



**GAS COMPONENTS**



**ELECTRIC COMPONENTS**



**WATER TECHNOLOGY**



**MECHANICAL COMPONENTS**



**TOOLS**

Spare parts suitable for

**RM-GASTRO**

Find the complete and up-to-date range of products in our GEV Webshop



# Manufacturer catalogue

The most important spare parts and accessories arranged clearly for every manufacturer

- ✓ Complete product range and all appliance data always up to date in the GEV Webshop
- ✓ Alphabetical Index at the end of the catalogue

## GEV Webshop

[www.gev-online.co.uk](http://www.gev-online.co.uk)

[www.gev-online.com](http://www.gev-online.com)



- 🔍 Add to Favourites
- 🔍 Sign In with email address and usual password
- 🔍 Easy-order – place several items in your basket at the same time
- 🔍 Quick Item search – no login needed



## heating elements

### heating elements for bain maries

<b>GEV No.</b>	416195	<b>Ref. No.</b>	401023000
<b>description</b>	heating element 1500W 230V heating circuits 1 L 368mm L1 23mm W 268mm connection male faston 6.3mm connection distance 263mm tube ø 6.3mm dry heating element bain marie L2 345mm H 19mm		
<b>For models:</b>	BM1120, BMV1120, BMV2120		

<b>GEV No.</b>	418668	<b>Ref. No.</b>	401021700 40121700
<b>description</b>	heating element 700W 230V heating circuits 1 L 370mm L1 35mm W 230mm connection 6.3 connection distance 224mm tube ø 6.3mm bain marie L2 335mm H 15mm		
<b>For models:</b>	BMPD2120, BMPD3120, BMPD4120, BMPK4120, BMSD2120, BMSD4120		

### heating elements for chip scuttles

<b>GEV No.</b>	418659	<b>Ref. No.</b>	401021000
<b>description</b>	heating element 350W 230V heating circuits 1 L 175mm W 180mm connection 6.3 tube ø 6.5mm dry heating element hot dog machine L1 30mm L2 145mm H 17mm connection distance 174mm		

### heating elements for fryers

#### 2 hole fixing

<b>GEV No.</b>	418665	<b>Ref. No.</b>	401003000
<b>description</b>	heating element 5000W 230V heating circuits 1 L 473mm W 250mm H 190mm connection M6 L1 23mm L2 450mm W1 53mm W2 145mm tube ø 8.5mm thread 1/4" windings 4 fryer		
<b>For models:</b>	FE60P		
<b>accessories for</b>	418665		
	<b>GEV No.</b>	361182	<b>Ref. No.</b> —
	nut thread 1/4" H 5mm nickel-plated brass WS 17 Qty 1 pcs		
	<b>GEV No.</b>	510417	<b>Ref. No.</b> —
	flat gasket fibre ED ø 20mm ID ø 14mm thickness 2mm Qty 1 pcs		
	<b>GEV No.</b>	520228	<b>Ref. No.</b> —
	tooth lock washer ID ø 15.3mm ED ø 24mm steel Qty 1 pcs for thread M14		
	<b>GEV No.</b>	550262	<b>Ref. No.</b> —
	flat gasket copper ED ø 20mm ID ø 14mm thickness 2mm		
	<b>GEV No.</b>	560113	<b>Ref. No.</b> —
	plain washer ID ø 6.4mm ED ø 12mm thickness 1.6mm SS Qty 20 pcs DIN 125A for thread M6		
	<b>GEV No.</b>	560133	<b>Ref. No.</b> —
	hexagonal nut thread M6 H 5mm WS 10 SS DIN/ISO DIN 934 / ISO 4032/8673 Qty 20 pcs		

<b>GEV No.</b>	418654	<b>Ref. No.</b>	401001000
<b>description</b>	heating element 2100W 230V heating circuits 1 L 270mm W 120mm H 200mm L1 15mm L2 255mm H1 155mm H2 45mm thread 1/4" tube ø 8.5mm connection M4 fryer windings 4		
<b>For models:</b>	EF05, EF55, EF85, FE44, FE44E, FE74, FE74E		
<b>accessories for</b>	418654		
	<b>GEV No.</b>	521103	<b>Ref. No.</b> —
	nut thread M4 H 3mm WS 7 brass Qty 20 pcs		
	<b>GEV No.</b>	521104	<b>Ref. No.</b> —
	washer ID ø 4.3mm ED ø 8mm thickness 0.5mm brass Qty 20 pcs for thread M4		
	<b>GEV No.</b>	560111	<b>Ref. No.</b> —
	plain washer ID ø 4.3mm ED ø 9mm thickness 0.8mm SS Qty 20 pcs DIN 125A for thread M4		





Table continues overleaf

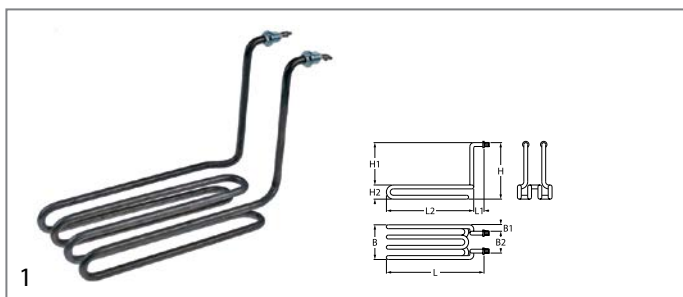

<b>accessories for</b>	418654			
	GEV No.	560131	Ref. No.	—
	hexagonal nut thread M4 H 3.2mm WS 7 SS DIN/ISO DIN 934 / ISO 4032/8673 Qty 20 pcs			







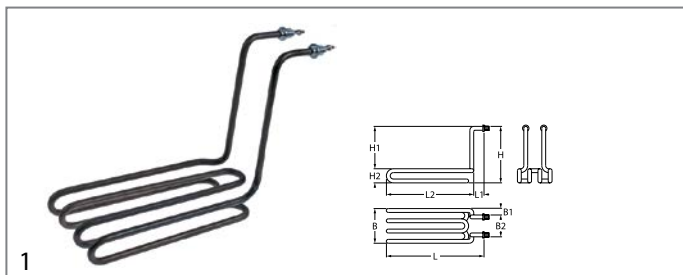

<b>GEV No.</b>	418669	<b>Ref. No.</b>	401002000
<b>description</b>	heating element 3000W 230V heating circuits 1 L 270mm W 110mm H 200mm L1 15mm L2 255mm H1 160mm H2 40mm thread 1/4" tube ø 8.5mm connection M4 fryer windings 4		
<b>For models:</b>	EF08, EF85, EF88, FE04S, FE07EV, FE07TE, FE44S, FE74E, FE77T		

<b>accessories for</b>	418669			
	GEV No.	521103	Ref. No.	—
	nut thread M4 H 3mm WS 7 brass Qty 20 pcs			
	GEV No.	521104	Ref. No.	—
	washer ID ø 4.3mm ED ø 8mm thickness 0.5mm brass Qty 20 pcs for thread M4			
	GEV No.	560111	Ref. No.	—
	plain washer ID ø 4.3mm ED ø 9mm thickness 0.8mm SS Qty 20 pcs DIN 125A for thread M4			
	GEV No.	560131	Ref. No.	—
	hexagonal nut thread M4 H 3.2mm WS 7 SS DIN/ISO DIN 934 / ISO 4032/8673 Qty 20 pcs			









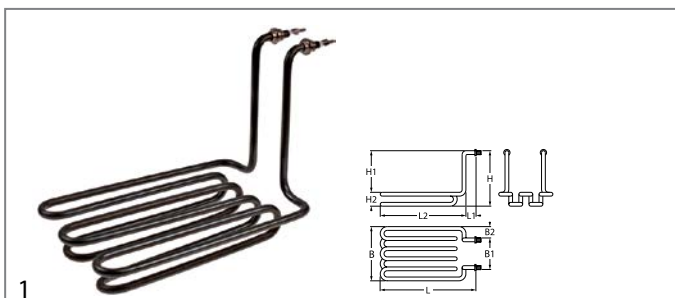

<b>GEV No.</b>	418671	<b>Ref. No.</b>	401002520
<b>description</b>	heating element 3000W 230V heating circuits 1 L 300mm W 120mm H 215mm L1 50mm L2 250mm H1 180mm H2 35mm thread 1/4" tube ø 8.5mm connection M4 immersion heater fryer windings 4		

<b>spare parts for</b>	418671			
	GEV No.	510417	Ref. No.	—
	flat gasket fibre ED ø 20mm ID ø 14mm thickness 2mm Qty 1 pcs			
<b>accessories for</b>	418671			
	GEV No.	361182	Ref. No.	—
	nut thread 1/4" H 5mm nickel-plated brass WS 17 Qty 1 pcs			
	GEV No.	520228	Ref. No.	—
	tooth lock washer ID ø 15.3mm ED ø 24mm steel Qty 1 pcs for thread M14			
	GEV No.	521103	Ref. No.	—
	nut thread M4 H 3mm WS 7 brass Qty 20 pcs			
	GEV No.	521104	Ref. No.	—
	washer ID ø 4.3mm ED ø 8mm thickness 0.5mm brass Qty 20 pcs for thread M4			

<b>accessories for</b>	418671			
	GEV No.	550262	Ref. No.	—
	flat gasket copper ED ø 20mm ID ø 14mm thickness 2mm			
	GEV No.	560111	Ref. No.	—
	plain washer ID ø 4.3mm ED ø 9mm thickness 0.8mm SS Qty 20 pcs DIN 125A for thread M4			
	GEV No.	560131	Ref. No.	—
	hexagonal nut thread M4 H 3.2mm WS 7 SS DIN/ISO DIN 934 / ISO 4032/8673 Qty 20 pcs			



<b>GEV No.</b>	418655	<b>Ref. No.</b>	401002500
<b>description</b>	heating element 3000W 230V heating circuits 1 L 275mm W 175mm H 200mm L1 15mm L2 260mm H1 160mm H2 40mm thread 1/4" tube ø 8.5mm connection M4 windings 5 W1 50mm W2 75mm		
<b>For models:</b>	FE74, FE77, FE77V		

<b>spare parts for</b>	418655			
	GEV No.	510417	Ref. No.	—
	flat gasket fibre ED ø 20mm ID ø 14mm thickness 2mm Qty 1 pcs			
<b>accessories for</b>	418655			
	GEV No.	361182	Ref. No.	—
	nut thread 1/4" H 5mm nickel-plated brass WS 17 Qty 1 pcs			
	GEV No.	520228	Ref. No.	—
	tooth lock washer ID ø 15.3mm ED ø 24mm steel Qty 1 pcs for thread M14			
	GEV No.	521103	Ref. No.	—
	nut thread M4 H 3mm WS 7 brass Qty 20 pcs			
	GEV No.	521104	Ref. No.	—
	washer ID ø 4.3mm ED ø 8mm thickness 0.5mm brass Qty 20 pcs for thread M4			
	GEV No.	550262	Ref. No.	—
	flat gasket copper ED ø 20mm ID ø 14mm thickness 2mm			
	GEV No.	560111	Ref. No.	—
	plain washer ID ø 4.3mm ED ø 9mm thickness 0.8mm SS Qty 20 pcs DIN 125A for thread M4			
	GEV No.	560131	Ref. No.	—
	hexagonal nut thread M4 H 3.2mm WS 7 SS DIN/ISO DIN 934 / ISO 4032/8673 Qty 20 pcs			



<b>GEV No.</b>	418670	<b>Ref. No.</b>	401002510
<b>description</b>	heating element 3000W 230V heating circuits 1 L 310mm W 175mm H 220mm L1 50mm L2 260mm H1 180mm H2 40mm thread 1/4" tube ø 8.5mm connection M4 windings 5 W1 50mm W2 75mm		

### heating elements for hot dog machines

<b>GEV No.</b>	418661	<b>Ref. No.</b>	401022500
<b>description</b>	heating element 1000W 230V L 180mm W 187mm H 18mm tube ø 6.2mm L1 30mm L2 150mm connection 6.3 connection distance 181mm heating circuits 1 hot dog machine		
<b>For models:</b>	HD3N, HD4N, HD4NK, HDN, WE11, WEV12		

### heating elements for griddles

<b>GEV No.</b>	419009	<b>Ref. No.</b>	401025000
<b>description</b>	heating element 3000W 230V heating circuits 1 L 430mm W 270mm H 35mm tube ø 8.5mm W1 20mm W2 230mm connection male faston 6.3mm griddle connection distance 200mm dry heating element		
<b>For models:</b>	FTH30, FTH60, FTHR60, FTR30		

<b>GEV No.</b>	418656	<b>Ref. No.</b>	401020500
<b>description</b>	heating element 110W 230V L 131mm W 140mm H 6mm tube ø 6.5mm connection cable with thermal fuse cable length 160/300mm dry heating element heating circuits 1		
<b>For models:</b>	HD01, HD02, HD03, HD04, HD3N, HD4N, HD4NK		

### heating elements for hot counters

<b>GEV No.</b>	415699	<b>Ref. No.</b>	401021200
<b>description</b>	heating element 400W 230V heating circuits 1 L 298mm W 138mm tube ø 6.3mm connection male faston 6.3mm dry heating element for vitrine 2 hole fixing thread M12x1.25 mounting distance 132mm		

### heating elements for contact grills

<b>GEV No.</b>	418660	<b>Ref. No.</b>	401031200
<b>description</b>	heating element 1200W 230V L 177mm W 215mm H 20mm W1 35mm W2 145mm tube ø 6.3mm windings 4 connection M4		
<b>For models:</b>	PD2020L, PD2020R, PM2015R		





<b>GEV No.</b>	418666	<b>Ref. No.</b>	401021701	
<b>description</b>	heating element 700W 230V heating circuits 1 L 630mm W 160mm tube ø 6.3mm connection male faston 6.3mm for vitrine thread M12 mounting distance 154mm			
<b>For models:</b>	VEC810, VEC820			
<b>spare parts for</b>	418666			
	<b>GEV No.</b>	521110	<b>Ref. No.</b>	—
	flat gasket fibre ED ø 20mm ID ø 13mm thickness 2mm Qty 1 pcs			
<b>accessories for</b>	418666			
	<b>GEV No.</b>	520229	<b>Ref. No.</b>	—
	nut thread M12x1 H 4mm WS 16 zinc-coated steel Qty 1 pcs			
	<b>GEV No.</b>	521131	<b>Ref. No.</b>	—
	nut thread M12x1 H 3.5mm WS 17 SS Qty 1 pcs			
	<b>GEV No.</b>	528110	<b>Ref. No.</b>	—
	O-ring EPDM thickness 2.62mm ID ø 12.37mm Qty 1 pcs			

<b>GEV No.</b>	418664	<b>Ref. No.</b>	401031800
<b>description</b>	heating element 1800W 230V L 185mm W 205mm H 20mm W1 40mm W2 125mm tube ø 6.3mm windings 4 connection M4		
<b>For models:</b>	PD2020L, PD2020R, PM2015R		



heating elements for pasta cookers



<b>GEV No.</b>	418663	<b>Ref. No.</b>	401002600
<b>description</b>	heating element 3000W 230V L 245mm W 225mm H 27mm connection 6.3 thread M10x1 tube ø 6.3mm L1 120mm L2 125mm mounting distance 220mm		
<b>spare parts for</b>	418663		
	<b>GEV No.</b>	510893	<b>Ref. No.</b> —
	O-ring EPDM thickness 2.62mm ID ø 9.92mm Qty 1 pcs		
<b>accessories for</b>	418663		
	<b>GEV No.</b>	510416	<b>Ref. No.</b> —
	flat gasket fibre ED ø 19mm ID ø 10.5mm thickness 1.5mm for thread M10 Qty 1 pcs		
	<b>GEV No.</b>	520231	<b>Ref. No.</b> —
	nut thread M10x1 H 6mm WS 14 zinc-coated steel Qty 1 pcs		
	<b>GEV No.</b>	521129	<b>Ref. No.</b> —
	nut thread M10 H 6mm SS WS 17 Qty 1 pcs DIN/ISO DIN 439		

heating elements for pizza ovens

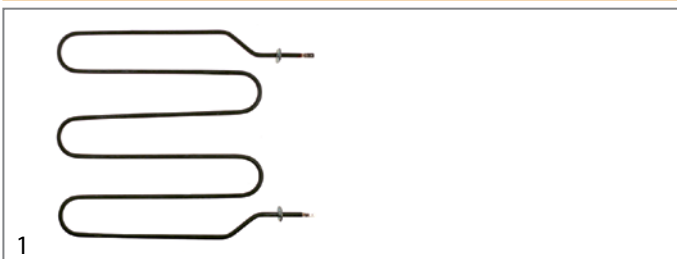

<b>GEV No.</b>	418672	<b>Ref. No.</b>	401031000
<b>description</b>	heating element 1000W 230V heating circuits 1 L 330mm W 300mm L1 30mm L2 60mm L3 240mm W1 35mm W2 230mm lug length 27mm lug width 22mm connection length 55mm connection male faston 6.3mm tube ø 6.3mm 2 hole fixing hole ø 3mm dry heating element pizza oven		
<b>For models:</b>	FP36, FP36S		

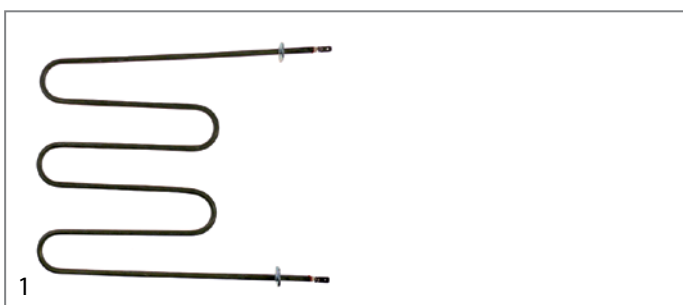

<b>GEV No.</b>	418667	<b>Ref. No.</b>	401021750
<b>description</b>	heating element 750W 230V heating circuits 1 L 310mm W 250mm lug length 30mm lug width 20.4mm connection male faston 6.3mm pizza oven		
<b>For models:</b>	FP36, FP36S		

heating elements for rolling grills

<b>GEV No.</b>	416189	<b>Ref. No.</b>	637108200
<b>description</b>	heating element 220W 240V heating circuits 1 L 359mm connection distance 359mm tube ø 8.5mm dry heating element roller grill		
<b>For models:</b>	CW8		

heating elements for salamanders/toast-

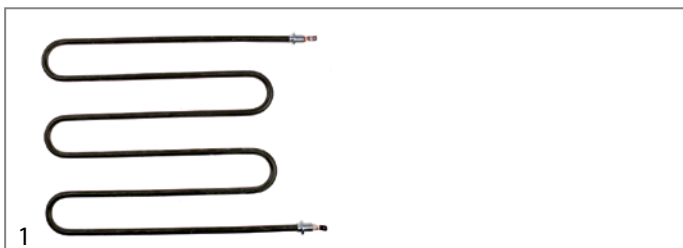

<b>GEV No.</b>	418653	<b>Ref. No.</b>	401024000
<b>description</b>	heating element 2200W 230V L 350mm W 260mm thread M12 mounting distance 245mm connection 6.3 air tube ø 8.5mm heating circuits 1 H 8.5mm		
<b>spare parts for</b>	418653		
	<b>GEV No.</b>	521110	<b>Ref. No.</b> —
	flat gasket fibre ED ø 20mm ID ø 13mm thickness 2mm Qty 1 pcs		
<b>accessories for</b>	418653		
	<b>GEV No.</b>	520229	<b>Ref. No.</b> —
	nut thread M12x1 H 4mm WS 16 zinc-coated steel Qty 1 pcs		
	<b>GEV No.</b>	521131	<b>Ref. No.</b> —
	nut thread M12x1 H 3.5mm WS 17 SS Qty 1 pcs		
	<b>GEV No.</b>	528110	<b>Ref. No.</b> —
	O-ring EPDM thickness 2.62mm ID ø 12.37mm Qty 1 pcs		



heating elements for heating bridges



1

<b>GEV No.</b>	418657	<b>Ref. No.</b>	401021500
<b>description</b>	heating element 500W 230V heating circuits 1 L 165mm W 125mm connection 6.3 tube ø 8.5mm dry heating element heated bridge L1 30mm L2 135mm H 16mm		

quartz heating elements



1

<b>GEV No.</b>	693058	<b>Ref. No.</b>	637000200
<b>description</b>	insulator female L 7mm hole ø 5.5mm ø 13mm		
<b>For models:</b>	CW8		



1

<b>GEV No.</b>	416187	<b>Ref. No.</b>	401023400
<b>description</b>	quartz heating element 400W 115V L 260mm ø 12mm connection male faston 6.3mm mounting distance 24.8mm		
<b>For models:</b>	TO920, TO940		



1

<b>GEV No.</b>	418625	<b>Ref. No.</b>	401023500
<b>description</b>	quartz heating element 500W 115V L 365mm ø 10mm connection male faston 6.3mm		
<b>For models:</b>	TO930, TO960		

heating elements for convection



1

<b>GEV No.</b>	418662	<b>Ref. No.</b>	401033000
<b>description</b>	heating element 3000W 230V heating circuits 1 ID ø 186mm ED ø 200mm L 217mm H 31mm L1 17mm W1 31mm H1 6mm H2 25mm flange length 70mm flange width 22mm hole distance 56mm connection male faston 6.3mm connection length 30mm tube ø 6.3mm convection heating element hole ø 5.5mm rectangular flange		
<b>For models:</b>	SPT60GLS, SPT90-5ELS, SPT90-5GLS, SPT90ELS, SPT90GL, SPT90GLS		
<b>spare parts for</b>	418662		
	<b>GEV No.</b>	510368	<b>Ref. No.</b> —
	gasket L 70mm W 23.5mm hole ø 5mm hole distance 56mm FIBER thickness 2mm for heating element		

accessories



1

<b>GEV No.</b>	693058	<b>Ref. No.</b>	637000200
<b>description</b>	insulator female L 7mm hole ø 5.5mm ø 13mm		
<b>For models:</b>	CW8		



1

<b>GEV No.</b>	693057	<b>Ref. No.</b>	637000100
<b>description</b>	insulator male L 10mm hole ø 8.4mm ø 13mm		
<b>For models:</b>	CW8		

hot plates

round

with radiused edge

for domestic kitchens



1

<b>GEV No.</b>	490006	<b>Ref. No.</b>	401051820
<b>description</b>	hot plate ø 180mm 2000W 230V with protector connection 4 screw clamps with 4mm spill ring		
<b>For models:</b>	SPT90-5ELS, SPT90ELS		



## energy regulators

## EGO

## 1-circuit



<b>GEV No.</b>	380015	<b>Ref. No.</b>	402520000 637060100
<b>description</b>	energy regulator 230V 13A single-circuit turn direction right shaft ø 6x4.6mm shaft L 23mm mounting thread M4 power release 6-100% no. 50.57021.010		
<b>For models:</b>	CW8		

<b>GEV No.</b>	390604	<b>Ref. No.</b>	402501500
<b>description</b>	thermostat t.max. 110°C temperature range 30-110°C 1-pole 1NO 16A probe ø 5mm probe L 90mm capillary pipe 970mm capillary pipe isolated 28mm gland nut shaft ø 6x4.6mm shaft L 17mm rotation 270°		

## thermostats

## control and safety thermostats

## EGO

## safety thermostats

## 56.\_ series



<b>GEV No.</b>	390610	<b>Ref. No.</b>	402511000
<b>description</b>	safety thermostat switch-off temp. 235°C 1-pole 16A probe ø 3mm probe L 190mm capillary pipe 1000mm capillary pipe isolated 640mm gland nut probe SS		
<b>For models:</b>	EF05, EF08, EF55, EF85, EF88, FE04S, FE07EV, FE07TE, FE44, FE44E, FE44S, FE60P, FE74, FE74E, FE77, FE77T, FE77V		

<b>GEV No.</b>	390882	<b>Ref. No.</b>	402501501
<b>description</b>	thermostat t.max. 120°C temperature range 30-120°C 1-pole 1NO 16A probe ø 5mm probe L 80mm capillary pipe 980mm capillary pipe isolated 28mm gland nut shaft ø 6x4.6mm shaft L 17mm rotation 270° 250V		

<b>GEV No.</b>	390611	<b>Ref. No.</b>	402502000
<b>description</b>	thermostat t.max. 190°C temperature range 50-190°C 1-pole 1NO 16A probe ø 3mm probe L 185mm capillary pipe 980mm capillary pipe isolated 640mm gland nut shaft ø 6x4.6mm shaft L 23mm shaft position upper rotation 270° probe material SS		
<b>For models:</b>	EF05, EF08, EF55, EF85, EF88, FE04S, FE07EV, FE07TE, FE44, FE44E, FE44S, FE60P, FE74, FE74E, FE77, FE77T, FE77V, HD3N, HD4N, HD4NK, HDN		

## CAEM

## control thermostats



<b>GEV No.</b>	390082	<b>Ref. No.</b>	40250110
<b>description</b>	thermostat t.max. 100°C temperature range 30-90°C 1-pole 1CO 16A probe ø 6mm probe L 94mm capillary pipe 1600mm capillary pipe isolatedmm gland nut shaft ø 6x4.6mm shaft L 22mm shaft position upper rotation 270° probe material copper		

<b>GEV No.</b>	390606	<b>Ref. No.</b>	402503150
<b>description</b>	thermostat t.max. 300°C temperature range 50-300°C 1-pole 1NO 16A probe ø 3mm probe L 175mm capillary pipe 1500mm capillary pipe isolated 650mm gland nut shaft ø 6x4.6mm shaft L 18mm rotation 270°		
<b>For models:</b>	SPT60GLS, SPT90-5ELS, SPT90-5GLS, SPT90ELS, SPT90GL, SPT90GLS		



<b>GEV No.</b>	390602	<b>Ref. No.</b>	402503000 402503002 402503500
<b>description</b>	thermostat t.max. 300°C temperature range 50-300°C 1-pole 1NO 16A probe ø 5mm probe L 70mm capillary pipe 900mm capillary pipe isolated 700mm gland nut shaft L 18mm rotation 270°		
<b>For models:</b>	FP36, FP36S, FTH30, FTH60, FTHR60, FTR30, PD2020L, PD2020R, PM2015R		

various

safety thermostats



<b>GEV No.</b>	390607	<b>Ref. No.</b>	402511200
<b>description</b>	safety thermostat switch-off temp. 360°C 1-pole 20A probe ø 3mm probe L 150mm capillary pipe 920mm capillary pipe isolated 240mm gland nut probe SS		
<b>For models:</b>	SPT60GLS, SPT90-5ELS, SPT90-5GLS, SPT90ELS, SPT90GL, SPT90GLS		

safety thermostats



<b>GEV No.</b>	390603	<b>Ref. No.</b>	402511130
<b>description</b>	safety thermostat switch-off temp. 130°C 1-pole 16A probe ø 5mm probe L 120mm capillary pipe 900mm capillary pipe isolatedmm gland nut probe SS		

accessories

connecting bows



<b>GEV No.</b>	550060	<b>Ref. No.</b>	402503201
<b>description</b>	connecting bow long for thermostat Qty 1 pcs		
<b>For models:</b>	SPT60GLS, SPT90-5ELS, SPT90ELS, SPT90GL, SPT90GLS		

TECASA

control thermostats



<b>GEV No.</b>	390980	<b>Ref. No.</b>	402501400
<b>description</b>	thermostat t.max. 90°C temperature range 30-90°C 1-pole 1NO 16A probe ø 6mm probe L 95mm capillary pipe 1550mm capillary pipe isolated 1500mm gland nut shaft ø 6x4.6mm shaft L 16mm shaft position° shaft position upper rotation 270° outer switch probe material SS probe thread disc ømm screw connection		

switches and momentary switches

rocker/momentary rocker switches

30x22mm



<b>GEV No.</b>	346896 <sup>1</sup>	<b>Ref. No.</b>	637086000
<b>description</b>	rocker switch mounting measurements 30x22mm black 2NO 250V 16A 0-I connection male faston 6.3mm ambient temperature max. 125/55°C protection IP65		
<b>For models:</b>	CW8		



<sup>1</sup>non-illuminated



<b>GEV No.</b>	301003	<b>Ref. No.</b>	401500550	
<b>description</b>	rocker switch mounting measurements 30x22mm green 2NO 250V 16A illuminated 0-I connection male faston 6.3mm ambient temperature max. 125/55°C protection IP65			
<b>For models:</b>	BMPD2120, BMPD3120, BMPD4120, BMPK4120, BMSD2120, BMSD4120			
<b>accessories for</b>	301003			
	<b>GEV No.</b>	301036	<b>Ref. No.</b>	401509000
	protective cover internal size 30x22mm for rocker switch mounting measurementsmm			



			
1			
<b>GEV No.</b>	301036	<b>Ref. No.</b>	401509000
<b>description</b>	protective cover internal size 30x22mm for rocker switch mounting measurementsmm		
<b>For models:</b>	BM1120, BMPD2120, BMPD3120, BMPD4120, BMPK4120, BMSD2120, BMSD4120, BMV1120, BMV2120, FE07EV, FE07TE, FE44E, FE74E, FTH30, FTH60, FTHR60, FTR30, PD2020L, PD2020R, PM2015R		

			
1			
<b>GEV No.</b>	346377	<b>Ref. No.</b>	401500500
<b>description</b>	rocker switch mounting measurements 30x22mm black 2CO 230V 16A 0-I connection male faston 6.3mm ambient temperature max. 125/55°C protection IP40		
<b>For models:</b>	BM1120, BMV1120, BMV2120, FE07EV, FE07TE, FE44E, FE74E, FTH30, FTH60, FTHR60, FTR30, HD04, HD3N, HD4N, HD4NK, HDN, PD2020L, PD2020R, PM2015R, VEC810, VEC820, WE11, WEV12		
<b>accessories for</b>	346377		
		<b>GEV No.</b>	301036
		<b>Ref. No.</b>	401509000
	protective cover internal size 30x22mm for rocker switch mounting measurementsmm		

			
1			
<b>GEV No.</b>	346985	<b>Ref. No.</b>	401500600
<b>description</b>	rocker switch mounting measurements 30x22mm black 1NO/1CO 250V 16A 0-I/II connection male faston 6.3mm ambient temperature max. 85°C protection IP40		
<b>For models:</b>	HD01, HD02, HD03, HD3N, HD4N, HD4NK		

## push/momentary push switches

30x22mm

			
1			
<b>GEV No.</b>	301086	<b>Ref. No.</b>	401500530
<b>description</b>	push switch mounting measurements 30x22mm black 2NO 250V 12A 0-1 connection male faston 6.3mm ambient temperature max. 85/55°C protection IP54 with protective collar		
<b>For models:</b>	FE04S, FE44, FE44S, FE60P, FE74, FE77, FE77T, FE77V		

			
1			
<b>GEV No.</b>	301036	<b>Ref. No.</b>	401509000
<b>description</b>	protective cover internal size 30x22mm for rocker switch mounting measurementsmm		
<b>For models:</b>	BM1120, BMPD2120, BMPD3120, BMPD4120, BMPK4120, BMSD2120, BMSD4120, BMV1120, BMV2120, FE07EV, FE07TE, FE44E, FE74E, FTH30, FTH60, FTHR60, FTR30, PD2020L, PD2020R, PM2015R		

## microswitches

## pin-plunger actuated

M10

			
1			
<b>GEV No.</b>	345032	<b>Ref. No.</b>	401520000
<b>description</b>	microswitch with plunger thread M10x1 thread L 12mm 250V 16A 1CO connection male faston 6.3mm stroke 7mm mounting distance 22mm L 28mm ambient temperature max. 125°C type SP9603 actuating force: 180g		
<b>For models:</b>	EF05, EF08, EF55, EF85, EF88, FE04S, FE07EV, FE07TE, FE44, FE44E, FE44S, FE60P, FE74, FE74E, FE77, FE77T, FE77V		

## cam switches

## 2 operating positions

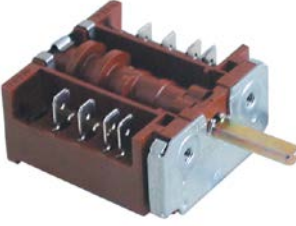
			
1			
<b>GEV No.</b>	301715	<b>Ref. No.</b>	401505000
<b>description</b>	cam switch 2 operating positions sequence 0-1 16A shaft ø 6x4.6mm shaft L 23mm connection male faston 6.3mm plastic		
<b>For models:</b>	TO920, TO930, TO940, TO960		

## 6 operating positions

			
1			
<b>GEV No.</b>	301714	<b>Ref. No.</b>	401505100
<b>description</b>	cam switch 6 operating positions 3-pole		
<b>For models:</b>	SPT90-5ELS, SPT90ELS		



operation switches



1			
<b>GEV No.</b>	300091	<b>Ref. No.</b>	401506000
<b>description</b>	operation switch EGO 2 operating positions 2NO 16A sequence 0-1 shaft ø 6x4.6mm shaft L 23mm connection screw ceramic		
<b>For models:</b>	SPT60GLS, SPT90-5ELS, SPT90-5GLS, SPT90ELS, SPT90GL, SPT90GLS		

lamps

indicator lights

indicator lights (complete)

ø10mm

with plug-in socket



1			
<b>GEV No.</b>	359139	<b>Ref. No.</b>	401515100 401515150
<b>description</b>	indicator light ø 10mm green 230V connection male faston 6.3mm Qty 1 pcs		
<b>For models:</b>	EF05, EF08, EF55, EF85, EF88, FP36, FP36S, HD01, HD02, HD03, HD04, HD3N, HD4N, HD4NK, HDN, SPT60GLS, SPT90-5ELS, SPT90-5GLS, SPT90ELS, SPT90GL, SPT90GLS, TO920, TO930, TO940, TO960		



1			
<b>GEV No.</b>	359140	<b>Ref. No.</b>	401515200 401515250
<b>description</b>	indicator light ø 10mm yellow 230V connection male faston 6.3mm Qty 1 pcs		
<b>For models:</b>	BMPD2120, BMPD3120, BMPD4120, BMPK4120, BMSD2120, BMSD4120, FP36, FP36S, SPT60GLS, SPT90-5ELS, SPT90-5GLS, SPT90ELS, SPT90GL, SPT90GLS, TO920, TO930, TO940, TO960		

30x22mm

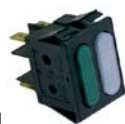

1			
<b>GEV No.</b>	359164	<b>Ref. No.</b>	401510001 637082100
<b>description</b>	indicator light mounting measurements 30x22mm 230V green/white connection male faston 6.3mm temp.-resist. 125°C		
<b>For models:</b>	CW8		



1			
<b>GEV No.</b>	301138	<b>Ref. No.</b>	401510000
<b>description</b>	indicator light mounting measurements 30x22mm 230V red/green connection male faston 6.3mm temp.-resist. 125/55°C type RL2		
<b>For models:</b>	BM1120, BMV1120, BMV2120, FE04S, FE07EV, FE07TE, FE44, FE44E, FE44S, FE60P, FE74, FE74E, FE77, FE77T, FE77V, FTH30, FTH60, FTHR60, FTR30, PD2020L, PD2020R, PM2015R, VEC810, VEC820, WE11, WEV12		

timers

mechanical timers



1			
<b>GEV No.</b>	350181	<b>Ref. No.</b>	401550010
<b>description</b>	timer C20 with bell 2-pole operation time 15min impulse mechanical 2NO at 250V 16A permanent position yes shaft ø 6x4.6mm shaft 6x4.6mm shaft L 20mm mounting distance 28mm		
<b>For models:</b>	FP36, FP36S		



1			
<b>GEV No.</b>	360409	<b>Ref. No.</b>	401550000
<b>description</b>	timer MT49 2-pole operation time 15min impulse mechanical 2NO at 250V 16A permanent position no shaft 6x4.6mm shaft L 17mm mounting distance 28mm		
<b>For models:</b>	TO920, TO930, TO940, TO960		

audible timers



1			
<b>GEV No.</b>	350180	<b>Ref. No.</b>	401550025
<b>description</b>	audible timer operation time 120min ø 56mm shaft ø 6x4.6mm shaft L 24mm mounting distance 28mm		
<b>For models:</b>	SPT90-5ELS, SPT90-5GLS, SPT90ELS, SPT90GL, SPT90GLS		



### contactors

#### TELEMECANIQUE (Schneider Electric)

##### power contactors



<b>1</b>			
<b>GEV No.</b>	380479	<b>Ref. No.</b>	401531090
<b>description</b>	power contactor resistive load 25A 230VAC (AC3/400V) 9A/4kW main contacts 3NO auxiliary contacts 1NO/1NC connection screw connection type LC1D09P7		
<b>For models:</b>	FP36S		



<b>1</b>			
<b>GEV No.</b>	380976	<b>Ref. No.</b>	401531000
<b>description</b>	power contactor resistive load 32A 230VAC (AC3/400V) 18A/7.5kW main contacts 3NO auxiliary contacts 1NO/1NC connection screw connection		
<b>For models:</b>	FE07TE, FE77T		



<b>1</b>			
<b>GEV No.</b>	380979	<b>Ref. No.</b>	401531050
<b>description</b>	power contactor resistive load 40A 230VAC (AC3/400V) 25A/11kW main contacts 3NO auxiliary contacts 1NO/1NC connection screw connection type LC1D25P7		
<b>For models:</b>	FE60P		

### fans

#### hot air motors

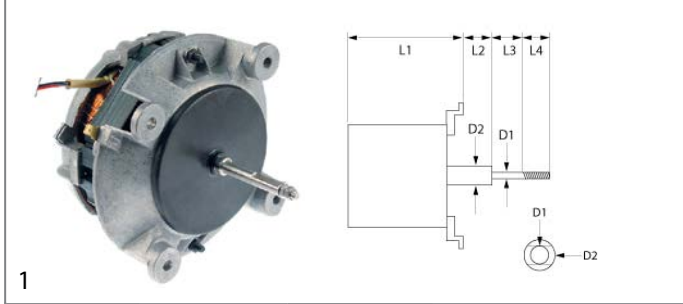

<b>1</b>			
<b>GEV No.</b>	500662	<b>Ref. No.</b>	403000200
<b>description</b>	fan motor 220-240V 1 phase 50/60Hz 0.12kW 2800/3200rpm speeds 1 L1 85mm L2 7mm L3 47mm L4 12mm D1 ø 8/6mm D2 ø 12mm M5R ET 1.6A power input 0.25W suitable capacitor 5µF/400V		
<b>For models:</b>	SPT60GLS, SPT90-5ELS, SPT90-5GLS, SPT90ELS, SPT90GL, SPT90GLS		



<b>1</b>			
<b>GEV No.</b>	601450	<b>Ref. No.</b>	403000250
<b>description</b>	fan wheel D1 ø 160mm H1 45mm blades 36 D2 ø 8mm D3 ø 8mm H2 24mm		
<b>For models:</b>	SPT60GLS, SPT90-5ELS, SPT90-5GLS, SPT90ELS, SPT90GL, SPT90GLS		

### motors

#### gear motors

##### for grills

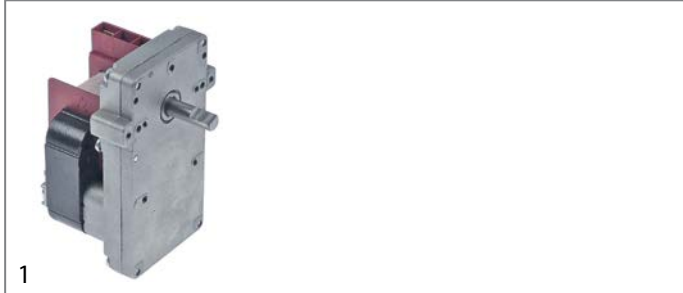

<b>1</b>			
<b>GEV No.</b>	499209	<b>Ref. No.</b>	637075100
<b>description</b>	gear motor KENTA type K9113069 23W 230V 50Hz 2.5rpm shaft ø 6x8mm L 108mm W 58mm H 66mm		
<b>For models:</b>	CW8		



## condensators & interference suppression filters

### operating capacitors

#### plastic



1

<b>GEV No.</b>	365009	<b>Ref. No.</b>	401590400
<b>description</b>	operating capacitor capacity 2.5µF 400V tolerance 5% 50Hz ambient temperature max. -25 to +85°C ø 36.5mm L 55mm M8 plastic connection male faston 6.3mm 1.27.65C3 protection		
<b>For models:</b>	SPT60GLS, SPT90-5ELS, SPT90-5GLS, SPT90ELS, SPT90GL, SPT90GLS		

## electric accessories

### plugs - couplings - power sockets

#### protective contact power sockets

#### producer-specific power sockets

#### miscellaneous



1

<b>GEV No.</b>	550975	<b>Ref. No.</b>	401590000
<b>description</b>	built-in socket max. 16A with earth pin countries B 240V mounting ø 43mm 1 phase L/N/PE		
<b>For models:</b>	BMPD2120, BMPD3120, BMPD4120, BMPK4120		

### cables

#### spiral cables



1

<b>GEV No.</b>	550071	<b>Ref. No.</b>	402010100
<b>description</b>	spiral cable plug type CEE7/7 type E+F 1.5mm <sup>2</sup> 3-pole with plug L 500mm expansion 5:1 countries A/D/I black		
<b>For models:</b>	BMPD2120, BMPD3120, BMPD4120, BMPK4120		

#### accessories

#### cable glands

#### threaded cable glands

#### screw connections



1

<b>GEV No.</b>	550971	<b>Ref. No.</b>	402086016
<b>description</b>	cable gland thread PG16 cable ø 14mm mounting ø 22.5mm Qty 1 pcs plastic WS 27		
<b>For models:</b>	FE07TE, FE60P, FE77T, FTH60, FTHR60, PD2020L, PD2020R, SPT90-5ELS, SPT90ELS		

### terminals

#### connection terminals with screw/faston connections



1

<b>GEV No.</b>	550517	<b>Ref. No.</b>	402080100
<b>description</b>	power terminal block 5-pole max. 40A max 450V connection M6/ male faston 6.3mm temp.-resist. 150°C cross section 6mm <sup>2</sup>		
<b>For models:</b>	FE07TE, FE60P, FE77T, FTH60, FTHR60, PD2020L, PD2020R, SPT90-5ELS, SPT90ELS		

#### connection terminals with strain relief



1







<b>GEV No.</b>	550976	<b>Ref. No.</b>	402085500
<b>description</b>	power terminal block 2-pole max 450V max. 16A cable ø 10.5mm cross section 1.5mm <sup>2</sup> with strain relief		
<b>For models:</b>	BM1120, BMPD2120, BMPD3120, BMPD4120, BMPK4120, BMSD2120, BMSD4120, BMV1120, BMV2120, FE04S, FE07EV, FE44, FE44E, FE44S, FE74, FE74E, FE77, FE77V, FP36, FP36S, FTH30, FTR30, HD01, HD02, HD03, HD04, HD3N, HD4N, HD4NK, HDN, PM2015R, TO920, TO930, TO940, TO960, VEC810, VEC820, WE11, WEV12		

gas taps



PEL

20S series







<b>GEV No.</b>	104774	<b>Ref. No.</b>	404500100
<b>description</b>	gas tap PEL type 20S gas inlet M16x1.5 (tube ø 10mm) bypass nozzle ø 0mm gas outlet M16x1.5 (tube ø 10/8mm) thermocouple connection M8x1 pilot connection shaft ø 8x6.5mm shaft L 22/15mm shaft flat upper without ignition flame connection		
<b>For models:</b>	FTH30GL		
<b>spare parts for</b>	104774		
	<b>GEV No.</b>	101060	<b>Ref. No.</b> —
	magnet unit standard L 39mm D1 ø 15.4mm D2 ø 11mm suitable for PEL20-21/JUNKERS/EGA		
	<b>GEV No.</b>	101230	<b>Ref. No.</b> —
	thermocouple nut T1: M8x1 T2: M18x1 aluminium		
<b>accessories for</b>	104774		
	<b>GEV No.</b>	101278	<b>Ref. No.</b> —
	olive for pipe ø 10mm Qty 1 pcs		
	<b>GEV No.</b>	101300	<b>Ref. No.</b> —
	union nut thread M16x1.5 tube ø 10mm		
	<b>GEV No.</b>	101450	<b>Ref. No.</b> —
	olive for pipe ø 8mm L 12.7mm Qty 1 pcs ED ø 10mm		
	<b>GEV No.</b>	101451	<b>Ref. No.</b> —
	union nut thread M16x1.5 tube ø 8mm		

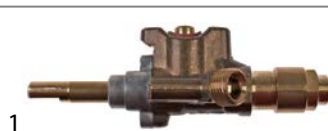

<b>GEV No.</b>	106806	<b>Ref. No.</b>	404500110
<b>description</b>	gas tap PEL type 20S gas inlet pipe flange ø21mm bypass nozzle ø 0mm gas outlet M16x1.5 (tube ø 10/8mm) thermocouple connection M8x1 pilot connection shaft ø 8x6.5mm shaft L 23/15mm shaft flat upper		
<b>For models:</b>	SPT60GLS, SPT90-5GLS, SPT90GLS		
<b>spare parts for</b>	106806		
	<b>GEV No.</b>	101060	<b>Ref. No.</b> —
	magnet unit standard L 39mm D1 ø 15.4mm D2 ø 11mm suitable for PEL20-21/JUNKERS/EGA		
	<b>GEV No.</b>	101230	<b>Ref. No.</b> —
	thermocouple nut T1: M8x1 T2: M18x1 aluminium		

SABAF



<b>GEV No.</b>	104775	<b>Ref. No.</b>	404000260
<b>description</b>	gas tap SABAF type 10 gas inlet pipe flange ø14mm bypass nozzle ø 0.56mm gas outlet 1/4" (tube ø 8mm) front fixing thermocouple connection M8x1 shaft ø 8x6.5mm shaft L 32/12.5mm shaft flat right		
<b>For models:</b>	SPT90GL		
<b>spare parts for</b>	104775		
	<b>GEV No.</b>	106724	<b>Ref. No.</b> —
	magnet unit L 30mm D1 ø 12.5mm D2 ø 8.5mm suitable for SABAF		
<b>accessories for</b>	104775		
	<b>GEV No.</b>	101277	<b>Ref. No.</b> 404000204 404000263
	olive ID ø 8mm Qty 1 pcs		
	<b>GEV No.</b>	520656	<b>Ref. No.</b> —
	union nut thread 1/4" tube ø 6/8mm		



<b>GEV No.</b>	106577	<b>Ref. No.</b>	404000261
<b>description</b>	gas tap SABAF type 10 gas inlet pipe flange ø23mm bypass nozzle ø 0.38mm gas outlet 1/4" (tube ø 8mm) front fixing thermocouple connection M8x1 shaft ø 8x6.5mm shaft L 32/12.5mm shaft flat right		
<b>For models:</b>	SPT90GL		
<b>spare parts for</b>	106577		
	<b>GEV No.</b>	106724	<b>Ref. No.</b> —
	magnet unit L 30mm D1 ø 12.5mm D2 ø 8.5mm suitable for SABAF		
<b>accessories for</b>	106577		
	<b>GEV No.</b>	101277	<b>Ref. No.</b> 404000204 404000263
	olive ID ø 8mm Qty 1 pcs		
	<b>GEV No.</b>	101376	<b>Ref. No.</b> —
	gasket ID ø 8mm ED ø 12mm H 3/5mm		
	<b>GEV No.</b>	101751	<b>Ref. No.</b> —
	bracket		
	<b>GEV No.</b>	520656	<b>Ref. No.</b> —
	union nut thread 1/4" tube ø 6/8mm		



## ignition parts

### electrodes

<b>GEV No.</b>	104772	<b>Ref. No.</b>	404000209 500401800
<b>description</b>	ignition electrode D1 ø 5mm cable length 550mm connection ø2.4mm D2 ø 6mm BL1 16mm BL2 2mm BL3 5mm BL4 8.5mm		
<b>For models:</b>	SPT90GL		

<b>GEV No.</b>	104785	<b>Ref. No.</b>	404530200
<b>description</b>	ignition electrode flange length 38mm flange width 17mm D1 ø 9.5mm L1 15mm BL1 30mm BL2 30mm connection M4 fixing dimensions ø4.5mm mounting distance 28mm		
<b>For models:</b>	FTH30GL		

### ignition cables

#### pre-assembled cables

<b>GEV No.</b>	100186	<b>Ref. No.</b>	402008000
<b>description</b>	ignition cable cable length 600mm connection ø2.4mm / lug M4		
<b>For models:</b>	FTH30GL		

### piezoelectric igniters

#### mounting diameter 18mm

<b>GEV No.</b>	100009	<b>Ref. No.</b>	401540000	
<b>description</b>	piezoelectric igniter body plastic blowing mounting ø 18mm connection ø2.4mm front measurements 26mm M18x1.5			
<b>accessories for</b>	100009			
	<b>GEV No.</b>	101339	<b>Ref. No.</b>	—
	cover cap for piezoelectric igniter			

<b>accessories for</b>	100009			
	<b>GEV No.</b>	106869	<b>Ref. No.</b>	—
	cover cap for piezoelectric igniter ID ø 22mm ED ø 35mm H 25mm			
	<b>GEV No.</b>	107931	<b>Ref. No.</b>	—
	cover cap for piezoelectric igniter ID ø 21mm ED ø 36mm			

### thermocouples

#### threaded thermocouples

#### threaded thermocouples standard

#### with socket with thread M8x1

#### SIT

<b>GEV No.</b>	107630	<b>Ref. No.</b>	404050200	
<b>description</b>	thermocouple SIT M8x1 L 600mm M8x1			
<b>For models:</b>	FTH30GL, SPT60GLS, SPT90-5GLS, SPT90GL, SPT90GLS			
<b>accessories for</b>	107630			
	<b>GEV No.</b>	102067	<b>Ref. No.</b>	—
	nut thread M8x1 H 3mm brass Qty 1 pcs type SEF 1			

### accessories

#### miscellaneous

<b>GEV No.</b>	104771	<b>Ref. No.</b>	450401057
<b>description</b>	fastening angle for thermocouple		

gas burners

hob burners

universal hob burners

SABAF

1 series



<b>GEV No.</b>	104288	<b>Ref. No.</b>	404000200
<b>description</b>	burner cap 3.6kW ø 120mm		
<b>For models:</b>	SPT90GL		
<b>accessories for</b>	104288		
	<b>GEV No.</b>	104289	<b>Ref. No.</b> 404000203
	burner lower part 3/3.6kW for burner cap ø 90/120mm		
	<b>GEV No.</b>	105086	<b>Ref. No.</b> 404000201
	burner ring 3.6kW for burner cap ø 120mm		
	<b>GEV No.</b>	105087	<b>Ref. No.</b> 404000202
	burner head 3.6kW for burner cap ø 120mm		



<b>GEV No.</b>	104286	<b>Ref. No.</b>	404000248
<b>description</b>	burner cap 3kW ø 90mm		
<b>For models:</b>	SPT90GL		
<b>accessories for</b>	104286		
	<b>GEV No.</b>	104289	<b>Ref. No.</b> 404000203
	burner lower part 3/3.6kW for burner cap ø 90/120mm		
	<b>GEV No.</b>	105089	<b>Ref. No.</b> 404000249
	burner ring 3kW for burner cap ø 90mm		
	<b>GEV No.</b>	105090	<b>Ref. No.</b> 404000250
	burner head 3kW for burner cap ø 90mm		



<b>GEV No.</b>	105087	<b>Ref. No.</b>	404000202
<b>description</b>	burner head 3.6kW for burner cap ø 120mm		
<b>For models:</b>	SPT90GL		
<b>accessories for</b>	105087		
	<b>GEV No.</b>	104288	<b>Ref. No.</b> 404000200
	burner cap 3.6kW ø 120mm		
	<b>GEV No.</b>	105085	<b>Ref. No.</b> —
	burner cap ø 120mm		
	<b>GEV No.</b>	105086	<b>Ref. No.</b> 404000201
	burner ring 3.6kW for burner cap ø 120mm		

<b>accessories for</b>	105087		
	<b>GEV No.</b>	105088	<b>Ref. No.</b> —
	burner cap A ø 110mm with central hole		
	<b>GEV No.</b>	105089	<b>Ref. No.</b> 404000249
	burner ring 3kW for burner cap ø 90mm		



<b>GEV No.</b>	105090	<b>Ref. No.</b>	404000250
<b>description</b>	burner head 3kW for burner cap ø 90mm		
<b>For models:</b>	SPT90GL		
<b>accessories for</b>	105090		
	<b>GEV No.</b>	104286	<b>Ref. No.</b> 404000248
	burner cap 3kW ø 90mm		
	<b>GEV No.</b>	104289	<b>Ref. No.</b> 404000203
	burner lower part 3/3.6kW for burner cap ø 90/120mm		
	<b>GEV No.</b>	105089	<b>Ref. No.</b> 404000249
	burner ring 3kW for burner cap ø 90mm		



<b>GEV No.</b>	104289	<b>Ref. No.</b>	404000203
<b>description</b>	burner lower part 3/3.6kW for burner cap ø 90/120mm		
<b>For models:</b>	SPT90GL		
<b>accessories for</b>	104289		
	<b>GEV No.</b>	104286	<b>Ref. No.</b> 404000248
	burner cap 3kW ø 90mm		
	<b>GEV No.</b>	104288	<b>Ref. No.</b> 404000200
	burner cap 3.6kW ø 120mm		
	<b>GEV No.</b>	105086	<b>Ref. No.</b> 404000201
	burner ring 3.6kW for burner cap ø 120mm		
	<b>GEV No.</b>	105087	<b>Ref. No.</b> 404000202
	burner head 3.6kW for burner cap ø 120mm		
	<b>GEV No.</b>	105089	<b>Ref. No.</b> 404000249
	burner ring 3kW for burner cap ø 90mm		
	<b>GEV No.</b>	105090	<b>Ref. No.</b> 404000250
	burner head 3kW for burner cap ø 90mm		
	<b>GEV No.</b>	106482	<b>Ref. No.</b> —
	gas injector thread M6x0.75 WS 7 bore ø 1.1mm		
	<b>GEV No.</b>	106485	<b>Ref. No.</b> —
	gas injector thread M6x0.75 WS 7 bore ø 1.6mm		







 <p>1</p>			
<b>GEV No.</b>	105086	<b>Ref. No.</b>	404000201
<b>description</b>	burner ring 3.6kW for burner cap ø 120mm		
<b>For models:</b>	SPT90GL		
<b>accessories for</b>	105086		
	<b>GEV No.</b>	105085	<b>Ref. No.</b>
			—
	burner cap ø 120mm		
	<b>GEV No.</b>	105087	<b>Ref. No.</b>
			404000202
	burner head 3.6kW for burner cap ø 120mm		
	<b>GEV No.</b>	105088	<b>Ref. No.</b>
			—
	burner cap A ø 110mm with central hole		
	<b>GEV No.</b>	105089	<b>Ref. No.</b>
			404000249
	burner ring 3kW for burner cap ø 90mm		

 <p>1</p>			
<b>GEV No.</b>	105089	<b>Ref. No.</b>	404000249
<b>description</b>	burner ring 3kW for burner cap ø 90mm		
<b>For models:</b>	SPT90GL		
<b>accessories for</b>	105089		
	<b>GEV No.</b>	104286	<b>Ref. No.</b>
			404000248
	burner cap 3kW ø 90mm		
	<b>GEV No.</b>	104289	<b>Ref. No.</b>
			404000203
	burner lower part 3/3.6kW for burner cap ø 90/120mm		
	<b>GEV No.</b>	105090	<b>Ref. No.</b>
			404000250
	burner head 3kW for burner cap ø 90mm		

FLAM GAS

FGP series

 <p>1</p>			
<b>GEV No.</b>	104776	<b>Ref. No.</b>	404000113
<b>description</b>	air mixing tube L 43.4mm ø 14mm		
<b>For models:</b>	SPT60GLS, SPT90-5GLS, SPT90GLS		

 <p>1</p>			
<b>GEV No.</b>	104773	<b>Ref. No.</b>	404000111
<b>description</b>	burner cap ø 83mm 4.5kW		
<b>For models:</b>	SPT60GLS, SPT90-5GLS, SPT90GLS		

 <p>1</p>			
<b>GEV No.</b>	104762	<b>Ref. No.</b>	404000112
<b>description</b>	burner head for burner cap ø 83mm 4.5kW		
<b>For models:</b>	SPT60GLS, SPT90-5GLS, SPT90GLS		

 <p>1</p>			
<b>GEV No.</b>	104763	<b>Ref. No.</b>	404000114
<b>description</b>	burner lower part for burner cap ø 83mm 4.5kW		
<b>For models:</b>	SPT60GLS, SPT90-5GLS, SPT90GLS		

 <p>1</p>			
<b>GEV No.</b>	104764	<b>Ref. No.</b>	404000105
<b>description</b>	burner unit 4.5kW complete		

 <p>1</p>			
<b>GEV No.</b>	104784	<b>Ref. No.</b>	404520200
<b>description</b>	nozzle holder nozzle mounting M10x1 tube ø 10mm gas inlet M16x1.5 gas outlet M14x1		
<b>For models:</b>	FTH30GL		

producer-specific hob burners

RM GASTRO

600 (1) series





 <p>1</p>			
<b>GEV No.</b>	104288	<b>Ref. No.</b>	404000200
<b>description</b>	burner cap 3.6kW ø 120mm		
<b>For models:</b>	SPT90GL		
<b>accessories for</b>	104288		
	<b>GEV No.</b>	104289	<b>Ref. No.</b>
			404000203
	burner lower part 3/3.6kW for burner cap ø 90/120mm		
	<b>GEV No.</b>	105086	<b>Ref. No.</b>
			404000201
	burner ring 3.6kW for burner cap ø 120mm		

Table continues overleaf





<b>accessories for</b>	104288		
	<b>GEV No.</b>	105087	<b>Ref. No.</b> 404000202
burner head 3.6kW for burner cap ø 120mm			

<b>1</b>			
<b>GEV No.</b>	104286	<b>Ref. No.</b>	404000248
<b>description</b>	burner cap 3kW ø 90mm		
<b>For models:</b>	SPT90GL		
<b>accessories for</b>	104286		
	<b>GEV No.</b>	104289	<b>Ref. No.</b> 404000203
burner lower part 3/3.6kW for burner cap ø 90/120mm			
	<b>GEV No.</b>	105089	<b>Ref. No.</b> 404000249
burner ring 3kW for burner cap ø 90mm			
	<b>GEV No.</b>	105090	<b>Ref. No.</b> 404000250
burner head 3kW for burner cap ø 90mm			

<b>1</b>			
<b>GEV No.</b>	105087	<b>Ref. No.</b>	404000202
<b>description</b>	burner head 3.6kW for burner cap ø 120mm		
<b>For models:</b>	SPT90GL		
<b>accessories for</b>	105087		
	<b>GEV No.</b>	104288	<b>Ref. No.</b> 404000200
burner cap 3.6kW ø 120mm			
	<b>GEV No.</b>	105085	<b>Ref. No.</b> —
burner cap ø 120mm			
	<b>GEV No.</b>	105086	<b>Ref. No.</b> 404000201
burner ring 3.6kW for burner cap ø 120mm			
	<b>GEV No.</b>	105088	<b>Ref. No.</b> —
burner cap A ø 110mm with central hole			
	<b>GEV No.</b>	105089	<b>Ref. No.</b> 404000249
burner ring 3kW for burner cap ø 90mm			



<b>1</b>			
<b>GEV No.</b>	105090	<b>Ref. No.</b>	404000250
<b>description</b>	burner head 3kW for burner cap ø 90mm		
<b>For models:</b>	SPT90GL		
<b>accessories for</b>	105090		
	<b>GEV No.</b>	104286	<b>Ref. No.</b> 404000248
burner cap 3kW ø 90mm			
	<b>GEV No.</b>	104289	<b>Ref. No.</b> 404000203
burner lower part 3/3.6kW for burner cap ø 90/120mm			

<b>accessories for</b>	105090		
	<b>GEV No.</b>	105089	<b>Ref. No.</b> 404000249
burner ring 3kW for burner cap ø 90mm			

<b>1</b>			
<b>GEV No.</b>	104289	<b>Ref. No.</b>	404000203
<b>description</b>	burner lower part 3/3.6kW for burner cap ø 90/120mm		
<b>For models:</b>	SPT90GL		
<b>accessories for</b>	104289		
	<b>GEV No.</b>	104286	<b>Ref. No.</b> 404000248
burner cap 3kW ø 90mm			
	<b>GEV No.</b>	104288	<b>Ref. No.</b> 404000200
burner cap 3.6kW ø 120mm			
	<b>GEV No.</b>	105086	<b>Ref. No.</b> 404000201
burner ring 3.6kW for burner cap ø 120mm			
	<b>GEV No.</b>	105087	<b>Ref. No.</b> 404000202
burner head 3.6kW for burner cap ø 120mm			
	<b>GEV No.</b>	105089	<b>Ref. No.</b> 404000249
burner ring 3kW for burner cap ø 90mm			
	<b>GEV No.</b>	105090	<b>Ref. No.</b> 404000250
burner head 3kW for burner cap ø 90mm			
	<b>GEV No.</b>	106482	<b>Ref. No.</b> —
gas injector thread M6x0.75 WS 7 bore ø 1.1mm			
	<b>GEV No.</b>	106485	<b>Ref. No.</b> —
gas injector thread M6x0.75 WS 7 bore ø 1.6mm			

<b>1</b>			
<b>GEV No.</b>	105086	<b>Ref. No.</b>	404000201
<b>description</b>	burner ring 3.6kW for burner cap ø 120mm		
<b>For models:</b>	SPT90GL		
<b>accessories for</b>	105086		
	<b>GEV No.</b>	105085	<b>Ref. No.</b> —
burner cap ø 120mm			
	<b>GEV No.</b>	105087	<b>Ref. No.</b> 404000202
burner head 3.6kW for burner cap ø 120mm			
	<b>GEV No.</b>	105088	<b>Ref. No.</b> —
burner cap A ø 110mm with central hole			
	<b>GEV No.</b>	105089	<b>Ref. No.</b> 404000249
burner ring 3kW for burner cap ø 90mm			



 <p>1</p>			
<b>GEV No.</b>	105089	<b>Ref. No.</b>	404000249
<b>description</b>	burner ring 3kW for burner cap ø 90mm		
<b>For models:</b>	SPT90GL		
<b>accessories for</b>	105089		
 <p>GEV No. 104286 Ref. No. 404000248</p> <p>burner cap 3kW ø 90mm</p>			
 <p>GEV No. 104289 Ref. No. 404000203</p> <p>burner lower part 3/3.6kW for burner cap ø 90/120mm</p>			
 <p>GEV No. 105090 Ref. No. 404000250</p> <p>burner head 3kW for burner cap ø 90mm</p>			

 <p>1</p>			
<b>GEV No.</b>	104764	<b>Ref. No.</b>	404000105
<b>description</b>	burner unit 4.5kW complete		

 <p>1</p>			
<b>GEV No.</b>	104784	<b>Ref. No.</b>	404520200
<b>description</b>	nozzle holder nozzle mounting M10x1 tube ø 10mm gas inlet M16x1.5 gas outlet M14x1		
<b>For models:</b>	FTH30GL		

600 (2) series			
 <p>1</p>			
<b>GEV No.</b>	104776	<b>Ref. No.</b>	404000113
<b>description</b>	air mixing tube L 43.4mm ø 14mm		
<b>For models:</b>	SPT60GLS, SPT90-5GLS, SPT90GLS		

pan supports			
 <p>1</p>			
<b>GEV No.</b>	211055	<b>Ref. No.</b>	408014035 SPG 07313
<b>description</b>	pan support W 315mm L 515mm H 43mm stainless steel		
<b>For models:</b>	SPT90GL		

 <p>1</p>			
<b>GEV No.</b>	104773	<b>Ref. No.</b>	404000111
<b>description</b>	burner cap ø 83mm 4.5kW		
<b>For models:</b>	SPT60GLS, SPT90-5GLS, SPT90GLS		

 <p>1</p>			
<b>GEV No.</b>	211092	<b>Ref. No.</b>	408014065
<b>description</b>	pan support W 320mm L 520mm H 45mm		
<b>For models:</b>	SPT60GLS, SPT90-5GLS, SPT90GLS		

 <p>1</p>			
<b>GEV No.</b>	104762	<b>Ref. No.</b>	404000112
<b>description</b>	burner head for burner cap ø 83mm 4.5kW		
<b>For models:</b>	SPT60GLS, SPT90-5GLS, SPT90GLS		

 <p>1</p>			
<b>GEV No.</b>	104763	<b>Ref. No.</b>	404000114
<b>description</b>	burner lower part for burner cap ø 83mm 4.5kW		
<b>For models:</b>	SPT60GLS, SPT90-5GLS, SPT90GLS		

accessories

pan supports



1

<b>GEV No.</b>	211055	<b>Ref. No.</b>	408014035 SPG 07313
<b>description</b>	pan support W 315mm L 515mm H 43mm stainless steel		
<b>For models:</b>	SPT90GL		



1

<b>GEV No.</b>	211092	<b>Ref. No.</b>	408014065
<b>description</b>	pan support W 320mm L 520mm H 45mm		
<b>For models:</b>	SPT60GLS, SPT90-5GLS, SPT90GLS		

bar burners

bar burners



1

<b>GEV No.</b>	104761	<b>Ref. No.</b>	404000100
<b>description</b>	bar burner ø 40mm Wmm Hmm L 385mm flange width 43mm flange length 43mm griddle		
<b>For models:</b>	FTH30GL		



1

<b>GEV No.</b>	211091	<b>Ref. No.</b>	503000268
<b>description</b>	chargrill grid L 485mm W 310mm		



1

<b>GEV No.</b>	211090	<b>Ref. No.</b>	503000285
<b>description</b>	chargrill grid L 485mm W 310mm fish		



1

<b>GEV No.</b>	210256	<b>Ref. No.</b>	503000305 503000310
<b>description</b>	lava rock grid L 420mm W 240mm H 35mm		



1

<b>GEV No.</b>	211089	<b>Ref. No.</b>	503000355 503000360
<b>description</b>	lava rock grid L 570mm W 420mm H 35mm		

chargrill grids



1

<b>GEV No.</b>	211091	<b>Ref. No.</b>	503000268
<b>description</b>	chargrill grid L 485mm W 310mm		



1

<b>GEV No.</b>	211090	<b>Ref. No.</b>	503000285
<b>description</b>	chargrill grid L 485mm W 310mm fish		

lava rock grids



1

<b>GEV No.</b>	210256	<b>Ref. No.</b>	503000305 503000310
<b>description</b>	lava rock grid L 420mm W 240mm H 35mm		



1

<b>GEV No.</b>	211089	<b>Ref. No.</b>	503000355 503000360
<b>description</b>	lava rock grid L 570mm W 420mm H 35mm		



accessories

nozzle holders



1			
<b>GEV No.</b>	104784	<b>Ref. No.</b>	404520200
<b>description</b>	nozzle holder nozzle mounting M10x1 tube ø 10mm gas inlet M16x1.5 gas outlet M14x1		
<b>For models:</b>	FTH30GL		

miscellaneous



1			
<b>GEV No.</b>	104786	<b>Ref. No.</b>	404000109
<b>description</b>	connecting fitting L 27.5mm		
<b>For models:</b>	SPT60GLS, SPT90-5GLS, SPT90GLS		

gas nozzles

main nozzles

gas nozzles M6x0.75



1			
<b>GEV No.</b>	104766	<b>Ref. No.</b>	404000252
<b>description</b>	gas injector thread M6x0.75 WS 7 bore ø 0.85mm		
<b>For models:</b>	SPT90GL		



1			
<b>GEV No.</b>	104767	<b>Ref. No.</b>	404000207
<b>description</b>	gas injector thread M6x0.75 WS 7 bore ø 0.96mm		
<b>For models:</b>	SPT90GL		



1			
<b>GEV No.</b>	104782	<b>Ref. No.</b>	404000251
<b>description</b>	gas injector thread M6x0.75 WS 7 bore ø 0.75mm		
<b>For models:</b>	SPT90GL		



1			
<b>GEV No.</b>	104765	<b>Ref. No.</b>	404000206
<b>description</b>	gas injector thread M6x0.75 WS 7 bore ø 0.8mm		
<b>For models:</b>	SPT90GL		



1			
<b>GEV No.</b>	104781	<b>Ref. No.</b>	404000253
<b>description</b>	gas injector thread M6x0.75 WS 7 bore ø 1.3mm		
<b>For models:</b>	SPT90GL		



1			
<b>GEV No.</b>	104778	<b>Ref. No.</b>	404000208
<b>description</b>	gas injector thread M6x0.75 WS 7 bore ø 1.45mm		
<b>For models:</b>	SPT90GL		



1			
<b>GEV No.</b>	104787	<b>Ref. No.</b>	404000254
<b>description</b>	gas injector thread M6x0.75 WS 7 bore ø 1.4mm		
<b>For models:</b>	SPT90GL		



1			
<b>GEV No.</b>	104788	<b>Ref. No.</b>	404000211
<b>description</b>	gas injector thread M6x0.75 WS 7 bore ø 1.58mm		
<b>For models:</b>	SPT90GL		

gas nozzles M10x1





1			
<b>GEV No.</b>	100633	<b>Ref. No.</b>	404547077
<b>description</b>	gas injector thread M10x1 WS 11 bore ø 0.75mm inner peaked		





1			
<b>GEV No.</b>	100636	<b>Ref. No.</b>	404547093
<b>description</b>	gas injector thread M10x1 WS 11 bore ø 0.9mm inner peaked		
<b>For models:</b>	FTH30GL		

			
1			
<b>GEV No.</b>	100637	<b>Ref. No.</b>	404547110
<b>description</b>	gas injector thread M10x1 WS 11 bore ø 1.1mm inner peaked		

			
1			
<b>GEV No.</b>	100641	<b>Ref. No.</b>	404547135
<b>description</b>	gas injector thread M10x1 WS 11 bore ø 1.35mm inner peaked		
<b>For models:</b>	FTH30GL		

			
1			
<b>GEV No.</b>	104780	<b>Ref. No.</b>	404547105
<b>description</b>	gas injector thread M10x1 WS 11 bore ø 1.05mm		
<b>For models:</b>	SPT90GLS		

			
1			
<b>GEV No.</b>	104779	<b>Ref. No.</b>	404547160
<b>description</b>	gas injector thread M10x1 WS 11 bore ø 1.6mm		
<b>For models:</b>	SPT90GLS		

			
1			
<b>GEV No.</b>	104777	<b>Ref. No.</b>	404547090
<b>description</b>	gas injector thread M10x1 WS 11 bore ø 1.7mm		
<b>For models:</b>	SPT90GLS		

			
1			
<b>GEV No.</b>	104768	<b>Ref. No.</b>	404547170
<b>description</b>	gas injector thread M10x1 WS 13 bore ø 1.7mm		
<b>For models:</b>	SPT90GLS		

## auxiliary gas parts

### screw connections

#### union screws

			
1			
<b>GEV No.</b>	104783	<b>Ref. No.</b>	404000205
<b>description</b>	union screw for pipe ø 8mm Qty 1 pcs WS 13		
<b>For models:</b>	SPT90GL		

### consumables

#### lava rocks / ceramic briquetts

			
1			
<b>GEV No.</b>	211008	<b>Ref. No.</b>	153000150
<b>description</b>	lava rocks size ca.20-70mm Qty 5kg		

## equipment-specific units

### for bain marie

#### spare parts and accessories

			
1			
<b>GEV No.</b>	691318	<b>Ref. No.</b>	500400365
<b>description</b>	fixing plate mounting pos. right		
<b>For models:</b>	FTH30GL, SPT60GLS, SPT90-5ELS, SPT90-5GLS, SPT90ELS, SPT90GL, SPT90GLS		

#### housing and bezels

			
1			
<b>GEV No.</b>	691357	<b>Ref. No.</b>	450134000
<b>description</b>	fastening angle		

for deep fryers

housing and bezels

			
1			
<b>GEV No.</b>	691357	<b>Ref. No.</b>	450134000
<b>description</b>	fastening angle		

miscellaneous

			
1			
<b>GEV No.</b>	514402	<b>Ref. No.</b>	452510015 502520710
<b>description</b>	drain filter ø 37.5mm		

			
1			
<b>GEV No.</b>	541922	<b>Ref. No.</b>	408712120
<b>description</b>	drain pipe L 120mm thread 3/4"		

			
1			
<b>GEV No.</b>	541923	<b>Ref. No.</b>	408712060
<b>description</b>	drain pipe L 60mm thread 3/4"		

for griddles

spare parts and accessories

			
1			
<b>GEV No.</b>	691318	<b>Ref. No.</b>	500400365
<b>description</b>	fixing plate mounting pos. right		
<b>For models:</b>	FTH30GL, SPT60GLS, SPT90-5ELS, SPT90-5GLS, SPT90ELS, SPT90GL, SPT90GLS		

for hot dog machines

lids

			
1			
<b>GEV No.</b>	691299	<b>Ref. No.</b>	502000400
<b>description</b>	lid ø 200mm		
<b>For models:</b>	HD3N, HD4N, HD4NK, HDN		

glass cylinders

			
1			
<b>GEV No.</b>	691325	<b>Ref. No.</b>	407860003
<b>description</b>	glass cylinder ø 193.5mm H 240mm		
<b>For models:</b>	HD3N, HD4N, HD4NK, HDN		

miscellaneous

			
1			
<b>GEV No.</b>	691301	<b>Ref. No.</b>	502000350
<b>description</b>	bottom plate for hot dog machine perforated ø 190mm		
<b>For models:</b>	HD3N, HD4N, HD4NK, HDN		

			
1			
<b>GEV No.</b>	691302	<b>Ref. No.</b>	502000600
<b>description</b>	connection plate for hot dog machine aluminium HD-01		
<b>For models:</b>	HD01		

			
1			
<b>GEV No.</b>	691305	<b>Ref. No.</b>	502000601
<b>description</b>	connection plate for hot dog machine aluminium HD-02		
<b>For models:</b>	HD02		



1

<b>GEV No.</b>	691303	<b>Ref. No.</b>	502000602
<b>description</b>	connection plate for hot dog machine aluminium HD-03		
<b>For models:</b>	HD03, HD3N		



1

<b>GEV No.</b>	691306	<b>Ref. No.</b>	502000700
<b>description</b>	connection plate for hot dog machine aluminium HD-04		
<b>For models:</b>	HD04, HD4N, HD4NK		



1

<b>GEV No.</b>	691304	<b>Ref. No.</b>	502000500
<b>description</b>	connection plate for hot dog machine L 195mm W 195mm thickness 7.5mm aluminium HD-xN		
<b>For models:</b>	HD3N, HD4N, HD4NK, HDN		



1

<b>GEV No.</b>	691359	<b>Ref. No.</b>	630011300
<b>description</b>	mounting angle		
<b>For models:</b>	CW8		



1

<b>GEV No.</b>	691358	<b>Ref. No.</b>	630011200 6440073
<b>description</b>	mounting angle L 207mm		
<b>For models:</b>	CW8		



1

<b>GEV No.</b>	691300	<b>Ref. No.</b>	452005400
<b>description</b>	separating plate for hot dog machine perforated L 230mm W 178mm		
<b>For models:</b>	HD3N, HD4N, HD4NK, HDN		

### skewers



1

<b>GEV No.</b>	691316	<b>Ref. No.</b>	408706100
<b>description</b>	bun spikes ø 24.8mm hot dog grill aluminium		
<b>For models:</b>	HD01, HD02, HD03, HD04, HD3N, HD4N, HD4NK		

### water containers



1

<b>GEV No.</b>	691307	<b>Ref. No.</b>	408735100 408735101
<b>description</b>	water container for hot dog machine ø 197mm		
<b>For models:</b>	HD3N, HD4N, HD4NK, HDN		

### gear wheels



1

<b>GEV No.</b>	693062	<b>Ref. No.</b>	633100300
<b>description</b>	gear wheel teeth 11 shaft intake ø 8mm ø 31mm hub ø 18mm stainless steel		
<b>For models:</b>	CW8		

### for ovens

#### spare parts and accessories



1

<b>GEV No.</b>	691318	<b>Ref. No.</b>	500400365
<b>description</b>	fixing plate mounting pos. right		
<b>For models:</b>	FTH30GL, SPT60GLS, SPT90-SELS, SPT90-5GLS, SPT90ELS, SPT90GL, SPT90GLS		





doors



1

<b>GEV No.</b>	691375	<b>Ref. No.</b>	507009030
<b>description</b>	oven door H 435mm W 650mm complete		
<b>For models:</b>	SPT60GLS, SPT90-SELS, SPT90-5GLS, SPT90ELS, SPT90GL, SPT90GLS		

for pizza ovens

spare parts and accessories



1

<b>GEV No.</b>	691317	<b>Ref. No.</b>	454500360
<b>description</b>	fastening angle for handle		
<b>For models:</b>	FP36S		

for rolling grills

pipes

bushes



1

<b>GEV No.</b>	693060	<b>Ref. No.</b>	633080100
<b>description</b>	bushing PTFE		
<b>For models:</b>	CW8		

pipes



1

<b>GEV No.</b>	693713	<b>Ref. No.</b>	634210100
<b>description</b>	pipe with gear wheel L 370mm for roller grill		

gear wheels



1

<b>GEV No.</b>	693062	<b>Ref. No.</b>	633100300
<b>description</b>	gear wheel teeth 11 shaft intake ø 8mm ø 31mm hub ø 18mm stainless steel		
<b>For models:</b>	CW8		

for dishwashers

washing and rinsing systems



1

<b>GEV No.</b>	510011	<b>Ref. No.</b>	429008
<b>description</b>	screw connection plastic		

for toasters

pliers

pliers



1

<b>GEV No.</b>	690010	<b>Ref. No.</b>	408012003
<b>description</b>	plier for toaster H 180mm total length 100mm		
<b>For models:</b>	TO920, TO930, TO940, TO960		

knobs

producer-specific knobs

RM GASTRO



1

<b>GEV No.</b>	112926	<b>Ref. No.</b>	402590500
<b>description</b>	knob energy regulator 1-3 t.max.°C temperature range°C ø 42mm shaft ø 6x4.6mm shaft flat upper black		



1

<b>GEV No.</b>	112927	<b>Ref. No.</b>	402593200
<b>description</b>	knob gas tap without ignition flame t.max.°C temperature range°C ø 42mm shaft ø 6x4.6mm shaft flat right		
<b>For models:</b>	SPT60GLS, SPT90-5GLS, SPT90GL, SPT90GLS		



1

<b>GEV No.</b>	112928	<b>Ref. No.</b>	402593100
<b>description</b>	knob gas tap without ignition flame t.max.°C temperature range°C ø 42mm shaft ø 6x4.6mm shaft flat upper		
<b>For models:</b>	FTH30GL		



1

<b>GEV No.</b>	112925	<b>Ref. No.</b>	402593300
<b>description</b>	knob switch 7-position t.max.°C temperature range°C ø 42mm shaft ø 6x4.6mm shaft flat upper black		
<b>For models:</b>	SPT90-5ELS, SPT90ELS		



1

<b>GEV No.</b>	112918	<b>Ref. No.</b>	402592130
<b>description</b>	knob thermostat t.max. 110°C temperature range 30-110°C ø 42mm shaft ø 6x4.6mm shaft flat upper rotation 270° black		



1

<b>GEV No.</b>	112921	<b>Ref. No.</b>	402592005
<b>description</b>	knob thermostat t.max. 190°C temperature range 50-190°C ø 42mm shaft ø 6x4.6mm shaft flat lower rotation 270° black		



1

<b>GEV No.</b>	112922	<b>Ref. No.</b>	402592000
<b>description</b>	knob thermostat t.max. 190°C temperature range 50-190°C ø 42mm shaft ø 6x4.6mm shaft flat upper rotation 270° black		
<b>For models:</b>	EF05, EF08, EF55, EF85, EF88, FE04S, FE07EV, FE07TE, FE44, FE44E, FE44S, FE60P, FE74, FE74E, FE77, FE77T, FE77V		



1

<b>GEV No.</b>	112938	<b>Ref. No.</b>	402593000
<b>description</b>	knob thermostat t.max. 300°C temperature range 50-300°C ø 42mm shaft ø 6x4.6mm shaft flat upper rotation 270° black		
<b>For models:</b>	FP36, FP36S, FTH30, FTH60, FTHR60, FTR30, PD2020L, PD2020R, PM2015R, SPT60GLS, SPT90-5ELS, SPT90-5GLS, SPT90ELS, SPT90GL, SPT90GLS		



1

<b>GEV No.</b>	112919	<b>Ref. No.</b>	402591100
<b>description</b>	knob thermostat t.max. 90°C temperature range 30-90°C ø 42mm shaft ø 6x4.6mm shaft flat right rotation 270° black		
<b>For models:</b>	BMPK4120, VEC810, VEC820		



1			
<b>GEV No.</b>	112920	<b>Ref. No.</b>	402591000
<b>description</b>	knob thermostat t.max. 90°C temperature range 30-90°C ø 42mm shaft ø 6x4.6mm shaft flat upper rotation 270° black		
<b>For models:</b>	BM1120, BMPD2120, BMPD3120, BMPD4120, BMSD2120, BMSD4120, BMV1120, BMV2120, HD3N, HD4N, HD4NK, HDN, WE11, WEV12		

1			
<b>GEV No.</b>	112923	<b>Ref. No.</b>	402590820
<b>description</b>	knob time 120min t.max.°C temperature range°C ø 42mm shaft ø 6x4.6mm shaft flat upper black		
<b>For models:</b>	SPT90-5ELS, SPT90-5GLS, SPT90ELS, SPT90GL, SPT90GLS		

1			
<b>GEV No.</b>	112937	<b>Ref. No.</b>	402590750
<b>description</b>	knob time 15min + permanent ON t.max.°C temperature range°C ø 42mm shaft ø 6x4.6mm shaft flat left		
<b>For models:</b>	TO920, TO930, TO940, TO960		

1			
<b>GEV No.</b>	112924	<b>Ref. No.</b>	402590770
<b>description</b>	knob time 15min + permanent ON t.max.°C temperature range°C ø 42mm shaft ø 6x4.6mm shaft flat left black		
<b>For models:</b>	FP36, FP36S		

1			
<b>GEV No.</b>	112929	<b>Ref. No.</b>	402590700
<b>description</b>	knob toaster t.max.°C temperature range°C ø 42mm shaft ø 6x4.6mm shaft flat right		
<b>For models:</b>	TO920, TO930		

1			
<b>GEV No.</b>	112930	<b>Ref. No.</b>	402590900
<b>description</b>	knob toaster t.max.°C temperature range°C ø 42mm shaft ø 6x4.6mm shaft flat right		
<b>For models:</b>	TO940, TO960		

## accessories

### rosettes

1			
<b>GEV No.</b>	110105	<b>Ref. No.</b>	402595001
<b>description</b>	rosette knob ø 42mm ø 56mm zero mark		
<b>For models:</b>	FP36S		

1			
<b>GEV No.</b>	110310	<b>Ref. No.</b>	402595000
<b>description</b>	rosette knob up to ø 45mm		
<b>For models:</b>	BM1120, BMPD2120, BMPD3120, BMPD4120, BMPK4120, BMSD2120, BMSD4120, BMV1120, BMV2120, EF05, EF08, EF55, EF85, EF88, FE04S, FE07EV, FE07TE, FE44, FE44E, FE44S, FE60P, FE74, FE74E, FE77, FE77T, FE77V, FTH30, FTH30GL, FTH60, FTHR60, FTR30, HD3N, HD4N, HD4NK, HDN, PD2020L, PD2020R, PM2015R, SPT60GLS, SPT90-5ELS, SPT90-5GLS, SPT90ELS, SPT90GL, SPT90GLS, TO920, TO930, TO940, TO960, VEC810, VEC820...(Other models you can see in the webshop)		

## handles and hand wheels

### cylindrical handles

#### fixed

1			
<b>GEV No.</b>	691314	<b>Ref. No.</b>	407803000
<b>description</b>	cylindrical handle thread M8 ø 28mm L 86mm		

### cone handles

1			
<b>GEV No.</b>	110704	<b>Ref. No.</b>	407803190
<b>description</b>	cone handle thread M6 ø 16mm L 25mm plastic black		
<b>For models:</b>	FE07EV, FE77V		

## mushroom cap handles

 <p>1</p>			
<b>GEV No.</b>	112936	<b>Ref. No.</b>	407803050
<b>description</b>	mushroom cap handle thread M5 handle ø 25mm L 17mm plastic black		
<b>For models:</b>	FP36, FP36S, PD2020L, PD2020R, PM2015R		

 <p>1</p>			
<b>GEV No.</b>	112935	<b>Ref. No.</b>	407802001
<b>description</b>	mushroom cap handle thread M5 handle ø 30mm L 19mm plastic black		
<b>For models:</b>	EF05, EF08, EF55, EF85, EF88, HD3N, HD4N, HD4NK, HDN, WE11, WEV12		

## ball handles

 <p>1</p>			
<b>GEV No.</b>	691311	<b>Ref. No.</b>	407803200
<b>description</b>	ball handle thread M6 ø 20mm		
<b>For models:</b>	PD2020L, PD2020R, PM2015R		

## handle bars

### handle bars

 <p>1</p>			
<b>GEV No.</b>	691373	<b>Ref. No.</b>	500504080
<b>description</b>	handle rod tube ø 30.5mm thickness 1.5mm L 460mm SS		
<b>For models:</b>	BMPK4120		

 <p>1</p>			
<b>GEV No.</b>	691372	<b>Ref. No.</b>	500504280
<b>description</b>	handle rod tube ø 30.5mm thickness 1.5mm L 660mm SS		
<b>For models:</b>	BMPD2120		

## HANDLES AND HAND WHEELS RM-GASTRO

### consoles

 <p>1</p>				
<b>GEV No.</b>	690115	<b>Ref. No.</b>	407803100	
<b>description</b>	console pair GN 667 tube ø 30mm H 59mm A 78mm B 37mm C 56mm plastic			
<b>For models:</b>	BMPD2120, BMPD3120, BMPD4120, BMPK4120			
<b>accessories for</b>	690115			
	<b>GEV No.</b>	690439	<b>Ref. No.</b>	—
	handle rod tube ø 30mm thickness 1.5mm L 300mm SS			
	<b>GEV No.</b>	690440	<b>Ref. No.</b>	—
	handle rod tube ø 30mm thickness 1.5mm L 500mm SS			
	<b>GEV No.</b>	690441	<b>Ref. No.</b>	—
	handle rod tube ø 30mm thickness 1.5mm L 700mm SS			

### bracket handles

 <p>1</p>			
<b>GEV No.</b>	700736	<b>Ref. No.</b>	407801500
<b>description</b>	pull handle		
<b>For models:</b>	FE04S, FE07EV, FE07TE, FE44, FE44E, FE44S, FE74, FE74E, FE77, FE77T, FE77V		

 <p>1</p>			
<b>GEV No.</b>	700737	<b>Ref. No.</b>	407802100
<b>description</b>	pull handle L 120mm H 32mm mounting distance 110mm thread M4 W 17mm		
<b>For models:</b>	FE60P		

 <p>1</p>			
<b>GEV No.</b>	691315	<b>Ref. No.</b>	408015110
<b>description</b>	pull handle L 190mm H 48mm mounting distance 173mm handle M6		
<b>For models:</b>	SPT90-5ELS, SPT90-5GLS, SPT90ELS, SPT90GL, SPT90GLS		



			
1			
<b>GEV No.</b>	691374	<b>Ref. No.</b>	408015100
<b>description</b>	pull handle L 515mm H 50mm mounting distance 497mm handle M6		
<b>For models:</b>	SPT60GLS, SPT90-5ELS, SPT90-5GLS, SPT90ELS, SPT90GL, SPT90GLS		

			
1			
<b>GEV No.</b>	691312	<b>Ref. No.</b>	407801100
<b>description</b>	pull handle L 91mm H 26mm mounting distance 73mm handle M4		
<b>For models:</b>	FE60P		

## folding grill handles

			
1			
<b>GEV No.</b>	691340	<b>Ref. No.</b>	408015020
<b>description</b>	handle tube ø 26mm thickness 6mm L 220mm plastic for contact grill		
<b>For models:</b>	PD2020L, PD2020R		

			
1			
<b>GEV No.</b>	691341	<b>Ref. No.</b>	408015010
<b>description</b>	handle tube ø 26mm thickness 6mm L 325mm plastic for contact grill black		
<b>For models:</b>	PM2015R		

## miscellaneous

			
1			
<b>GEV No.</b>	691313	<b>Ref. No.</b>	407803035
<b>description</b>	handle		
<b>For models:</b>	FP36, FP36S		

			
1			
<b>GEV No.</b>	691308	<b>Ref. No.</b>	407800100
<b>description</b>	handle L 140mm W 22mm hole distance 120mm Qty 1 pcs		
<b>For models:</b>	FE04S, FE44, FE44S, FE60P, FE74, FE77, FE77T, FE77V		

## accessories



### extensions

			
1			
<b>GEV No.</b>	691348	<b>Ref. No.</b>	408701500
<b>description</b>	threaded part L 26mm thread M6		
<b>For models:</b>	PD2020L, PD2020R, PM2015R		

## hinges

### oven hinges

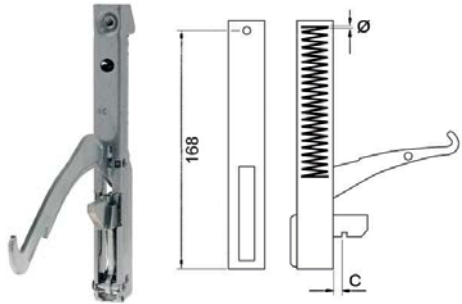
			
1			
<b>GEV No.</b>	700739	<b>Ref. No.</b>	408790310
<b>description</b>	opposite support mounting distance 91mm L 115mm W 10mm		
<b>For models:</b>	SPT60GLS, SPT90-5ELS, SPT90-5GLS, SPT90ELS, SPT90GL, SPT90GLS		

				
1				
<b>GEV No.</b>	700738	<b>Ref. No.</b>	408790300 408790305	
<b>description</b>	oven hinge mounting distance 168mm lever length 158mm groove distance 15mm spring thickness 3.8mm spring length 65mm L 178mm			
<b>For models:</b>	SPT60GLS, SPT90-5ELS, SPT90-5GLS, SPT90ELS, SPT90GL, SPT90GLS			
<b>accessories for</b>	700738			
	<b>GEV No.</b>	700739	<b>Ref. No.</b>	408790310
	opposite support mounting distance 91mm L 115mm W 10mm			

## equipment feet and end caps

## equipment feet

## with screw mounting



1

<b>GEV No.</b>	701203	<b>Ref. No.</b>	407812300
<b>description</b>	equipment foot tube ø 58mm thread M10 thread L 20mm H 110-170mm plastic size 2 1/3" Qty 1 pcs		
<b>For models:</b>	SPT60GLS, SPT90-SELS, SPT90-5GLS, SPT90ELS, SPT90GL, SPT90GLS		



1

<b>GEV No.</b>	701202	<b>Ref. No.</b>	407812200
<b>description</b>	equipment foot tube ø 67mm thread M10 thread L 21mm H 115/175mm SS size 2 1/2" Qty 1 pcs		
<b>For models:</b>	FE60P		

## bullet feet

## plastic



1

<b>GEV No.</b>	700117	<b>Ref. No.</b>	407810810
<b>description</b>	equipment foot pipe type 30x30 thickness 1.2-1.5mm H 23-55mm plastic Qty 1 pcs load capacity 90kg		
<b>For models:</b>	BMSD2120, BMSD4120		

## screw-in feet



1

<b>GEV No.</b>	691344	<b>Ref. No.</b>	407810500 636002100
<b>description</b>	equipment foot thread M8 thread L 20mm ø 23mm H 12mm Qty 1 pcs		
<b>For models:</b>	BM1120, BMV1120, BMV2120, CW8, FTH30, FTH30GL, FTH60, FTHR60, FTR30, PD2020L, PD2020R, PM2015R, VEC810, VEC820		



1

<b>GEV No.</b>	696496	<b>Ref. No.</b>	409083050
<b>description</b>	equipment foot thread M8 thread L 20mm ø 23mm H 12mm Qty 4 pcs		

## bolting feet



1

<b>GEV No.</b>	691345	<b>Ref. No.</b>	407810000
<b>description</b>	equipment foot ø 28mm H 21mm bore ø 5mm Qty 1 pcs hole ø 10mm		
<b>For models:</b>	FP36, FP36S		

## end caps and plugs

## housing plugs



1

<b>GEV No.</b>	691343	<b>Ref. No.</b>	407810100
<b>description</b>	plug mounting ø 6mm ø 11mm H 10mm plastic Qty 1 pcs		
<b>For models:</b>	EF05, EF08, EF55, EF85, EF88, FE04S, FE07EV, FE07TE, FE44, FE44E, FE44S, FE74, FE74E, FE77, FE77T, FE77V, HD01, HD02, HD03, HD04, HD3N, HD4N, HD4NK, HDN, TO920, TO930, TO940, TO960, VEN510, VEN520, VEN810, VEN820, WE11, WEV12		

## for square pipes



1

<b>GEV No.</b>	691342	<b>Ref. No.</b>	407825000
<b>description</b>	end cap L 30mm W 20mm Qty 1 pcs for square pipes		

## DERBY RUOTE

with bolt hole

chrome-plated steel



1

<b>GEV No.</b>	700733	<b>Ref. No.</b>	408791210
<b>description</b>	swivel castor ø 125mm bolt hole bolt hole ø 12mm housing chrome-plated sheet steel capacity 100kg bearing ball bearing wheel body polypropylene tread TPE tyres H 159mm wheel width 30mm Qty 1 pcs		
<b>For models:</b>	BMPD2120, BMPD3120, BMPD4120, BMPK4120		



1

<b>GEV No.</b>	700732	<b>Ref. No.</b>	408792100
<b>description</b>	swivel castor with swivel brake ø 125mm bolt hole bolt hole ø 12mm housing chrome-plated sheet steel capacity 100kg bearing ball bearing wheel body polypropylene tread TPE tyres H 159mm wheel width 30mm Qty 1 pcs		
<b>For models:</b>	BMPD2120, BMPD3120, BMPD4120, BMPK4120		

## bumper angles



1

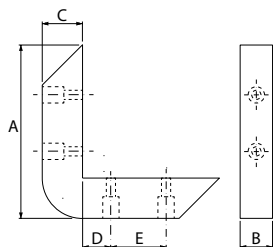

<b>GEV No.</b>	690938	<b>Ref. No.</b>	407830000
<b>description</b>	bumper angle outer length 126mm inner length 99mm W 27mm H 29mm mounting distance 30mm hole distance 35mm hole ø 5mm rubber black		
<b>For models:</b>	BMPD2120, BMPD3120, BMPD4120, BMPK4120		

## baskets

fryer baskets

RM GASTRO



1

<b>GEV No.</b>	970616	<b>Ref. No.</b>	408000102 408000106
<b>description</b>	fryer basket L1 235mm W1 130mm H1 105mm H3 200mm fastening behind		
<b>For models:</b>	EF05, EF55, EF85		



1

<b>GEV No.</b>	970618	<b>Ref. No.</b>	408000101 408000104
<b>description</b>	fryer basket L1 235mm W1 130mm H1 105mm H3 200mm fastening in front		
<b>For models:</b>	FE04S, FE44, FE44E, FE44S, FE74, FE74E		



1

<b>GEV No.</b>	970612	<b>Ref. No.</b>	408000501 408001501
<b>description</b>	fryer basket L1 235mm W1 210mm H1 105mm L2 390mm H2 170mm H3 210mm fastening in front		
<b>For models:</b>	FE07EV, FE07TE, FE74, FE74E, FE77, FE77T, FE77V		



1

<b>GEV No.</b>	970617	<b>Ref. No.</b>	408001000
<b>description</b>	fryer basket L1 245mm W1 300mm H1 120mm H3 210mm fastening in front		



1

<b>GEV No.</b>	970619	<b>Ref. No.</b>	408001030
<b>description</b>	fryer basket L1 455mm W1 245mm H1 90mm		



1

<b>GEV No.</b>	970620	<b>Ref. No.</b>	408001060
<b>description</b>	fryer basket L1 575mm W1 440mm H1 80mm		
<b>For models:</b>	FE60P		



1

<b>GEV No.</b>	970773	<b>Ref. No.</b>	408000502 408001502
<b>description</b>	fryer basket W1 210mm L1 235mm H1 105mm L2 390mm H2 170mm H3 210mm fastening behind		
<b>For models:</b>	EF08, EF85, EF88		

## pasta baskets

### RM GASTRO



1

<b>GEV No.</b>	970846	<b>Ref. No.</b>	408001110
<b>description</b>	pasta basket H1 135mm W1 100mm L1 135mm L2 210mm H2 210mm H3 300mm stainless steel		



1

<b>GEV No.</b>	970621	<b>Ref. No.</b>	408001100
<b>description</b>	pasta basket L1 135mm W1 100mm H1 135mm stainless steel		

## wire baskets for hot dog machines



1

<b>GEV No.</b>	691360	<b>Ref. No.</b>	408009000
<b>description</b>	grid basket for hot dog grill ø 175mm H 215mm		
<b>For models:</b>	HD3N, HD4N, HD4NK, HDN		

## shelves and shelf rails

### grates

#### producer-specific



1

<b>GEV No.</b>	691370	<b>Ref. No.</b>	408011500
<b>description</b>	chargrill grid W 300mm D 645mm chrome-plated steel with handle for salamander grill		



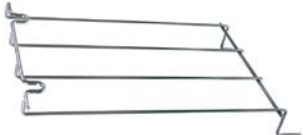

## grid attachments

 <p>1</p>			
<b>GEV No.</b>	691371	<b>Ref. No.</b>	408013100
<b>description</b>	rack support		
<b>For models:</b>	SPT60GLS, SPT90-5ELS, SPT90-5GLS, SPT90ELS, SPT90GL, SPT90GLS		

## shelf rails and supports

### producer-specific

 <p>1</p>			
<b>GEV No.</b>	692758	<b>Ref. No.</b>	453500160
<b>description</b>	shelf support L 40mm W 30mm		

## gaskets

### gaskets for heated units

#### door seals

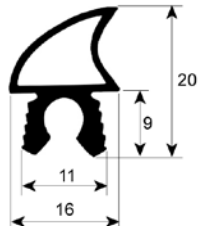
 <p>1</p>			
<b>GEV No.</b>	900792	<b>Ref. No.</b>	409081000 507009120
<b>description</b>	door seal profile 2748 L 1750mm		
<b>For models:</b>	SPT60GLS, SPT90-5ELS, SPT90-5GLS, SPT90ELS, SPT90GL, SPT90GLS		

## transmission technology and ball bearings

### chains

#### roller chains 05B-1 single

 <p>1</p>			
<b>GEV No.</b>	693063	<b>Ref. No.</b>	633110000
<b>description</b>	chain DIN/ISO 05 B-1 splitting 8mm links 35 internal width 3mm rollerø 5mm single closed		
<b>For models:</b>	CW8		

 <p>1</p>			
<b>GEV No.</b>	693064	<b>Ref. No.</b>	633110100
<b>description</b>	chain DIN/ISO 05 B-1 splitting 8mm links 52 internal width 3mm rollerø 5mm single		
<b>For models:</b>	CW8		

## springs

### torsion springs

 <p>1</p>			
<b>GEV No.</b>	700723	<b>Ref. No.</b>	408702505
<b>description</b>	torsion spring ø 20.5mm L1 40mm L2 120mm L3 40mm wire gauge ø 3.6mm		
<b>For models:</b>	PM2015R		

 <p>1</p>			
<b>GEV No.</b>	700084	<b>Ref. No.</b>	408702500
<b>description</b>	torsion spring ø 22mm L1 119mm L2 64mm L3 64mm wire gauge ø 3.5mm		
<b>For models:</b>	PD2020L, PD2020R		

## fittings, hose and pipe connectors

### fittings

#### reducers

 <p>1</p>			
<b>GEV No.</b>	520182	<b>Ref. No.</b>	409017100
<b>description</b>	reducer thread 3/4" ET - 1/2" IT nickel-plated brass total length 17.5mm WS 30		
<b>For models:</b>	FE07EV, FE60P, FE77V		

#### sleeves

 <p>1</p>			
<b>GEV No.</b>	520176	<b>Ref. No.</b>	409021134
<b>description</b>	sleeve thread 3/4" - 3/4" nickel-plated brass WS 32 total length 32mm		



## angle pieces



1

<b>GEV No.</b>	541924	<b>Ref. No.</b>	409011100
<b>description</b>	angle piece thread 1/2" IT - 1/2" IT brass		
<b>For models:</b>	BMV1120, BMV2120, WEV12		



1

<b>GEV No.</b>	520950	<b>Ref. No.</b>	402 525 203
<b>description</b>	elbow thread 1/2" IT stainless steel 90°		

## miscellaneous



1

<b>GEV No.</b>	541928	<b>Ref. No.</b>	409006250
<b>description</b>	angle piece thread 3/4"		

## extensions



1

<b>GEV No.</b>	541925	<b>Ref. No.</b>	409031140
<b>description</b>	extension fitting thread 1/2" IT - 1/2" ET brass L 40mm		
<b>For models:</b>	BMV1120, BMV2120		



1

<b>GEV No.</b>	541926	<b>Ref. No.</b>	409032330
<b>description</b>	extension fitting thread 3/4" IT - 3/4" ET brass L 30mm		



1

<b>GEV No.</b>	541927	<b>Ref. No.</b>	409032340
<b>description</b>	extension fitting thread 3/4" IT - 3/4" ET chrome-plated brass L 40mm		
<b>For models:</b>	FE60P		

## valves and tank inlets

## ball valves

## universal

## mini ball valves



1

<b>GEV No.</b>	514403	<b>Ref. No.</b>	409000200
<b>description</b>	ball valve angled connection 3/8" ET - 1/2" ET DN8 total length 56mm		
<b>For models:</b>	BMV1120, BMV2120, WEV12		

## ball valves with lever handle



1

<b>GEV No.</b>	541921	<b>Ref. No.</b>	409001100
<b>description</b>	ball valve connection 1/2" IT - 1/2" IT DN15 total length 61mm		
<b>For models:</b>	BMPD2120, BMPD3120, BMPD4120, BMPK4120, BMSD2120, BMSD4120		



1

<b>GEV No.</b>	520836	<b>Ref. No.</b>	409001200
<b>description</b>	ball valve connection 3/4" IT - 3/4" IT total length 54mm handle length 87mm		
<b>For models:</b>	FE60P		

## measuring equipment

## thermometers

## built-in thermometers



1

<b>GEV No.</b>	541929	<b>Ref. No.</b>	6111959
<b>description</b>	thermometer mounting measurements 58x25.5mm -40 up to +40°C capillary pipe 700mm probe ø 6mm probe L 85mm		



## fastening material

fasteners			
retaining rings			
DIN 471			
			
1			
<b>GEV No.</b>	693061	<b>Ref. No.</b>	633050500
<b>description</b>	retaining ring shaft ø 25mm thickness 1.2mm steel DIN 471		
<b>For models:</b>	CW8		

## consumables

lava rocks / ceramic briquetts			
			
1			
<b>GEV No.</b>	211008	<b>Ref. No.</b>	153000150
<b>description</b>	lava rocks size ca.20-70mm Qty 5kg		



<b>A</b>		
audible timers	11	
<b>B</b>		
ball valves	34	
bar burners	20	
<b>C</b>		
cable glands	13	
cables	13	
cam switches	10	
castors and bumper angles	31	
condensators & interference suppression filters	13	
consumables	35	
contactors	12	
<b>D</b>		
door seals	33	
<b>E</b>		
electric accessories	13	
end caps and plugs	30	
energy regulators	8	
<b>F</b>		
fans	12	
fasteners	35	
fastening material	35	
fittings	33	
<b>G</b>		
gas burners	16	
gas nozzles	21	
gas taps	14	
gaskets for heated units	33	
grates	32	
<b>H</b>		
heating elements	3	
heating elements for bain maries	3	
heating elements for chip scuttles	3	
heating elements for contact grills	5	
heating elements for convection	7	
heating elements for fryers	3	
heating elements for griddles	5	
heating elements for heating bridges	7	
heating elements for pasta cookers	6	
heating elements for pizza ovens	6	
heating elements for salamanders/toasters	6	
hob burners	16	
hot air motors	12	
hot plates	7	
<b>I</b>		
ignition cables	15	
indicator lights	11	
indicator lights (complete)	11	
<b>L</b>		
lamps	11	
lava rocks / ceramic briquettes	22, 35	
<b>M</b>		
measuring equipment	34	
mechanical timers	11	
microswitches	10	
motors	12	
<b>O</b>		
operating capacitors	13	
oven hinges	29	
<b>P</b>		
piezoelectric igniters	15	
plugs - couplings - power sockets	13	
protective contact power sockets	13	
push/momentary push switches	10	
<b>Q</b>		
quartz heating elements	7	
<b>R</b>		
reducers	33	
retaining rings	35	
rocker/momentary rocker switches	9	
<b>S</b>		
safety thermostats	8	
shelves and shelf rails	32	
sleeves	33	
spiral cables	13	
switches and momentary switches	9	
<b>T</b>		
terminals	13	
thermocouples	15	
thermostats	8	
threaded cable glands	13	
timers	11	
<b>V</b>		
valves and tank inlets	34	