



GAS COMPONENTS



ELECTRIC COMPONENTS



WATER TECHNOLOGY



MECHANICAL COMPONENTS



TOOLS

Spare parts suitable for

RANCILIO

Find the complete and up-to-date range of products in our GEV Webshop



Manufacturer catalogue

The most important spare parts and accessories arranged clearly for every manufacturer

- ✓ Complete product range and all appliance data always up to date in the GEV Webshop
- ✓ Alphabetical Index at the end of the catalogue

GEV Webshop

www.gev-online.co.uk

www.gev-online.com



- 🔍 Add to Favourites
- 🔍 Sign In with email address and usual password
- 🔍 Easy-order – place several items in your basket at the same time
- 🔍 Quick Item search – no login needed











heating elements

heating elements for coffee machine



 <p>1</p>			
GEV No.	417180	Ref. No.	33122017
description	heating element 1700W 230V heating circuits 1 ϕ 105mm H 190mm W1 85mm H1 140mm H2 50mm mounting distance 76mm thread 1/4" copper windings 4 tube ϕ 8mm immersion heater 2 hole fixing connection male faston 6.3mm		
For models:	Epoca1gr, S20		
accessories for	417180		
	GEV No.	361182	Ref. No. —
	nut thread 1/4" H 5mm nickel-plated brass WS 17 Qty 1 pcs		
	GEV No.	510417	Ref. No. —
	flat gasket fibre ED ϕ 20mm ID ϕ 14mm thickness 2mm Qty 1 pcs		
	GEV No.	520228	Ref. No. —
	tooth lock washer ID ϕ 15.3mm ED ϕ 24mm steel Qty 1 pcs for thread M14		
	GEV No.	528110	Ref. No. 36405002
	O-ring EPDM thickness 2.62mm ID ϕ 12.37mm Qty 1 pcs		
	GEV No.	550262	Ref. No. —
	flat gasket copper ED ϕ 20mm ID ϕ 14mm thickness 2mm		

 <p>1</p>			
GEV No.	417181	Ref. No.	33322022
description	heating element 2100W 230V heating circuits 3 mounting ϕ 44mm L 215mm W 34mm H 60mm hole distance 62mm hole ϕ 10mm tube ϕ 8mm L1 40mm L2 65mm L3 110mm H1 30mm H2 30mm connection 1/8" 3 hole flange suitable for RANCILIO immersion heater		

 <p>1</p>			
GEV No.	417009	Ref. No.	36322022
description	heating element 2100W 230V heating circuits 3 mounting ϕ 44mm L 220mm W 29mm H 50mm hole distance 62mm hole ϕ 10mm L1 30mm L2 60mm L3 130mm H1 30mm H2 20mm 3 hole flange suitable for RANCILIO immersion heater		
accessories for	417009		
	GEV No.	528002	Ref. No. —
	flat gasket PTFE ED ϕ 57mm ID ϕ 42mm thickness 3mm Qty 1 pcs equiv. no. 12001/W10470 suitable for		
	GEV No.	528488	Ref. No. —
	flat gasket fibre ED ϕ 57mm ID ϕ 42mm thickness 3mm Qty 1 pcs		

 <p>1</p>			
GEV No.	417010	Ref. No.	36322027
description	heating element 2700W 230V heating circuits 3 mounting ϕ 44mm L 390mm W 31mm H 51mm hole distance 62mm hole ϕ 10mm tube ϕ 8.5mm L1 25mm L2 60mm L3 295mm H1 30mm H2 21mm connection M3 3 hole flange suitable for RANCILIO immersion heater		
accessories for	417010		
	GEV No.	527169	Ref. No. —
	hexagonal nut thread M3 H 2.8mm WS 5.5 brass Qty 1 pcs		
	GEV No.	528002	Ref. No. —
	flat gasket PTFE ED ϕ 57mm ID ϕ 42mm thickness 3mm Qty 1 pcs equiv. no. 12001/W10470 suitable for		
	GEV No.	528488	Ref. No. —
	flat gasket fibre ED ϕ 57mm ID ϕ 42mm thickness 3mm Qty 1 pcs		
	GEV No.	560110	Ref. No. —
	plain washer ID ϕ 3.2mm ED ϕ 7mm thickness 0.5mm SS Qty 20 pcs DIN 125A for thread M3		
	GEV No.	560130	Ref. No. —
	hexagonal nut thread M3 H 2.4mm WS 5.5 SS DIN/ISO DIN 934 / ISO 4032/8673 Qty 20 pcs		

 <p>Image not available</p> <p>1</p>			
GEV No.	417177	Ref. No.	33322031
description	heating element 3000W 230V heating circuits 3 mounting ϕ 44mm hole distance 64mm suitable for RANCILIO		

 <p>1</p>			
GEV No.	417176	Ref. No.	33322028 33322030
description	heating element 3000W 230V heating circuits 3 mounting ϕ 44mm L 215mm W 42mm H 50mm hole distance 62mm hole ϕ 10mm L1 35mm L2 55mm L3 135mm H1 30mm H2 20mm connection M4 3 hole flange suitable for RANCILIO immersion heater		
For models:	Millenium, S20, Z11		
accessories for	417176		
	GEV No.	528003	Ref. No. 36930012
	flat gasket PTFE ED ϕ 59mm ID ϕ 45mm thickness 2mm Qty 1 pcs equiv. no. 36930012 suitable for RANCILIO		

electric components

			
GEV No.	417135	Ref. No.	33322039 36322040
description	heating element 3900W 230V heating circuits 3 mounting \varnothing 44mm L 391mm W 35mm H 51mm hole distance 63mm hole \varnothing 9mm L1 30mm L2 66mm L3 295mm H1 31mm H2 20mm connection M3 3 hole flange suitable for RANCILIO immersion heater		
accessories for	417135		
	GEV No.	510406	Ref. No. 36220003
	flat gasket fibre ED \varnothing 60mm ID \varnothing 48mm thickness 3mm for thread 1½" Qty 1 pcs		
	GEV No.	527169	Ref. No. —
	hexagonal nut thread M3 H 2.8mm WS 5.5 brass Qty 1 pcs		
	GEV No.	560110	Ref. No. —
	plain washer ID \varnothing 3.2mm ED \varnothing 7mm thickness 0.5mm SS Qty 20 pcs DIN 125A for thread M3		
	GEV No.	560130	Ref. No. —
	hexagonal nut thread M3 H 2.4mm WS 5.5 SS DIN/ISO DIN 934 / ISO 4032/8673 Qty 20 pcs		



			
GEV No.	417179	Ref. No.	33323004 33323430
description	heating element 4300W 230V heating circuits 3 mounting \varnothing 42mm L 400mm W 34mm H 51mm hole distance 62mm hole \varnothing 10mm length thermostat sleeves 202mm thermostat sleeves \varnothing 5mm number of thermostat sleeves 1 thermostat sleeve clinging tube \varnothing 8.5mm L1 27mm L2 75mm L3 298mm H1 31mm H2 20mm connection male faston 6.3mm 3 hole flange suitable for RANCILIO immersion heater		
For models:	Classe10, Classe6, Classe8, Epoca2gr		



			
GEV No.	417178	Ref. No.	33322040 33322046
description	heating element 4300W 230V heating circuits 3 mounting \varnothing 44mm L 380mm W 34mm H 52mm hole distance 65mm hole \varnothing 10mm L1 30mm L2 65mm L3 280mm H1 33mm H2 19mm connection M3x0.6 3 hole flange suitable for RANCILIO immersion heater		
For models:	Millenium, S20NSF, Z11		



immersion heating elements

3 hole flange \varnothing 38.5mm

			
GEV No.	416396	Ref. No.	33222002
description	heating element 2400W 230V		

			
GEV No.	418642	Ref. No.	65230113
description	heating element 2600W 230V mounting \varnothing 38.5mm heating circuits 1 L 260mm W 33mm H 24mm number of thermostat sleeves 1 thermostat sleeves \varnothing 7mm length thermostat sleeves 175mm thermostat sleeve eccentric, non clinging tube \varnothing 6.5mm hole distance 57mm 3 hole flange connection male faston 6.3mm immersion heater		
accessories for	418642		
	GEV No.	532577	Ref. No. —
	O-ring EPDM thickness 5.34mm ID \varnothing 40.65mm Qty 1 pcs		

			
GEV No.	416397	Ref. No.	33222003
description	heating element 3000W 230V mounting \varnothing 38.5mm heating circuits 1 L 280mm W 27mm H 23mm number of thermostat sleeves 1 thermostat sleeves \varnothing 4.5mm length thermostat sleeves 250mm tube \varnothing 6.5mm hole distance 57mm hole \varnothing 10mm 3 hole flange connection male faston 6.3mm immersion heater		
accessories for	416397		
	GEV No.	532577	Ref. No. —
	O-ring EPDM thickness 5.34mm ID \varnothing 40.65mm Qty 1 pcs		



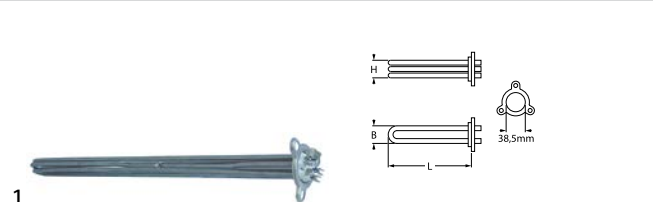



			
GEV No.	416398	Ref. No.	33322004
description	heating element 4000W 230V mounting \varnothing 38.5mm heating circuits 3 L 287mm W 26mm H 34mm number of thermostat sleeves 1 thermostat sleeves \varnothing 7mm length thermostat sleeves 255mm thermostat sleeve centred, adjacent tube \varnothing 6.3mm hole distance 57mm hole \varnothing 10mm 3 hole flange connection male faston 6.3mm immersion heater		
accessories for	416398		
	GEV No.	521120	Ref. No. 36401001 65456075
	O-ring EPDM thickness 5.34mm ID \varnothing 37.47mm Qty 1 pcs		

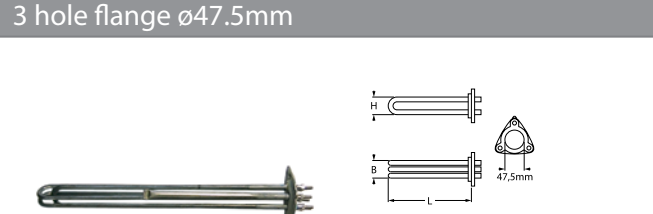





GEV No.	416419	Ref. No.	33322006
description	heating element 6000W 230V hole distance 57mm		
accessories for	416419		
	GEV No.	532577	Ref. No.
	O-ring EPDM thickness 5.34mm ID \varnothing 40.65mm Qty 1 pcs		

3 hole flange \varnothing 47.5mm

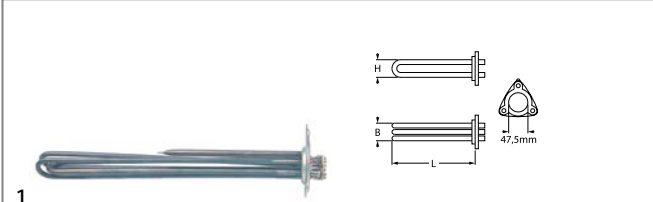



GEV No.	415001	Ref. No.	65230081
description	heating element 4500W 230V mounting \varnothing 47.5mm heating circuits 3 L 316mm W 35mm H 34mm number of thermostat sleeves 1 thermostat sleeves \varnothing 7mm length thermostat sleeves 180mm thermostat sleeve eccentric, non clinging tube \varnothing 6.3mm hole distance 62mm hole \varnothing 8mm connection M4 3 hole flange immersion heater		
spare parts for	415001		
	GEV No.	510408	Ref. No.
	O-ring EPDM thickness 5.34mm ID \varnothing 47mm Qty 1 pcs		
accessories for	415001		
	GEV No.	510562	Ref. No.
	O-ring silicone thickness 5.34mm ID \varnothing 47mm Qty 1 pcs		
	GEV No.	521103	Ref. No.
	nut thread M4 H 3mm WS 7 brass Qty 20 pcs		
	GEV No.	521104	Ref. No.
	washer ID \varnothing 4.3mm ED \varnothing 8mm thickness 0.5mm brass Qty 20 pcs for thread M4		
	GEV No.	560111	Ref. No.
	plain washer ID \varnothing 4.3mm ED \varnothing 9mm thickness 0.8mm SS Qty 20 pcs DIN 125A for thread M4		
	GEV No.	560131	Ref. No.
	hexagonal nut thread M4 H 3.2mm WS 7 SS DIN/ISO DIN 934 / ISO 4032/8673 Qty 20 pcs		



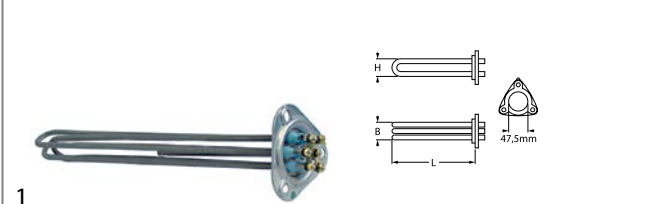

GEV No.	417440	Ref. No.	65230111
description	heating element 4900W 230V mounting \varnothing 47.5mm heating circuits 3 L 330mm W 32mm H 34mm number of thermostat sleeves 1 thermostat sleeves \varnothing 7mm length thermostat sleeves 177mm thermostat sleeve not clinging tube \varnothing 6.5mm hole distance 62mm hole \varnothing 8mm connection M4 3 hole flange immersion heater		
accessories for	417440		
	GEV No.	510408	Ref. No.
	O-ring EPDM thickness 5.34mm ID \varnothing 47mm Qty 1 pcs		
	GEV No.	510562	Ref. No.
	O-ring silicone thickness 5.34mm ID \varnothing 47mm Qty 1 pcs		



GEV No.	416240	Ref. No.	65230083
description	heating element 6545W 230/400V mounting \varnothing 48mm heating circuits 3 L 355mm W 31mm H 37mm number of thermostat sleeves 1 thermostat sleeves \varnothing 7mm length thermostat sleeves 175mm thermostat sleeve upper centre not clinging tube \varnothing 6.5mm hole distance 63mm hole \varnothing 10mm connection M4 3 hole flange immersion heater		
accessories for	416240		
	GEV No.	510408	Ref. No.
	O-ring EPDM thickness 5.34mm ID \varnothing 47mm Qty 1 pcs		
	GEV No.	510562	Ref. No.
	O-ring silicone thickness 5.34mm ID \varnothing 47mm Qty 1 pcs		

with compression flange 50 x 26mm



GEV No.	416234	Ref. No.	65230098
description	heating element 600W 230V heating circuits 1 flange 50x26mm L 160mm W 45mm H 27mm tube \varnothing 8.8mm connection male faston 6.3mm connection length 40mm immersion heater compression flange		
accessories for	416234		
	GEV No.	510387	Ref. No.
	gasket L 46mm W 22mm \varnothing mm EPDM for heating element for flange 50x26mm		
	GEV No.	510388	Ref. No.
	counterflange \varnothing mm hole distancemm perforation \varnothing mm L 43mm W 21mm SS for heating element for flange 50x26mm		



with compression flange 70 x 26mm

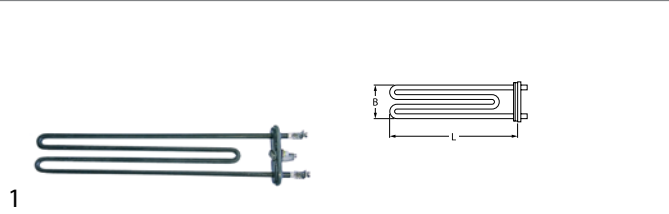

GEV No.	415000	Ref. No.	65230088
description	heating element 2900W 230V heating circuits 1 flange 70x26mm L 272mm W 51mm Hmm tube ø 6.3mm connection M4 immersion heater compression flange		
spare parts for	415000		
	GEV No.	521128	Ref. No. 65437048
	gasket L 66mm W 21mm ømm for heating element suitable for ELETTOBAR, WOLK		
accessories for	415000		
	GEV No.	521128	Ref. No. 65437048
	gasket L 66mm W 21mm ømm for heating element suitable for ELETTOBAR, WOLK		

with expansion flange 70 x 18mm

GEV No.	416239	Ref. No.	65230100
description	heating element 2600W 230V heating circuits 1 flange 70x18mm L 270mm W 65mm connection male faston 6.3mm tube ø 8.5mm immersion heater expansion flange		

1 1/4"

GEV No.	416402	Ref. No.	33122039
description	heating element 4000W 230V heating circuits 3 thread 1 1/4" L 305mm W 38mm H 55mm H1 29mm H2 24mm tube ø 6.3mm connection male faston 6.3mm flange with thread immersion heater		
accessories for	416402		
	GEV No.	510405	Ref. No. 36404017
	flat gasket fibre ED ø 56mm ID ø 42mm thickness 2mm for thread 1 1/4" Qty 1 pcs		
	GEV No.	520232	Ref. No. 23242012
	nut thread 1 1/4" H 5mm nickel-plated brass WS 47 Qty 1 pcs		
	GEV No.	528021	Ref. No. —
	flat gasket PTFE ED ø 53mm ID ø 42.5mm thickness 3mm Qty 1 pcs equiv. no. 12001/02286 suitable for Astoria/Aurora/Brasilia/Wega		

GEV No.	416420	Ref. No.	33122023
description	heating element 1800W 230V heating circuits 1 L 340mm W 46mm H 28mm L1 45mm L2 295mm thread M10x1 mounting distance 40mm tube ø 6.4mm 2 hole fixing connection male faston 6.3mm immersion heater		

GEV No.	416399	Ref. No.	33122024
description	heating element 2000W 230V heating circuits 1 L 349mm W 35mm thread M10x1 mounting distance 29mm tube ø 6.5mm 2 hole fixing dry heating element connection male faston 6.3mm		
accessories for	416399		
	GEV No.	510416	Ref. No. —
	flat gasket fibre ED ø 19mm ID ø 10.5mm thickness 1.5mm for thread M10 Qty 1 pcs		
	GEV No.	510893	Ref. No. 65456015
	O-ring EPDM thickness 2.62mm ID ø 9.92mm Qty 1 pcs		
	GEV No.	520231	Ref. No. —
	nut thread M10x1 H 6mm WS 14 zinc-coated steel Qty 1 pcs		
	GEV No.	521129	Ref. No. —
	nut thread M10 H 6mm SS WS 17 Qty 1 pcs DIN/ISO DIN 439		







GEV No.	416401	Ref. No.	33122021
description	heating element 2000W 230V heating circuits 1 L 395mm W 115mm H 28mm L1 105mm L2 290mm W1 75mm W2 40mm thread M10x1 mounting distance 98mm tube ø 6.3mm 2 hole fixing connection male faston 6.3mm immersion heater		





GEV No.	415665	Ref. No.	65230086
description	heating element 2750/3250W 220/240V heating circuits 1 L 380mm W 110mm H 30mm thread M10x1 mounting distance 75mm tube ø 6.5mm connection M4 immersion heater 2 hole fixing		
spare parts for	415665		
	GEV No.	510893	Ref. No. 65456015
	O-ring EPDM thickness 2.62mm ID ø 9.92mm Qty 1 pcs		
accessories for	415665		
	GEV No.	510416	Ref. No. —
	flat gasket fibre ED ø 19mm ID ø 10.5mm thickness 1.5mm for thread M10 Qty 1 pcs		
	GEV No.	520231	Ref. No. —
	nut thread M10x1 H 6mm WS 14 zinc-coated steel Qty 1 pcs		
	GEV No.	521103	Ref. No. —
	nut thread M4 H 3mm WS 7 brass Qty 20 pcs		
	GEV No.	521104	Ref. No. —
	washer ID ø 4.3mm ED ø 8mm thickness 0.5mm brass Qty 20 pcs for thread M4		
	GEV No.	521129	Ref. No. —
	nut thread M10 H 6mm SS WS 17 Qty 1 pcs DIN/ISO DIN 439		
	GEV No.	560111	Ref. No. —
	plain washer ID ø 4.3mm ED ø 9mm thickness 0.8mm SS Qty 20 pcs DIN 125A for thread M4		

Table continues overleaf



accessories for	415665		
	GEV No.	560131	Ref. No. —
	hexagonal nut thread M4 H 3.2mm WS 7 SS DIN/ISO DIN 934 / ISO 4032/8673 Qty 20 pcs		



 <p>1</p>			
GEV No.	416235	Ref. No.	65080360
description	heating element 3000W 230V heating circuits 1 L 320mm W 50mm H 40mm thread M10x1 mounting distance 44mm tube ø 6.3mm connection male faston 6.3mm 2 hole fixing L1 32mm L2 288mm		
spare parts for	416235		
	GEV No.	510893	Ref. No. 65456015
	O-ring EPDM thickness 2.62mm ID ø 9.92mm Qty 1 pcs		
accessories for	416235		
	GEV No.	510416	Ref. No. —
	flat gasket fibre ED ø 19mm ID ø 10.5mm thickness 1.5mm for thread M10 Qty 1 pcs		
	GEV No.	510893	Ref. No. 65456015
	O-ring EPDM thickness 2.62mm ID ø 9.92mm Qty 1 pcs		
	GEV No.	521129	Ref. No. —
	nut thread M10 H 6mm SS WS 17 Qty 1 pcs DIN/ISO DIN 439		
	GEV No.	560192	Ref. No. —
	tooth lock washer ID ø 10.4mm ED ø 18mm SS DIN/ISO DIN 6798A Qty 1 pcs for thread M10		

 <p>1</p>			
GEV No.	416400	Ref. No.	33122030
description	heating element 3000W 230V L 473mm W 45mm H 30mm thread M10x1 mounting distance 108mm tube ø 7mm connection male faston 6.3mm 2 hole fixing immersion heater L1 108mm L2 364mm		
accessories for	416400		
	GEV No.	510416	Ref. No. —
	flat gasket fibre ED ø 19mm ID ø 10.5mm thickness 1.5mm for thread M10 Qty 1 pcs		
	GEV No.	510893	Ref. No. 65456015
	O-ring EPDM thickness 2.62mm ID ø 9.92mm Qty 1 pcs		
	GEV No.	520231	Ref. No. —
	nut thread M10x1 H 6mm WS 14 zinc-coated steel Qty 1 pcs		
	GEV No.	521129	Ref. No. —
	nut thread M10 H 6mm SS WS 17 Qty 1 pcs DIN/ISO DIN 439		

thermostats

bi-metal thermostats

safety bi-metal thermostats

 <p>1</p>			
GEV No.	390233	Ref. No.	65236039 65926189
description	bi-metal safety thermostat hole distance 24mm switch-off temp. 110°C 1NC 1-pole 16A connection F6.3 2 hole fixing without holder		
accessories for	390233		
	GEV No.	504736	Ref. No. —
	bracket for contact thermostat		
	GEV No.	550388	Ref. No. —
	bracket for contact thermostat mounting distance 24.5mm mounting ø 3.8		

 <p>1</p>			
GEV No.	390318	Ref. No.	65236047
description	bi-metal safety thermostat switch-off temp. 95°C 1-pole 2 hole fixing		

bi-metal thermostats

 <p>1</p>			
GEV No.	390363	Ref. No.	34200055
description	bi-metal thermostat hole distance 23.5mm switch-off temp. 140°C 1NC 1-pole 10A 250V connection F6.3		
For models:	Silvia		

 <p>1</p>			
GEV No.	390226	Ref. No.	65236050
description	bi-metal thermostat hole distance 23.5mm switch-off temp. 65°C NC 1-pole 16A connection F6.3 2 hole fixing		

 <p>1</p>			
GEV No.	390301	Ref. No.	65236035
description	bi-metal thermostat hole distance 23.8mm switch-off temp. 60°C 1NC 1-pole 16A connection F6.3 2 hole fixing		



GEV No.	390319	Ref. No.	65236048
description	bi-metal thermostat hole distance 23.8mm switch-off temp. 80°C 1NC 1-pole 16A connection F6.3 2 hole fixing		

control and safety thermostats

EGO

control thermostats

51._ series



GEV No.	390306	Ref. No.	65236043
description	thermostat t.max. 85°C temperature range fixed 85°C 1-pole gland nut		

safety thermostats

55.32_ series



GEV No.	390324	Ref. No.	34200095
description	safety thermostat switch-off temp. 169°C 3-pole 3NC 20A probe ø 4mm probe L 128mm capillary pipe 890mm capillary pipe isolated 210/210mm gland nut probe SS		
For models:	Classe10, Classe6, Classe8, Epoca2gr		

56._ series



GEV No.	375480	Ref. No.	34200097
description	safety thermostat switch-off temp. 169°C 1-pole 16A probe ø 4mm probe L 130mm capillary pipe 550mm capillary pipe isolated 530mm gland nut		
For models:	Classe10, Classe6, Classe8, Epoca2gr		



IMIT / TEMPOMATIC / ARTHERMO

control thermostats



GEV No.	390457	Ref. No.	34200047
description	thermostat t.max. 85°C temperature range 0-90°C 1-pole 1CO 16A probe ø 6.5mm probe L 110mm capillary pipe 1000mm capillary pipe isolated 950mm gland nut shaft ø 6x4.6mm shaft L 19mm shaft position upper shaft position +135° rotation 270° probe material copper		







GEV No.	390005	Ref. No.	65236014	
description	thermostat t.max. 85°C temperature range 25-85°C 1-pole 1CO 15A probe ø 11mm probe L 35mm capillary pipe 600mm capillary pipe isolated 600mm gland nut shaft ø 6x4.6mm shaft L 8mm shaft position upper rotation 270° screw-in probe			
accessories for	390005			
	GEV No.	510417	Ref. No.	—
	flat gasket fibre ED ø 20mm ID ø 14mm thickness 2mm Qty 1 pcs			
	GEV No.	550261	Ref. No.	—
	nut thread M14x1 H 4mm WS 19 SS Qty 1 pcs			



			
GEV No.	390013	Ref. No.	32200051 34200051
description	thermostat t.max. 90°C temperature range 30-90°C 1-pole 1CO 15A probe ø 6.5mm probe L 95mm capillary pipe 1000mm capillary pipe isolatedmm gland nut shaft L 19mm rotation 270° with disc distance between disc - probe 20mm		

CAEM
control thermostats

			
GEV No.	390672	Ref. No.	65236042
description	thermostat t.max. 53°C temperature range fixed 53°C 1-pole 1CO 16A probe ø 9.5mm probe L 30mm capillary pipe 600mm capillary pipe isolated 540mm gland nut shaft Lmm screw-in probe probe thread M14x1		
spare parts for	390672		
	GEV No.	510417	Ref. No. —
	flat gasket fibre ED ø 20mm ID ø 14mm thickness 2mm Qty 1 pcs		
	GEV No.	550261	Ref. No. —
	nut thread M14x1 H 4mm WS 19 SS Qty 1 pcs		

			
GEV No.	390686	Ref. No.	65236043
description	thermostat t.max. 83°C temperature range°C 1-pole 1CO 20A probe ø 6mm probe L 90mm capillary pipe 630mm capillary pipe isolated 550mm gland nut shaft ømm shaft Lmm shaft position rotation 270° probe material copper		

RANCO
safety thermostats

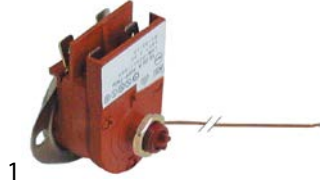
			
GEV No.	390476	Ref. No.	34200093
description	safety thermostat 2-pole 16A probe ø 2mm capillary pipe 470mm capillary pipe isolatedmm gland nut with capillary probe switch-off temp. 165°C		
For models:	Epoca1gr		

			
GEV No.	390305	Ref. No.	34200092 34200092
description	safety thermostat t.max. 165°C temperature range°C 1-pole 1NC 25A probe ø 2mm probe Lmm capillary pipe 490mm capillary pipe isolatedmm gland nut shaft ømm shaft Lmm shaft position rotation° probe material copper with capillary probe screw connection M10x0.75 switch-off temp. 165°C		
For models:	Epoca1gr, Millenium, S20, S20NSF, Z11		
accessories for	390305		
	GEV No.	390313	Ref. No. 23214019
	screw connection		
	GEV No.	390317	Ref. No. 36230014
	double nipple		
	GEV No.	390373	Ref. No. 23212014
	union screw thread M10x1 L 20mm ID ø 2.7mm WS 12 thread L 15mm		

various
control thermostats

			
GEV No.	390478	Ref. No.	34200047
description	thermostat 1-pole		

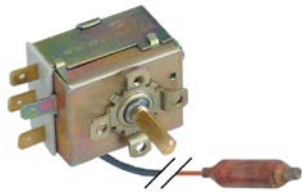

1

GEV No.	390479	Ref. No.	34200046 old version
description	thermostat 1-pole		



1

GEV No.	390002	Ref. No.	34200046
description	thermostat t.max. 90°C temperature range 30-90°C 1-pole shaft ø 4.6mm		

refrigeration thermostats

RANCO

K22 series



1

GEV No.	390524	Ref. No.	68023591
description	thermostat RANCO type K22L1082 probe ømm probe Lmm capillary pipe 2000mm temperature range -22 up to -3°C		

accessories

fitting parts



1

GEV No.	390373	Ref. No.	23212014
description	union screw thread M10x1 L 20mm ID ø 2.7mm WS 12 thread L 15mm		
For models:	Millenium, S20, S20NSF, Z11		

probe clips

spring clips

for safety thermostat



1

GEV No.	550006	Ref. No.	3420091
description	probe clip for pipe ø 8.5mm for probe ø 4mm Qty 1 pcs		

plunger sockets



1

GEV No.	506408	Ref. No.	38123237
description	thermowell thread 1/2" ID ø 10mm L 65mm single		



1

GEV No.	550995	Ref. No.	65999160
description	thermowell thread M14x1 ID ø 5mm L 40mm SS ø 9mm		

switches and momentary switches

rocker/momentary rocker switches

30x11 mm



1

GEV No.	301014	Ref. No.	34030054
description	momentary rocker switch mounting measurements 30x11mm black 1NO 250V 16A connection male faston 6.3mm ambient temperature max. 85/125°C protection IP40 mounting ømm male faston 6.3mm		
For models:	Rocky		







1

GEV No.	301053	Ref. No.	34030042
description	rocker switch mounting measurements 30x11mm white 1NO/indicator light 250V 16A 0-1 connection male faston 6.3mm		
For models:	Rocky		





30x22mm

			
1			
GEV No.	301002	Ref. No.	34030031
description	rocker switch mounting measurements 30x22mm orange 2NO 250V 16A illuminated 0-I connection male faston 6.3mm ambient temperature max. 85/125°C protection IP65		
accessories for	301002		
	GEV No.	301036	Ref. No. 34030131
	protective cover internal size 30x22mm for rocker switch mounting measurementsmm		

			
1			
GEV No.	301017	Ref. No.	34030045
description	rocker switch mounting measurements 30x22mm green 2CO 250V 16A illuminated connection male faston 6.3mm ambient temperature max. 125/55°C protection IP40		
accessories for	301017		
	GEV No.	301036	Ref. No. 34030131
	protective cover internal size 30x22mm for rocker switch mounting measurementsmm		

			
1			
GEV No.	301036	Ref. No.	34030131
description	protective cover internal size 30x22mm for rocker switch mounting measurementsmm		
For models:	MD		

			
1			
GEV No.	301188	Ref. No.	34030058
description	rocker switch mounting measurements 30x22mm black 2NO/2NO 250V 16A I O II connection male faston 6.3mm ambient temperature max. 125/55°C protection IP40		
accessories for	301188		
	GEV No.	301036	Ref. No. 34030131
	protective cover internal size 30x22mm for rocker switch mounting measurementsmm		

			
1			
GEV No.	346157	Ref. No.	34030052
description	momentary rocker switch mounting measurements 30x22mm orange 2NO 250V 16A illuminated START connection male faston 6.3mm ambient temperature max. 85°C protection IP40		
For models:	MD		

			
1			
GEV No.	347279	Ref. No.	34030073
description	rocker switch mounting measurements 30x22mm blue 2NO 250V 16A illuminated cup warmer connection male faston 6.3mm ambient temperature max. 85/125°C protection IP40		

			
1			
GEV No.	346108	Ref. No.	34030037 34030064
description	rocker switch mounting measurements 30x22mm orange 2NO 250V 16A illuminated ignition connection male faston 6.3mm ambient temperature max. 125/55°C protection IP40		
For models:	MD, Millenium, S20, S20NSF, Silvia		

			
1			
GEV No.	346164	Ref. No.	34030034 34030038
description	rocker switch mounting measurements 30x22mm orange/black 2NO 250V 16A illuminated steam connection male faston 6.3mm ambient temperature max. 125/55°C protection IP40		
For models:	Silvia		

			
1			
GEV No.	346110	Ref. No.	34030047
description	rocker switch mounting measurements 30x22mm red 2NO 250V 16A illuminated coffee connection male faston 6.3mm ambient temperature max. 125/55°C protection IP40		
For models:	S20, S20NSF, Silvia		

			
1			
GEV No.	346111	Ref. No.	34030039
description	rocker switch mounting measurements 30x22mm red 2NO 250V 16A illuminated cup warmer connection male faston 6.3mm ambient temperature max. 125/55°C protection IP40		
For models:	S20, Z11		

			
1			
GEV No.	346109	Ref. No.	34030029
description	rocker switch mounting measurements 30x22mm red 2NO 250V 16A illuminated water connection male faston 6.3mm ambient temperature max. 125/55°C protection IP40		
For models:	Millenium, S20, S20NSF, Silvia, Z11		



push/momentary push switches

19x13mm



1

GEV No.	346115	Ref. No.	10705354
description	momentary push switch mounting measurements 19x13mm black 1NO 250V 16A water connection male faston 4.8mm ambient temperature max. 85°C protection IP40		
For models:	Millenium		



1

GEV No.	301191	Ref. No.	34030055
description	momentary push switch mounting measurements 19x13mm black 2NO 250V 10A connection male faston 4.8mm ambient temperature max. 105°C protection IP40		



1

GEV No.	301190	Ref. No.	34030056
description	push switch mounting measurements 19x13mm black 2NO 250V 16A connection male faston 4.8mm ambient temperature max. 105°C protection IP40		



1

GEV No.	346116	Ref. No.	10705356
description	push switch mounting measurements 19x13mm black 2NO 250V 16A cup warmer connection male faston 6.3mm ambient temperature max. 85°C protection IP40		
For models:	Millenium		



1

GEV No.	346114	Ref. No.	10705355
description	push switch mounting measurements 19x13mm black 2NO 250V 16A water connection male faston 6.3mm ambient temperature max. 125°C protection IP40		
For models:	Millenium		



1

GEV No.	347605 ¹	Ref. No.	34030069
description	push switch mounting measurements 19x13mm yellow 2NO 250V 16A illuminated connection male faston 6.3mm ambient temperature max. 105°C protection IP40		
accessories for	347605		
	GEV No.	346541	Ref. No.
			—
	protective cover for rocker switch external size 23.4x17.4mm internal size 19x13mm H 9.5mm mounting measurementsmm		

¹illuminated

28.5x28.5mm



1

GEV No.	347931	Ref. No.	34030066
description	momentary push switch mounting measurements 28.5x28.5mm black 2NO 250V 16A connection male faston 6.3mm ambient temperature max. 150°C		

30x22mm



1

GEV No.	346112	Ref. No.	34030970
description	push switch mounting measurements 30x22mm black 2NO 250V 16A illuminated connection male faston 6.3mm ambient temperature max. 120/55°C protection IP54 with rubber collar		
For models:	Classe10, Classe6, Epoca1gr, Epoca2gr		



1

GEV No.	301036	Ref. No.	34030131
description	protective cover internal size 30x22mm for rocker switch mounting measurementsmm		
For models:	MD		

accessories

push buttons





1

GEV No.	506385	Ref. No.	38130014
description	cap boiler		





			
1			
GEV No.	506391	Ref. No.	38130016
description	cap detergent		

			
1			
GEV No.	506384	Ref. No.	38130013
description	cap on		

			
1			
GEV No.	506386	Ref. No.	38130015
description	cap tank		

			
1			
GEV No.	346117	Ref. No.	38123553
description	push button		
For models:	Millenium		

			
1			
GEV No.	506387	Ref. No.	38130017
description	push button cold rinsing		

			
1			
GEV No.	506392	Ref. No.	38130011
description	push button cold rinsing		

			
1			
GEV No.	506390	Ref. No.	38130019
description	push button drain pump		

			
1			
GEV No.	506388	Ref. No.	38130018
description	push button regeneration		

microswitches



lever actuated

			
1			
GEV No.	346159	Ref. No.	34100004
description	microswitch with lever 250V 10A 1CO connection male faston 6.3mm ambient temperature max. 125°C lever length 25mm		
For models:	MD		

roller-lever actuated

heavy duty version

			
1			
GEV No.	347286	Ref. No.	34100001
description	microswitch with handle with a switch 250V 16A 1CO connection screw L 50mm ambient temperature max. 85°C lever length 50mm		
For models:	Z11		

			
1			
GEV No.	345266	Ref. No.	34100001 old version
description	microswitch with handle with a switch 250V 16A 1CO connection soldering connection L 48mm L1 39mm ambient temperature max. 85°C mounting distance 25mm C36ZP type C109 actuating force: 125g lever length 49mm		
accessories for	345266		
	GEV No.	527628	Ref. No.
			—
	protection cap		

pin-plunger actuated

			
1			
GEV No.	345105	Ref. No.	68023055
description	microswitch with plunger 250V 16A 1CO connection male faston 6.3mm L 28mm ambient temperature max. 125°C mounting distance 22mm type SM-51 actuating force: 280g black		



1

GEV No.	346158	Ref. No.	34100003
description	microswitch with plunger 250V 5A 1CO connection male faston 4.8mm ambient temperature max. 105°C mounting distance 22mm type 2663RA actuating force: 120g black		
For models:	MD		

M12



1

GEV No.	345350	Ref. No.	34100012 34100014
description	microswitch with plunger mounting distance 22mm thread M12x0.75 thread L 16mm 250V 16A 1CO connection male faston 6.3mm stroke 4mm ambient temperature max. 125°C type EF83161.3 actuating force: 66g		
accessories for	345350		
	GEV No.	345351	Ref. No. —
	nut thread M12x0.75 H 1.6mm WS 14 chrome-plated brass Qty 1 pcs		

miscellaneous



1

GEV No.	506405	Ref. No.	15705010
description	microswitch with plunger mechanical		

system switches (ROLD)



1

GEV No.	345536	Ref. No.	65226096
description	element holder mounting ø 16mm flat black		



1

GEV No.	345601	Ref. No.	65299035
description	indicator lamp holder V ø 11mm		



1

GEV No.	345606	Ref. No.	65226071
description	momentary switch unit 2CO 250V 16A connection male faston 6.3mm		



1

GEV No.	346847	Ref. No.	65409003
description	rotary disc green/black disc ø 18.7mm		



1

GEV No.	345605	Ref. No.	65208010
description	switch 2CO 250V 16A connection male faston 6.3mm		



1

GEV No.	346851	Ref. No.	65080804
description	switch 2CO 250V 16A connection male faston 6.3mm		

cam switches

3 operating positions



1

GEV No.	347854	Ref. No.	34030067 34060067 65205011
description	cam switch 3 operating positions 6NO sequence 1-0-2 16A shaft ø 6x4.6mm shaft L 23mm connection male faston 6.3mm		



rotary switches

BREMAS

A3200 series



1

GEV No.	346023	Ref. No.	34030025
description	rotary switch 3 1-0-2 sets of contacts 6 type CS0327419 600V 40A shaft \varnothing 5x5mm shaft L 23mm shaft square connection screw		
For models:	S20, S20NSF, Z11		

SONTHEIMER



1

GEV No.	345388	Ref. No.	34030026
description	rotary switch 2 0-1 sets of contacts 2 600V 16A shaft \varnothing 6x6mm shaft L 24mm type A2/12E/Z3/BG/X70S connection screw shaft square		



1

GEV No.	301193	Ref. No.	34030027
description	rotary switch 3 1-0-2 sets of contacts 3 400V 16A shaft \varnothing 6x6mm shaft L 25mm connection screw shaft star-shaped		

miscellaneous



1

GEV No.	347280	Ref. No.	34030006
description	rotary switch 2NO 16A shaft L 18mm \varnothing 40mm 2-pole shaft 5x5mm		
For models:	Z11		

magnetic switches

36x13mm



1

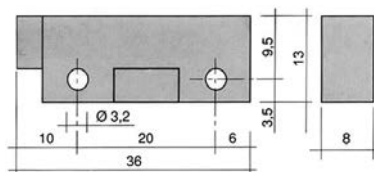

GEV No.	345118 ¹	Ref. No.	65211002	
description	magnetic switch L 36mm W 13mm 1NO 250V 1A P max. 50W connection cable cable length 980mm			
accessories for	345118			
	GEV No.	345399	Ref. No.	65927088
	magnet \varnothing 3.3mm L 40mm H 8mm W 13mm hole distance 30mm M3			

¹with coded connector

accessories

magnets



1

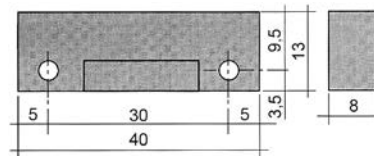

GEV No.	345399	Ref. No.	65927088
description	magnet \varnothing 3.3mm L 40mm H 8mm W 13mm hole distance 30mm M3		



1

GEV No.	346953	Ref. No.	65999108
description	magnet \varnothing mm L 23mm H 17mm W 18mm M6 hole \varnothing 6.5mm		



lamps

indicator lights

indicator lights 2-piece (lens and indicator lamp)

indicator light lenses

ø10mm (type SRZ-2)



1

GEV No.	359362	Ref. No.	34030113/+116
----------------	--------	-----------------	---------------

description	indicator light housings mounting measurements ø10mm clear square
--------------------	---



1

GEV No.	359359	Ref. No.	34030112
----------------	--------	-----------------	----------

description	indicator light housings mounting measurements ø10mm green square
--------------------	---



1

GEV No.	359358	Ref. No.	34030113
----------------	--------	-----------------	----------

description	indicator light housings mounting measurements ø10mm orange square
--------------------	--

ø10mm (type SRZ-3)



1

GEV No.	359124	Ref. No.	34030110
----------------	--------	-----------------	----------

description	indicator light housings mounting measurements ø10mm yellow round Qty 1 pcs
--------------------	---

For models:	Classe8, Epoca1gr, Epoca2gr
--------------------	-----------------------------

accessories for	359124
------------------------	--------



GEV No.	359132	Ref. No.	—
description	indicator lamp green 250V connection male faston 6.3mm protection IP54 ambient temperature max. 85°C		

indicator lamps for socket type SRZ / SDK / SDY / SFK



1

GEV No.	359130	Ref. No.	34030116
----------------	--------	-----------------	----------

description	indicator lamp 230V clear connection male faston 6.3mm ø 8mm
--------------------	--

For models:	Classe8, Epoca1gr, Epoca2gr
--------------------	-----------------------------

indicator lights (complete)

ø 9mm



1

GEV No.	359809	Ref. No.	34030093
----------------	--------	-----------------	----------

description	indicator light ø 9mm 230V yellow
--------------------	-----------------------------------

ø10mm

with plug-in socket



1

GEV No.	359140	Ref. No.	65216018
----------------	--------	-----------------	----------

description	indicator light ø 10mm yellow 230V connection male faston 6.3mm Qty 1 pcs
--------------------	---

ø12mm

with screw socket



1

GEV No.	359567	Ref. No.	10111015
----------------	--------	-----------------	----------

description	indicator light ø 12mm 250V green cable length 400mm
--------------------	--

For models:	S20, S20NSF, Z11
--------------------	------------------



1

GEV No.	359461	Ref. No.	10111019
----------------	--------	-----------------	----------

description	lamp ø 12mm 250V green connection male faston 6.3mm cable length 260mm temp.-resist. 150°C
--------------------	--

For models:	S20, S20NSF
--------------------	-------------



1

GEV No.	359460	Ref. No.	10111017
----------------	--------	-----------------	----------

description	lamp ø 12mm 250V orange connection male faston 6.3mm cable length 260mm temp.-resist. 150°C
--------------------	---

For models:	S20, S20NSF
--------------------	-------------

30x11mm



1

GEV No.	359159	Ref. No.	34030060
----------------	--------	-----------------	----------

description	indicator light mounting measurements 30x11mm 230V yellow connection male faston 6.3mm temp.-resist. 125°C
--------------------	--

For models:	S20, Silvia
--------------------	-------------



LED

indicator lamps

mounting diameter 6mm



1			
GEV No.	359404	Ref. No.	65216028
description	indicator light LED mounting ø 6mm 5VDC green connection cable 200mm 2mA		



1			
GEV No.	358098	Ref. No.	65216029
description	indicator light LED mounting ø 6mm 5VDC yellow connection cable 200mm 2mA		

timers

programme timers

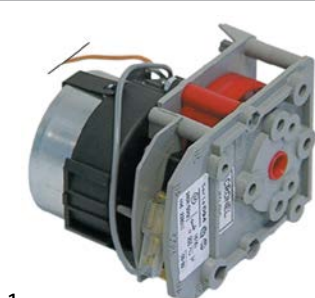

1			
GEV No.	360005	Ref. No.	65238052
description	timer BIGATTI D94 engines 1 chambers 1 operation time 20min 230V shaft ømm shaft Lmm manif. no. WE006 motor type 82354021L		





1			
GEV No.	360349	Ref. No.	65238053
description	timer CDC 11803 engines 1 chambers 3 operation time 150s 230V shaft ømm shaft Lmm manif. no. 11803F1BEE000.0010 motor type M48R ATS type 11803F1 / 238046		
spare parts for	360349		
	GEV No.	360673	Ref. No.
			—
	motor kit pinion ø 6.8mm teeth 15 230V voltage AC 50/60Hz turn direction clockwise motor ø 48mm H 18.5mm motor type UDS-40NE1RNZ165 cable length 150mm with holder		



1			
GEV No.	360524	Ref. No.	68023003 68023222
description	timer CDC 11904 engines 1 chambers 4 operation time 12min 230V shaft ømm shaft Lmm manif. no. 11904F1 / BDR000.0000 motor type M48R ATS		
spare parts for	360524		
	GEV No.	360118	Ref. No.
			—
	motor CDC pinion ø 4.9mm teeth 10 230V voltage AC 50/60Hz turn direction right motor ø 47mm H 19.3mm motor type M48R ATS for timer cable length 260mm 1.9/2.5W		





1			
GEV No.	360133	Ref. No.	65238066
description	timer CDC 7804DV engines 2 chambers 4 operation time 60s / 20min 230V shaft ømm shaft Lmm manif. no. 7804DV / 360133 motor type M37RN/M37LN		
spare parts for	360133		
	GEV No.	360119	Ref. No.
			—
	motor CDC pinion ø 5.4mm teeth 12 230V turn direction right motor ø 37mm motor type M37RN for timer		
	GEV No.	360131	Ref. No.
			—
	motor CDC pinion ø 5.4mm teeth 12 230V turn direction left motor ø 37mm motor type M37LN for timer		

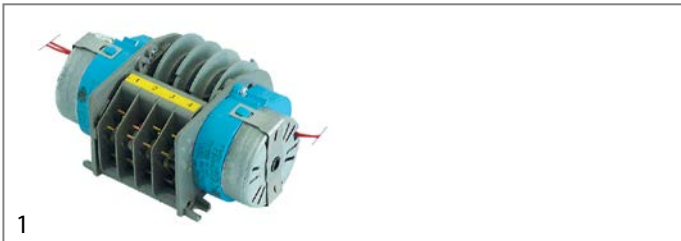

1			
GEV No.	360165	Ref. No.	68023247
description	timer FIBER P20 engines 1 chambers 4 operation time 10min 230V shaft ømm shaft Lmm manif. no. P205J04J414 motor type M51B-J0R6400		
spare parts for	360165		
	GEV No.	360673	Ref. No.
			—
	motor kit pinion ø 6.8mm teeth 15 230V voltage AC 50/60Hz turn direction clockwise motor ø 48mm H 18.5mm motor type UDS-40NE1RNZ165 cable length 150mm with holder		



1			
GEV No.	360313	Ref. No.	34050022
description	timer FIBER P25 engines 2 chambers 4 operation time 6s / 2min 230V shaft ømm shaft Lmm manif. no. P255J04JD78 motor type M51B-J0R6400 / M51BJ0L6400		
spare parts for	360313		
	GEV No.	360673	Ref. No. —
	motor kit pinion ø 6.8mm teeth 15 230V voltage AC 50/60Hz turn direction clockwise motor ø 48mm H 18.5mm motor type UDS-40NE1RNZ165 cable length 150mm with holder		
	GEV No.	360674	Ref. No. —
	motor kit pinion ø 6.8mm teeth 15 230V voltage AC 50/60Hz turn direction counterclockwise motor ø 48mm H 18.5mm motor type UDS40NE1RNZ165 cable length 150mm with holder		

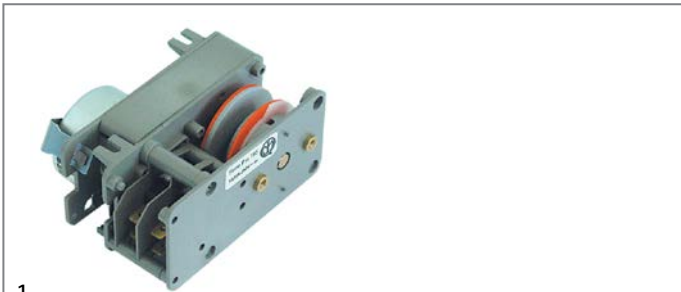

1			
GEV No.	360315	Ref. No.	34050033
description	timer FIBER P26 engines 1 chambers 2 operation time 120s 230V shaft ømm shaft Lmm manif. no. P265JV2H3AV motor type P265J03L109		



1			
GEV No.	360314	Ref. No.	34050032
description	timer FIBER P26 engines 1 chambers 3 operation time 20min 230V shaft ømm shaft Lmm manif. no. P265J03L109 motor type M61B40R6400		



1			
GEV No.	360454	Ref. No.	65238066 (old version)
description	timer FIBER P26 engines 2 chambers 4 operation time 60s / 20min 230V shaft ømm shaft Lmm manif. no. P265J04KB75 motor type M61B40R6400 / M61B40L6400		

contactors

ABB

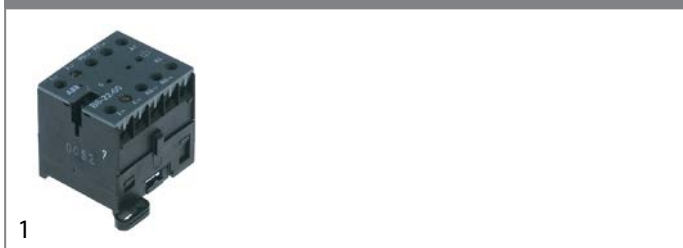

1			
GEV No.	380092	Ref. No.	34200332
description	power contactor resistive load 20A 230VAC (AC3/400V) 12A/5.5kW main contacts 4NO auxiliary contacts connection screw connection type B6-40-00 / B7-40-00		
For models:	Classe10, Classe6, Classe8, Epoca2gr		

GENERAL ELECTRIC (AEG)

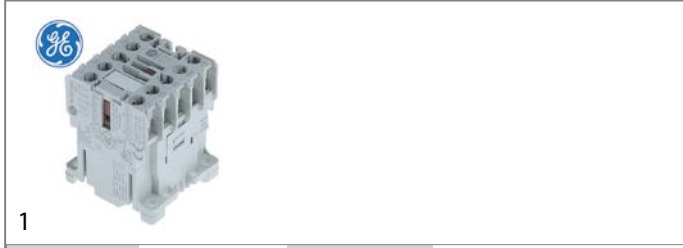

1			
GEV No.	380238	Ref. No.	65229032
description	power contactor resistive load 20A 230VAC (AC3/400V) 8.4A/4kW main contacts 3NO auxiliary contacts 1NO connection screw connection type LS0510A type AEG LS0510A type GE MC1A 310A		

1

GEV No.	381095	Ref. No.	34200025
description	power contactor resistive load 25A 230VAC (AC3/400V) 12A/5.5kW main contacts 3NO auxiliary contacts 1NO connection screw connection type AEG type GE CL01A400T6		
For models:	Z11		



2

GEV No.	380244	Ref. No.	34200260
description	power contactor resistive load 25A 230VAC (AC3/400V) 9A/4kW main contacts 3NO auxiliary contacts 1NO connection screw connection type AEG LS4K 10A type GE CL00A 310		
For models:	Classe10, Classe6, Classe8, Epoca2gr		

ISKRA (FANAL)
power contactors



1

GEV No.	380212	Ref. No.	34200219
description	power contactor resistive load 20A 230VAC (AC3/400V) 8.5A/5.5kW main contacts 3NO auxiliary contacts 1NC connection screw connection type Fanal K07M 01 type ISKRA DSL7 01		
For models:	Millenium		

relays

power relays

with DIN rail mounting

lateral



1

GEV No.	380313	Ref. No.	65229036
description	power relays FINDER 230VAC 16A 3CO connection male faston DIN rail manuf. no. 62.83.8.230.0008		

with flange mounting



1

GEV No.	380357	Ref. No.	34200197
description	power relays FINDER 230VAC 16A 3NO connection male faston bracket mounting manuf. no. 62.83.8.230.0300+062.10		



1

GEV No.	380130	Ref. No.	34200194 34200196
description	power relays Italiana Relè 230VAC 16A 3NO connection male faston 6.3mm screw mounting manuf. no. B1-3-230AC		
For models:	Z11		

with bracket mounting



GEV No.	380815	Ref. No.	65229039
description	power relays 230VAC 16A 2NO connection male faston 6.3mm flange dimensions 36x38x68mm		



GEV No.	380702	Ref. No.	34200181
description	power relays FINDER 230VAC 16A 3NO connection male faston 6.3mm flange dimensions 36x38x68mm manuf. no. 62.83.8.230.0300 230V		
For models:	MD		



GEV No.	380291	Ref. No.	34200037
description	power relays bracket mounting		



GEV No.	380357	Ref. No.	34200197
description	power relays FINDER 230VAC 16A 3NO connection male faston bracket mounting manuf. no. 62.83.8.230.0300+062.10		



GEV No.	380312	Ref. No.	34200192 3420037 65229023 65229024 68023190
description	power relays FINDER 230VAC 10A 3CO connection male faston 4.8mm bracket mounting dimensions 52x32.2x36.5mm manuf. no. 60.63.8.230.0000		
For models:	Classe10, Classe6, Classe8, Epoca2gr, MD, Millenium, S20, S20NSF		



GEV No.	380185	Ref. No.	65229029
description	power relays Italiana Relè 230VAC 30A 1NO connection F6.3 bracket mounting dimensions 36.5x32.2x51.8mm manuf. no. A10-230AC-FA		



GEV No.	380139	Ref. No.	65929115
description	power relays FINDER 230VAC 16A 2CO connection F6.3 bracket mounting dimensions 68x38.2x35.8mm manuf. no. 62.82.8.230.0000		



GEV No.	380222	Ref. No.	34200189
description	power relays 230VAC 16A 2NO		





accessories

			
1			
GEV No.	380703	Ref. No.	34200182
description	adapter for flange mounting suitable for Finder relay 62 series.		
For models:	MD		

level relays

GICAR

			
1			
GEV No.	402103	Ref. No.	34070016 34200016
description	level controller 230/240V voltage AC 50/60Hz connection F6.3 type NRL30/1E-2C/F		
For models:	S20, S20NSF, Z11		

			
1			
GEV No.	400417	Ref. No.	34070029
description	level relay 230V voltage AC 50/60Hz 5A connection F6.3 type RL30/1E-2C/F.9.1.40.20		
For models:	Classe10, Classe6, Classe8, Epoca2gr, Millenium, S20, S20NSF		

transformers

toroidal core transformers

			
1			
GEV No.	401884	Ref. No.	34200267
description	transformer 140VA		
For models:	Classe10, Classe8		

			
1			
GEV No.	400415	Ref. No.	34200258
description	transformer 75VA		

probes

producer-specific probes

			
1			
GEV No.	400910	Ref. No.	65231014
description	temperature probe NTC 10kOhm cable silicone probe -40 up to +110°C cable -50 up to +180°C connection coded plug thread probe ø4.5x30mm cable length 0.35m		

			
1			
GEV No.	400416	Ref. No.	34070174
description	temperature probe PTC 2kOhm cable silicone probe -50 up to +150°C cable -50 up to +180°C connection plug thread 3/8" probe ø8x30mm cable length 0.7m		
For models:	Classe10, Classe6, Classe8, Epoca2gr		

electronics

EPROMS

			
1			
GEV No.	400900	Ref. No.	65225029
description	EPROM CODE 225029-3		

PCBs

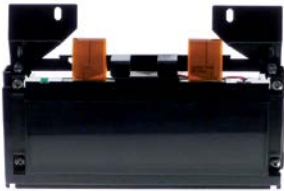
			
1			
GEV No.	402173	Ref. No.	10705562
description	display coffee machine L 150mm W 70mm		
For models:	Classe10		



1

GEV No.	402186	Ref. No.	10700975
description	display L 57mm W 94mm		
For models:	Classe8		





1

GEV No.	402184	Ref. No.	10705340
description	keypad unit L 102mm W 80mm mounting pos. 95x58 buttons 5		
For models:	Classe10		



1

GEV No.	400897	Ref. No.	65227059
description	display PCB dishwasher GS 60		
accessories for	400897		
	GEV No.	Ref. No.	—
	ribbon cable 10-pole L 3000mm plug type coded 2 row plug: number of poles 10		



1

GEV No.	402185	Ref. No.	10705368 10705414
description	keypad unit L 165mm W 49mm buttons 1		
For models:	Classe6, Classe8		



1

GEV No.	402188	Ref. No.	10111042
description	keypad unit 50 tablets of 60g coffee machine L 34mm W 72mm suitable for RANCILIO programme buttons 4		
For models:	Classe10		



1

GEV No.	402187	Ref. No.	10705369
description	keypad unit L 62mm W 40mm buttons 1		
For models:	Classe6, Classe8		

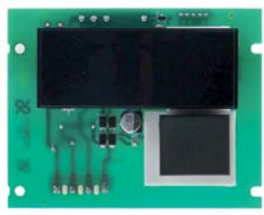

1

GEV No.	402183	Ref. No.	10705387
description	keypad unit L 102mm W 80mm mounting pos. 95x58		
For models:	Classe10		



1

GEV No.	402182	Ref. No.	10705364
description	keypad unit L 80mm W 102mm mounting pos. 95x58 buttons 3		
For models:	Classe10		



1

GEV No.	402181	Ref. No.	10705348
description	keypad unit L 81mm W 102mm mounting pos. 95x58 buttons 5		
For models:	Classe10		

1

GEV No.	400518	Ref. No.	34070161
description	PCB		
For models:	Millenium, S20, S20NSF, Z11		



1

GEV No.	400519	Ref. No.	34070165
description	PCB		
For models:	S20, S20NSF		



1

GEV No.	400526	Ref. No.	34070112
description	PCB		
For models:	Millenium, Z11		



1

GEV No.	400528	Ref. No.	34070173
description	PCB		



1

GEV No.	401454	Ref. No.	10700972
description	PCB		
For models:	Classe8, Epoca2gr		



1

GEV No.	401878	Ref. No.	10700980
description	PCB		
For models:	Classe10		



1

GEV No.	401879	Ref. No.	10700971 10700977
description	PCB		
For models:	Classe6, Epoca1gr, Epoca2gr		



1

GEV No.	401880	Ref. No.	10700979
description	PCB		
For models:	Classe10		



1

GEV No.	401881	Ref. No.	10700978
description	PCB		
For models:	Classe8		

1

GEV No.	401900	Ref. No.	65215029
description	PCB L 120mm W 80mm		







1

GEV No.	401882	Ref. No.	34070171 34070211
description	PCB level		
For models:	Classe10, Classe6, Classe8, Epoca2gr		



1

GEV No.	400899	Ref. No.	65215023	
description	power PCB dishwasher LP10/20/30 without EPROM			
accessories for	400899			
	GEV No.	400761	Ref. No.	—
	plug connector 5-pole			
	GEV No.	400900	Ref. No.	65225029
	EPROM CODE 225029-3			
	GEV No.	401558	Ref. No.	—
	EPROM CODE 81000-1			
	GEV No.	403241	Ref. No.	—
	EPROM type U61E for dishwasher CODE 81001-3			
	GEV No.	550048	Ref. No.	—
	female bullet			

central units



1

GEV No.	401876	Ref. No.	34070063
description	control box		
For models:	Classe8		

keypads

keypad units



1

GEV No.	400480	Ref. No.	10111031
description	keypad foil EPOCA CD		
For models:	Epoca1gr, Epoca2gr		



1

GEV No.	400482	Ref. No.	10705231
description	keypad unit		
For models:	Millenium		



1

GEV No.	400507	Ref. No.	100111025 10111025
description	keypad unit		
For models:	Z11		



1

GEV No.	400517	Ref. No.	10705235
description	keypad unit		
For models:	Millenium		





1

GEV No.	402174	Ref. No.	10705367
description	keypad unit buttons 5 black suitable for coffee machine L 170mm W 32mm		
For models:	Classe6, Classe8		



			
1			
GEV No.	400477	Ref. No.	10705222 10705226 1070522610
description	keypad unit buttons 5 L 122mm W 40mm connection		
For models:	S20, S20NSF, Z11		

			
1			
GEV No.	402190	Ref. No.	10705366
description	keypad unit coffee machine buttons 1 suitable for RANCILIO L 62mm W 40mm		
For models:	Classe6, Classe8		

			
1			
GEV No.	402428	Ref. No.	10111035 10111036
description	push switch coffee machine EPOCA CD type L42A8 250V 2NO L 110mm W 55mm		
For models:	Epoca1gr, Epoca2gr		

solenoid valves

solenoid valves (water)

			
1			
GEV No.	370246	Ref. No.	65240010
description	solenoid valve double straight 230VAC inlet 3/4" outlet 11.5mm t.max. 90°C ELBI plastic output B 0.5l/min flow regulating valve outlet B red		













				
1				
GEV No.	370021	Ref. No.	34040021	
description	solenoid valve double straight 230VAC inlet 3/4" outlet 11.5mm DN10 TP flow regulating valve inlet white			
spare parts for	370021			
	GEV No.	371013	Ref. No.	—
solenoid coil TP 230VAC 50/60Hz				
accessories for	370021			
	GEV No.	371220	Ref. No.	—
reducer TP flow rate 3l/min red tolerance ±15%				
	GEV No.	371221	Ref. No.	—
reducer TP flow rate 5.5l/min yellow tolerance ±15%				
	GEV No.	371222	Ref. No.	—
reducer TP flow rate 6l/min grey tolerance ±15%				
	GEV No.	371223	Ref. No.	—
reducer TP flow rate 10l/min white tolerance ±15%				
	GEV No.	371224	Ref. No.	—
reducer TP flow rate 12l/min bronze tolerance ±15%				
	GEV No.	371225	Ref. No.	—
reducer TP flow rate 16l/min light brown tolerance ±15%				
	GEV No.	371226	Ref. No.	—
reducer TP flow rate 20l/min red tolerance ±15%				
	GEV No.	371230	Ref. No.	—
reducer TP flow rate 0.25l/min red tolerance ±25%				
	GEV No.	371231	Ref. No.	—
reducer TP flow rate 0.35l/min violet tolerance ±25%				
	GEV No.	371232	Ref. No.	—
reducer TP flow rate 0.5l/min orange tolerance ±25%				
	GEV No.	371233	Ref. No.	—
reducer TP flow rate 0.8l/min white tolerance ±25%				
	GEV No.	371234	Ref. No.	—
reducer TP flow rate 1l/min light blue tolerance ±25%				
	GEV No.	371235	Ref. No.	—
reducer TP flow rate 1.2l/min brown tolerance ±25%				
	GEV No.	371236	Ref. No.	—
reducer TP flow rate 1.5l/min light brown tolerance ±25%				

Table continues overleaf

accessories for 370021				
	GEV No.	371237	Ref. No.	—
reducer TP flow rate 2.5l/min yellow tolerance ±25%				
	GEV No.	371238	Ref. No.	—
reducer TP flow rate 3.4l/min dark green tolerance ±25%				
	GEV No.	371239	Ref. No.	—
reducer TP flow rate 5l/min black tolerance ±25%				
	GEV No.	371240	Ref. No.	—
reducer TP flow rate 8l/min blue tolerance ±20%				

  1				
GEV No.	370017	Ref. No.	34040022 65240011	
description	solenoid valve single straight 230VAC inlet 3/4" outlet 11.5mm DN10 TP p max 10bar			
spare parts for 370017				
	GEV No.	371013	Ref. No.	—
solenoid coil TP 230VAC 50/60Hz				
accessories for 370017				
	GEV No.	371220	Ref. No.	—
reducer TP flow rate 3l/min red tolerance ±15%				
	GEV No.	371221	Ref. No.	—
reducer TP flow rate 5.5l/min yellow tolerance ±15%				
	GEV No.	371222	Ref. No.	—
reducer TP flow rate 6l/min grey tolerance ±15%				
	GEV No.	371223	Ref. No.	—
reducer TP flow rate 10l/min white tolerance ±15%				
	GEV No.	371224	Ref. No.	—
reducer TP flow rate 12l/min bronze tolerance ±15%				
	GEV No.	371225	Ref. No.	—
reducer TP flow rate 16l/min light brown tolerance ±15%				
	GEV No.	371226	Ref. No.	—
reducer TP flow rate 20l/min red tolerance ±15%				
	GEV No.	371230	Ref. No.	—
reducer TP flow rate 0.25l/min red tolerance ±25%				
	GEV No.	371231	Ref. No.	—
reducer TP flow rate 0.35l/min violet tolerance ±25%				
	GEV No.	371232	Ref. No.	—
reducer TP flow rate 0.5l/min orange tolerance ±25%				

accessories for 370017				
	GEV No.	371233	Ref. No.	—
reducer TP flow rate 0.8l/min white tolerance ±25%				
	GEV No.	371234	Ref. No.	—
reducer TP flow rate 1l/min light blue tolerance ±25%				
	GEV No.	371235	Ref. No.	—
reducer TP flow rate 1.2l/min brown tolerance ±25%				
	GEV No.	371236	Ref. No.	—
reducer TP flow rate 1.5l/min light brown tolerance ±25%				
	GEV No.	371237	Ref. No.	—
reducer TP flow rate 2.5l/min yellow tolerance ±25%				
	GEV No.	371238	Ref. No.	—
reducer TP flow rate 3.4l/min dark green tolerance ±25%				
	GEV No.	371239	Ref. No.	—
reducer TP flow rate 5l/min black tolerance ±25%				
	GEV No.	371240	Ref. No.	—
reducer TP flow rate 8l/min blue tolerance ±20%				













  1				
GEV No.	370025	Ref. No.	34040020	
description	solenoid valve triple straight 230VAC inlet 3/4" outlet 11.5mm DN10 TP			
spare parts for 370025				
	GEV No.	371013	Ref. No.	—
solenoid coil TP 230VAC 50/60Hz				
accessories for 370025				
	GEV No.	371220	Ref. No.	—
reducer TP flow rate 3l/min red tolerance ±15%				
	GEV No.	371221	Ref. No.	—
reducer TP flow rate 5.5l/min yellow tolerance ±15%				
	GEV No.	371222	Ref. No.	—
reducer TP flow rate 6l/min grey tolerance ±15%				
	GEV No.	371223	Ref. No.	—
reducer TP flow rate 10l/min white tolerance ±15%				
	GEV No.	371224	Ref. No.	—
reducer TP flow rate 12l/min bronze tolerance ±15%				
	GEV No.	371225	Ref. No.	—
reducer TP flow rate 16l/min light brown tolerance ±15%				

Table continues overleaf









accessories for		370025	
	GEV No.	371226	Ref. No. —
reducer TP flow rate 20l/min red tolerance ±15%			
	GEV No.	371230	Ref. No. —
reducer TP flow rate 0.25l/min red tolerance ±25%			
	GEV No.	371231	Ref. No. —
reducer TP flow rate 0.35l/min violet tolerance ±25%			
	GEV No.	371232	Ref. No. —
reducer TP flow rate 0.5l/min orange tolerance ±25%			
	GEV No.	371233	Ref. No. —
reducer TP flow rate 0.8l/min white tolerance ±25%			
	GEV No.	371234	Ref. No. —
reducer TP flow rate 1l/min light blue tolerance ±25%			
	GEV No.	371235	Ref. No. —
reducer TP flow rate 1.2l/min brown tolerance ±25%			
	GEV No.	371236	Ref. No. —
reducer TP flow rate 1.5l/min light brown tolerance ±25%			
	GEV No.	371237	Ref. No. —
reducer TP flow rate 2.5l/min yellow tolerance ±25%			
	GEV No.	371238	Ref. No. —
reducer TP flow rate 3.4l/min dark green tolerance ±25%			
	GEV No.	371239	Ref. No. —
reducer TP flow rate 5l/min black tolerance ±25%			
	GEV No.	371240	Ref. No. —
reducer TP flow rate 8l/min blue tolerance ±20%			

solenoid valves with reducers			
	1		
GEV No.	370437	Ref. No.	68023010 68023502
description	solenoid valve double angled 230VAC inlet 3/4" input 10l/min output 1.2/1.2l/min DN10 t.max. 90°C TP plastic flow regulating valve inlet white outlet 11.5mm output A 1.2l/min output B 1.2l/min flow regulating valve outlet A dark brown flow regulating valve outlet B dark brown		

	1		
GEV No.	370427	Ref. No.	68023001
description	solenoid valve single angled 230VAC inlet 3/4" outlet 11.5mm input/min output 1.2l/min DN10 t.max. 90°C TP plastic flow regulating valve outlet dark brown		

metal			
LUCIFER			
3-way			
131F series			
	1		
GEV No.	370053	Ref. No.	34040008
description	solenoid valve 3-ways 230VAC DN 2.5mm slide-on receptacle DIN -10 up to 140°C type series 131F coil type DZ06S6 membranes FKM (water/steam) p max 10bar flange 32x32mm		
For models:	Epoca1gr, Millenium, S20, Z11		
spare parts for	370053		
	GEV No.	370061	Ref. No. —
solenoid valve body LUCIFER-PARKER 3-ways outer cone			
	GEV No.	371031	Ref. No. 34049053
solenoid coil LUCIFER-PARKER 230VAC 9VA coil type DZ06S6 seat ø 15mm			
accessories for	370053		
	GEV No.	371090	Ref. No. —
power socket plug type DIN 43650A screw			
	GEV No.	371095	Ref. No. —
O-ring Viton thickness 1.78mm ID ø 6.07mm Qty 1 pcs			
	GEV No.	371100	Ref. No. —
O-ring silicone thickness 1.78mm ID ø 6.07mm Qty 1 pcs			

			
1			
GEV No.	370051	Ref. No.	34040024 alternative
description	solenoid valve 3-ways 24VDC DN 2.5mm slide-on receptacle DIN -10 up to 140°C LUCIFER-PARKER type series 131F coil type DZ02C2 membranes FKM (water/steam) p max 10bar flange 32x32mm		
spare parts for	370051		
	GEV No.	370061	Ref. No. —
solenoid valve body LUCIFER-PARKER 3-ways outer cone			
	GEV No.	371043	Ref. No. —
solenoid coil LUCIFER-PARKER 24VDC 9VA coil type DZ02C2 seat ø 14.5mm			
accessories for	370051		
	GEV No.	371090	Ref. No. —
power socket plug type DIN 43650A screw			
	GEV No.	371095	Ref. No. —
O-ring Viton thickness 1.78mm ID ø 6.07mm Qty 1 pcs			
	GEV No.	371100	Ref. No. —
O-ring silicone thickness 1.78mm ID ø 6.07mm Qty 1 pcs			

spare parts and accessories



solenoid coils



			
1			
GEV No.	371031	Ref. No.	34049053
description	solenoid coil LUCIFER-PARKER 230VAC 9VA coil type DZ06S6 seat ø 15mm		

PARKER



2-way



VE-125 series

			
1			
GEV No.	370202	Ref. No.	34040104
description	solenoid valve 2-ways 230VAC connection DN 2.5mm slide-on receptacle DIN -20° up to 130°C PARKER type series VE-125 coil type ZB09 membranes FKM (water) p max 10bar flange 32x32mm		
spare parts for	370202		
	GEV No.	371029	Ref. No. —
solenoid coil PARKER 230VAC 9VA coil type ZB09 seat ø 14mm H 33mm W 34mm D 43mm			

accessories for	370202		
	GEV No.	371090	Ref. No. —
power socket plug type DIN 43650A screw			
	GEV No.	532553	Ref. No. —
O-ring silicone thickness 1.5mm ID ø 13.15mm Qty 1 pcs			
	GEV No.	532554	Ref. No. —
O-ring silicone thickness 1.5mm ID ø 4.1mm Qty 1 pcs			

E-146 series

			
1			
GEV No.	370206	Ref. No.	10060412 10060486 10060500
description	solenoid valve 2-ways 230VAC connection 1/8" L 40mm DN 2.5mm slide-on receptacle DIN -20° up to 130°C PARKER type series VE-146 coil type ZB09 membranes FKM (water) p max 15bar p min 0bar		
For models:	Classe10, Classe6, Classe8, Epoca1gr, Epoca2gr, Millenium, S20, Z11		
spare parts for	370206		
	GEV No.	371029	Ref. No. —
solenoid coil PARKER 230VAC 9VA coil type ZB09 seat ø 14mm H 33mm W 34mm D 43mm			
accessories for	370206		
	GEV No.	371090	Ref. No. —
power socket plug type DIN 43650A screw			

			
1			
GEV No.	370218	Ref. No.	10060466
description	solenoid valve 2-ways 24VDC connection 1/8" DN 2.5mm slide-on receptacle DIN -20° up to 130°C PARKER type series VE-146 coil type ZB12 membranes FKM (water) p max 12bar		
For models:	Classe10, Classe8, Epoca2gr		
spare parts for	370218		
	GEV No.	371030	Ref. No. —
solenoid coil 24VDC 12VA coil type ZB12 seat ø 14mm			
accessories for	370218		
	GEV No.	371090	Ref. No. —
power socket plug type DIN 43650A screw			



3-way			
VE-128 series			
 <p>1</p>			
GEV No.	370057	Ref. No.	3404008
description	solenoid valve 3-ways 230VAC body outer cone DN 1.2mm slide-on receptacle DIN -20° up to 140°C PARKER type series VE-128 coil type ZB09 membranes ruby p max 10bar brass flange 32x32mm		
spare parts for	370057		
	GEV No.	370062	Ref. No. —
solenoid valve body PARKER 3-ways outer cone			
	GEV No.	371029	Ref. No. —
solenoid coil PARKER 230VAC 9VA coil type ZB09 seat ø 14mm H 33mm W 34mm D 43mm			
accessories for	370057		
	GEV No.	371090	Ref. No. —
power socket plug type DIN 43650A screw			
	GEV No.	371095	Ref. No. —
O-ring Viton thickness 1.78mm ID ø 6.07mm Qty 1 pcs			
	GEV No.	371100	Ref. No. —
O-ring silicone thickness 1.78mm ID ø 6.07mm Qty 1 pcs			
 <p>1</p>			
GEV No.	370058	Ref. No.	34040024
description	solenoid valve 3-ways 24VDC body outer cone DN 1.2mm slide-on receptacle DIN -20° up to 140°C PARKER type series VE-128 coil type ZB12 membranes ruby p max 10bar		
spare parts for	370058		
	GEV No.	370062	Ref. No. —
solenoid valve body PARKER 3-ways outer cone			
	GEV No.	371030	Ref. No. —
solenoid coil 24VDC 12VA coil type ZB12 seat ø 14mm			
accessories for	370058		
	GEV No.	371090	Ref. No. —
power socket plug type DIN 43650A screw			
	GEV No.	371095	Ref. No. —
O-ring Viton thickness 1.78mm ID ø 6.07mm Qty 1 pcs			
	GEV No.	371100	Ref. No. —
O-ring silicone thickness 1.78mm ID ø 6.07mm Qty 1 pcs			

pressure switches

for warewashing

ø 58mm with male faston 6.3mm

with connection horizontal

 <p>1</p>			
GEV No.	541326	Ref. No.	34200061
description	pressure control pre-adjusted pressure range 56/25mbar connection 6mm ø 58mm pressure connection horizontal warewashing pressure connection ø 6mm		
For models:	Epoca1 gr, S20		
 <p>1</p>			
GEV No.	541327	Ref. No.	34200064
description	pressure control pre-adjusted pressure range 56/25mbar connection male faston 6.3mm ø 58mm pressure connection horizontal warewashing pressure connection ø 6mm		
 <p>1</p>			
GEV No.	541328	Ref. No.	34200063
description	pressure control pre-adjusted pressure range 56/25mbar connection male faston 6.3mm ø 58mm pressure connection horizontal warewashing pressure connection ø 6mm		
 <p>1</p>			
GEV No.	541002	Ref. No.	65224002
description	pressure control pressure range 110/60mbar connection 6mm ø 58mm pressure connection horizontal warewashing pressure connection ø 6mm		

1

GEV No.	541011	Ref. No.	65224010
description	pressure control pressure range 110/70mbar connection 6mm ø 58mm pressure connection horizontal warewashing		



1

GEV No.	541001	Ref. No.	65224004
description	pressure control pressure range 35/17mbar connection 6mm ø 58mm pressure connection horizontal warewashing		



1

GEV No.	541003	Ref. No.	65224003
description	pressure control pressure range 55/35mbar connection 6mm ø 58mm pressure connection horizontal warewashing pressure connection ø 6mm		

accessories



1

GEV No.	541109	Ref. No.	65035031
description	Y-piece plastic hose ø 8-6-8mm for pressure switch		

for coffee machines

ø 35mm





1

GEV No.	541676	Ref. No.	34200288
description	pressure control ø 35mm pressure range 0-4bar 0.5-3.5V connection 3/8" pressure connection 3/8"		
For models:	Classe10, Classe6, Classe8, Epoca1gr, Epoca2gr		

miscellaneous



1

GEV No.	541021	Ref. No.	34200110	
description	pressure control pressure range adjustable 0.5-1.4bar connection 1/4" 30A 3-pole type P302 coffee machine parts SIRAI			
For models:	Classe6, Millenium, S20, Z11			
accessories for	541021			
	GEV No.	550262	Ref. No.	—
	flat gasket copper ED ø 20mm ID ø 14mm thickness 2mm			
	GEV No.	890100	Ref. No.	—
	PTFE tape reel L 12m W 12mm -200 up to +260°C approval DIN-DVGW, KTW temperature-resistant, elastic for fine thread thickness 0.1mm			

electrodes



1

GEV No.	400020	Ref. No.	10202204
description	level electrode 1/4" total length 150mm probe L 124mm insulated probe length 26mm connection male faston 6.3mm stainless steel ø 2.5mm		
For models:	Classe6, Epoca1gr, Millenium, S20, S20NSF, Z11		



1

GEV No.	401883	Ref. No.	34200088
description	level electrode 1/8" total length 115mm probe L 100mm insulated probe length 26mm connection male faston 6.3mm stainless steel ø 2.5mm		
For models:	Classe10, Classe6, Epoca1gr, Epoca2gr		



flow meters and flow sensors

flow meters

GICAR



GEV No.	401920	Ref. No.	34070050
description	flow meter thread 1/4" stainless steel with LED male faston 2.8mm approval NSF		
For models:	Classe10, Classe6, Classe8, Epoca1gr, Epoca2gr		
accessories for	401920		
	GEV No.	400222	Ref. No. —
	flow meter thread 1/4" stainless steel male faston 2.8mm approval NSF		
	GEV No.	520161	Ref. No. —
	double nipple nickel-plated brass thread 1/8" - 1/4" Qty 1 pcs		
	GEV No.	520163	Ref. No. —
	double nipple nickel-plated brass thread 1/4" - 1/4" Qty 1 pcs		
	GEV No.	529361	Ref. No. —
	flat gasket copper ED ø 18mm ID ø 13.5mm thickness 1.5mm for thread 1/4"		

miscellaneous



GEV No.	402680	Ref. No.	65240998
description	flow meter pressure range 0.2-10bar connection 10mm L 69mm		

compressors

CUBIGEL

accessories

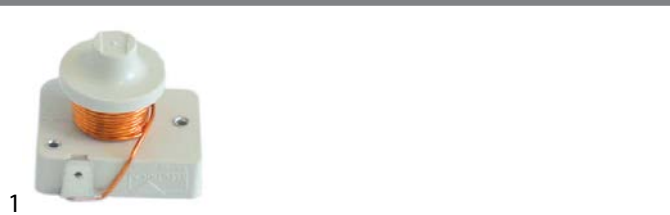

GEV No.	380461	Ref. No.	34020105
description	start relay MTRP H 4920 250V 8A 1NO		
For models:	MD		



GEV No.	380887	Ref. No.	34020112
description	start relay MTRP0017 250V 8A		
For models:	MD, Rocky		



GEV No.	380886	Ref. No.	34020114
description	start relay MTRP0026 250V voltage AC 8A 1NO		
For models:	MD		



GEV No.	380894	Ref. No.	34020113
description	start relay MTRP0048 115V		
For models:	MD		



GEV No.	380460	Ref. No.	34020109
description	start relay MTRP4211 250V 8A		
For models:	MD		

→ electric components



fans

refrigeration fans

refrigeration motors universal

accessories

fan wheels

aluminium



1

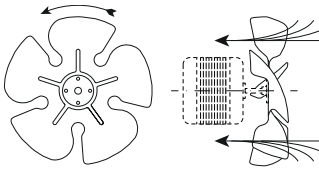

GEV No.	601387	Ref. No.	68020031
description	fan wheel sucking ø 254mm fan wheel mounting 25.4mm blade angle 34° W 50mm aluminium		

motors

motors

for coffee grinders

complete



1

GEV No.	500242	Ref. No.	14000022 34014022
description	motor 200W 230V 50/60Hz 1 phase shaft ø 14mm shaft length 35mm 1400rpm type MC125/55 ø 130mm H 190mm capacitor 25µF ELETTRMECANICA 0.2kW		
For models:	MD		



1

GEV No.	500243	Ref. No.	34014002
description	motor 230V 50Hz 1 phase shaft ø 17mm shaft length 45mm 1420rpm type MD.80/MC4 ø 150mm H 220mm capacitor 35µF ELETTRMECANICA		
For models:	MD		

pumps



wash and rinse pumps

FIR

pumps







1

GEV No.	500020	Ref. No.	34013226
description	pump inlet ø 32mm outlet ø 32mm type 4134.1402 230V 50Hz 1 phase 0.18kW 0.25HP L 180mm rotation direction right capacitor 10µF FIR		
spare parts for	500020		
	GEV No.	510506	Ref. No.
			—
	pump cover pump type 4333/1265		
accessories for	500020		
	GEV No.	504329	Ref. No.
			—
	blind plug H 17.5mm thread M16x1.5 plastic WS 22 for pump		



1

GEV No.	500017	Ref. No.	34013304
description	pump inlet ø 45mm outlet ø 40mm type 1219.1405 230V 50Hz 1 phase 0.73kW 1HP L 300mm rotation direction right capacitor 12.5µF FIR		
spare parts for	500017		
	GEV No.	365014	Ref. No. —
	operating capacitor capacity 12.5µF 450V tolerance 5%Hz ambient temperature max. -25 to +85°C ø 35mm L 70mm M8 plastic connection male faston 6.3mm 45S.C3DS.12.5 protection		
	GEV No.	510600	Ref. No. —
	impellor ø 102mm H 29mm shaft intake ø 9/8mm rotation direction right blades 6		
	GEV No.	510692	Ref. No. —
	mechanical shaft seal for shaft ø 11mm slide ring ext. ø 24mm slide ring H 13mm counter ring mounting ø 26mm height counter ring 8mm counter ring int. ø 14mm		
	GEV No.	521539	Ref. No. —
	pump cover FIR inlet ø 45mm outlet ø 40mm auxiliary pressure connection 10mm supporting pressure open turn direction right ø 160mm ID ø 125mm inner height 25mm		
	GEV No.	521702	Ref. No. 36222001
	pump cover gasket thickness 3.5x4.5mm Qty 1 pcs		







1

GEV No.	499134	Ref. No.	34013302
description	pump inlet ø 45mm outlet ø 40mm type 2282 230V 50Hz 0.37kW 0.5HP L 205mm rotation direction right capacitor 12.5µF auxiliary pressure connection 11mm supporting pressure open FIR		
spare parts for	499134		
	GEV No.	365014	Ref. No. —
	operating capacitor capacity 12.5µF 450V tolerance 5%Hz ambient temperature max. -25 to +85°C ø 35mm L 70mm M8 plastic connection male faston 6.3mm 45S.C3DS.12.5 protection		
	GEV No.	510607	Ref. No. —
	impellor ø 85mm H 29mm shaft intake ø 9x8mm rotation direction right blades 6		
	GEV No.	510692	Ref. No. —
	mechanical shaft seal for shaft ø 11mm slide ring ext. ø 24mm slide ring H 13mm counter ring mounting ø 26mm height counter ring 8mm counter ring int. ø 14mm		
	GEV No.	521539	Ref. No. —
	pump cover FIR inlet ø 45mm outlet ø 40mm auxiliary pressure connection 10mm supporting pressure open turn direction right ø 160mm ID ø 125mm inner height 25mm		
	GEV No.	521702	Ref. No. 36222001
	pump cover gasket thickness 3.5x4.5mm Qty 1 pcs		



1

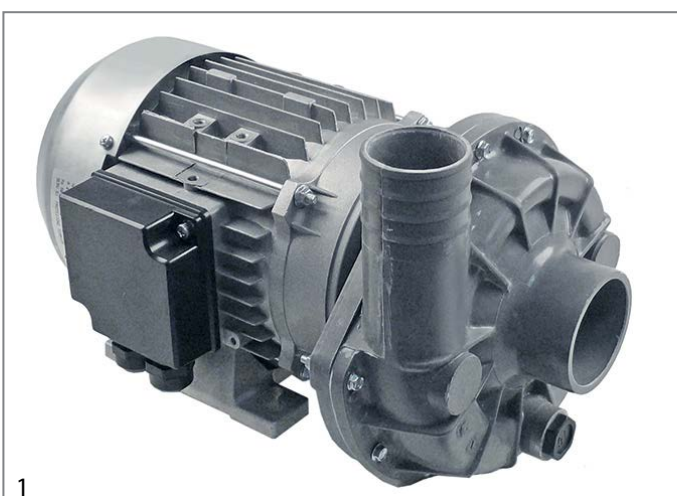

GEV No.	500155	Ref. No.	34013173
description	pump inlet ø 63mm outlet ø 47mm type 1225 230V 50Hz 1 phase 1.1kW 1.5HP L 335mm rotation direction right capacitor 31.5µF FIR		
spare parts for	500155		
	GEV No.	365016	Ref. No. —
	operating capacitor capacity 31.5µF 400V tolerance 5%Hz ambient temperature max. -25 to +85°C ø 45mm L 95mm M8 plastic connection male faston 6.3mm protection		
	GEV No.	510602	Ref. No. —
	impellor ø 110mm H 34mm rotation direction right thread M8L shaft ø 28mm seat ø 12.2mm blades 6		
	GEV No.	510693	Ref. No. 65141002
	mechanical shaft seal for shaft ø 12mm slide ring ext. ø 24mm slide ring H 15.5mm slide ring int. ø 11mm counter ring mounting ø 24mm height counter ring 8mm counter ring int. ø 13.5mm		
	GEV No.	521513	Ref. No. —
	pump cover FIR inlet ø 63mm outlet ø 47mm turn direction right ID ø 150mm inner height 32mm		
	GEV No.	524416	Ref. No. —
	pump cover gasket thickness 4x4mm Qty 1 pcs		



1





GEV No.	500023	Ref. No.	34013171
description	pump inlet ø 63mm outlet ø 47mm type 1225.2725 230/400V 50Hz 3 phase 1.1kW 1.5HP L 335mm rotation direction right FIR		
spare parts for	500023		
	GEV No.	510602	Ref. No. —
	impellor ø 110mm H 34mm rotation direction right thread M8L shaft ø 28mm seat ø 12.2mm blades 6		

spare parts for 500023

	GEV No.	510693	Ref. No.	65141002
	mechanical shaft seal for shaft ø 12mm slide ring ext. ø 24mm slide ring H 15.5mm slide ring int. ø 11mm counter ring mounting ø 24mm height counter ring 8mm counter ring int. ø 13.5mm			
	GEV No.	521513	Ref. No.	—
	pump cover FIR inlet ø 63mm outlet ø 47mm turn direction right ID ø 150mm inner height 32mm			
	GEV No.	524416	Ref. No.	—
	pump cover gasket thickness 4x4mm Qty 1 pcs			



1

GEV No.	500029	Ref. No.	34013170
description	pump inlet ø 63mm outlet ø 47mm type 1295.2503 230/400V 50Hz 3 phase 0.88kW 1.2HP L 305mm rotation direction right FIR		
spare parts for	500029		
	GEV No.	510693	Ref. No. 65141002
	mechanical shaft seal for shaft ø 12mm slide ring ext. ø 24mm slide ring H 15.5mm slide ring int. ø 11mm counter ring mounting ø 24mm height counter ring 8mm counter ring int. ø 13.5mm		
	GEV No.	521213	Ref. No. —
	impellor ø 117mm H 24mm M8L		
	GEV No.	521513	Ref. No. —
	pump cover FIR inlet ø 63mm outlet ø 47mm turn direction right ID ø 150mm inner height 32mm		
	GEV No.	524416	Ref. No. —
	pump cover gasket thickness 4x4mm Qty 1 pcs		



LGB







1

GEV No.	500979	Ref. No.	65130148
description	pump inlet \varnothing 28mm outlet \varnothing 26mm type ZFC1121DX 230V 50Hz 1 phase 0.25kW L 198mm rotation direction left capacitor 6.3 μ F LGB		
spare parts for	500979		
	GEV No.	365012	Ref. No. 65206009
	operating capacitor capacity 6.3 μ F 450V tolerance 5% 50Hz ambient temperature max. -25 to +85°C \varnothing 30mm L 61mm M8 plastic connection male faston 6.3mm protection		
	GEV No.	510703	Ref. No. 65141007
	mechanical shaft seal for shaft \varnothing 13mm slide ring H 13mm height counter ring 5.5mm ED \varnothing 26mm		
	GEV No.	521098	Ref. No. —
	pump cover LGB inlet \varnothing 28mm outlet \varnothing 26mm auxiliary pressure connection 12mm ID \varnothing 77mm		
	GEV No.	521099	Ref. No. —
	impellor \varnothing 72mm H 17mm thread M7R shaft \varnothing 13mm shaft length 12mm		
	GEV No.	528800	Ref. No. —
	O-ring EPDM thickness 2.62mm ID \varnothing 75.87mm Qty 1 pcs		







1



GEV No.	500553	Ref. No.	34013303
description	pump inlet \varnothing 45mm outlet \varnothing 38mm type ZF290SX 230V 50Hz 1 phase 0.65kW 0.88HP L 200mm rotation direction right capacitor 12.5 μ F auxiliary pressure connection 13mm supporting pressure open LGB		
spare parts for	500553		
	GEV No.	365014	Ref. No. —
	operating capacitor capacity 12.5 μ F 450V tolerance 5%Hz ambient temperature max. -25 to +85°C \varnothing 35mm L 70mm M8 plastic connection male faston 6.3mm 45S.C3DS.12.5 protection		
	GEV No.	510702	Ref. No. —
	mechanical shaft seal height counter ring 5.5mm ID \varnothing 12mm		
	GEV No.	521106	Ref. No. —
	impellor \varnothing 97mm H 24mm rotation direction right thread M8L seat \varnothing 8.2mm blades 5		
	GEV No.	521542	Ref. No. —
	pump cover LGB inlet \varnothing 45mm outlet \varnothing 40mm auxiliary pressure connection 13mm supporting pressure open \varnothing 150mm ID \varnothing 120mm inner high 25mm		
	GEV No.	521714	Ref. No. —
	pump cover gasket thickness 4x4mm Qty 1 pcs		



1			
GEV No.	500554	Ref. No.	34013302 934013302
description	pump inlet ø 45mm outlet ø 40mm type ZF290SX 230V 50Hz 1 phase 0.67kW 0.8HP L 200mm rotation direction right capacitor 12.5µF LGB		
spare parts for	500554		
	GEV No.	365014	Ref. No. —
	operating capacitor capacity 12.5µF 450V tolerance 5%Hz ambient temperature max. -25 to +85°C ø 35mm L 70mm M8 plastic connection male faston 6.3mm 45S.C3DS.12.5 protection		



1			
GEV No.	500156	Ref. No.	65130109
description	pump inlet ø 50mm outlet ø 50mm type ZF400SX 230V 50Hz 1 phase 0.6kW 0.8HP L 210mm rotation direction right capacitor 16µF LGB		
spare parts for	500156		
	GEV No.	509020	Ref. No. 65124031
	impellor ø 104mm H 25mm M8L		
	GEV No.	510703	Ref. No. 65141007
	mechanical shaft seal for shaft ø 13mm slide ring H 13mm height counter ring 5.5mm ED ø 26mm		
	GEV No.	521548	Ref. No. 65116019
	pump cover LGB inlet ø 50mm outlet ø 50mm		
	GEV No.	521734	Ref. No. —
	pump cover bottom part		

spare parts for	500156		
	GEV No.	523509	Ref. No. —
	deep-groove ball bearing type 6201-2RS shaft ø 12mm ED ø 32mm W 10mm with sealing discs deep-groove ball bearing DIN 625-1		
	GEV No.	532623	Ref. No. —
	O-ring EPDM thickness 2.62mm ID ø 120.32mm Qty 1 pcs		
accessories for	500156		
	GEV No.	365021	Ref. No. 34020016 34020022 65206004
	operating capacitor capacity 16µF 425V tolerance 5% 50/60Hz ambient temperature max. -25 to +85°C ø 35mm L 73mm single M8 plastic connection male faston 6.3mm 416.10.99 protection		



1			
GEV No.	500543	Ref. No.	65130126
description	pump inlet ø 50mm outlet ø 50mm type ZF400VSX 230V 50Hz 1 phase 0.85kW 1.2HP L 245mm rotation direction right capacitor 16µF LGB		
spare parts for	500543		
	GEV No.	365021	Ref. No. 34020016 34020022 65206004
	operating capacitor capacity 16µF 425V tolerance 5% 50/60Hz ambient temperature max. -25 to +85°C ø 35mm L 73mm single M8 plastic connection male faston 6.3mm 416.10.99 protection		
	GEV No.	509020	Ref. No. 65124031
	impellor ø 104mm H 25mm M8L		
	GEV No.	510703	Ref. No. 65141007
	mechanical shaft seal for shaft ø 13mm slide ring H 13mm height counter ring 5.5mm ED ø 26mm		
	GEV No.	521548	Ref. No. 65116019
	pump cover LGB inlet ø 50mm outlet ø 50mm		
	GEV No.	521734	Ref. No. —
	pump cover bottom part		
	GEV No.	532623	Ref. No. —
	O-ring EPDM thickness 2.62mm ID ø 120.32mm Qty 1 pcs		



1			
GEV No.	500361	Ref. No.	65080112
description	pump inlet ø 60mm outlet ø 49mm type ZF400SX 230V 50Hz 1 phase 0.8kW 1HP L 210mm rotation direction right capacitor 16µF LGB		
spare parts for	500361		
	GEV No.	Ref. No.	34020016 34020022 65206004
	operating capacitor capacity 16µF 425V tolerance 5% 50/60Hz ambient temperature max. -25 to +85°C ø 35mm L 73mm single M8 plastic connection male faston 6.3mm 416.10.99 protection		
	GEV No.	Ref. No.	509020
	impellor ø 104mm H 25mm M8L		
	GEV No.	Ref. No.	510703
	mechanical shaft seal for shaft ø 13mm slide ring H 13mm height counter ring 5.5mm ED ø 26mm		
	GEV No.	Ref. No.	521547
	pump cover LGB inlet ø 60mm outlet ø 50mm supporting pressure M8 turn direction right ø 160mm ID ø 127mm inner height 36mm		
	GEV No.	Ref. No.	532623
	O-ring EPDM thickness 2.62mm ID ø 120.32mm Qty 1 pcs		

spare parts for 500153			
	GEV No.	Ref. No.	510703
	mechanical shaft seal for shaft ø 13mm slide ring H 13mm height counter ring 5.5mm ED ø 26mm		
	GEV No.	Ref. No.	513267
	end cap for wash pump suitable for pump casing		
	GEV No.	Ref. No.	518177
	drain unit thread 3/4" ID ø 35mm hose ø 24mm		
	GEV No.	Ref. No.	518204
	screw connection for filter ø 67mm		
	GEV No.	Ref. No.	518205
	flat gasket rubber ED ø 61mm ID ø 47mm thickness 2mm Qty 1 pcs		
	GEV No.	Ref. No.	521147
	flange		
	GEV No.	Ref. No.	521221
	impellor ø 67mm H 16mm rotation direction right thread M7L shaft ø 13mm shaft length 12mm blades 8		
	GEV No.	Ref. No.	528800
	O-ring EPDM thickness 2.62mm ID ø 75.87mm Qty 1 pcs		







1			
GEV No.	500153	Ref. No.	65999134
description	pump inlet ø outlet ø type W180SX 230V 50Hz 1 phase 0.19kW 0.26HP L 220mm rotation direction right capacitor 5µF LGB		
spare parts for	500153		
	GEV No.	Ref. No.	365017
	operating capacitor capacity 5µF 450V tolerance 5% 50/60Hz ambient temperature max. -25 to +85°C ø 28mm L 54mm M8 plastic connection male faston 6.3mm 16.10.08 protection		



1			
GEV No.	500150	Ref. No.	65999135
description	pump inlet ø outlet ø type W210SX 230V 50Hz 1 phase 0.24kW 0.33HP L 230mm rotation direction right capacitor 6.3µF LGB		
spare parts for	500150		
	GEV No.	Ref. No.	365012
	operating capacitor capacity 6.3µF 450V tolerance 5% 50Hz ambient temperature max. -25 to +85°C ø 30mm L 61mm M8 plastic connection male faston 6.3mm protection		
	GEV No.	Ref. No.	509004
	impellor ø 71mm H 16mm M7L rotation direction right shaft ø 13mm shaft length 13mm blades 8		
	GEV No.	Ref. No.	510703
	mechanical shaft seal for shaft ø 13mm slide ring H 13mm height counter ring 5.5mm ED ø 26mm		
	GEV No.	Ref. No.	513267
	end cap for wash pump suitable for pump casing		
	GEV No.	Ref. No.	513275
	O-ring EPDM thickness 1.78mm ID ø 82.27mm Qty 1 pcs		

Table continues overleaf

spare parts for 500150			
	GEV No.	518177	Ref. No. 65111023
drain unit thread 3/4" ID ø 35mm hose ø 24mm			
	GEV No.	518204	Ref. No. 65429065
screw connection for filter ø 67mm			
	GEV No.	518205	Ref. No. 65437079
flat gasket rubber ED ø 61mm ID ø 47mm thickness 2mm Qty 1 pcs			
	GEV No.	521147	Ref. No. 65315024
flange			

booster pumps I

			
1	GEV No.	500358	Ref. No. 65130120
description pump inlet ø 3/8" outlet ø 3/8" type PS46 230V 50Hz 0.45kW ø 100mm L 200mm capacitor 10µF LGB			
spare parts for 500358			
	GEV No.	510713	Ref. No. —
slide ring for shaft ø 12mm ED ø 24mm H 16mm			
	GEV No.	510723	Ref. No. —
counter ring H 8mm ED ø 26mm ID ø 13.5mm for mechanical shaft seal			
	GEV No.	698400	Ref. No. —
pump cover gasket pump type PS46 thickness 2mm ID ø 66mm Qty 1 pcs			
accessories for 500358			
	GEV No.	365015	Ref. No. 34020003 65206002
operating capacitor capacity 10µF 400V tolerance 5%Hz ambient temperature max. -25 to +85°C ø 35.5mm L 59mm M8 plastic connection male faston 6.3mm protection			
	GEV No.	511279	Ref. No. —
hose connector brass straight thread 3/8" hose ø 12mm Qty 1 pcs			
	GEV No.	520202	Ref. No. —
hose connector nickel-plated brass straight thread 3/8" hose ø 12mm Qty 1 pcs			
	GEV No.	520677	Ref. No. —
hose connector brass straight thread 3/8" hose ø 13mm Qty 1 pcs			

drain pumps

ASKOLL



			
1	GEV No.	500210	Ref. No. 65130123
description drain pump 230V 40W			

			
1	GEV No.	500214	Ref. No. 65130105
description drain pump inlet ø 30mm outlet ø 22mm 230/240V 30W 50Hz ASKOLL type R113			

booster pumps II

pump heads

FLUID-O-TECH

			
1	GEV No.	500064	Ref. No. 69000266
description pump head PO204 FLUID-O-TECH L 82mm 200l/h connection 3/8" GAS with bypass brass clip connection for coffee machine shaft ø 4.8x11mm			
accessories for 500064			
	GEV No.	520126	Ref. No. —
clamp for pump/motor			

PROCON



1			
GEV No.	500230	Ref. No.	69000039
description	pump head V6105 PROCON L 82mm 180l/h connection 3/8" NPT with bypass brass clip connection for coffee machine shaft ø 4.8x11mm		
For models:	Millenium, S20, S20NSF		
accessories for	500230		
	GEV No.	Ref. No.	—
	520126		
	clamp for pump/motor		

accessories



1			
GEV No.	365015	Ref. No.	34020003 65206002
description	operating capacitor capacity 10µF 400V tolerance 5%Hz ambient temperature max. -25 to +85°C ø 35.5mm L 59mm M8 plastic connection male faston 6.3mm protection		



1			
GEV No.	365017	Ref. No.	65206010
description	operating capacitor capacity 5µF 450V tolerance 5% 50/60Hz ambient temperature max. -25 to +85°C ø 28mm L 54mm M8 plastic connection male faston 6.3mm 16.10.08 protection		



1			
GEV No.	365012	Ref. No.	65206009
description	operating capacitor capacity 6.3µF 450V tolerance 5% 50Hz ambient temperature max. -25 to +85°C ø 30mm L 61mm M8 plastic connection male faston 6.3mm protection		



pumps for ice machines

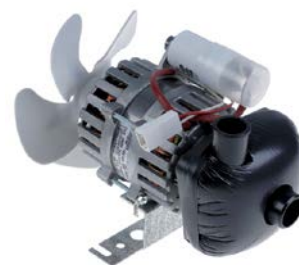

1			
GEV No.	500590	Ref. No.	68023377
description	pump FIR type 4240.2300 120W 230V 50/60Hz inlet ø 22mm outlet ø 22mm L 240mm rotation direction right for ice-cube maker capacitor 5µF		
spare parts for	500590		
	GEV No.	Ref. No.	—
	601412		
	fan wheel sucking ø 154mm fan wheel mounting 25.4mm blade angle 28° W 34mm plastic		
	GEV No.	Ref. No.	—
	601413		
	fixing plate suitable for fanwheel ED ø 32mm shaft ø 7 mounting distance 26mm		



1			
GEV No.	500165	Ref. No.	68023002
description	pump REBO type 63/35 120W 230V 50/60Hz inlet ø 28mm outlet ø 26mm L 180mm rotation direction right for ice-cube maker capacitor 5µF		
spare parts for	500165		
	GEV No.	Ref. No.	65206010
	365017		
	operating capacitor capacity 5µF 450V tolerance 5% 50/60Hz ambient temperature max. -25 to +85°C ø 28mm L 54mm M8 plastic connection male faston 6.3mm 16.10.08 protection		
	GEV No.	Ref. No.	—
	601412		
	fan wheel sucking ø 154mm fan wheel mounting 25.4mm blade angle 28° W 34mm plastic		
	GEV No.	Ref. No.	—
	601413		
	fixing plate suitable for fanwheel ED ø 32mm shaft ø 7 mounting distance 26mm		

			
1			
GEV No.	500161	Ref. No.	— 68023076
description	pump REBO type NR40 55W 230V 50Hz outlet ø 17mm L 110mm rotation direction left for ice-cube maker		
spare parts for	500161		
	GEV No.	Ref. No.	—
	 pump motor 55W 230V 50Hz REBO L 205mm type outlet ømm suitable for for ice maker		

			
1			
GEV No.	365022	Ref. No.	34020027
description	operating capacitor capacity 40µF 400V tolerance 5%Hz ambient temperature max. -25 to +85°C ø 45mm L 95mm M8 plastic connection male faston 6.3mm protection		
For models:	MD		

			
1			
GEV No.	365017	Ref. No.	65206010
description	operating capacitor capacity 5µF 450V tolerance 5% 50/60Hz ambient temperature max. -25 to +85°C ø 28mm L 54mm M8 plastic connection male faston 6.3mm 16.10.08 protection		

			
1			
GEV No.	365012	Ref. No.	65206009
description	operating capacitor capacity 6.3µF 450V tolerance 5% 50Hz ambient temperature max. -25 to +85°C ø 30mm L 61mm M8 plastic connection male faston 6.3mm protection		

fuses

fine fuses

			
1			
GEV No.	358669	Ref. No.	34200169
description	fine fuse size ø5x20mm 0.63A fast-acting rated 250V Qty 10 pcs		
For models:	S20, S20NSF, Z11		

			
1			
GEV No.	358677	Ref. No.	65228004
description	fine fuse size ø5x20mm 4A fast-acting rated 250V Qty 10 pcs		

condensators & interference suppression filters

operating capacitors

plastic

			
1			
GEV No.	365015	Ref. No.	34020003 65206002
description	operating capacitor capacity 10µF 400V tolerance 5%Hz ambient temperature max. -25 to +85°C ø 35.5mm L 59mm M8 plastic connection male faston 6.3mm protection		

			
1			
GEV No.	365021	Ref. No.	34020016 34020022 65206004
description	operating capacitor capacity 16µF 425V tolerance 5% 50/60Hz ambient temperature max. -25 to +85°C ø 35mm L 73mm single M8 plastic connection male faston 6.3mm 416.10.99 protection		
For models:	MD, Rocky		

			
1			
GEV No.	365105	Ref. No.	34020025
description	operating capacitor capacity 25µF 450V tolerance 5% 50/60Hz ambient temperature max. -25 to +85°C ø 40mm L 120mm M8 plastic connection male faston 6.3mm protection		
For models:	MD		



			
1			
GEV No.	358533	Ref. No.	34200167
description	fine fuse size ø5x20mm 6.3A fast-acting rated 250V Qty 10 pcs		
For models:	S20, S20NSF, Z11		

			
1			
GEV No.	358599	Ref. No.	34200170
description	fine fuse size ø5x20mm 0.8A slow-acting rated 250V Qty 10 pcs		
For models:	S20, S20NSF, Z11		

fine fuse holders			
			
1			
GEV No.	358011	Ref. No.	38123598
description	fuse holder suitable fuse ø5x20mm L 35mm W 23mm H 11mm		
For models:	Classe10, Classe6, Classe8, Epoca2gr		

electric accessories

cables

ribbon cables

group 1			
			
1			
GEV No.	400903	Ref. No.	65211009
description	ribbon cable 10-pole L 2290mm plug type FC-10P raster size 2.54mm		

			
1			
GEV No.	403035	Ref. No.	10110441
description	ribbon cable 26-pole L 1650mm plug type 2 row		
For models:	Classe10		

miscellaneous			
			
1			
GEV No.	401452	Ref. No.	10110476
description	kable set 3-piece		

			
1			
GEV No.	401453	Ref. No.	10110475
description	kable set 3-piece		

terminals

connection terminals with screw/faston connections

			
1			
GEV No.	550278	Ref. No.	34150023
description	power terminal block 3-pole max. 40A max 400V connection ø6mm ² / F6.3 temp.-resist. 150°C cross section 6mm ²		
For models:	Epoca1gr		

			
1			
GEV No.	550349	Ref. No.	65220010
description	power terminal block 4-pole max. 40A max 400V connection ø6mm ² / F6.3 temp.-resist. 150°C cross section 6mm ²		

			
1			
GEV No.	550411	Ref. No.	34150024 65220011
description	power terminal block 6-pole max. 40A max 450V connection ø6mm ² / F6.3 temp.-resist. 150°C cross section 6mm ²		
For models:	Classe10, Classe6, Classe8, Epoca2gr, Millenium		

connection boxes

			
1			
GEV No.	550300	Ref. No.	65459018
description	power terminal block 3-pole contacts P+N+E		



ignition parts

ignition switches



1

GEV No.	301014	Ref. No.	34030054
description	momentary rocker switch mounting measurements 30x11mm black 1NO 250V 16A connection male faston 6.3mm ambient temperature max. 85/125°C protection IP40 mounting ømm male faston 6.3mm		
For models:	Rocky		

equipment-specific units

for ice-cube maker

drain systems

overflow pipes



1

GEV No.	695083	Ref. No.	68013028
description	overflow pipe ID ø 22mm D1 ø 27mm D2 ø 19mm L 144mm		

curtains

with holder



1

GEV No.	695506	Ref. No.	68022034
description	curtain for ice maker W 328mm H 150mm with holder shaft length 325mm shaft ø 7.5mm		



1

GEV No.	696594	Ref. No.	68022106
description	curtain for ice-cube maker W 273mm H 160mm shaft length 280mm shaft ø 7.6mm holder length 316mm		

for espresso machines

filter holders

filter holders standard

filter holder without spout



1

GEV No.	525976	Ref. No.	N/A
description	filter holder suitable for BFC/ROYAL1/RANCILIO without outlet mounting ø 82mm outlet 3/8" ID ø 62mm wedge height 10mm wedge position horizontal number of wedges 2 lever straight		

filter holders long



1

GEV No.	529039	Ref. No.	20112011
description	filter holder mounting ø 81.6mm outlet 3/8" ID ø 61.5mm handle M8 wedge position horizontal number of wedges 2 chrome-plated brass		
For models:	Epoca1gr, S20, Z11		

handles

with bore



1

GEV No.	529277	Ref. No.	10060184 10705091
description	handle aperture 12x12mm black plastic L1 135mm		
For models:	Epoca1gr		



1

GEV No.	529036	Ref. No.	38123569
description	handle ø 35mm aperture 12x12mm L 120mm black		
For models:	Epoca1gr		





1

GEV No.	529038	Ref. No.	38121018
description	handle ø 35mm aperture 12x12mm L 120mm black plastic		
For models:	S20, S20NSF, Z11		

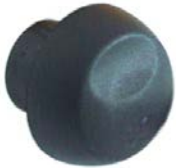

end caps			
			
1			
GEV No.	529035	Ref. No.	38123570 38123599 938123599
description	end cap black		
For models:	Epoca1gr		

			
1			
GEV No.	529037	Ref. No.	38121032
description	end cap black		
For models:	S20, S20NSF		

filter holders with manometer			
			
1			
GEV No.	800012	Ref. No.	10079000
description	filter holder with manometer ø 73mm mounting ø 81.6mm pressure range 0-16bar		

filters			
for 1 cup			
			
1			
GEV No.	527631	Ref. No.	N/A
description	coffee filter ø 70mm mounting ø 60.7mm H 17mm cups 1 amount of coffee 8g		

			
1			
GEV No.	529015	Ref. No.	N/A
description	coffee filter ø 70mm mounting ø 60.8mm H 20mm cups 1 amount of coffee 7g		

for 2 cups			
			
1			
GEV No.	529014	Ref. No.	40100010
description	coffee filter ø 70mm mounting ø 60mm H 21mm cups 2 amount of coffee 12g perforation ø 0.3mm round		
For models:	Epoca1gr, Millenium, S20, S20NSF, Silvia, Z11		

			
1			
GEV No.	529016	Ref. No.	N/A
description	coffee filter ø 70mm mounting ø 61mm H 22mm cups 2 amount of coffee 12g		

filter holder springs			
			
1			
GEV No.	531243	Ref. No.	N/A
description	filter holder spring L 70mm W 60mm wire gauge ø 1.3mm for espresso filter holder Qty 20 pcs		

brewing units			
shower screens			
with upstand and central hole			
			
1			
GEV No.	529085	Ref. No.	40200005
description	shower screen ø 57.5mm H 4mm hole ø 5mm		
For models:	Classe10, Epoca1gr, Millenium, S20, S20NSF, Silvia, Z11		

with upstand			
			
1			
GEV No.	529293	Ref. No.	40200030
description	shower screen ø 57mm H 6mm		
For models:	Classe6, Z11		

filter holder gaskets

flat

with external notch



1

GEV No.	528034	Ref. No.	36301001 36301046
description	filter holder gasket D1 ø 73.5mm D2 ø 57.5mm H 8mm with outside notch Qty 1 pcs		
For models:	Classe10, Classe6, Epoca1gr, Millenium, S20, Z11		

shim gaskets



1

GEV No.	531250	Ref. No.	—
description	shim gasket D1 ø 73mm D2 ø 59mm thickness 0.5mm paper Qty 20 pcs		

brewing units manual

components

gaskets

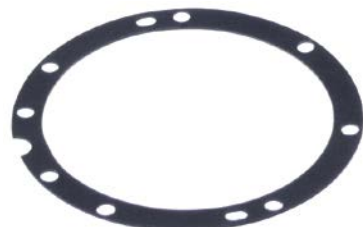

1

GEV No.	528199	Ref. No.	36206008
description	gasket D1 ø 126mm D2 ø 104mm thickness 1mm hole distance 118mm rubber		
For models:	Z11		



1

GEV No.	528228	Ref. No.	36206004
description	gasket D1 ø 32mm thickness 0.6mm mounting pos. right rubber		
For models:	Z11		



1

GEV No.	528212	Ref. No.	36206003
description	gasket D1 ø 32mm thickness 1mm mounting pos. left rubber		
For models:	Z11		



1

GEV No.	528196	Ref. No.	36101012
description	gasket ED ø 104mm ID ø 88.5mm H 8mm X-shape		
For models:	Z11		



1

GEV No.	528322	Ref. No.	36101003
description	gasket ED ø 19mm ID ø 11.5mm H 4mm for valve body		
For models:	Z11		



1

GEV No.	528285	Ref. No.	36101004
description	gasket ED ø 24mm ID ø 14mm H 5mm		
For models:	Z11		



1

GEV No.	528194	Ref. No.	36101005
description	gasket ED ø 50.5mm ID ø 35.5mm H 7.5mm X-shape		
For models:	Classe6, Z11		



			
1			
GEV No.	529292	Ref. No.	36101006
description	gasket ED ø 51mm W 7mm int. ø 1 37mm		
For models:	Classe6, Z11		

			
1			
GEV No.	528195	Ref. No.	36101007
description	gasket ED ø 54.5mm ID ø 39.5mm H 7.5mm X-shape		
For models:	Z11		

			
1			
GEV No.	529294	Ref. No.	36101008
description	gasket ED ø 55mm W 7mm int. ø 1 41mm		
For models:	Z11		

			
1			
GEV No.	528320	Ref. No.	36301009
description	gasket rubber ED ø 10mm ID ø 4mm thickness 2mm Qty 1 pcs suitable for for valve		
For models:	Z11		

miscellaneous			
			
1			
GEV No.	528397	Ref. No.	36130002
description	bolt PTFE L 21mm ED ø 8mm		
For models:	Classe6, Z11		

			
1			
GEV No.	528191	Ref. No.	20112501
description	cam		
For models:	Classe6, Z11		

			
1			
GEV No.	528730	Ref. No.	36230006
description	PTFE ring ø 12mm ID ø 9.5mm thickness 1mm		
For models:	Classe10, Z11		

			
1			
GEV No.	528720	Ref. No.	26128010
description	roller		
For models:	Classe10, Z11		

			
1			
GEV No.	528399	Ref. No.	38120007
description	stop bolt plastic L 16mm for lever ED ø 14mm		
For models:	Z11		

spring guides			
			
1			
GEV No.	528731	Ref. No.	23129008
description	spring guide		
For models:	Classe10, Z11		

springs



1

GEV No.	528114	Ref. No.	39120014
description	compression spring \varnothing 45mm L 185mm wire gauge \varnothing 7mm		
For models:	Classe6, Z11		

levers

lever handles



1

GEV No.	111255	Ref. No.	38123860
description	lever thread M8x1 \varnothing 32mm for coffee machine		
For models:	Classe10		

accessories



1

GEV No.	528717	Ref. No.	36901599
description	suppressor for lever \varnothing 17mm ID \varnothing 8mm L 28mm rubber		
For models:	Classe10, Z11		

components

drain units

spring guides



1

GEV No.	528736	Ref. No.	23139001
description	spring guide		
For models:	Classe10, Z11		

screw connections



1

GEV No.	527433	Ref. No.	10090002 10090018 38123077 910090002
description	drain connection thread 1/8" L 63mm plastic		
For models:	Epoca1gr, Millenium, S20, S20NSF, Silvia, Z11		

nozzles

with thread



1

GEV No.	528738	Ref. No.	10060507 10060603 10060612 23212018
description	nozzle		
For models:	Classe10, Z11		

screws



1

GEV No.	560373	Ref. No.	37030412
description	cylinder head bolt thread M4 thread L 12mm WS 3 SS Qty 1 pcs intake internal hexagon DIN 912/ISO 4762		
For models:	Millenium, S20, S20NSF, Silvia, Z11		

miscellaneous



1

GEV No.	528734	Ref. No.	23206008
description	nut		
For models:	Classe10, Z11		

water dispersions

water dispersions

group 2



1

GEV No.	529141	Ref. No.	25139001
description	water distributor \varnothing 21mm with central hole hole \varnothing 5.6mm H 6mm grooves 8 1mm stainless steel		
For models:	Classe10, Epoca1gr, Millenium, S20, S20NSF, Silvia, Z11		

group 3



1

GEV No.	528394	Ref. No.	20200181 20200182
description	water distributor \varnothing 56/58mm H 10mm 1 holes hole \varnothing 16mm brass		
For models:	Epoca1gr		

safety valves

safety valves

1/2"



1

GEV No. 529306 **Ref. No.** N/A

description safety valve connection 1/2" triggering pressure 1.8bar



1

GEV No. 529310 **Ref. No.** N/A

description safety valve connection 1/2" triggering pressure 1.8bar approval ISPEL sealed

expansion valves



1

GEV No. 529297 **Ref. No.** 10060460

description expansion valve T1: 3/8" ET T2: 1/4" ET L 29mm

For models: Classe10, Classe8, Millenium, S20, Z11

with hose connection



1

GEV No. 529296 **Ref. No.** 10060479

description expansion valve T1: 3/8" ET hose ø 8mm L 29mm

For models: Classe6, Classe8, Epoca2gr

gaskets



1

GEV No. 528289 **Ref. No.** 36301041

description gasket rubber D1 ø 11mm thickness 2mm for expansion valve Qty 1 pcs

For models: Epoca1gr

compression springs



1

GEV No. 528324 **Ref. No.** 39110040

description compression spring ø 11mm L 21mm wire gauge ø 1.5mm for expansion valve

For models: Epoca1gr, S20, S20NSF, Silvia, Z11



1

GEV No. 528703 **Ref. No.** 39110064
39110070

description compression spring ø 9.6mm L 26mm wire gauge ø 0.6mm

For models: Epoca1gr, S20, S20NSF, Z11

nozzles



1

GEV No. 528702 **Ref. No.** 23206001

description nozzle

For models: S20



1

GEV No. 528391 **Ref. No.** 23000057

description nozzle thread 1/4" WS 17 bore ø 0.7mm L 30mm

For models: Epoca1gr

brass 3-way



1

GEV No. 529282 **Ref. No.** 10060478

description expansion valve suitable for RANCILIO outlet 1/4" inlet 3/8"

For models: Classe6, Classe8, Epoca2gr

with non-return valve



1

GEV No. 529291 **Ref. No.** 10060476

description expansion valve with non-return valve

For models: Epoca1gr



1

GEV No.	529290	Ref. No.	10706067
description	expansion valve with non-return valve 2-way		
For models:	Classe10		



1

GEV No.	529343	Ref. No.	10706063
description	expansion valve with non-return valve 2-way		
For models:	Classe10, Millenium, S20, Z11		



1

GEV No.	529342	Ref. No.	10060471 10060480
description	expansion valve with non-return valve equiv. no. 10060480		
For models:	Z11		



1

GEV No.	529344	Ref. No.	10706064
description	expansion valve with non-return valve equiv. no. 10706064 3-way		
For models:	Classe10, S20, Z11		

drain pans

drain pans



1

GEV No.	528130	Ref. No.	38121007
description	drain pan connection 14mm connection for model B-C		
For models:	S20, Z11		



1

GEV No.	528105	Ref. No.	38123513
description	drain pan L 90mm W 90mm H 58mm hole ø 9mm connection 3/4"		
For models:	Classe10, Classe6, Millenium, S20, S20NSF		

aerators and air bleeders



1

GEV No.	529305	Ref. No.	10060050
description	aerator and air bleeder connection 3/8"		
For models:	Classe10, Classe6, Classe8, Epoca1gr, Millenium, S20, S20NSF, Z11		

boilers

gaskets

perforated



1

GEV No.	528124	Ref. No.	36930011
description	boiler gasket D1 ø 175mm D2 ø 124mm thickness 2mm 8 holes PTFE suitable for RANCILIO		
For models:	Classe10, Classe6, Classe8, Epoca2gr, Millenium, S20, Z11		





			
1			
GEV No.	528116	Ref. No.	3693001
description	boiler gasket D1 ø 177mm D2 ø 126mm thickness 2mm 8 holes graphite suitable for RANCILIO equiv. no. 3693001		

heat exchangers

injector tubes

			
1			
GEV No.	529287	Ref. No.	10042004 10042172
description	injector pipe boiler tube ø 8mm pipe length 121mm T1: 3/8" T2: 1/4" copper/brass		
For models:	Classe10, Classe6, Classe8, Epoca2gr, S20, Z11		

			
1			
GEV No.	529288	Ref. No.	10042173
description	injector pipe boiler tube ø 8mm pipe length 180mm T1: 3/8" T2: 1/4" brass		
For models:	Classe10, Classe6, Classe8, Epoca2gr		

			
1			
GEV No.	529286	Ref. No.	10042171
description	injector pipe boiler tube ø 8mm pipe length 69mm T1: 3/8" T2: 1/4" brass		
For models:	Classe10, Classe6, Classe8, Epoca2gr		

steam/water taps

steam/water taps

			
1			
GEV No.	529540	Ref. No.	10060114
description	steam/water tap		

			
1			
GEV No.	529276	Ref. No.	10060100
description	steam/water tap inlet 3/8" outlet 3/8" brass		
For models:	Millenium, S20, S20NSF, Z11		

steam taps

bushes

			
1			
GEV No.	528393	Ref. No.	23000006
description	bush D1 ø 14mm D2 ø 9mm ID ø 7.1mm H 6mm stainless steel for gasket		

steam taps (complete)

			
1			
GEV No.	529275	Ref. No.	10060101 10060104 10060134
description	steam tap mounting pos. left inlet 3/8" outlet 3/8" brass		

			
1			
GEV No.	529274	Ref. No.	10060102
description	steam tap mounting pos. right inlet 3/8" outlet 3/8" brass		

			
1			
GEV No.	524875	Ref. No.	10060106
description	steam tap mounting pos. right with non-return valve inlet 3/8" outlet 3/8" brass		

steam valves

			
1			
GEV No.	529271	Ref. No.	10706040 10706044 10706045
description	steam valve 1/2" L 75mm		
For models:	Millenium, S20NSF, Z11		

knobs



1

GEV No.	111252	Ref. No.	10060183
description	knob steam ø 52mm black		

components

shafts



1

GEV No.	529279	Ref. No.	10060002
description	shaft for coffee machine tap L 75mm		
For models:	S2ONSF		

bushes



1

GEV No.	528388	Ref. No.	25132003
description	bush for steam-/water-tap D1 ø 14mm D2 ø 12mm ID ø 9.5mm H 4.2mm stainless steel		
For models:	S20		

gasket supports



1

GEV No.	528722	Ref. No.	23216005
description	gasket support		
For models:	S2ONSF		



1

GEV No.	527437	Ref. No.	10060001
description	piston for tap ø 17.5mm L 12mm thread M6 stainless steel		
For models:	S20		

springs



1

GEV No.	528190	Ref. No.	39110035
description	compression spring ø 12mm L 30mm wire gauge ø 1mm		



1

GEV No.	528189	Ref. No.	39110036
description	compression spring ø 14mm L 18mm wire gauge ø 1mm		

flanges



1

GEV No.	528389	Ref. No.	20112601
description	flange mounting pos. left ø 32mm ID ø 19.5mm H 18mm hole distance 40mm hole ø 5mm for steam-/water-tap		



1

GEV No.	528390	Ref. No.	20112603
description	flange mounting pos. right ø 32mm ID ø 19.5mm H 18mm hole distance 40mm hole ø 5mm for steam-/water-tap		



1

GEV No.	530624	Ref. No.	10060005 links 10701240
description	flange set mounting pos. left for steam-/water-tap		

screw connections



1

GEV No.	527432	Ref. No.	23224002
description	screw connection for tap L 52mm ID ø 9mm WS 24 brass thread 1/2" - 16mm special		
For models:	S20		



			
1			
GEV No.	527436	Ref. No.	23220029
description	screw connection tap head L 25mm WS 20 brass thread M16 left		
For models:	S20		

water taps

knobs

			
1			
GEV No.	111167	Ref. No.	10060176
description	knob water ø 47mm shaft ø hexagon 20mm black		

			
1			
GEV No.	111251	Ref. No.	10060182 10060188
description	knob water ø 52mm shaft ø hexagon 20mm black		

steam/water pipes

steam pipes

			
1			
GEV No.	529542	Ref. No.	10706003 old version
description	steam pipe		

			
1			
GEV No.	529339	Ref. No.	10049046
description	steam pipe thread 1/4" L 130mm W 75mm tube ø 6mm SILVIA		
For models:	Silvia		

			
1			
GEV No.	529401	Ref. No.	10049016 10706024
description	steam pipe thread 3/8" L 170mm tube ø 10mm		

			
1			
GEV No.	529431	Ref. No.	10706017 10706024
description	steam pipe with thread		
For models:	Millenium, S20, S20NSF		

			
1			
GEV No.	529432	Ref. No.	10706018
description	steam pipe with thread		

			
1			
GEV No.	529437	Ref. No.	10706003
description	steam pipe with thread		
For models:	S20, Z11		

water pipes

			
1			
GEV No.	529430	Ref. No.	10049017
description	water pipe		

			
1			
GEV No.	529433	Ref. No.	10706009
description	water pipe		

			
1			
GEV No.	529463	Ref. No.	10706027
description	water pipe		



GEV No.	529464	Ref. No.	10049025
description	water pipe short		
For models:	Z11		

accessories

bushes



GEV No.	528342	Ref. No.	36930016
description	bush D1 ø 12mm D2 ø 7.8mm H 6.6mm plastic for steam pipe ID ø 6mm		



GEV No.	525058	Ref. No.	25119005
description	bush D1 ø 8.8mm D2 ø 12mm H 5.5mm SS ID ø 7mm		
For models:	S20, S20NSF, Z11		

gaskets



GEV No.	528198	Ref. No.	36930017
description	flat gasket PTFE ED ø 14.5mm ID ø 12mm thickness 1mm inner cone for steam pipe Qty 1 pcs H 3mm		



GEV No.	510893	Ref. No.	65456015
description	O-ring EPDM thickness 2.62mm ID ø 9.92mm Qty 1 pcs		

springs



GEV No.	528334	Ref. No.	39110038 939110038
description	compression spring ø 12.2mm L 11.6mm wire gauge ø 2.1mm for steam/water pipes		

fine filters



GEV No.	529284	Ref. No.	32910001
description	fine filter flat ø 9.5mm		
For models:	Epoca1gr		





GEV No.	528704	Ref. No.	10706070
description	fine filter with housing		
For models:	S20, Z11		



GEV No.	528724	Ref. No.	10705003
description	fine filter with housing		
For models:	Z11		

intake valves



GEV No.	529678	Ref. No.	10060290	
description	intake valve water equiv. no. 10060290 complete			
For models:	Classe10, Millenium, S20, S20NSF, Z11			
spare parts for	529678			
	GEV No.	528708	Ref. No.	37900110
	ball ø 9.5mm stainless steel			

accessories

gaskets



GEV No.	528712	Ref. No.	36101002
description	gasket ED ø 15mm ID ø 8mm H 4.5mm U-shape		
For models:	Classe10, Millenium, S20, S20NSF, Z11		



springs



1

GEV No.	529289	Ref. No.	39110008
description	spring ø 17mm L 25mm wire gauge ø 2.5mm		
For models:	S20NSF, Z11		

miscellaneous



1

GEV No.	528708	Ref. No.	37900110
description	ball ø 9.5mm stainless steel		
For models:	Classe10, Millenium, S20, S20NSF, Z11		

level glasses

level glasses

gaskets



1

GEV No.	529372	Ref. No.	36103002
description	gasket		
For models:	Millenium, Z11		

pressure rings



1

GEV No.	529374	Ref. No.	12131005 23131005
description	plain washer ID ø 13mm ED ø 17.8mm thickness 0.5mm brass Qty 1 pcs		
For models:	Millenium, Z11		

level glasses



1

GEV No.	528707	Ref. No.	38125007
description	level glass		
For models:	S20, S20NSF, Z11		

level glasses (complete)



1

GEV No.	529273	Ref. No.	10060380 10060382
description	water level tube L 190mm W 60mm thread 3/8"		
For models:	Classe6, Classe8, Epoca2gr, S20		

level glass pipes



1

GEV No.	529285	Ref. No.	38228066
description	water level tube ø 10mm H 107.5mm		
For models:	Classe10, Classe6, Classe8, Epoca2gr, S20		



1

GEV No.	528629	Ref. No.	41010010
description	water level tube ø 12mm H 140mm ID ø 9mm		
For models:	Millenium, S20NSF, Z11		

accessories for 528629



GEV No.	528344	Ref. No.	—
description	O-ring silicone thickness 2.62mm ID ø 12.37mm Qty 1 pcs		



GEV No.	528628	Ref. No.	—
description	washer ID ø 13.3mm ED ø 17mm thickness 0.5mm brass Qty 1 pcs water level glass		



GEV No.	528630	Ref. No.	—
description	ball ø 6.6mm plastic water level glass		



1

GEV No.	529371	Ref. No.	10060320
description	water level tube ø 12mm H 140mm ID ø 9mm		

non-return valves

compression springs



GEV No.	528193	Ref. No.	39110063
description	compression spring ø 8mm L 55mm wire gauge ø 0.7mm		
For models:	Classe10, Classe6, Classe8, Epoca2gr, S20, S20NSF		

complete



GEV No.	529283	Ref. No.	10705029
description	non-return valve suitable for RANCILIO thread 3/8" IT - 3/8" ET		
For models:	Classe10		

screw connections

miscellaneous



GEV No.	390313	Ref. No.	23214019
description	screw connection		
For models:	Millenium, S20		

for coffee grinders

grinding burrs

grinding burrs straight

standard



GEV No.	527229	Ref. No.	69000032
description	grinding burrs pair turn direction left D1 ø 50mm ID ø 31mm H 8mm tooth spacing 3mm hole ø 4.5mm bore ø 7.5mm mounting ø 40 suitable for RANCILIO, OBEL		
For models:	MD, Rocky		



GEV No.	527235	Ref. No.	69000033
description	grinding burrs pair turn direction left D1 ø 63.3mm ID ø 38mm H 9mm tooth spacing 3mm hole ø 5.5mm bore ø 8.5mm mounting ø 50 straight suitable for Auora, Eureka, Rancilio		
For models:	MD		



GEV No.	527236	Ref. No.	69000034
description	grinding burrs pair turn direction left D1 ø 75mm ID ø 43mm H 10.6mm tooth spacing 4mm hole ø 6.5mm bore ø 10mm mounting ø 57 straight suitable for RANCILIO		
For models:	MD		

grinding burrs holders



GEV No.	527266	Ref. No.	22104001
description	grinding burr holder type MD50 suitable for RANCILIO equip. no. 22104001		
For models:	MD		



GEV No.	527267	Ref. No.	22114801
description	grinding burr holder type MD80 suitable for RANCILIO equip. no. 22114801		

spillage trays



GEV No.	527440	Ref. No.	38120013
description	drain tray L 125mm W 64mm for coffee grinder suitable for MD50		
For models:	MD		

miscellaneous



GEV No.	692092	Ref. No.	36310009
description	equipment foot self-adhesive ø 18mm H 10mm Qty 1 pcs for coffee grinder		
For models:	Rocky		

dosing containers

dosing container lids



1

GEV No.	527439	Ref. No.	38123033
description	lid for dosing container ø 110.5mm suitable for ROCKY		
For models:	Rocky		



1

GEV No.	527450	Ref. No.	38123034
description	lid for dosing container ø 111mm suitable for ROCKY		
For models:	Rocky		



1

GEV No.	527352	Ref. No.	38120024
description	lid for dosing container ø 119mm		
For models:	MD		

adjusting screws



1

GEV No.	527444	Ref. No.	21208702
description	adjusting screw for dosing container thread M8		
For models:	MD		



1

GEV No.	527539	Ref. No.	21208701
description	adjusting screw for dosing container thread M8		
For models:	MD		

springs

group 1



1

GEV No.	528718	Ref. No.	39220010
description	tension spring ø 10mm total length 46mm wire gauge ø 1mm		
For models:	MD, Z11		



1

GEV No.	527454	Ref. No.	39220013
description	tension spring ø 5mm total length 85mm wire gauge ø 0.5mm		
For models:	Rocky		

glass cylinders



1

GEV No.	527353	Ref. No.	38125008
description	cylinder		



1

GEV No.	527354	Ref. No.	38125009
description	glass cylinder		

levers

levers



1

GEV No.	527443	Ref. No.	14705015 22105001
description	lever dosing pump brass		
For models:	MD		



1

GEV No.	527738	Ref. No.	14705001
description	lever for dosing unit hole ø 10mm metal		
For models:	Rocky		

coffee powder dispenser



1

GEV No.	527441	Ref. No.	38125017
description	coffee discharge chute angled perforation \varnothing 5mm hole distance 48mm plastic for coffee grinder		
For models:	Rocky		

coffee presses

components

pressers



1

GEV No.	527446	Ref. No.	38120032
description	coffee press \varnothing 52.3mm H 21mm plastic		
For models:	MD		



1

GEV No.	527447	Ref. No.	38120031
description	coffee press \varnothing 56.5mm H 15mm plastic		
For models:	MD		

coffee presses



1

GEV No.	527546	Ref. No.	14701027 21208301
description	coffee press \varnothing 57mm L 78mm H 50mm plastic		
For models:	MD		

sector plates



1

GEV No.	527542	Ref. No.	32329014
description	sector plates		
For models:	MD		

ratches

ratches



1

GEV No.	527453	Ref. No.	21103000
description	ratchet for dosing unit \varnothing 39mm inner cone int. \varnothing 12mm int. \varnothing 215mm		
For models:	MD		

stars

central



1

GEV No.	527543	Ref. No.	21206501
description	star mounting pos. centre \varnothing 115mm hole \varnothing 9mm H 32mm		
For models:	MD		

upper



1

GEV No.	527541	Ref. No.	21208501
description	star mounting pos. upper \varnothing 115mm hole \varnothing 23mm H 22mm		
For models:	MD		



bottom



1

GEV No.	527545	Ref. No.	14701020
description	star mounting pos. lower \varnothing 115mm shaft \varnothing 8 shaft length 60mm thread M8		
For models:	MD		

accessories



1

GEV No.	527540	Ref. No.	38123002
description	brush thread M4 plastic		
For models:	MD		



1

GEV No.	527455	Ref. No.	26208006
description	extension L 23mm thread M4 WS 8		
For models:	MD		

adjustment mechanism

lockable adjustment



1

GEV No.	527452	Ref. No.	22208501
description	push button for setting ring L 34mm W 14mm shaft \varnothing 4mm shaft length 19mm		
For models:	MD		



1

GEV No.	527451	Ref. No.	38111003
description	push button for setting ring L 35mm W 20mm shaft \varnothing 4mm shaft length 19mm		
For models:	MD		

coffee beans containers

container lids



1

GEV No.	527345	Ref. No.	38120040
description	lid for coffee beans container L 118mm W 118mm		
For models:	MD		



1

GEV No.	527346	Ref. No.	38120012
description	lid for coffee beans container L 141mm W 141mm		
For models:	MD		



1

GEV No.	527347	Ref. No.	38120025
description	lid for coffee beans container L 157mm W 157mm		
For models:	MD		

coffee beans containers



1

GEV No.	527342	Ref. No.	14030005	
description	coffee beans container			
For models:	MD			
spare parts for	527342			
	GEV No.	527345	Ref. No.	38120040
		lid for coffee beans container L 118mm W 118mm		



1

GEV No.	527343	Ref. No.	14030001
description	coffee beans container complete		
For models:	MD		
spare parts for	527343		
	GEV No.	527346	Ref. No. 38120012
	lid for coffee beans container L 141mm W 141mm		



1

GEV No.	527344	Ref. No.	14030011
description	coffee beans container complete L 160mm W 160mm H 255mm seat ø 65mm ROCKY		
For models:	MD		
spare parts for	527344		
	GEV No.	527347	Ref. No. 38120025
	lid for coffee beans container L 157mm W 157mm		



1

GEV No.	527438	Ref. No.	14705011 38123029A 914705011
description	coffee beans container ø 116mm H 120mm		
For models:	Rocky		

protection caps



1

GEV No.	527449	Ref. No.	38123040
description	grinding burrs protection H 27mm D1 ø 55.4mm		
For models:	Rocky		



1

GEV No.	527350	Ref. No.	38120061
description	grinding burrs protection suitable for RANCILIO type MD40 equiv. no. 38120061		
For models:	MD		

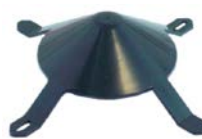

1

GEV No.	527351	Ref. No.	38120062
description	grinding burrs protection suitable for RANCILIO type MD50, MD80 equiv. no. 38120062		
For models:	MD		

locks



1

GEV No.	527348	Ref. No.	32329038
description	catch		
For models:	MD		



			
1			
GEV No.	527349	Ref. No.	3239015
description	catch		

support for filter holder

			
1			
GEV No.	527445	Ref. No.	21210502
description	filter holder support for dosing pump L 112mm W 65mm H 40mm aluminium		
For models:	MD		

			
1			
GEV No.	527547	Ref. No.	21210501
description	filter holder support for dosing pump L 114mm W 65mm H 40mm		
For models:	MD		



			
1			
GEV No.	527448	Ref. No.	38123031
description	filter holder support L 116mm W 60mm H 51mm plastic		
For models:	Rocky		

for dishwashers

drain and intake components

RANCILIO

drain /intake bodies

			
1			
GEV No.	506404	Ref. No.	38123466
description	drain fitting		
accessories for	506404		
	GEV No.	506361	Ref. No. 38123467
			nut thread 1"
	GEV No.	510072	Ref. No. 36404019 65456016
			O-ring EPDM thickness 3.53mm ID ø 32.93mm Qty 1 pcs



			
1			
GEV No.	506371	Ref. No.	38124024
description	drain fitting thread 1¼" ID ø 30mm		
accessories for	506371		
	GEV No.	506367	Ref. No. 36201014
			flat gasket rubber ED ø 40mm ID ø 28mm thickness 1.8mm Qty 1 pcs
	GEV No.	506372	Ref. No. —
			nut thread 1¼"

			
1			
GEV No.	506366	Ref. No.	38124006
description	drain fitting thread M30x2 ID ø 22mm		
accessories for	506366		
	GEV No.	506367	Ref. No. 36201014
			flat gasket rubber ED ø 40mm ID ø 28mm thickness 1.8mm Qty 1 pcs
	GEV No.	506368	Ref. No. 38123162
			nut thread M30x2

			
1			
GEV No.	506367	Ref. No.	36201014
description	flat gasket rubber ED ø 40mm ID ø 28mm thickness 1.8mm Qty 1 pcs		

			
1			
GEV No.	506334	Ref. No.	36206014
description	flat gasket rubber ED ø 54mm ID ø 41mm thickness 2mm Qty 1 pcs		

			
1			
GEV No.	506409	Ref. No.	15705124
description	intake body		
spare parts for	506409		
	GEV No.	506361	Ref. No. 38123467
	nut thread 1"		
	GEV No.	506403	Ref. No. 38123472
	overflow pipe L 90mm ø 24/27mm		
	GEV No.	506404	Ref. No. 38123466
	drain fitting		
	GEV No.	510072	Ref. No. 36404019 65456016
	O-ring EPDM thickness 3.53mm ID ø 32.93mm Qty 1 pcs		

			
1			
GEV No.	506376	Ref. No.	38123468
description	intake body thread 1 1/4" ED ø 60mm		
accessories for	506376		
	GEV No.	506372	Ref. No. —
	nut thread 1 1/4"		
	GEV No.	519179	Ref. No. 36404020
	O-ring EPDM thickness 3.53mm ID ø 41.28mm Qty 1 pcs		

			
1			
GEV No.	506361	Ref. No.	38123467
description	nut thread 1"		

			
1			
GEV No.	506333	Ref. No.	22103801 38123161
description	nut thread 1 1/4"		

			
1			
GEV No.	506368	Ref. No.	38123162
description	nut thread M30x2		

			
1			
GEV No.	519179	Ref. No.	36404020
description	O-ring EPDM thickness 3.53mm ID ø 41.28mm Qty 1 pcs		

			
1			
GEV No.	506375	Ref. No.	38123246
description	screw cap		

filters			
			
1			
GEV No.	518065	Ref. No.	65080470 65429038
description	filter support H 140mm ø 140mm		

			
1			
GEV No.	508374	Ref. No.	80259
description	flat filter H 35mm L 540mm W 274mm		

			
1			
GEV No.	510022	Ref. No.	65121052
description	round filters ø 153mm H 120mm		





			
1			
GEV No.	517792	Ref. No.	15800091
description	round filters ø 78.5mm H 64mm		

			
1			
GEV No.	506364	Ref. No.	38124034
description	overflow pipe L 130mm ø 22mm		

overflow pipes			
			
1			
GEV No.	510072	Ref. No.	36404019 65456016
description	O-ring EPDM thickness 3.53mm ID ø 32.93mm Qty 1 pcs		

			
1			
GEV No.	506370 ¹	Ref. No.	38124042
description	overflow pipe L 133mm ø 22mm		

			
1			
GEV No.	506365	Ref. No.	38124040
description	overflow pipe		

<p>for drain pump</p> 			
1			
GEV No.	506369	Ref. No.	38124023
description	overflow pipe L 133mm ø 30mm		

			
1			
GEV No.	506373	Ref. No.	30002022
description	overflow pipe		

			
1			
GEV No.	518202	Ref. No.	65142051
description	overflow pipe L 168mm ø 22mm		

			
1			
GEV No.	506362	Ref. No.	38124005
description	overflow pipe L 112mm ø 22mm		

			
1			
GEV No.	506374	Ref. No.	30002024
description	overflow pipe L 233mm ø 30mm		

			
1			
GEV No.	506363 ¹	Ref. No.	38124039
description	overflow pipe L 112mm ø 22mm		

¹for drain pump

			
1			
GEV No.	513180	Ref. No.	65080249
description	overflow pipe L 287mm ø 38mm		
accessories for	513180		
	GEV No.	510072	Ref. No.
			36404019 65456016
	O-ring EPDM thickness 3.53mm ID ø 32.93mm Qty 1 pcs		







			
1			
GEV No.	506403	Ref. No.	38123472
description	overflow pipe L 90mm ø 24/27mm		

containers

salt tanks

			
1			
GEV No.	524177	Ref. No.	65480005
description	lid ø 69mm H 20mm for salt tank ID ø 50mm		
accessories for	524177		
	GEV No.	524148	Ref. No.
			—
	O-ring EPDM thickness 3.53mm ID ø 40.86mm Qty 1 pcs		

			
1			
GEV No.	510018	Ref. No.	65429011
description	nut ø 92mm H 10.5mm for salt tank ID ø 64mm		

			
1			
GEV No.	510929	Ref. No.	38123006
description	salt tank ø 120mm H 117mm hose ø 10mm mounting ø 70mm overall height 157mm		
spare parts for	510929		
	GEV No.	506015	Ref. No.
			65456052
	O-ring EPDM thickness 3.53mm ID ø 39.69mm Qty 1 pcs		
	GEV No.	510018	Ref. No.
			65429011
	nut ø 92mm H 10.5mm for salt tank ID ø 64mm		
	GEV No.	524177	Ref. No.
			65480005
	lid ø 69mm H 20mm for salt tank ID ø 50mm		
accessories for	510929		
	GEV No.	510071	Ref. No.
			65437034
	flat gasket rubber ED ø 81mm ID ø 68mm thickness 3mm for salt tank Qty 1 pcs		
	GEV No.	510654	Ref. No.
			—
	gasket H 6mm D1 ø 82mm D2 ø 68mm		
	GEV No.	510883	Ref. No.
			36201016
	gasket rubber ED ø 86mm ID ø 66mm thickness 2mm for salt tank Qty 1 pcs		







			
1			
GEV No.	510032	Ref. No.	65406998
description	salt tank without gasket new model		
spare parts for	510032		
	GEV No.	506015	Ref. No.
			65456052
	O-ring EPDM thickness 3.53mm ID ø 39.69mm Qty 1 pcs		
	GEV No.	510018	Ref. No.
			65429011
	nut ø 92mm H 10.5mm for salt tank ID ø 64mm		

Table continues overleaf







spare parts for 510032				
	GEV No.	510071	Ref. No.	65437034
	flat gasket rubber ED ø 81mm ID ø 68mm thickness 3mm for salt tank Qty 1 pcs			
	GEV No.	524177	Ref. No.	65480005
	lid ø 69mm H 20mm for salt tank ID ø 50mm			

				
1				
GEV No.	518377	Ref. No.	65104026	
description	boiler ø 150mm L 360mm			

accessories				
				
1				
GEV No.	510071	Ref. No.	65437034	
description	flat gasket rubber ED ø 81mm ID ø 68mm thickness 3mm for salt tank Qty 1 pcs			

				
1				
GEV No.	518098	Ref. No.	65104044	
description	boiler with safety thermostat 2600W 230V ø 110mm L 295mm W 110mm H 115mm connection 11mm hose ø 6mm with thermostat inlet ø 11mm			

				
1				
GEV No.	510883	Ref. No.	36201016	
description	gasket rubber ED ø 86mm ID ø 66mm thickness 2mm for salt tank Qty 1 pcs			

spare parts for 518098				
	GEV No.	390233	Ref. No.	65236039 65926189
	bi-metal safety thermostat hole distance 24mm switch-off temp. 110°C 1NC 1-pole 16A connection F6.3 2 hole fixing without holder			
	GEV No.	390319	Ref. No.	65236048
	bi-metal thermostat hole distance 23.8mm switch-off temp. 80°C 1NC 1-pole 16A connection F6.3 2 hole fixing			
	GEV No.	418642	Ref. No.	65230113
	heating element 2600W 230V mounting ø 38.5mm heating circuits 1 L 260mm W 33mm H 24mm number of thermostat sleeves 1 thermostat sleeves ø 7mm length thermostat sleeves 175mm thermostat sleeve eccentric, non clinging tube ø 6.5mm hole distance 57mm 3 hole flange connection male faston 6.3mm immersion heater			
	GEV No.	521120	Ref. No.	36401001 65456075
	O-ring EPDM thickness 5.34mm ID ø 37.47mm Qty 1 pcs			

boilers				
boilers for dishwashers				
				
1				
GEV No.	513243	Ref. No.	65080389	
description	boiler			

accessories				
				
1				
GEV No.	517799	Ref. No.	65143228	
description	pipe for boiler ø 9mm L 245mm			

				
1				
GEV No.	518576	Ref. No.	65104050	
description	boiler			

				
1				
GEV No.	513709	Ref. No.	65104056	
description	boiler ø 110mm L 295mm			

rotation plates

rotation plates



1	GEV No.	504047	Ref. No.	69000153
	description	rotation plate ø 280mm seat ø 15mm		

rotation plate bearings

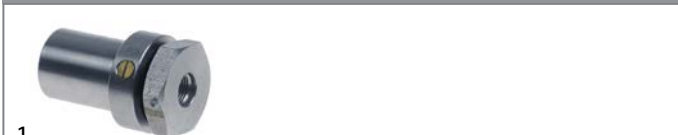

1	GEV No.	519427	Ref. No.	65322007
	description	spindle for rotation plate		

softener cartridges

softening columns



1	GEV No.	530019	Ref. No.	38123250
	description	softener double		

housing and bezels

miscellaneous



1	GEV No.	513000	Ref. No.	65480057
	description	lid rubber ED ø 27mm		

hood mechanics for dishwashers

hood handle supports

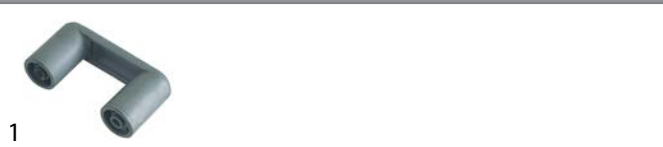

1	GEV No.	513192	Ref. No.	65926243
	description	guide for hood handle		

air traps

air traps



1	GEV No.	506396	Ref. No.	15705112
	description	air trap		
	spare parts for	506396		

	GEV No.	506398	Ref. No.	36201015
	description	flat gasket rubber ED ø 37.5mm ID ø 24mm thickness 2mm Qty 1 pcs		

	GEV No.	506399	Ref. No.	23232005
	description	nut thread 3/4" H 3mm WS 32 brass Qty 1 pcs		

	GEV No.	506400	Ref. No.	36201012
	description	flat gasket rubber ED ø 24mm ID ø 16.5mm thickness 1.5mm Qty 1 pcs		

	GEV No.	506401	Ref. No.	3812025 38121025
	description	hose connector		

	GEV No.	506402	Ref. No.	23232010
	description	union nut		



1	GEV No.	506397	Ref. No.	38123007
	description	air trap		

	accessories for	506397		
	GEV No.	506398	Ref. No.	36201015
	description	flat gasket rubber ED ø 37.5mm ID ø 24mm thickness 2mm Qty 1 pcs		

	GEV No.	506399	Ref. No.	23232005
	description	nut thread 3/4" H 3mm WS 32 brass Qty 1 pcs		

	GEV No.	506400	Ref. No.	36201012
	description	flat gasket rubber ED ø 24mm ID ø 16.5mm thickness 1.5mm Qty 1 pcs		

	GEV No.	506401	Ref. No.	3812025 38121025
	description	hose connector		

	GEV No.	506402	Ref. No.	23232010
	description	union nut		



 <p>1</p>			
GEV No.	518488	Ref. No.	65107005
description	air trap		
accessories for	518488		
 <p>GEV No. 504618 Ref. No. —</p> <p>O-ring EPDM thickness 2.62mm ID ø 15.54mm Qty 1 pcs</p>			
 <p>GEV No. 510075 Ref. No. 65437019</p> <p>flat gasket rubber ED ø 22mm ID ø 13mm thickness 1.5mm Qty 1 pcs</p>			
 <p>GEV No. 510106 Ref. No. 65468029</p> <p>hose connector for air trap</p>			

 <p>1</p>			
GEV No.	518200	Ref. No.	65984005
description	air trap ø 34mm H 78mm hose ø 6mm plastic		
spare parts for	518200		
 <p>GEV No. 504618 Ref. No. —</p> <p>O-ring EPDM thickness 2.62mm ID ø 15.54mm Qty 1 pcs</p>			
 <p>GEV No. 510075 Ref. No. 65437019</p> <p>flat gasket rubber ED ø 22mm ID ø 13mm thickness 1.5mm Qty 1 pcs</p>			
 <p>GEV No. 510106 Ref. No. 65468029</p> <p>hose connector for air trap</p>			

air trap accessories

 <p>1</p>			
GEV No.	510075	Ref. No.	65437019
description	flat gasket rubber ED ø 22mm ID ø 13mm thickness 1.5mm Qty 1 pcs		

 <p>1</p>			
GEV No.	510106	Ref. No.	65468029
description	hose connector for air trap		

backflow preventers

backflow preventers

 <p>1</p>			
GEV No.	518297	Ref. No.	65144011
description	backflow preventer		

 <p>1</p>			
GEV No.	518486	Ref. No.	65144010
description	backflow preventer connection 1/2" dishwasher hose ø 12mm		

miscellaneous

 <p>1</p>			
GEV No.	506407	Ref. No.	36301037
description	gasket		

 <p>1</p>			
GEV No.	518564	Ref. No.	65499085
description	key for pump		

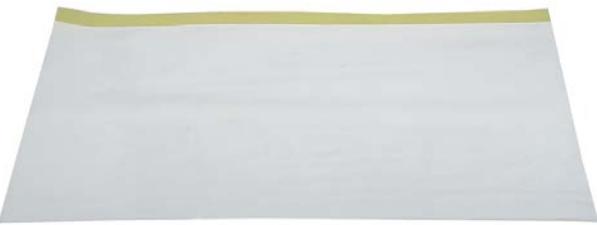
 <p>1</p>			
GEV No.	343006	Ref. No.	65214086
description	protective film for dishwasher self-adhesive L 485mm W 360mm Qty 1 pcs		

door mechanics

linkage



1

GEV No.	518355	Ref. No.	65304021
description	door pin stop rod		

sliding plates



1

GEV No.	518589	Ref. No.	38123244
description	sliding plate		



1

GEV No.	518356	Ref. No.	65307003
description	sliding plate sliding plate		



1

GEV No.	518353	Ref. No.	65307005
description	stop plastic for door L 60mm W 12.5mm H 10mm		

hinges



1

GEV No.	510090	Ref. No.	65449036
description	spring door lock spring mounting pos. door lock		

hinge camps



1

GEV No.	518262	Ref. No.	65311009
description	hinge camp mounting pos. left		



1

GEV No.	518261	Ref. No.	65311008
description	hinge camp mounting pos. right		

hinge pins



1

GEV No.	518264	Ref. No.	65325034
description	hinge pin hinge pin		

door bumpers

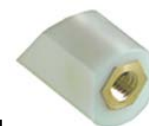

1

GEV No.	518066	Ref. No.	65417041
description	door bumper end stop		



1

GEV No.	518354	Ref. No.	65028078
description	door bumper slotted hole disc		

locks



1

GEV No.	518242	Ref. No.	65329012
description	door catch		



1

GEV No.	506157	Ref. No.	15706001
description	door catch catch		

			
1			
GEV No.	513138	Ref. No.	65994012
description	door catch with nut door locking catch		

			
1			
GEV No.	518245	Ref. No.	65325030
description	spigot door catch		

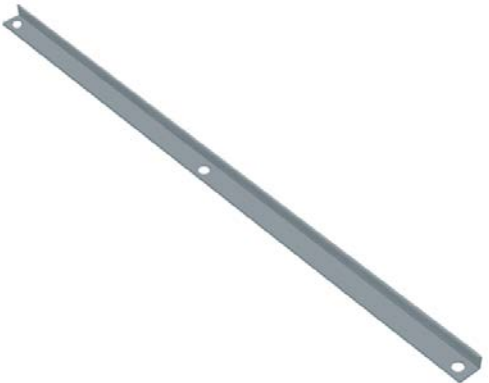
miscellaneous			
			
1			
GEV No.	518247	Ref. No.	65033291
description	fastening angle for door seal		

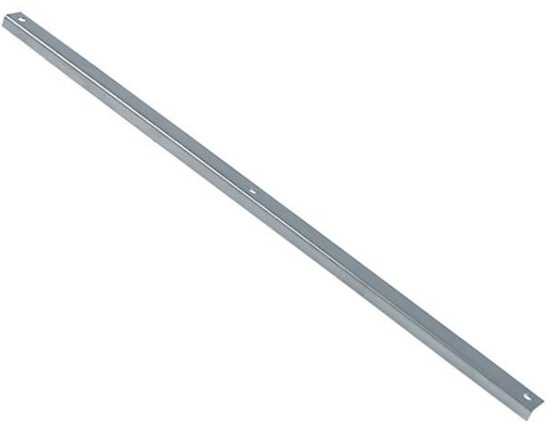
			
1			
GEV No.	518249	Ref. No.	65033294
description	fastening angle for door seal		

screw connections			
			
1			
GEV No.	519579	Ref. No.	23000020
description	hexagonal nut thread M3 H 13mm WS 10 Qty 1 pcs		

washing and rinsing systems			
			
1			
GEV No.	506337	Ref. No.	20122105
description	connecting fitting for wash arm support mounting pos. lower		

			
1			
GEV No.	506351	Ref. No.	20120107
description	connecting fitting for wash arm support mounting pos. upper		

			
1			
GEV No.	518240	Ref. No.	65437078
description	flat gasket rubber ED ø 33mm ID ø 17mm thickness 1.5mm Qty 1 pcs		

			
1			
GEV No.	518444	Ref. No.	65199051
description	flow control valve for wash arm ø 16mm H 20mm		

			
1			
GEV No.	513277	Ref. No.	65437080
description	gasket		



1

GEV No.	518071	Ref. No.	65080178
description	gasket for wash arm support L 109mm W 68mm		



1

GEV No.	518665	Ref. No.	65454006
description	knurled nut mounting pos. upper/lateral ø 19.65mm H 4mm thread M5		



1

GEV No.	517454	Ref. No.	65308031
description	nut for wash arm ED ø 35mm thickness 11mm plastic		



1

GEV No.	518596	Ref. No.	65417038
description	nut wash pipe		



1

GEV No.	518086	Ref. No.	65080174
description	opposite support		



1

GEV No.	513259	Ref. No.	65111026
description	rinse arm support mounting pos. upper		



1

GEV No.	518434	Ref. No.	65429050
description	rinse arm support mounting pos. upper		



1

GEV No.	518443	Ref. No.	65468165
description	rinse arm support mounting pos. upper		



1

GEV No.	506357	Ref. No.	25146007
description	rinse pipe mounting pos. lower		



1

GEV No.	506338	Ref. No.	38123207
description	screw cap		



1

GEV No.	510011	Ref. No.	65429008
description	screw connection plastic		



1

GEV No.	506331	Ref. No.	32235445
description	throttle disc		





1

GEV No.	510112	Ref. No.	65454002
description	Thumb screw thread M10 thread L 10mm ø 22mm H 4.5mm SS		



			
1			
GEV No.	506325	Ref. No.	25148004
description	Thumb screw thread M8 thread L 6mm D1 ø 13mm L 1.5mm ø 22mm H 2.5mm SS		

			
1			
GEV No.	518484	Ref. No.	65449045
description	wash arm support for stationary arms mounting pos. upper		

				
1				
GEV No.	513714	Ref. No.	65080237	
description	wash pipe			
spare parts for	513714			
	GEV No.	518141	Ref. No.	65080179
	wash arm support thread M46x2 ø 44mm ID ø 39mm L 112.5mm W 86mm hole ø 12mm			

washing and rinsing systems (sorted by producer)



RANCILIO



			
1			
GEV No.	506307	Ref. No.	15033926
description	wash arm L 362mm nozzles 6 mounting ø 18/36.5mm mounting pos. lower LT105		



			
1			
GEV No.	513145	Ref. No.	65080311
description	wash arm L 510mm nozzles 10 mounting ø 16mm mounting pos. upper and bottom		





			
1			
GEV No.	518273	Ref. No.	65990107
description	wash arm L 510mm nozzles 8 mounting ø 15mm mounting pos. upper and bottom		

			
1			
GEV No.	517418	Ref. No.	15704045
description	rinse arm mounting pos. lower L 375mm nozzles 6 mounting ø 18mm		





				
1				
GEV No.	506306	Ref. No.	15704055	
description	rinse arm mounting pos. upper L 380mm nozzles 6 mounting ø 18mm without nozzle edition LT 285-295			
accessories for	506306			
	GEV No.	506311	Ref. No.	23117026
	rinse jet			

				
1				
GEV No.	506305	Ref. No.	15704054	
description	rinse arm mounting pos. upper/lower L 315mm nozzles 5 mounting ø 18mm without nozzle edition LT 185-195			
spare parts for	506305			
	GEV No.	506312	Ref. No.	38123209
	wash jet			
accessories for	506305			
	GEV No.	506311	Ref. No.	23117026
	rinse jet			

			
1			
GEV No.	506309	Ref. No.	15032903
description	rinse arm mounting pos. upper/lower L 515mm nozzles 7 mounting ø 18mm without nozzle		
accessories for	506309		
	GEV No.	506311	Ref. No. 23117026
rinse jet			
	GEV No.	506312	Ref. No. 38123209
wash jet			
	GEV No.	506325	Ref. No. 25148004
Thumb screw thread M8 thread L 6mm D1 ø 13mm L 1.5mm ø 22mm H 2.5mm SS			
	GEV No.	506326	Ref. No. 36930096
disc			
	GEV No.	506339	Ref. No. 36930097
bush			

			
1			
GEV No.	506301	Ref. No.	15704068
description	wash and rinse arm 2 wash arms/ 2 rinse arms		
spare parts for	506301		
	GEV No.	506312	Ref. No. 38123209
wash jet			
	GEV No.	506314	Ref. No. 38123210
wash jet 5mm			
	GEV No.	506315	Ref. No. 38123208
union nut wash jet			
accessories for	506301		
	GEV No.	506311	Ref. No. 23117026
rinse jet			

			
1			
GEV No.	506303	Ref. No.	15704065
description	wash and rinse arm mounting pos. lower 2 wash arms/ 2 rinse arms wash arm L 410mm rinse arm L 405mm w. jets 7 r. jets 6 mounting ø 18/50mm LT 285-295		

			
1			
GEV No.	506302	Ref. No.	15704064
description	wash and rinse arm mounting pos. lower without rinse jet wash arm L 350mm rinse arm L 350mm w. jets 6 r. jets 5 mounting ø 18/50mm LT 185-195		
spare parts for	506302		
	GEV No.	506312	Ref. No. 38123209
wash jet			
	GEV No.	506314	Ref. No. 38123210
wash jet 5mm			
	GEV No.	506315	Ref. No. 38123208
union nut wash jet			
accessories for	506302		
	GEV No.	506311	Ref. No. 23117026
rinse jet			







			
1			
GEV No.	506304	Ref. No.	15704066
description	wash and rinse arm mounting pos. upper/lower without rinse jet wash arm L 485mm rinse arm L 480mm w. jets 8 r. jets 7 mounting ø 18/50mm LS 385-605		
spare parts for	506304		
	GEV No.	506312	Ref. No. 38123209
wash jet			
	GEV No.	506314	Ref. No. 38123210
wash jet 5mm			
	GEV No.	506315	Ref. No. 38123208
union nut wash jet			

Table continues overleaf





accessories for	506304		
	GEV No.	506311	Ref. No. 23117026
	rinse jet		

1 	GEV No.	506311	Ref. No. 23117026
description	rinse jet		

1 	GEV No.	506315	Ref. No. 38123208
description	union nut wash jet		

1 	GEV No.	506312	Ref. No. 38123209
description	wash jet		

1 	GEV No.	506313	Ref. No. 38123287
description	wash jet		

1 	GEV No.	506314	Ref. No. 38123210
description	wash jet 5mm		

1 	GEV No.	506395	Ref. No. 15704121
description	wash arm L 240mm nozzles 9 L2 220mm H 435mm		

1 	GEV No.	506264	Ref. No. 15704122
description	wash arm L 240mm nozzles 9 L2 250mm H 480mm		

1 	GEV No.	506321	Ref. No. 38124011
description	swirl		

1 	GEV No.	506315	Ref. No. 38123208
description	union nut wash jet		

1 	GEV No.	506313	Ref. No. 38123287
description	wash jet		

1 	GEV No.	506322	Ref. No. 38124010
description	wash jet		

















1 	GEV No.	513150	Ref. No. 65080377
description	rinse arm L 510mm nozzles 5 mounting ø 14mm mounting pos. lower		
spare parts for	513150		
	GEV No.	513155	Ref. No. —
	rinse jet thread M5 ø 8mm		

Table continues overleaf

spare parts for 513150			
	GEV No.	513159	Ref. No. 65080380
	rinse arm shaft		
	GEV No.	513221	Ref. No. 65129059
	rinse arm boss		
	GEV No.	518419	Ref. No. 65926132
	end cap for rinse arm		



			
1	GEV No.	513149	Ref. No. 65080370
	description rinse arm L 510mm nozzles 5 mounting ø 14mm mounting pos. upper/lower		
spare parts for 513149			
	GEV No.	513157	Ref. No. —
	connector holder		
	GEV No.	513221	Ref. No. 65129059
	rinse arm boss		
	GEV No.	513273	Ref. No. —
	rinse arm L 240mm nozzles 2 mounting ø 10mm mounting pos. bottom left		
	GEV No.	513723	Ref. No. —
	rinse arm L 240mm nozzles 3 mounting pos. upper/lower		
	GEV No.	518276	Ref. No. 65140025
	rinse jet		
	GEV No.	518281	Ref. No. 65454005
	knurled nut thread M6 SS ø 20mm H 4mm		
	GEV No.	518419	Ref. No. 65926132
	end cap for rinse arm		
	GEV No.	528485	Ref. No. 65456060
	O-ring EPDM thickness 1.78mm ID ø 6.07mm Qty 1 pcs		

			
1	GEV No.	518419	Ref. No. 65926132
	description end cap for rinse arm		
accessories for 518419			
	GEV No.	528485	Ref. No. 65456060
	O-ring EPDM thickness 1.78mm ID ø 6.07mm Qty 1 pcs		

			
1	GEV No.	528485	Ref. No. 65456060
	description O-ring EPDM thickness 1.78mm ID ø 6.07mm Qty 1 pcs		

			
1	GEV No.	513221	Ref. No. 65129059
	description rinse arm boss		

			
1	GEV No.	513154	Ref. No. 65140028
	description rinse jet		

			
1	GEV No.	518276	Ref. No. 65140025
	description rinse jet		
accessories for 518276			
	GEV No.	510303	Ref. No. 65456030
	O-ring EPDM thickness 1.78mm ID ø 6.75mm Qty 1 pcs		











			
1	GEV No.	518320	Ref. No. 65993048
	description rinse arm L 460mm nozzles 5 mounting ø 14mm mounting pos. lower		
spare parts for 518320			
	GEV No.	510303	Ref. No. 65456030
	O-ring EPDM thickness 1.78mm ID ø 6.75mm Qty 1 pcs		
	GEV No.	518276	Ref. No. 65140025
	rinse jet		
	GEV No.	518277	Ref. No. —
	rinse jet		
	GEV No.	518278	Ref. No. —
	end cap		
	GEV No.	518280	Ref. No. 65412029
	connector holder for knurled nut		
	GEV No.	518281	Ref. No. 65454005
	knurled nut thread M6 SS ø 20mm H 4mm		

Table continues overleaf







spare parts for		518320	
	GEV No.	518327	Ref. No. —
rinse arm boss			

			
1			
GEV No.	518276	Ref. No.	65140025
description	rinse jet		
accessories for		518276	
	GEV No.	510303	Ref. No. 65456030
O-ring EPDM thickness 1.78mm ID ø 6.75mm Qty 1 pcs			

			
1			
GEV No.	518317	Ref. No.	65993036
description	rinse arm L 245mm nozzles 4 mounting ø 17.2/M20mm mounting pos. upper		

			
1			
GEV No.	518331	Ref. No.	65106049
description	rinse arm L 110mm nozzles 2 mounting ø 13mm mounting pos. left		

			
1			
GEV No.	510139	Ref. No.	65140007
description	rinse jet		
accessories for		510139	
	GEV No.	510130	Ref. No. 65429006
union nut for rinse jet			

			
1			
GEV No.	510130	Ref. No.	65429006
description	union nut for rinse jet		
accessories for		510130	
	GEV No.	510139	Ref. No. 65140007
rinse jet			

			
1			
GEV No.	518315	Ref. No.	65129053
description	wash arm H 397mm L 400mm nozzles 6 mounting pos. upper		

			
1			
GEV No.	510146	Ref. No.	65119003
description	swirl ø 18.5mm H 7mm hole ø 2mm		

			
1			
GEV No.	510144	Ref. No.	65140010
description	union nut for wash jet		

miscellaneous			
			
1			
GEV No.	517417	Ref. No.	15704032
description	rinse jet complete mounting pos. upper/lower H 40mm		

			
1			
GEV No.	506320	Ref. No.	38124021
description	swirl H 5mm ø 14mm 5.5mm		

			
1			
GEV No.	506348	Ref. No.	38123201
description	opposite support mounting pos. lower		

			
1			
GEV No.	506350	Ref. No.	38123202
description	opposite support mounting pos. lower		



1

GEV No.	506359	Ref. No.	38123200
description	wash arm support lower		

2



GEV No.	506332	Ref. No.	30005005
description	wash arm support mounting pos. lower		

1



GEV No.	506335	Ref. No.	38123470
description	wash arm support mounting pos. lower		

accessories for 506335



GEV No.	506334	Ref. No.	36206014
description	flat gasket rubber ED ø 54mm ID ø 41mm thickness 2mm Qty 1 pcs		

1



GEV No.	506343	Ref. No.	38123157
description	wash arm support mounting pos. lower		

1



GEV No.	506347	Ref. No.	38123212
description	wash arm support mounting pos. lower		

1



GEV No.	506349	Ref. No.	15705118
description	wash arm support mounting pos. lower		



1

GEV No.	506353	Ref. No.	38123151
description	wash arm support mounting pos. upper		

rinse arm shafts

1



GEV No.	518170	Ref. No.	65143174
description	extension for rinse arm shaft		

1



GEV No.	506328	Ref. No.	25146008
description	rinse arm shaft		

1



GEV No.	506330	Ref. No.	25146013
description	rinse arm shaft		

1



GEV No.	513159	Ref. No.	65080380
description	rinse arm shaft		

1



GEV No.	506341	Ref. No.	25143007
description	rinse arm shaft mounting pos. lower		

1



GEV No.	506340	Ref. No.	25143008
description	rinse arm shaft mounting pos. upper		





			
1			
GEV No.	506356	Ref. No.	25146006
description	rinse arm shaft mounting pos. upper		

knobs

producer-specific knobs

RANCILIO

			
1			
GEV No.	111102	Ref. No.	10705215
description	knob switch zero mark ø 42mm shaft ø 5x5mm black		
For models:	S20, S20NSF, Z11		

			
1			
GEV No.	110917	Ref. No.	38123239
description	knob switch zero mark ø 34mm shaft ø 6x6mm shaft flat rectangular green		

			
1			
GEV No.	110916	Ref. No.	39900001
description	knob spring		
For models:	Silvia		

			
1			
GEV No.	110914	Ref. No.	38130026
description	rosette 0-1		

			
1			
GEV No.	110915	Ref. No.	38130027
description	rosette 2-0-1		

steam/water taps

steam/water taps

			
1			
GEV No.	111166	Ref. No.	10060175
description	knob ø 46mm		

			
1			
GEV No.	111169	Ref. No.	10060177 38123560 38123565 38123656
description	knob RANCILIO ø 49mm black		
For models:	Millenium		

			
1			
GEV No.	111040	Ref. No.	10060152
description	knob steam ø 55mm shaft ø hexagon 20mm black		
For models:	S20, S20NSF, Z11		

			
1			
GEV No.	111167	Ref. No.	10060176
description	knob water ø 47mm shaft ø hexagon 20mm black		

			
1			
GEV No.	111251	Ref. No.	10060182 10060188
description	knob water ø 52mm shaft ø hexagon 20mm black		

			
1			
GEV No.	111041	Ref. No.	10060162
description	knob water ø 55mm shaft ø hexagon width A/F20mm black		
For models:	S20, S20NSF, Z11		

accessories



GEV No.	112600	Ref. No.	10090014
description	cone handle ø 59mm L 99mm plastic black		

accessories

button springs



GEV No.	111168	Ref. No.	32210001
description	knob spring		
For models:	Millenium, S20NSF, Z11		

handles and hand wheels

cone handles



GEV No.	112600	Ref. No.	10090014
description	cone handle ø 59mm L 99mm plastic black		

levers

with handle



GEV No.	111255	Ref. No.	38123860
description	lever thread M8x1 ø 32mm for coffee machine		
For models:	Classe10		

miscellaneous



GEV No.	528721	Ref. No.	38123088
description	handle		



GEV No.	111044	Ref. No.	38111001
description	handle for intake tap		

equipment feet and end caps

screw-in feet



GEV No.	695601	Ref. No.	65461010
description	equipment foot thread M17 thread L 23mm ø 24mm H 11mm plastic WS 24 Qty 1 pcs		



GEV No.	513284	Ref. No.	65461019
description	equipment foot thread M8 thread L 20mm ø 30mm H 12mm Qty 1 pcs		

bolting feet



GEV No.	692091	Ref. No.	36310003
description	equipment foot ø 21mm H 10mm bore ø 4mm Qty 1 pcs MD50		
For models:	MD		

miscellaneous



GEV No.	692092	Ref. No.	36310009
description	equipment foot self-adhesive ø 18mm H 10mm Qty 1 pcs for coffee grinder		
For models:	Rocky		



baskets

warewashing baskets

steel wire baskets round

mix baskets



GEV No. 970309 **Ref. No.** 69000170

description mix basket ED ø 355mm H 160mm seat ø 280mm

steel wire baskets square

mix baskets



GEV No. 971014¹ **Ref. No.** 65983056

description mix basket L 382mm W 382mm H 170mm mesh type wide-meshed

¹wide-meshed

accessories

cutlery inserts



GEV No. 976013 **Ref. No.** 65712003

description cutlery insert L 105mm W 105mm ømm H 140mm

gaskets

O-rings

EPDM



GEV No. 528243 **Ref. No.** 36401008

description O-ring EPDM thickness 1.78mm ID ø 15.6mm Qty 1 pcs

GEV No. 517035 **Ref. No.** 36401003

description O-ring EPDM thickness 1.78mm ID ø 4.48mm Qty 1 pcs

For models: Classe10, S20, S20NSF, Z11

GEV No. 528485 **Ref. No.** 65456060

description O-ring EPDM thickness 1.78mm ID ø 6.07mm Qty 1 pcs

GEV No. 510303 **Ref. No.** 65456030

description O-ring EPDM thickness 1.78mm ID ø 6.75mm Qty 1 pcs

GEV No. 510177 **Ref. No.** 36404007

description O-ring EPDM thickness 1.78mm ID ø 7.66mm Qty 1 pcs

For models: Classe10, Classe6, Classe8, Epoca1gr, Epoca2gr, Millenium, S20, Z11

GEV No. 513275 **Ref. No.** 65456074

description O-ring EPDM thickness 1.78mm ID ø 82.27mm Qty 1 pcs

GEV No. 504574 **Ref. No.** 36402003
65456019

description O-ring EPDM thickness 1.78mm ID ø 9.25mm Qty 1 pcs

For models: Classe10, Classe6, Classe8, Epoca2gr, S20, Z11

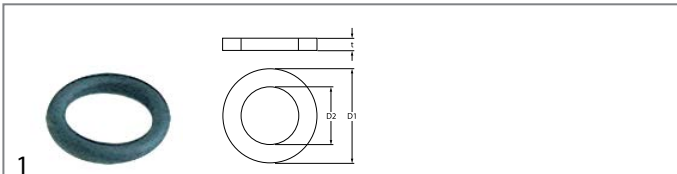

1

GEV No.	529412	Ref. No.	65456006
description	O-ring EPDM thickness 2.62mm ID ø 10.78mm Qty 1 pcs		

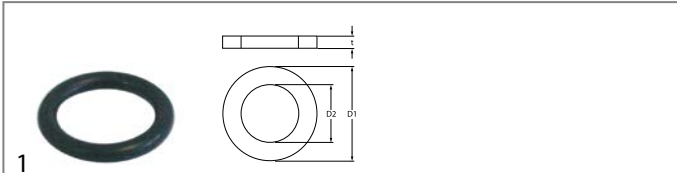

1

GEV No.	518227	Ref. No.	65456020
description	O-ring EPDM thickness 2.62mm ID ø 12.37mm Qty 1 pcs		

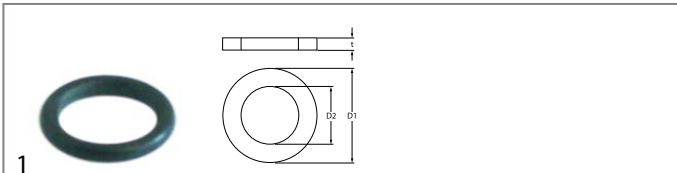

1

GEV No.	528110	Ref. No.	36405002
description	O-ring EPDM thickness 2.62mm ID ø 12.37mm Qty 1 pcs		
For models:	S20, S20NSF		

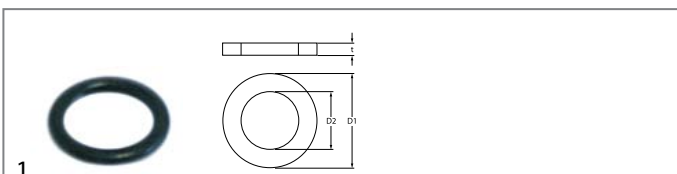

1

GEV No.	510893	Ref. No.	65456015
description	O-ring EPDM thickness 2.62mm ID ø 9.92mm Qty 1 pcs		

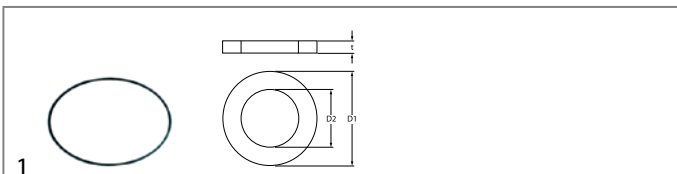

1

GEV No.	510554	Ref. No.	65456031
description	O-ring EPDM thickness 2mm ID ø 120mm Qty 1 pcs		

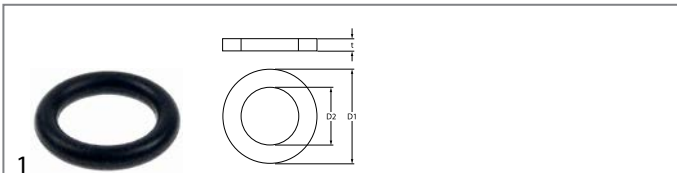

1

GEV No.	361085	Ref. No.	36407001
description	O-ring EPDM thickness 2mm ID ø 8mm Qty 1 pcs		

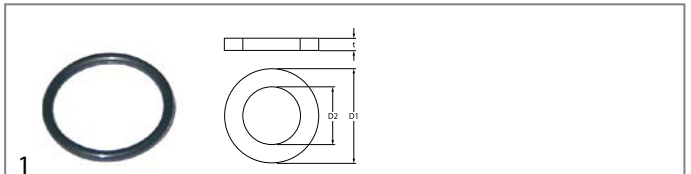

1

GEV No.	510072	Ref. No.	36404019 65456016
description	O-ring EPDM thickness 3.53mm ID ø 32.93mm Qty 1 pcs		

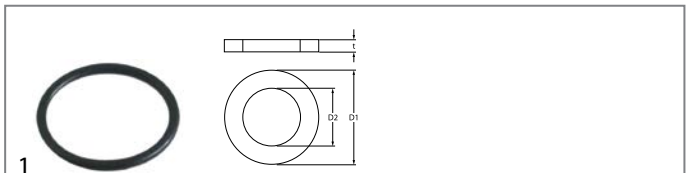

1

GEV No.	506015	Ref. No.	65456052
description	O-ring EPDM thickness 3.53mm ID ø 39.69mm Qty 1 pcs		

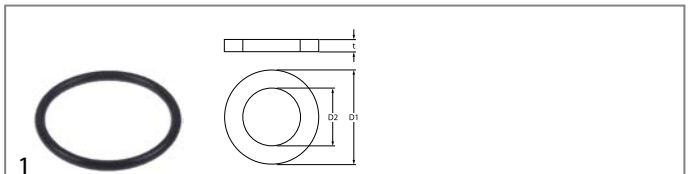

1

GEV No.	519179	Ref. No.	36404020
description	O-ring EPDM thickness 3.53mm ID ø 41.28mm Qty 1 pcs		

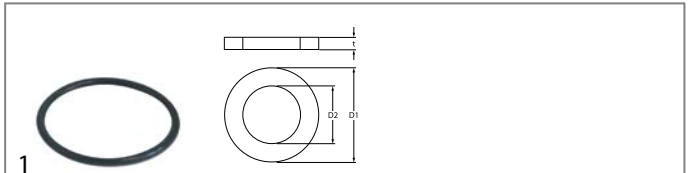

1

GEV No.	518175	Ref. No.	65456061
description	O-ring EPDM thickness 3.53mm ID ø 49.21mm Qty 1 pcs		

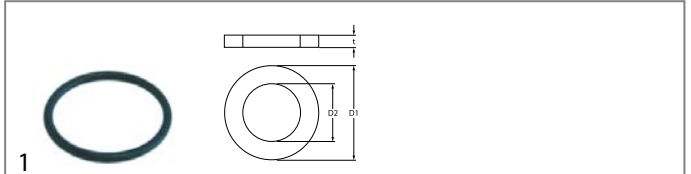

1

GEV No.	521120	Ref. No.	36401001 65456075
description	O-ring EPDM thickness 5.34mm ID ø 37.47mm Qty 1 pcs		

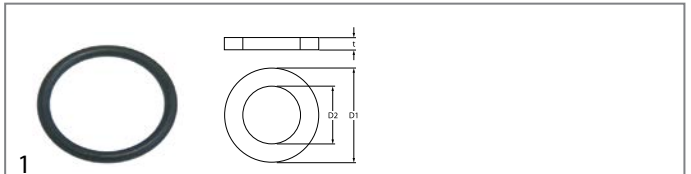

1

GEV No.	510408	Ref. No.	36401001 65450002 65456002
description	O-ring EPDM thickness 5.34mm ID ø 47mm Qty 1 pcs		



silicone

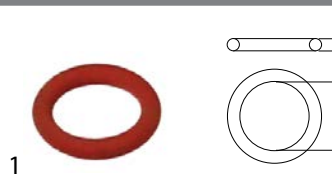

1

GEV No.	532194	Ref. No.	36404013
description	O-ring silicone thickness 1.78mm ID ø 7.66mm Qty 10 pcs		
For models:	S20NSF, Z11		

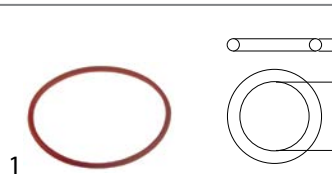

1

GEV No.	532368	Ref. No.	36404111
description	O-ring silicone thickness 3.53mm ID ø 120.2mm Qty 10 pcs		
For models:	S20NSF		

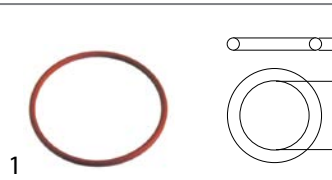

1

GEV No.	532507	Ref. No.	36405001
description	O-ring silicone thickness 3.53mm ID ø 74.61mm Qty 1 pcs		
For models:	Silvia		

Viton

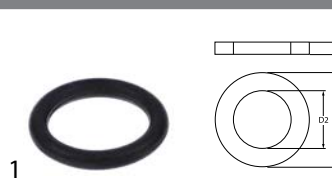

1

GEV No.	525059	Ref. No.	36404001
description	O-ring Viton thickness 2.4mm ID ø 12.3mm Qty 1 pcs		
For models:	S20, S20NSF, Z11		

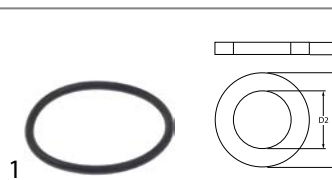

1

GEV No.	532690	Ref. No.	36404009
description	O-ring Viton thickness 5mm ID ø 78mm Qty 1 pcs		
For models:	Z11		

sealing washers

fibre gaskets



1

GEV No.	528723	Ref. No.	36220008
description	flat gasket FIBER ED ø 20mm ID ø 13mm thickness 1mm Qty 1 pcs		



1

GEV No.	529349	Ref. No.	65437030
description	flat gasket FIBER ED ø 22mm ID ø 16.5mm thickness 2mm for thread 3/8" Qty 1 pcs		



1

GEV No.	518393	Ref. No.	65437042
description	flat gasket FIBER ED ø 24mm ID ø 17mm thickness 2mm Qty 1 pcs		



1

GEV No.	521122	Ref. No.	36220010
description	flat gasket fibre ED ø 31mm ID ø 21.5mm thickness 2mm for thread 1/2" Qty 1 pcs		



1

GEV No.	510405	Ref. No.	36404017
description	flat gasket fibre ED ø 56mm ID ø 42mm thickness 2mm for thread 1 1/4" Qty 1 pcs		





1

GEV No.	510406	Ref. No.	36220003
description	flat gasket fibre ED ø 60mm ID ø 48mm thickness 3mm for thread 1 1/2" Qty 1 pcs		

rubber gaskets

			
1			
GEV No.	506263	Ref. No.	36206017
description	flat gasket rubber ED ø 43.3mm ID ø 33mm thickness 0.8mm Qty 1 pcs suitable for RANCILIO		

			
1			
GEV No.	519547	Ref. No.	65437041
description	flat gasket rubber ED ø 14.4mm ID ø 15.5mm thickness 2mm Qty 1 pcs size 3/4"		

			
1			
GEV No.	520390	Ref. No.	36201005
description	flat gasket rubber ED ø 21mm ID ø 16mm thickness 2mm Qty 1 pcs		
For models:	Z11		

			
1			
GEV No.	510075	Ref. No.	65437019
description	flat gasket rubber ED ø 22mm ID ø 13mm thickness 1.5mm Qty 1 pcs		

			
1			
GEV No.	506400	Ref. No.	36201012
description	flat gasket rubber ED ø 24mm ID ø 16.5mm thickness 1.5mm Qty 1 pcs		

			
1			
GEV No.	518240	Ref. No.	65437078
description	flat gasket rubber ED ø 33mm ID ø 17mm thickness 1.5mm Qty 1 pcs		

			
1			
GEV No.	506398	Ref. No.	36201015
description	flat gasket rubber ED ø 37.5mm ID ø 24mm thickness 2mm Qty 1 pcs		

			
1			
GEV No.	506367	Ref. No.	36201014
description	flat gasket rubber ED ø 40mm ID ø 28mm thickness 1.8mm Qty 1 pcs		

			
1			
GEV No.	513059	Ref. No.	65437063
description	flat gasket rubber ED ø 52mm ID ø 40mm thickness 3mm Qty 1 pcs		

			
1			
GEV No.	506334	Ref. No.	36206014
description	flat gasket rubber ED ø 54mm ID ø 41mm thickness 2mm Qty 1 pcs		

			
1			
GEV No.	518205	Ref. No.	65437079
description	flat gasket rubber ED ø 61mm ID ø 47mm thickness 2mm Qty 1 pcs		

			
1			
GEV No.	510071	Ref. No.	65437034
description	flat gasket rubber ED ø 81mm ID ø 68mm thickness 3mm for salt tank Qty 1 pcs		

			
1			
GEV No.	529372	Ref. No.	36103002
description	gasket		
For models:	Millenium, Z11		

			
1			
GEV No.	528320	Ref. No.	36301009
description	gasket rubber ED ø 10mm ID ø 4mm thickness 2mm Qty 1 pcs suitable for for valve		
For models:	Z11		





 <p>1</p>			
GEV No.	518060	Ref. No.	65456040
description	gasket rubber ED ø 132mm ID ø 122mm thickness 5mm		

 <p>1</p>			
GEV No.	510883	Ref. No.	36201016
description	gasket rubber ED ø 86mm ID ø 66mm thickness 2mm for salt tank Qty 1 pcs		

copper gaskets

DIN-7603-A

 <p>1</p>			
GEV No.	528197	Ref. No.	36240001
description	flat gasket copper ED ø 10mm ID ø 6mm thickness 1mm Qty 1 pcs		
For models:	S20, S20NSF, Silvia, Z11		

 <p>1</p>			
GEV No.	529373	Ref. No.	36240002
description	flat gasket copper ED ø 15mm ID ø 10.2mm thickness 1mm		
For models:	S20NSF, Z11		

 <p>1</p>			
GEV No.	506329	Ref. No.	24270001 27270001
description	flat gasket copper ED ø 18mm ID ø 13.5mm thickness 1mm for thread 1/4"		
For models:	Classe6, Classe8, Epoca1gr, Epoca2gr, S20, S20NSF, Z11		

 <p>1</p>			
GEV No.	528660	Ref. No.	27350002
description	flat gasket copper ED ø 21mm ID ø 17mm thickness 1.5mm suitable for 3/8"		
For models:	Classe10, Classe6, Classe8, Millenium, S20, S20NSF		

 <p>1</p>			
GEV No.	528701	Ref. No.	27350001 927350001
description	flat gasket copper ED ø 21mm ID ø 17mm thickness 1mm suitable for 3/8"		
For models:	Classe10, Classe6, Classe8, Epoca1gr, Epoca2gr, Millenium, S20, S20NSF, Silvia, Z11		

 <p>1</p>			
GEV No.	560331	Ref. No.	27400002
description	flat gasket copper ED ø 22mm ID ø 18mm thickness 1.5mm Qty 1 pcs		
For models:	Epoca1gr		

 <p>1</p>			
GEV No.	528698	Ref. No.	27400001
description	flat gasket copper ED ø 24mm ID ø 20mm thickness 1mm		
For models:	Classe10, Millenium, S20, S20NSF, Z11		

 <p>1</p>			
GEV No.	528737	Ref. No.	36240003
description	flat gasket copper ED ø 30mm ID ø 26mm thickness 1mm		
For models:	Classe10, Z11		

 <p>1</p>			
GEV No.	506342	Ref. No.	36240005
description	flat gasket copper ED ø 32.7mm ID ø 26.5mm thickness 1mm		
For models:	S20, S20NSF		

DIN-7603-C

 <p>1</p>			
GEV No.	529360	Ref. No.	36930013
description	gasket copper ED ø 26.1mm ID ø 21mm thickness 2.1mm for thread 1/2"		
For models:	Classe10, Classe6, Classe8, Epoca2gr, Millenium, Z11		

PTFE gaskets



1			
GEV No.	528956	Ref. No.	36220018
description	flat gasket PTFE ED ø 130mm ID ø 117mm thickness 1.6mm Qty 1 pcs		
For models:	Epoca1gr, S20		



1			
GEV No.	528198	Ref. No.	36930017
description	flat gasket PTFE ED ø 14.5mm ID ø 12mm thickness 1mm inner cone for steam pipe Qty 1 pcs H 3mm		



1			
GEV No.	359332	Ref. No.	36220009
description	flat gasket PTFE ED ø 21mm ID ø 16.8mm thickness 1.7mm Qty 1 pcs		
For models:	Classe10, Classe6, Classe8, S20, S20NSF, Z11		



1			
GEV No.	506355	Ref. No.	36230011
description	flat gasket PTFE ED ø 25mm ID ø 17mm thickness 0.5mm Qty 1 pcs		



1			
GEV No.	518180	Ref. No.	65303018
description	flat gasket PTFE ED ø 40mm ID ø 35mm thickness 3mm Qty 1 pcs equiv. no. 303018/371450-166 suitable for COLGED, HOBART		



1			
GEV No.	528003	Ref. No.	36930012
description	flat gasket PTFE ED ø 59mm ID ø 45mm thickness 2mm Qty 1 pcs equiv. no. 36930012 suitable for RANCILIO		
For models:	Classe10, Classe6, Classe8, Epoca2gr, Millenium, S20, Z11		



1			
GEV No.	531077	Ref. No.	36230001
description	gasket PTFE ED ø 18mm ID ø 9mm thickness 0.5mm Qty 1 pcs		
For models:	S20, S20NSF, Z11		

Viton gaskets



1			
GEV No.	528696	Ref. No.	36301008 36301102
description	gasket Viton ED ø 13.5mm ID ø 4mm thickness 4mm Qty 1 pcs		
For models:	Classe10, Millenium, S20, S20NSF, Z11		



1			
GEV No.	528733	Ref. No.	36302002
description	gasket Viton ED ø 13.5mm ID ø 4mm thickness 4mm Qty 1 pcs		
For models:	Classe10, Classe6, Epoca2gr, Silvia, Z11		

special gaskets

door seals for dishwashers

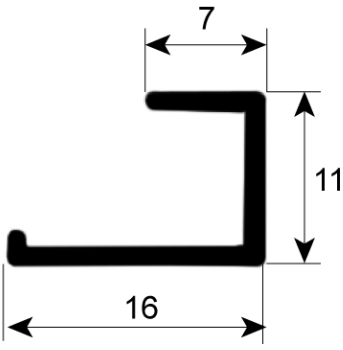

1			
GEV No.	518246	Ref. No.	65437057
description	door seal L 395mm dishwasher suitable for ELETTOBAR, WOLK equiv. no. 437057		

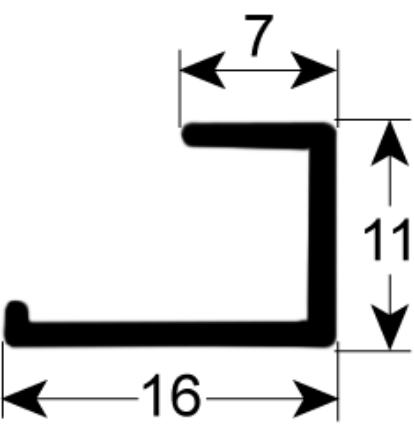

1			
GEV No.	518248	Ref. No.	65437058
description	door seal L 430mm dishwasher suitable for ELETTOBAR, WOLK equiv. no. 437058		



GEV No.	518536	Ref. No.	65437081
description	door seal L 590mm W 32mm dishwasher suitable for ELETTOBAR, WOLK equiv. no. 437052		

GEV No.	528196	Ref. No.	36101012
description	gasket ED ø 104mm ID ø 88.5mm H 8mm X-shape		
For models:	Z11		

sealing discs

GEV No.	528289	Ref. No.	36301041
description	gasket rubber D1 ø 11mm thickness 2mm for expansion valve Qty 1 pcs		
For models:	Epoca1gr		

GEV No.	528322	Ref. No.	36101003
description	gasket ED ø 19mm ID ø 11.5mm H 4mm for valve body		
For models:	Z11		

group gaskets

GEV No.	528199	Ref. No.	36206008
description	gasket D1 ø 126mm D2 ø 104mm thickness 1mm hole distance 118mm rubber		
For models:	Z11		

GEV No.	528285	Ref. No.	36101004
description	gasket ED ø 24mm ID ø 14mm H 5mm		
For models:	Z11		

GEV No.	528228	Ref. No.	36206004
description	gasket D1 ø 32mm thickness 0.6mm mounting pos. right rubber		
For models:	Z11		

GEV No.	528194	Ref. No.	36101005
description	gasket ED ø 50.5mm ID ø 35.5mm H 7.5mm X-shape		
For models:	Classe6, Z11		

GEV No.	528212	Ref. No.	36206003
description	gasket D1 ø 32mm thickness 1mm mounting pos. left rubber		
For models:	Z11		

GEV No.	529292	Ref. No.	36101006
description	gasket ED ø 51mm W 7mm int. ø 1 37mm		
For models:	Classe6, Z11		

GEV No.	528739	Ref. No.	36220004
description	group gasket L 71mm W 71mm thickness 2mm suitable for RANCILIO hole distance 46mm		
For models:	Epoca2gr, Z11		

GEV No.	528195	Ref. No.	36101007
description	gasket ED ø 54.5mm ID ø 39.5mm H 7.5mm X-shape		
For models:	Z11		



1

GEV No.	529294	Ref. No.	36101008
description	gasket ED ø 55mm W 7mm int. ø 141mm		
For models:	Z11		

miscellaneous



1

GEV No.	506407	Ref. No.	36301037
description	gasket		



1

GEV No.	506406	Ref. No.	36201028
description	gasket suitable for RANCILIO equiv. no. 36201028 L 48mm W 46mm microswitch		

gaskets for wash arm support



1

GEV No.	518025	Ref. No.	65437014
description	gasket D1 ø 50mm D2 ø 82mm thickness 2mm with 6 holes wash arm support equiv. no. 437014 suitable for COLGED		



1

GEV No.	506344	Ref. No.	36201023
description	gasket D1 ø 56.5mm D2 ø 86mm thickness 0.8mm rubber with 4 screw holes wash arm support equiv. no. 36201023 suitable for RANCILIO		



1

GEV No.	506345	Ref. No.	36201027
description	gasket D1 ø 85mm D2 ø 57mm thickness 1.5mm with 4 screw holes wash arm support equiv. no. 36201027 suitable for RANCILIO		



1

GEV No.	518339	Ref. No.	65437064
description	gasket D2 ø 50mm thickness 2mm with 3 screw holes wash arm support equiv. no. 437064 suitable for COLGED hole ø 50mm hole distance 67mm		

condensors

condensors

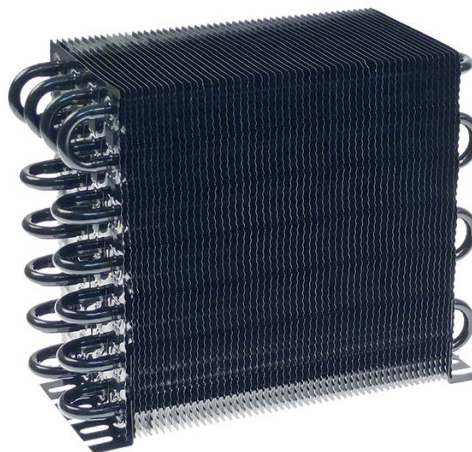

1

GEV No.	750661	Ref. No.	68020019
description	condenser W 215mm D 270mm H 117mm Qty 1 pcs		

springs

compression springs



1

GEV No.	528324	Ref. No.	39110040
description	compression spring ø 11mm L 21mm wire gauge ø 1.5mm for expansion valve		
For models:	Epoca 1gr, S20, S20NSF, Silvia, Z11		



 <p>1</p>			
GEV No.	528334	Ref. No.	39110038 939110038
description	compression spring ø 12.2mm L 11.6mm wire gauge ø 2.1mm for steam/water pipes		

 <p>1</p>			
GEV No.	528190	Ref. No.	39110035
description	compression spring ø 12mm L 30mm wire gauge ø 1mm		

 <p>1</p>			
GEV No.	528189	Ref. No.	39110036
description	compression spring ø 14mm L 18mm wire gauge ø 1mm		

 <p>1</p>			
GEV No.	528697	Ref. No.	39110010
description	compression spring ø 16mm L 31mm wire gauge ø 2mm		
For models:	Classe10, S20, S20NSF, Z11		

 <p>1</p>			
GEV No.	529375	Ref. No.	39110012
description	compression spring ø 17mm L 13mm wire gauge ø 2mm		
For models:	Millenium, S20NSF, Z11		

 <p>1</p>			
GEV No.	528732	Ref. No.	39110072
description	compression spring ø 17mm L 40mm wire gauge ø 2.7mm		
For models:	Classe10, Z11		

 <p>1</p>			
GEV No.	527442	Ref. No.	39120035
description	compression spring ø 3.8mm L 17mm wire gauge ø 0.35mm for coffee grinder		
For models:	MD, Rocky		

 <p>1</p>			
GEV No.	527544	Ref. No.	39110025 39120025
description	compression spring ø 35.2mm L 22mm wire gauge ø 2mm		
For models:	MD, S20, S20NSF, Z11		

 <p>1</p>			
GEV No.	528114	Ref. No.	39120014
description	compression spring ø 45mm L 185mm wire gauge ø 7mm		
For models:	Classe6, Z11		

 <p>1</p>			
GEV No.	528735	Ref. No.	39110071
description	compression spring ø 7.7mm L 35mm wire gauge ø 0.6mm		
For models:	Classe10, Z11		

 <p>1</p>			
GEV No.	528699	Ref. No.	39110060
description	compression spring ø 8mm L 53mm wire gauge ø 0.4mm		

 <p>1</p>			
GEV No.	528193	Ref. No.	39110063
description	compression spring ø 8mm L 55mm wire gauge ø 0.7mm		
For models:	Classe10, Classe6, Classe8, Epoca2gr, S20, S20NSF		

 <p>1</p>			
GEV No.	528703	Ref. No.	39110064 39110070
description	compression spring ø 9.6mm L 26mm wire gauge ø 0.6mm		
For models:	Epoca1gr, S20, S20NSF, Z11		



1

GEV No.	528716	Ref. No.	39110030
description	cross flow fan ø 11.6mm L 21mm wire gauge ø 1.2mm		
For models:	Classe10, S20NSF, Z11		

gas tension springs



1

GEV No.	701299	Ref. No.	65035070
description	gas tension spring 50N hub 150mm D1 ø 15mm D2 ø 6mm hole distance 365.5mm hole ø 6.5mm L 380mm		

tension springs



1

GEV No.	695544	Ref. No.	68020282
description	tension spring ø 10.5mm total length 42mm wire gauge ø 1.5mm		



1

GEV No.	518260	Ref. No.	65449049
description	tension spring ø 10mm total length 145mm wire gauge ø 1mm		



1

GEV No.	528718	Ref. No.	39220010
description	tension spring ø 10mm total length 46mm wire gauge ø 1mm		
For models:	MD, Z11		



1

GEV No.	528719	Ref. No.	39220025
description	tension spring ø 13.2mm total length 85mm wire gauge ø 2.1mm		
For models:	Classe10, Z11		



1

GEV No.	527454	Ref. No.	39220013
description	tension spring ø 5mm total length 85mm wire gauge ø 0.5mm		
For models:	Rocky		

manometers



1

GEV No.	541209	Ref. No.	35162501
description	manometer double scale ø 70mm pressure range 0-2.5 / 0-16bar connection thread 1/8"		



1

GEV No.	541669	Ref. No.	35002509
description	manometer ø 41mm pressure range 16bar thread 1/8" coffee machine		
For models:	Classe10, Classe6, Classe8, Epoca2gr		



1

GEV No.	541261	Ref. No.	35002508
description	manometer ø 44mm pressure range 0 up to 2.5bar thread 1/8" connection on the backside		
For models:	Classe10, Classe6, Classe8, Epoca1gr, Epoca2gr		

dosing pumps

peristaltic dosing pumps

SEKO

built-in version

with frequency control











1

GEV No.	361767 ¹	Ref. No.	65209021	
description	dosing pump SEKO 3l/h 230VAC detergent hose ø 4x6mm hose type K hose Santoprene suction level 1.5m type NBR 3 8W built-in version peristaltic pump			
spare parts for	361767			
	GEV No.	361815	Ref. No.	65143219
	pump hose detergent hose ø 6x10mm hose ø 4x6mm hose type K hose Santoprene type SEKO			

¹incl. inlet and conveyor hose



			
1			
GEV No.	361215	Ref. No.	65209016
description	dosing pump SEKO frequency control 0.3-3.0l/h 230VAC detergent hose ø 4x6mm hose type K hose Santoprene suction level 1.5m type PBR protection IP55 dimensions 100x67x68mm power input 3.5W		
spare parts for	361215		
	GEV No.	361136	Ref. No. —
	roller assembly for dosing pump hole ø 4.8x4mm		
	GEV No.	361226	Ref. No. —
	PCB L 59mm W 26mm electronic control		
	GEV No.	361815	Ref. No. 65143219
	pump hose detergent hose ø 6x10mm hose ø 4x6mm hose type K hose Santoprene type SEKO		
accessories for	361215		
	GEV No.	361142	Ref. No. —
	mounting set detergent hose type 4x6mm hose length 2m PVC 2x hose/container filter/tank intake transparent		
	GEV No.	520090	Ref. No. 65143194
	PVC hose ID ø 4mm ED ø 6mm L 2m thickness 1mm t.max. 60°C transparent		
	GEV No.	520091	Ref. No. —
	nylon hose ID ø 4mm ED ø 6mm L 2m thickness 1mm operating p. 10bar burst p. 50bar t.max. 100°C transparent		

<p>spare parts</p>  			
1			
GEV No.	361815	Ref. No.	65143219
description	pump hose detergent hose ø 6x10mm hose ø 4x6mm hose type K hose Santoprene type SEKO		

piston pumps

<p>spare parts</p> 			
1			
GEV No.	510298	Ref. No.	65144012 69000076
description	lip valve dosing pump suitable for DB2/DS5		

membrane dosing pumps

self-priming

SEKO



			
1			
GEV No.	361364 ¹	Ref. No.	65926278
description	dosing pump type DIB5E self-sucking rinse aid pump rate 0-5cm ³ per stroke pressure connection ø 4x6mm suction connection ø 4x6mm SEKO supporting pressure closed		
spare parts for	361364		
	GEV No.	361301	Ref. No. —
	hose connector for type DIB3E/DIB5E		
	GEV No.	361302	Ref. No. —
	valve bush for type DIB3E/DIB5E		
	GEV No.	361304	Ref. No. —
	O-ring EPDM ID ø 11.11mm thickness 1.78mm Qty 1 pcs for type DIB3E/DIB5E		
	GEV No.	361305	Ref. No. —
	valve disc for type DIB3E/DIB5E DIB3P/DIB5P		
	GEV No.	361306	Ref. No. —
	membrane for type DIB3E/DIB5E ø 49mm hole ø 5mm		
	GEV No.	361307	Ref. No. —
	membrane dosing pump ø 68mm hole ø 6mm for type DIB3P/DIB5P		
	GEV No.	361459	Ref. No. —
	hose connector ø 6mm for dosing pump		
	GEV No.	361481	Ref. No. —
	lip valve for type DIB3P/DIB5P DIB3E/DIB5E		
accessories for	361364		
	GEV No.	361240	Ref. No. —
	hose connector 1-way hose ø 6mm plastic connection M10x1		
	GEV No.	361241	Ref. No. —
	hose connector 1-way hose ø 9mm plastic connection M10x1		

¹auxiliary pressure connection closed

various



1

GEV No.	361015	Ref. No.	69000298
description	dosing pump membrane dosing pump rinse aid inlet 6x8mm outlet 4x6mm pressure connection ø 4x6mm suction connection ø 6x8mm		
spare parts for	361015		
	GEV No.	361132	Ref. No. —
	membrane dosing pump		
	GEV No.	510298	Ref. No. 65144012 69000076
	lip valve dosing pump suitable for DB2/DS5		

spare parts



1



GEV No.	510298	Ref. No.	65144012 69000076
description	lip valve dosing pump suitable for DB2/DS5		

self-priming with supporting pressure

ELETTOBAR



1

GEV No.	361362	Ref. No.	65987023
description	dosing pump rinse aid pressure connection ø 6mm pressure connection 6		
spare parts for	361362		
	GEV No.	361363	Ref. No. 65199012
	membrane		
	GEV No.	510298	Ref. No. 65144012 69000076
	lip valve dosing pump suitable for DB2/DS5		



1

GEV No.	510298	Ref. No.	65144012 69000076
description	lip valve dosing pump suitable for DB2/DS5		



1

GEV No.	361363	Ref. No.	65199012
description	membrane		

GERMAC

spare parts



1

GEV No.	510298	Ref. No.	65144012 69000076
description	lip valve dosing pump suitable for DB2/DS5		

RANCILIO

spare parts



1

GEV No.	361349	Ref. No.	36206007
description	membrane L 50mm W 50mm		



1

GEV No.	361426	Ref. No.	23120025
description	non-return valve		
For models:	Classe10, Classe6, Classe8, Epoca1gr, Epoca2gr, Millenium, S20, Z11		



SEKO



1

GEV No.	362013	Ref. No.	65929198
description	dosing pump type DIB P with auxiliary pressure connection for dishwashers pump rate 0-3cm ³ per stroke pressure connection ø 4x6mm suction connection ø 4x6mm auxiliary pressure connection 10mm SEKO		

accessories

container filters



1

GEV No.	513043	Ref. No.	65121017
description	container filter hose ø 4mm		



1

GEV No.	361141	Ref. No.	65121075
description	container filter with weight ceramic hose ø 4mm		

hoses



PVC hoses



1

GEV No.	520090	Ref. No.	65143194	
description	PVC hose ID ø 4mm ED ø 6mm L 2m thickness 1mm t.max. 60°C transparent			
accessories for	520090			
	GEV No.	361058	Ref. No.	—
	container filter with non-return valve SS hose ø 4x6mm ø 20mm L 56mm			
	GEV No.	361066	Ref. No.	—
	container filter straight SS hose ø 4x6mm L 37mm non return valve ball valve			
	GEV No.	361106	Ref. No.	—
	container filter with weight and non-return valve SS hose ø 4x6mm ø 21mm L 51mm non return valve lip valve			
	GEV No.	361141	Ref. No.	65121075
	container filter with weight ceramic hose ø 4mm			
	GEV No.	361230	Ref. No.	—
	container filter with weight stainless steel hose ø 4x6mm			

accessories for 520090

	GEV No.	361462	Ref. No.	—
	container filter with weight SS hose ø 4x6mm			
	GEV No.	361728	Ref. No.	—
	container filter with 4m 4x6 hose SS hose ø 4x6mm hose length 4000mm			

hose couplings

metal



1

GEV No.	361184	Ref. No.	23225003
description	nut thread 1/2" H 6mm nickel-plated brass WS 24 Qty 1 pcs		
For models:	S20NSF, Z11		

tank inlets



1

GEV No.	361270	Ref. No.	65468151
description	tank inlet SS M12 hose ø 4mm		



hoses

supply hoses

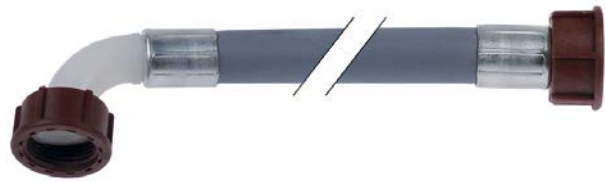
PVC supply hoses



1

GEV No.	520010	Ref. No.	65143170 69000195	
description	supply hose PVC straight-curved DN13 connections 3/4" L 1500mm operating p. 10bar burst p. 32bar t.max. 90°C blue approval VDE flat seal			
accessories for	520010			
	GEV No.	520053	Ref. No.	—
	screen connection 3/4" D1 ø 26mm D2 ø 15mm Qty 10 pcs rubber thickness 8mm			
	GEV No.	520054	Ref. No.	—
	flat gasket rubber ED ø 23.5mm ID ø 14mm thickness 2.3mm Qty 10 pcs			

industrial hoses

pressure control hoses



GEV No.	530560	Ref. No.	65143005 65143013
description	pressure control hose ID ø 5mm ED ø 9mm L 5m operating p. 30bar burst p. 90bar temp.-resist. 60°C		

drain hoses

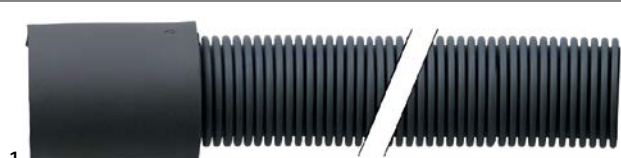

GEV No.	513718	Ref. No.	65143120
description	drain hose DN19 L 1500mm straight ø inside 24mm straight ext. ø 28mm outer hose ø 23mm		

PVC hoses

PVC hoses without fabric



GEV No.	520090	Ref. No.	65143194
description	PVC hose ID ø 4mm ED ø 6mm L 2m thickness 1mm t.max. 60°C transparent		

accessories for	520090			
	GEV No.	361058	Ref. No.	—
	container filter with non-return valve SS hose ø 4x6mm ø 20mm L 56mm			
	GEV No.	361066	Ref. No.	—
	container filter straight SS hose ø 4x6mm L 37mm non return valve ball valve			
	GEV No.	361106	Ref. No.	—
	container filter with weight and non-return valve SS hose ø 4x6mm ø 21mm L 51mm non return valve lip valve			
	GEV No.	361141	Ref. No.	65121075
	container filter with weight ceramic hose ø 4mm			
	GEV No.	361230	Ref. No.	—
	container filter with weight stainless steel hose ø 4x6mm			
	GEV No.	361462	Ref. No.	—
	container filter with weight SS hose ø 4x6mm			
	GEV No.	361728	Ref. No.	—
	container filter with 4m 4x6 hose SS hose ø 4x6mm hose length 4000mm			



GEV No.	518518	Ref. No.	65143178
description	drain hose DN19 L 1500mm A int. ø 21mm A ext. ø 27mm B int. ø 29mm B ext. ø 35mm outer hose ø 25mm		



GEV No.	513258	Ref. No.	65127044
description	drain hose DN19 L 270mm A int. ø 22mm A ext. ø 28mm B int. ø 24mm B ext. ø 28mm outer hose ø 22mm		



GEV No.	518219	Ref. No.	65127037
description	drain hose DN19 L 630mm A int. ø 20mm A ext. ø 27mm B int. ø 21mm B ext. ø 28mm outer hose ø 24mm		

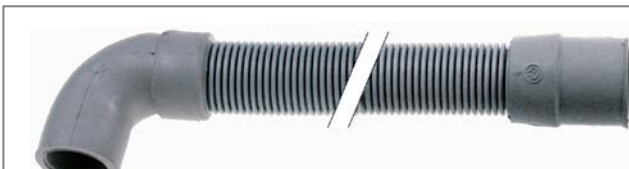

GEV No.	530819	Ref. No.	65143137
description	drain hose DN20 L 2500mm straight ø inside 19mm straight ext. ø 24mm elbow ø inside 22mm elbow ext. ø 27mm outer hose ø 24mm		

hoses wire reinforced



GEV No.	520686	Ref. No.	36901800
description	drain hose ID ø 14mm ED ø 20mm L 5m wire reinforced		
For models:	Millenium, S20, Z11		



formed hoses

straight



1

GEV No.	518519	Ref. No.	65127054
description	formed hose dishwasher straight equiv. no. 127054		



1

GEV No.	518070	Ref. No.	65127026
description	formed hose dishwasher straight mounting pos. upper equiv. no. 127026		



1

GEV No.	518380	Ref. No.	65127036
description	formed hose ext. \varnothing 53 ID \varnothing 43mm L 65mm dishwasher straight mounting pos. upper equiv. no. 127036		

form L



1

GEV No.	518639	Ref. No.	65143237
description	formed hose end piece A ext. \varnothing 18mm end piece A int. \varnothing 11mm AD2 \varnothing 18mm \varnothing end piece B 11mm L 460mm		



1

GEV No.	513250	Ref. No.	65080188
description	formed hose ID \varnothing 48mm ED \varnothing 60mm thickness 6mm L1 235mm L2 140mm L-shape		



1

GEV No.	506382	Ref. No.	36301020
description	formed hose L 160x220mm warewashing L-shape equiv. no. 36301020 ID \varnothing 60mm		



1

GEV No.	518225	Ref. No.	65127041
description	formed hose warewashing L-shape equiv. no. 127041		



1

GEV No.	506383	Ref. No.	36306004
description	formed hose warewashing L-shape equiv. no. 36306004		



1

GEV No.	506378	Ref. No.	36306020
description	formed hose warewashing L-shape equiv. no. 36306020		

with branch



1

GEV No.	511929	Ref. No.	65143239
description	formed hose ext. \varnothing 17 L 430mm plastic black Qty 1		



form S



1

GEV No.	506379	Ref. No.	36306021
description	formed hose S-shape warewashing equiv. no. 36306021		

form U



1

GEV No.	518517	Ref. No.	65127050
description	formed hose for drain pump D1 ø 28mm D2 ø 21mm warewashing U-shape		

miscellaneous



1

GEV No.	513716	Ref. No.	65127053
description	pressure hose warewashing		

for dishwashers

ventilation hoses



1

GEV No.	513265	Ref. No.	65143189
description	ventilation hose ext. ø 17 ID ø 14mm L 75mm warewashing back-flow restrictor		

fittings, hose and pipe connectors

hose connectors

without screw connection



1

GEV No.	541109	Ref. No.	65035031
description	Y-piece plastic hose ø 8-6-8mm for pressure switch		

fittings

double nipples



1

GEV No.	520663	Ref. No.	23217019
description	double nipple brass thread 3/8" - 3/8" Qty 1 pcs		
For models:	Classe10, Classe6, Classe8, Epoca1gr, Epoca2gr		

hose connectors

brass



1

GEV No.	513253	Ref. No.	65108006
description	hose connector brass angled thread 1/4" hose ø 12mm Qty 1 pcs		



water softeners

measuring devices



1

GEV No.	541474	Ref. No.	69000252
description	control strip water hardness (German) Qty 100 pcs		

ancillary products

clamps

hose clamps

DIN 3017 - W4



1

GEV No.	520120	Ref. No.	69000081
description	hose clamp SS W4 ø 12-20mm width 9mm Qty 1 pcs DIN 3017		
For models:	Millenium, S20, Z11		

double wire clamps



1

GEV No.	513268	Ref. No.	65423011
description	hose clamp ø 8-10mm wire gauge ø 1mm Qty 1 pcs		

measuring devices



1

GEV No.	541474	Ref. No.	69000252
description	control strip water hardness (German) Qty 100 pcs		

measuring equipment

thermometers

built-in thermometers



1

GEV No.	541095	Ref. No.	69000007
description	thermometer mounting measurements 58x25.5mm 0 up to +120°C capillary pipe 3000mm probe ø 6.5mm probe L 20mm		

fastening material

screws

flat-headed bolts



1

GEV No.	560354	Ref. No.	37030410
description	flat-headed bolt thread M4 thread L 10mm SS DIN 84/ISO 1207 Qty 1 pcs intake slotted head ø 7mm head thickness 2.5mm		
For models:	MD, Z11		



1

GEV No.	560353	Ref. No.	37030407
description	flat-headed bolt thread M4 thread L 7mm SS DIN 84/ISO 1207 Qty 1 pcs intake slotted head ø 7mm head thickness 2.5mm		
For models:	MD, Millenium, S20, S20NSF, Silvia, Z11		



1

GEV No.	560355	Ref. No.	37030510
description	flat-headed bolt thread M5 thread L 10mm SS DIN 84/ISO 1207 Qty 1 pcs intake slotted head ø 8.3mm head thickness 3.2mm		
For models:	MD		

hexagonal screws



1

GEV No.	560086	Ref. No.	377040610
description	hexagonal screw thread M6 thread L 10mm SS WS 10 Qty 20 pcs DIN 933 / ISO 4017		



1

GEV No.	510990	Ref. No.	37040820
description	hexagonal screw thread M8 thread L 20mm SS WS 13 Qty 1 pcs DIN 933 / ISO 4017		



1

GEV No.	550682	Ref. No.	37040821
description	hexagonal screw thread M8 thread L 20mm SS WS 13 Qty 1 pcs DIN 933 / ISO 4017		
For models:	Classe6, Classe8, Epoca1gr, Epoca2gr, Millenium, S20, S20NSF, Z11		



1

GEV No.	560351	Ref. No.	37030511 37030518 937030518
description	hexagonal screw thread M5 thread L 12mm SS WS 10 Qty 1 pcs		
For models:	Epoca1gr, MD, Millenium, S20, S20NSF, Z11		

cylinder head bolts

DIN 912/ISO 4762



1

GEV No.	560025	Ref. No.	37060413
description	cylinder head bolt thread M4 thread L 10mm WS 3 SS Qty 20 pcs DIN 912/ISO 4762		



1

GEV No.	560373	Ref. No.	37030412
description	cylinder head bolt thread M4 thread L 12mm WS 3 SS Qty 1 pcs intake internal hexagon DIN 912/ISO 4762		
For models:	Millenium, S20, S20NSF, Silvia, Z11		



1

GEV No.	527170	Ref. No.	37060608
description	cylinder head bolt thread M6 thread L 8mm WS 5 SS Qty 1 pcs DIN 912/ISO 4762		
For models:	Classe6, S20, S20NSF, Silvia, Z11		

grub screws

DIN 913/ISO 4026



1

GEV No.	560346	Ref. No.	32239044D8
description	grub screw thread M5 L 6mm SS DIN 913/ISO 4026 intake internal hexagon WS 2.5 Qty 20 pcs		

knurled screws



1

GEV No.	510112	Ref. No.	65454002
description	Thumb screw thread M10 thread L 10mm ø 22mm H 4.5mm SS		



1

GEV No.	506325	Ref. No.	25148004
description	Thumb screw thread M8 thread L 6mm D1 ø 13mm L 1.5mm ø 22mm H 2.5mm SS		

nuts

cap nuts



1

GEV No.	560136	Ref. No.	37370501
description	cap nuts thread M5 WS 8 SS Qty 20 pcs DIN/ISO DIN 1587		

hexagonal nuts

DIN 934 / ISO 4032/8673





1

GEV No.	560340	Ref. No.	37310400
description	hexagonal nut thread M4 H 3.2mm WS 7 SS DIN/ISO DIN 934 / ISO 4032/8673 Qty 1 pcs		
For models:	MD, S20NSF, Z11		





			
1			
GEV No.	560129	Ref. No.	37320501
description	hexagonal nut thread M5 H 4mm WS 8 SS DIN/ISO DIN 934 / ISO 4032/8673 Qty 1 pcs		
For models:	Z11		

			
1			
GEV No.	517174	Ref. No.	37320800
description	nut thread M8 H 6.5mm WS 13 SS DIN/ISO DIN 934 / ISO 4032/8673 Qty 1 pcs		
For models:	Classe6, Epoca1gr, MD, S20, S20NSF, Z11		

DIN 982 (self-locking, tall version)			
			
1			
GEV No.	560660	Ref. No.	37360501
description	hexagonal nut thread M5 H 5.4mm zinc-coated steel WS 8 Qty 20 pcs DIN/ISO DIN 982 self-locking		

hexagonal nuts metric (without norm)			
			
1			
GEV No.	521134	Ref. No.	65417017
description	hexagonal nut thread M14x1 SS		

hexagonal nuts inch thread			
			
1			
GEV No.	361184	Ref. No.	23225003
description	nut thread 1/2" H 6mm nickel-plated brass WS 24 Qty 1 pcs		
For models:	S20NSF, Z11		

			
1			
GEV No.	520232	Ref. No.	23242012
description	nut thread 1/4" H 5mm nickel-plated brass WS 47 Qty 1 pcs		

			
1			
GEV No.	506399	Ref. No.	23232005
description	nut thread 3/4" H 3mm WS 32 brass Qty 1 pcs		
For models:	Classe10, Classe6, Millenium, S20		

washers

spring rings

			
1			
GEV No.	560208	Ref. No.	37420800
description	lock washer ID ø 8.3mm ED ø 15mm SS Qty 1 pcs		
For models:	Classe6, Classe8, Epoca2gr, Millenium, S20, S20NSF, Z11		

washers

miscellaneous

			
1			
GEV No.	506326	Ref. No.	36930096
description	disc		

			
1			
GEV No.	529374	Ref. No.	12131005 23131005
description	plain washer ID ø 13mm ED ø 17.8mm thickness 0.5mm brass Qty 1 pcs		
For models:	Millenium, Z11		

			
1			
GEV No.	560352	Ref. No.	32259083
description	plain washer ID ø 7mm ED ø 10mm thickness 0.5mm stainless steel Qty 1 pcs		
For models:	Epoca1gr		

			
1			
GEV No.	560349	Ref. No.	32239044
description	plain washer ID ø 9.3mm ED ø 18.6mm thickness 1.2mm SS Qty 1 pcs		
For models:	S20, S20NSF, Z11		

			
1			
GEV No.	560350	Ref. No.	23123003
description	plain washer ID \varnothing 9.5mm ED \varnothing 13mm thickness 0.5mm brass for steam valve		
For models:	S20NSF		

			
1			
GEV No.	507015	Ref. No.	37510700
description	retaining ring E D1 \varnothing 7mm D2 \varnothing 14mm SS DIN 6799 thickness 0.9mm for shaft \varnothing 8-11mm		
For models:	S20, S20NSF, Z11		

fasteners

clamps

hose clamps

DIN 3017 - W4

			
1			
GEV No.	520120	Ref. No.	69000081
description	hose clamp SS W4 \varnothing 12-20mm width 9mm Qty 1 pcs DIN 3017		
For models:	Millenium, S20, Z11		

double wire clamps

			
1			
GEV No.	513268	Ref. No.	65423011
description	hose clamp \varnothing 8-10mm wire gauge \varnothing 1mm Qty 1 pcs		

retaining rings

DIN 6799

			
1			
GEV No.	528709	Ref. No.	37510400
description	retaining ring E D1 \varnothing 4mm D2 \varnothing 9mm steel DIN 6799 thickness 0.7mm for shaft \varnothing 5-7mm		
For models:	MD, S20NSF, Z11		

			
1			
GEV No.	516198	Ref. No.	37510600
description	retaining ring E D1 \varnothing 6mm D2 \varnothing 12mm SS DIN 6799 thickness 0.7mm for shaft \varnothing 7-9mm		
For models:	MD, S20, S20NSF, Z11		

consumables

fuses

fine fuses

			
1			
GEV No.	358669	Ref. No.	34200169
description	fine fuse size \varnothing 5x20mm 0.63A fast-acting rated 250V Qty 10 pcs		
For models:	S20, S20NSF, Z11		

			
1			
GEV No.	358677	Ref. No.	65228004
description	fine fuse size \varnothing 5x20mm 4A fast-acting rated 250V Qty 10 pcs		

			
1			
GEV No.	358533	Ref. No.	34200167
description	fine fuse size \varnothing 5x20mm 6.3A fast-acting rated 250V Qty 10 pcs		
For models:	S20, S20NSF, Z11		

			
1			
GEV No.	358599	Ref. No.	34200170
description	fine fuse size \varnothing 5x20mm 0.8A slow-acting rated 250V Qty 10 pcs		
For models:	S20, S20NSF, Z11		

fine fuse holders

			
1			
GEV No.	358011	Ref. No.	38123598
description	fuse holder suitable fuse \varnothing 5x20mm L 35mm W 23mm H 11mm		
For models:	Classe10, Classe6, Classe8, Epoca2gr		

B			
bi-metal thermostats	7, 7	hose couplings	89
booster pumps I	38	hoses	89
booster pumps II	38	hoses wire reinforced	90
C		I	
cables	41	ignition switches	42
cam switches	14	immersion heating elements	4
cap nuts	94	indicator lights	16
clamps	93, 96	indicator lights (complete)	16
compressors	31	industrial hoses	90
condensators & interference suppression filters	40	K	
consumables	96	knurled screws	94
contactors	18	L	
container filters	89	lamps	16
control thermostats	8, 8	LED	17
cylinder head bolts	94	M	
D		magnetic switches	15
door seals for dishwashers	82	measuring devices	93, 93
dosing pumps	86	measuring equipment	93
double nipples	92	microswitches	13
double wire clamps	93, 96	motors	32
drain hoses	90	N	
drain pumps	38	nuts	94
E		O	
electric accessories	41	operating capacitors	40
electrodes	30	O-rings	77
F		P	
fans	32	plunger sockets	10
fasteners	96	pressure control hoses	90
fastening material	93	pressure switches	29
fine fuses	96	probe clips	10
fittings	92	probes	21
flat-headed bolts	93	programme timers	17
flow meters	31	pumps	32
formed hoses	91	pumps for ice machines	39
fuses	40, 96	push/momentary push switches	12
G		PVC hoses	90
gaskets for wash arm support	84	PVC supply hoses	89
grub screws	94	R	
H		refrigeration fans	32
heating elements	3	refrigeration motors universal	32
heating elements for coffee machine	3	refrigeration thermostats	10
hexagonal nuts	94	relays	19
hexagonal screws	93	retaining rings	96
hose clamps	93, 96	ribbon cables	41
hose connectors	92, 92	rocker/momentary rocker switches	10

rotary switches 15

S

safety bi-metal thermostats 7

safety thermostats 8

screws 93

sealing discs 83

sealing washers 79

solenoid valves 25

spring clips 10

spring rings 95

supply hoses 89

switches and momentary switches 10

system switches (ROLD) 14

T

tank inlets 89

terminals 41

thermostats 7

timers 17

transformers 21

V

ventilation hoses 92

W

wash and rinse pumps 32

washers 95

water softeners 93