



**GAS COMPONENTS**



**ELECTRIC COMPONENTS**



**WATER TECHNOLOGY**



**MECHANICAL COMPONENTS**



**TOOLS**

Spare parts suitable for

**RATIONAL**

Find the complete and up-to-date range of products in our GEV Webshop



# Manufacturer catalogue

The most important spare parts and accessories arranged clearly for every manufacturer

- ✓ Complete product range and all appliance data always up to date in the GEV Webshop
- ✓ Alphabetical Index at the end of the catalogue

## GEV Webshop

[www.gev-online.co.uk](http://www.gev-online.co.uk)

[www.gev-online.com](http://www.gev-online.com)



- 🔍 Add to Favourites
- 🔍 Sign In with email address and usual password
- 🔍 Easy-order – place several items in your basket at the same time
- 🔍 Quick Item search – no login needed



# heating elements

## immersion heating elements

with expansion flange 70 x 18mm



<b>GEV No.</b>	417684	<b>Ref. No.</b>	3004.3506 3004.4103 3004.4107 3004.4113 3004.4146 3004.4306
<b>description</b>	heating element 3000W 230V heating circuits 2 flange 70x18mm L 365mm W 65mm connection male faston 6.3mm tube ø 8.5mm immersion heater expansion flange		
<b>For models:</b>	CC6, CD20		



<b>GEV No.</b>	417685	<b>Ref. No.</b>	3004.3509 3004.3535 3004.4142 3004.4303
<b>description</b>	heating element 3000W 400V heating circuits 2 flange 70x18mm L 365mm W 64mm connection male faston 6.3mm tube ø 8.5mm immersion heater expansion flange		
<b>For models:</b>	CM20-3NAC380V50Hz, CM20-3NAC400V50Hz		



<b>GEV No.</b>	417672	<b>Ref. No.</b>	3004.3516 3004.4105 3004.4108 3004.4114 3004.4121 3004.4307
<b>description</b>	heating element 6000W 230V flange 70x18mm L 355mm		
<b>For models:</b>	CC6, CD101, CD20, CD201, CM201		



<b>GEV No.</b>	417687	<b>Ref. No.</b>	3004.3405 3004.3505 3004.3523 3004.4102 3004.4106 3004.4112 3004.4136 3004.4305
<b>description</b>	heating element 6000W 230V heating circuits 2 flange 70x18mm L 365mm W 65mm connection male faston 6.3mm tube ø 8.5mm immersion heater expansion flange connection length 32mm		
<b>For models:</b>	CD101, CD20, CD201, CM101, CM201		



<b>GEV No.</b>	417699	<b>Ref. No.</b>	3004.4155 3004.4156 3004.4162 3004.4163
<b>description</b>	heating element 6000W 230V heating circuits 2 flange 70x18mm L 375mm W 65mm connection male faston 6.3mm tube ø 8.5mm immersion heater expansion flange thermostat sleeves ø 2.5mm length thermostat sleeves 105mm number of thermostat sleeves 1		
<b>For models:</b>	CC6, CD101, CD201		



<b>GEV No.</b>	417673	<b>Ref. No.</b>	3004.3518 3004.4304
<b>description</b>	heating element 6000W 400V flange 70x18mm number of thermostat sleeves 1		
<b>For models:</b>	CC101, CC201, CM101, CM201		



<b>GEV No.</b>	417686	<b>Ref. No.</b>	3004.3508 3004.4135 3004.4302
<b>description</b>	heating element 6000W 400V heating circuits 2 flange 70x18mm L 365mm W 65mm connection male faston 6.3mm tube ø 8.5mm immersion heater expansion flange		
<b>For models:</b>	CC101, CC201, CM101, CM201		



<b>GEV No.</b>	417688	<b>Ref. No.</b>	3004.4157 3004.4158 3004.4164 3004.4165
<b>description</b>	heating element 6000W 400V heating circuits 2 flange 70x18mm L 370mm W 65mm connection male faston 6.3mm tube ø 8.5mm immersion heater expansion flange thermostat sleeves ø 3mm length thermostat sleeves 134mm number of thermostat sleeves 1		
<b>For models:</b>	CC101, CC201, CM101, CM201		



<b>GEV No.</b>	418639	<b>Ref. No.</b>	3004.4159
<b>description</b>	heating element 6000W 440V heating circuits 2 flange 70x18mm L 370mm W 68mm connection male faston 6.3mm tube ø 8.5mm immersion heater expansion flange thermostat sleeves ø 2.5mm length thermostat sleeves 115mm thermostat sleeve clinging number of thermostat sleeves 1		



## special flanges



1

<b>GEV No.</b>	420519	<b>Ref. No.</b>	44.01.378 4401336 4401340 87.01.016
<b>description</b>	heating element 18000W 230/400V heating circuits 1 L 188mm W 66mm flange length 123mm flange width 102mm connection cable included cable length 850mm boiler		

## miscellaneous



1

<b>GEV No.</b>	417678	<b>Ref. No.</b>	44.00.195 44.00.533 87.00.367
<b>description</b>	heating element 18000W 230V heating circuits 6 L 194mm W 87mm H 68mm hole distance 50mm hole ø 8mm number of thermostat sleeves 2 thermostat sleeves ø 6/2mm length thermostat sleeves 142/105mm thermostat sleeve clinging cable length 730mm immersion heater 10 hole flange		
<b>For models:</b>	CM102, CM201, CM202, CM62, SCC102, SCC201, SCC202, SCC62		



1

<b>GEV No.</b>	417709 <sup>1</sup>	<b>Ref. No.</b>	44.00.291 87.00.370	
<b>description</b>	heating element 9000W 208V heating circuits 3 L 192mm W 39mm H 68mm number of thermostat sleeves 2 thermostat sleeves ø 3/7.5mm length thermostat sleeves 142/102mm thermostat sleeve eccentric, clinging tube ø 6.5mm hole distance 65mm hole ø 8mm cable length 620mm connection length 28mm connection male faston 6.3mm 5 hole flange immersion heater flange width 82mm flange length 82mm incl. gasket			
<b>For models:</b>	CM101, CM61, SCC101, SCC61			
<b>spare parts for</b>	417709			
	<b>GEV No.</b>	512485	<b>Ref. No.</b>	40.00.280 44.00.280
	gasket L 81mm W 81mm hole distance 65mm thickness 4mm for heating element suitable for RATIONAL equiv. no. 4400280			

<sup>1</sup>with gasket

1

<b>GEV No.</b>	417694	<b>Ref. No.</b>	44.00.194 44.00.534 87.00.366
<b>description</b>	heating element 9000W 230V heating circuits 3 L 192mm W 39mm H 68mm hole distance 90mm hole ø 8mm thermostat sleeves ø 2.5/6.5mm length thermostat sleeves 155mm number of thermostat sleeves 2 thermostat sleeve eccentric, clinging flange length 82mm flange width 82mm tube ø 6.5mm cable length 200mm immersion heater 5 hole flange		
<b>For models:</b>	CM101, CM61, SCC101, SCC202, SCC61		



1

<b>GEV No.</b>	417714	<b>Ref. No.</b>	44.00.292 87.00.371	
<b>description</b>	heating element 9000W 230V heating circuits 3 L 193mm W 39mm H 69mm hole distance 65mm hole ø 8mm thermostat sleeves ø 3/7.5mm length thermostat sleeves 142/102mm number of thermostat sleeves 2 thermostat sleeve eccentric, clinging flange length 82mm flange width 82mm tube ø 6.5mm for combi-steamer			
<b>For models:</b>	CM101, CM61, SCC101, SCC61			
<b>accessories for</b>	417714			
	<b>GEV No.</b>	550893	<b>Ref. No.</b>	—
	gasket L 81mm W 81mm hole distance 65mm thickness 4mm for heating element suitable for RATIONAL equiv. no. 4400280			





1



<b>GEV No.</b>	417695	<b>Ref. No.</b>	3201.1000 3201.1004 3201.1008 3201.1009 8720.1590	
<b>description</b>	heating element 9000W 230V heating circuits 3 L 205mm W 38mm H 70mm number of thermostat sleeves 1 thermostat sleeves ø 2.5mm length thermostat sleeves 120mm thermostat sleeve eccentric, clinging tube ø 6.3mm hole distance 64mm hole ø 8mm connection male faston 6.3mm 4 hole flange immersion heater flange width 82mm flange length 82mm			
<b>For models:</b>	CCC101, CCC201, CCC202, CCC61, CCD101, CCD201, CCD202, CCD61, CCM101, CCM201, CCM202, CCM61, CD101, CD102, CD201, CD202, CD61, CM101, CM102, CM201, CM202, CM61, CPC101, CPC102, CPC201, CPC202, CPC61			
<b>accessories for</b>	417695			
	<b>GEV No.</b>	512482	<b>Ref. No.</b>	5110.1003
	gasket rubber L 82mm W 82mm thickness 4mm hole ø 9mm hole distance 64mm for heating element suitable for RATIONAL 4 holes			







			
1			
<b>GEV No.</b>	417696	<b>Ref. No.</b>	3201.1200 3201.1205 3201.1206 3201.1210
<b>description</b>	heating element 9000W 230V heating circuits 3 L 232mm W 76mm H 38mm number of thermostat sleeves 1 thermostat sleeves ø 2.5mm length thermostat sleeves 235mm thermostat sleeve eccentric, clinging tube ø 6.5mm hole distance 64mm hole ø 8mm connection length 41mm connection male faston 6.3mm rectangular flange immersion heater flange width 72mm flange length 82mm		
<b>For models:</b>	CCC101, CCC102, CCC61, CCD101, CCD102, CCD61, CCM101, CCM102, CCM61		

			
1			
<b>GEV No.</b>	417646	<b>Ref. No.</b>	44.01.333 44.01.337 87.01.011 87.01.012
<b>description</b>	heating element 9000W 400V L 195mm W 40mm H 80mm number of thermostat sleeves 1 thermostat sleeves ø 6mm length thermostat sleeves 132mm tube ø 6mm hole distance 61mm hole ø 7.5mm cable length 60mm combi-steamer flange width 82mm flange length 82mm with gasket with thermowell		

			
1			
<b>GEV No.</b>	417710 <sup>1</sup>	<b>Ref. No.</b>	87.00.372
<b>description</b>	heating element 9000W 255/440V heating circuits 3 L 192mm W 39mm H 68mm number of thermostat sleeves 2 thermostat sleeves ø 3/7.5mm length thermostat sleeves 138/102mm thermostat sleeve eccentric, clinging tube ø 6.5mm hole distance 65mm hole ø 8mm cable length 620mm connection length 28mm connection male faston 6.3mm 5 hole flange immersion heater flange width 82mm flange length 82mm incl. gasket		
<b>spare parts for</b>	417710		
		<b>GEV No.</b>	512485
		<b>Ref. No.</b>	40.00.280 44.00.280
	gasket L 81mm W 81mm hole distance 65mm thickness 4mm for heating element suitable for RATIONAL equiv. no. 4400280		

<sup>1</sup>with gasket

			
1			
<b>GEV No.</b>	417711	<b>Ref. No.</b>	3201.1006 8720.1592
<b>description</b>	heating element 9000W 255V heating circuits 3 L 204mm W 38mm H 75mm number of thermostat sleeves 1 thermostat sleeves ø 3mm length thermostat sleeves 102mm thermostat sleeve eccentric, clinging tube ø 6.5mm hole distance 65mm hole ø 8mm connection length 38mm connection male faston 6.3mm rectangular flange immersion heater flange width 82mm flange length 82mm		
<b>For models:</b>	CD101, CD102, CD201, CD202, CD61, CM101, CM102, CM201, CM202, CM61, CPC101, CPC102, CPC201, CPC202, CPC61		
<b>spare parts for</b>	417711		
		<b>GEV No.</b>	512485
		<b>Ref. No.</b>	40.00.280 44.00.280
	gasket L 81mm W 81mm hole distance 65mm thickness 4mm for heating element suitable for RATIONAL equiv. no. 4400280		

			
1			
<b>GEV No.</b>	415364	<b>Ref. No.</b>	3004.2800
<b>description</b>	heating element 7500W 230/400V heating circuits 3 thread 1½" L 481mm W 36mm H 36mm thermostat sleeves ø 7mm length thermostat sleeves 145mm thermostat sleeve eccentric, clinging tube ø 8.5mm connection M4 immersion heater connection length 25mm flange with thread WS 59		
<b>For models:</b>	CD101, CD20, CD201		

heating elements for convection

			
1			
<b>GEV No.</b>	693548	<b>Ref. No.</b>	2150.1005
<b>description</b>	flange suitable for convection heating element W 23mm mounting pos. outer length 210		
<b>For models:</b>	CCC101, CCC102, CCC201, CCC202, CCC61, CCD101, CCD102, CCD201, CCD202, CCD61, CCM101, CCM102, CCM201, CCM202, CCM61		

			
1			
<b>GEV No.</b>	693546	<b>Ref. No.</b>	2150.1250
<b>description</b>	flange suitable for convection heating element W 47mm mounting pos. outer length 210		
<b>For models:</b>	CD61, CM61, CPC61		



1

<b>GEV No.</b>	417670	<b>Ref. No.</b>	3200.1002 8720.1596
<b>description</b>	heating element 15000W 230V heating circuits 6 ID ø 505mm ED ø 517mm L 620mm H 195mm W1 155mm H1 27mm H2 168mm flange length 210mm flange width 25mm		
<b>For models:</b>	CCC102, CCC202, CCD102, CCD202, CCM102, CCM202, CD102, CD202, CM102, CM202, CPC102, CPC202		





1

<b>GEV No.</b>	417676	<b>Ref. No.</b>	40.00.265 87.00.396
<b>description</b>	heating element 18000W 230V heating circuits 3 ID ø 410mm ED ø 477mm L 477mm H 110mm W1 110mm H1 20mm H2 90mm flange length 140mm flange width 62mm hole distance 64mm connection cable connection length 70mm tube ø 6.3mm convection heating element		
<b>For models:</b>	CM101, SCC101, SCC202		



1

<b>GEV No.</b>	417675	<b>Ref. No.</b>	3200.1003 3200.1017 8720.1597 8720.1609
<b>description</b>	heating element 15000W 230V heating circuits 6 ID ø 635mm ED ø 650mm L 696mm H 200mm L1 23mm W1 156mm H1 35mm H2 165mm flange length 210mm flange width 24mm hole distance 31mm connection male faston 6.3mm connection length 80mm tube ø 6.3mm convection heating element hole ø 7mm mounting pos. outer rectangular flange		
<b>For models:</b>	CCC102, CCC202, CCD102, CCD202, CCM102, CCM202, CD102, CD202, CM102, CM202, CPC102, CPC202		
<b>spare parts for</b>	417675		
	<b>GEV No.</b>	512484	<b>Ref. No.</b> 5110.1009
	gasket L 210mm W 24mm thickness 2mm for heating element		



1

<b>GEV No.</b>	417671	<b>Ref. No.</b>	3004.3519 3004.3538 3004.4333
<b>description</b>	heating element 18000W 230V heating circuits 6 ID ø 385mm ED ø 440mm L 460mm H 140mm L1 20mm W1 163mm H1 30mm H2 110mm thread M14x1.5 12 hole fixing connection male faston 6.3mm tube ø 6.3mm convection heating element		
<b>For models:</b>	CD101, CD201		



1

<b>GEV No.</b>	418381	<b>Ref. No.</b>	40.00.596 40.02.588 87.00.407
<b>description</b>	heating element 18000W 230V		
<b>For models:</b>	CM201, SCC201		





1

<b>GEV No.</b>	417677	<b>Ref. No.</b>	40.00.597 87.00.404
<b>description</b>	heating element 18000W 230V heating circuits 6 ID ø 407mm ED ø 485mm L 485mm H 106mm W1 111mm H1 11mm H2 85mm flange length 140mm flange width 72mm hole distance 128mm connection cable connection length 98mm tube ø 6.6mm cable length 600mm convection heating element hole ø 5mm rectangular flange L1 485mm		
<b>For models:</b>	CM201, SCC201		





			
1			
<b>GEV No.</b>	418380	<b>Ref. No.</b>	40.00.075 87.00.383
<b>description</b>	heating element 18000W 230V heating circuits 6 ID ø 415mm ED ø 480mm L 480mm H 110mm W1 111mm H1 10mm H2 100mm flange length 140mm flange width 61mm hole distance 65mm tube ø 6.3mm		
<b>For models:</b>	CM101, SCC101		

			
1			
<b>GEV No.</b>	417683	<b>Ref. No.</b>	40.00.267 87.00.397
<b>description</b>	heating element 30000W 230V heating circuits 6 ID ø 573mm ED ø 630mm L 655mm H 120mm W1 135mm H1 15mm H2 110mm flange length 160mm flange width 75mm hole distance 74mm connection cable connection length 95mm tube ø 8.5mm cable length 600mm convection heating element hole ø 6mm rectangular flange L1 8mm		
<b>For models:</b>	CM102, CM202, SCC102, SCC202		
<b>accessories for</b>	417683		
		<b>GEV No.</b>	560611 <b>Ref. No.</b> 40.00.331
	gasket L 160mm W 75mm for heating element thickness 2mm hole distance 74mm SCC Linie 102/202		

			
1			
<b>GEV No.</b>	417674	<b>Ref. No.</b>	3004.3520 3004.3521 3004.4336 3004.4339
<b>description</b>	heating element 18000W 400V heating circuits 6 thread M14x1.5 12 hole fixing connection male faston 6.3mm convection heating element		
<b>For models:</b>	CC101, CC201, CM101, CM201		

			
1			
<b>GEV No.</b>	418377	<b>Ref. No.</b>	40.00.271 87.00.400
<b>description</b>	heating element 6000W 230V heating circuits 3 ID ø 404mm ED ø 420mm L 440mm H 107mm W1 112mm H1 20mm H2 84mm flange length 140mm flange width 61mm hole distance 65mm connection cable tube ø 6.5mm cable length 300mm convection heating element hole ø 5.5mm rectangular flange L1 7mm		
<b>For models:</b>	CM102, SCC102		

			
1			
<b>GEV No.</b>	418379	<b>Ref. No.</b>	40.00.113
<b>description</b>	heating element 20000W 230V		
<b>For models:</b>	CM62, SCC62		

			
1			
<b>GEV No.</b>	417689	<b>Ref. No.</b>	3004.3529 3004.3537
<b>description</b>	heating element 9000W 230V heating circuits 3 ID ø 385mm ED ø 400mm L 420mm H 125mm L1 20mm W1 160mm H1 20mm H2 105mm thread M14x1.5 6 hole fixing connection male faston 6.3mm tube ø 6.3mm mounting pos. inner convection heating element		
<b>For models:</b>	CD101, CD201		

			
1			
<b>GEV No.</b>	418375	<b>Ref. No.</b>	40.00.263 87.00.395
<b>description</b>	heating element 20000W 400V heating circuits 3 ID ø 410mm ED ø 470mm L 480mm H 125mm W1 110mm H1 15mm H2 110mm flange length 140mm flange width 65mm hole distance 65mm connection cable tube ø 6.5mm cable length 30mm convection heating element hole ø 5mm rectangular flange L1 8mm		
<b>For models:</b>	CM62, SCC62		



1

<b>GEV No.</b>	417690	<b>Ref. No.</b>	40.00.261 87.00.394
<b>description</b>	heating element 9000W 230V heating circuits 3 ID ø 407mm ED ø 420mm L 443mm H 105mm W1 107mm H1 21mm H2 88mm flange length 140mm flange width 62mm hole distance 65mm connection cable connection length 90mm tube ø 6.5mm cable length 270mm convection heating element hole ø 5mm rectangular flange L1 6mm		
<b>For models:</b>	CM61, SCC61		



1

<b>GEV No.</b>	418378	<b>Ref. No.</b>	40.00.077 87.00.384
<b>description</b>	heating element 9000W 230V heating circuits 3 ID ø 410mm ED ø 420mm L 435mm H 108mm W1 106mm H1 15mm H2 93mm flange length 140mm flange width 60mm hole distance 65mm tube ø 6.5mm hole ø 6mm		
<b>For models:</b>	CM61, SCC61		



1

<b>GEV No.</b>	417691	<b>Ref. No.</b>	3004.3528
<b>description</b>	heating element 9000W 230V heating circuits 3 ID ø 440mm ED ø 453mm L 470mm H 140mm L1 20mm W1 163mm H1 30mm H2 110mm thread M14x1.5 screw mounting connection male faston 6.3mm tube ø 6.5mm mounting pos. outer convection heating element		
<b>For models:</b>	CD101, CD201		



1

<b>GEV No.</b>	417692	<b>Ref. No.</b>	3200.1000 8720.1594
<b>description</b>	heating element 9000W 230V heating circuits 3 ID ø 445mm ED ø 458mm L 474mm H 130mm W1 156mm H1 33mm H2 97mm flange length 210mm flange width 25mm hole distance 31mm connection male faston 6.3mm connection length 80mm tube ø 6.5mm dry heating element hole ø 7.5mm mounting pos. inner rectangular flange		
<b>For models:</b>	CCC101, CCC201, CCC61, CCD101, CCD201, CCD61, CCM101, CCM201, CCM61, CD101, CD201, CD61, CM101, CM201, CM61, CPC101, CPC201, CPC61		
<b>accessories for</b>	417692		
	<b>GEV No.</b>	512484	<b>Ref. No.</b> 5110.1009
	gasket L 210mm W 24mm thickness 2mm for heating element		



1

<b>GEV No.</b>	417693	<b>Ref. No.</b>	3200.1001 8720.1595
<b>description</b>	heating element 9000W 230V heating circuits 3 ID ø 504mm ED ø 516mm L 535mm H 130mm W1 156mm H1 35mm H2 95mm flange length 210mm flange width 25mm hole distance 31mm connection male faston 6.3mm connection length 80mm tube ø 6.5mm dry heating element hole ø 7.5mm mounting pos. outer rectangular flange L1 19mm		
<b>For models:</b>	CCC101, CCC201, CCD101, CCD201, CCM101, CCM201, CD101, CD201, CM101, CM201, CPC101, CPC201		



1

<b>GEV No.</b>	417697	<b>Ref. No.</b>	3004.3507 3004.3524
<b>description</b>	heating element 9000W 230V heating circuits 4 ID ø 310mm ED ø 333mm L 410mm H 115mm L1 77mm W1 75mm H1 15mm H2 100mm thread M14x1.5 8 hole fixing connection male faston 6.3mm tube ø 8.5mm convection heating element		
<b>For models:</b>	CC6		

1

<b>GEV No.</b>	417698	<b>Ref. No.</b>	3004.3531 3004.3533
<b>description</b>	heating element 9000W 400V heating circuits 3 ID ø 385mm ED ø 400mm L 402mm H 112mm L1 30mm W1 170mm H1 15mm H2 107mm thread M14x1.5 6 hole fixing connection male faston 6.3mm tube ø 6.5mm mounting pos. inner convection heating element		
<b>For models:</b>	CC101, CC201, CM101, CM201		



1

<b>GEV No.</b>	415239	<b>Ref. No.</b>	3004.3530
<b>description</b>	heating element 9000W 400V heating circuits 3 ID ø 440mm ED ø 453mm L 465mm H 140mm L1 15mm W1 150mm H1 30mm H2 110mm thread M14x1.5 6 hole fixing connection male faston 6.3mm tube ø 6.3mm mounting pos. outer convection heating element		
<b>For models:</b>	CC101, CC201, CM101, CM201		
<b>accessories for</b>	415239		
	<b>GEV No.</b>	<b>Ref. No.</b>	—
	510417		
	flat gasket fibre ED ø 20mm ID ø 14mm thickness 2mm Qty 1 pcs		
	<b>GEV No.</b>	<b>Ref. No.</b>	3004.1405
	520228		
	tooth lock washer ID ø 15.3mm ED ø 24mm steel Qty 1 pcs for thread M14		
	<b>GEV No.</b>	<b>Ref. No.</b>	3004.1406
	520230		
	nut thread M14x1.5 H 5mm WS 19 zinc-coated steel Qty 1 pcs		
	<b>GEV No.</b>	<b>Ref. No.</b>	—
	521101		
	nut thread M14x1.5 H 5mm WS 19 SS Qty 1 pcs		
	<b>GEV No.</b>	<b>Ref. No.</b>	—
	550262		
	flat gasket copper ED ø 20mm ID ø 14mm thickness 2mm		







1

<b>GEV No.</b>	417679	<b>Ref. No.</b>	3004.1403 3004.1411 3004.4100 3004.4110
<b>description</b>	heating element 2000W 220V heating circuits 1 L 95mm W 520mm connection length 24mm connection male faston 6.3mm tube ø 6.3mm thread M14x1.5 2 hole fixing convection heating element mounting distance 514mm		
<b>For models:</b>	CD101, CD201, CM101, CM201		



1

<b>GEV No.</b>	415556	<b>Ref. No.</b>	3004.1407 3004.4300
<b>description</b>	heating element 2000W 400V heating circuits 1 L 85mm W 530mm connection male faston 6.3mm tube ø 6.5mm thread M14x1.5 2 hole fixing convection heating element mounting distance 525mm		
<b>accessories for</b>	415556		
	<b>GEV No.</b>	<b>Ref. No.</b>	3004.1405
	520228		
	tooth lock washer ID ø 15.3mm ED ø 24mm steel Qty 1 pcs for thread M14		
	<b>GEV No.</b>	<b>Ref. No.</b>	3004.1406
	520230		
	nut thread M14x1.5 H 5mm WS 19 zinc-coated steel Qty 1 pcs		
	<b>GEV No.</b>	<b>Ref. No.</b>	—
	521101		
	nut thread M14x1.5 H 5mm WS 19 SS Qty 1 pcs		
	<b>GEV No.</b>	<b>Ref. No.</b>	—
	550262		
	flat gasket copper ED ø 20mm ID ø 14mm thickness 2mm		



1

<b>GEV No.</b>	417681	<b>Ref. No.</b>	3004.1001 3004.1004 3004.4101 3004.4111 3004.4313
<b>description</b>	heating element 2500W 230V heating circuits 1 L 148mm W 534mm connection male faston 6.3mm tube ø 6.3mm thread M14x1.5 2 hole fixing convection heating element mounting distance 528mm		
<b>For models:</b>	CD20		



1

<b>GEV No.</b>	417682	<b>Ref. No.</b>	3004.4301 3004.4308 3004.4314 3004.4315
<b>description</b>	heating element 2500W 400V heating circuits 1 L 148mm W 545mm connection male faston 6.3mm tube ø 6.3mm thread M14x1.5 2 hole fixing convection heating element mounting distance 539mm		
<b>For models:</b>	CM20-3NAC380V50Hz, CM20-3NAC400V50Hz		



## thermostats

### bi-metal thermostats

#### bi-metal thermostats



<b>GEV No.</b>	375160	<b>Ref. No.</b>	3014.0325
<b>description</b>	bi-metal thermostat hole distance mm switch-off temp. 110°C 1NC 1-pole 16A connection F6.3 M4		
<b>For models:</b>	CD101, CM101, CM102, CM201, CM202, CM61, CPC101, CPC102, CPC201, CPC202, CPC61		

### control and safety thermostats

#### EGO

#### control thermostats

#### 55.13\_ series



<b>GEV No.</b>	375086	<b>Ref. No.</b>	3014.0314
<b>description</b>	thermostat t.max. 180°C temperature range 60-180°C 1-pole 1CO 16A probe ø 6mm probe L 90mm capillary pipe 2400mm capillary pipe isolated 2300mm gland nut shaft ø 6x4.6mm shaft L 25mm shaft position upper rotation 270° probe material SS		



<b>GEV No.</b>	375401	<b>Ref. No.</b>	30140314
<b>description</b>	thermostat t.max. 185°C temperature range 97-185°C 1-pole 1NO 16A probe ø 6mm probe L 87mm capillary pipe 1430mm capillary pipe isolated 1100mm gland nut M9x1 shaft ø 6x4.6mm shaft L 23mm shaft position upper rotation 270°		
<b>For models:</b>	CCD101, CCD102, CCD201, CCD202, CCD61, CD101, CD20, CD201		



<b>GEV No.</b>	375087	<b>Ref. No.</b>	3014.0311
<b>description</b>	thermostat t.max. 300°C temperature range 50-300°C 1-pole 1CO 16A probe ø 3.03mm probe L 160mm capillary pipe 1130mm capillary pipe isolated 1103mm gland nut shaft L 23mm shaft position upper rotation 270°		
<b>For models:</b>	CD101, CD20, CD201, CM101		



<b>GEV No.</b>	375066	<b>Ref. No.</b>	3014.0166
<b>description</b>	thermostat t.max. 300°C temperature range 60-300°C 1-pole 1CO 16A probe ø 4mm probe L 98mm capillary pipe 1450mm capillary pipe isolated mm gland nut shaft ø 6x4.6mm shaft L 25mm shaft position upper special probe		
<b>For models:</b>	CCD101, CCD102, CCD201, CCD202, CCD61, CD101, CD102, CD201, CD202, CD61		



<b>GEV No.</b>	375088	<b>Ref. No.</b>	3014.0318
<b>description</b>	thermostat t.max. 300°C temperature range 60-300°C 1-pole 1NO 16A probe ø 4mm probe L 100mm capillary pipe 830mm capillary pipe isolated 800mm gland nut shaft L 15mm shaft position upper rotation 270°		
<b>For models:</b>	CD101, CD20, CD201		



**E·G·O**



1

<b>GEV No.</b>	375085	<b>Ref. No.</b>	3014.0312
<b>description</b>	thermostat t.max. 90°C temperature range 0-90°C 1-pole 1CO 16A probe ø 3.1mm probe L 247mm capillary pipe 1430mm capillary pipe isolated 1400mm gland nut shaft ø 6x4.6mm shaft L 18mm shaft position upper probe material SS		
<b>For models:</b>	CCD101, CCD102, CCD201, CCD202, CCD61, CD101, CD102, CD20, CD201, CD202, CD61, CM101, CM201		

55.12\_ series

**E·G·O**



1

<b>GEV No.</b>	375084	<b>Ref. No.</b>	3014.0300 3014.0328
<b>description</b>	safety thermostat switch-off temp. 135°C 1-pole 10A probe ø 6mm probe L 83mm capillary pipe 1440mm capillary pipe isolated 1360mm gland nut probe SS		

safety thermostats

51\_ series

**E·G·O**



1

<b>GEV No.</b>	375074	<b>Ref. No.</b>	3014.0322
<b>description</b>	safety thermostat switch-off temp. 365°C 2-pole 16A probe ø 4mm probe L 116mm capillary pipe 1170mm capillary pipe isolated 1100mm gland nut probe with special screwing screw connection M14x1		
<b>For models:</b>	CCC101, CCC102, CCC201, CCC202, CCC61, CCD101, CCD102, CCD201, CCD202, CCD61, CCM101, CCM102, CCM201, CCM202, CCM61, CM101, CM102, CM201, CM202, CM61, CPC101, CPC102, CPC201, CPC202, CPC61		

**E·G·O**



1

<b>GEV No.</b>	375776	<b>Ref. No.</b>	3014.0300 3014.0328
<b>description</b>	safety thermostat switch-off temp. 135°C 1-pole 10A probe ø 6mm probe L 87mm capillary pipe 1440mm capillary pipe isolated 1400mm gland nut probe SS		
<b>For models:</b>	CC101, CC201, CC6, CCC101, CCC102, CCC201, CCC202, CCC61, CCD101, CCD102, CCD201, CCD202, CCD61, CCM101, CCM102, CCM201, CCM202, CCM61, CD61, CM101, CM102, CM201, CM202, CM61, CM62, CPC101, CPC102, CPC201, CPC202, CPC61, SCC101, SCC102, SCC201, SCC202, SCC61, SCC62		

**E·G·O**



1

<b>GEV No.</b>	375090	<b>Ref. No.</b>	3014.0310 3014.0316
<b>description</b>	safety thermostat switch-off temp. 365°C 2-pole 16A probe ø 4mm probe L 120mm capillary pipe 1170mm capillary pipe isolated 1100mm gland nut probe SS		
<b>For models:</b>	CC101, CC201, CC6, CD101, CD20, CD201, CM101, CM201, CM62		

**E·G·O**



1

<b>GEV No.</b>	375775	<b>Ref. No.</b>	40.01.329
<b>description</b>	safety thermostat switch-off temp. 160°C 1-pole 10A probe ø 6mm probe L 87mm capillary pipe 1440mm capillary pipe isolated 1400mm gland nut probe		

55.32\_ series



<b>GEV No.</b>	375984	<b>Ref. No.</b>	40.00.673
<b>description</b>	safety thermostat switch-off temp. 225°C 3-pole 3NC 20A probe ø 6mm probe L 94mm capillary pipe 900mm capillary pipe isolated 670mm gland nut M10x1 probe SS		



<b>GEV No.</b>	375890	<b>Ref. No.</b>	40.00.638
<b>description</b>	safety thermostat switch-off temp. 650°C 3-pole starting temperature 624°C		

56.\_ series



<b>GEV No.</b>	390797	<b>Ref. No.</b>	40.02.515
<b>description</b>	safety thermostat switch-off temp. 157°C 1-pole 16A probe ø 6mm probe L 62mm capillary pipe 1520mm capillary pipe isolated 1380mm gland nut probe		
<b>For models:</b>	CM101, CM102, CM201, CM202, CM61, CM62, SCC101, SCC102, SCC201, SCC202, SCC61, SCC62		

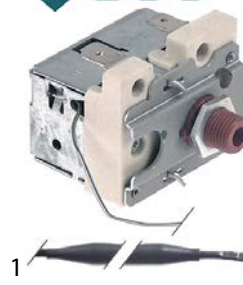

<b>GEV No.</b>	375862	<b>Ref. No.</b>	40.01.329
<b>description</b>	safety thermostat switch-off temp. 183°C 1-pole 16A probe ø 6mm probe L 61mm capillary pipe 1460mm capillary pipe isolated 1400mm gland nut probe SS		
<b>For models:</b>	CM101, CM102, CM201, CM202, CM61, CM62, SCC101, SCC102, SCC201, SCC202, SCC61, SCC62		

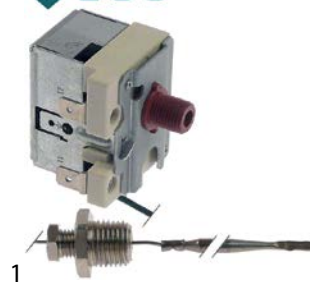

<b>GEV No.</b>	390977	<b>Ref. No.</b>	3014.0324
<b>description</b>	safety thermostat switch-off temp. 360°C 1-pole 16A probe ø 4mm probe L 102mm capillary pipe 1200mm capillary pipe isolated 820mm gland nut 1/4" probe SS		
<b>For models:</b>	CD101, CD102, CD201, CD202, CD61		



<b>GEV No.</b>	375774	<b>Ref. No.</b>	40.00.605 40.01.482
<b>description</b>	safety thermostat switch-off temp. 365°C 1-pole 16A probe ø 4mm probe L 96mm capillary pipe 1160mm capillary pipe isolated 1100mm gland nut probe SS with special screwing screw connection M10x1		
<b>For models:</b>	CM101, CM102, CM201, CM202, CM61, CM62, SCC101, SCC102, SCC201, SCC202, SCC61, SCC62		



**E-G-O**



1

<b>GEV No.</b>	375159	<b>Ref. No.</b>	3014.0326 3014.0326ET 3014.0326S
<b>description</b>	safety thermostat switch-off temp. 365°C 1-pole 16A probe ø 4mm probe L 96mm capillary pipe 1160mm capillary pipe isolated 1100mm gland nut probe with special screwing screw connection M14x1		
<b>For models:</b>	CD101, CD102, CD201, CD202, CD61, CM101, CM102, CM201, CM202, CM61, CPC101, CPC102, CPC201, CPC202, CPC61		

control thermostats with operation switch

55.13\_series

**E-G-O**

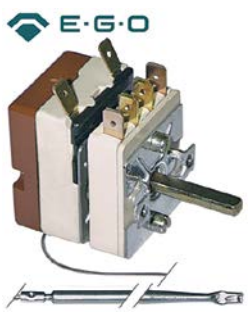

1

<b>GEV No.</b>	375083	<b>Ref. No.</b>	3014.0308
<b>description</b>	thermostat t.max. 250°C temperature range 60-250°C 1-pole 1NO 16A probe ø 4mm probe L 100mm capillary pipe 3150mm capillary pipe isolated 3090mm gland nut shaft ø 6x4.6mm shaft L 23mm shaft position upper rotation 270° outer switch 2NO		
<b>For models:</b>	CD101, CD20, CD201		

55.34\_series

**E-G-O**



1

<b>GEV No.</b>	375570	<b>Ref. No.</b>	40.00.799
<b>description</b>	thermostat t.max. 470°C temperature range 100-470°C 1-pole 1NO 16A probe ø 3.9mm probe L 228mm capillary pipe 1110mm capillary pipe isolated 600mm gland nut shaft ø 6x4.6mm shaft L 24mm shaft position upper rotation 270° outer switch 2NO		

**RATHGEBER**

control thermostats



1

<b>GEV No.</b>	375739	<b>Ref. No.</b>	3306.0301
<b>description</b>	thermostat t.max. 110°C temperature range 30-110°C 1-pole 1NO 16A probe ø 6mm probe L 140mm capillary pipe 1600mm capillary pipe isolated 1560mm gland nut shaft ø 6x4.6mm shaft L 24mm shaft position upper rotation 270°		

switches and momentary switches  
push/momentary push switches

30x22mm



1

<b>GEV No.</b>	347178	<b>Ref. No.</b>	3016.1430
<b>description</b>	push switch mounting measurements 30x22mm black 2NO 250V 16A non-illuminated connection male faston 6.3mm ambient temperature max. 85/55°C protection IP40		
<b>For models:</b>	CC101, CC201, CC6		

ø18.2mm



1

<b>GEV No.</b>	346508	<b>Ref. No.</b>	3016.1352
<b>description</b>	momentary push switch mounting ø 18.2mm black 1NC/1NO 250V 2A connection screw ambient temperature max. 85°C protection IP40		
<b>For models:</b>	CD101, CD20, CD201, CM101, CM201		

2 hole fixing



1

<b>GEV No.</b>	345136	<b>Ref. No.</b>	3016.1405
<b>description</b>	switch combination triple green 240V 16A connection male faston 6.3mm ambient temperature max. 125°C protection IP44		



## microswitches

## lever actuated



1

<b>GEV No.</b>	345125	<b>Ref. No.</b>	3040.3011
<b>description</b>	microswitch with lever 250V 16A 1CO connection male faston 6.3mm ambient temperature max. 85°C mounting distance 25mm type C99ZP3 actuating force: 25g lever length 63.5mm		
<b>For models:</b>	CM101, CM102, CM201, CM202, CM61		

## roller-lever actuated

## microswitches



1

<b>GEV No.</b>	345216	<b>Ref. No.</b>	3016.0101
<b>description</b>	microswitch 250V 16A 1CO connection male faston 6.3mm ambient temperature max. 125°C mounting distance 22mm with handle with a switch blue/black		
<b>For models:</b>	CCC101, CCC102, CCC61, CCM101, CCM102, CCM61, CPC101, CPC102, CPC201, CPC202, CPC61		



1

<b>GEV No.</b>	347949	<b>Ref. No.</b>	3016.0102
<b>description</b>	microswitch with handle with a switch 250V 0.1A 1NC connection male faston 6.3mm L 21mm L1 12mm mounting distance 24mm white		
<b>For models:</b>	CPC101, CPC102, CPC201, CPC202, CPC61, SCC101, SCC102, SCC201, SCC202, SCC61, SCC62		

## pin-plunger actuated

## M16



1

<b>GEV No.</b>	345047	<b>Ref. No.</b>	3016.1400 3016.1403 3016.1407
<b>description</b>	microswitch with plunger thread M16x1 thread L 27mm 250V 5A 1NO connection cable stroke 5mm ambient temperature max. 85°C with cable type 837333 actuating force: 400g		
<b>For models:</b>	CC101, CC201, CC6, CD101, CD20, CD201, CM101, CM201, CM62		
<b>accessories for</b>	345047		
	<b>GEV No.</b>	698490	<b>Ref. No.</b> —
	cover ED ø 17mm suitable for 345047		

## float switches



1

<b>GEV No.</b>	400023	<b>Ref. No.</b>	3002.0407 3016.1200 3016.1201 3016.1202 8424.1202
<b>description</b>	float switch thread 3/8" 1CO ø 30mm L 170mm mounting ø 3/8"mm 250V 0.5A cable cable length 2000mm		
<b>accessories for</b>	400023		
	<b>GEV No.</b>	506024	<b>Ref. No.</b> —
	nut thread 3/8" H 6mm SS WS 22 Qty 1 pcs		

## cam switches

## 2 operating positions



1

<b>GEV No.</b>	300048	<b>Ref. No.</b>	3016.1620
<b>description</b>	cam switch 2 operating positions core temperature sequence 1-2 shaft ø 6x4.6mm connection male faston 4-pole		
<b>For models:</b>	CD101, CD20, CD201		

## 4 operating positions



1

<b>GEV No.</b>	300046	<b>Ref. No.</b>	3016.1600 3016.1630
<b>description</b>	cam switch 4 operating positions 5NO sequence 0-1-2-3 16A shaft ø 6x4.6mm shaft L 27mm connection male faston 6.3mm		
<b>For models:</b>	CM6, CM6-3NAC380V50Hz, CM6-3NAC400V50Hz		



1

<b>GEV No.</b>	300049	<b>Ref. No.</b>	3016.1640
<b>description</b>	cam switch 4 operating positions 8NO sequence 0-1-2-3 16A shaft $\varnothing$ 6x4.6mm shaft L 17mm connection male faston 6.3mm		
<b>For models:</b>	CD101, CD20, CD201		

5 operating positions

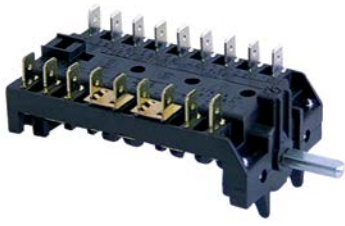

1

<b>GEV No.</b>	300070	<b>Ref. No.</b>	3016.1613
<b>description</b>	cam switch 5 operating positions 9NO sequence 0-1-2-3-4 16A shaft $\varnothing$ 6x4.6mm shaft L 23mm connection male faston 6.3mm plastic		
<b>For models:</b>	CD101, CD102, CD201, CD202, CD61		

6 operating positions

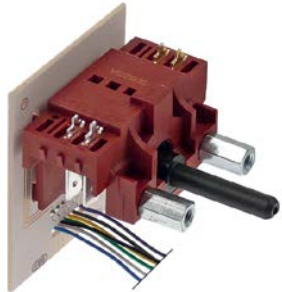

1

<b>GEV No.</b>	300051	<b>Ref. No.</b>	3016.1631
<b>description</b>	cam switch 6 operating positions 2NO sequence 1-0-2-3-4-5 6A shaft $\varnothing$ 6x4.6mm shaft L 33mm connection male faston 6.3mm plastic		
<b>For models:</b>	CM101, CM201, CM62		

rotary switches

TELEMECANIQUE (Schneider Electric)



1

<b>GEV No.</b>	300052	<b>Ref. No.</b>	3016.1500
<b>description</b>	rotary switch 2 1-2 sets of contacts 4 type D1155N 400V 12A connection screw		
<b>For models:</b>	CD101, CD20, CD201		



1

<b>GEV No.</b>	300047	<b>Ref. No.</b>	3016.1300
<b>description</b>	rotary switch 4 operating positions 9-pole		
<b>For models:</b>	CD101, CD20, CD201		

magnetic switches

29x19mm



1

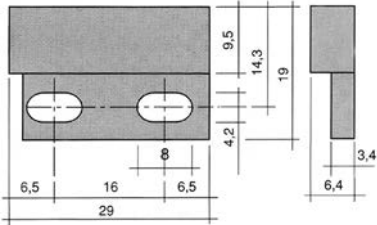

<b>GEV No.</b>	345217	<b>Ref. No.</b>	3016.1408 3016.1415 3016.1439
<b>description</b>	magnetic switch L 29mm W 19mm 1NO 125V 0.5A P max. 10W connection cable cable length 2000mm		
<b>For models:</b>	CC101, CC201, CC6, CCC101, CCC102, CCC201, CCC202, CCC61, CCD101, CCD102, CCD201, CCD202, CCD61, CCM101, CCM102, CCM201, CCM61, CD101, CD102, CD201, CD202, CD61, CM101, CM102, CM201, CM202, CM61, CPC101, CPC102, CPC201, CPC202, CPC61		



32x15mm



1

<b>GEV No.</b>	346510	<b>Ref. No.</b>	40.00.335
<b>description</b>	magnetic switch		
<b>For models:</b>	CM101, CM102, CM61, CM62, SCC101, SCC102, SCC201, SCC202, SCC61, SCC62		



1

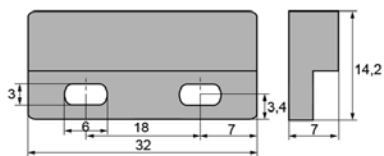

<b>GEV No.</b>	346515 <sup>1</sup>	<b>Ref. No.</b>	40.00.454
<b>description</b>	magnetic switch L 32mm W 15mm 1NO 250V 0.5A P max. 50W connection coded plug cable length 1750mm		
<b>For models:</b>	CM101, CM102, CM201, CM202, CM61, CM62, SCC101, SCC102, SCC202, SCC61, SCC62		

<sup>1</sup>with coded connector

1

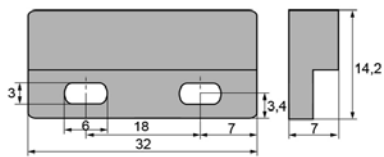

<b>GEV No.</b>	345109	<b>Ref. No.</b>	3016.1408 3016.1415 3016.1439
<b>description</b>	magnetic switch L 32mm W 15mm 1NO 250V 1A P max. 40W connection cable cable length 2000mm		

ø 8mm



1

<b>GEV No.</b>	346511	<b>Ref. No.</b>	3016.1417 3016.1437
<b>description</b>	magnetic switch 230V 0.2A P max. 50W probe L 60mm 1NO connection cable cable length 2500mm		
<b>For models:</b>	CPC101, CPC102, CPC201, CPC202, CPC61		

## accessories

## magnets



1

<b>GEV No.</b>	346514	<b>Ref. No.</b>	3016.1409
<b>description</b>	magnet ø 10mm L 40mm Hmm Wmm		
<b>For models:</b>	CCC101, CCC61, CCD101, CCD61, CCM101, CCM61, CD101, CD102, CD201, CD202, CD61, CM101, CM102, CM201, CM202, CM61, CPC101, CPC102, CPC201, CPC202, CPC61		



1

<b>GEV No.</b>	345110	<b>Ref. No.</b>	3016.1412
<b>description</b>	magnet ømm L 25mm H 9mm W 15mm		
<b>For models:</b>	CCC101, CCC102, CCC61, CCD101, CCD102, CCD61, CCM101, CCM102, CCM61		

## magnetic holders



1

<b>GEV No.</b>	541986	<b>Ref. No.</b>	24.00.502
<b>description</b>	magnet holder with magnet ø 13mm		
<b>For models:</b>	CM101, CM102, CM61, CM62, SCC101, SCC102, SCC61, SCC62		



## control equipment

### JKN (Square D)

#### push buttons



1

<b>GEV No.</b>	345174	<b>Ref. No.</b>	3016.1354
<b>description</b>	push button mounting measurements ø22mm clear reset		
<b>For models:</b>	CM101, CM201, CM62		



1

<b>GEV No.</b>	345207	<b>Ref. No.</b>	3016.1353
<b>description</b>	push button mounting measurements ø22mm transparent reset		
<b>For models:</b>	CM101, CM201, CM62		

**accessories for** 345207



<b>GEV No.</b>	345175	<b>Ref. No.</b>	—
<b>description</b>	contact block 1NC/1NO		

#### rotary switches



1

<b>GEV No.</b>	110261	<b>Ref. No.</b>	3016.1311
<b>description</b>	rotary selector		



1

<b>GEV No.</b>	110260	<b>Ref. No.</b>	3016.1310
<b>description</b>	rotary selector mounting measurements ø22mm		
<b>For models:</b>	CD101, CD20, CD201		

**accessories for** 110260



<b>GEV No.</b>	110261	<b>Ref. No.</b>	3016.1311
<b>description</b>	rotary selector		

## TELEMECANIQUE (EFA)

### XBS series

#### switches (complete)



1

<b>GEV No.</b>	347709	<b>Ref. No.</b>	3016.1350
<b>description</b>	momentary push switch mounting measurements ø22mm white 1NC/1NO		
<b>For models:</b>	CM101, CM201, CM62		

#### lamps



1

<b>GEV No.</b>	359606	<b>Ref. No.</b>	3024.0301
<b>description</b>	neon light bulb socket Ba9s 220V 2W clear ø 10mm L 28mm		
<b>For models:</b>	CM101, CM201, CM62		

**accessories for** 359606



<b>GEV No.</b>	359832	<b>Ref. No.</b>	—
<b>description</b>	lamp socket mounting measurements ø16.2mm socket Ba9s connection male faston 6.3mm		



<b>GEV No.</b>	359853	<b>Ref. No.</b>	—
<b>description</b>	lamp socket mounting measurements ø18.2mm socket Ba9s connection male faston 6.3mm		

## encoders and potentiometers



1

<b>GEV No.</b>	300198	<b>Ref. No.</b>	40.00.404 40.00.404F
<b>description</b>	encoder		
<b>For models:</b>	SCC101, SCC102, SCC201, SCC202, SCC61, SCC62		



1

<b>GEV No.</b>	300196	<b>Ref. No.</b>	3035.0600
<b>description</b>	potentiometer 0-150		
<b>For models:</b>	CD101, CD20, CD201		



1

<b>GEV No.</b>	403719	<b>Ref. No.</b>	42.00.044
<b>description</b>	potentiometer 4.15KOhm shaft ø 6x4.6mm shaft L 23mm		



1

<b>GEV No.</b>	300197	<b>Ref. No.</b>	40.00.464
<b>description</b>	potentiometer 4.7KOhm rotation 360° shaft ø 5.9mm with switch shaft L 22mm		
<b>For models:</b>	CM101, CM102, CM201, CM202, CM61, CM62		



1

<b>GEV No.</b>	300000	<b>Ref. No.</b>	3040.0157 3040.0268
<b>description</b>	potentiometer 5.2KOhm rotation 300° shaft ø 6x4.6mm with switch shaft L 18mm thread M10x0.75		



1

<b>GEV No.</b>	300058	<b>Ref. No.</b>	3040.0150 3040.0181
<b>description</b>	potentiometer 5KOhm rotation 270° shaft ø 6mm shaft L 27mm		
<b>For models:</b>	CM101, CM201		



1

<b>GEV No.</b>	300059	<b>Ref. No.</b>	3040.0151
<b>description</b>	potentiometer 5KOhm rotation 310° shaft ø 6mm with switch shaft L 35mm		
<b>For models:</b>	CM101, CM201		



1

<b>GEV No.</b>	300266	<b>Ref. No.</b>	3040.0156
<b>description</b>	potentiometer with switch 4.7KOhm rotation 270° shaft ø 6mm shaft L 18.5mm for combi-steamer CPC		



1

<b>GEV No.</b>	400106	<b>Ref. No.</b>	3040.0258 8817.1303
<b>description</b>	pulsar KOhm rotation 360° shaft ø 6mm type CPC		
<b>For models:</b>	CPC101, CPC102, CPC201, CPC202, CPC61		

## lamps

### indicator lights

#### indicator lights 3-piece (housing, lens and bulb)

#### lamps

#### light bulbs



1

<b>GEV No.</b>	359598	<b>Ref. No.</b>	3024.0300 3025.0306
<b>description</b>	light bulb socket Ba15d 230V 5-7W ø 16mm L 35mm		
<b>For models:</b>	CCD101, CCD102, CCD201, CCD202, CCD61, CD101, CD20, CD201		



1



<b>GEV No.</b>	359608	<b>Ref. No.</b>	3025.0304
<b>description</b>	light bulb socket E14 10/15W 230V ø 16mm L 51mm lens L 31mm Qty 1 pcs		
<b>For models:</b>	CD101, CD20, CD201		







1

<b>GEV No.</b>	359597	<b>Ref. No.</b>	3024.0210 3024.0307
<b>description</b>	light bulb socket T10 24V 2W ø 10mm L 28mm		
<b>For models:</b>	CM101, CM201, CM62		





neon light bulbs			
			
1			
<b>GEV No.</b>	359606	<b>Ref. No.</b>	3024.0301
<b>description</b>	neon light bulb socket Ba9s 220V 2W clear ø 10mm L 28mm		
<b>For models:</b>	CM101, CM201, CM62		
<b>accessories for</b>	359606		
	<b>GEV No.</b>	359832	<b>Ref. No.</b> —
	lamp socket mounting measurements ø16.2mm socket Ba9s connection male faston 6.3mm		
	<b>GEV No.</b>	359853	<b>Ref. No.</b> —
	lamp socket mounting measurements ø18.2mm socket Ba9s connection male faston 6.3mm		

			
1			
<b>GEV No.</b>	359585	<b>Ref. No.</b>	30240300
<b>description</b>	neon light bulb socket E10 230V green ø 10mm L 28mm		
<b>accessories for</b>	359585		
	<b>GEV No.</b>	359060	<b>Ref. No.</b> —
	lamp socket mounting measurements ø16.2mm socket E10 connection screw		
	<b>GEV No.</b>	359685	<b>Ref. No.</b> —
	lamp socket mounting measurements ø16.2mm socket E10		

indicator lights (complete)			
miscellaneous			
			
1			
<b>GEV No.</b>	359886	<b>Ref. No.</b>	8430.7110
<b>description</b>	indicator light 230V 15W socket Ba15d triple		
<b>For models:</b>	CD101, CD20, CD201		

			
1			
<b>GEV No.</b>	359066	<b>Ref. No.</b>	3024.0309
<b>description</b>	indicator light mounting measurements 30x21mm green 230V		

			
1			
<b>GEV No.</b>	359883	<b>Ref. No.</b>	3024.0309
<b>description</b>	indicator light mounting measurements 30x21mm green 230V		
<b>For models:</b>	CD101, CD102, CD201, CD202, CD61		



			
1			
<b>GEV No.</b>	359884	<b>Ref. No.</b>	3024.0310
<b>description</b>	indicator light mounting measurements 30x21mm red 230V		
<b>For models:</b>	CD101, CD102, CD201, CD202, CD61		



			
1			
<b>GEV No.</b>	359065	<b>Ref. No.</b>	3024.0310
<b>description</b>	indicator light mounting measurements 30x21mm white 230V		

			
1			
<b>GEV No.</b>	359885	<b>Ref. No.</b>	3024.0307
<b>description</b>	indicator light mounting measurements 35x16mm red 230V		
<b>For models:</b>	CCD101, CCD102, CCD201, CCD202, CCD61		

			
1			
<b>GEV No.</b>	359887	<b>Ref. No.</b>	3023.0300
<b>description</b>	lamp socket socket E10 mounting measurements ø21mm		
<b>For models:</b>	CD101, CD20, CD201		

## screw-on/push-on fit

neon light bulbs			
			
1			
<b>GEV No.</b>	359606	<b>Ref. No.</b>	3024.0301
<b>description</b>	neon light bulb socket Ba9s 220V 2W clear ø 10mm L 28mm		
<b>For models:</b>	CM101, CM201, CM62		
<b>accessories for</b>	359606		
	<b>GEV No.</b>	359832	<b>Ref. No.</b> —
	lamp socket mounting measurements ø16.2mm socket Ba9s connection male faston 6.3mm		
	<b>GEV No.</b>	359853	<b>Ref. No.</b> —
	lamp socket mounting measurements ø18.2mm socket Ba9s connection male faston 6.3mm		

			
1			
<b>GEV No.</b>	359585	<b>Ref. No.</b>	30240300
<b>description</b>	neon light bulb socket E10 230V green ø 10mm L 28mm		
<b>accessories for</b>	359585		
	<b>GEV No.</b>	359060	<b>Ref. No.</b> —
	lamp socket mounting measurements ø16.2mm socket E10 connection screw		
	<b>GEV No.</b>	359685	<b>Ref. No.</b> —
	lamp socket mounting measurements ø16.2mm socket E10		





## light bulbs

for ovens



<b>GEV No.</b>	359610	<b>Ref. No.</b>	3024.0200
<b>description</b>	light bulb t.max. 300°C socket E14 15W 230V ø 22mm L 47mm lens L 20mm for oven lamp type Philips		
<b>For models:</b>	CC101, CC201, CC6, CD101, CD20, CD201, CM101, CM201, CM62		

for indicator lights



<b>GEV No.</b>	359598	<b>Ref. No.</b>	3024.0300 3025.0306
<b>description</b>	light bulb socket Ba15d 230V 5-7W ø 16mm L 35mm		
<b>For models:</b>	CCD101, CCD102, CCD201, CCD202, CCD61, CD101, CD20, CD201		



<b>GEV No.</b>	359608	<b>Ref. No.</b>	3025.0304
<b>description</b>	light bulb socket E14 10/15W 230V ø 16mm L 51mm lens L 31mm Qty 1 pcs		
<b>For models:</b>	CD101, CD20, CD201		



<b>GEV No.</b>	359597	<b>Ref. No.</b>	3024.0210 3024.0307
<b>description</b>	light bulb socket T10 24V 2W ø 10mm L 28mm		
<b>For models:</b>	CM101, CM201, CM62		

## halogen lamp

for socket G4 / G6.35 / G9



<b>GEV No.</b>	359596	<b>Ref. No.</b>	3024.0201 3024.0201P
<b>description</b>	halogen lamp socket G4 12V 10W temp.-resist. 500°C		
<b>For models:</b>	CCC101, CCC102, CCC201, CCC202, CCC61, CCD101, CCD102, CCD201, CCD202, CCD61, CCM101, CCM102, CCM201, CCM202, CCM61, CD101, CD102, CD201, CD202, CD61, CM101, CM102, CM201, CM202, CM61, CM62, CPC101, CPC102, CPC201, CPC202, CPC61, SCC101, SCC102, SCC201, SCC202, SCC61, SCC62		

## oven lamps

## universal oven lamps

mounting diameter 35.5mm



<b>GEV No.</b>	359720	<b>Ref. No.</b>	3023.0501
<b>description</b>	oven lamp mounting ø 35.5mm 230V 15W socket E14 temp.-resist. 300°C connection male faston 6.3mm hard glas		
<b>For models:</b>	CC101, CC201, CC6, CD101, CD20, CD201, CM101, CM201, CM62		

<b>spare parts for</b>	359720			
	<b>GEV No.</b>	359701	<b>Ref. No.</b>	3023.0502 3023.0506
	lamp socket socket E14 220-230V mounting ø 35.5mm connection male faston 6.3mm 15W			

	<b>GEV No.</b>	359705	<b>Ref. No.</b>	30250002
	oven lamp glass thr.ø 33.5mm ø 52mm hard glas temp.-resist. 350°C			

	<b>GEV No.</b>	359721	<b>Ref. No.</b>	3025.0003 5012.0508 5012.0509 5012.0535
	gasket silicone ED ø 48mm ID ø 39.5mm thickness 5mm Qty 1 pcs			

	<b>GEV No.</b>	359740	<b>Ref. No.</b>	—
	light bulb t.max. 300°C socket E14 15W 230V ø 22mm L 48mm lens L 20mm for oven lamp IMPORT			



<b>GEV No.</b>	359701	<b>Ref. No.</b>	3023.0502 3023.0506
<b>description</b>	lamp socket socket E14 220-230V mounting ø 35.5mm connection male faston 6.3mm 15W		
<b>For models:</b>	CC101, CC201, CC6, CD101, CD20, CD201, CM101, CM201, CM62		

<b>accessories for</b>	359701			
	<b>GEV No.</b>	359705	<b>Ref. No.</b>	30250002
	oven lamp glass thr.ø 33.5mm ø 52mm hard glas temp.-resist. 350°C			

	<b>GEV No.</b>	359709	<b>Ref. No.</b>	—
	oven lamp glass thr.ø 33.5mm ø 42mm hard glas temp.-resist. 350°C			

	<b>GEV No.</b>	359721	<b>Ref. No.</b>	3025.0003 5012.0508 5012.0509 5012.0535
	gasket silicone ED ø 48mm ID ø 39.5mm thickness 5mm Qty 1 pcs			



	<b>GEV No.</b>	359942	<b>Ref. No.</b>	—
	oven lamp glass thr.ø 33.5mm ø 41mm hard glas temp.-resist. 350°C			









 <p>1</p>							
<b>GEV No.</b>	359723	<b>Ref. No.</b>	3025.0002 3025.0004				
<b>description</b>	oven lamp glass thr.ø 33.5mm ø 51mm borosilicate glass temp.-resist. 550°C						
<b>For models:</b>	CC101, CC201, CC6, CD101, CD20, CD201, CM101, CM201, CM62						
<b>accessories for</b>	359723						
 <table border="1"> <tr> <td>GEV No.</td> <td>359721</td> <td>Ref. No.</td> <td>3025.0003 5012.0508 5012.0509 5012.0535</td> </tr> </table> <p>gasket silicone ED ø 48mm ID ø 39.5mm thickness 5mm Qty 1 pcs</p>				GEV No.	359721	Ref. No.	3025.0003 5012.0508 5012.0509 5012.0535
GEV No.	359721	Ref. No.	3025.0003 5012.0508 5012.0509 5012.0535				

 <p>1</p>							
<b>GEV No.</b>	359705	<b>Ref. No.</b>	30250002				
<b>description</b>	oven lamp glass thr.ø 33.5mm ø 52mm hard glas temp.-resist. 350°C						
<b>accessories for</b>	359705						
 <table border="1"> <tr> <td>GEV No.</td> <td>359610</td> <td>Ref. No.</td> <td>3024.0200</td> </tr> </table> <p>light bulb t.max. 300°C socket E14 15W 230V ø 22mm L 47mm lens L 20mm for oven lamp type Philips</p>				GEV No.	359610	Ref. No.	3024.0200
GEV No.	359610	Ref. No.	3024.0200				
 <table border="1"> <tr> <td>GEV No.</td> <td>359700</td> <td>Ref. No.</td> <td>—</td> </tr> </table> <p>gasket for pizza oven fibre glass ID ø 32.5mm ED ø 55mm thickness 5mm</p>				GEV No.	359700	Ref. No.	—
GEV No.	359700	Ref. No.	—				
 <table border="1"> <tr> <td>GEV No.</td> <td>359721</td> <td>Ref. No.</td> <td>3025.0003 5012.0508 5012.0509 5012.0535</td> </tr> </table> <p>gasket silicone ED ø 48mm ID ø 39.5mm thickness 5mm Qty 1 pcs</p>				GEV No.	359721	Ref. No.	3025.0003 5012.0508 5012.0509 5012.0535
GEV No.	359721	Ref. No.	3025.0003 5012.0508 5012.0509 5012.0535				
 <table border="1"> <tr> <td>GEV No.</td> <td>359837</td> <td>Ref. No.</td> <td>—</td> </tr> </table> <p>gasket ID ø 33mm ED ø 46mm thickness 1mm graphite</p>				GEV No.	359837	Ref. No.	—
GEV No.	359837	Ref. No.	—				
 <table border="1"> <tr> <td>GEV No.</td> <td>359838</td> <td>Ref. No.</td> <td>—</td> </tr> </table> <p>gasket ID ø 33mm ED ø 45mm</p>				GEV No.	359838	Ref. No.	—
GEV No.	359838	Ref. No.	—				

 <p>1</p>			
<b>GEV No.</b>	359721	<b>Ref. No.</b>	3025.0003 5012.0508 5012.0509 5012.0535
<b>description</b>	gasket silicone ED ø 48mm ID ø 39.5mm thickness 5mm Qty 1 pcs		
<b>For models:</b>	CC101, CC201, CC6, CD101, CD20, CD201, CM101, CM201, CM62		





producer-specific oven lamps							
RATIONAL							
 <p>1</p>							
<b>GEV No.</b>	359888	<b>Ref. No.</b>	3024.0305				
<b>description</b>	lamp socket 230V 5W socket Ba15d with holder						
<b>For models:</b>	CCD101, CCD102, CCD201, CCD202, CCD61						
<b>accessories for</b>	359888						
 <table border="1"> <tr> <td>GEV No.</td> <td>359598</td> <td>Ref. No.</td> <td>3024.0300 3025.0306</td> </tr> </table> <p>light bulb socket Ba15d 230V 5-7W ø 16mm L 35mm</p>				GEV No.	359598	Ref. No.	3024.0300 3025.0306
GEV No.	359598	Ref. No.	3024.0300 3025.0306				

 <p>1</p>							
<b>GEV No.</b>	359876	<b>Ref. No.</b>	8514.1007 8514.1017				
<b>description</b>	frame SS for lamp lenses W 90mm L 113mm C-Line, CPC, SCC 61-202						
<b>For models:</b>	CCC101, CCC102, CCC201, CCC202, CCC61, CCD101, CCD102, CCD201, CCD202, CCD61, CCM101, CCM102, CCM201, CCM202, CCM61, CD101, CD102, CD201, CD202, CD61, CM101, CM102, CM201, CM202, CM61, CPC101, CPC102, CPC201, CPC202, CPC61						
<b>accessories for</b>	359876						
 <table border="1"> <tr> <td>GEV No.</td> <td>359877</td> <td>Ref. No.</td> <td>5201.1000</td> </tr> </table> <p>lamp glass L 95mm W 72mm thickness 4mm C-Line, CPC, SCC 61-202</p>				GEV No.	359877	Ref. No.	5201.1000
GEV No.	359877	Ref. No.	5201.1000				
 <table border="1"> <tr> <td>GEV No.</td> <td>359879</td> <td>Ref. No.</td> <td>5110.1023</td> </tr> </table> <p>gasket L 99mm W 75mm C-Line, CPC, SCC 61-202</p>				GEV No.	359879	Ref. No.	5110.1023
GEV No.	359879	Ref. No.	5110.1023				
 <table border="1"> <tr> <td>GEV No.</td> <td>359880</td> <td>Ref. No.</td> <td>5110.1022</td> </tr> </table> <p>gasket L 95mm W 72mm C-Line, CPC, SCC 61-202</p>				GEV No.	359880	Ref. No.	5110.1022
GEV No.	359880	Ref. No.	5110.1022				
 <table border="1"> <tr> <td>GEV No.</td> <td>560448</td> <td>Ref. No.</td> <td>1008.0753</td> </tr> </table> <p>hexagonal screw thread M5 thread L 8mm SS WS 8 Qty 1 pcs head thickness 4mm DIN 933 / ISO 4017</p>				GEV No.	560448	Ref. No.	1008.0753
GEV No.	560448	Ref. No.	1008.0753				



 <p>1</p>			
<b>GEV No.</b>	359880	<b>Ref. No.</b>	5110.1022
<b>description</b>	gasket L 95mm W 72mm C-Line, CPC, SCC 61-202		
<b>For models:</b>	CCC101, CCC102, CCC201, CCC202, CCC61, CCD101, CCD102, CCD201, CCD202, CCD61, CCM101, CCM102, CCM201, CCM202, CCM61, CD101, CD102, CD201, CD202, CD61, CM101, CM102, CM201, CM202, CM61, CPC101, CPC102, CPC201, CPC202, CPC61		







			
1			
<b>GEV No.</b>	359879	<b>Ref. No.</b>	5110.1023
<b>description</b>	gasket L 99mm W 75mm C-Line, CPC, SCC 61-202		
<b>For models:</b>	CCC101, CCC102, CCC201, CCC202, CCC61, CCD101, CCD102, CCD201, CCD202, CCD61, CCM101, CCM102, CCM201, CCM202, CCM61, CD101, CD102, CD201, CD202, CD61, CM101, CM102, CM201, CM202, CM61, CPC101, CPC102, CPC201, CPC202, CPC61		

			
1			
<b>GEV No.</b>	360724	<b>Ref. No.</b>	8514.1034
<b>description</b>	lamp glass L 113mm W 90mm C-Line, CPC, SCC 61-202		
<b>For models:</b>	CD101, CD102, CD201, CD202, CD61, CM101, CM102, CM201, CM202, CM61, CPC101, CPC102, CPC201, CPC202, CPC61		
<b>spare parts for</b>	360724		
	<b>GEV No.</b>	359876	<b>Ref. No.</b> 8514.1007 8514.1017
frame SS for lamp lenses W 90mm L 113mm C-Line, CPC, SCC 61-202			
	<b>GEV No.</b>	359877	<b>Ref. No.</b> 5201.1000
lamp glass L 95mm W 72mm thickness 4mm C-Line, CPC, SCC 61-202			
	<b>GEV No.</b>	359879	<b>Ref. No.</b> 5110.1023
gasket L 99mm W 75mm C-Line, CPC, SCC 61-202			
	<b>GEV No.</b>	359880	<b>Ref. No.</b> 5110.1022
gasket L 95mm W 72mm C-Line, CPC, SCC 61-202			

			
1			
<b>GEV No.</b>	359877	<b>Ref. No.</b>	5201.1000
<b>description</b>	lamp glass L 95mm W 72mm thickness 4mm C-Line, CPC, SCC 61-202		
<b>For models:</b>	CCC101, CCC102, CCC201, CCC202, CCC61, CCD101, CCD102, CCD201, CCD202, CCD61, CCM101, CCM102, CCM201, CCM202, CCM61, CD101, CD102, CD201, CD202, CD61, CM101, CM102, CM201, CM202, CM61, CPC101, CPC102, CPC201, CPC202, CPC61		

			
1			
<b>GEV No.</b>	359873	<b>Ref. No.</b>	4001.1248 8514.1018
<b>description</b>	lamp socket socket G4 for halogen lamp		
<b>For models:</b>	CCC101, CCC102, CCC201, CCC202, CCC61, CCD101, CCD102, CCD201, CCD202, CCD61, CCM101, CCM102, CCM201, CCM202, CCM61, CD101, CD102, CD201, CD202, CD61, CM101, CM102, CM201, CM202, CM61, CM62, CPC101, CPC102, CPC201, CPC202, CPC61, SCC101, SCC102, SCC201, SCC202, SCC61, SCC62		
<b>accessories for</b>	359873		
	<b>GEV No.</b>	359876	<b>Ref. No.</b> 8514.1007 8514.1017
frame SS for lamp lenses W 90mm L 113mm C-Line, CPC, SCC 61-202			
	<b>GEV No.</b>	359877	<b>Ref. No.</b> 5201.1000
lamp glass L 95mm W 72mm thickness 4mm C-Line, CPC, SCC 61-202			

<b>accessories for</b>	359873		
	<b>GEV No.</b>	359879	<b>Ref. No.</b> 5110.1023
gasket L 99mm W 75mm C-Line, CPC, SCC 61-202			
	<b>GEV No.</b>	359880	<b>Ref. No.</b> 5110.1022
gasket L 95mm W 72mm C-Line, CPC, SCC 61-202			
	<b>GEV No.</b>	360724	<b>Ref. No.</b> 8514.1034
lamp glass L 113mm W 90mm C-Line, CPC, SCC 61-202			

			
1			
<b>GEV No.</b>	359882	<b>Ref. No.</b>	40.00.093
<b>description</b>	gasket L 81mm W 65mm		
<b>For models:</b>	CM101, CM102, CM201, CM202, CM61, CM62, SCC101, SCC102, SCC201, SCC202, SCC61, SCC62		

			
1			
<b>GEV No.</b>	359881	<b>Ref. No.</b>	40.00.094
<b>description</b>	gasket L 85mm W 70mm		
<b>For models:</b>	CM101, CM102, CM201, CM202, CM61, CM62, SCC101, SCC102, SCC201, SCC202, SCC61, SCC62		

			
1			
<b>GEV No.</b>	359878	<b>Ref. No.</b>	40.00.095
<b>description</b>	lamp glass L 80mm W 65mm thickness 4mm		
<b>For models:</b>	CM101, CM102, CM201, CM202, CM61, CM62, SCC101, SCC102, SCC201, SCC202, SCC61, SCC62		

			
1			
<b>GEV No.</b>	359874	<b>Ref. No.</b>	40.00.098
<b>description</b>	lamp socket socket G4 for halogen lamp		
<b>For models:</b>	CM101, CM102, CM201, CM202, CM61, CM62, SCC101, SCC102, SCC201, SCC202, SCC61, SCC62		

			
1			
<b>GEV No.</b>	359875	<b>Ref. No.</b>	40.00.091 40.00.096
<b>description</b>	press frame with gasket		
<b>For models:</b>	CM101, CM102, CM201, CM202, CM61, CM62, SCC101, SCC102, SCC201, SCC202, SCC61, SCC62		



**lamps**

**light bulbs**

 <p><b>PHILIPS</b></p>			
1			
<b>GEV No.</b>	359610	<b>Ref. No.</b>	3024.0200
<b>description</b>	light bulb t.max. 300°C socket E14 15W 230V ø 22mm L 47mm lens L 20mm for oven lamp type Philips		
<b>For models:</b>	CC101, CC201, CC6, CD101, CD20, CD201, CM101, CM201, CM62		

**halogen lamps**

**for socket G4 / G6.35 / G9**

 <p><b>500°C</b></p>			
1			
<b>GEV No.</b>	359596	<b>Ref. No.</b>	3024.0201 3024.0201P
<b>description</b>	halogen lamp socket G4 12V 10W temp.-resist. 500°C		
<b>For models:</b>	CCC101, CCC102, CCC201, CCC202, CCC61, CCD101, CCD102, CCD201, CCD202, CCD61, CCM101, CCM102, CCM201, CCM202, CCM61, CD101, CD102, CD201, CD202, CD61, CM101, CM102, CM201, CM202, CM61, CM62, CPC101, CPC102, CPC201, CPC202, CPC61, SCC101, SCC102, SCC201, SCC202, SCC61, SCC62		

**sockets**

**Ba15d**

									
1									
<b>GEV No.</b>	359888	<b>Ref. No.</b>	3024.0305						
<b>description</b>	lamp socket 230V 5W socket Ba15d with holder								
<b>For models:</b>	CCD101, CCD102, CCD201, CCD202, CCD61								
<b>accessories for</b>	359888								
		<table border="1"> <tr> <td><b>GEV No.</b></td> <td>359598</td> <td><b>Ref. No.</b></td> <td>3024.0300 3025.0306</td> </tr> </table>	<b>GEV No.</b>	359598	<b>Ref. No.</b>	3024.0300 3025.0306	<table border="1"> <tr> <td><b>description</b></td> <td>light bulb socket Ba15d 230V 5-7W ø 16mm L 35mm</td> </tr> </table>	<b>description</b>	light bulb socket Ba15d 230V 5-7W ø 16mm L 35mm
<b>GEV No.</b>	359598	<b>Ref. No.</b>	3024.0300 3025.0306						
<b>description</b>	light bulb socket Ba15d 230V 5-7W ø 16mm L 35mm								

**timers**

**electric timers**

									
1									
<b>GEV No.</b>	350015	<b>Ref. No.</b>	3013.0101 3013.0109						
<b>description</b>	timer MS65 without bell operation time 120min time spreadmin 1CO/1NO at 250V 16A permanent position yes impulse electric shaft ø 6x4.6mm shaft L 23mm mounting distance 28mm connection lateral 2-pole								
<b>For models:</b>	CD101, CD102, CD20, CD201, CD202, CD61, CM101, CM201								
<b>accessories for</b>	350015								
		<table border="1"> <tr> <td><b>GEV No.</b></td> <td>110366</td> <td><b>Ref. No.</b></td> <td>—</td> </tr> </table>	<b>GEV No.</b>	110366	<b>Ref. No.</b>	—	<table border="1"> <tr> <td><b>description</b></td> <td>knob switch zero mark t.max.°C ø 44mm shaft ø 6x4.6mm shaft flat upper black</td> </tr> </table>	<b>description</b>	knob switch zero mark t.max.°C ø 44mm shaft ø 6x4.6mm shaft flat upper black
<b>GEV No.</b>	110366	<b>Ref. No.</b>	—						
<b>description</b>	knob switch zero mark t.max.°C ø 44mm shaft ø 6x4.6mm shaft flat upper black								
		<table border="1"> <tr> <td><b>GEV No.</b></td> <td>111206</td> <td><b>Ref. No.</b></td> <td>—</td> </tr> </table>	<b>GEV No.</b>	111206	<b>Ref. No.</b>	—	<table border="1"> <tr> <td><b>description</b></td> <td>dial plate graduation 120min permanent position no rotation 10-300° ø 60mm timers knob ø 45mm</td> </tr> </table>	<b>description</b>	dial plate graduation 120min permanent position no rotation 10-300° ø 60mm timers knob ø 45mm
<b>GEV No.</b>	111206	<b>Ref. No.</b>	—						
<b>description</b>	dial plate graduation 120min permanent position no rotation 10-300° ø 60mm timers knob ø 45mm								

**with time spread**

			
1			
<b>GEV No.</b>	350074	<b>Ref. No.</b>	3013.0104 3013.0107
<b>description</b>	timer MS65 operation time 120min time spread 30min 1CO/2NO/1NC at 250V 16A permanent position yes impulse electric shaft ø 6x4.6mm shaft L 22mm mounting distance 28mm connection lateral Invensys 4-pole shaft position lower°		
<b>For models:</b>	CCD101, CCD102, CCD201, CCD202, CCD61, CD101, CD102, CD20, CD201, CD202, CD61		

**alarm devices**

**buzzers**

			
1			
<b>GEV No.</b>	350136	<b>Ref. No.</b>	40.00.209 40.02.087 87.00.136
<b>description</b>	buzzer 12VAC connection cable 200mm screw mounting 63dB		
<b>For models:</b>	CM101, CM102, CM201, CM202, CM61, CM62, SCC101, SCC102, SCC201, SCC202, SCC61, SCC62		



			
1			
<b>GEV No.</b>	350053	<b>Ref. No.</b>	3006.0107
<b>description</b>	buzzer 12VAC connection male faston 3.2mm screw mounting buzzer		
<b>For models:</b>	CM101, CM102, CM201, CM202, CM61, CM62, CPC101, CPC102, CPC201, CPC202, CPC61, SCC101, SCC102, SCC201, SCC202, SCC61, SCC62		

			
1			
<b>GEV No.</b>	350050	<b>Ref. No.</b>	3006.0101
<b>description</b>	buzzer 230VAC connection male faston 6.3mm screw mounting thread M4 60dB		
<b>For models:</b>	CC101, CC201, CC6, CCD101, CCD102, CCD201, CCD202, CCD61, CD101, CD102, CD20, CD201, CD202, CD61, CM101, CM201, CM62		

			
1			
<b>GEV No.</b>	350091	<b>Ref. No.</b>	3006.0103
<b>description</b>	buzzer 24VAC connection male faston 6.3mm push-in 63dB		
<b>For models:</b>	CCC101, CCC102, CCC201, CCC202, CCC61, CCM101, CCM102, CCM201, CCM202, CCM61		

			
1			
<b>GEV No.</b>	381501	<b>Ref. No.</b>	3028.0509 3028.0557 3088.0509 40.02.808 40.02.885 40.03.691 40.03.691S
<b>description</b>	power contactor resistive load 32A 230VAC (AC3/400V) 17A/7.5kW main contacts 3NO auxiliary contacts 1NC connection screw connection		
<b>For models:</b>	CCC101, CCC102, CCD101, CCD102, CCD201, CCM101, CCM102, CD101, CD102, CD201, CD202, CM102, CM201, CM202, CPC102, CPC201, CPC202		

			
1			
<b>GEV No.</b>	382001	<b>Ref. No.</b>	3028.0517 3028.0569 40.02.806 40.02.883 40.03.689 40.03.689S
<b>description</b>	power contactor resistive load 32A 230VAC (AC3/400V) 17A/7.5kW main contacts 4NO auxiliary contacts connection screw connection		
<b>For models:</b>	CCC101, CCC61, CCM101, CCM61, CD101, CM101, CPC101		

## contactors

### BENEDIKT & JÄGER



#### power contactors



			
1			
<b>GEV No.</b>	380772	<b>Ref. No.</b>	40.02.758 40.02.759 40.02.804 40.02.881 40.03.667 40.03.684
<b>description</b>	power contactor resistive load 25A 230VAC (AC3/400V) 10A/4kW main contacts 3NO auxiliary contacts 1NO connection screw connection type K3-10A10230		
<b>For models:</b>	CM61, SCC61		







			
1			
<b>GEV No.</b>	381173	<b>Ref. No.</b>	3028.0101 3028.0123 3028.0124 3028.0127 3028.0131 3028.0134 3028.0136 3028.0201 3028.0223 3028.0224 3028.0226 3028.0401 3028.0412 3028.0451 3028.0452 3028.0461 3028.0462 3028.0510 3028.0511 3028.0553 40.00.805 40.02.553 40.02.585 40.02.809 40.02.886 40.03.685
<b>description</b>	power contactor resistive load 50A 230VAC (AC3/400V) 24A/11kW main contacts 3NO auxiliary contacts 1NO connection torx type K3-24B00 50/60Hz		
<b>For models:</b>	CC101, CC6, CCC102, CCC201, CCD102, CCM102, CCM201, CD101, CD20, CD201, CD61, CM101, CM201, CM61, CPC61, SCC101, SCC61		





			
2			
<b>GEV No.</b>	381203	<b>Ref. No.</b>	40.03.692
<b>description</b>	power contactor resistive load 65A 230VAC (AC3/400V) 32A/15kW main contacts 3NO auxiliary contacts 1NO connection screw connection type K3-32B00		
<b>spare parts for</b>	381203		
	<b>GEV No.</b>	380678	<b>Ref. No.</b> 4002641V
	auxiliary contact contacts 1NO AC15 10A for contactors K2/K3 connection screw type HN10 AC1 25A		

			
1			
<b>GEV No.</b>	381180	<b>Ref. No.</b>	40.03.686 40.03.686S
<b>description</b>	power contactor resistive load 80A 230VAC (AC3/400V) 40A/18.5kW main contacts 3NO connection screw connection type K3-40B00		
<b>accessories for</b>	381180		
	<b>GEV No.</b>	380678	<b>Ref. No.</b> 4002641V
	auxiliary contact contacts 1NO AC15 10A for contactors K2/K3 connection screw type HN10 AC1 25A		

<b>auxiliary contacts</b>			
			
1			
<b>GEV No.</b>	380678	<b>Ref. No.</b>	4002641V
<b>description</b>	auxiliary contact contacts 1NO AC15 10A for contactors K2/K3 connection screw type HN10 AC1 25A		

GENERAL ELECTRIC (AEG)

<b>power contactors</b>			
 Image not available			
1			
<b>GEV No.</b>	380445	<b>Ref. No.</b>	3028.0103 3028.0120 3028.0125 3028.0129 3028.0203 3028.0220 3028.0413 3028.0503 3028.0504 3028.0505 3028.0507 3028.0550 40.02.805 40.02.882 40.03.688
<b>description</b>	contactor resistive load 25A connection screw connection set		
<b>For models:</b>	CCC101, CCC102, CCC201, CCC202, CCC61, CCD101, CCD102, CCD201, CCD202, CCD61, CCM101, CCM102, CCM201, CCM202, CCM61, CD101, CD102, CD20, CD201, CD202, CD61, CM101, CM102, CM201, CM202, CM61, CPC101, CPC102, CPC201, CPC202, CPC61		



			
1			
<b>GEV No.</b>	380267	<b>Ref. No.</b>	3028.0515 3028.0516 3028.0555 40.01.558 40.02.812 40.02.889 40.03.694
<b>description</b>	power contactor resistive load 110A 230VAC (AC3/400V) 65A/30kW main contacts 3NO auxiliary contacts connection screw connection type AEG LS30K 00A type GE CL07A 300		
<b>For models:</b>	CD201, CD61, CM102, CM201, CM202, CM61, CPC102, CPC201, CPC61, SCC102, SCC201, SCC202		
<b>accessories for</b>	380267		
	<b>GEV No.</b>	380268	<b>Ref. No.</b> 3028.0153 3028.0560 8720.1582
	auxiliary contact contacts 1NO for contactors CL+LS_K connection screw AC-12 10A type AEG HS07K 10 type GE BCLF 10		
	<b>GEV No.</b>	380269	<b>Ref. No.</b> 3028.0561
	auxiliary contact contacts 1NC AC15 6A for contactors CL+LS_K connection screw AC-12 10A type AEG HS07K 01 type GE BCLF 01		
	<b>GEV No.</b>	380270	<b>Ref. No.</b> —
	auxiliary contact contacts 1NO/1NC for contactors CL+LS_K connection screw AC-12 10A type AEG HS08K 11 type GE BCLL 11		
	<b>GEV No.</b>	380271	<b>Ref. No.</b> —
	auxiliary contact contacts 2NO for contactors CL+LS_K connection screw AC-12 10A type AEG HS08K 20 type GE BCLL 20		



			
1			
<b>GEV No.</b>	380239	<b>Ref. No.</b>	3028.0103 3028.0120 3028.0125 3028.0129 3028.0203 3028.0220 3028.0413 3028.0503 3028.0504 3028.0505 3028.0507 3028.0550 40.02.805 40.02.882 40.03.688
<b>description</b>	power contactor resistive load 20A 230VAC (AC3/400V) 8.4A/4kW main contacts 3NO auxiliary contacts 1NC connection screw connection type LS05 01A type AEG LS05 01A type GE MC1A 301A		



			
1			
<b>GEV No.</b>	380238	<b>Ref. No.</b>	3028.0133 3028.0204 3028.0218 3028.0221 3028.0300 3028.0400 3028.0410 3028.0411 3028.0418 3028.0450 3028.0454 3028.0460 3028.0500 3028.0501 3028.0502 3028.0506 3028.0551 3035.0501 40.01.554
<b>description</b>	power contactor resistive load 20A 230VAC (AC3/400V) 8.4A/4kW main contacts 3NO auxiliary contacts 1NO connection screw connection type LS0510A type AEG LS0510A type GE MC1A 310A		



			
1			
<b>GEV No.</b>	380498	<b>Ref. No.</b>	40.00.451 40.02.917
<b>description</b>	power contactor resistive load 20A 230VAC (AC3/400V) 9A/4kW main contacts 4NO auxiliary contacts connection male faston 6.3mm type MC1A 400A type AEG LS05 01 FA type GE MC1A 400A		
<b>For models:</b>	CM101, CM102, CM201, CM202, CM61, CM62, SCC101, SCC102, SCC201, SCC202, SCC61, SCC62		





 			
1			
<b>GEV No.</b>	380245	<b>Ref. No.</b>	3028.0103 3028.0120 3028.0125 3028.0129 3028.0203 3028.0220 3028.0413 3028.0503 3028.0504 3028.0505 3028.0507 3028.0550 40.02.805 40.02.882 40.03.688
<b>description</b>		power contactor resistive load 25A 230VAC (AC3/400V) 9A/4kW main contacts 3NO auxiliary contacts 1NC connection screw connection type AEG LS4K 01A type GE CL00A 301 H 85mm	

 			
1			
<b>GEV No.</b>	380261	<b>Ref. No.</b>	3028.0508 3028.0552 40.01.555 40.02.760 40.02.807 40.02.884 40.03.690
<b>description</b>		power contactor resistive load 32A 230VAC (AC3/400V) 17A/7.5kW main contacts 3NO auxiliary contacts 1NO connection screw connection type AEG LS7K 10A type GE CL02A 310	
<b>For models:</b>		CC101, CC201, CCC101, CCD101, CCD202, CCD61, CCM101, CD101, CD61, CM101, CM102, CM201, CM202, CM61, CM62, CPC101, CPC102, CPC201, CPC202, CPC61, SCC101, SCC202, SCC62	

 			
2			
<b>GEV No.</b>	380244	<b>Ref. No.</b>	3028.0130 3028.0204 3028.0218 3028.0221 3028.0300 3028.0400 3028.0410 3028.0411 3028.0418 3028.0450 3028.0454 3028.0460 3028.0500 3028.0501 3028.0502 3028.0506 3028.0551 40.01.554
<b>description</b>		power contactor resistive load 25A 230VAC (AC3/400V) 9A/4kW main contacts 3NO auxiliary contacts 1NO connection screw connection type AEG LS4K 10A type GE CL00A 310	

 			
1			
<b>GEV No.</b>	380265	<b>Ref. No.</b>	3028.0512 3028.0554 3028.0563 40.01.559 40.02.583 40.02.639 40.02.810 40.02.813 40.02.887 40.02.890 40.03.402 40.03.403 40.03.683
<b>description</b>		power contactor resistive load 60A 230VAC (AC3/400V) 32A/16kW main contacts 3NO auxiliary contacts 1NO connection screw connection type AEG LS15K 00A type GE CL04A 310 H 98mm L 87mm W 55mm	
<b>For models:</b>		CC201, CCC102, CCC201, CCC202, CCD101, CCD102, CCD201, CCD202, CCM102, CCM201, CCM202, CD101, CD102, CD201, CD202, CD61, CM101, CM102, CM201, CM202, CM61, CPC101, CPC102, CPC201, CPC202, CPC61, SCC102, SCC201, SCC202, SCC62	

			
1			
<b>GEV No.</b>	380396	<b>Ref. No.</b>	3028.0102 3028.0117 3028.0121 3028.0128 3028.0205 3028.0217 3028.0403 3028.0414 3028.0417 3028.0453 3028.0455 3028.0513 3028.0514 3028.0558 40.01.556 40.01.557 40.02.551 40.02.552 40.02.580 40.02.811 40.02.888 40.03.693
<b>description</b>		power contactor resistive load 60A 230VAC main contacts 3NO auxiliary contacts 1NO	
<b>For models:</b>		CC201, CD101, CD102, CD20, CD201, CM101, CM102, CM201, CM61, CM62, CPC102, CPC201, SCC101, SCC102, SCC201, SCC61, SCC62	

			
1			
<b>GEV No.</b>	380266	<b>Ref. No.</b>	3028.0102 3028.0117 3028.0121 3028.0128 3028.0205 3028.0217 3028.0403 3028.0414 3028.0417 3028.0453 3028.0455 3028.0513 3028.0514 3028.0558 40.01.556 40.01.557 40.02.551 40.02.552 40.02.580 40.02.811 40.02.888 40.03.693
<b>description</b>		power contactor resistive load 90A 230VAC (AC3/400V) 22kW main contacts 3NO connection screw type AEG LS22K 00A type GE CL06A 300	

auxiliary contacts

			
1			
<b>GEV No.</b>	380269	<b>Ref. No.</b>	3028.0561
<b>description</b>		auxiliary contact contacts 1NC AC15 6A for contactors CL+LS_K connection screw AC-12 10A type AEG HS07K 01 type GE BCLF 01	
<b>For models:</b>		CD101, CD102, CD201, CD202, CD61, CM102, CM201, CPC101, CPC102, CPC201, CPC61	

			
1			
<b>GEV No.</b>	380241	<b>Ref. No.</b>	3028.0158
<b>description</b>		auxiliary contact contacts 1NC for contactors M+LS05 connection screw AC-12 10A type AEG HS05 01LS type GE MACL 101AT	
<b>For models:</b>		CCC201, CCC202, CCM201, CCM202	



 <p>1</p>			
<b>GEV No.</b>	380268	<b>Ref. No.</b>	3028.0153 3028.0560 8720.1582
<b>description</b>	auxiliary contact contacts 1NO for contactors CL+LS_K connection screw AC-12 10A type AEG HS07K 10 type GE BCLF 10		
<b>For models:</b>	CCC101, CCC102, CCC201, CCC202, CCC61, CCD102, CCD202, CCM101, CCM102, CCM201, CCM202, CCM61, CD101, CD102, CD201, CD202, CD61, CM101, CM102, CM201, CM202, CM61, CPC101, CPC102, CPC201, CPC202, CPC61, SCC201, SCC202		

 <p>1</p>			
<b>GEV No.</b>	380240	<b>Ref. No.</b>	3028.0161
<b>description</b>	auxiliary contact contacts 1NO for contactors M+LS05 connection screw AC-12 10A type AEG HS05 10LS type GE MACL 110AT		

motor protection circuit breakers

 <p>1</p>			
<b>GEV No.</b>	380169	<b>Ref. No.</b>	3031.0101 3031.0110
<b>description</b>	motor protection circuit breaker		
<b>For models:</b>	CC101, CC6, CD101, CM101		

 <p>1</p>			
<b>GEV No.</b>	380170	<b>Ref. No.</b>	3031.0103
<b>description</b>	motor protection circuit breaker		
<b>For models:</b>	CC201, CD20, CD201, CM201		

MOELLER/EATON

power contactors

 <p>1</p>			
<b>GEV No.</b>	381224	<b>Ref. No.</b>	3028.0104
<b>description</b>	power contactor resistive load 16A main contacts 4NO type DIL04-40 230V		
<b>For models:</b>	CD101		

 <p>1</p>			
<b>GEV No.</b>	380515	<b>Ref. No.</b>	3028.0100 3028.0200
<b>description</b>	power contactor resistive load 20A 230VAC (AC3/400V) 4kW main contacts 4		
<b>For models:</b>	CD101, CD20, CD201, CM101, CM201		

 <p>1</p>			
<b>GEV No.</b>	380171	<b>Ref. No.</b>	3028.0118
<b>description</b>	power contactor resistive load 20A 230VAC (AC3/400V) 9A/4kW main contacts 3NO auxiliary contacts 1NO connection screw connection type DILEM 10		



			
1			
<b>GEV No.</b>	380497	<b>Ref. No.</b>	3028.0204 3028.0218 3028.0221 3028.0300 3028.0400 3028.0410 3028.0411 3028.0418 3028.0450 3028.0454 3028.0460 3028.0500 3028.0501 3028.0502 3028.0506 3028.0551 40.01.554
<b>description</b>	power contactor resistive load 20A 230VAC (AC3/400V) 9A/4kW main contacts 4NO auxiliary contacts connection screw connection type DILEM 4		
<b>For models:</b>	CC101, CC201, CC6, CCC101, CCC61, CCD61, CCM101, CCM61, CD101, CD201, CD61, CM101, CM102, CM201, CM61, CM62, CPC101, CPC102, CPC201, CPC61, SCC61		

			
2			
<b>GEV No.</b>	380167	<b>Ref. No.</b>	3028.0102 3028.0117 3028.0121 3028.0128 3028.0205 3028.0217 3028.0403 3028.0414 3028.0417 3028.0453 3028.0455 3028.0513 3028.0514 3028.0558 40.01.556 40.01.557 40.02.551 40.02.552 40.02.580 40.02.811 40.02.888 40.03.693
<b>description</b>	power contactor resistive load 66A 230VAC (AC3/400V) 50A/22kW main contacts 3NO auxiliary contacts 1NO connection screw connection type DILM 50		

motor protection circuit breakers			
			
1			
<b>GEV No.</b>	380163	<b>Ref. No.</b>	3031.0108
<b>description</b>	motor protection circuit breaker type PKZM		

auxiliary contacts			
			
1			
<b>GEV No.</b>	380175	<b>Ref. No.</b>	3028.0151
<b>description</b>	auxiliary contact contacts 1NO/1NC connection screw		
<b>For models:</b>	CD101, CD201, CM101		

TELEMECANIQUE (Schneider Electric)

auxiliary contactors			
			
1			
<b>GEV No.</b>	380367	<b>Ref. No.</b>	3028.0110 3028.0112
<b>description</b>	auxiliary contactor 230VAC AC1 10A type CA2SK11P7 connection screw contacts 1NO/1NC		
<b>For models:</b>	CM201, CPC201		

			
1			
<b>GEV No.</b>	380188	<b>Ref. No.</b>	3028.0110 3028.0112
<b>description</b>	small relay switch main contacts 1NO auxiliary contacts 1NC supply at 50-60Hz 220-240V		



ABL SURSUM

motor protection circuit breakers



1

<b>GEV No.</b>	380300	<b>Ref. No.</b>	3031.0105 3031.0106
<b>description</b>	motor protection circuit breaker type Mbs25-016 setting range 1-1.6A (AC3/400V) 0.55kW		
<b>For models:</b>	CC101, CC6, CD101, CM101		
<b>accessories for</b>	380300		
	<b>GEV No.</b>	380305	<b>Ref. No.</b> 3031.0099 3031.0102
auxiliary contact contacts 1NO/1NC HMS11			



1

<b>GEV No.</b>	380301	<b>Ref. No.</b>	3031.0107
<b>description</b>	motor protection circuit breaker type Mbs25-025 setting range 1.6-2.5A (AC3/400V) 1.1kW		
<b>For models:</b>	CC201, CD20, CD201, CM201		



1

<b>GEV No.</b>	380304	<b>Ref. No.</b>	3031.0108
<b>description</b>	motor protection circuit breaker type MS25-10 setting range 6.3-10A (AC3/400V) 4kW		
<b>For models:</b>	CD20		

accessories



1

<b>GEV No.</b>	380305	<b>Ref. No.</b>	3031.0099 3031.0102
<b>description</b>	auxiliary contact contacts 1NO/1NC HMS11		
<b>For models:</b>	CC101, CC201, CC6, CD101, CD20, CD201, CM101, CM201		

TRIPUS (Eichhoff)

small relay switches



1

<b>GEV No.</b>	380397	<b>Ref. No.</b>	3028.0601
<b>description</b>	small relay switch 24V main contacts 1NO/1NC connection Faston 6.3mm resistive load 16A		
<b>For models:</b>	CCC101, CCC102, CCC201, CCC202, CCC61, CCM101, CCM102, CCM201, CCM202, CCM61		

miscellaneous

accessories



1

<b>GEV No.</b>	380841	<b>Ref. No.</b>	3028.1001 87.00.429
<b>description</b>	conversion kit for contactor		



power contactors



1

<b>GEV No.</b>	380165	<b>Ref. No.</b>	3028.0204 3028.0218 3028.0221 3028.0300 3028.0400 3028.0410 3028.0411 3028.0418 3028.0450 3028.0454 3028.0460 3028.0500 3028.0501 3028.0502 3028.0506 3028.0551 40.01.554
<b>description</b>	power contactor		



1

<b>GEV No.</b>	380168	<b>Ref. No.</b>	3028.0103 3028.0120 3028.0125 3028.0129 3028.0203 3028.0220 3028.0413 3028.0503 3028.0504 3028.0505 3028.0507 3028.0550 40.02.805 40.02.882 40.03.688
<b>description</b>	power contactor		



1

<b>GEV No.</b>	380289	<b>Ref. No.</b>	3025.0103
<b>description</b>	power contactor resistive load 20A		



1

<b>GEV No.</b>	381225	<b>Ref. No.</b>	87.00.427
<b>description</b>	power contactor set		

solid state relays

CELDUC

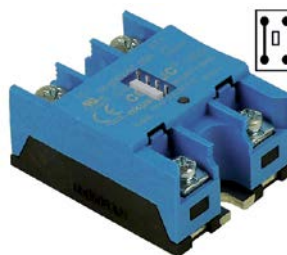

1

<b>GEV No.</b>	401672	<b>Ref. No.</b>	40.00.453P Alternativ
<b>description</b>	solid state relay CELDUC 2 phase 50A 24-600V 7.5-25VDC L 58mm W 46mm jumper at L1 and L2 screw type SOB665200 7.5-25VDC		
<b>accessories for</b>	401672		
	<b>GEV No.</b>	<b>Ref. No.</b>	8720.1584
	connecting cable L 1440mm 4-pole suitable for RATIONAL		



1

<b>GEV No.</b>	400105	<b>Ref. No.</b>	3028.0533 3028.0533P 40.00.453 40.00.453P 40.01.589
<b>description</b>	solid state relay CELDUC 2 phase 65A 400V 24VDC L 58mm W 45mm plug-in connection screw type 40.00.453		
<b>For models:</b>	CD101, CM101, CM102, CM201, CM202, CM61, CM62, CPC101, CPC102, CPC201, CPC202, SCC61, SCC62		
<b>accessories for</b>	400105		
	<b>GEV No.</b>	<b>Ref. No.</b>	8720.1584
	connecting cable L 1440mm 4-pole suitable for RATIONAL		



CRYDOM



1

<b>GEV No.</b>	401670	<b>Ref. No.</b>	8720.1583
<b>description</b>	solid state relay		

relays

power relays

with male contacts

female contact 2.0mm



1

<b>GEV No.</b>	380502	<b>Ref. No.</b>	3035.0485
<b>description</b>	power relays connection 2.0 plug-in connection		
<b>For models:</b>	CD101, CM102, CM201, CM202, CPC101, CPC102, CPC201, CPC202, CPC61		

plug-in/print relays



1

<b>GEV No.</b>	380501	<b>Ref. No.</b>	3035.0486 3035.0490
<b>description</b>	print relay 12VDC		
<b>For models:</b>	CD101, CPC101, CPC102, CPC201, CPC202, CPC61		

time relays

time relays



1

<b>GEV No.</b>	380281	<b>Ref. No.</b>	3035.0200 3035.0400 3035.0401 3035.0410
<b>description</b>	time relay FINDER 82.11.0.240 time range 0.05s-10h 24-240VAC/24-48VDC 5A 1CO		
<b>For models:</b>	CD101, CD20, CD201		



1

<b>GEV No.</b>	380283	<b>Ref. No.</b>	3035.0402 3035.0411
<b>description</b>	time relay FINDER 82.41.0.240 time range 0.05s-10h 24-240VAC/24-48VDC 5A		
<b>For models:</b>	CD101, CD20, CD201		



1

<b>GEV No.</b>	380319	<b>Ref. No.</b>	3035.0453
<b>description</b>	time relay pickup-delayed 0.06-150s		
<b>For models:</b>	CM102, CPC102		



1

<b>GEV No.</b>	380280	<b>Ref. No.</b>	3035.0200 3035.0400 3035.0401 3035.0410
<b>description</b>	time relay WIELAND NGZ11 time range 1.5-30s 24-240V AC/DC 5A connection grip connection		



1

<b>GEV No.</b>	380282	<b>Ref. No.</b>	3035.0402 3035.0411
<b>description</b>	time relay WIELAND NGZ310 time range 1.5-30s 24-240V AC/DC 5A connection grip connection		



1

<b>GEV No.</b>	403057	<b>Ref. No.</b>	3037.0107 3037.0245
<b>description</b>	transformer primary 400/415/440/480V secondary 208/240V 192/460VA 50/60Hz		
<b>For models:</b>	CD101, CD61, CM101, CM102, CM61, CPC101, CPC61		

transformers

open transformers

with clamp terminal



1

<b>GEV No.</b>	400104	<b>Ref. No.</b>	3037.0242
<b>description</b>	transformer primary 230VAC secondary 24VAC 40VA secondary 1.7A connection screw 50/60Hz with fuse		
<b>For models:</b>	CM101, CM102, CM201, CM61, CPC101, CPC102, CPC201, CPC61		

with plug connection



1

<b>GEV No.</b>	400101	<b>Ref. No.</b>	3037.0240
<b>description</b>	transformer primary 200-260VAC secondary 4.2/14.4/11.5VAC 68.4VA		
<b>For models:</b>	CD101, CM101, CM102, CM201, CM202, CM61, CPC101, CPC102, CPC201, CPC202, CPC61		

encapsulated transformers

multiple connections



1

<b>GEV No.</b>	403774	<b>Ref. No.</b>	3037.0246
<b>description</b>	transformer primary 400/415/440/480 secondary 240/208 320/820VA secondary 1.33A H 107mm L 120mm W 105mm type block for combi-steamer CPC-L. 102/201/202		
<b>For models:</b>	CD102, CD201, CD202, CM102, CM201, CM202, CPC102, CPC201, CPC202		



1

<b>GEV No.</b>	400117	<b>Ref. No.</b>	3037.0204
<b>description</b>	transformer primary 200-230V secondary 11.5V 20VA 50/60Hz temperature restriction 131°C ambient temperature max. 60°C		
<b>For models:</b>	CCC201, CCC202, CCD201, CCD202, CCM201, CCM202, CD201, CD202		



1

<b>GEV No.</b>	400794	<b>Ref. No.</b>	3037.0100 3037.0102 3037.0104 3037.0105 3037.0108 3037.0109 3037.0110 3037.0217
<b>description</b>	transformer primary 400/415/440/480V secondary 200/230/240V 150VA connection screw connection 50/60Hz		





1

<b>GEV No.</b>	400102	<b>Ref. No.</b>	3037.0205
<b>description</b>	transformer primary 230VAC secondary 11.5VAC 10VA		
<b>For models:</b>	CCC101, CCC102, CCC61, CCD101, CCD102, CCD61, CCM101, CCM102, CCM61, CD101, CD102, CD61		









			
1			
<b>GEV No.</b>	400118	<b>Ref. No.</b>	3037.0203
<b>description</b>	transformer primary 230VAC secondary 21VAC 35VA		
<b>For models:</b>	CCC101, CCC102, CCC201, CCC202, CCC61, CCM101, CCM102, CCM201, CCM202, CCM61, CM202, CPC202		

			
1			
<b>GEV No.</b>	401471	<b>Ref. No.</b>	40.00.333
<b>description</b>	transformer primary 230V secondary 11.5V 20VA		
<b>For models:</b>	CM201, CM202		

with plug connection

			
1			
<b>GEV No.</b>	401472	<b>Ref. No.</b>	40.00.277
<b>description</b>	transformer 1/20/50VA secondary A H 70mm L 76mm W 104mm connection plug 50/60Hz type 110170 with fuse secondary 2.1/11.5/12VAC primary 230VAC		
<b>For models:</b>	CM101, CM102, CM201, CM202, CM61, CM62, SCC101, SCC102, SCC201, SCC202, SCC61, SCC62		
<b>spare parts for</b>	401472		
		<b>GEV No.</b>	358602
		<b>Ref. No.</b>	—
	fine fuse size ø5x20mm 1.6A slow-acting rated 250V Qty 10 pcs		

			
1			
<b>GEV No.</b>	401473	<b>Ref. No.</b>	40.00.592
<b>description</b>	transformer 21.6VA H 70mm L 94mm W 71mm connection plug 50-60Hz type 40.00.592 moulded secondary 12VDC primary 200-250VAC		
<b>For models:</b>	CM201, CM202, SCC201, SCC202		

			
1			
<b>GEV No.</b>	401470	<b>Ref. No.</b>	40.00.278
<b>description</b>	transformer primary 230V secondary 11.5V 10VA		
<b>For models:</b>	CM101, CM102, CM61, CM62		

electronic controllers

ELIWELL

universal controllers

built-in version









			
1			
<b>GEV No.</b>	378303	<b>Ref. No.</b>	40.01.360
<b>description</b>	electronic controller ELIWELL type IDPlus 902 mounting measurements 71x29mm 230V voltage AC NTC/Pt1000/PTC relay outputs 8A -55 up to +150°C display 3 digits + algebraic sign		
<b>accessories for</b>	378303		
		<b>GEV No.</b>	379052
		<b>Ref. No.</b>	—
	temperature probe PTC 1kOhm cable silicone probe -50 up to +150°C cable -50 up to +180°C probe ø6x40mm cable length 1.5m without screw connection 2-wire		
		<b>GEV No.</b>	379053
		<b>Ref. No.</b>	—
	temperature probe PTC 1kOhm cable PVC probe -50 up to +150°C cable -10 up to 100°C probe ø6x30mm cable length 3m without screw connection 2-wire		
		<b>GEV No.</b>	379064
		<b>Ref. No.</b>	—
	temperature probe PTC 1kOhm cable silicone probe -50 up to +150°C cable -50 up to +180°C probe ø6x40mm cable length 3m without screw connection 2-wire		
		<b>GEV No.</b>	379142
		<b>Ref. No.</b>	—
	temperature probe PTC 1kOhm cable PVC probe -50 up to +150°C cable -10 up to 100°C probe ø6x30mm cable length 1.5m without screw connection 2-wire		
		<b>GEV No.</b>	379160
		<b>Ref. No.</b>	—
	temperature probe NTC 10kOhm cable thermoplastic probe -40 up to +110°C cable -40 up to +110°C probe ø6x14mm cable length 1.5m without screw connection 2-wire		
		<b>GEV No.</b>	379161
		<b>Ref. No.</b>	—
	temperature probe NTC 10kOhm cable thermoplastic probe -40 up to +110°C cable -40 up to +110°C probe ø6x14mm cable length 3m without screw connection 2-wire		
		<b>GEV No.</b>	379162
		<b>Ref. No.</b>	—
	temperature probe NTC 10kOhm cable thermoplastic probe -40 up to +110°C cable -40 up to +110°C probe ø6x14mm cable length 6m 2-wire		
		<b>GEV No.</b>	379169
		<b>Ref. No.</b>	—
	temperature probe NTC 10kOhm cable thermoplastic probe -40 up to +110°C cable -40 up to +110°C probe ø6x14mm cable length 2m without screw connection 2-wire		

Table continues overleaf



accessories for 378303			
GEV No.	379199	Ref. No.	—
temperature probe PTC 1kOhm cable PVC probe -50 up to +150°C cable -10 up to 100°C probe ø6x30mm cable length 5m without screw connection 2-wire			
GEV No.	379343	Ref. No.	—
temperature probe NTC 10kOhm cable silicone probe -40 up to +110°C cable -50 up to +180°C probe ø6x40mm cable length 3m 2-wire			
GEV No.	379458	Ref. No.	—
temperature probe NTC 10kOhm cable silicone probe -40 up to +110°C cable -50 up to +180°C probe ø6x40mm cable length 1.5m without screw connection 2-wire			
GEV No.	379630	Ref. No.	—
temperature probe NTC 10kOhm cable thermoplastic probe -40 up to +110°C cable -40 up to +110°C probe ø6x14mm cable length 2.5m without screw connection 2-wire resistor 10kOhm			

### miscellaneous

#### universal controllers

			
1			
GEV No.	379020	Ref. No.	3014.0110 3014.0111 3014.0113 3014.0114
description	electronic controller Pt100 steam control		
For models:	CD101, CD20, CD201		

### probes

#### producer-specific probes

##### probes

			
1			
GEV No.	379430	Ref. No.	40.01.095
description	core temperature probe thermocouple K (NiCr-Ni) cable silicone probe -50 up to 1150°C cable -50 up to +180°C connection coded plug thread probe ø1.5x140mm cable length 1.65m		
For models:	CM101, CM102, CM202, SCC101, SCC102, SCC202		

			
1			
GEV No.	381428	Ref. No.	3014.0151
description	temperature probe Pt100 cable silicone probe -100 up to 450°C cable -50 up to +180°C connection 2-wire thread M6 probe ø4x100mm cable length 1.5m		
For models:	CC101, CC201, CC6, CM101, CM201, CM62		

			
1			
GEV No.	381429	Ref. No.	3014.0156 3014.0158
description	temperature probe Pt100 cable silicone probe -100 up to 450°C cable -50 up to +180°C connection 2-wire thread probe ø3.2x100mm cable length 2.6m		
For models:	CC101, CC201, CC6, CM101, CM201, CM62		

			
1			
GEV No.	381427	Ref. No.	3014.0120 3014.0150 3014.0152
description	temperature probe Pt100 cable silicone probe -50 up to +250°C cable -50 up to +180°C connection 2-wire thread probe ø4x75mm cable length 1.7m		
For models:	CC101, CC6, CD101, CD20, CD201, CM101, CM201		

			
1			
GEV No.	381431	Ref. No.	3014.0165 3014.1011 3014.1012 3014.1013 3014.1014
description	temperature probe thermocouple K (NiCr-Ni) cable silicone probe -50 up to 1150°C cable -50 up to +180°C connection 2-wire thread probe ø1.5x100mm cable length 1.8m		
For models:	CC101, CC201, CC6, CCC101, CCC102, CCC201, CCC202, CCC61, CCD101, CCD102, CCD201, CCD202, CCD61, CCM101, CCM102, CCM201, CCM202, CCM61, CD101, CD102, CD201, CD202, CD61, CM101, CM102, CM201, CM202, CM61, CPC101, CPC102, CPC201, CPC202, CPC61		

			
1			
GEV No.	379429	Ref. No.	3014.1017 3014.1018 3014.1019 3014.1020
description	temperature probe thermocouple K (NiCr-Ni) cable silicone probe -50 up to 1150°C cable -50 up to +180°C connection 2-wire thread probe ø10.5mm cable length 1.7m		
For models:	CM101, CM102, CM201, CM61, CPC101, CPC102, CPC201, CPC202, CPC61		

			
1			
GEV No.	381430	Ref. No.	3014.1000
description	temperature probe thermocouple K (NiCr-Ni) cable silicone probe -50 up to 1150°C cable -50 up to +180°C connection 2-wire thread probe ø2x100mm cable length 0.25m		
For models:	CD101, CD61, CM101, CM102, CM201, CM202, CM61, CPC101, CPC102, CPC201, CPC202, CPC61		

			
1			
GEV No.	381433	Ref. No.	3014.1001 3014.1002 3014.1003 3014.1004 3014.1005
description	temperature probe thermocouple K (NiCr-Ni) cable silicone probe -50 up to 1150°C cable -50 up to +180°C connection 2-wire thread probe ø2x100mm cable length 2.2m		
For models:	CM101, CM102, CM201, CM202, CM61, CPC101, CPC102, CPC201, CPC202, CPC61		



<b>GEV No.</b>	381424	<b>Ref. No.</b>	3014.0160 8720.1003
<b>description</b>	temperature probe thermocouple K (NiCr-Ni) cable silicone probe -50 up to 1150°C cable -50 up to +180°C connection 2-wire thread probe ø2x100mm cable length 2m		
<b>For models:</b>	CCC101, CCC102, CCC201, CCC202, CCC61, CCM101, CCM102, CCM201, CCM202, CCM61		

<b>GEV No.</b>	381432	<b>Ref. No.</b>	3014.0161 3014.1006 3014.1007 3014.1008 3014.1009 3014.1010 3014.1016 8720.1002
<b>description</b>	temperature probe thermocouple K (NiCr-Ni) cable silicone probe -50 up to 1150°C cable -50 up to +180°C connection 2-wire thread probe ø2x40mm cable length 2.6m		
<b>For models:</b>	CCC101, CCC102, CCC201, CCC202, CCC61, CCD101, CCD102, CCD201, CCD61, CCM101, CCM102, CCM201, CCM202, CCM61, CD101, CD102, CD201, CD202, CD61, CM101, CM102, CM201, CM202, CM61, CPC101, CPC102, CPC201, CPC202, CPC61		

<b>GEV No.</b>	379425	<b>Ref. No.</b>	3014.0157
<b>description</b>	temperature probe thermocouple K (NiCr-Ni) cable silicone probe -50 up to 1150°C cable -50 up to +180°C connection 2-wire thread probe ø3x280mm cable length 2m		
<b>For models:</b>	CM101, CM201, CM62		

<b>GEV No.</b>	378351	<b>Ref. No.</b>	40.03.528
<b>description</b>	temperature probe thermocouple K (NiCr-Ni) cable silicone probe -50 up to 1150°C cable -50 up to +180°C connection coded plug thread M8 probe ø2x135mm cable length 1.3m		

<b>GEV No.</b>	379864	<b>Ref. No.</b>	40.00.395 40.00.594 40.01.097 40.01.099
<b>description</b>	temperature probe thermocouple K (NiCr-Ni) cable silicone probe -50 up to 1150°C cable -50 up to +180°C connection coded plug thread M8 probe ø2x50mm cable length 1.2m		
<b>For models:</b>	CM101, CM102, CM201, CM202, CM61, CM62, SCC101, SCC102, SCC201, SCC202, SCC61, SCC62		

<b>GEV No.</b>	379873	<b>Ref. No.</b>	40.00.292
<b>description</b>	temperature probe thermocouple K (NiCr-Ni) cable silicone probe -50 up to 1150°C cable -50 up to +180°C connection coded plug thread probe ø1.5x180mm cable length 1.6m		
<b>For models:</b>	CM201, SCC201		

<b>GEV No.</b>	379441	<b>Ref. No.</b>	40.00.291
<b>description</b>	temperature probe thermocouple K (NiCr-Ni) cable silicone probe -50 up to 1150°C cable -50 up to +180°C connection coded plug thread probe ø2x125mm cable length 1.5m		
<b>For models:</b>	CM101, CM102, CM201, CM202, CM61, CM62, SCC101, SCC102, SCC201, SCC202, SCC61, SCC62		

<b>GEV No.</b>	379869	<b>Ref. No.</b>	40.00.287 40.00.398 87.00.058
<b>description</b>	temperature probe thermocouple K (NiCr-Ni) cable silicone probe -50 up to 1150°C cable -50 up to +180°C connection coded plug thread probe ø2x70mm cable length 2.5m		
<b>For models:</b>	CM101, CM102, CM201, CM202, CM61, CM62, SCC101, SCC102, SCC201, SCC202, SCC61, SCC62		

<b>GEV No.</b>	379442	<b>Ref. No.</b>	40.01.094
<b>description</b>	temperature probe thermocouple K (NiCr-Ni) cable silicone probe -50 up to 1150°C cable -50 up to +180°C connection coded plug thread probe ø2x90mm cable length 1.5m		
<b>For models:</b>	CM61, CM62, SCC61, SCC62		

<b>GEV No.</b>	379870	<b>Ref. No.</b>	40.00.290 40.00.399 87.00.470
<b>description</b>	temperature probe thermocouple K (NiCr-Ni) cable silicone probe -50 up to 1150°C cable -50 up to +180°C connection coded plug thread probe ø4.2mm cable length 1.7m		
<b>For models:</b>	SCC101, SCC102, SCC201, SCC202, SCC61, SCC62		

core probes

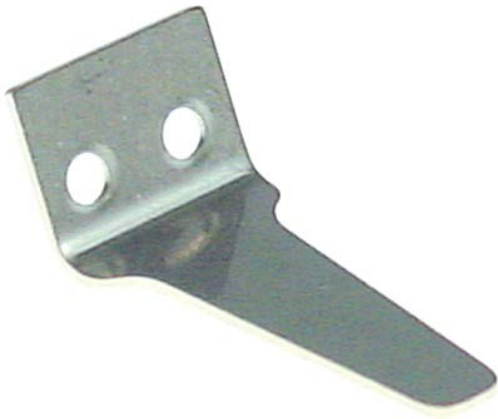

1	<b>GEV No.</b>	693523	<b>Ref. No.</b>	22.00.479
	<b>description</b>	bracket		

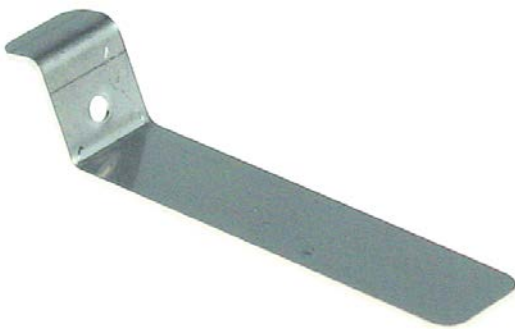

1	<b>GEV No.</b>	693522	<b>Ref. No.</b>	22.00.480
	<b>description</b>	bracket for core temperature probe		



1	<b>GEV No.</b>	693524	<b>Ref. No.</b>	22.00.453
	<b>description</b>	bracket for core temperature probe L 80mm ø 16mm		



1	<b>GEV No.</b>	379867	<b>Ref. No.</b>	40.00.298 40.00.298P 40.01.943 87.00.097
	<b>description</b>	conversion kit thermocouple K (NiCr-Ni) cable PTFE probe -40 up to +250°C cable -40 up to +250°C connection plug probe ø3x100mm thread M16 cable length 2.2m handle ø 10mm handle length 40mm		



1	<b>GEV No.</b>	379874	<b>Ref. No.</b>	40.00.298 40.01.943 87.00.097
	<b>description</b>	core temperature probe		
	<b>For models:</b>	CM102, CM201, CM202		



1	<b>GEV No.</b>	378646	<b>Ref. No.</b>	24.01.122
	<b>description</b>	core temperature probe cable PTFE connection coded plug probe ø3x100mm cable length 2.7m handle ø 12mm handle length 44mm		







1	<b>GEV No.</b>	381443	<b>Ref. No.</b>	40.04.040P
	<b>description</b>	core temperature probe CM_P 61-102 cable PTFE insulated probe -40 up to +250°C probe ø3x100mm cable length 2.45m handle ø 12mm handle length 44mm		



1	<b>GEV No.</b>	381425	<b>Ref. No.</b>	3035.0604 3035.0605 3035.0607 3035.0608 3035.0623 3035.0627 3035.0703 3035.0706 3035.0707
	<b>description</b>	core temperature probe Pt100 cable PTFE probe -40 up to +250°C cable -40 up to +250°C connection 2-wire probe ø3.2x100mm thread M12 cable length 2.8m handle ø 10mm handle length 80mm		
	<b>For models:</b>	CC101, CC201, CC6, CD101, CD20, CD201, CM101, CM201, CM62		



			
<b>GEV No.</b>	381426	<b>Ref. No.</b>	3035.0700 3035.0701 3035.0708 3035.0709 3035.0710 3035.0711 3035.0712 3035.0713
<b>description</b>	core temperature probe thermocouple K (NiCr-Ni) cable PTFE probe -40 up to +250°C cable -40 up to +250°C connection 2-wire probe ø3.2x100mm thread M12 cable length 1.9m handle ø 10mm handle length 100mm		
<b>For models:</b>	CCC101, CCC61, CCD101, CCD61, CCM101, CCM61, CD101, CD61, CM101, CM102, CM201, CM202, CM61, CPC101, CPC102, CPC201, CPC202, CPC61		

			
<b>GEV No.</b>	379792 <sup>1</sup>	<b>Ref. No.</b>	3035.0714 3035.0715 3035.0716 3035.0717 3035.0717ET 30350ET
<b>description</b>	core temperature probe thermocouple K (NiCr-Ni) cable PTFE probe -40 up to +250°C cable -40 up to +250°C connection grip connection probe ø3.2x100mm thread M16x2 cable length 1.9m handle ø 10mm handle length 40mm		
<b>For models:</b>	CM102, CPC101, CPC102, CPC201, CPC202, CPC61		
<b>accessories for</b>	379792		
	<b>GEV No.</b>	510179	<b>Ref. No.</b> —
	flat gasket fibre ED ø 18mm ID ø 13mm thickness 1.5mm Qty 1 pcs		
	<b>GEV No.</b>	560519	<b>Ref. No.</b> —
	nut thread M12x1 H 5mm WS 17 SS Qty 1 pcs		

<sup>1</sup> multipoint probe

			
<b>GEV No.</b>	379868 <sup>1</sup>	<b>Ref. No.</b>	40.00.295 40.01.942 87.00.096
<b>description</b>	core temperature probe thermocouple K (NiCr-Ni) cable PTFE probe -40 up to +250°C cable -40 up to +250°C connection plug probe ø3x100mm thread M16 cable length 2.2m handle ø 10mm handle length 40mm		
<b>For models:</b>	SCC102, SCC201, SCC202		

<sup>1</sup> multipoint probe

			
<b>GEV No.</b>	379871	<b>Ref. No.</b>	40.02.100 40.02.100P 40.02.101
<b>description</b>	core temperature probe thermocouple K (NiCr-Ni) cable PTFE probe -40 up to +250°C cable -40 up to +250°C connection plug probe ø3x100mm thread M16 cable length 2.2m handle ø 10mm handle length 40mm		
<b>For models:</b>	SCC201, SCC202		

			
<b>GEV No.</b>	379872	<b>Ref. No.</b>	40.02.102 40.02.102P 40.02.103
<b>description</b>	core temperature probe thermocouple K (NiCr-Ni) cable PTFE probe -40 up to +250°C cable -40 up to +250°C connection plug probe ø3x100mm thread M16 cable length 2.2m handle ø 10mm handle length 40mm		
<b>For models:</b>	CM201, CM202		

			
<b>GEV No.</b>	379865	<b>Ref. No.</b>	40.00.296 40.00.297 40.00.608 40.00.608P 40.01.603
<b>description</b>	core temperature probe thermocouple K (NiCr-Ni) cable PTFE probe -40 up to +250°C cable -40 up to +250°C connection plug probe ø3x100mm thread M16 cable length 2.3m handle ømm handle length 50mm		
<b>For models:</b>	CM101, CM102, CM61, CM62		

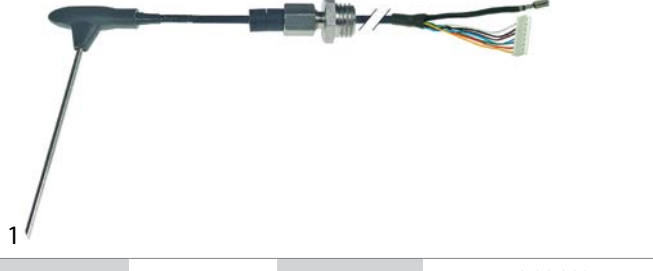
			
<b>GEV No.</b>	379866 <sup>1</sup>	<b>Ref. No.</b>	40.00.293 40.00.294 40.00.606 40.00.606P 40.01.604 40.04.097
<b>description</b>	core temperature probe thermocouple K (NiCr-Ni) cable PTFE probe -40 up to +250°C cable -40 up to +250°C connection plug probe ø3x100mm thread M16 cable length 2.3m handle ømm handle length 50mm		
<b>For models:</b>	SCC101, SCC102, SCC202, SCC61, SCC62		

<sup>1</sup> multipoint probe





accessories

screw connections



<b>GEV No.</b>	550366	<b>Ref. No.</b>	3014.0163
----------------	--------	-----------------	-----------

**description** screw for thermocouple

**For models:** CCC101, CCC102, CCC201, CCC202, CCC61, CCD101, CCD201, CCD61, CCM101, CCM102, CCM201, CCM202, CCM61, CD101, CD102, CD201, CD202, CD61, CM101, CM102, CM201, CM202, CM61, CM62, CPC101, CPC102, CPC201, CPC202, CPC61, SCC101, SCC102, SCC201, SCC202, SCC61, SCC62

**accessories for** 550366



<b>GEV No.</b>	550365	<b>Ref. No.</b>	3014.0162
----------------	--------	-----------------	-----------

**description** gasket for thermocouple

miscellaneous



<b>GEV No.</b>	550365	<b>Ref. No.</b>	3014.0162
----------------	--------	-----------------	-----------

**description** gasket for thermocouple

**For models:** CCC101, CCC102, CCC201, CCC202, CCC61, CCD101, CCD201, CCD61, CCM101, CCM102, CCM201, CCM202, CCM61, CD101, CD102, CD201, CD202, CD61, CM101, CM102, CM201, CM202, CM61, CM62, CPC101, CPC102, CPC201, CPC202, CPC61, SCC101, SCC102, SCC201, SCC202, SCC61, SCC62

electronics

electronics accessories

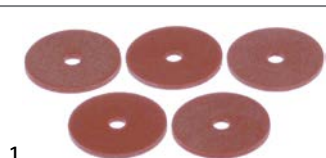

<b>GEV No.</b>	901571	<b>Ref. No.</b>	5110.1029
----------------	--------	-----------------	-----------

**description** gasket for control panel H 1mm D1 ø 18mm D2 ø 3mm silicone Qty 5 pcs

**For models:** CCD101, CCD102, CCD61, CCM101, CCM102, CCM61, CM101, CM102, CM201, CM202, CM61, CM62, CPC201, SCC101, SCC102, SCC201, SCC202, SCC61, SCC62

EPROMS



<b>GEV No.</b>	403018	<b>Ref. No.</b>	3040.0311
----------------	--------	-----------------	-----------

**description** EPROM type CPC CODE XS5.06S

**For models:** CPC101, CPC102, CPC201, CPC202, CPC61

PCBs



<b>GEV No.</b>	400084	<b>Ref. No.</b>	3040.2050
----------------	--------	-----------------	-----------

**description** control PCB

**For models:** CCM101, CCM102, CCM201, CCM202, CCM61



<b>GEV No.</b>	400100	<b>Ref. No.</b>	3040.2040
----------------	--------	-----------------	-----------

**description** control PCB

**For models:** CCC101, CCC102, CCC201, CCC202, CCC61



<b>GEV No.</b>	402920	<b>Ref. No.</b>	3040.3041
----------------	--------	-----------------	-----------

**description** control PCB combi-steamer CD 101/CM 101 suitable for RATIONAL

**For models:** CD101, CD102, CD201, CD202, CD61, CM101, CM102, CM201, CM202, CM61, CPC101, CPC102, CPC201, CPC202, CPC61

1

<b>GEV No.</b>	400098	<b>Ref. No.</b>	3040.0276 3040.3000 3040.3001 3040.3001ET
<b>description</b>	control PCB combi-steamer CD 101/CM 101 without EPROM		
<b>For models:</b>	CD101, CM101, CM102, CM201, CM202, CM61, CPC101, CPC102, CPC201, CPC202, CPC61		



1

<b>GEV No.</b>	402827	<b>Ref. No.</b>	42.00.047 42.00.047P 42.00.048
<b>description</b>	control PCB combi-steamer CM101 L 372mm W 120mm type RAL115ET		
<b>For models:</b>	CM101, CM102, CM201, CM202, CM61, CM62		



1

<b>GEV No.</b>	400103	<b>Ref. No.</b>	3040.3020
<b>description</b>	control PCB combi-steamer CM 61-202 L 460mm W 154mm 61-202		
<b>For models:</b>	CM201, CM202, CPC101, CPC102, CPC201, CPC202, CPC61		



1

<b>GEV No.</b>	403319	<b>Ref. No.</b>	3040.3210
<b>description</b>	control PCB combi-steamer CPC-Linie CM 61-202/G model since 10/1997		
<b>For models:</b>	CM101, CM102, CM201, CM202, CM61, CPC201		



1

<b>GEV No.</b>	400099	<b>Ref. No.</b>	3040.3010
<b>description</b>	control PCB combi-steamer CM101		
<b>For models:</b>	CM101, CM102, CM201, CM202, CM61		



1

<b>GEV No.</b>	401475	<b>Ref. No.</b>	42.00.002 42.00.002P
<b>description</b>	control PCB combi-steamer SCC Line		
<b>For models:</b>	SCC101, SCC102, SCC201, SCC202, SCC61, SCC62		
<b>accessories for</b>	401475		
	<b>GEV No.</b>	<b>Ref. No.</b>	4001.0224
	fine fuse size ø6.3x32mm 6.3A slow-acting rated 250V Qty 10 pcs		



1

<b>GEV No.</b>	400107	<b>Ref. No.</b>	3040.2030
<b>description</b>	control PCB combi-steamer CM101 edition CM v. 4.91-97		
<b>For models:</b>	CM101, CM201		



1

<b>GEV No.</b>	403796	<b>Ref. No.</b>	42.00.090P 42.00.161 42.00.269P
<b>description</b>	control PCB for combi-steamer CM_P 61-202 suitable for RATIONAL model Sicotronic		



1

<b>GEV No.</b>	403797	<b>Ref. No.</b>	42.00.080P 42.00.160 4200080
<b>description</b>	control PCB for combi-steamer SCC_WE, CM_P 61-202 model Sicotronic		



1

<b>GEV No.</b>	400109	<b>Ref. No.</b>	3040.0110
<b>description</b>	control PCB regulation and control electronics		
<b>For models:</b>	CM101, CM201		



1

<b>GEV No.</b>	403889	<b>Ref. No.</b>	42.00.112P 4200112
<b>description</b>	display for combi-steamer SCC_WE 61-202 complete incl. control		



1

<b>GEV No.</b>	401490	<b>Ref. No.</b>	3040.0152
<b>description</b>	keypad PCB		
<b>For models:</b>	CM101, CM201		



1

<b>GEV No.</b>	401938	<b>Ref. No.</b>	3040.2051
<b>description</b>	keypad PCB		



1

<b>GEV No.</b>	400129	<b>Ref. No.</b>	3002.0407 3016.1200 3016.1201 3016.1202 8424.1202 8720.1501
<b>description</b>	level relay		
<b>For models:</b>	CD101, CD20, CD201, CM101, CM201		



1

<b>GEV No.</b>	400111	<b>Ref. No.</b>	3002.0400 3002.0408 3040.2060 3040.2061 3040.3100 3040.3100ET
<b>description</b>	PCB		
<b>For models:</b>	CCD101, CCD102, CCD201, CCD202, CCD61, CD101, CD102, CD20, CD201, CD202, CD61, CM101, CM201		



1

<b>GEV No.</b>	401483	<b>Ref. No.</b>	3035.0601
<b>description</b>	PCB		
<b>For models:</b>	CD101, CD20, CD201		

1

<b>GEV No.</b>	401493	<b>Ref. No.</b>	3040.0121
<b>description</b>	PCB		
<b>For models:</b>	CM101, CM201, CM62		



1

<b>GEV No.</b>	401662	<b>Ref. No.</b>	42.00.004 42.00.004P 87.00.139
<b>description</b>	PCB combi-steamer CM101 conversion kit		
<b>For models:</b>	CM101, CM102, CM201, CM202, CM61, CM62		



1

<b>GEV No.</b>	401479	<b>Ref. No.</b>	3017.1000 3017.1001 3040.2602 3040.2604 8680.1018 8720.1293
<b>description</b>	PCB combi-steamer		
<b>For models:</b>	CCC101, CCC102, CCC201, CCC202, CCC61, CCM101, CCM102, CCM201, CCM202, CCM61, CPC201		



1

<b>GEV No.</b>	400110	<b>Ref. No.</b>	3002.0400 3002.0408 3040.2060 3040.2061 3040.3100 3040.3100ET
<b>description</b>	PCB combi-steamer level control		



1

<b>GEV No.</b>	400077	<b>Ref. No.</b>	3035.0660
<b>description</b>	PCB combi-steamer CCD 101/201 core temperature		
<b>For models:</b>	CCD101, CCD102, CCD201, CCD202, CCD61		



1

<b>GEV No.</b>	400033	<b>Ref. No.</b>	3037.0218 3037.0219
<b>description</b>	PCB for gas valve 240V 28V		
<b>For models:</b>	CM101, CM201, CM62		



1

<b>GEV No.</b>	401487	<b>Ref. No.</b>	3040.3040 3040.3040P
<b>description</b>	PCB combi-steamer CD 101/CM 101 with axial flow fan for fan motor		
<b>For models:</b>	CD101, CD102, CD201, CD202, CD61, CM101, CM102, CM201, CM202, CM61, CPC101, CPC102, CPC201, CPC202, CPC61		



1

<b>GEV No.</b>	401629	<b>Ref. No.</b>	40.00.049 40.00.049P 42.00.045 42.00.064P
<b>description</b>	relay shroud I/O-board SCC Line		
<b>For models:</b>	SCC101, SCC102, SCC201, SCC202, SCC61, SCC62		
<b>accessories for</b>	401629		
	<b>GEV No.</b>	358786	<b>Ref. No.</b>
	fine fuse size ø6.3x32mm 2A slow-acting rated 250V Qty 10 pcs		





## central units



1

<b>GEV No.</b>	401013	<b>Ref. No.</b>	3031.0200 3031.0201 3031.0204
<b>description</b>	motor break electronic 50/60Hz for RATIONAL breaking duration 4s type ETBO 10 (AC3/380V) 0.5kW		
<b>For models:</b>	CD20		

## keypads

## front foils



1

<b>GEV No.</b>	403795	<b>Ref. No.</b>	16.00.555
<b>description</b>	front foil for combi-steamer SCC Line L 540mm W 175mm		

1



<b>GEV No.</b>	401012	<b>Ref. No.</b>	2049.0823
<b>description</b>	keypad foil		
<b>For models:</b>	CM20-3NAC380V50Hz, CM20-3NAC400V50Hz		

## membrane keypads



1

<b>GEV No.</b>	403781	<b>Ref. No.</b>	42.00.067 42.00.067S
<b>description</b>	membrane keypad for combi-steamer SCC Line L 230mm W 124mm		

## solenoid valves



## solenoid valves (water)

## ELBI

## straight



1

<b>GEV No.</b>	373021	<b>Ref. No.</b>	3002.0300 3002.0330 3002.0330ET	
<b>description</b>	solenoid valve double straight 230VAC inlet 3/4" outlet 11.5mm output 1x 4.7l/min DN10 ELBI			
<b>For models:</b>	CC101, CC201, CC6, CCC101, CCC102, CCC201, CCC202, CCC61, CCD101, CCD102, CCM101, CCM102, CCM201, CCM202, CCM61, CD101, CD20, CD201, CM101, CM102, CM201, CM202, CM61, CPC101, CPC102, CPC201, CPC202, CPC61			
<b>spare parts for</b>	373021			
	<b>GEV No.</b>	370467	<b>Ref. No.</b>	—
	solenoid valve filter suitable for ELBI			
	<b>GEV No.</b>	371263	<b>Ref. No.</b>	—
	reducer ELBI type EATON (INVENSYS) flow rate 4.7l/min pressure range 0 up to 10bar tolerance ±15/25% grey			





1

<b>GEV No.</b>	373017	<b>Ref. No.</b>	3002.0200 3002.0331 3002.0331ET	
<b>description</b>	solenoid valve single straight 230VAC inlet 3/4" outlet 11.5mm DN10 ELBI			
<b>For models:</b>	CCC101, CCC102, CCC201, CCC202, CCC61, CCD101, CCD102, CCD201, CCD202, CCD61, CCM101, CCM102, CCM201, CCM202, CCM61, CD101, CD102, CD201, CD202, CD61, CM101, CM102, CM201, CM202, CM61, CPC101, CPC102, CPC201, CPC202, CPC61			
<b>spare parts for</b>	373017			
	<b>GEV No.</b>	370467	<b>Ref. No.</b>	—
	solenoid valve filter suitable for ELBI			





			
1			
<b>GEV No.</b>	370852	<b>Ref. No.</b>	50.00.139
<b>description</b>	solenoid valve single straight 230VAC inlet 3/4" outlet 11.5mm DN10		
<b>For models:</b>	CM101, CM102, CM201, CM202, CM61, CM62, SCC101, SCC102, SCC201, SCC202, SCC61, SCC62		

			
1			
<b>GEV No.</b>	370853	<b>Ref. No.</b>	50.01.146
<b>description</b>	solenoid valve single straight 230VAC inlet 3/4" outlet 11.5mm input 10l/min 10 flow regulating valve inlet white		
<b>For models:</b>	SCC101, SCC102, SCC201, SCC202, SCC61, SCC62		

			
1			
<b>GEV No.</b>	370851	<b>Ref. No.</b>	50.00.138
<b>description</b>	solenoid valve double straight 230VAC inlet 3/4" outlet 11.5mm DN10		
<b>For models:</b>	SCC101, SCC102, SCC201, SCC202, SCC61, SCC62		

spare parts and accessories



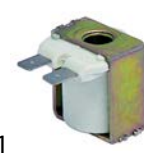







solenoid coils











			
1			
<b>GEV No.</b>	371016	<b>Ref. No.</b>	3002.0321
<b>description</b>	solenoid coil ELBI 230VAC 50/60Hz pressure range 0 up to 10bar coil type EATON (INVENSYS) tolerance ±15%		





MÜLLER

medium temperature: 90°C  
duty cycle: 100%

with cable connection

			
1			
<b>GEV No.</b>	370065	<b>Ref. No.</b>	3002.0327
<b>description</b>	solenoid valve double straight 230VAC inlet 3/4" outlet 11.5mm DN10 t.max. 90°C duty cycle 100% MÜLLER cable length 2000mm		
<b>For models:</b>	CC101, CC6, CM201		
<b>spare parts for</b>	370065		
	<b>GEV No.</b>	370195	<b>Ref. No.</b> 3002.0314
	solenoid valve body double straight inlet 3/4" outlet 11.5mm DN10 t.max. 90°C duty cycle 100% MÜLLER 230V		
	<b>GEV No.</b>	371002	<b>Ref. No.</b> —
	solenoid valve holder MÜLLER flange support		
	<b>GEV No.</b>	371009	<b>Ref. No.</b> 3002.0326
	compression spring for solenoid coil		
	<b>GEV No.</b>	371010	<b>Ref. No.</b> 3002.0324 3002.0325 3002.0329
	solenoid coil 230VAC connection with cable cable length 2000mm		
	<b>GEV No.</b>	371011	<b>Ref. No.</b> —
	spare parts kit membrane with long star star hight 8mm MÜLLER		
	<b>GEV No.</b>	371122	<b>Ref. No.</b> —
	solenoid valve filter ø 19mm H 10mm suitable for MÜLLER		
	<b>GEV No.</b>	501161	<b>Ref. No.</b> —
	tap head for solenoid valve holder for solenoid coils		
<b>accessories for</b>	370065		
	<b>GEV No.</b>	371017	<b>Ref. No.</b> —
	solenoid coil MÜLLER 230VAC connection male faston 6.3mm		
	<b>GEV No.</b>	371037	<b>Ref. No.</b> —
	solenoid coil 24VAC 50/60Hz connection male faston 6.3mm		
	<b>GEV No.</b>	371038	<b>Ref. No.</b> —
	solenoid coil 230VAC connection appliance plug		

			
<b>1</b>			
<b>GEV No.</b>	370368	<b>Ref. No.</b>	3002.0305
<b>description</b>	solenoid valve single straight 230VAC inlet 3/4" outlet 11.5mm DN10 t.max. 90°C duty cycle 100% MÜLLER cable length 2000mm		
<b>spare parts for</b>	370368		
	<b>GEV No.</b>	370133	<b>Ref. No.</b> 3002.0301
	solenoid valve body single straight inlet 3/4" outlet 11.5mm DN10 t.max. 90°C duty cycle 100% MÜLLER 230V		
	<b>GEV No.</b>	371002	<b>Ref. No.</b> —
	solenoid valve holder MÜLLER flange support		
	<b>GEV No.</b>	371009	<b>Ref. No.</b> 3002.0326
	compression spring for solenoid coil		
	<b>GEV No.</b>	371010	<b>Ref. No.</b> 3002.0324 3002.0325 3002.0329
	solenoid coil 230VAC connection with cable cable length 2000mm		
	<b>GEV No.</b>	371011	<b>Ref. No.</b> —
	spare parts kit membrane with long star star high 8mm MÜLLER		
	<b>GEV No.</b>	371122	<b>Ref. No.</b> —
	solenoid valve filter ø 19mm H 10mm suitable for MÜLLER		
	<b>GEV No.</b>	501161	<b>Ref. No.</b> —
	tap head for solenoid valve holder for solenoid coils		
<b>accessories for</b>	370368		
	<b>GEV No.</b>	371017	<b>Ref. No.</b> —
	solenoid coil MÜLLER 230VAC connection male faston 6.3mm		
	<b>GEV No.</b>	371037	<b>Ref. No.</b> —
	solenoid coil 24VAC 50/60Hz connection male faston 6.3mm		
	<b>GEV No.</b>	371038	<b>Ref. No.</b> —
	solenoid coil 230VAC connection appliance plug		

			
<b>1</b>			
<b>GEV No.</b>	370006	<b>Ref. No.</b>	3002.0328
<b>description</b>	solenoid valve triple straight 230VAC inlet 3/4" outlet 12.5mm DN10 t.max. 90°C duty cycle 100% MÜLLER cable length 2000mm		
<b>spare parts for</b>	370006		
	<b>GEV No.</b>	370132	<b>Ref. No.</b> 3002.0315
	solenoid valve body triple straight inlet 3/4" outlet 11.5mm DN10 t.max. 90°C duty cycle 100% MÜLLER 230V		
	<b>GEV No.</b>	371002	<b>Ref. No.</b> —
	solenoid valve holder MÜLLER flange support		
	<b>GEV No.</b>	371009	<b>Ref. No.</b> 3002.0326
	compression spring for solenoid coil		

<b>spare parts for</b>	370006		
	<b>GEV No.</b>	371010	<b>Ref. No.</b> 3002.0324 3002.0325 3002.0329
	solenoid coil 230VAC connection with cable cable length 2000mm		
	<b>GEV No.</b>	371011	<b>Ref. No.</b> —
	spare parts kit membrane with long star star high 8mm MÜLLER		
	<b>GEV No.</b>	371122	<b>Ref. No.</b> —
	solenoid valve filter ø 19mm H 10mm suitable for MÜLLER		
	<b>GEV No.</b>	501161	<b>Ref. No.</b> —
	tap head for solenoid valve holder for solenoid coils		
<b>accessories for</b>	370006		
	<b>GEV No.</b>	371017	<b>Ref. No.</b> —
	solenoid coil MÜLLER 230VAC connection male faston 6.3mm		
	<b>GEV No.</b>	371037	<b>Ref. No.</b> —
	solenoid coil 24VAC 50/60Hz connection male faston 6.3mm		
	<b>GEV No.</b>	371038	<b>Ref. No.</b> —
	solenoid coil 230VAC connection appliance plug		

spare parts and accessories

<b>valve bodies</b>			
			
<b>1</b>			
<b>GEV No.</b>	370195	<b>Ref. No.</b>	3002.0314
<b>description</b>	solenoid valve body double straight inlet 3/4" outlet 11.5mm DN10 t.max. 90°C duty cycle 100% MÜLLER 230V		
<b>For models:</b>	CC101, CC201, CC6, CD20, CM101, CM201		

			
<b>1</b>			
<b>GEV No.</b>	370133	<b>Ref. No.</b>	3002.0301
<b>description</b>	solenoid valve body single straight inlet 3/4" outlet 11.5mm DN10 t.max. 90°C duty cycle 100% MÜLLER 230V		
<b>For models:</b>	CD20, CM101		

			
<b>1</b>			
<b>GEV No.</b>	370132	<b>Ref. No.</b>	3002.0315
<b>description</b>	solenoid valve body triple straight inlet 3/4" outlet 11.5mm DN10 t.max. 90°C duty cycle 100% MÜLLER 230V		
<b>For models:</b>	CM101		



solenoid coils			
			
1			
<b>GEV No.</b>	371010	<b>Ref. No.</b>	3002.0324 3002.0325 3002.0329
<b>description</b>	solenoid coil 230VAC connection with cable cable length 2000mm		
<b>For models:</b>	CC101, CC201, CC6, CD20, CM101, CM201		

			
1			
<b>GEV No.</b>	370372	<b>Ref. No.</b>	3002.0311
<b>description</b>	solenoid valve triple straight 230VAC inlet 3/4" outlet 11.5mm DN10 EATON (INVENSYS) cable length 2000mm		
<b>For models:</b>	CD101, CD20, CD201, CM101, CM201		

miscellaneous			
			
1			
<b>GEV No.</b>	371009	<b>Ref. No.</b>	3002.0326
<b>description</b>	compression spring for solenoid coil		

with coded terminal			
			
1			
<b>GEV No.</b>	370840	<b>Ref. No.</b>	3002.0306 3002.0310 3002.0310ET
<b>description</b>	solenoid valve double straight 200-240VAC inlet 3/4" outlet 10.5 input 10l/min DN10 ROBERTSHAW		
<b>For models:</b>	CD101, CD61, CM101, CM102, CM201, CM202, CM61, CPC101, CPC102, CPC201, CPC202, CPC61		

**ROBERTSHAW/INVENSYS**

*medium temperature: 90°C 90°C 60°C*  
*ambient temperature: 60°C 25°C 60°C*  
*duty cycle: 40% 100% 100%*

solenoid valves with reducers			
3-fold			
			
1			
<b>GEV No.</b>	370672	<b>Ref. No.</b>	50.01.050 50.01.050S
<b>description</b>	solenoid valve triple straight 230VAC inlet 3/4" outlet 11.5mm 10 EATON (INVENSYS) plastic output C 5l/min flow regulating valve outlet C black		
<b>For models:</b>	SCC101, SCC102, SCC201, SCC202, SCC61, SCC62		

			
1			
<b>GEV No.</b>	370269	<b>Ref. No.</b>	3002.0300 3002.0330 3002.0330ET
<b>description</b>	solenoid valve double straight 230VAC inlet 3/4" outlet 11.5mm DN10 EATON (INVENSYS)		

			
1			
<b>GEV No.</b>	370371	<b>Ref. No.</b>	3002.0304
<b>description</b>	solenoid valve double straight 230VAC inlet 3/4" outlet 11.5mm DN10 EATON (INVENSYS) cable length 2000mm		
<b>For models:</b>	CC201, CD101, CD20, CD201, CM101, CM201, CM62		

			
1			
<b>GEV No.</b>	370268	<b>Ref. No.</b>	3002.0200 3002.0331 3002.0331ET 50.00.316
<b>description</b>	solenoid valve single straight 230VAC inlet 3/4" outlet 11.5mm DN10 EATON (INVENSYS)		
<b>For models:</b>	CM101, CM102, CM201, CM202, CM61, CM62		

			
1			
<b>GEV No.</b>	370370	<b>Ref. No.</b>	3002.0305
<b>description</b>	solenoid valve single straight 230VAC inlet 3/4" outlet 11.5mm DN10 EATON (INVENSYS) cable length 2000mm		
<b>For models:</b>	CD101, CD20, CD201, CM101, CM201		



			
1			
<b>GEV No.</b>	370270	<b>Ref. No.</b>	3002.0340 3002.0343ET
<b>description</b>	solenoid valve single straight 230VAC inlet 3/8" outlet 3/8" DN10 Invensys		
<b>For models:</b>	CM102, CPC102, CPC201, CPC202		



## drain valves



1

<b>GEV No.</b>	401889	<b>Ref. No.</b>	40.00.400 54.00.171 54.00.200 54.00.357 54.01.291 87.01.191
<b>description</b>	drain valve 12V single inlet 40mm outlet 40mm for combi-steamer		
<b>For models:</b>	SCC101, SCC102, SCC201, SCC202, SCC61, SCC62		
<b>accessories for</b>	401889		
	GEV No.	532727	Ref. No. 10.00.512
	O-ring silicone thickness 3.5mm ID ø 26mm Qty 5 pcs for model SCC, CM		
	GEV No.	532728	Ref. No. 10.00.511
	O-ring silicone thickness 3.5mm ID ø 46mm Qty 5 pcs for model SCC, CM		

## Solenoid valve - accessories

## filters



1

<b>GEV No.</b>	371323	<b>Ref. No.</b>	1900.0202
<b>description</b>	solenoid valve filter ø 19.5mm H 10.5mm suitable for RATIONAL coarse		
<b>For models:</b>	CCC101, CCC102, CCC201, CCC202, CCC61, CCD101, CCD102, CCD201, CCD202, CCD61, CCM101, CCM102, CCM201, CCM202, CCM61, CD101, CD102, CD201, CD202, CD61, CM101, CM102, CM201, CM202, CM61, CM62, CPC101, CPC102, CPC201, CPC202, CPC61, SCC101, SCC102, SCC201, SCC202, SCC61, SCC62		



1

<b>GEV No.</b>	699812	<b>Ref. No.</b>	50.00.086
<b>description</b>	locking plate for solenoid valve L 37mm W 29mm H 4mm		
<b>For models:</b>	CM101, CM102, CM201, CM202, CM61, CM62, SCC101, SCC102, SCC201, SCC202, SCC61, SCC62		

## pressure switches

## for gas equipment



1

<b>GEV No.</b>	541108	<b>Ref. No.</b>	3017.1004
<b>description</b>	pressure control		
<b>For models:</b>	CM101, CM102, CM201, CM202, CM61, CPC101, CPC102, CPC201, CPC202, CPC61		



1

<b>GEV No.</b>	541111	<b>Ref. No.</b>	3017.1003 3017.1006 3017.1010
<b>description</b>	pressure control pressure range adjustable 0.2- 3mbar pressure connection horizontal gas technology connection 6mm suitable for RATIONAL		
<b>For models:</b>	CM101, CM102, CM201, CM202, CM61, CPC101, CPC102, CPC201, CPC202, CPC61		

## for combi-steamers



1

<b>GEV No.</b>	345709	<b>Ref. No.</b>	3017.1011
<b>description</b>	pressure control ø 84mm pressure range 0-3mbar for humidity measuring connection 6mm p max 0.025bar pressure connection 6mm		
<b>For models:</b>	CD101, CPC101, CPC102, CPC201, CPC202, CPC61, SCC101, SCC102, SCC201, SCC202, SCC61, SCC62		



1

<b>GEV No.</b>	345218	<b>Ref. No.</b>	3017.1002
<b>description</b>	pressure control pressure range 0-3mbar connection 6mm pressure connection 6mm		
<b>For models:</b>	CPC101, CPC102, CPC201, CPC202, CPC61		



1			
<b>GEV No.</b>	541329	<b>Ref. No.</b>	2062.0356 3016.1418 3016.1441
<b>description</b>	pressure control pressure range 350/150mbar connection 8mm pressure connection 8mm		
<b>For models:</b>	CPC101, CPC102, CPC201, CPC202, CPC61		

1			
<b>GEV No.</b>	403138	<b>Ref. No.</b>	87.01.220 87.01.253
<b>description</b>	level electrode PG9 total length 100mm probe L 85mm insulated probe length 70mm with connection cable connection coded plug		

## electrodes

1			
<b>GEV No.</b>	403805	<b>Ref. No.</b>	44.01.371 44.01.420 87.01.221
<b>description</b>	level electrode M15x1.5 probe L 12mm total length 325mm insulated probe length 114mm straight connection plug-in connection ø 1.5mm EPDM		

1			
<b>GEV No.</b>	400021	<b>Ref. No.</b>	3002.0401
<b>description</b>	level electrode PG9 total length 110mm probe L 70/47/24mm insulated probe length 62/38/16mm with 3 probes connection grip connection		
<b>For models:</b>	CC6, CD101, CD102, CD201, CD202, CD61, CM61, CPC61		

1			
<b>GEV No.</b>	403298	<b>Ref. No.</b>	44.01.407 44.01.408 87.01.218
<b>description</b>	level electrode M15x1.5 total length 110mm probe L 85mm insulated probe length 75mm with extension connection coded plug ø 2mm suitable for RATIONAL		

1						
<b>GEV No.</b>	400022	<b>Ref. No.</b>	3002.0402			
<b>description</b>	level electrode PG9 total length 135mm probe L 89/59/28mm insulated probe length 80mm with 3 probes connection grip connection					
<b>For models:</b>	CC101, CC201, CCC101, CCC102, CCC201, CCC202, CCC61, CCD101, CCD102, CCD201, CCD202, CCD61, CCM101, CCM102, CCM201, CCM202, CCM61, CD101, CD102, CD20, CD201, CD202, CD61, CM101, CM102, CM201, CM202, CM61, CM62, CPC101, CPC102, CPC201, CPC202, CPC61, SCC101, SCC102, SCC201, SCC202, SCC61, SCC62					
<b>accessories for</b>	400022					
	<table border="1"> <tr> <td><b>GEV No.</b></td> <td>379729</td> <td><b>Ref. No.</b></td> <td>40.00.205 40.01.542 40.02.383</td> </tr> </table>	<b>GEV No.</b>	379729	<b>Ref. No.</b>	40.00.205 40.01.542 40.02.383	
<b>GEV No.</b>	379729	<b>Ref. No.</b>	40.00.205 40.01.542 40.02.383			
	connection cable L 1230mm 4-pole for level electrode plug type coded					
	<table border="1"> <tr> <td><b>GEV No.</b></td> <td>550574</td> <td><b>Ref. No.</b></td> <td>—</td> </tr> </table>	<b>GEV No.</b>	550574	<b>Ref. No.</b>	—	
<b>GEV No.</b>	550574	<b>Ref. No.</b>	—			
	nut thread PG9 H 3mm WS 28 nickel-plated brass Qty 1 pcs mounting ømm cable ømm					

1			
<b>GEV No.</b>	403297	<b>Ref. No.</b>	44.00.514 87.01.219
<b>description</b>	level electrode M15x1.5 total length 190mm probe L 165mm insulated probe length 153mm with extension connection coded plug ø 2mm suitable for RATIONAL		
<b>For models:</b>	CM201, SCC201		

1			
<b>GEV No.</b>	401492	<b>Ref. No.</b>	44.00.253
<b>description</b>	level electrode probe L 85mm		
<b>For models:</b>	CM61, CM62, SCC61, SCC62		

1			
<b>GEV No.</b>	400163	<b>Ref. No.</b>	3002.0409
<b>description</b>	level electrode PG9 total length 100mm probe L 72/43/22mm insulated probe length 70/62/52mm with 3 probes connection grip connection		
<b>For models:</b>	CM101, CM102, CM201, CM202, CM61, CPC101, CPC102, CPC201, CPC202, CPC61		





			
1			
<b>GEV No.</b>	401491	<b>Ref. No.</b>	3002.0404
<b>description</b>	level electrode probe L 95mm with 3 probes		
<b>For models:</b>	CM101, CM201, CM62		

			
1			
<b>GEV No.</b>	403886	<b>Ref. No.</b>	44.01.417
<b>description</b>	level electrode screw mounting total length 380mm probe L 90mm		

			
1			
<b>GEV No.</b>	403804	<b>Ref. No.</b>	44.00.287 44.01.371 87.01.221
<b>description</b>	level electrode with cable M15x1.5 probe L 12mm total length 325mm insulated probe length 114mm straight connection plug-in connection ø 1.5mm EPDM		
<b>For models:</b>	CM101, CM102, CM202, SCC101, SCC102, SCC202		

## flow meters and flow sensors

### flow sensors

			
1			
<b>GEV No.</b>	403301	<b>Ref. No.</b>	44.00.670 87.00.655
<b>description</b>	flow sensor inlet ø 10mm outlet ø 10mm L 104mm connection coded plug cable length 1300mm flow rate 1-25l/min		
<b>For models:</b>	SCC101, SCC102, SCC201, SCC202, SCC61, SCC62		

			
1			
<b>GEV No.</b>	402256	<b>Ref. No.</b>	3017.1050 44.00.211
<b>description</b>	flow sensor inlet ø 10mm outlet ø 10mm L 110mm flow rate 1-25l/min		
<b>For models:</b>	CPC101, CPC102, CPC201, CPC202, CPC61, SCC101, SCC102, SCC201, SCC202, SCC61, SCC62		

			
1			
<b>GEV No.</b>	403302	<b>Ref. No.</b>	50.00.934 50.01.523 87.01.272
<b>description</b>	flow sensor inlet ø 3/4" ET outlet ø 3/4" IT L 78mm connection coded plug cable length 1300mm flow rate 1-25l/min		
<b>For models:</b>	SCC101, SCC102, SCC201, SCC202, SCC61, SCC62		

## fans

### axial fans

#### ebm-papst

			
1			
<b>GEV No.</b>	601030 <sup>1</sup>	<b>Ref. No.</b>	40.03.425
<b>description</b>	axial fan L 119mm W 119mm H 38mm 230VAC 50Hz 18W bearing ball bearing manuf. no. 4656Z metal connection male faston 2.8mm ebm-papst fan wheel ø 110mm temp.-resist. 75°C		
<b>accessories for</b>	601030		
	<b>GEV No.</b>	550898	<b>Ref. No.</b> —
	connecting cable cable length 2000mm connection F 2.8 connection distance 7.9mm for axial flow fan		
	<b>GEV No.</b>	692497	<b>Ref. No.</b> —
	guard ø 105mm mounting distance 150mm for axial fan ebm-papst-mm		

<sup>1</sup>with ball bearings

			
1			
<b>GEV No.</b>	601309 <sup>1</sup>	<b>Ref. No.</b>	40.00.474
<b>description</b>	axial fan L 127mm W 127mm H 38mm 12VDC 21W bearing ball bearing manuf. no. DV5212N metal connection cable ebm-papst suitable for RATIONAL fan wheel ø 120mm temp.-resist. 65°C		
<b>For models:</b>	CM201, CM202, SCC201, SCC202		

<sup>1</sup>with ball bearings

1

<b>GEV No.</b>	601752 <sup>1</sup>	<b>Ref. No.</b>	40.02.899
<b>description</b>	axial fan L 127mm W 127mm H 38mm 12VDC 21W bearing ball bearing manuf. no. DV5212N plastic/metal connection cable 310mm ebm-papst fan wheel ø 120mm temp.-resist. 65°C SCC Line since 05/2008		
<b>For models:</b>	CM201, CM202, SCC201, SCC202		

<sup>1</sup>with ball bearings



1

<b>GEV No.</b>	601712 <sup>1</sup>	<b>Ref. No.</b>	993160
<b>description</b>	axial fan L 120mm W 120mm H 38mm 12VDC 10W bearing ball bearing connection cable 320mm plastic ADDA fan wheel ø 110mm		

<sup>1</sup>with ball bearings

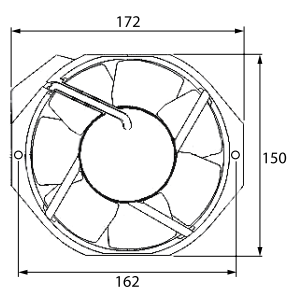
1

<b>GEV No.</b>	601113 <sup>1</sup>	<b>Ref. No.</b>	3101.1013
<b>description</b>	axial fan L 172mm W 150mm H 38mm 230VAC 50/60Hz 27/28W bearing ball bearing connection male faston 2.8mm manuf. no. 7056ES metal ebm-papst fan wheel ø 145mm temp.-resist. 55°C		
<b>For models:</b>	CM102, CM201, CM202, CPC102, CPC201, CPC202		

<sup>1</sup>with ball bearings



1

<b>GEV No.</b>	601670 <sup>1</sup>	<b>Ref. No.</b>	3101.1018
<b>description</b>	axial fan L 80mm W 80mm H 25mm 12VDC 1.8W bearing ball bearing connection cable 300mm fan wheel ø 75mm		
<b>For models:</b>	CD101, CD102, CD201, CD202, CD61, CM101, CM102, CM201, CM202, CM61, CPC101, CPC102, CPC201, CPC202, CPC61		

<sup>1</sup>with ball bearings

import



1

<b>GEV No.</b>	601080 <sup>1</sup>	<b>Ref. No.</b>	3101.1008
<b>description</b>	axial fan L 119mm W 119mm H 38mm 230VAC 50/60Hz 23/20W bearing ball bearing connection male faston 2.8mm metal ADDA fan wheel ø 110mm temp.-resist. 70°C		
<b>For models:</b>	CC101, CC201, CC6, CCC101, CCC102, CCC61, CCD101, CCD102, CCD61, CCM101, CCM102, CCM61, CD101, CD102, CD201, CD202, CD61, CM101, CM102, CM201, CM202, CM61, CM62, CPC101, CPC102, CPC201, CPC202, CPC61, SCC101, SCC102, SCC202, SCC61, SCC62		
<b>accessories for</b>	601080		
	<b>GEV No.</b>	550898	<b>Ref. No.</b> —
	connecting cable cable length 2000mm connection F 2.8 connection distance 7.9mm for axial flow fan		
	<b>GEV No.</b>	692519	<b>Ref. No.</b> —
	guard L 120mm W 120mm plastic		

<sup>1</sup>with ball bearings

accessories

fan guards



1

<b>GEV No.</b>	602141	<b>Ref. No.</b>	8455.1393
<b>description</b>	guard with filter for axial flow fan L 126mm W 126mm H 13.5mm mounting distance 115mm suitable for ebm-papst		
<b>For models:</b>	CM102, CM201, CM202, CPC102, CPC201, CPC202		



converters			
			
1			
<b>GEV No.</b>	381451	<b>Ref. No.</b>	40.03.257
<b>description</b>	converter ebm-papst type AC 4400HT 100-240V for combi-steamer SCC_WE, CM_P		

**cross flow fans**

**COPREL**

with standard coil

			
1			
<b>GEV No.</b>	601036	<b>Ref. No.</b>	3101.1004
<b>description</b>	cross flow fan TFL 120/15 HT roller ø 60mm roller length 120mm laminated core thickness 15mm motor position left 230V/50Hz 18W universal bearing silicone connection male faston 6.3mm airflow 101m³/h -30 up to +100°C 230V 50Hz		
<b>For models:</b>	CCC201, CCC202, CCD201, CCD202, CCM201, CCM202		

**hot air motors**

			
1			
<b>GEV No.</b>	510588	<b>Ref. No.</b>	2016.0875
<b>description</b>	counterflange for fan motor ED ø 60mm int. ø 132mm int. ø 226mm thickness 3mm steel		
<b>For models:</b>	CCC102, CCC202, CCD102, CCD202, CCM102, CCM202		

			
1			
<b>GEV No.</b>	697780	<b>Ref. No.</b>	22.00.083
<b>description</b>	engine shaft gasket plastic for fan ID ø 15mm ED ø 29.5mm thickness 4.5mm		
<b>For models:</b>	CM101, CM102, CM201, CM202, CM61, CM62, SCC101, SCC102, SCC201, SCC202, SCC61, SCC62		

<b>GEV No.</b>	601319	<b>Ref. No.</b>	3100.1036
<b>description</b>	fan motor		
<b>For models:</b>	CM102, CPC102, CPC202		



2

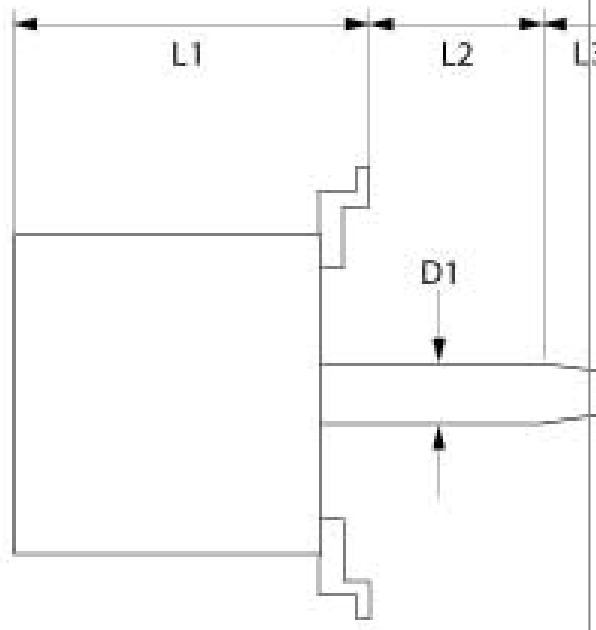

<b>GEV No.</b>	601321	<b>Ref. No.</b>	3100.1064
<b>description</b>	fan motor		
<b>For models:</b>	CM102, CPC102, CPC202		







<b>GEV No.</b>	601301	<b>Ref. No.</b>	40.00.274 40.00.274P 40.00.275 40.00.275P	
<b>description</b>	fan motor 100-240V 1 phase 50/60Hz 0.45kW 2000rpm speeds 1 L1 160mm L2mm L3mm L4mm M8R IT fan wheel ø 130mm type M3G084-FA22-16			
<b>For models:</b>	CM101, CM102, CM201, CM202, CM61, CM62, SCC101, SCC102, SCC201, SCC202, SCC61, SCC62			
<b>accessories for</b>	601301			
	<b>GEV No.</b>	511685	<b>Ref. No.</b>	87.00.564
	shaft seal kit ID ø 15mm ED ø 27mm shaft seal flange mounting gauge with mountign material			

Table continues overleaf



<b>accessories for</b> 601301			
	<b>GEV No.</b>	601327	<b>Ref. No.</b> 22.00.192 22.00.192S
fan wheel D1 ø 340mm H1 135mm blades 9 D2 ø 13mm D3 ø 16mm H2 38mm			



<b>GEV No.</b>	602128	<b>Ref. No.</b>	40.03.378 40.03.378P
<b>description</b>	fan motor 100-240V 50/60Hz 0.55kW 1800rpm L1 162mm L2 52mm L3 14mm with engine shaft gasket type SCC_WE, CM_P 61-202		
<b>spare parts for</b>	602128		
	<b>GEV No.</b>	551347	<b>Ref. No.</b> 87.01.188
gasket set SCC_WE, CM_P 61-202			
	<b>GEV No.</b>	551348	<b>Ref. No.</b> 20.01.755P
insulation SCC_WE, CM_P 61-202 L 248mm bore ø 30mm W 193mm H 15mm			

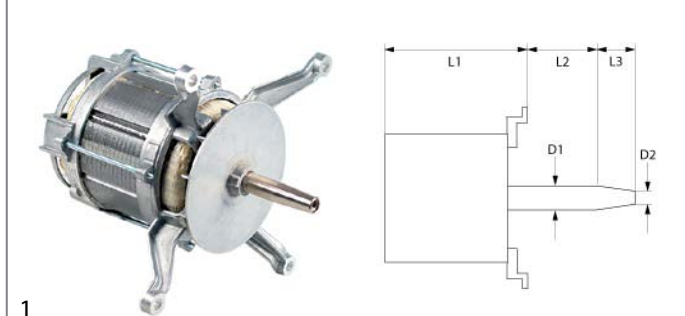

<b>GEV No.</b>	500158	<b>Ref. No.</b>	3100.1002
<b>description</b>	fan motor 200-240/346-415V 3 phase 50/60Hz 0.4kW 1400/1700rpm speeds 1 L1 160mm L2 30mm L3 35mm M10R IT 2.0/1.15A power input 560W at 50Hz 200-240/346-415V at 60Hz 200-277/346-480V at 50Hz 1400rpm at 60Hz 1700rpm type L7Cw4D-226 no. WN D1 ø 17mm D2 ø 13mm		
<b>For models:</b>	CCD101, CCD201, CCD61		

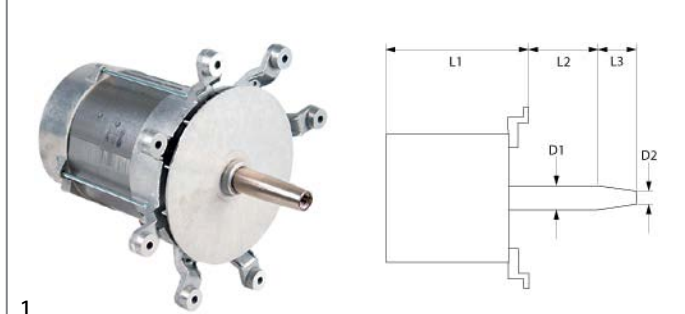



<b>GEV No.</b>	601313	<b>Ref. No.</b>	3100.1007
<b>description</b>	fan motor 200-240/346-415V 3 phase 50/60Hz 1kW 1400/1700rpm speeds 1 L1 220mm L2 35mm L3 50mm M14R IT 4.5/2.6A power input 1320W at 50Hz 200-240/346-415V at 60Hz 200-277/346-480V at 50Hz 1400rpm at 60Hz 1700rpm type L9FGw4D-227 no. T5 D1 ø 25mm D2 ø 20mm		
<b>For models:</b>	CCD102, CCD202		



<b>GEV No.</b>	602130	<b>Ref. No.</b>	3100.1033
<b>description</b>	fan motor 200-240V 50/60Hz 0,45/0,7kW 1450/1720rpm L1 150mm L2 34mm L3 36mm D1 ø 17mm D2 ø 14.5mm CPC-L.CD/CM/61/109/201		
<b>For models:</b>	CD101, CD201, CD61, CM101, CM201, CM61		
<b>spare parts for</b>	602130		
	<b>GEV No.</b>	551350	<b>Ref. No.</b> 8720.1613
gasket set for motor CPC, CM, CD			



<b>GEV No.</b>	602126	<b>Ref. No.</b>	40.03.513P 4003513
<b>description</b>	fan motor 200-240V 50/60Hz 0.75kW 1820rpm L1 160mm L2 49mm L3 16mm 3.75A for fan wheel ø 15mm		
<b>spare parts for</b>	602126		
	<b>GEV No.</b>	551347	<b>Ref. No.</b> 87.01.188
gasket set SCC_WE, CM_P 61-202			
	<b>GEV No.</b>	551348	<b>Ref. No.</b> 20.01.755P
insulation SCC_WE, CM_P 61-202 L 248mm bore ø 30mm W 193mm H 15mm			

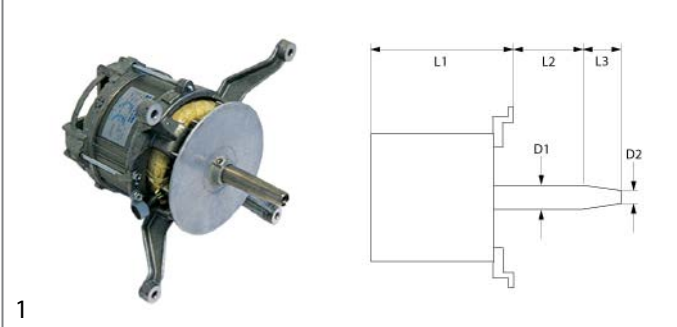

<b>GEV No.</b>	500100	<b>Ref. No.</b>	3001.0400 3001.0426
<b>description</b>	fan motor 220-240/380-415V 3 phase 50/60Hz 0.25kW 1400rpm speeds 1 L1 150mm L2 32mm L3 40mm M10R IT at 50Hz 1400rpm at 60Hz 1700rpm type L7Aw4D-099 no. X3 D1 ø 17mm D2 ø 13mm mounting distance 180mm		
<b>For models:</b>	CC101, CC201, CC6, CD101, CD20, CD201, CM101, CM201		



1

<b>GEV No.</b>	500105	<b>Ref. No.</b>	3001.0405 3001.0419 3001.0428
<b>description</b>	fan motor 220-240/380-415V 3 phase 50Hz 0.37kW 1400rpm speeds 1 L1 182mm L2 26mm L3 50mm $\phi$ 125mm M14R IT 2.85/1.65A power input 580W Cos(f) 0.55 at 50Hz 1400rpm no. R7 D1 $\phi$ 25mm D2 $\phi$ 20mm		

1

<b>GEV No.</b>	500167	<b>Ref. No.</b>	3100.1021
<b>description</b>	fan motor 220-240/380-415V 3 phase 50Hz 0.45kW 1400rpm speeds 1 L1 150mm L2 24mm L3 35mm M10R IT 1.1/1.9A power input 650W at 50Hz 1400rpm type L9Cw4D1-304 no. X7 D1 $\phi$ 17mm D2 $\phi$ 13mm		
<b>For models:</b>	CD101, CD201, CD202, CD61, CM101, CM201, CM61, CPC61		

1

<b>GEV No.</b>	500169	<b>Ref. No.</b>	3100.1023
<b>description</b>	fan motor 220-240/380-415V 3 phase 50Hz 1kW 1400rpm speeds 1 L1 190mm L2 41mm L3 37mm M10R IT 4.0/2.3A power input 1250W at 50Hz 1400rpm type L9FGw4D-395 no. X1 D1 $\phi$ 17mm D2 $\phi$ 13mm		
<b>For models:</b>	CD101, CD102, CD201, CD202, CD61, CM101, CM102, CM201, CM202, CM61		

1

<b>GEV No.</b>	601310	<b>Ref. No.</b>	3001.0423 3001.0424 3001.0433 3001.0434 3001.0441
<b>description</b>	fan motor 220-240V 1 phase 50/60Hz 0.16kW 1420/1720rpm speeds 1 L1 140mm L2 40mm L3 37mm M10R IT 1.3A suitable capacitor 16 $\mu$ F/280V power input 260W Cos(f) 0.96 at 50Hz 1420rpm at 60Hz 1720rpm type L7zAw4D-199 no. W5 D1 $\phi$ 17mm D2 $\phi$ 13mm		
<b>For models:</b>	CM101, CM201, CM62		

1

<b>GEV No.</b>	601320	<b>Ref. No.</b>	3100.1069
<b>description</b>	fan motor 220-240V 3 phase 50Hz 1kW 1400rpm speeds 1 L1 220mm L2 30mm L3 50mm 4.0/2.3A power input 1250W at 50Hz 1400rpm type L9FGw4D-395 no. WN D1 $\phi$ 25mm D2 $\phi$ 20mm		
<b>For models:</b>	CD102, CD202, CM102, CM202		

1

<b>GEV No.</b>	601318	<b>Ref. No.</b>	3100.1024 3100.1044
<b>description</b>	fan motor 230-240V 1 phase 50Hz 0.450/0.615kW 1440rpm speeds 1 L1 150mm L2 34mm L3 35mm M10x1.5 3.1A type L9Fw4D-397 no. CO D1 $\phi$ 17mm D2 $\phi$ 13mm		
<b>For models:</b>	CD61, CM101, CM201, CM61, CPC101, CPC201, CPC61		





<b>GEV No.</b>	601815	<b>Ref. No.</b>	3100.1061
<b>description</b>	fan motor 230-240V 1 phase 50Hz 0.450/0.615kW 1440rpm speeds 1 L1 150mm L2 34mm L3 35mm ø 125mm M10x1.5 3.1A type L9F-w4D-397 no. CO D1 ø 17mm D2 ø 13mm kit		
<b>For models:</b>	CD61, CM101, CM201, CM61, CPC101, CPC201, CPC61		

<b>GEV No.</b>	601704	<b>Ref. No.</b>	3100.1041 3100.1062
<b>description</b>	fan motor 240V 3 phase 60Hz 0.7kW 1720rpm speeds 1 L1 152mm L2 31mm L3 35mm M10L 3A D1 ø 17mm D2 ø 13.5mm		
<b>For models:</b>	CM101, CM201, CM61, CPC101, CPC201, CPC61		

<b>GEV No.</b>	601300	<b>Ref. No.</b>	3100.1080 3100.1083
<b>description</b>	fan motor 240V 3 phase 60Hz 0.68kW 1730rpm speeds 1 L1 145mm L2 24mm L3 34mm M10R IT 2.9A number of pole pairs 2 power input 870W at 60Hz 1730rpm Y type L9DFw4D-518 no. X6 D1 ø 17mm D2 ø 13mm		
<b>For models:</b>	CD101, CD201, CD61, CM101, CM201, CM61, CPC101, CPC201, CPC61		

<b>GEV No.</b>	500159	<b>Ref. No.</b>	3100.1000
<b>description</b>	fan motor 380-415/380-460V 3 phase 50Hz 0.04/0.37kW 710/1350rpm speeds 2 L1 170mm L2 30mm L3 35mm M10R IT 0.3/0.85A power input 100/550W at 50Hz 380-415V at 60Hz 380-460V at 50Hz 710/1350rpm at 60Hz 850/1680rpm Y/YY type L7rw84D-208 no. WN D1 ø 17mm D2 ø 13mm		
<b>For models:</b>	CCC101, CCC201, CCC61, CCM101, CCM201, CCM61		

<b>GEV No.</b>	601308	<b>Ref. No.</b>	3100.1081 3100.1084
<b>description</b>	fan motor 240V 3 phase 60Hz 0.68kW 1730rpm speeds 1 L1 155mm L2 47mm L3 35mm M10R IT 2.9A power input 870W at 60Hz 1730rpm type L9DFw4D-519 no. W8 D1 ø 17mm D2 ø 13mm		
<b>For models:</b>	CD102, CD202, CM102, CM202, CPC102, CPC202		
<b>accessories for</b>	601308		
	<b>GEV No.</b>	510573	<b>Ref. No.</b> 5001.0207
	shaft seal ID ø 17mm ED ø 29mm thickness 4.5mm		

<b>GEV No.</b>	500162	<b>Ref. No.</b>	3100.1020
<b>description</b>	fan motor 380-415V 3 phase 50Hz 0.08/0.45kW 700/1400rpm speeds 2 L1 147mm L2 35mm L3 35mm ø 125mm M10R IT 0.4/1.15A at 50Hz 700/1400rpm Y/YY type L9xw84D-393 no. V2 D1 ø 17mm D2 ø 13mm		
<b>For models:</b>	CPC101, CPC201, CPC61		
<b>spare parts for</b>	500162		
	<b>GEV No.</b>	601730	<b>Ref. No.</b> 3001.0803 3001.0804
	fan wheel for motor cooling ED ø 180mm H 20mm ID ø 20mm		



1

<b>GEV No.</b>	602129	<b>Ref. No.</b>	3100.1049
<b>description</b>	fan motor 380-415V 3 phase 50Hz 0.08/0.45kW 700/1400rpm speeds 2 L1 147mm L2 35mm L3 35mm ø 125mm M10R IT 0.4/1.15A at 50Hz 700/1400rpm Y/YY type L9zw84D-393 no. V2 D1 ø 17mm D2 ø 13mm		
<b>For models:</b>	CM201, CPC101, CPC201, CPC61		
<b>spare parts for</b>	602129		
	<b>GEV No.</b>	<b>Ref. No.</b>	<b>551350</b> 8720.1613
	gasket set for motor CPC, CM, CD		

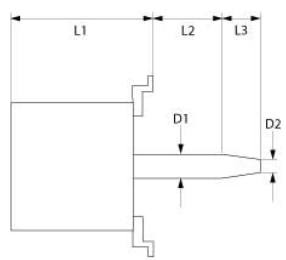
1

<b>GEV No.</b>	601314	<b>Ref. No.</b>	3100.1001
<b>description</b>	fan motor 380-415V 3 phase 50Hz 0.12/0.9kW 700/1380rpm speeds 2 L1 230mm L2 35mm L3 50mm 0.9/2.1A power input 240/1200W at 50Hz 700/1380rpm type L9zw84D-212 no. X2 D1 ø 25mm D2 ø 20mm		
<b>For models:</b>	CCC102, CCC202, CCM102, CCM202		



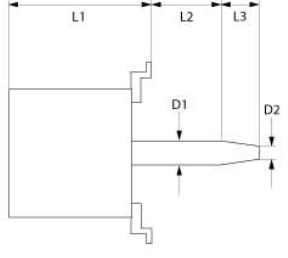

1

<b>GEV No.</b>	601299	<b>Ref. No.</b>	3100.1068
<b>description</b>	fan motor 380-415V 3 phase 50Hz 0.12/0.9kW 700/1380rpm speeds 2 L1 205mm L2 40mm L3 35mm M10R IT 0.9/2.1A power input 240/1200W at 50Hz 700/1380rpm type L9zw84D-394 no. X4 D1 ø 17mm D2 ø 13mm		
<b>For models:</b>	CPC102, CPC202		



1

<b>GEV No.</b>	602127	<b>Ref. No.</b>	40.00.276 40.00.276P
<b>description</b>	fan motor 400/480V 50/60Hz 0.85kW 2500rpm L1 165mm L2 37.5mm L3 36mm with engine shaft gasket type SCC Line		
<b>For models:</b>	CM101, CM102, CM201, CM202, CM61, CM62, SCC101, SCC102, SCC201, SCC202, SCC61, SCC62		
<b>spare parts for</b>	602127		
	<b>GEV No.</b>	<b>Ref. No.</b>	<b>551349</b> 87.00.562
	gasket set SCC, CM61-202 since 06/2007		

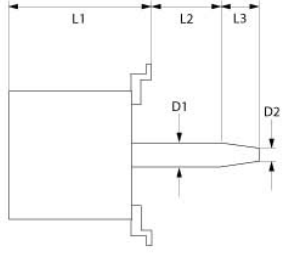



1

<b>GEV No.</b>	500168	<b>Ref. No.</b>	3100.1022
<b>description</b>	fan motor 380-415V 3 phase 50Hz 0.12/0.9kW 700/1380rpm speeds 2 L1 205mm L2 47mm L3 35mm 0.9/2.1A power input 240/1200W at 50Hz 700/1380rpm type L9zw84D-394 no. X6 D1 ø 13mm D2 ø 13mm L4 17mm		
<b>For models:</b>	CPC102, CPC202		



1

<b>GEV No.</b>	602139	<b>Ref. No.</b>	3001.0436 30010403
<b>description</b>	fan motor 440-480V 3 phase 60Hz 0.37kW 1600rpm L1 185mm L2 26mm L3 50mm type L9Cw4D-157 D1 ø 25mm D2 ø 20mm		
<b>For models:</b>	CD20		
<b>accessories for</b>	602139		
	<b>GEV No.</b>	<b>Ref. No.</b>	<b>510574</b> 5001.0211
	shaft sealing type 20 for fan motor		



Image not available

1

<b>GEV No.</b>	601312	<b>Ref. No.</b>	2012.0510
<b>description</b>	fan wheel		
<b>For models:</b>	CD20		



2

<b>GEV No.</b>	601316	<b>Ref. No.</b>	2012.0502
<b>description</b>	fan wheel		
<b>For models:</b>	CCC101, CCC61, CCD101, CCD61, CCM101, CCM61		



Image not available

1

<b>GEV No.</b>	601317	<b>Ref. No.</b>	2012.0504
<b>description</b>	fan wheel		
<b>For models:</b>	CCC102, CCD102, CCM102		



1

<b>GEV No.</b>	601326	<b>Ref. No.</b>	2012.0514
<b>description</b>	fan wheel		
<b>For models:</b>	CD102, CD202, CM102, CM202, CPC102, CPC202		



1

<b>GEV No.</b>	601049	<b>Ref. No.</b>	2012.0602
<b>description</b>	fan wheel D1 ø 280mm H1 125mm blades 12 D2 ø 11mm D3 ø 16mm H2 37mm		
<b>For models:</b>	CC6		



1

<b>GEV No.</b>	601327	<b>Ref. No.</b>	22.00.192 22.00.192S
<b>description</b>	fan wheel D1 ø 340mm H1 135mm blades 9 D2 ø 13mm D3 ø 16mm H2 38mm		
<b>For models:</b>	CM102, CM202, CM62, SCC102, SCC202, SCC62		



1

<b>GEV No.</b>	601306	<b>Ref. No.</b>	22.00.188
<b>description</b>	fan wheel D1 ø 340mm H1 95mm blades 9 D2 ø 13mm D3 ø 16mm H2 37mm		
<b>For models:</b>	CM101, CM201, CM61, SCC101, SCC201, SCC61		



1

<b>GEV No.</b>	601315	<b>Ref. No.</b>	2012.0900
<b>description</b>	fan wheel D1 ø 350mm H1 125mm blades 12 D2 ø 12mm D3 ø 16mm H2 36mm		
<b>For models:</b>	CCC101, CCC201, CCC61, CCD101, CCD201, CCD61, CCM101, CCM201, CCM61		



1

<b>GEV No.</b>	601323	<b>Ref. No.</b>	2012.0512
<b>description</b>	fan wheel D1 ø 350mm H1 135mm blades 12 D2 ø 13mm D3 ø 16mm H2 45mm		
<b>For models:</b>	CD101, CD201, CD61, CM101, CM201, CM202, CM61, CPC101, CPC201, CPC61		



1

<b>GEV No.</b>	601311	<b>Ref. No.</b>	2012.0500
<b>description</b>	fan wheel D1 ø 350mm H1 125mm blades 12 D2 ø 13mm D3 ø 16.5mm H2 37mm		
<b>For models:</b>	CC101, CC201, CD101, CD20, CD201, CM101, CM201		



1

<b>GEV No.</b>	602137	<b>Ref. No.</b>	2012.0901
<b>description</b>	fan wheel D1 ø 450mm D2 ø 23mm D3 ø 19.5mm H1 156mm blades 12 H2 23.5mm for C-Linie 202		
<b>For models:</b>	CCC202, CCD202, CCM202		



1

<b>GEV No.</b>	601322	<b>Ref. No.</b>	2012.0507
<b>description</b>	fan wheel D1 ø 350mm H1 125mm blades 12 D2 ø 13mm D3 ø 16mm H2 37mm		
<b>For models:</b>	CD101, CD201, CD61, CM101, CM102, CM201, CM61, CPC101, CPC102, CPC201, CPC61		





1

<b>GEV No.</b>	601324	<b>Ref. No.</b>	2012.0508
<b>description</b>	fan wheel D1 ø 450mm H1 155mm blades 12 D2 ø 13.5mm D3 ø 17mm H2 45mm		
<b>For models:</b>	CD102, CD202, CM102, CM202, CPC102, CPC202		





			
1			
<b>GEV No.</b>	601325	<b>Ref. No.</b>	2012.0513
<b>description</b>	fan wheel D1 ø 450mm H1 165mm blades 12 D2 ø 14mm D3 ø 17mm H2 45mm		
<b>For models:</b>	CD102, CD202, CM102, CM202, CPC102, CPC202		

			
1			
<b>GEV No.</b>	601443	<b>Ref. No.</b>	3001.0801
<b>description</b>	fan wheel for motor cooling ED ø 127mm ID ø 25mm		

			
1			
<b>GEV No.</b>	601669	<b>Ref. No.</b>	3001.0800
<b>description</b>	fan wheel for motor cooling ED ø 128mm H 20mm shaft intake ø 17mm		

			
1			
<b>GEV No.</b>	601730	<b>Ref. No.</b>	3001.0803 3001.0804
<b>description</b>	fan wheel for motor cooling ED ø 180mm H 20mm ID ø 20mm		

			
1			
<b>GEV No.</b>	510587	<b>Ref. No.</b>	2016.0876
<b>description</b>	flange for fan motor ED ø 60mm int. ø 1 24mm int. ø 2 18.5mm thickness 3mm steel		
<b>For models:</b>	CC101, CC201, CC6, CCC101, CCC201, CCC61, CCD101, CCD201, CCD61, CCM101, CCM201, CCM61, CD101, CD102, CD201, CD202, CD61, CM101, CM102, CM201, CM202, CM61, CM62, CPC101, CPC102, CPC201, CPC202, CPC61		

			
1			
<b>GEV No.</b>	510573	<b>Ref. No.</b>	5001.0207
<b>description</b>	shaft seal ID ø 17mm ED ø 29mm thickness 4.5mm		
<b>For models:</b>	CC101, CC201, CC6, CCC101, CCC201, CCC61, CCD101, CCD201, CCD61, CCM101, CCM201, CCM61, CD101, CD102, CD201, CD202, CD61, CM101, CM102, CM201, CM202, CM61, CM62, CPC101, CPC102, CPC201, CPC202, CPC61, SCC101, SCC102, SCC201, SCC202, SCC61, SCC62		

			
1			
<b>GEV No.</b>	511682	<b>Ref. No.</b>	8514.1343 87.00.563
<b>description</b>	shaft seal kit ID ø 17mm ED ø 29mm shaft seal flange mounting gauge with mountign material		
<b>For models:</b>	CM101, CM102, CM201, CM202, CM61, CPC101, CPC102, CPC201, CPC202, CPC61		

radial fans

			
1			
<b>GEV No.</b>	601709	<b>Ref. No.</b>	3101.1017
<b>description</b>	radial fan 230V voltage AC 50/60Hz H1 180mm L1 175mm D1 ø 43mm W1 82mm W2 33mm H2 60mm W3 83mm H3 83mm for combi-steamer		
<b>For models:</b>	CM102, CM201, CM202, CPC102, CPC201, CPC202		

			
1			
<b>GEV No.</b>	601296	<b>Ref. No.</b>	70.00.067
<b>description</b>	radial fan 230V voltage AC 50Hz 140W H1 190mm L1 190mm D1 ø 50mm W1 133mm W2 28mm H2 55mm W3 83mm H3 83mm		
<b>For models:</b>	CM102, CM201, CM202, SCC102, SCC201, SCC202		

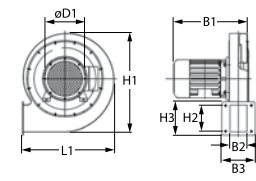

1

<b>GEV No.</b>	500798	<b>Ref. No.</b>	3101.1016
<b>description</b>	radial fan 230V voltage AC 50Hz 25W H1 143mm L1 127mm D1 ø 27mm W1 85mm W2 23mm H2 43mm W3 76mm H3 83mm		
<b>For models:</b>	CM101, CM102, CM201, CM61, CPC101, CPC102, CPC201, CPC61		

1

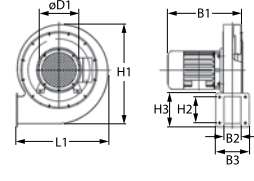
<b>GEV No.</b>	601115	<b>Ref. No.</b>	3101.1014
<b>description</b>	radial fan 24V voltage AC 50Hz H1 180mm L1 175mm D1 ø 43mm W1 84mm W2 33mm H2 59mm W3 82mm H3 83mm		
<b>For models:</b>	CM102, CM201, CM202, CPC102, CPC201, CPC202		

1

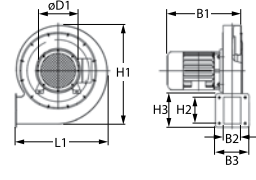
<b>GEV No.</b>	601295	<b>Ref. No.</b>	70.00.028
<b>description</b>	radial fan 230V voltage AC 50Hz 50W H1 180mm L1 180mm D1 ø 43mm W1 105mm W2 33mm H2 59mm W3 66mm H3 83mm		
<b>For models:</b>	CM101, CM102, CM201, CM202, CM61, CM62, SCC101, SCC102, SCC201, SCC202, SCC61, SCC62		

### accessories universal



1

<b>GEV No.</b>	403449	<b>Ref. No.</b>	8720.1462
<b>description</b>	motor break electric suitable for RATIONAL		

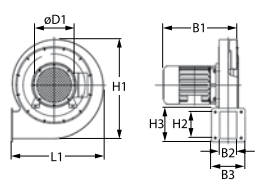
1

<b>GEV No.</b>	601114	<b>Ref. No.</b>	3101.1011 8720.1418
<b>description</b>	radial fan 24V voltage AC 50Hz 20W H1 141mm L1 130mm D1 ø 27mm W1 86mm W2 23mm H2 42.5mm W3 75.5mm H3 83mm gas burner		
<b>For models:</b>	CM101, CM102, CM201, CM61, CPC101, CPC102, CPC201, CPC61		



1

<b>GEV No.</b>	401013	<b>Ref. No.</b>	3031.0200 3031.0201 3031.0204
<b>description</b>	motor break electronic 50/60Hz for RATIONAL breaking duration 4s type ETBO 10 (AC3/380V) 0.5kW		
<b>For models:</b>	CD20		



motors

gear motors

for ovens

for flues



1

<b>GEV No.</b>	361999	<b>Ref. No.</b>	3101.1010 3101.1010S
<b>description</b>	gear motor CROUZET type 82841042 12V voltage DC shaft ø 4mm L 65mm W 50mm H 51mm for oven		



1

<b>GEV No.</b>	361565	<b>Ref. No.</b>	3101.1007
<b>description</b>	gear motor CROUZET type 82841056 24V voltage DCHz 4.2rpm shaft ø 4mm L 51mm W 66mm H 51mm		
<b>For models:</b>	CCC101, CCC102, CCC61, CCM101, CCM102, CCM61		



1

<b>GEV No.</b>	601138	<b>Ref. No.</b>	31011010
<b>description</b>	gear motor CROUZET type G70C10AFTEG 12V voltage DCHz shaft ø 4mm L 66mm W 50mm H 61mm		
<b>For models:</b>	CM102, CPC101, CPC102, CPC201, CPC202, CPC61, SCC101, SCC102, SCC201, SCC202, SCC61, SCC62		



1

<b>GEV No.</b>	500873	<b>Ref. No.</b>	22.00.318
<b>description</b>	ventilation valve CROUZET type G70C10AFTEG 12V voltage DC shaft ø 6mm L 95mm W 63mm H 136mm for combi-steamer ø 50mm		
<b>For models:</b>	SCC101, SCC102, SCC201, SCC202, SCC61, SCC62		



1

<b>GEV No.</b>	361564	<b>Ref. No.</b>	3101.1001
<b>description</b>	gear motor ESCAP type 22N28210E 24V shaft ø 5mm L 50mm W 32mm H 51mm for sliding valve		
<b>For models:</b>	CCC101, CCC201, CCC202, CCC61, CCM101, CCM201, CCM202, CCM61		

motors

for combi-steamers



1

<b>GEV No.</b>	401480	<b>Ref. No.</b>	3101.1002 8680.1006
<b>description</b>	motor for humidity measuring		
<b>For models:</b>	CCC101, CCC102, CCC201, CCC202, CCC61, CCM101, CCM102, CCM201, CCM202, CCM61, CPC201		

pumps

wash and rinse pumps

HANNING

pumps

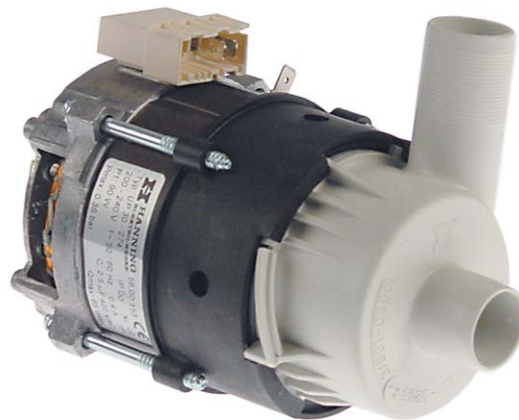

1

<b>GEV No.</b>	500578	<b>Ref. No.</b>	56.00.153 56.00.185
<b>description</b>	pump inlet ø 24mm outlet ø 24mm type UP30-274 230V 50/60Hz 1 phase 0.09kW 0.12HP L 145mm rotation direction left capacitor 2.5µF HANNING		
<b>For models:</b>	SCC101, SCC102, SCC201, SCC202, SCC61, SCC62		

<b>spare parts for</b>	500578		
<b>GEV No.</b>	501345	<b>Ref. No.</b>	—
	O-ring EPDM thickness 3mm ID ø 58mm Qty 1 pcs		



1		GEV No.	500579	Ref. No.	56.00.178 56.00.178P 56.00.186 87.00.437
<b>description</b>		pump inlet ø 24mm outlet ø 24mm type UP30-275 230V 50/60Hz 1 phase 0.09kW 0.12HP L 145mm rotation direction left capacitor 2.5µF HANNING			
<b>For models:</b>		SCC201, SCC202			
<b>spare parts for</b>		500579			
		GEV No.	501345	Ref. No.	—
O-ring EPDM thickness 3mm ID ø 58mm Qty 1 pcs					

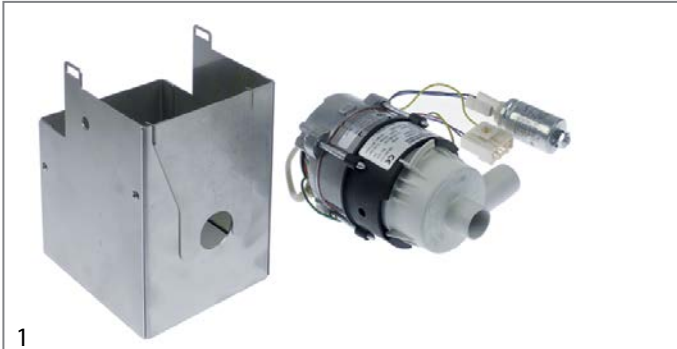

1		GEV No.	499184	Ref. No.	87.00.437
<b>description</b>		pump inlet ø 24mm outlet ø 24mm type UP30-890 200-240V 50/60Hz 1 phase 0.1kW L 145mm rotation direction left capacitor 2.5µF HANNING with SS housing			
<b>spare parts for</b>		499184			
		GEV No.	365009	Ref. No.	—
operating capacitor capacity 2.5µF 400V tolerance 5% 50Hz ambient temperature max. -25 to +85°C ø 36.5mm L 55mm M8 plastic connection male faston 6.3mm 1.27.65C3 protection					



1		GEV No.	499168	Ref. No.	56.00.153P
<b>description</b>		pump inlet ø 24mm type UP30-890 200-240V 50/60Hz 1 phase 0.1kW L 145mm rotation direction left capacitor 2.5µF HANNING			

drain pumps

HANNING



1		GEV No.	500573	Ref. No.	44.00.207 44.00.207P
<b>description</b>		drain pump 30W 4-piece 230V inlet ø 24/30mm outlet ø 24mm 50Hz HANNING type DPS25-032 1x pump, 3x pump cover			
<b>For models:</b>		CM101, CM102, CM201, CM202, CM61, CM62, SCC101, SCC102, SCC201, SCC202, SCC61, SCC62			



1		GEV No.	500044	Ref. No.	3002.1000 3002.1000ET 3002.1000P
<b>description</b>		drain pump inlet ø 30mm outlet ø 24mm 230V 100W 50Hz HANNING type BE28B4-017			
<b>For models:</b>		CC101, CC201, CC6, CCC101, CCC102, CCC201, CCC202, CCC61, CCD101, CCD102, CCD201, CCD202, CCD61, CCM101, CCM102, CCM201, CCM202, CCM61, CD101, CD102, CD20, CD201, CD202, CD61, CM101, CM102, CM201, CM202, CM61, CM62, CPC101, CPC102, CPC201, CPC202, CPC61			
<b>spare parts for</b>		500044			
		GEV No.	510168	Ref. No.	—
fan wheel shaft intake ø 5mm ø 62mm H 14mm					



1

<b>GEV No.</b>	501542	<b>Ref. No.</b>	3002.1005 3002.1005P 3002.1006
<b>description</b>	drain pump inlet ø 30mm outlet ø 24mm 230V 32W		
<b>For models:</b>	CD101, CD102, CD201, CD202, CD61, CM101, CM102, CM201, CM202, CM61, CPC101, CPC102, CPC201, CPC202, CPC61		

service kits



1

<b>GEV No.</b>	500573	<b>Ref. No.</b>	44.00.207 44.00.207P
<b>description</b>	drain pump 30W 4-piece 230V inlet ø 24/30mm outlet ø 24mm 50Hz HANNING type DPS25-032 1x pump, 3x pump cover		
<b>For models:</b>	CM101, CM102, CM201, CM202, CM61, CM62, SCC101, SCC102, SCC201, SCC202, SCC61, SCC62		



1

<b>GEV No.</b>	499215	<b>Ref. No.</b>	56.00.451 87.00.352
<b>description</b>	drain pump kit inlet ø 24mm outlet ø 24mm 200-240V 42W 50-60Hz mode of operation S2 max. 15min HANNING type DPS35		
<b>For models:</b>	SCC101, SCC102, SCC61, SCC62		

vibration pumps



1

<b>GEV No.</b>	500580	<b>Ref. No.</b>	3002.1003 8720.1526
<b>description</b>	vibration pump 230V 60W 50/60Hz inlet ø 7 outlet ø 1/8" IT CEME type E512 with accessories duty cycle 1/2 ambient temperature max. 60°C medium temp max. 35°C overheating protection 110°C CleanJet		
<b>For models:</b>	CPC101, CPC102, CPC201, CPC202, CPC61		



1

<b>GEV No.</b>	499354	<b>Ref. No.</b>	87.00.353
<b>description</b>	drain pump kit inlet ø 24mm outlet ø 24mm 60/62W 50/60Hz 200-240V mode of operation S2 type DPS35 HANNING		
<b>For models:</b>	SCC201, SCC202		

condensators & interference suppression filters

operating capacitors

metal



1

<b>GEV No.</b>	365215	<b>Ref. No.</b>	3001.0458
<b>description</b>	capacitor capacity 30µF 420/470V tolerance 5% ø 40mm L 119.5mm aluminium connection cable CPC-Linie CM 61-202/G		
<b>For models:</b>	CD61, CM101, CM201, CM61, CPC101, CPC201, CPC61		





filters

interference suppression filters



1			
<b>GEV No.</b>	365217	<b>Ref. No.</b>	3102.1000
<b>description</b>	interference suppression filter capacity 1.5µF 250V for combi-steamer CPC-Linie 61-202		
<b>For models:</b>	CCC101, CCC102, CCC201, CCC202, CCC61, CCD101, CCD102, CCD201, CCD202, CCD61, CCM101, CCM102, CCM201, CCM202, CCM61, CD101, CD102, CD201, CD202, CD61, CM101, CM102, CM201, CM202, CM61, CPC101, CPC102, CPC201, CPC202, CPC61		



1			
<b>GEV No.</b>	365216	<b>Ref. No.</b>	40.02.424
<b>description</b>	interference suppression filter capacity 3x0.27µFX1+3x0.47µFX1µF 400V for combi-steamer SCC, CM 61-202/E		
<b>For models:</b>	CM101, CM102, CM201, CM202, CM61, CM62, SCC101, SCC102, SCC201, SCC202, SCC61, SCC62		



1			
<b>GEV No.</b>	365108	<b>Ref. No.</b>	3001.0455
<b>description</b>	interference suppression filter type 3001.0455 250/440V 50/60Hz conductor 3 with E connection male faston 6.3mm L 52mm ø 60mm Hmm Wmm M8 aluminium Qty 1 pcs		
<b>For models:</b>	CD102, CM101, CM102, CM201, CM202, CM61, CPC101, CPC102, CPC201, CPC202, CPC61		

RC circuits



1			
<b>GEV No.</b>	380179	<b>Ref. No.</b>	3035.0514
<b>description</b>	RC circuit		
<b>For models:</b>	CD101, CD20, CD201, CM101, CM201		



1			
<b>GEV No.</b>	381487	<b>Ref. No.</b>	3035.0509 3035.0519
<b>description</b>	RC circuit 230V connection Faston 6.3mm L 35mm H 30mm W 30mm 4700hm		
<b>For models:</b>	CC101, CC201, CC6, CD20, CM101, CM201		



1			
<b>GEV No.</b>	380278	<b>Ref. No.</b>	3035.0517
<b>description</b>	RC circuit 72-250V voltage AC for contactors M series type AEG EB05 A60		
<b>For models:</b>	CCC101, CCC102, CCC201, CCC61, CCM101, CCM102, CCM201, CCM61, CM101, CM201		



1			
<b>GEV No.</b>	380272	<b>Ref. No.</b>	3028.0562
<b>description</b>	RC circuit for contactors type 910-304-585-50 130-250V 50-60Hz conductor 2 connection cable plastic Qty 1 pcs for contactors LS4_LS15K type AEG LR2K A250 type GE BS2R2R		
<b>For models:</b>	CD101, CD102, CD201, CD202, CD61, CM101, CM102, CM201, CM202, CM61, CPC101, CPC102, CPC201, CPC202, CPC61		



1			
<b>GEV No.</b>	380177	<b>Ref. No.</b>	3035.0508
<b>description</b>	RC circuit type 20002 110/220V 50/60/DChz conductor 2 connection cable 230mm L 29mm ømm H 15mm W 20mm adhesive tape plastic Qty 1 pcs		
<b>For models:</b>	CD101, CD20, CD201, CM101, CM102, CM201, CM202, CM61, CPC101, CPC102, CPC201, CPC202, CPC61		







			
1			
<b>GEV No.</b>	380221	<b>Ref. No.</b>	3035.0515 3035.0521
<b>description</b>	RC circuit type LS4-37 230V voltage AC type AEG LS4-37		
<b>For models:</b>	CC101, CC201, CC6, CCC101, CCC102, CCC201, CCC202, CCC61, CCD102, CCM101, CCM102, CCM201, CCM202, CCM61, CM101, CM201		

## fuses

### fine fuses

			
1			
<b>GEV No.</b>	358677	<b>Ref. No.</b>	30190112
<b>description</b>	fine fuse size $\phi$ 5x20mm 4A fast-acting rated 250V Qty 10 pcs		
<b>For models:</b>	CM101, CM102, CM201, CM62, CPC102, CPC201		

			
1			
<b>GEV No.</b>	358597	<b>Ref. No.</b>	3019.0400
<b>description</b>	fine fuse size $\phi$ 5x20mm 0.5A slow-acting rated 250V Qty 10 pcs		
<b>For models:</b>	CC101, CC201, CC6, CD101, CD20, CD201, CM101, CM201, CM62		

			
1			
<b>GEV No.</b>	358603	<b>Ref. No.</b>	3019.0120
<b>description</b>	fine fuse size $\phi$ 5x20mm 2A slow-acting rated 250V Qty 10 pcs		
<b>For models:</b>	CC101, CC201, CC6, CM101, CM102, CM201, CM202, CM61, CPC101, CPC102, CPC201, CPC202, CPC61		

			
1			
<b>GEV No.</b>	358607	<b>Ref. No.</b>	3019.0200
<b>description</b>	fine fuse size $\phi$ 5x20mm 6.3A slow-acting rated 250V Qty 10 pcs		
<b>For models:</b>	CD101, CD20, CD201, CM201		

			
1			
<b>GEV No.</b>	358735	<b>Ref. No.</b>	4001.0218
<b>description</b>	fine fuse size $\phi$ 5x30mm 6.3A medium lag rated 500V Qty 10 pcs		
<b>For models:</b>	CCC101, CCC102, CCC201, CCC61, CCD101, CCD102, CCD201, CCD202, CCD61, CCM101, CCM102, CCM201, CCM61		

			
1			
<b>GEV No.</b>	358792	<b>Ref. No.</b>	4001.0225
<b>description</b>	fine fuse size $\phi$ 6.3x32mm 10A slow-acting rated 250V Qty 10 pcs		
<b>For models:</b>	CD101, CD102, CD201, CD61, CM101, CM102, CM201, CM61, CPC101, CPC102, CPC201, CPC61		

			
1			
<b>GEV No.</b>	358791	<b>Ref. No.</b>	4001.0224
<b>description</b>	fine fuse size $\phi$ 6.3x32mm 6.3A slow-acting rated 250V Qty 10 pcs		
<b>For models:</b>	CD101, CD102, CD201, CD202, CD61, CM101, CM102, CM201, CM202, CM61, CM62, CPC101, CPC102, CPC201, CPC202, CPC61, SCC101, SCC102, SCC201, SCC202, SCC61, SCC62		

### fine fuse holders

			
1			
<b>GEV No.</b>	358382	<b>Ref. No.</b>	4001.1295
<b>description</b>	fuse holder suitable fuse $\phi$ 5x30mm 10A rated 250V connection screw connection		
<b>For models:</b>	CD101, CD102, CD201, CD202, CD61, CM101, CM102, CM201, CM202, CM61, CM62, CPC101, CPC102, CPC201, CPC202, CPC61, SCC101, SCC102, SCC201, SCC202, SCC61, SCC62		

			
1			
<b>GEV No.</b>	550104	<b>Ref. No.</b>	4001.1247
<b>description</b>	fuse holder WIELAND type WK4/THSI 5 U/V0 suitable fuse $\phi$ 5x30mm 0.5-6mm <sup>2</sup> top-hat rail 35mm 10A rated 600V		
<b>For models:</b>	CCC101, CCC102, CCC201, CCC61, CCD101, CCD102, CCD201, CCD202, CCD61, CCM101, CCM102, CCM201, CCM61		

			
1			
<b>GEV No.</b>	550348	<b>Ref. No.</b>	4001.1283
<b>description</b>	fuse holder WIELAND type WK4/THSI 6.3 U/V0 suitable fuse ø6.3x-32mm 6.3A rated 600V		
<b>For models:</b>	CD101, CD102, CD201, CD202, CD61, CM101, CM102, CM201, CM202, CM61, CPC101, CPC102, CPC201, CPC202, CPC61		

			
1			
<b>GEV No.</b>	550105	<b>Ref. No.</b>	4001.1228
<b>description</b>	rail-mounted terminal WIELAND type WK10/SIU 5X20 /V0 suitable fuse ø5x20mm 1.0-16mm <sup>2</sup> 10A rated 250V		
<b>For models:</b>	CC101, CC201, CC6, CD101, CD20, CD201, CM101, CM201, CM62		

screw locks

D0-system (NEOZED)

			
1			
<b>GEV No.</b>	358043	<b>Ref. No.</b>	3019.0401
<b>description</b>	fuse size D01 16A rated 250/400V E14 ø 11mm L 36mm Qty 10 pcs		
<b>For models:</b>	CCC202, CCD202, CCM202, CD102, CD201, CD202, CM101, CM102, CM201, CM202, CM61, CPC101, CPC102, CPC201, CPC202, CPC61		

			
1			
<b>GEV No.</b>	358044	<b>Ref. No.</b>	3019.0402
<b>description</b>	fuse size D02 25A rated 250/400V E18 ø 15mm L 36mm Qty 10 pcs		
<b>For models:</b>	CD202, CM202, CPC202		

			
1			
<b>GEV No.</b>	358045	<b>Ref. No.</b>	3019.0403
<b>description</b>	fuse size D02 35A rated 250/400V E18 ø 15mm L 36mm Qty 10 pcs		
<b>For models:</b>	CD20		

			
1			
<b>GEV No.</b>	358046	<b>Ref. No.</b>	3019.0404
<b>description</b>	fuse size D02 50A rated 250/400V E18 ø 15mm L 36mm Qty 10 pcs		
<b>For models:</b>	CCC202, CCD202, CCM202, CD20, CD202, CM202, CPC202		

			
1			
<b>GEV No.</b>	358047	<b>Ref. No.</b>	3019.0405
<b>description</b>	fuse size D02 63A rated 250/400V E18 ø 15mm L 36mm Qty 10 pcs		
<b>For models:</b>	CD202, CM202, CPC202, SCC202		

gauge pieces (NEOZED)

			
1			
<b>GEV No.</b>	358064	<b>Ref. No.</b>	4001.1238
<b>description</b>	gauge piece size D02 suitable for 16A		
<b>For models:</b>	CCC202, CCD202, CCM202, CD202, CM202, CPC202		

			
1			
<b>GEV No.</b>	358066	<b>Ref. No.</b>	4001.1239
<b>description</b>	gauge piece size D02 suitable for 25A		
<b>For models:</b>	CD202, CM202, CPC202		

			
1			
<b>GEV No.</b>	358067	<b>Ref. No.</b>	4001.1240
<b>description</b>	gauge piece size D02 suitable for 35A		
<b>For models:</b>	CD20		

			
1			
<b>GEV No.</b>	358068	<b>Ref. No.</b>	4001.1241
<b>description</b>	gauge piece size D02 suitable for 50A		
<b>For models:</b>	CCC202, CCD202, CCM202, CD20, CD202, CM202, CPC202		

fuse holders

			
1			
<b>GEV No.</b>	358060	<b>Ref. No.</b>	4001.1234
<b>description</b>	fuse holder suitable fuse D02 3-pole-pole 63A rated 400V		
<b>For models:</b>	CCC202, CCD202, CCM202, CD20, CD202, CM202, CPC202		



			
1			
<b>GEV No.</b>	358061	<b>Ref. No.</b>	4001.1225 4001.1235
<b>description</b>	fuse holder suitable fuse D02 ø 25mm mounting ø 18mm rated 400V L 30mm		
<b>For models:</b>	CCC202, CCD202, CCM202, CD20, CD202, CM202, CPC202, SCC202		

<b>fastening nuts</b>			
			
1			
<b>GEV No.</b>	550321	<b>Ref. No.</b>	4007.0601
<b>description</b>	nut thread PG9 WS 18 nickel-plated brass Qty 5 pcs thickness 2.9mm mounting ømm cable ømm		
<b>For models:</b>	CC101, CC201, CC6, CD101, CD20, CD201, CM101, CM201		

overload switches

			
1			
<b>GEV No.</b>	358524	<b>Ref. No.</b>	3014.0400 3014.0402
<b>description</b>	overload switch drop-away current 0.05A		
<b>For models:</b>	CCC101, CCC102, CCC201, CCC202, CCC61, CCD101, CCD102, CCD201, CCD202, CCD61, CCM101, CCM102, CCM201, CCM202, CCM61, CD101, CD102, CD201, CD202, CD61, CM101, CM102, CM201, CM202, CM61, CPC101, CPC102, CPC201, CPC202, CPC61		

<b>connection cables</b>			
			
1			
<b>GEV No.</b>	401794	<b>Ref. No.</b>	8720.1584
<b>description</b>	connecting cable L 1440mm 4-pole suitable for RATIONAL		



electric accessories



cables

<b>accessories</b>			
<b>cable glands</b>			
<b>cable glands</b>			
			
1			
<b>GEV No.</b>	550998	<b>Ref. No.</b>	2022.0111
<b>description</b>	cable gland ID ø 2.5mm mounting ø 7mm rubber Qty 5 pcs		
<b>For models:</b>	CM101, CM102, CM201, CM202, CM61, CPC101, CPC102, CPC201, CPC202, CPC61		

			
1			
<b>GEV No.</b>	403815	<b>Ref. No.</b>	8817.1040
<b>description</b>	connection cable 9-pole RS232/USB L 790mm		
<b>For models:</b>	CM101, CM102, CM201, CM202, CM61, CPC101, CPC102, CPC201, CPC202, CPC61		

			
1			
<b>GEV No.</b>	403299	<b>Ref. No.</b>	40.00.210 40.00.231 40.01.543 40.02.385
<b>description</b>	connection cable L 100mm 3-pole connection coded plug		
<b>For models:</b>	SCC101, SCC102, SCC201, SCC202, SCC61, SCC62		

<b>threaded cable glands</b>			
<b>screw connections</b>			
			
1			
<b>GEV No.</b>	550303	<b>Ref. No.</b>	4007.0600
<b>description</b>	cable gland thread PG9 cable ø 6.0-8.0mm mounting ø 15.2mm nickel-plated brass Qty 5 pcs		
<b>For models:</b>	CC101, CC201, CC6, CCD101, CCD102, CCD61, CD101, CD20, CD201, CM101, CM201, CM62		
<b>accessories for</b>	550303		
	<b>GEV No.</b>	550321	<b>Ref. No.</b>
			4007.0601
	nut thread PG9 WS 18 nickel-plated brass Qty 5 pcs thickness 2.9mm mounting ømm cable ømm		

			
1			
<b>GEV No.</b>	379729	<b>Ref. No.</b>	40.00.205 40.01.542 40.02.383
<b>description</b>	connection cable L 1230mm 4-pole for level electrode plug type coded		
<b>For models:</b>	CM101, CM102, CM201, CM202, CM61, CM62, SCC101, SCC102, SCC201, SCC202, SCC61, SCC62		
<b>accessories for</b>	379729		
	<b>GEV No.</b>	400022	<b>Ref. No.</b>
			3002.0402
	level electrode PG9 total length 135mm probe L 89/59/28mm insulated probe length 80mm with 3 probes connection grip connection		





			
1			
<b>GEV No.</b>	403812	<b>Ref. No.</b>	40.00.228 40.00.235
<b>description</b>	connection cable L 1500mm 8-pole for combi-steamer suitable for SCC Linie 202 connection plug-in connection		
<b>For models:</b>	CM102, CM201, CM202, CM62, SCC102, SCC201, SCC202		

			
1			
<b>GEV No.</b>	403777	<b>Ref. No.</b>	40.00.211
<b>description</b>	connection cable L 165mm 2-pole for halogen lamp suitable for SCC-Linie 61/62/101 connection plug-in connection		
<b>For models:</b>	SCC101, SCC202, SCC61, SCC62		

			
1			
<b>GEV No.</b>	403810	<b>Ref. No.</b>	40.00.243
<b>description</b>	connection cable L 1750mm 8-pole for combi-steamer SCC Linie 202 connection plug-in connection Japan		
<b>For models:</b>	CM202, SCC202		

			
1			
<b>GEV No.</b>	403811	<b>Ref. No.</b>	8720.1302 8720.1302ET
<b>description</b>	connection cable L 525mm 7-pole for combi-steamer CPC-Linie CPC/CM 61-202 connection plug-in connection plug type coded for PCB		
<b>For models:</b>	CM101, CM102, CM201, CM202, CM61, CPC101, CPC102, CPC201, CPC202, CPC61		

			
1			
<b>GEV No.</b>	403300	<b>Ref. No.</b>	40.00.207
<b>description</b>	connection cable L 740mm 3-pole for differential pressure transmitter connection coded plug		
<b>For models:</b>	SCC101, SCC102, SCC202, SCC61, SCC62		

			
1			
<b>GEV No.</b>	579001	<b>Ref. No.</b>	40.00.472
<b>description</b>	data cable L 1300mm 8-pole suitable for RATIONAL plug type RJ45		
<b>For models:</b>	CM101, CM102, CM201, CM202, CM61, CM62, SCC102, SCC201, SCC202, SCC62		

			
1			
<b>GEV No.</b>	579004	<b>Ref. No.</b>	40.04.377
<b>description</b>	data cable L 1800mm 6-pole for combi-steamer SCC, CM plug type RJ45/YY		

			
1			
<b>GEV No.</b>	579005	<b>Ref. No.</b>	8720.1300
<b>description</b>	data cable L 550mm 4-pole for combi-steamer suitable for CPC-Linie CPC/CM 61-202 plug type USB		
<b>For models:</b>	CM101, CM102, CM201, CM202, CM61, CPC101, CPC102, CPC201, CPC202, CPC61		

			
1			
<b>GEV No.</b>	579002	<b>Ref. No.</b>	40.00.471
<b>description</b>	data cable L 800mm 8-pole for combi-steamer suitable for SCC Line plug type RJ45		
<b>For models:</b>	CM101, CM201, CM202, CM61, SCC101, SCC102, SCC201, SCC202, SCC61, SCC62		

### terminals and connectors

not insulated

female fastons

iron nickel-plated

			
1			
<b>GEV No.</b>	550001	<b>Ref. No.</b>	4002.0100
<b>description</b>	female faston size 6.3x0.8mm 1.0-2.5mm <sup>2</sup> straight Fe gal Ni t.max. 340°C Qty 100 pcs		
<b>For models:</b>	CC101, CC201, CC6, CCC101, CCC102, CCC61, CCD101, CCD102, CCD61, CCM101, CCM102, CCM61, CD101, CD102, CD20, CD201, CD202, CD61, CM101, CM102, CM201, CM202, CM61, CPC101, CPC102, CPC201, CPC202, CPC61		

### plug connectors

			
1			
<b>GEV No.</b>	551357	<b>Ref. No.</b>	3040.0262
<b>description</b>	plug connector 10-pole left raster size 3.5mm		
<b>For models:</b>	CD101, CM101, CM102, CM201, CM202, CM61, CPC101, CPC102, CPC201, CPC202, CPC61		



terminals

PCB terminal blocks

 <p>1</p>			
<b>GEV No.</b>	550809	<b>Ref. No.</b>	3040.0193 3040.0198
<b>description</b>	PCB terminal block 11-pole raster size 5mm		
<b>For models:</b>	CC101, CC201, CC6, CD101, CD102, CD201, CD202, CD61		

rail-mounted terminals

WIELAND

rail-mounted terminals type 9700A

 <p>1</p>			
<b>GEV No.</b>	550374	<b>Ref. No.</b>	4001.1250
<b>description</b>	rail-mounted terminal WIELAND type 9700A/10 S35 1.5-16mm <sup>2</sup> top-hat rail 35mm blue W 10mm L 49mm		
<b>For models:</b>	CC101, CC6, CCC101, CCC61, CCD101, CCD61, CCM101, CCM61, CD101, CD102, CD201, CD61, CM101, CM102, CM201, CM202, CM61, CM62, CPC101, CPC201, CPC202, CPC61, SCC101, SCC61, SCC62		

 <p>1</p>			
<b>GEV No.</b>	550373	<b>Ref. No.</b>	4001.1202 4001.1209
<b>description</b>	rail-mounted terminal WIELAND type 9700A/10 S35 1.5-16mm <sup>2</sup> top-hat rail 35mm grey W 10mm L 49mm		
<b>For models:</b>	CC101, CC6, CCC101, CCC61, CCD101, CCD61, CCM101, CCM61, CD101, CD102, CD20, CD201, CD61, CM101, CM102, CM201, CM202, CM61, CM62, CPC101, CPC201, CPC202, CPC61, SCC101, SCC61		

 <p>1</p>			
<b>GEV No.</b>	550377	<b>Ref. No.</b>	4001.1251 4001.1252
<b>description</b>	rail-mounted terminal WIELAND type 9700A/16 S35 2.5-35mm <sup>2</sup> top-hat rail 35mm blue W 16mm L 59mm		
<b>For models:</b>	CC201, CCC102, CCC201, CCC202, CCD102, CCD201, CCD202, CCM102, CCM201, CCM202, CD101, CD102, CD201, CD202, CM101, CM102, CM201, CM202, CPC102, CPC201, CPC202, SCC102, SCC201, SCC202		

 <p>1</p>			
<b>GEV No.</b>	550376	<b>Ref. No.</b>	4001.1206
<b>description</b>	rail-mounted terminal WIELAND type 9700A/16 S35 2.5-35mm <sup>2</sup> top-hat rail 35mm grey W 16mm L 59mm		
<b>For models:</b>	CC201, CCC102, CCC201, CCC202, CCD102, CCD201, CCD202, CCM102, CCM201, CCM202, CD101, CD102, CD20, CD201, CD202, CM101, CM102, CM201, CM202, CM61, CM62, CPC101, CPC102, CPC201, CPC202, SCC101, SCC102, SCC201, SCC202, SCC61, SCC62		

 <p>1</p>			
<b>GEV No.</b>	550378	<b>Ref. No.</b>	4001.1233
<b>description</b>	rail-mounted terminal WIELAND type 9700A/16 SL2 S35 2.5-35mm <sup>2</sup> top-hat rail 35mm yellow/green W 16mm L 53mm		
<b>For models:</b>	CC201, CCC102, CCC201, CCC202, CCD102, CCD201, CCD202, CCM102, CCM201, CCM202, CD101, CD102, CD20, CD201, CD202, CM101, CM102, CM201, CM202, CM62, CPC101, CPC102, CPC201, CPC202, SCC102, SCC201, SCC202, SCC62		

 <p>1</p>			
<b>GEV No.</b>	550371	<b>Ref. No.</b>	4001.1216
<b>description</b>	rail-mounted terminal WIELAND type 9700A/6 S35 0.5-4mm <sup>2</sup> top-hat rail 35mm grey W 6mm L 46.6mm		
<b>For models:</b>	CC201, CCC101, CCC102, CCC201, CCC202, CCC61, CCD101, CCD102, CCD201, CCD202, CCD61, CCM101, CCM102, CCM201, CCM202, CCM61, CD101, CD102, CD20, CD201, CD202, CD61, CM101, CM102, CM201, CM202, CM61, CM62, CPC101, CPC102, CPC201, CPC202, CPC61		

 <p>1</p>			
<b>GEV No.</b>	550372	<b>Ref. No.</b>	4001.1222
<b>description</b>	rail-mounted terminal WIELAND type 9700A/6 SL2 S35 0.5-4mm <sup>2</sup> top-hat rail 35mm yellow/green W 6mm L 48.5mm		
<b>For models:</b>	CC101, CC201, CC6, CD101, CD201, CM101, CM102, CM201, CM202, CM61, CM62, CPC101, CPC102, CPC201, CPC61, SCC101, SCC102, SCC201, SCC202, SCC61, SCC62		





## fuse terminal blocks



<b>GEV No.</b>	550104	<b>Ref. No.</b>	4001.1247
<b>description</b>	fuse holder WIELAND type WK4/THSI 5 U/V0 suitable fuse $\phi$ 5x30mm 0.5-6mm <sup>2</sup> top-hat rail 35mm 10A rated 600V		
<b>For models:</b>	CCC101, CCC102, CCC201, CCC61, CCD101, CCD102, CCD201, CCD202, CCD61, CCM101, CCM102, CCM201, CCM61		



<b>GEV No.</b>	550348	<b>Ref. No.</b>	4001.1283
<b>description</b>	fuse holder WIELAND type WK4/THSI 6.3 U/V0 suitable fuse $\phi$ 6.3x32mm 6.3A rated 600V		
<b>For models:</b>	CD101, CD102, CD201, CD202, CD61, CM101, CM102, CM201, CM202, CM61, CPC101, CPC102, CPC201, CPC202, CPC61		



<b>GEV No.</b>	550105	<b>Ref. No.</b>	4001.1228
<b>description</b>	rail-mounted terminal WIELAND type WK10/SIU 5X20 /V0 suitable fuse $\phi$ 5x20mm 1.0-16mm <sup>2</sup> 10A rated 250V		
<b>For models:</b>	CC101, CC201, CC6, CD101, CD20, CD201, CM101, CM201, CM62		

## accessories



<b>GEV No.</b>	550337	<b>Ref. No.</b>	4001.1227
<b>description</b>	end barrier for fuse terminal clampsmm <sup>2</sup>		
<b>For models:</b>	CC201, CC6, CD101, CD201, CM101, CM201, CM62		



<b>GEV No.</b>	550370	<b>Ref. No.</b>	4001.1203
<b>description</b>	terminal block end bracket clampsmm <sup>2</sup>		
<b>For models:</b>	CC101, CC201, CC6, CCC101, CCC102, CCC201, CCC202, CCC61, CCD101, CCD102, CCD201, CCD202, CCD61, CCM101, CCM102, CCM201, CCM202, CCM61, CD101, CD102, CD20, CD201, CD202, CD61, CM101, CM102, CM201, CM202, CM61, CM62, CPC101, CPC102, CPC201, CPC202, CPC61, SCC101, SCC102, SCC201, SCC202, SCC61, SCC62		

## electronic components

## miscellaneous



<b>GEV No.</b>	403814	<b>Ref. No.</b>	87.01.084 87.01.085 87.01.275
<b>description</b>	memory stick USB for Software Update suitable for combi-steamer SCC_WE, CM_P		



<b>GEV No.</b>	403536	<b>Ref. No.</b>	87.00.037
<b>description</b>	memory stick with USB interface		



<b>GEV No.</b>	403449	<b>Ref. No.</b>	8720.1462
<b>description</b>	motor break electric suitable for RATIONAL		



<b>GEV No.</b>	403888	<b>Ref. No.</b>	7007.3006 7007.3080 7007.3090
<b>description</b>	USB stick for combi-steamer SCC Line		

## gas valves and ignition boxes

## gas control valves

## DUNGS



<b>GEV No.</b>	106050	<b>Ref. No.</b>	70.00.220
<b>description</b>	gas valve 230V 50/60Hz gas inlet 1/2" gas outlet 1/2" DUNGS type GB 055 243 443		
<b>For models:</b>	CM101, CM102, CM201, CM202, CM61, CM62, SCC101, SCC102, SCC201, SCC202, SCC61, SCC62		



1

<b>GEV No.</b>	106051	<b>Ref. No.</b>	70.00.031
<b>description</b>	gas valve 230V 50/60Hz gas inlet 1/2" gas outlet 1/2" DUNGS type GB-WND 055 243 442		
<b>For models:</b>	CM101, CM102, CM201, CM202, CM61, CM62, SCC101, SCC102, SCC201, SCC202, SCC61, SCC62		



1

<b>GEV No.</b>	107554	<b>Ref. No.</b>	70.00.029
<b>description</b>	gas valve 230V 50/60Hz gas inlet 1/2" gas outlet 1/2" total length 105mm DUNGS type GB-WND 055 D01 S02 243442		
<b>For models:</b>	CM101, CM102, CM201, CM202, CM61, CM62, SCC101, SCC102, SCC201, SCC202, SCC61, SCC62		



1

<b>GEV No.</b>	107555	<b>Ref. No.</b>	70.00.033
<b>description</b>	gas valve 230V 50/60Hz gas inlet 1/2" IT gas outlet 1/2" IT total length 105mm DUNGS type GB-ND 055 D01 S02 243443		
<b>For models:</b>	CM101, CM61, CM62, SCC101, SCC61, SCC62		

HONEYWELL



1



<b>GEV No.</b>	101186	<b>Ref. No.</b>	3039.0241
<b>description</b>	gas valve type VK4105C 220-240V 50/60Hz gas inlet flange 32x32mm gas outlet flange 32x32mm thermocouple connection pilot connection pressure range 15-60mbar max 60mbar operator type pressure controller type V5360E 1226 1 HONEYWELL flange 32x32mm		
<b>For models:</b>	CM101, CM102, CM201, CM202, CM61, CPC101, CPC102, CPC201, CPC202, CPC61		
<b>accessories for</b>	101186		
	<b>GEV No.</b>	<b>Ref. No.</b>	—
	102845		
	gas connection angled 1/2" flange 32x32mm hole distance 24x24mm Tandem		

<b>accessories for</b>	101186		
	<b>GEV No.</b>	<b>Ref. No.</b>	—
	102846		
	gas connection straight 1/2" flange 32x32mm hole distance 24x24mm suitable for Tandem		



1

<b>GEV No.</b>	106054	<b>Ref. No.</b>	3039.0245 3039.0245P
<b>description</b>	gas valve type VK4115V 220-240V 50/60Hz gas inlet flange 32x32mm gas outlet flange 32x32mm thermocouple connection pilot connection pressure range 15-60mbar operator type HONEYWELL flange 32x32mm		
<b>For models:</b>	CM101, CM102, CM201, CM202, CM61, CPC101, CPC102, CPC201, CPC202, CPC61		

<b>accessories for</b>	106054		
	<b>GEV No.</b>	<b>Ref. No.</b>	—
	102845		
	gas connection angled 1/2" flange 32x32mm hole distance 24x24mm Tandem		
	<b>GEV No.</b>	<b>Ref. No.</b>	—
	102846		
	gas connection straight 1/2" flange 32x32mm hole distance 24x24mm suitable for Tandem		

SIT

NOVASIT



1

<b>GEV No.</b>	106055	<b>Ref. No.</b>	3039.0221
<b>description</b>	gas valve SIT series Novasit 827 230V 50Hz gas inlet 1/2" gas outlet 1/2" thermocouple connection pilot connection closed ignition pressure 3-5mbar pressure range 3-37mbar pressure regulator connection standard equiv. no. 0.827.111 power supply for modulator 28VDC		
<b>For models:</b>	CM201		



<b>spare parts for</b>	106055		
	<b>GEV No.</b>	<b>Ref. No.</b>	—
	101313		
	solenoid coil 230V 50Hz		
<b>accessories for</b>	106055		
	<b>GEV No.</b>	<b>Ref. No.</b>	—
	100006		
	piezoelectric igniter suitable for ELETTROSIT body plastic blowing connection ø2.4mm ø 14mm		
	<b>GEV No.</b>	<b>Ref. No.</b>	—
	101305		
	gas connection straight 1/2" flange 45x45mm ELETTROSIT/V4400/4600/4605 suitable for SIT/HONEYWELL hole distance 36x36mm		

Table continues overleaf



accessories for		106055	
	GEV No.	101306	Ref. No. —
gas connection angled flange 45x45mm hole distance 36x36mm 1/2" ELETTROSIT/V4400/4600/4605 screw with O-ring suitable for SIT/HONEYWELL			
	GEV No.	101307	Ref. No. —
gas connection straight flange 45x45mm hole distance 36x36mm 3/4" ELETTROSIT/V4400/4600/4605 screw with O-ring suitable for SIT/HONEYWELL			
	GEV No.	101308	Ref. No. —
gas connection angled flange 45x45mm hole distance 36x36mm 3/4" ELETTROSIT/V4400/4600/4605 screw with O-ring suitable for SIT/HONEYWELL			
	GEV No.	101312	Ref. No. —
microswitch			
	GEV No.	101314	Ref. No. —
solenoid coil 24V 50Hz			
	GEV No.	101317	Ref. No. 3039.0205
plug with cable L 1000mm suitable for NOVASIT			
	GEV No.	101318	Ref. No. —
cover cap for solenoid coil suitable for NOVASIT			

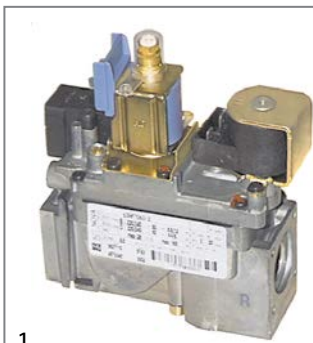

1

<b>GEV No.</b>	101163	<b>Ref. No.</b>	3039.0204 3039.0211 3039.0220 8720.1419
<b>description</b>	gas valve SIT series Novasit 827 230V 50Hz gas inlet 1/2" gas outlet 1/2" thermocouple connection pilot connection M10x1 ignition pressure 3-5mbar pressure range 2-20mbar pressure regulator connection standard equiv. no. 0.827.110 power supply for modulator 28VDC		
<b>For models:</b>	CM101, CM201, CM62		
<b>spare parts for</b>	101163		
	GEV No.	101313	Ref. No. —
solenoid coil 230V 50Hz			
<b>accessories for</b>	101163		
	GEV No.	100006	Ref. No. —
piezoelectric igniter suitable for ELETTROSIT body plastic blowing connection ø2.4mm ø 14mm			
	GEV No.	101305	Ref. No. —
gas connection straight 1/2" flange 45x45mm ELETTROSIT/V4400/4600/4605 suitable for SIT/HONEYWELL hole distance 36x36mm			
	GEV No.	101306	Ref. No. —
gas connection angled flange 45x45mm hole distance 36x36mm 1/2" ELETTROSIT/V4400/4600/4605 screw with O-ring suitable for SIT/HONEYWELL			
	GEV No.	101307	Ref. No. —
gas connection straight flange 45x45mm hole distance 36x36mm 3/4" ELETTROSIT/V4400/4600/4605 screw with O-ring suitable for SIT/HONEYWELL			

accessories for		101163	
	GEV No.	101308	Ref. No. —
gas connection angled flange 45x45mm hole distance 36x36mm 3/4" ELETTROSIT/V4400/4600/4605 screw with O-ring suitable for SIT/HONEYWELL			
	GEV No.	101312	Ref. No. —
microswitch			
	GEV No.	101314	Ref. No. —
solenoid coil 24V 50Hz			
	GEV No.	101317	Ref. No. 3039.0205
plug with cable L 1000mm suitable for NOVASIT			
	GEV No.	101318	Ref. No. —
cover cap for solenoid coil suitable for NOVASIT			

**ignition boxes**

**HONEYWELL**



1

<b>GEV No.</b>	101166	<b>Ref. No.</b>	3039.0103
<b>description</b>	ignition box HONEYWELL type S4560B 1006 electrodes 1 waiting time 0s safety time 10s 220-240V 10VA 50Hz		
<b>For models:</b>	CM101, CM201, CM62		



1

<b>GEV No.</b>	102381	<b>Ref. No.</b>	3039.0107 3039.0107P
<b>description</b>	ignition box HONEYWELL type S4565BD 1064 electrodes 3 waiting times safety time 5s 220-240V 4VA 50/60Hz		
<b>For models:</b>	CM101, CM102, CM201, CM202, CM61, CPC101, CPC102, CPC201, CPC202, CPC61		



Honeywell



1

<b>GEV No.</b>	101184	<b>Ref. No.</b>	3039.0105
<b>description</b>	ignition box HONEYWELL type S4565C 1033 equiv. no. S4565C 1033 electrodes 2 waiting times safety time 5s 220-240V 4VA 50/60Hz		
<b>For models:</b>	CM101, CM102, CM201, CM202, CM61, CPC101, CPC102, CPC201, CPC202, CPC61		

miscellaneous



1

<b>GEV No.</b>	107679	<b>Ref. No.</b>	74.00.883
<b>description</b>	ignition box type		
<b>spare parts for</b>	107679		
	<b>GEV No.</b>	579004	<b>Ref. No.</b> 40.04.377
	data cable L 1800mm 6-pole for combi-steamer SCC, CM plug type RJ45/YY		



1

<b>GEV No.</b>	102380	<b>Ref. No.</b>	74.00.221
<b>description</b>	ignition box type 3a9PHC070-R1		
<b>For models:</b>	CM101, CM102, CM201, CM202, CM61, CM62, SCC101, SCC102, SCC201, SCC202, SCC61, SCC62		



1

<b>GEV No.</b>	107191 <sup>1</sup>	<b>Ref. No.</b>	87.00.577
<b>description</b>	ignition box type with connection cable		
<b>accessories for</b>	107191		
	<b>GEV No.</b>	579004	<b>Ref. No.</b> 40.04.377
	data cable L 1800mm 6-pole for combi-steamer SCC, CM plug type RJ45/YY		

<sup>1</sup>with connection cable

ignition parts

electrodes



1

<b>GEV No.</b>	106829	<b>Ref. No.</b>	74.00.290
<b>description</b>	gasket for ignition electrode ID $\varnothing$ 10mm hole $\varnothing$ 4.5mm L 27mm W 17mm		
<b>For models:</b>	CM101, CM102, CM201, CM202, CM61, CM62, SCC101, SCC102, SCC201, SCC202, SCC61, SCC62		



1

<b>GEV No.</b>	550897	<b>Ref. No.</b>	44.00.250
<b>description</b>	gasket ignition electrode graphite thickness 2.5mm hole distance 27mm		
<b>For models:</b>	CM101, CM102, CM201, CM202, CM61, CM62, SCC101, SCC102, SCC201, SCC202, SCC61, SCC62		

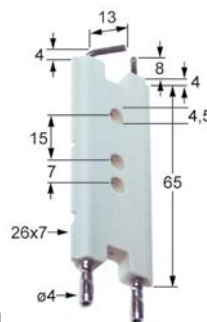

1

<b>GEV No.</b>	102881	<b>Ref. No.</b>	2068.0153
<b>description</b>	ignition electrode D1 $\varnothing$ 26x7mm L1 4mm L2 8mm L4 13/8mm BL1 65mm connection $\varnothing$ 4 fixing dimensions $\varnothing$ 4.5mm mounting distance 15/7mm		
<b>For models:</b>	CM101, CM201		



1

<b>GEV No.</b>	103301	<b>Ref. No.</b>	2068.0152
<b>description</b>	ignition electrode D1 $\varnothing$ 7mm L1 5mm L2 12mm BL1 63mm to clip connection $\varnothing$ 4mm		
<b>For models:</b>	CM101, CM201, CM62		

1

<b>GEV No.</b>	107858	<b>Ref. No.</b>	2068.0300
<b>description</b>	ignition electrode flange length 18mm flange width 17mm D1 ø 7mm D2 ø 7.5mm L1 5.5mm L2 23mm L3 14mm BL1 46.5mm BL2 13.5mm mounting distance 10mm connection ø 4mm		
<b>For models:</b>	CM101, CM102, CM201, CM202, CM61, CPC101, CPC102, CPC201, CPC202, CPC61		

1

<b>GEV No.</b>	103326	<b>Ref. No.</b>	74.00.873
<b>description</b>	ignition electrode flange length 30mm flange width 17.5mm D1 ø 9mm L1 60mm L2 18mm BL1 27mm BL2 29mm fixing dimensions M4mm flange SCC_WE, CM_P 61-101/201G		

1

<b>GEV No.</b>	103303	<b>Ref. No.</b>	74.00.034P
<b>description</b>	ignition electrode flange length 26mm flange width 16mm D1 ø 9mm D2 ø 3.5mm L1 88mm BL1 82mm cable length 340mm		

1

<b>GEV No.</b>	103333	<b>Ref. No.</b>	74.00.235 74.00.235S
<b>description</b>	ignition electrode flange length 30mm flange width 17mm D1 ø 9mm L1 37mm L2 10mm BL1 15mm BL2 25mm fixing dimensions M4mm with flange with earthing contact		
<b>For models:</b>	CM101, CM102, CM201, CM202, CM61, CM62, SCC101, SCC102, SCC201, SCC202, SCC61, SCC62		

1

<b>GEV No.</b>	103302	<b>Ref. No.</b>	74.00.230 74.00.230P
<b>description</b>	ignition electrode flange length 26mm flange width 16mm D1 ø 9mm L1 9mm L2 73mm BL1 82mm BL2 14mm connection F 4.8x0.8mm cable length 400mm mounting distance 19mm with flange		
<b>For models:</b>	CM101, CM102, CM201, CM202, CM61, CM62, SCC101, SCC102, SCC201, SCC202, SCC61, SCC62		



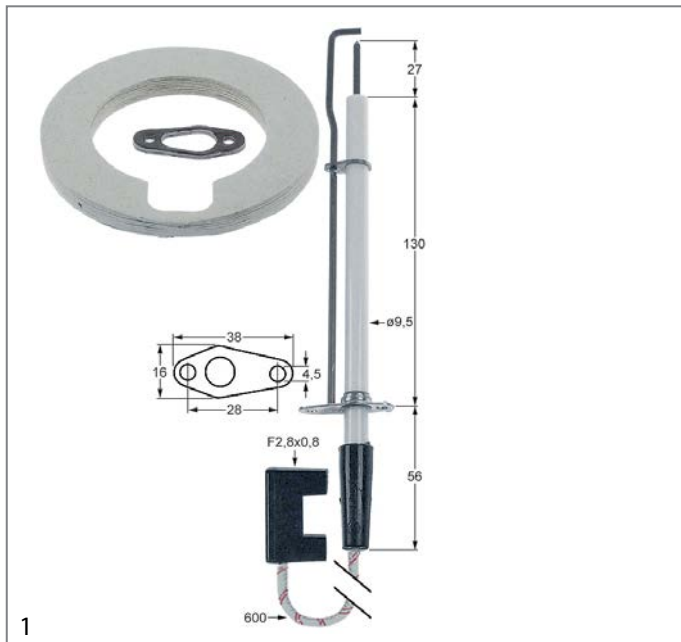

<b>GEV No.</b>	102884	<b>Ref. No.</b>	44.00.249 44.00.249P 87.00.662
<b>description</b>	ignition electrode flange length 38mm flange width 16mm D1 ø 9.5mm L1 27mm BL1 130mm BL2 56mm connection F 2.8x0.8mm cable length 600mm fixing dimensions ø4.5mm mounting distance 28mm with flange with earthing contact		
<b>For models:</b>	CM101, CM102, CM201, CM202, SCC101, SCC102, SCC201, SCC202		

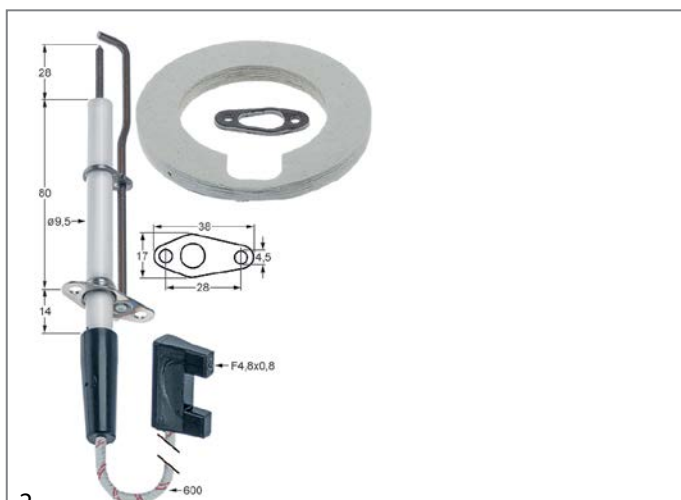

<b>GEV No.</b>	102883	<b>Ref. No.</b>	44.00.251P 87.00.663
<b>description</b>	ignition electrode flange length 38mm flange width 17mm D1 ø 9.5mm L1 28mm BL1 80mm BL2 14mm connection F 4.8x0.8mm cable length 600mm fixing dimensions ø4.5mm mounting distance 28mm with flange with earthing contact		
<b>For models:</b>	CM61, CM62, SCC61, SCC62		

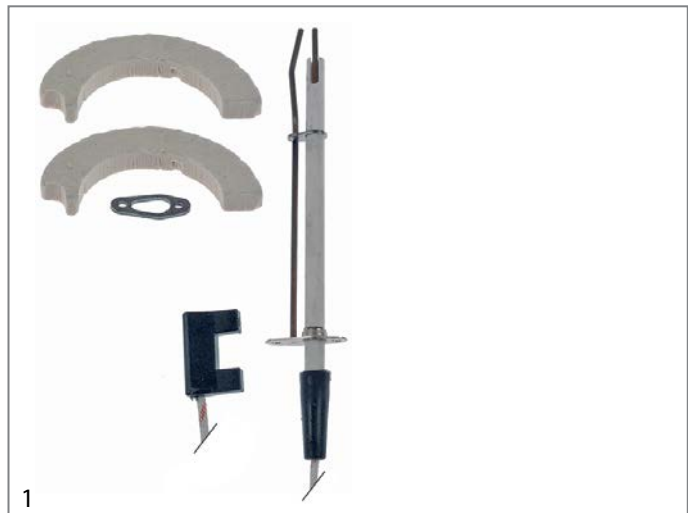

<b>GEV No.</b>	103304	<b>Ref. No.</b>	44.01.237 44.01.237P 87.01.346
<b>description</b>	ignition electrode with accessories flange length 38mm flange width 16mm D1 ø 9mm BL1 54mm BL2 144mm cable length 575mm		

## gas burners

### bar burners

<b>GEV No.</b>	109184	<b>Ref. No.</b>	72.00.048
<b>description</b>	insulation for burner ø 97.5mm ID ø 62.5mm thickness 9.5mm		
<b>For models:</b>	CM101, CM102, CM201, CM202, CM61, CM62, SCC101, SCC102, SCC201, SCC202, SCC61, SCC62		

### surface burners

<b>GEV No.</b>	105948	<b>Ref. No.</b>	2068.0215 2068.0225
<b>description</b>	surface burner L 330mm W 140mm H 55mm firing range 320x130mm burner rows 18 convection oven		
<b>For models:</b>	CM101, CM201, CM62		

<b>GEV No.</b>	105951	<b>Ref. No.</b>	2068.0229 2072.1001
<b>description</b>	surface burner number of rows 14 nozzle ø 0.62mm		
<b>For models:</b>	CM201		



1

<b>GEV No.</b>	105952	<b>Ref. No.</b>	2068.0228 2072.1000
<b>description</b>	surface burner number of rows 14 nozzle ø 1.1mm		
<b>For models:</b>	CM201		



1

<b>GEV No.</b>	105949	<b>Ref. No.</b>	2068.0227 2072.1002
<b>description</b>	surface burner number of rows 18 nozzle ø 0.62mm		
<b>For models:</b>	CM201		



1

<b>GEV No.</b>	105950	<b>Ref. No.</b>	2068.0216 2068.0226
<b>description</b>	surface burner number of rows 18 nozzle ø 0.65mm LPG		
<b>For models:</b>	CM101, CM62		

## forced air burners



1

<b>GEV No.</b>	108152	<b>Ref. No.</b>	70.00.566
<b>description</b>	blower for burner combi-steamer SCC_WE, CM_P 61-202 230V 110W hole distance 50mm NRG18/0800-3612-030203		

## accessories

### gaskets



1

<b>GEV No.</b>	104283	<b>Ref. No.</b>	5110.1318
<b>description</b>	gasket L 100mm W 100mm hole ø 64mm		
<b>For models:</b>	CM101, CM102, CM201, CM202, CM61, CPC101, CPC102, CPC201, CPC202, CPC61		

### miscellaneous



1

<b>GEV No.</b>	500807	<b>Ref. No.</b>	8668.1372
<b>description</b>	deflector for aspiration		

## auxiliary gas parts

### gas hoses

#### miscellaneous



1

<b>GEV No.</b>	250036	<b>Ref. No.</b>	2036.0610
<b>description</b>	gas hose T1: 1/2" L 800mm		
<b>For models:</b>	CM101, CM62		

### pressure switches



1

<b>GEV No.</b>	541108	<b>Ref. No.</b>	3017.1004
<b>description</b>	pressure control		
<b>For models:</b>	CM101, CM102, CM201, CM202, CM61, CPC101, CPC102, CPC201, CPC202, CPC61		



1

<b>GEV No.</b>	541111	<b>Ref. No.</b>	3017.1003 3017.1006 3017.1010
<b>description</b>	pressure control pressure range adjustable 0.2- 3mbar pressure connection horizontal gas technology connection 6mm suitable for RATIONAL		
<b>For models:</b>	CM101, CM102, CM201, CM202, CM61, CPC101, CPC102, CPC201, CPC202, CPC61		



consumables

PTFE tapes



1	<b>GEV No.</b>	890100	<b>Ref. No.</b>	5012.0524
<b>description</b>	PTFE tape reel L 12m W 12mm -200 up to +260°C approval DIN-DVGW, KTW temperature-resistant, elastic for fine thread thickness 0.1mm			
<b>description</b>	PTFE thread sealing tape for fine metal threads Application: All sanitary and heating circuits in hot and cold water areas. DVGW tested. DIN EN751-3. For fine thread DN < 10. Pressure: up to 20 bar. Temperature range: -60°C to +260°C			
<b>For models:</b>	CM101, CM201, CM62			

equipment-specific units  
for convection ovens/combi-steamers

drain units

drip rails



1	<b>GEV No.</b>	696533	<b>Ref. No.</b>	2530.070008 8100.0116
<b>description</b>	drip rail for combi-steamer L 600mm SS W 34mm hole ø 8mm			
<b>For models:</b>	CC101, CC6, CD101, CM101			



1	<b>GEV No.</b>	699339	<b>Ref. No.</b>	24.01.800
<b>description</b>	drip rail for door inside L 495mm W 19.5mm for combi-steamer SCC, CM 61/101			
<b>For models:</b>	CM101, CM61, SCC101, SCC61			

1	<b>GEV No.</b>	694434	<b>Ref. No.</b>	8455.1315 8455.1465 8455.1474 8455.1481
<b>description</b>	drip rail with bezel L 465mm plastic for combi-steamer hose ø 15mm			
<b>For models:</b>	CD101, CD61, CM101, CM61, CPC101, CPC61			

1	<b>GEV No.</b>	692854	<b>Ref. No.</b>	50.01.192
<b>description</b>	drip rail with sleeve L 750mm plastic suitable for combi-steamer SCC 62/102			
<b>For models:</b>	SCC102, SCC62			
<b>spare parts for</b>	692854			
	<b>GEV No.</b>	694322	<b>Ref. No.</b>	50.00.303
<b>description</b>	sleeve for drip pan D1 ø 15mm D2 ø 20mm L 62mm			

steam generators

steam generators



1	<b>GEV No.</b>	692686	<b>Ref. No.</b>	8350.1300
<b>description</b>	steam generator L 250mm W 140mm H 440mm			
<b>For models:</b>	CD61, CM61, CPC61			

			
1			
<b>GEV No.</b>	697779	<b>Ref. No.</b>	8350.7100
<b>description</b>	steam generator suitable for RATIONAL		
<b>For models:</b>	CM201, CPC201		

<b>spare parts and accessories</b>			
			
1			
<b>GEV No.</b>	108152	<b>Ref. No.</b>	70.00.566
<b>description</b>	blower for burner combi-steamer SCC_WE, CM_P 61-202 230V 110W hole distance 50mm NRG118/0800-3612-030203		

			
1			
<b>GEV No.</b>	694998	<b>Ref. No.</b>	56.00.488
<b>description</b>	container L 160mm W 135mm H 66mm suitable for combi-steamer SCC Linie 61-202		
<b>For models:</b>	SCC101, SCC102, SCC61, SCC62		

			
1			
<b>GEV No.</b>	694996	<b>Ref. No.</b>	54.01.141S
<b>description</b>	sleeve with clip $\varnothing$ 61/73mm suitable for combi-steamer SCC_WE, CM_P 61/62/101		

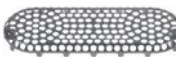
<b>filters</b>			
			
1			
<b>GEV No.</b>	514525	<b>Ref. No.</b>	54.01.117
<b>description</b>	drain filter L 168mm W 59mm H 22mm for combi-steamer SCC_WE, CM_P 61-202		

			
1			
<b>GEV No.</b>	701580	<b>Ref. No.</b>	2005.0307
<b>description</b>	drain filter $\varnothing$ 71mm H 18mm IT M6 for combi-steamer model CPC-Li- nie CPC 61/101/201		
<b>For models:</b>	CPC101, CPC201, CPC61		

**steam pipes**

			
1			
<b>GEV No.</b>	530875	<b>Ref. No.</b>	44.00.362
<b>description</b>	steam hose ext. $\varnothing$ 78 ID $\varnothing$ 70mm L 54mm silicone red/black		
<b>For models:</b>	CM202, SCC202		



 <p>1</p>			
<b>GEV No.</b>	701575	<b>Ref. No.</b>	20.00.998
<b>description</b>	drain filter ø 98mm H 26mm for combi-steamer model SCC Linie 61/101 spout ø 70mm		
<b>For models:</b>	CM101, CM61, SCC101, SCC61		

 <p>1</p>			
<b>GEV No.</b>	694649	<b>Ref. No.</b>	16.01.327
<b>description</b>	mounting plate L 425mm W 31mm H 20mm SS for control panel		
<b>For models:</b>	CM101, CM102, CM201, CM202, CM61, CM62, SCC101, SCC102, SCC201, SCC202, SCC61, SCC62		

housing and bezels			
 <p>1</p>			
<b>GEV No.</b>	699801	<b>Ref. No.</b>	56.00.380 87.01.288
<b>description</b>	cover for drain assembly L 325mm W 162mm H 92mm		
<b>For models:</b>	SCC101, SCC102, SCC61, SCC62		

glass panels			
 <p>1</p>			
<b>GEV No.</b>	692856	<b>Ref. No.</b>	24.00.212
<b>description</b>	door glass for combi-steamer SCC/CM202 L 1340mm mounting pos. inner W 680mm thickness 6mm		
<b>For models:</b>	CM202, SCC202		

 <p>1</p>			
<b>GEV No.</b>	699802	<b>Ref. No.</b>	50.00.279 50.00.751
<b>description</b>	cover for spray gun D1 ø 90/145mm L 145mm H 68mm		
<b>For models:</b>	CM101, CM102, CM61, CM62, SCC101, SCC102, SCC61, SCC62		

 <p>1</p>			
<b>GEV No.</b>	694937	<b>Ref. No.</b>	8474.1336
<b>description</b>	glass panel for door inside combi-steamer CPC-Linie 61 L 573mm W 495mm thickness 7mm		
<b>For models:</b>	CD61, CM101, CM61, CPC61		

 <p>1</p>			
<b>GEV No.</b>	694999	<b>Ref. No.</b>	22.00.767
<b>description</b>	cover cap for ventilation combi-steamer SCC_WE, CM_P 61-202 thread M6 ø 100mm		

 <p>1</p>			
<b>GEV No.</b>	694938	<b>Ref. No.</b>	24.00.200
<b>description</b>	glass panel for door inside combi-steamer SCC/CM102 L 763mm W 680mm thickness 7mm		
<b>For models:</b>	CM102, SCC102		

 <p>1</p>			
<b>GEV No.</b>	694939	<b>Ref. No.</b>	22.00.353
<b>description</b>	cover cap for ventilation for combi-steamer SCC Linie 61-202 D1 ø 90mm thread M6 thickness 1mm		
<b>For models:</b>	CM101, CM102, CM201, CM202, CM61, CM62, SCC101, SCC102, SCC201, SCC202, SCC61, SCC62		

 <p>1</p>			
<b>GEV No.</b>	694492	<b>Ref. No.</b>	24.00.163
<b>description</b>	glass panel L 485mm W 508mm thickness 6mm mounting pos. inner for combi-steamer		
<b>For models:</b>	CM61, SCC61		

 <p>1</p>			
<b>GEV No.</b>	699810	<b>Ref. No.</b>	54.00.781
<b>description</b>	lid with nozzle extinction L 170mm W 125mm		
<b>For models:</b>	SCC102, SCC62		



air filters

			
1			
<b>GEV No.</b>	699340	<b>Ref. No.</b>	16.01.526
<b>description</b>	filter L 200mm W 220mm H 50mm		

			
1			
<b>GEV No.</b>	692694	<b>Ref. No.</b>	16.00.292 16.00.673 16.01.662
<b>description</b>	filter L 220mm W 50mm ømm H 150mm SCC Line		
<b>For models:</b>	CM101, CM102, CM201, CM202, CM61, CM62, SCC101, SCC102, SCC201, SCC202, SCC61, SCC62		

			
1			
<b>GEV No.</b>	692695	<b>Ref. No.</b>	2039.0337 5214.1300 8455.1377
<b>description</b>	filter insert L 213mm W 60mm ømm H 90mm		
<b>For models:</b>	CD101, CD102, CD201, CD202, CD61, CM101, CM102, CM201, CM202, CM61, CPC101, CPC102, CPC201, CPC202, CPC61		

cleaning system

coupling bushings

			
1			
<b>GEV No.</b>	694486	<b>Ref. No.</b>	2062.0348
<b>description</b>	coupling bush for cleaning system		
<b>For models:</b>	CPC201, CPC202		

			
1			
<b>GEV No.</b>	694487	<b>Ref. No.</b>	2062.0347
<b>description</b>	coupling bush for cleaning system		
<b>For models:</b>	CPC201, CPC202		

			
1			
<b>GEV No.</b>	694488	<b>Ref. No.</b>	2062.0350
<b>description</b>	coupling bush for cleaning system		
<b>For models:</b>	CPC201, CPC202		

			
1			
<b>GEV No.</b>	694489	<b>Ref. No.</b>	2062.0349
<b>description</b>	coupling bush for cleaning system		
<b>For models:</b>	CPC201, CPC202		

pumps

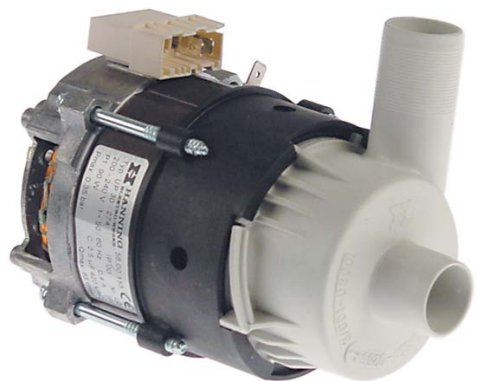
			
1			
<b>GEV No.</b>	500578	<b>Ref. No.</b>	56.00.153 56.00.185
<b>description</b>	pump inlet ø 24mm outlet ø 24mm type UP30-274 230V 50/60Hz 1 phase 0.09kW 0.12HP L 145mm rotation direction left capacitor 2.5µF HANNING		
<b>For models:</b>	SCC101, SCC102, SCC201, SCC202, SCC61, SCC62		
<b>spare parts for</b>	500578		
	<b>GEV No.</b>	501345	<b>Ref. No.</b> —
			
O-ring EPDM thickness 3mm ID ø 58mm Qty 1 pcs			

			
1			
<b>GEV No.</b>	500579	<b>Ref. No.</b>	56.00.178 56.00.178P 56.00.186 87.00.437
<b>description</b>	pump inlet ø 24mm outlet ø 24mm type UP30-275 230V 50/60Hz 1 phase 0.09kW 0.12HP L 145mm rotation direction left capacitor 2.5µF HANNING		
<b>For models:</b>	SCC201, SCC202		
<b>spare parts for</b>	500579		
	<b>GEV No.</b>	501345	<b>Ref. No.</b> —
			
O-ring EPDM thickness 3mm ID ø 58mm Qty 1 pcs			



cleaning arms



1

<b>GEV No.</b>	541433	<b>Ref. No.</b>	8655.2101
<b>description</b>	cleaning arm CleanJet suitable for RATIONAL _101- _202		
<b>For models:</b>	CPC101, CPC102, CPC201, CPC202		



1

<b>GEV No.</b>	541432	<b>Ref. No.</b>	8655.2100
<b>description</b>	cleaning arm CleanJet suitable for RATIONAL _61		
<b>For models:</b>	CPC61		

hoses



1

<b>GEV No.</b>	694491	<b>Ref. No.</b>	50.00.172
<b>description</b>	supply tube for hose reel		
<b>For models:</b>	CM101, CM61, SCC101, SCC61		

pipes



1

<b>GEV No.</b>	520965	<b>Ref. No.</b>	22.00.916
<b>description</b>	air ducting L 183mm ø 52.5mm for combi-steamer SCC_WE, CM_P, 201/202		



1

<b>GEV No.</b>	521193	<b>Ref. No.</b>	22.00.915
<b>description</b>	air ducting L 186mm ø 53mm for combi-steamer SCC_WE, CM_P, 101/102		

non-return valves



1

<b>GEV No.</b>	531321	<b>Ref. No.</b>	2069.0107
<b>description</b>	non-return valve		
<b>For models:</b>	CD201, CD202, CM201, CM202, CPC201, CPC202, SCC201, SCC202		



1

<b>GEV No.</b>	531297	<b>Ref. No.</b>	50.00.078
<b>description</b>	non-return valve ø 16.4mm L 18mm		
<b>For models:</b>	CM101, CM102, CM201, CM202, CM61, CM62, SCC101, SCC102, SCC201, SCC202, SCC61, SCC62		

hoses



1

<b>GEV No.</b>	530794	<b>Ref. No.</b>	2112.1304
<b>description</b>	formed hose ED ø 29mm ID ø 23mm L 485mm for combi-steamer CPC-Linie 102/201E		
<b>For models:</b>	CD102, CD201, CM102, CM201, CPC102, CPC201		



1

<b>GEV No.</b>	530791	<b>Ref. No.</b>	44.00.242
<b>description</b>	formed hose ED ø 29mm ID ø 23mm L 730mm for combi-steamer SCC Linie 202		
<b>For models:</b>	CM202, SCC202		



1			
<b>GEV No.</b>	530908	<b>Ref. No.</b>	44.01.221
<b>description</b>	formed hose ext. $\varnothing$ 30 ID $\varnothing$ 23mm silicone combi-steamer SCC_WE, CM_P		



1			
<b>GEV No.</b>	530793	<b>Ref. No.</b>	44.00.231 44.00.238
<b>description</b>	formed hose ID $\varnothing$ 22mm ED $\varnothing$ 28mm L 640mm for combi-steamer SCC, CM201/202 since 04/2004		
<b>For models:</b>	CM201, CM202, SCC201, SCC202		



1			
<b>GEV No.</b>	530792	<b>Ref. No.</b>	2112.1305
<b>description</b>	formed hose ID $\varnothing$ 22mm ED $\varnothing$ 29mm L 640mm for combi-steamer CPC 202		
<b>For models:</b>	CD202, CM202, CPC202		



1			
<b>GEV No.</b>	694490	<b>Ref. No.</b>	2112.1310
<b>description</b>	formed hose ID $\varnothing$ 22mm ED $\varnothing$ 30mm L 80mm steam generator		
<b>For models:</b>	CD101, CD102, CD201, CD202, CD61, CM101, CM102, CM201, CM202, CM61, CM62, CPC101, CPC102, CPC201, CPC202, CPC61, SCC101, SCC102, SCC201, SCC202, SCC61, SCC62		



1			
<b>GEV No.</b>	698610	<b>Ref. No.</b>	54.00.086
<b>description</b>	formed hose ID $\varnothing$ 48mm ED $\varnothing$ 54mm L 100mm for combi-steamer		
<b>For models:</b>	CM101, CM61, SCC101, SCC61		



1			
<b>GEV No.</b>	694362	<b>Ref. No.</b>	2022.0201
<b>description</b>	hose for combi-steamer		
<b>For models:</b>	CC101, CC201, CC6, CD101, CD201, CM101, CM201		

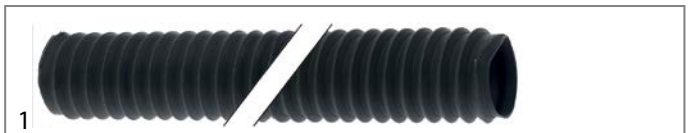

1			
<b>GEV No.</b>	530912	<b>Ref. No.</b>	70.00.117
<b>description</b>	hose ID $\varnothing$ 40mm L 480mm for combi-steamer SCC Linie 101/G		
<b>For models:</b>	CM101, SCC101		



1			
<b>GEV No.</b>	530911	<b>Ref. No.</b>	70.00.115
<b>description</b>	hose ID $\varnothing$ 40mm L 800mm for combi-steamer SCC Linie 101/G		
<b>For models:</b>	CM101, CM62, SCC101, SCC62		



1			
<b>GEV No.</b>	694924	<b>Ref. No.</b>	2112.1300
<b>description</b>	hose ID $\varnothing$ 50mm ED $\varnothing$ 56mm L 89mm CPC-Linie 61		
<b>For models:</b>	CD61, CM61, CPC61		



1			
<b>GEV No.</b>	692102	<b>Ref. No.</b>	2112.1006
<b>description</b>	hose ID $\varnothing$ 50mm ED $\varnothing$ 60mm L 50mm		
<b>For models:</b>	CCC101, CCC102, CCC61, CCD101, CCD102, CCD61, CCM101, CCM102, CCM61, CD101, CD102, CD201, CD61, CM101, CM102, CM201, CM202, CM61, CM62, CPC101, CPC102, CPC201, CPC202, CPC61, SCC101, SCC102, SCC201, SCC61, SCC62		





1

<b>GEV No.</b>	694321	<b>Ref. No.</b>	2112.1307
<b>description</b>	hose ID ø 70mm ext. ø 80 L 80mm for combi-steamer		
<b>For models:</b>	CD102, CD201, CD202, CM102, CM201, CM202, CPC102, CPC201, CPC202, SCC201, SCC202		



1

<b>GEV No.</b>	530875	<b>Ref. No.</b>	44.00.362
<b>description</b>	steam hose ext. ø 78 ID ø 70mm L 54mm silicone red/black		
<b>For models:</b>	CM202, SCC202		



1

<b>GEV No.</b>	698611	<b>Ref. No.</b>	8354.1320
<b>description</b>	pump hose for combi-steamer		
<b>For models:</b>	CM101, CM102, CM201, CM202, CM61, CM62, SCC101, SCC102, SCC201, SCC202, SCC61, SCC62		

service kits



1

<b>GEV No.</b>	530874	<b>Ref. No.</b>	8720.1469 8720.1521
<b>description</b>	conversion kit - for combi-steamer CPC-Linie 61-102E RATIONAL		
<b>For models:</b>	CPC101, CPC102, CPC61		
<b>spare parts for</b>	530874		

	<b>GEV No.</b>	692215	<b>Ref. No.</b>	2039.0360 2039.0362 2039.0376 8720.1525
conversion kit for tank inlet fitting				



1

<b>GEV No.</b>	530796	<b>Ref. No.</b>	2110.1019 2110.1020 2112.1019
<b>description</b>	silicone hose ID ø 5mm ED ø 8mm L 1190mm for combi-steamer CPC/SCC Linie		
<b>For models:</b>	CM101, CM102, CM201, CM61, CPC101, CPC102, CPC201, CPC202, CPC61, SCC101, SCC102, SCC201, SCC202, SCC61, SCC62		



1

<b>GEV No.</b>	512496	<b>Ref. No.</b>	87.00.417
<b>description</b>	repair kit shaft sealing gaskets and grease for combi-steamer SCC, CM61-202 since 06/2007		



1

<b>GEV No.</b>	530795	<b>Ref. No.</b>	2110.1029
<b>description</b>	silicone hose ID ø 6mm ED ø 10mm L 1085mm for combi-steamer CPC-Linie CM 61-202/G white		
<b>For models:</b>	CPC101, CPC102, CPC201, CPC202, CPC61		



1

<b>GEV No.</b>	699811	<b>Ref. No.</b>	87.00.065
<b>description</b>	service kit for bulb socket RATIONAL		



1

<b>GEV No.</b>	530798	<b>Ref. No.</b>	2110.1030
<b>description</b>	silicone hose ID ø 6mm ED ø 10mm L 1120mm for combi-steamer CPC-Linie CM 61-202/G		
<b>For models:</b>	CPC101, CPC102, CPC201, CPC202, CPC61		



1

<b>GEV No.</b>	530882	<b>Ref. No.</b>	87.01.174
<b>description</b>	thread bolt retrofit kit RATIONAL for combi-steamer SCC_WE, CM_P 61-102 M6 A2-70		

## drip water trays



1

<b>GEV No.</b>	699800	<b>Ref. No.</b>	50.00.300
<b>description</b>	drip tray plastic L 745mm W 47mm H 20mm		
<b>For models:</b>	CM102, CM62, SCC102, SCC62		

## door mechanics

## miscellaneous



1

<b>GEV No.</b>	694934	<b>Ref. No.</b>	2940.1306
<b>description</b>	cover for door latch suitable for combi-steamer CPC-Linie 201/202 aluminium L 96.5mm W 65.5mm		
<b>For models:</b>	CD201, CD202, CM201, CM202, CPC201, CPC202		

## locking mechanism



1

<b>GEV No.</b>	530873	<b>Ref. No.</b>	24.01.350
<b>description</b>	catch for combi-steamer SCC-Linie 201/202 L 88.5mm W 64mm H 70mm ID ø 18mm		

## accessories



1

<b>GEV No.</b>	698608	<b>Ref. No.</b>	24.00.171
<b>description</b>	buffer silicone for door		
<b>For models:</b>	CM101, CM102, CM61, CM62, SCC101, SCC102, SCC201, SCC61, SCC62		



1

<b>GEV No.</b>	694656	<b>Ref. No.</b>	2039.0402
<b>description</b>	door bumper silicone ø 13mm L 19mm		
<b>For models:</b>	CD101, CD102, CD201, CD202, CD61, CM101, CM102, CM201, CM202, CM61, CPC101, CPC102, CPC201, CPC202, CPC61		

## vibration pumps



1

<b>GEV No.</b>	500580	<b>Ref. No.</b>	3002.1003 8720.1526
<b>description</b>	vibration pump 230V 60W 50/60Hz inlet ø 7 outlet ø 1/8" IT CEME type E512 with accessories duty cycle 1/2 ambient temperature max. 60°C medium temp max. 35°C overheating protection 110°C CleanJet		
<b>For models:</b>	CPC101, CPC102, CPC201, CPC202, CPC61		

## miscellaneous



1

<b>GEV No.</b>	520964	<b>Ref. No.</b>	2062.0333
<b>description</b>	adapter for non-return valve combi-steamer CPC, CM, CD, SCC thread 3/4" ET - 3/4" IT L 41.5mm bore ø 13mm D1 ø 31mm thickness 3mm		
<b>For models:</b>	CD101, CD102, CD201, CD202, CD61, CM101, CM102, CM201, CM202, CM61, CPC101, CPC102, CPC201, CPC202, CPC61		





1

<b>GEV No.</b>	694433	<b>Ref. No.</b>	2069.0108	
<b>description</b>	air valve for combi-steamer bore ø 2mm L 18mm plastic ø 20mm			
<b>For models:</b>	CD101, CD102, CD201, CD202, CD61, CM101, CM102, CM201, CM202, CM61, CM62, CPC101, CPC102, CPC201, CPC202, CPC61, SCC101, SCC102, SCC201, SCC202, SCC61, SCC62			
<b>accessories for</b>	694433			
	<b>GEV No.</b>	694402	<b>Ref. No.</b>	2062.0332 8354.1304
	valve body for air valve hose ø 10mm			







			
1			
<b>GEV No.</b>	693559	<b>Ref. No.</b>	2060.1600
<b>description</b>	bearing block for glass plate mounting pos. outer		
<b>For models:</b>	CCC101, CCC61, CCD101, CCD61, CCM101, CCM61		

			
1			
<b>GEV No.</b>	693532	<b>Ref. No.</b>	8354.1302
<b>description</b>	bracket for level electrode		
<b>For models:</b>	CM101, CM61, CPC101, CPC61		

			
1			
<b>GEV No.</b>	694945	<b>Ref. No.</b>	2118.1201
<b>description</b>	boot combi-steamer CPC C-Linie 61/101 ID ø 75mm W 131mm H 61mm rubber		
<b>For models:</b>	CCC101, CCC102, CCC61, CCD101, CCD102, CCD61, CCM101, CCM102, CCM61		

			
1			
<b>GEV No.</b>	693533	<b>Ref. No.</b>	2920.1300
<b>description</b>	bracket for level electrode		
<b>For models:</b>	CD101, CD102, CD201, CD202, CD61, CM101, CM102, CM201, CM202, CM61, CM62, CPC101, CPC102, CPC201, CPC202, CPC61, SCC101, SCC102, SCC201, SCC202, SCC61, SCC62		

			
1			
<b>GEV No.</b>	693523	<b>Ref. No.</b>	22.00.479
<b>description</b>	bracket		

			
1			
<b>GEV No.</b>	693550	<b>Ref. No.</b>	2016.0852
<b>description</b>	bush D1 ø 52mm D2 ø 25mm PTFE H 14.5mm		

			
1			
<b>GEV No.</b>	693522	<b>Ref. No.</b>	22.00.480
<b>description</b>	bracket for core temperature probe		

			
1			
<b>GEV No.</b>	693526	<b>Ref. No.</b>	2060.1210
<b>description</b>	bush for spray gun		
<b>For models:</b>	CD101, CD102, CD61, CM101, CM102, CM61, CPC101, CPC102, CPC61		

			
1			
<b>GEV No.</b>	693524	<b>Ref. No.</b>	22.00.453
<b>description</b>	bracket for core temperature probe L 80mm ø 16mm		



1

<b>GEV No.</b>	693595	<b>Ref. No.</b>	50.00.135 50.00.752
<b>description</b>	bush for spray gun		
<b>For models:</b>	CM201, CM202, SCC201, SCC202		

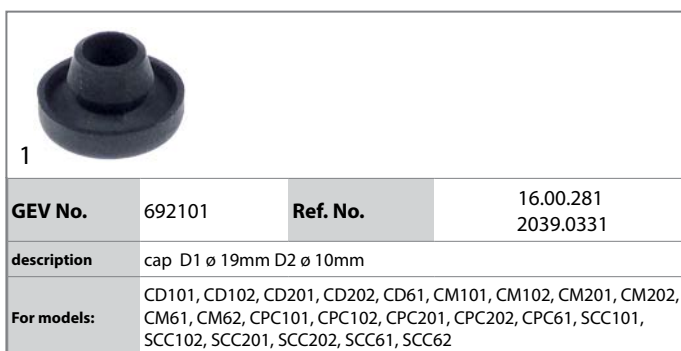

1

<b>GEV No.</b>	692101	<b>Ref. No.</b>	16.00.281 2039.0331
<b>description</b>	cap D1 ø 19mm D2 ø 10mm		
<b>For models:</b>	CD101, CD102, CD201, CD202, CD61, CM101, CM102, CM201, CM202, CM61, CM62, CPC101, CPC102, CPC201, CPC202, CPC61, SCC101, SCC102, SCC201, SCC202, SCC61, SCC62		



1

<b>GEV No.</b>	699809	<b>Ref. No.</b>	50.00.156
<b>description</b>	clamp for spray gun L 24mm		
<b>For models:</b>	CM101, CM102, CM201, CM202, CM61, CM62, SCC101, SCC102, SCC201, SCC202, SCC61, SCC62		

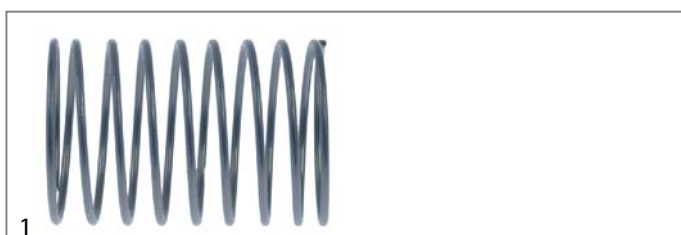

1

<b>GEV No.</b>	692295	<b>Ref. No.</b>	2001.0124
<b>description</b>	compression spring ø 48mm L 71mm wire gauge ø 2.2mm		
<b>For models:</b>	CM101, CM102, CM201, CM202, CPC101, CPC202, SCC101, SCC102, SCC201, SCC202		



1

<b>GEV No.</b>	510558	<b>Ref. No.</b>	2022.0110
<b>description</b>	connection for pump		
<b>For models:</b>	CC101, CC201, CC6, CD101, CD20, CD201, CM101, CM201		



1

<b>GEV No.</b>	510559	<b>Ref. No.</b>	2118.1000 5001.0208
<b>description</b>	connection for pump		
<b>For models:</b>	CCC101, CCC102, CCC201, CCC202, CCC61, CCD101, CCD102, CCD201, CCD202, CCD61, CCM101, CCM102, CCM201, CCM202, CCM61, CD101, CD102, CD201, CD202, CD61, CM101, CM102, CM201, CM202, CM61, CM62, CPC101, CPC102, CPC201, CPC202, CPC61, SCC101, SCC102, SCC201, SCC202, SCC61, SCC62		



1

<b>GEV No.</b>	694786	<b>Ref. No.</b>	22.00.213 22.00.214 87.00.325 87.00.469
<b>description</b>	conversion kit for ventilation for combi-steamer		
<b>For models:</b>	CM101, CM102, CM201, CM202, SCC101, SCC102, SCC201, SCC202		



1

<b>GEV No.</b>	696782	<b>Ref. No.</b>	87.00.630
<b>description</b>	conversion kit for ventilation for combi-steamer		



1

<b>GEV No.</b>	702000	<b>Ref. No.</b>	10.00.357
<b>description</b>	cover cap for tray rack trolley D1 ø 20mm H 13.5mm D2 ø 26mm plastic Qty 5 pcs SCC-Linie 201/202		
<b>For models:</b>	CM201, CM202, SCC201, SCC202		



1

<b>GEV No.</b>	694652	<b>Ref. No.</b>	2070.0050
<b>description</b>	drain pipe angled D1 ø 54mm D2 ø 40mm L 95mm plastic H 95mm		
<b>For models:</b>	CD101, CD102, CD201, CD202, CD61, CM101, CM102, CM201, CM202, CM61, CPC101, CPC102, CPC201, CPC202, CPC61		



1

<b>GEV No.</b>	694650	<b>Ref. No.</b>	50.01.191
<b>description</b>	drain pipe for combi-steamer L 555mm plastic		
<b>For models:</b>	SCC101, SCC61		



1

<b>GEV No.</b>	694391	<b>Ref. No.</b>	50.00.299 50.00.556 50.01.613
<b>description</b>	drain pipe with sleeve for drip pan L 560mm PE		
<b>For models:</b>	CM101, CM61, SCC101, SCC61		



1

<b>GEV No.</b>	524459	<b>Ref. No.</b>	50.00.286
<b>description</b>	drip rail L 540mm plastic W 63mm		
<b>For models:</b>	CM101, CM61, SCC101, SCC61		
<b>accessories for</b>	524459		
	<b>GEV No.</b>	697931	<b>Ref. No.</b>
			50.00.296 50.00.296P
	mounting clip plastic W 20mm Qty 5 pcs		



1

<b>GEV No.</b>	524454	<b>Ref. No.</b>	8474.1377 8474.1380
<b>description</b>	drip rail push-in for door L 549mm metal W 24mm H 25mm		
<b>For models:</b>	CD101, CD61, CM101, CM61, CPC101, CPC61		



1

<b>GEV No.</b>	694651	<b>Ref. No.</b>	2005.0301 2005.0308
<b>description</b>	filter for combi-steamer ø 97mm hole ø 6mm H 17.5mm		
<b>For models:</b>	CCC102, CCC202, CCD202, CCM102, CCM202, CD102, CD202, CM101, CM102, CM201, CM202, CM61, CM62, CPC102, CPC202, SCC101, SCC102, SCC201, SCC202, SCC61, SCC62		



1

<b>GEV No.</b>	520917	<b>Ref. No.</b>	74.00.296
<b>description</b>	gasket for heat exchanger D1 ø 104mm D2 ø 132mm		
<b>For models:</b>	CM101, CM102, CM201, CM202, CM61, CM62, SCC101, SCC102, SCC201, SCC202, SCC61, SCC62		

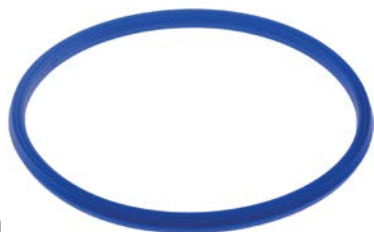

1

<b>GEV No.</b>	694320	<b>Ref. No.</b>	5012.0566
<b>description</b>	gasket for lid ø 145mm		
<b>For models:</b>	CD101, CD102, CD61, CM101, CM102, CM201, CM202, CM61, CM62, CPC101, CPC102, CPC61, SCC101, SCC102, SCC201, SCC202, SCC61, SCC62		



1

<b>GEV No.</b>	694527	<b>Ref. No.</b>	2070.0020
<b>description</b>	gasket rubber ED ø 57mm ID ø 39mm thickness 4mm for combi-steamer Qty 1 pcs suitable for RATIONAL		
<b>For models:</b>	CC101, CC201, CC6, CD101, CD20, CD201, CM101, CM201		



1

<b>GEV No.</b>	512184	<b>Ref. No.</b>	8664.1301
<b>description</b>	hose connector plastic thread 3/4" Qty 1 pcs connection distance 60mm T-shape		
<b>For models:</b>	CD101, CD102, CD201, CD202, CD61, CM101, CM102, CM201, CM202, CM61, CM62, CPC101, CPC102, CPC201, CPC202, CPC61, SCC101, SCC102, SCC201, SCC202, SCC61, SCC62		



1

<b>GEV No.</b>	694936	<b>Ref. No.</b>	5003.0300 5003.0300ET 5212.1200
<b>description</b>	insulating mat for combi-steamer CPC-Linie L 1078mm W 635mm H 11mm foam Qty 2 pcs		
<b>For models:</b>	CC101, CC6, CCC101, CCC102, CCC61, CCD101, CCD102, CCD61, CCM101, CCM102, CCM61, CD101, CD102, CD201, CD202, CD61, CM101, CM102, CM201, CM202, CM61, CPC101, CPC102, CPC201, CPC202, CPC61, SCC101, SCC61		



1

<b>GEV No.</b>	551348	<b>Ref. No.</b>	20.01.755P
<b>description</b>	insulation SCC_WE, CM_P 61-202 L 248mm bore ø 30mm W 193mm H 15mm		



1

<b>GEV No.</b>	697931	<b>Ref. No.</b>	50.00.296 50.00.296P
<b>description</b>	mounting clip plastic W 20mm Qty 5 pcs		
<b>For models:</b>	CM101, CM102, CM61, CM62, SCC101, SCC102, SCC61, SCC62		



1

<b>GEV No.</b>	694653	<b>Ref. No.</b>	60.60.566
<b>description</b>	outflow plug with chain for combi-steamer plastic ø 39mm H 22mm		



1

<b>GEV No.</b>	694556	<b>Ref. No.</b>	50.00.230
<b>description</b>	pipe for hose reel L 700mm WS 24 plastic thread M20x1.75 ø 12mm		
<b>For models:</b>	CM201, CM202, SCC201, SCC202		



1

<b>GEV No.</b>	693525	<b>Ref. No.</b>	60.60.859
<b>description</b>	pipe L 102mm ceramic ø 11.4mm		



1

<b>GEV No.</b>	694654	<b>Ref. No.</b>	2120.1259
<b>description</b>	plug for draining L 40mm plastic ø 10mm		
<b>For models:</b>	CD101, CD102, CD201, CD202, CD61, CM101, CM102, CM201, CM202, CM61, CM62, CPC101, CPC102, CPC201, CPC202, CPC61, SCC101, SCC102, SCC201, SCC202, SCC61, SCC62		



			
1			
<b>GEV No.</b>	512497	<b>Ref. No.</b>	2039.0350
<b>description</b>	protection cap for pulser suitable for combi-steamer CPC-Linie CPC/CM 61-202 D1 ø 13.5mm H 8.5mm D2 ø 6mm silicone		
<b>For models:</b>	CPC101, CPC102, CPC201, CPC202, CPC61		

			
1			
<b>GEV No.</b>	693549	<b>Ref. No.</b>	2016.0853
<b>description</b>	retaining ring bush		
<b>For models:</b>	CD20		

			
1			
<b>GEV No.</b>	696393	<b>Ref. No.</b>	8514.1346
<b>description</b>	rotary nozzle for combi-steamer L 125mm stainless steel		
<b>For models:</b>	CPC101, CPC102, CPC201, CPC202, CPC61		

			
1			
<b>GEV No.</b>	699808	<b>Ref. No.</b>	22.00.564
<b>description</b>	rubber sleeve for ventilation L 50mm ID ø 50mm ED ø 61mm		
<b>For models:</b>	CM101, CM102, CM201, CM202, CM61, CM62, SCC101, SCC102, SCC201, SCC202, SCC61, SCC62		

			
1			
<b>GEV No.</b>	692750	<b>Ref. No.</b>	5110.1027
<b>description</b>	shim for control panel bore ø 6mm D1 ø 17mm plastic for combi-steamer C-Linie/CPC-Linie CD/CM/61-202		
<b>For models:</b>	CCD101, CCD102, CCD201, CCD202, CCD61, CCM101, CCM102, CCM201, CCM202, CCM61, CD101, CD102, CD201, CD202, CD61, CM101, CM102, CM201, CM202, CM61, CM62, CPC201		

			
1			
<b>GEV No.</b>	694322	<b>Ref. No.</b>	50.00.303
<b>description</b>	sleeve for drip pan D1 ø 15mm D2 ø 20mm L 62mm		
<b>For models:</b>	CM101, CM102, CM61, CM62, SCC101, SCC102, SCC61, SCC62		

			
1			
<b>GEV No.</b>	530797	<b>Ref. No.</b>	22.00.354
<b>description</b>	spacer for ventilation combi-steamer SCC, CM61-202 since 06/2007 D1 ø 61mm H 26mm D2 ø 58mm thickness 1.5mm		
<b>For models:</b>	CM101, CM102, CM201, CM202, CM61, CM62, SCC101, SCC102, SCC201, SCC202, SCC61, SCC62		

			
1			
<b>GEV No.</b>	692166	<b>Ref. No.</b>	2760.1540
<b>description</b>	support bracket for door drip tray bore ø 6x8mm L 65mm W 30mm		
<b>For models:</b>	CD101, CD102, CD61, CM101, CM102, CM61, CPC101, CPC102, CPC61		

			
1			
<b>GEV No.</b>	694658	<b>Ref. No.</b>	8720.1572
<b>description</b>	thread bolt angled L 42mm SS thread M6 ø 6mm		





			
1			
<b>GEV No.</b>	694657	<b>Ref. No.</b>	8720.1571
<b>description</b>	thread bolt straight L 44mm SS thread M6 ø 6mm		

			
1			
<b>GEV No.</b>	694940	<b>Ref. No.</b>	2120.1308
<b>description</b>	union nut for door drip tray for combi-steamer CPC-Linie CPC 61/101/201 L 8mm WS 5 thread M3 Qty 2 pcs		
<b>For models:</b>	CD101, CD102, CD61, CM101, CM102, CM61, CPC101, CPC102, CPC61		

			
1			
<b>GEV No.</b>	694402	<b>Ref. No.</b>	2062.0332 8354.1304
<b>description</b>	valve body for air valve hose ø 10mm		
<b>For models:</b>	CD101, CD102, CD201, CD202, CD61, CM101, CM102, CM201, CM202, CM61, CM62, CPC101, CPC102, CPC201, CPC202, CPC61, SCC101, SCC102, SCC201, SCC202, SCC61, SCC62		
<b>accessories for</b>	694402		
	<b>GEV No.</b>	694433	<b>Ref. No.</b> 2069.0108
	air valve for combi-steamer bore ø 2mm L 18mm plastic ø 20mm		

			
1			
<b>GEV No.</b>	692749	<b>Ref. No.</b>	22.00.568
<b>description</b>	ventilation valve for combi-steamer SCC Linie 61/62 L 137mm bore ø 47mm W 122mm		
<b>For models:</b>	SCC61, SCC62		

			
1			
<b>GEV No.</b>	692747	<b>Ref. No.</b>	22.00.725
<b>description</b>	ventilation valve for combi-steamer SCC_WE, CM_P 61-202 L 134.5mm W 89mm H 108.5mm		

			
1			
<b>GEV No.</b>	530799	<b>Ref. No.</b>	50.00.073
<b>description</b>	water distributor for combi-steamer SCC, CM L 83mm bore ø 13mm thread 3/4"		
<b>For models:</b>	CM201, CM202, SCC201, SCC202		

## for boiling pans

## miscellaneous

			
1			
<b>GEV No.</b>	692215	<b>Ref. No.</b>	2039.0360 2039.0362 2039.0376 8720.1525
<b>description</b>	conversion kit for tank inlet fitting		
<b>For models:</b>	CPC101, CPC102, CPC61		



for dishwashers

screw connections



1			
<b>GEV No.</b>	501387	<b>Ref. No.</b>	95.17.398
<b>description</b>	nut thread 3/4" H 13mm WS 30 Qty 1 pcs		

knobs

universal knobs



1			
<b>GEV No.</b>	110253	<b>Ref. No.</b>	3013.0113
<b>description</b>	knob switch zero mark t.max.°C ø 50mm shaft ø 6x4.6mm shaft flat upper black		
<b>For models:</b>	CD101, CD20, CD201		



1			
<b>GEV No.</b>	110244	<b>Ref. No.</b>	3013.0301
<b>description</b>	knob thermostat t.max. 250°C ø 50mm shaft ø 6x4.6mm shaft flat upper/lower black temperature range 30-250°C rotation 270°		
<b>For models:</b>	CD101, CD20, CD201		



1			
<b>GEV No.</b>	110245	<b>Ref. No.</b>	3013.0201
<b>description</b>	knob thermostat t.max. 300°C ø 50mm shaft ø 6x4.6mm shaft flat upper black temperature range 50-300°C		
<b>For models:</b>	CD101, CD20, CD201		



1			
<b>GEV No.</b>	110254	<b>Ref. No.</b>	3013.0114
<b>description</b>	knob thermostat t.max. 80°C ø 50mm shaft ø 6x4.6mm shaft flat upper black temperature range 50-80°C		
<b>For models:</b>	CD101, CD20, CD201		



1			
<b>GEV No.</b>	110251	<b>Ref. No.</b>	3013.0105
<b>description</b>	knob time 120min + permanent ON t.max.°C ø 50mm shaft ø 6x4.6mm shaft flat upper black		
<b>For models:</b>	CD101, CD20, CD201		



1			
<b>GEV No.</b>	110252	<b>Ref. No.</b>	3013.0108
<b>description</b>	knob time 120min + permanent ON t.max.°C ø 50mm shaft ø 6x4.6mm shaft flat upper black		
<b>For models:</b>	CD101, CD20, CD201		

producer-specific knobs

RATIONAL



1			
<b>GEV No.</b>	110253	<b>Ref. No.</b>	3013.0113
<b>description</b>	knob switch zero mark t.max.°C ø 50mm shaft ø 6x4.6mm shaft flat upper black		
<b>For models:</b>	CD101, CD20, CD201		



1			
<b>GEV No.</b>	110244	<b>Ref. No.</b>	3013.0301
<b>description</b>	knob thermostat t.max. 250°C ø 50mm shaft ø 6x4.6mm shaft flat upper/lower black temperature range 30-250°C rotation 270°		
<b>For models:</b>	CD101, CD20, CD201		



1

<b>GEV No.</b>	110245	<b>Ref. No.</b>	3013.0201
<b>description</b>	knob thermostat t.max. 300°C ø 50mm shaft ø 6x4.6mm shaft flat upper black temperature range 50-300°C		
<b>For models:</b>	CD101, CD20, CD201		



1

<b>GEV No.</b>	110254	<b>Ref. No.</b>	3013.0114
<b>description</b>	knob thermostat t.max. 80°C ø 50mm shaft ø 6x4.6mm shaft flat upper black temperature range 50-80°C		
<b>For models:</b>	CD101, CD20, CD201		



1

<b>GEV No.</b>	110251	<b>Ref. No.</b>	3013.0105
<b>description</b>	knob time 120min + permanent ON t.max.°C ø 50mm shaft ø 6x4.6mm shaft flat upper black		
<b>For models:</b>	CD101, CD20, CD201		



1

<b>GEV No.</b>	110252	<b>Ref. No.</b>	3013.0108
<b>description</b>	knob time 120min + permanent ON t.max.°C ø 50mm shaft ø 6x4.6mm shaft flat upper black		
<b>For models:</b>	CD101, CD20, CD201		



1

<b>GEV No.</b>	112811	<b>Ref. No.</b>	16.00.231
<b>description</b>	knob for pulser ø 68.5mm shaft ø 5mm black		



1

<b>GEV No.</b>	111957	<b>Ref. No.</b>	3013.0355
<b>description</b>	knob ø 60mm shaft ø 6x4.6mm shaft flat universal		
<b>For models:</b>	CPC101, CPC102, CPC201, CPC202, CPC61		



1

<b>GEV No.</b>	111963	<b>Ref. No.</b>	16.00.232
<b>description</b>	knob ø 69mm shaft ø 5mm		
<b>For models:</b>	SCC101, SCC102, SCC201, SCC202, SCC61, SCC62		



1

<b>GEV No.</b>	111649	<b>Ref. No.</b>	16.02.062
<b>description</b>	knob ø 69mm shaft ø 5mm silver		



1

<b>GEV No.</b>	110262	<b>Ref. No.</b>	3013.0330 3013.0331
<b>description</b>	knob switch zero mark ø 42mm shaft ø 6x4.6mm shaft flat upper blue		
<b>For models:</b>	CCD101, CCD201, CCD202, CCD61, CCM101, CCM201, CCM202, CCM61, CM101, CM201, CM62		





1

<b>GEV No.</b>	111958	<b>Ref. No.</b>	16.00.282
<b>description</b>	knob switch zero mark ø 50mm shaft ø 6x4.6mm shaft flat upper black		
<b>For models:</b>	CM101, CM102, CM201, CM202, CM61, CM62		



 <p>1</p>			
<b>GEV No.</b>	110259	<b>Ref. No.</b>	3013.0344 3013.0346
<b>description</b>	knob switch zero mark ø 52mm shaft ø 6x4.6mm shaft flat upper blue		
<b>For models:</b>	CCD101, CCD102, CCD201, CCD202, CCD61, CCM101, CCM102, CCM201, CCM202, CCM61, CD101, CD102, CD201, CD202, CD61, CM101, CM102, CM201, CM202, CM61, CPC201		

 <p>1</p>			
<b>GEV No.</b>	110144	<b>Ref. No.</b>	3013.0325 3013.0329
<b>description</b>	knob zero mark ø 40mm shaft ø 6mm 3-piece		
<b>For models:</b>	CM101, CM201		



 <p>1</p>			
<b>GEV No.</b>	111812	<b>Ref. No.</b>	3013.0345
<b>description</b>	knob zero mark ø 52mm shaft ø 6x4.6mm shaft flat upper grey/black		

## locks

### turning lever locks



#### universal

#### RAHRBACH

 <p>1</p>			
<b>GEV No.</b>	700098	<b>Ref. No.</b>	2016.0603
<b>description</b>	door catch mounting pos. right off-set 38mm L 110mm H 74mm W 33mm mounting distance 68/68mm series 1750		
<b>For models:</b>	CC201, CD20, CD201, CM201		
<b>spare parts for</b>	700098		
		<b>GEV No.</b>	690136
		<b>Ref. No.</b>	2016.0605
<b>description</b>	sliding plate mounting pos. right L 28mm H 3mm W 21mm H2 12.5mm		
<b>accessories for</b>	700098		
		<b>GEV No.</b>	514281
		<b>Ref. No.</b>	—
<b>description</b>	base plate L 110mm W 35mm for door catch thickness 10mm		

 <p>1</p>			
<b>GEV No.</b>	690136	<b>Ref. No.</b>	2016.0605
<b>description</b>	sliding plate mounting pos. right L 28mm H 3mm W 21mm H2 12.5mm		
<b>For models:</b>	CC201, CD20, CD201, CM201		

#### STUV

 <p>1</p>			
<b>GEV No.</b>	700098	<b>Ref. No.</b>	2016.0603
<b>description</b>	door catch mounting pos. right off-set 38mm L 110mm H 74mm W 33mm mounting distance 68/68mm series 1750		
<b>For models:</b>	CC201, CD20, CD201, CM201		
<b>spare parts for</b>	700098		
		<b>GEV No.</b>	690136
		<b>Ref. No.</b>	2016.0605
<b>description</b>	sliding plate mounting pos. right L 28mm H 3mm W 21mm H2 12.5mm		
<b>accessories for</b>	700098		
		<b>GEV No.</b>	514281
		<b>Ref. No.</b>	—
<b>description</b>	base plate L 110mm W 35mm for door catch thickness 10mm		



#### producer-specific

#### RATIONAL

 <p>1</p>			
<b>GEV No.</b>	693519	<b>Ref. No.</b>	2016.1412 2016.1430 2016.1450
<b>description</b>	door handle L 230mm W 55mm H 62mm flange 56mm		
<b>For models:</b>	CC201, CD20, CD201, CM201		

 <p>1</p>			
<b>GEV No.</b>	690102	<b>Ref. No.</b>	2016.1457
<b>description</b>	bearing block L 110mm H 63mm W 35mm mounting distance 1 30mm mounting distance 2 90mm hole ø 20mm type 1750		
<b>For models:</b>	CC201, CD20, CD201, CM201		

 <p>1</p>			
<b>GEV No.</b>	700072	<b>Ref. No.</b>	2016.1300
<b>description</b>	door catch H 17mm L 84mm W 53mm mounting distance 68mm zinc die cast with wedge heated units		
<b>For models:</b>	CC201, CD20, CD201, CM201		

			
1			
<b>GEV No.</b>	700098	<b>Ref. No.</b>	2016.0603
<b>description</b>	door catch mounting pos. right off-set 38mm L 110mm H 74mm W 33mm mounting distance 68/68mm series 1750		
<b>For models:</b>	CC201, CD20, CD201, CM201		
<b>spare parts for</b>	700098		
	<b>GEV No.</b>	690136	<b>Ref. No.</b> 2016.0605
<b>description</b>	sliding plate mounting pos. right L 28mm H 3mm W 21mm H2 12.5mm		
<b>accessories for</b>	700098		
	<b>GEV No.</b>	514281	<b>Ref. No.</b> —
<b>description</b>	base plate L 110mm W 35mm for door catch thickness 10mm		

			
1			
<b>GEV No.</b>	693592	<b>Ref. No.</b>	2016.1453
<b>description</b>	plain washer for door latch plastic ø 56mm ID ø 40mm H 2.3mm		
<b>For models:</b>	CC201, CD20, CD201, CM201		

			
1			
<b>GEV No.</b>	690103	<b>Ref. No.</b>	2016.1452
<b>description</b>	screw cap H 47mm ø 40mm hole ø 10mm type 1750		
<b>For models:</b>	CC201, CD20, CD201, CM201		

			
1			
<b>GEV No.</b>	690136	<b>Ref. No.</b>	2016.0605
<b>description</b>	sliding plate mounting pos. right L 28mm H 3mm W 21mm H2 12.5mm		
<b>For models:</b>	CC201, CD20, CD201, CM201		

			
1			
<b>GEV No.</b>	690101	<b>Ref. No.</b>	2016.0604
<b>description</b>	snap lock L 85mm W 40mm mounting distance 68mm heated units H 63mm type 1750 series		
<b>For models:</b>	CC201, CD20, CD201, CM201		

handle latches

producer-specific

<b>RATIONAL</b>			
			
1			
<b>GEV No.</b>	693563	<b>Ref. No.</b>	8514.1038
<b>description</b>	door catch		
<b>For models:</b>	CCC102, CCC201, CCC202, CCD102, CCD201, CCD202, CCM102, CCM201, CCM202		

			
1			
<b>GEV No.</b>	693562	<b>Ref. No.</b>	2940.1004 8720.1474
<b>description</b>	door catch conversion kit		
<b>For models:</b>	CCC102, CCC201, CCC202, CCD102, CCD201, CCD202, CCM102, CCM201, CCM202		

			
1			
<b>GEV No.</b>	694935	<b>Ref. No.</b>	24.01.351
<b>description</b>	door catch for door handle H 29mm L 98.5mm W 70mm mounting distance 50mm for combi-steamer SCC-Linie 201/202		

			
1			
<b>GEV No.</b>	693520	<b>Ref. No.</b>	8474.1019 8474.1305 8474.1410
<b>description</b>	door catch L 55.5mm W 60mm H 45mm mounting distance 50mm		
<b>For models:</b>	CCC102, CCC201, CCC202, CCD102, CCD201, CCD202, CCM102, CCM201, CCM202, CD201, CD202, CM201, CM202, CPC201, CPC202, SCC201, SCC202		





 <p>1</p>			
<b>GEV No.</b>	693560	<b>Ref. No.</b>	2016.1501 2016.1507 2016.1509
<b>description</b>	door handle L 205mm W 58mm H 55mm black plastic shaft 20mm shaft ø 18mm		
<b>For models:</b>	CCC102, CCC201, CCC202, CCD102, CCD201, CCD202, CCM102, CCM201, CCM202, CD201, CD202, CM201, CM202, CPC201, CPC202		

 <p>1</p>			
<b>GEV No.</b>	693561	<b>Ref. No.</b>	5110.1015
<b>description</b>	gasket for door latch ø 28mm ID ø 20mm H 4mm		
<b>For models:</b>	CCC102, CCC201, CCC202, CCD102, CCD201, CCD202, CCM102, CCM201, CCM202		

 <p>1</p>			
<b>GEV No.</b>	694511	<b>Ref. No.</b>	1005.1901
<b>description</b>	pin for catch ø 5.6mm L 16mm		
<b>For models:</b>	CD201, CD202, CM201, CM202, CPC201, CPC202, SCC201, SCC202		

 <p>1</p>			
<b>GEV No.</b>	693573	<b>Ref. No.</b>	2940.1305
<b>description</b>	bolt piece for door L 58mm H 20mm ø 36mm hole ø 8mm		
<b>For models:</b>	CD201, CD202, CM201, CM202, CPC201, CPC202, SCC201, SCC202		

 <p>1</p>			
<b>GEV No.</b>	693574	<b>Ref. No.</b>	8455.1300
<b>description</b>	cover for closing jaw		
<b>For models:</b>	CD201, CD202, CM201, CM202, CPC201, CPC202		

 <p>1</p>			
<b>GEV No.</b>	694934	<b>Ref. No.</b>	2940.1306
<b>description</b>	cover for door latch suitable for combi-steamer CPC-Linie 201/202 aluminium L 96.5mm W 65.5mm		
<b>For models:</b>	CD201, CD202, CM201, CM202, CPC201, CPC202		

 <p>1</p>			
<b>GEV No.</b>	693538	<b>Ref. No.</b>	1006.1000 8514.1307
<b>description</b>	door catch H 70mm L 100mm W 30mm mounting distance 50mm		
<b>For models:</b>	CD201, CD202, CM201, CM202, CPC201, CPC202, SCC201, SCC202		

 <p>1</p>			
<b>GEV No.</b>	693520	<b>Ref. No.</b>	8474.1019 8474.1305 8474.1410
<b>description</b>	door catch L 55.5mm W 60mm H 45mm mounting distance 50mm		
<b>For models:</b>	CCC102, CCC201, CCC202, CCD102, CCD201, CCD202, CCM102, CCM201, CCM202, CD201, CD202, CM201, CM202, CPC201, CPC202, SCC201, SCC202		

 <p>1</p>			
<b>GEV No.</b>	693560	<b>Ref. No.</b>	2016.1501 2016.1507 2016.1509
<b>description</b>	door handle L 205mm W 58mm H 55mm black plastic shaft 20mm shaft ø 18mm		
<b>For models:</b>	CCC102, CCC201, CCC202, CCD102, CCD201, CCD202, CCM102, CCM201, CCM202, CD201, CD202, CM201, CM202, CPC201, CPC202		

 <p>1</p>			
<b>GEV No.</b>	694511	<b>Ref. No.</b>	1005.1901
<b>description</b>	pin for catch ø 5.6mm L 16mm		
<b>For models:</b>	CD201, CD202, CM201, CM202, CPC201, CPC202, SCC201, SCC202		



1

<b>GEV No.</b>	693573	<b>Ref. No.</b>	2940.1305
<b>description</b>	bolt piece for door L 58mm H 20mm ø 36mm hole ø 8mm		
<b>For models:</b>	CD201, CD202, CM201, CM202, CPC201, CPC202, SCC201, SCC202		



1

<b>GEV No.</b>	693582	<b>Ref. No.</b>	24.00.216
<b>description</b>	cover for door latch L 97mm W 10.5mm mounting distance 71mm H 65mm		
<b>For models:</b>	CM201, CM202, SCC201, SCC202		



1

<b>GEV No.</b>	693538	<b>Ref. No.</b>	1006.1000 8514.1307
<b>description</b>	door catch H 70mm L 100mm W 30mm mounting distance 50mm		
<b>For models:</b>	CD201, CD202, CM201, CM202, CPC201, CPC202, SCC201, SCC202		



1

<b>GEV No.</b>	693520	<b>Ref. No.</b>	8474.1019 8474.1305 8474.1410
<b>description</b>	door catch L 55.5mm W 60mm H 45mm mounting distance 50mm		
<b>For models:</b>	CCC102, CCC201, CCC202, CCD102, CCD201, CCD202, CCM102, CCM201, CCM202, CD201, CD202, CM201, CM202, CPC201, CPC202, SCC201, SCC202		



1

<b>GEV No.</b>	693581	<b>Ref. No.</b>	24.00.136
<b>description</b>	door handle plastic		
<b>For models:</b>	CM201, CM202, SCC201, SCC202		



1

<b>GEV No.</b>	694511	<b>Ref. No.</b>	1005.1901
<b>description</b>	pin for catch ø 5.6mm L 16mm		
<b>For models:</b>	CD201, CD202, CM201, CM202, CPC201, CPC202, SCC201, SCC202		





1

<b>GEV No.</b>	693578	<b>Ref. No.</b>	24.00.141
<b>description</b>	bracket for door catch L 66mm W 23.5mm H 19mm mounting distance 46mm		
<b>For models:</b>	CM101, CM102, CM61, CM62, SCC101, SCC102, SCC61, SCC62		
<b>accessories for</b>	693578		
	<b>GEV No.</b>	693579	<b>Ref. No.</b> 24.00.142
	door catch H 10.5mm L 42mm W 13mm M5		



1

<b>GEV No.</b>	693576	<b>Ref. No.</b>	24.00.176 24.02.762
<b>description</b>	catch L 83mm ø 41mm clamp length 43mm BL 45mm		
<b>For models:</b>	CM101, CM102, CM61, CM62, SCC101, SCC102, SCC61, SCC62		
<b>spare parts for</b>	693576		
	<b>GEV No.</b>	693577	<b>Ref. No.</b> —
	D-lock W 29mm H 17mm spring length 50mm spring thickness 3mm		



1

<b>GEV No.</b>	693580	<b>Ref. No.</b>	24.00.504
<b>description</b>	cover for catch		
<b>For models:</b>	CM101, CM102, CM61, CM62, SCC101, SCC102, SCC61, SCC62		



1

<b>GEV No.</b>	694909	<b>Ref. No.</b>	24.00.506 24.01.100 24.02.761
<b>description</b>	D-lock W 29mm H 17mm spring length 50mm spring thickness 3mm		
<b>For models:</b>	CM101, CM102, CM61, CM62, SCC101, SCC102, SCC61, SCC62		





			
1			
<b>GEV No.</b>	693579	<b>Ref. No.</b>	24.00.142
<b>description</b>	door catch H 10.5mm L 42mm W 13mm M5		
<b>For models:</b>	CM101, CM102, CM61, CM62, SCC101, SCC102, SCC61, SCC62		

			
1			
<b>GEV No.</b>	693564	<b>Ref. No.</b>	2039.0340
<b>description</b>	cover door catch L1 91mm L2 58mm W 34mm H 38mm		
<b>For models:</b>	CD101, CD102, CD61, CM101, CM102, CM61, CPC101, CPC102, CPC61		

			
1			
<b>GEV No.</b>	693575	<b>Ref. No.</b>	24.00.152
<b>description</b>	door handle L 200mm W 50mm H 66mm blue plastic		
<b>For models:</b>	CM101, CM102, CM61, CM62, SCC101, SCC102, SCC61, SCC62		
<b>accessories for</b>	693575		
	<b>GEV No.</b>	693576	<b>Ref. No.</b>
			24.00.176 24.02.762
	catch L 83mm ø 41mm clamp length 43mm BL 45mm		

			
1			
<b>GEV No.</b>	693566	<b>Ref. No.</b>	2940.1312 2940.1314
<b>description</b>	door catch H 8mm L 47mm W1 26mm W2 24mm		
<b>For models:</b>	CD101, CD102, CD61, CM101, CM102, CM61, CPC101, CPC102, CPC61		

			
1			
<b>GEV No.</b>	693596	<b>Ref. No.</b>	2016.1500 2016.1504 2016.1505 2016.1506
<b>description</b>	door handle L 205mm W 33mm grey plastic ø 57mm spigot hight 39mm spigot-ø 12mm		
<b>For models:</b>	CCC101, CCC61, CCD101, CCD61, CCM101, CCM61, CD101, CD102, CD61, CM101, CM102, CM61, CPC101, CPC102, CPC61		

			
1			
<b>GEV No.</b>	693565	<b>Ref. No.</b>	2940.1313
<b>description</b>	bracket for door catch L 64mm W 25mm H 28mm hole ø 6mm mounting distance 46mm		
<b>For models:</b>	CD101, CD102, CD61, CM101, CM102, CM61, CPC101, CPC102, CPC61		
<b>accessories for</b>	693565		
	<b>GEV No.</b>	693566	<b>Ref. No.</b>
			2940.1312 2940.1314
	door catch H 8mm L 47mm W1 26mm W2 24mm		

			
1			
<b>GEV No.</b>	693550	<b>Ref. No.</b>	2016.0852
<b>description</b>	bush D1 ø 52mm D2 ø 25mm PTFE H 14.5mm		

			
1			
<b>GEV No.</b>	693536	<b>Ref. No.</b>	8474.1300
<b>description</b>	catch complete H 34mm L 155mm W 57mm		
<b>For models:</b>	CD101, CD102, CD61, CM101, CM102, CM61, CPC101, CPC102, CPC61		

			
1			
<b>GEV No.</b>	693557	<b>Ref. No.</b>	2043.0102
<b>description</b>	cam for door mounting pos. lower L 58mm W1 18mm W2 8mm		
<b>For models:</b>	CCC101, CCC61, CCD101, CCD61, CCM101, CCM61		

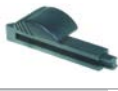
			
1			
<b>GEV No.</b>	693543	<b>Ref. No.</b>	2043.0101
<b>description</b>	cam for door mounting pos. upper L 58mm W1 18mm W2 8mm		
<b>For models:</b>	CCC101, CCC61, CCD101, CCD61, CCM101, CCM61		

			
1			
<b>GEV No.</b>	693537	<b>Ref. No.</b>	8474.1001
<b>description</b>	catch H 34mm L 141mm W 56mm		
<b>For models:</b>	CCC101, CCC61, CCD101, CCD61, CCM101, CCM61		

			
1			
<b>GEV No.</b>	693542	<b>Ref. No.</b>	2039.0319
<b>description</b>	cover for door lock H 35.5mm L 70mm W 34mm mounting measurements 49x29mm		
<b>For models:</b>	CCC101, CCC61, CCD101, CCD61, CCM101, CCM61		

			
1			
<b>GEV No.</b>	693596	<b>Ref. No.</b>	2016.1500 2016.1504 2016.1505 2016.1506
<b>description</b>	door handle L 205mm W 33mm grey plastic ø 57mm spigot height 39mm spigot-ø 12mm		
<b>For models:</b>	CCC101, CCC61, CCD101, CCD61, CCM101, CCM61, CD101, CD102, CD61, CM101, CM102, CM61, CPC101, CPC102, CPC61		

			
1			
<b>GEV No.</b>	693556	<b>Ref. No.</b>	2760.1050
<b>description</b>	lid for door latch L 58mm W 38mm cut-out 18x6mm thickness 2mm mounting pos. lower		
<b>For models:</b>	CCC101, CCC61, CCD101, CCD61, CCM101, CCM61		

			
1			
<b>GEV No.</b>	693594	<b>Ref. No.</b>	2760.1049
<b>description</b>	lid for door latch mounting pos. upper		
<b>For models:</b>	CCC101, CCC61, CCD101, CCD61, CCM101, CCM61		

			
1			
<b>GEV No.</b>	693518	<b>Ref. No.</b>	2016.1517
<b>description</b>	door handle black plastic		



edgemoat latches

handle latches

STUV

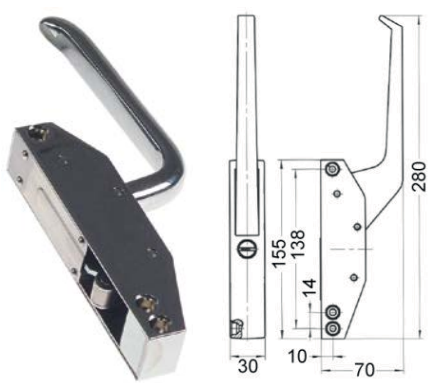
3.30.016x.x series

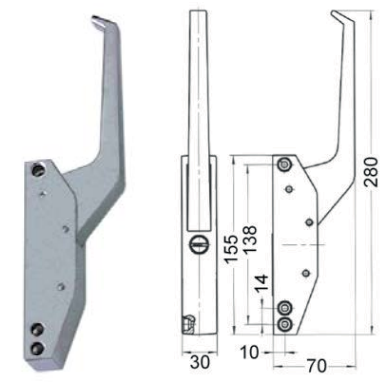
			
1			
<b>GEV No.</b>	693517	<b>Ref. No.</b>	2016.1110
<b>description</b>	catch		

				
1				
<b>GEV No.</b>	700063	<b>Ref. No.</b>	2016.1100 2016.1104	
<b>description</b>	handle latch L 155mm mounting distance 124/138mm non lockable refrigeration units 3.30.0164			
<b>For models:</b>	CC101, CC6, CD101, CM101, CM62			
<b>accessories for</b>	700063			
	<b>GEV No.</b>	700064	<b>Ref. No.</b>	2016.0602 2016.0606 2016.0610 2016.0611 2016.0615
door catch H 40mm L 28mm W 22mm				



## door catches



1			
<b>GEV No.</b>	700064	<b>Ref. No.</b>	2016.0602 2016.0606 2016.0610 2016.0611 2016.0615
<b>description</b>	door catch H 40mm L 28mm W 22mm		
<b>For models:</b>	CC101, CC6, CCC101, CCC61, CCD101, CCD61, CCM101, CCM61, CD101, CM101, CM62		

## walk-in fridge catches

### STUV

#### 3.31.015x.x series



1			
<b>GEV No.</b>	700072	<b>Ref. No.</b>	2016.1300
<b>description</b>	door catch H 17mm L 84mm W 53mm mounting distance 68mm zinc die cast with wedge heated units		
<b>For models:</b>	CC201, CD20, CD201, CM201		

## snap locks

### producer-specific

#### RATIONAL



1			
<b>GEV No.</b>	700072	<b>Ref. No.</b>	2016.1300
<b>description</b>	door catch H 17mm L 84mm W 53mm mounting distance 68mm zinc die cast with wedge heated units		
<b>For models:</b>	CC201, CD20, CD201, CM201		



1			
<b>GEV No.</b>	690101	<b>Ref. No.</b>	2016.0604
<b>description</b>	snap lock L 85mm W 40mm mounting distance 68mm heated units H 63mm type 1750 series		
<b>For models:</b>	CC201, CD20, CD201, CM201		

## miscellaneous



1			
<b>GEV No.</b>	694655	<b>Ref. No.</b>	1901.0041
<b>description</b>	spring clip for door latch L 26mm W 13mm H 10.5mm hole ø 8mm Qty 2 pcs		
<b>For models:</b>	CD101, CD102, CD61, CM101, CM102, CM61, CPC101, CPC102, CPC61		

## hinges

### door bearing



1			
<b>GEV No.</b>	693540	<b>Ref. No.</b>	2016.0802
<b>description</b>	bolt L 20mm mounting pos. upper/lower ø 15mm		
<b>For models:</b>	CC201, CD20, CD201, CM201		



1			
<b>GEV No.</b>	693569	<b>Ref. No.</b>	2120.1254
<b>description</b>	bolt mounting pos. upper		
<b>For models:</b>	CD101, CD102, CD201, CD202, CD61, CM101, CM102, CM201, CM202, CM61, CPC101, CPC102, CPC201, CPC202, CPC61		



1			
<b>GEV No.</b>	693558	<b>Ref. No.</b>	2120.1009
<b>description</b>	bolt mounting pos. upper for hinge		
<b>For models:</b>	CCC101, CCC61, CCD101, CCD61, CCM101, CCM61		



1			
<b>GEV No.</b>	693539	<b>Ref. No.</b>	2016.0801
<b>description</b>	bolt mounting pos. upper right		
<b>For models:</b>	CC101, CC6, CD101, CM101, CM62		





1

<b>GEV No.</b>	693584	<b>Ref. No.</b>	24.00.048
<b>description</b>	bolt mounting pos. upper right for door		
<b>For models:</b>	CM101, CM102, CM201, CM202, CM61, CM62, SCC101, SCC102, SCC201, SCC202, SCC61, SCC62		



1

<b>GEV No.</b>	693590	<b>Ref. No.</b>	24.00.159
<b>description</b>	bush mounting pos. bottom right latching		
<b>For models:</b>	CM201, CM202, SCC201, SCC202		



1

<b>GEV No.</b>	693568	<b>Ref. No.</b>	2940.1300
<b>description</b>	bush mounting pos. upper		
<b>For models:</b>	CD101, CD102, CD201, CD202, CD61, CM101, CM102, CM201, CM202, CM61, CPC101, CPC102, CPC201, CPC202, CPC61		



1

<b>GEV No.</b>	693585	<b>Ref. No.</b>	24.00.147
<b>description</b>	bush mounting pos. upper right for door		
<b>For models:</b>	CM101, CM102, CM201, CM202, CM61, CM62, SCC101, SCC102, SCC201, SCC202, SCC61, SCC62		



1

<b>GEV No.</b>	693586	<b>Ref. No.</b>	24.00.137
<b>description</b>	door bolt mounting pos. bottom right latching		
<b>For models:</b>	CM101, CM102, CM61, CM62, SCC101, SCC102, SCC61, SCC62		



1

<b>GEV No.</b>	693588	<b>Ref. No.</b>	24.00.146
<b>description</b>	door bolt mounting pos. bottom right latching		
<b>For models:</b>	CM101, CM102, CM61, CM62, SCC101, SCC102, SCC61, SCC62		



1

<b>GEV No.</b>	693589	<b>Ref. No.</b>	24.00.145
<b>description</b>	door bolt mounting pos. bottom right latching		
<b>For models:</b>	CM201, CM202, SCC201, SCC202		



1

<b>GEV No.</b>	693587	<b>Ref. No.</b>	24.00.223
<b>description</b>	hinge mounting pos. bottom right		
<b>For models:</b>	CM101, CM102, CM61, CM62, SCC101, SCC102, SCC61, SCC62		



1

<b>GEV No.</b>	693552	<b>Ref. No.</b>	8440.1001
<b>description</b>	hinge mounting pos. lower		
<b>For models:</b>	CD101, CM101		



1

<b>GEV No.</b>	693572	<b>Ref. No.</b>	2930.1306
<b>description</b>	hinge mounting pos. lower		
<b>For models:</b>	CD101, CD102, CD61, CM101, CM102, CM61, CPC101, CPC102, CPC61		





1

<b>GEV No.</b>	693554	<b>Ref. No.</b>	8440.1000
<b>description</b>	hinge mounting pos. upper		
<b>For models:</b>	CC101, CC6, CD101, CM101, CM62		



			
1			
<b>GEV No.</b>	693567	<b>Ref. No.</b>	2930.1307
<b>description</b>	hinge mounting pos. upper		
<b>For models:</b>	CD101, CD102, CD201, CD202, CD61, CM101, CM102, CM201, CM202, CM61, CPC101, CPC102, CPC201, CPC202, CPC61		

			
1			
<b>GEV No.</b>	693593	<b>Ref. No.</b>	2580.960495
<b>description</b>	hinge mounting pos. upper		
<b>For models:</b>	CD20, CD201, CM201		

			
1			
<b>GEV No.</b>	693583	<b>Ref. No.</b>	24.00.133
<b>description</b>	hinge mounting pos. upper right		
<b>For models:</b>	CM101, CM102, CM201, CM202, CM61, CM62, SCC101, SCC102, SCC201, SCC202, SCC61, SCC62		

accessories

miscellaneous

			
1			
<b>GEV No.</b>	693570	<b>Ref. No.</b>	2940.1302
<b>description</b>	sleeve latching		
<b>For models:</b>	CD101, CD102, CD201, CD202, CD61, CM101, CM102, CM201, CM202, CM61, CPC101, CPC102, CPC201, CPC202, CPC61		

			
1			
<b>GEV No.</b>	693571	<b>Ref. No.</b>	2940.1303
<b>description</b>	spigot latching		
<b>For models:</b>	CD101, CD102, CD201, CD202, CD61, CM101, CM102, CM201, CM202, CM61, CPC101, CPC102, CPC201, CPC202, CPC61		

filters

device filters

			
1			
<b>GEV No.</b>	698609	<b>Ref. No.</b>	40.02.684
<b>description</b>	filter insert L 180mm W 140mm H 22mm plastic suitable for RATIONAL		

equipment feet and end caps

bullet feet

plastic

			
1			
<b>GEV No.</b>	701589	<b>Ref. No.</b>	2039.0100
<b>description</b>	equipment foot pipe type 35x35 thickness 1-1.5mm H 15-50mm plastic		
<b>For models:</b>	CC101, CC6, CD101, CD20, CD201, CM101, CM201		

zamak/SS

			
1			
<b>GEV No.</b>	700112	<b>Ref. No.</b>	2039.0111
<b>description</b>	equipment foot pipe type 40x40 thickness 1mm H 33-60mm Zamak/SS Qty 1 pcs		
<b>For models:</b>	CC201, CD101, CD102, CD20, CD201, CD202, CD61, CM101, CM102, CM201, CM202, CM61, CM62, CPC101, CPC102, CPC201, CPC202, CPC61, SCC201, SCC202		

## DERBY RUOTE

with bolt hole

chrome-plated steel



1

<b>GEV No.</b>	700200	<b>Ref. No.</b>	2005.0401
<b>description</b>	swivel castor ø 100mm bolt hole bolt hole ø 12mm housing chrome-plated sheet steel capacity 80kg bearing ball bearing wheel body polypropylene tread TPE tyres H 132mm wheel width 30mm Qty 1 pcs		
<b>For models:</b>	CD101, CD20, CD201, CM101, CM201		



1

<b>GEV No.</b>	700201 <sup>1</sup>	<b>Ref. No.</b>	2005.0402
<b>description</b>	swivel castor with swivel brake ø 100mm bolt hole bolt hole ø 12mm housing chrome-plated sheet steel capacity 80kg bearing ball bearing wheel body polypropylene tread TPE tyres H 132mm wheel width 30mm Qty 1 pcs		
<b>For models:</b>	CD101, CD20, CD201, CM101, CM201		

<sup>1</sup>with swivel brake

stainless steel



1

<b>GEV No.</b>	700215	<b>Ref. No.</b>	2005.0403
<b>description</b>	swivel castor ø 100mm bolt hole bolt hole ø 12mm housing SS capacity 80kg bearing ball bearing wheel body polypropylene tread TPE tyres H 132mm wheel width 30mm Qty 1 pcs		
<b>For models:</b>	CC101, CC201, CC6, CC101, CC201, CC62		



1

<b>GEV No.</b>	700222	<b>Ref. No.</b>	2005.0500 2005.0501 2005.0502 2005.0604 2005.0606
<b>description</b>	swivel castor ø 125mm bolt hole bolt hole ø 12mm housing SS capacity 100kg bearing ball bearing wheel body polypropylene tread TPE tyres H 159mm wheel width 30mm Qty 1 pcs		
<b>For models:</b>	CCC101, CCC102, CCC61, CCD101, CCD102, CCD61, CCM101, CCM102, CCM61, CD101, CD102, CD201, CD202, CD61, CM101, CM102, CM201, CM202, CM61, CPC101, CPC102, CPC201, CPC202, CPC61		

## EQUIPMENT FEET AND END CAPS RATIONAL



1

<b>GEV No.</b>	700216 <sup>1</sup>	<b>Ref. No.</b>	2005.0404
<b>description</b>	swivel castor with swivel brake ø 100mm bolt hole bolt hole ø 12mm housing SS capacity 80kg bearing ball bearing wheel body polypropylene tread TPE tyres H 132mm wheel width 30mm Qty 1 pcs		
<b>For models:</b>	CC101, CC201, CC6, CM201, CM62		

<sup>1</sup>with swivel brake



1

<b>GEV No.</b>	700223 <sup>1</sup>	<b>Ref. No.</b>	2005.0600 2005.0601 2005.0602 2005.0603 2005.0605
<b>description</b>	swivel castor with swivel brake ø 125mm bolt hole bolt hole ø 12mm housing SS capacity 100kg bearing ball bearing wheel body polypropylene tread TPE tyres H 159mm wheel width 30mm Qty 1 pcs		
<b>For models:</b>	CCC101, CCC102, CCC61, CCD101, CCD102, CCD61, CCM101, CCM102, CCM61, CD101, CD102, CD201, CD202, CD61, CM101, CM102, CM201, CM202, CM61, CPC101, CPC102, CPC201, CPC202, CPC61		

<sup>1</sup>with swivel brake

## spare parts and accessories

### miscellaneous



1

<b>GEV No.</b>	560192	<b>Ref. No.</b>	1210.0160
<b>description</b>	tooth lock washer ID ø 10.4mm ED ø 18mm SS DIN/ISO DIN 6798A Qty 1 pcs for thread M10		
<b>For models:</b>	CC101, CC201, CC6, CCC101, CCC201, CCC61, CCD101, CCD201, CCD61, CCM101, CCM201, CCM61, CD101, CD20, CD201, CM101, CM201, CM62		

## BLICKLE

### plastic

ø125mm



1

<b>GEV No.</b>	701029	<b>Ref. No.</b>	60.60.100 60.60.100V
<b>description</b>	swivel castor with brake ø 125mm threaded shaft M10 housing plastic H 128mm		
<b>For models:</b>	CM201, CM202, SCC201, SCC202		



1

<b>GEV No.</b>	700988	<b>Ref. No.</b>	60.60.101
<b>description</b>	swivel castor without brake ø 125mm threaded shaft M10 housing plastic H 127mm		
<b>For models:</b>	CM201, CM202, SCC201, SCC202		

## shelves and shelf rails

### grates

#### universal

#### without upstand



1

<b>GEV No.</b>	970862	<b>Ref. No.</b>	6010.1101
<b>description</b>	grate W 325mm D 530mm GN 1/1 chrome-plated steel wire gauge frame 7mm lengthwise wires gauge 4mm crossing wires 1 silver		

### grid attachments



1

<b>GEV No.</b>	694659	<b>Ref. No.</b>	60.61.016
<b>description</b>	rack support L 540mm H 505mm mounting pos. left W 30mm SS		
<b>For models:</b>	CM61, SCC61		

## gaskets

### gaskets for heated units

#### window seals

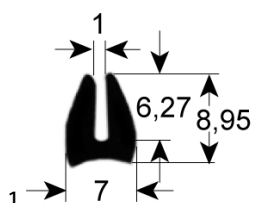

1

<b>GEV No.</b>	902233	<b>Ref. No.</b>	5012.0201
<b>description</b>	window gasket profile 1560 L 2800mm Qty 1		
<b>For models:</b>	CC6		

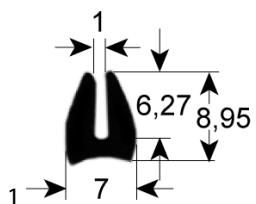
1

<b>GEV No.</b>	902234	<b>Ref. No.</b>	5012.0202
<b>description</b>	window gasket profile 1560 L 3800mm Qty 1		
<b>For models:</b>	CC101, CD101, CM101		

1

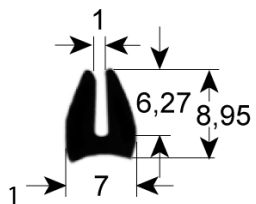
<b>GEV No.</b>	902235	<b>Ref. No.</b>	5012.0203
<b>description</b>	window gasket profile 1560 L 5400mm Qty 1		
<b>For models:</b>	CC201, CD201, CM201		

1

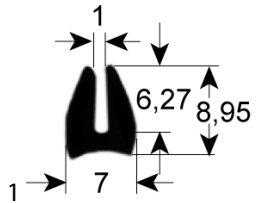
<b>GEV No.</b>	902218	<b>Ref. No.</b>	5012.0204
<b>description</b>	window gasket profile 1560 L 5900mm Qty 1		
<b>For models:</b>	CD20		

<b>GEV No.</b>	902236	<b>Ref. No.</b>	5012.0200 5012.0223
<b>description</b>	window gasket profile 1570 Qty supplied by meter		
<b>For models:</b>	CD101, CD20, CD201, CM101, CM62		

<b>GEV No.</b>	900198	<b>Ref. No.</b>	5105.1006
<b>description</b>	window gasket profile 1860 W 635mm L 1275mm Qty 1 external size		
<b>For models:</b>	CCC202, CCD202, CCM202		

<b>GEV No.</b>	900088	<b>Ref. No.</b>	5105.1005
<b>description</b>	window gasket profile 1860 W 430mm L 1275mm Qty 1 20 x 1/1 external size		
<b>For models:</b>	CCC201, CCD201, CCM201		

**door seals**

<b>GEV No.</b>	902237	<b>Ref. No.</b>	5012.0701
<b>description</b>	door seal profile 2210 L 3800mm Qty 1		
<b>For models:</b>	CC201, CD201, CM201		

<b>GEV No.</b>	900183	<b>Ref. No.</b>	5105.1000
<b>description</b>	window gasket profile 1860 W 430mm L 485mm Qty 1 external size		

<b>GEV No.</b>	902238	<b>Ref. No.</b>	5012.0702
<b>description</b>	door seal profile 2210 L 4200mm Qty 1		
<b>For models:</b>	CD20		

<b>GEV No.</b>	900184	<b>Ref. No.</b>	5105.1003
<b>description</b>	window gasket profile 1860 W 430mm L 745mm Qty 1 external size		
<b>For models:</b>	CCD101		

<b>GEV No.</b>	902240	<b>Ref. No.</b>	5012.0703
<b>description</b>	door seal profile 2230 W 470mm L 485mm external size Qty 1		
<b>For models:</b>	CC6		

<b>GEV No.</b>	900193	<b>Ref. No.</b>	5105.1017
<b>description</b>	window gasket profile 1860 W 600mm L 715mm Qty 1 external size		
<b>For models:</b>	CCC102, CCD102, CCM102		

<b>GEV No.</b>	902241	<b>Ref. No.</b>	5012.0704 5012.0705
<b>description</b>	door seal profile 2230 W 480mm L 725mm external size Qty 1		
<b>For models:</b>	CC101, CD101, CM101		



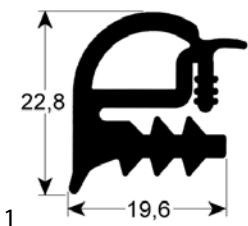

22,8  
19,6  
1

<b>GEV No.</b>	902242	<b>Ref. No.</b>	5105.1001
<b>description</b>	door seal profile 2250 W 470mm L 520mm external size Qty 1 6 x 1/1		
<b>For models:</b>	CCC61, CCD61, CCM61		

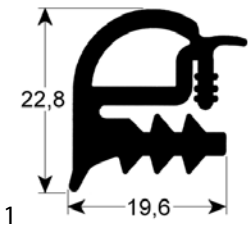

22,8  
19,6  
1

<b>GEV No.</b>	902243	<b>Ref. No.</b>	5105.1004
<b>description</b>	door seal profile 2250 W 470mm L 790mm external size 10 x 1/1		
<b>For models:</b>	CCC101, CCD101, CCM101		

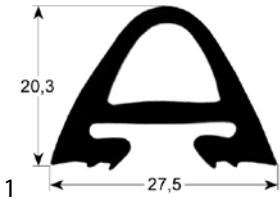

20,3  
27,5  
1

<b>GEV No.</b>	902244	<b>Ref. No.</b>	5105.1007
<b>description</b>	door seal profile 2530 W 520mm L 1400mm external size Qty 1		
<b>For models:</b>	CCC201, CCD201, CCM201		

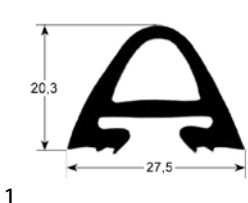

20,3  
27,5  
1

<b>GEV No.</b>	900087	<b>Ref. No.</b>	5110.1047
<b>description</b>	door seal profile 2530 W 710mm L 815mm external size Qty 1 10 x 2/1		
<b>For models:</b>	CCC102, CCD102, CCM102		

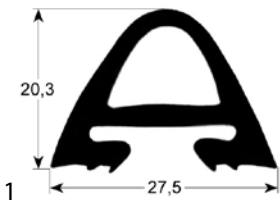

20,3  
27,5  
1

<b>GEV No.</b>	902245	<b>Ref. No.</b>	5105.1008
<b>description</b>	door seal profile 2530 W 720mm L 1410mm external size Qty 1 20 x 2/1		
<b>For models:</b>	CCC202, CCD202, CCM202		

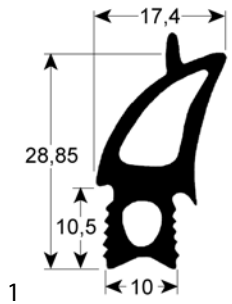

17,4  
28,85  
10,5  
10  
1

<b>GEV No.</b>	902219	<b>Ref. No.</b>	5105.1020 5105.1020P
<b>description</b>	door seal profile 2730 W 465mm L 520mm external size Qty 1		
<b>For models:</b>	CD61, CM101, CM61, CPC61		

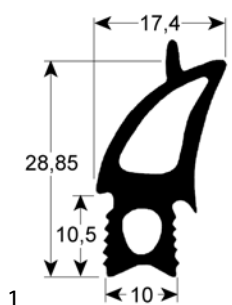

17,4  
28,85  
10,5  
10  
1

<b>GEV No.</b>	902246	<b>Ref. No.</b>	20.00.398P
<b>description</b>	door seal profile 2730 W 470mm L 1475mm suitable for RATIONAL for model SCC/CM201 outer plug size Qty 1		

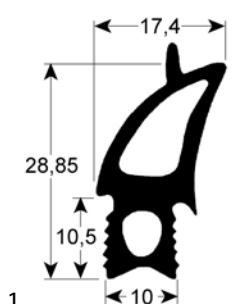

17,4  
28,85  
10,5  
10  
1

<b>GEV No.</b>	902221	<b>Ref. No.</b>	20.00.394 20.00.394P 20.01.800 20.01.800P 20.02.550P
<b>description</b>	door seal profile 2730 W 470mm L 500mm suitable for RATIONAL for model SCC/CM 61 outer plug size Qty 1		
<b>For models:</b>	CM61, SCC61		

<b>GEV No.</b>	902247	<b>Ref. No.</b>	5105.1021 5105.1021P
<b>description</b>	door seal profile 2730 W 470mm L 785mm suitable for RATIONAL for model CPC 101 outer plug size Qty 1		
<b>For models:</b>	CD101, CM101, CPC101		

<b>GEV No.</b>	902220	<b>Ref. No.</b>	5105.1022 5105.1022P
<b>description</b>	door seal profile 2730 W 685mm L 780mm suitable for RATIONAL for model SCC/CM102 edition since 11/2011 outer plug size		
<b>For models:</b>	CD102, CM102, CPC102		

<b>GEV No.</b>	902248	<b>Ref. No.</b>	20.00.399 20.00.399P
<b>description</b>	door seal profile 2730 W 675mm L 1475mm suitable for RATIONAL for model SCC/CM202 outer plug size		
<b>For models:</b>	CM202, SCC202		

<b>GEV No.</b>	902222	<b>Ref. No.</b>	20.00.396 20.00.396P 20.01.802 20.01.802P
<b>description</b>	door seal profile 2731 W 470mm L 760mm suitable for RATIONAL for model SCC/CM 101 edition since 05/2011 outer plug size		
<b>For models:</b>	CM101, SCC101		

<b>GEV No.</b>	902224	<b>Ref. No.</b>	20.00.395 20.00.395P 20.01.801 20.01.801P 20.02.551P
<b>description</b>	door seal profile 2730 W 675mm L 500mm suitable for RATIONAL for model SCC/CM 62 since 05/2011 outer plug size Qty 1		
<b>For models:</b>	CM62, SCC62		

<b>GEV No.</b>	902223	<b>Ref. No.</b>	5105.1023 5105.1023P
<b>description</b>	door seal profile 2732 W 485mm L 1495mm external size Qty 1		
<b>For models:</b>	CD201, CM201, CM202, CPC201, CPC202		

<b>GEV No.</b>	902250	<b>Ref. No.</b>	5105.1024 5105.1024P
<b>description</b>	door seal profile 2732 W 680mm L 1495mm suitable for RATIONAL for model CPC 202 outer plug size		
<b>For models:</b>	CD202, CM202, CPC202		



<b>GEV No.</b>	902337	<b>Ref. No.</b>	20.02.552P
<b>description</b>	door seal profile 2733 W 470mm L 760mm outer plug size for model SCC/CM 101 suitable for RATIONAL		

<b>GEV No.</b>	900055	<b>Ref. No.</b>	5012.0504 5012.0551
<b>description</b>	tray rack trolley gasket profile 4020 Qty supplied by meter silicone foam		
<b>For models:</b>	CD20, CD201		

<b>GEV No.</b>	902249	<b>Ref. No.</b>	20.00.397 20.00.397P 20.01.803P 20.02.553P
<b>description</b>	door seal profile 2733 W 675mm L 760mm suitable for RATIONAL for model SCC/CM102 edition since 05/2011 outer plug size		
<b>For models:</b>	CM102, SCC102		

<b>GEV No.</b>	902227	<b>Ref. No.</b>	5105.1009 5105.1015
<b>description</b>	tray rack trolley gasket profile 4060 W 450mm L 170mm Qty 1 3-sided (long side open)		
<b>For models:</b>	CCC201, CCD201, CCM201		

**gaskets for tray rack trolleys**

<b>GEV No.</b>	902225	<b>Ref. No.</b>	5012.0551
<b>description</b>	tray rack trolley gasket profile 4020 L 1100mm Qty 1 silicone foam		
<b>For models:</b>	CD20		

<b>GEV No.</b>	902228	<b>Ref. No.</b>	5105.1010
<b>description</b>	tray rack trolley gasket profile 4060 W 675mm L 165mm outer plug size Qty 1 suitable for RATIONAL for model C202 3-sided (long side open)		
<b>For models:</b>	CCC202, CCD202, CCM202		

<b>GEV No.</b>	902226	<b>Ref. No.</b>	5012.0550
<b>description</b>	tray rack trolley gasket profile 4020 L 750mm Qty 1 silicone foam		
<b>For models:</b>	CC201, CD201, CM201		

<b>GEV No.</b>	902229	<b>Ref. No.</b>	5105.1025
<b>description</b>	tray rack trolley gasket profile 4090 L 615mm Qty 1		
<b>For models:</b>	CD201, CM201, CM202, CPC201, CPC202		

<b>GEV No.</b>	902230	<b>Ref. No.</b>	5105.1026
<b>description</b>	tray rack trolley gasket profile 4090 L 820mm Qty 1		
<b>For models:</b>	CD202, CM202, CPC202		

<b>GEV No.</b>	902231	<b>Ref. No.</b>	24.00.187
<b>description</b>	tray rack trolley gasket profile 4095 L 575mm Qty 1		
<b>For models:</b>	CM201, SCC201		

<b>GEV No.</b>	902232	<b>Ref. No.</b>	24.00.194
<b>description</b>	tray rack trolley gasket profile 4095 L 780mm Qty 1		
<b>For models:</b>	CM202, SCC202		

**gaskets for control panels**

<b>GEV No.</b>	900575	<b>Ref. No.</b>	16.00.385 16.00.386 16.00.387
<b>description</b>	gasket for control panel		
<b>For models:</b>	CM101, CM102, CM201, CM202, CM61, CM62, SCC101, SCC102, SCC201, SCC202, SCC61, SCC62		

<b>GEV No.</b>	901454	<b>Ref. No.</b>	5100.1010 5100.1011
<b>description</b>	gasket for control panel L 2000mm foam rubber self-adhesive		
<b>For models:</b>	CD101, CD102, CD201, CD202, CD61, CM101, CM102, CM201, CM202, CM61, CPC101, CPC102, CPC201, CPC202, CPC61, SCC101, SCC61		

<b>GEV No.</b>	902406	<b>Ref. No.</b>	16.01.908
<b>description</b>	gasket for control panel suitable for SCC_WE, CM_PW 180mm W2 130mm L 530mm		

<b>GEV No.</b>	900570	<b>Ref. No.</b>	5105.1012
<b>description</b>	gasket for control panel W 305mm L 1000mm external size suitable for RATIONAL short side open		
<b>For models:</b>	CCC101, CCC102, CCD101, CCD102, CCM101, CCM102		

<b>GEV No.</b>	900571	<b>Ref. No.</b>	5105.1013 5105.1014
<b>description</b>	gasket for control panel W 305mm L 1700mm short side open		

<b>GEV No.</b>	900569	<b>Ref. No.</b>	5105.1011
<b>description</b>	gasket for control panel W 305mm L 720mm external size suitable for RATIONAL short side open		
<b>For models:</b>	CCC61, CCD61, CCM61		

<b>GEV No.</b>	900572	<b>Ref. No.</b>	5105.1013 5105.1014
<b>description</b>	gasket for control panel W 415mm L 1700mm external size suitable for RATIONAL short side open		
<b>For models:</b>	CCC201, CCC202, CCD201, CCD202, CCM201, CCM202		

O-rings

EPDM

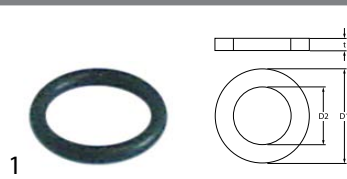

<b>GEV No.</b>	504574	<b>Ref. No.</b>	2060.0228
<b>description</b>	O-ring EPDM thickness 1.78mm ID ø 9.25mm Qty 1 pcs		
<b>For models:</b>	CC101, CC201, CC6, CCC101, CCC102, CCC201, CCC202, CCC61, CCD101, CCD102, CCD201, CCD202, CCD61, CCM101, CCM102, CCM201, CCM202, CCM61, CD101, CD102, CD201, CD202, CD61, CM101, CM102, CM201, CM202, CM61, CM62, CPC101, CPC102, CPC201, CPC202, CPC61		

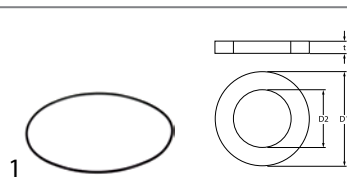

<b>GEV No.</b>	532731	<b>Ref. No.</b>	5012.0565
<b>description</b>	O-ring EPDM thickness 2.5mm ID ø 115mm Qty 5 pcs suitable for combi-steamer CPC-Linie		
<b>For models:</b>	CD101, CD102, CD201, CD202, CD61, CM101, CM102, CM201, CM202, CM61, CPC101, CPC102, CPC201, CPC202, CPC61		



<b>GEV No.</b>	530909	<b>Ref. No.</b>	50.00.538
<b>description</b>	O-ring EPDM thickness 2mm ID ø 11.91mm Qty 5 pcs		
<b>For models:</b>	CM101, CM102, CM201, CM202, CM61, CM62, SCC101, SCC102, SCC201, SCC202, SCC61, SCC62		

silicone

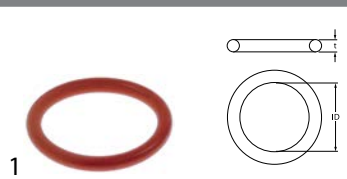

<b>GEV No.</b>	532727	<b>Ref. No.</b>	10.00.512
<b>description</b>	O-ring silicone thickness 3.5mm ID ø 26mm Qty 5 pcs for model SCC, CM		
<b>For models:</b>	SCC101, SCC102, SCC201, SCC202, SCC61, SCC62		

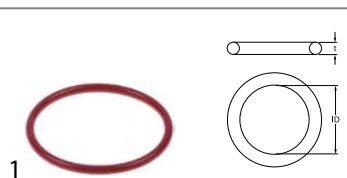

<b>GEV No.</b>	532728	<b>Ref. No.</b>	10.00.511
<b>description</b>	O-ring silicone thickness 3.5mm ID ø 46mm Qty 5 pcs for model SCC, CM		
<b>For models:</b>	SCC101, SCC102, SCC201, SCC202, SCC61, SCC62		

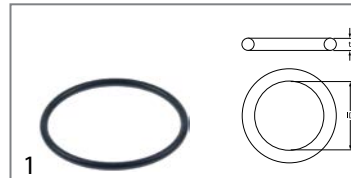

<b>GEV No.</b>	512414	<b>Ref. No.</b>	5012.0538 5012.0560 5012.056D
<b>description</b>	O-ring silicone thickness 3mm ID ø 47.5mm Qty 5 pcs		
<b>For models:</b>	CD101, CD102, CD201, CD202, CD61, CM101, CM102, CM201, CM202, CM61, CPC101, CPC102, CPC201, CPC202, CPC61		

sealing washers

fibre gaskets



<b>GEV No.</b>	560463 <sup>1</sup>	<b>Ref. No.</b>	5012.0534
<b>description</b>	flat gasket fibre ED ø 27.7mm ID ø 19.5mm thickness 1.5mm for burner Qty 5 pcs		
<b>For models:</b>	CM101, CM201, CM62		

<sup>1</sup>Qty 5 pieces

rubber gaskets



<b>GEV No.</b>	505403	<b>Ref. No.</b>	50.00.537
<b>description</b>	flat gasket rubber ED ø 18mm ID ø 13mm thickness 2mm for spray gun combi-steamer Qty 1 pcs for model SCC, CM		
<b>For models:</b>	CM101, CM102, CM201, CM202, CM61, CM62, SCC101, SCC102, SCC201, SCC202, SCC61, SCC62		



<b>GEV No.</b>	560616	<b>Ref. No.</b>	5110.1024
<b>description</b>	gasket ED ø 24mm ID ø 15mm thickness 3mm Qty 5 pcs for model C-Line, CPC, SCC 61-202		
<b>For models:</b>	CCC101, CCC102, CCC201, CCC202, CCC61, CCD101, CCD102, CCD201, CCD202, CCD61, CCM101, CCM102, CCM201, CCM202, CCM61, CD101, CD102, CD201, CD202, CD61, CM101, CM102, CM201, CM202, CM61, CM62, CPC101, CPC102, CPC201, CPC202, CPC61, SCC101, SCC102, SCC201, SCC202, SCC61, SCC62		





<b>GEV No.</b>	560617	<b>Ref. No.</b>	5012.0539
<b>description</b>	gasket rubber ED ø 19.5mm ID ø 12mm thickness 2.3mm Qty 5 pcs		
<b>For models:</b>	CC101, CC6, CCC101, CCC102, CCC201, CCC202, CCC61, CCD101, CCD102, CCD201, CCD202, CCD61, CCM101, CCM102, CCM201, CCM202, CCM61, CD101, CD102, CD201, CD202, CD61, CM101, CM102, CM201, CM202, CM61, CPC101, CPC102, CPC201, CPC202, CPC61		





			
1			
<b>GEV No.</b>	694527	<b>Ref. No.</b>	2070.0020
<b>description</b>	gasket rubber ED ø 57mm ID ø 39mm thickness 4mm for combi-steamer Qty 1 pcs suitable for RATIONAL		
<b>For models:</b>	CC101, CC201, CC6, CD101, CD20, CD201, CM101, CM201		

**copper gaskets**

<b>DIN-7603-A</b>			
			
1			
<b>GEV No.</b>	530883	<b>Ref. No.</b>	1315.0101
<b>description</b>	flat gasket copper ED ø 10mm ID ø 6mm thickness 1mm Qty 10 pcs		
<b>For models:</b>	CC101, CC201, CC6, CCC101, CCC102, CCC201, CCC202, CCC61, CCD101, CCD102, CCD201, CCD202, CCD61, CCM101, CCM102, CCM201, CCM202, CCM61, CD101, CD102, CD201, CD202, CD61, CM101, CM102, CM201, CM202, CM61, CM62, CPC101, CPC102, CPC201, CPC202, CPC61, SCC101, SCC102, SCC201, SCC202, SCC61, SCC62		

			
1			
<b>GEV No.</b>	560200	<b>Ref. No.</b>	1315.0105
<b>description</b>	flat gasket copper ED ø 16mm ID ø 10mm thickness 1.5mm Qty 1 pcs		
<b>For models:</b>	CCC101, CCC102, CCC201, CCC202, CCC61, CCD101, CCD102, CCD201, CCD202, CCD61, CCM101, CCM102, CCM201, CCM202, CCM61, CD101, CD61, CM101, CM102, CM201, CM202, CM61, CPC101, CPC102, CPC201, CPC202, CPC61		

			
1			
<b>GEV No.</b>	560615	<b>Ref. No.</b>	1315.0109
<b>description</b>	gasket copper ED ø 16mm ID ø 8.5mm thickness 1.2mm for combi-steamer suitable for CPC Qty 5 pcs		
<b>For models:</b>	CD101, CD102, CD201, CD202, CD61, CM101, CM102, CM201, CM202, CM61, CPC101, CPC102, CPC201, CPC202, CPC61		

			
1			
<b>GEV No.</b>	560614	<b>Ref. No.</b>	1315.0104
<b>description</b>	gasket copper ED ø 20mm ID ø 16mm thickness 1.5mm suitable for CPC Qty 10 pcs		
<b>For models:</b>	CC101, CC201, CC6, CCD101, CCD102, CCD61, CD101, CD201, CM101, CM102, CM201, CM202, CM61, CM62, CPC101, CPC102, CPC201, CPC202, CPC61, SCC101, SCC102, SCC201, SCC202, SCC61, SCC62		

<b>DIN-7603-C</b>			
			
1			
<b>GEV No.</b>	510420	<b>Ref. No.</b>	3004.1404
<b>description</b>	gasket copper ED ø 19.9mm ID ø 14.3mm thickness 2mm Qty 1 pcs		
<b>For models:</b>	CC101, CC201, CC6, CD101, CD20, CD201, CM101, CM201		

**silicone gaskets**

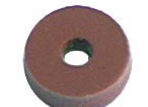
			
1			
<b>GEV No.</b>	510575	<b>Ref. No.</b>	2022.0100 5110.1028
<b>description</b>	flat gasket silicone ED ø 14.5mm ID ø 4mm thickness 4mm Qty 1 pcs		
<b>For models:</b>	CC101, CC201, CC6, CCD101, CCD102, CCD201, CCD202, CCD61, CCM101, CCM102, CCM61, CD101, CD102, CD20, CD201, CD202, CD61, CM101, CM102, CM201, CM202, CM61, CM62, CPC101, CPC102, CPC201, CPC202, CPC61, SCC101, SCC102, SCC201, SCC202, SCC61, SCC62		

			
1			
<b>GEV No.</b>	359721	<b>Ref. No.</b>	3025.0003 5012.0508 5012.0509 5012.0535
<b>description</b>	gasket silicone ED ø 48mm ID ø 39.5mm thickness 5mm Qty 1 pcs		
<b>For models:</b>	CC101, CC201, CC6, CD101, CD20, CD201, CM101, CM201, CM62		

**foam rubber gaskets**

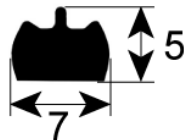
			
1			
<b>GEV No.</b>	901454	<b>Ref. No.</b>	5100.1010 5100.1011
<b>description</b>	gasket for control panel L 2000mm foam rubber self-adhesive		
<b>For models:</b>	CD101, CD102, CD201, CD202, CD61, CM101, CM102, CM201, CM202, CM61, CPC101, CPC102, CPC201, CPC202, CPC61, SCC101, SCC61		

sealing cords

round



<b>GEV No.</b>	510572	<b>Ref. No.</b>	5002.0100 5002.0300 5002.0301 5002.0500 8006.8008
<b>description</b>	sealing cord ø 10mm greased L 0.2m Qty 1		
<b>For models:</b>	CD101, CD20, CD201, CM101, CM201		

shaft gaskets

shaft gaskets



<b>GEV No.</b>	510574	<b>Ref. No.</b>	5001.0211
<b>description</b>	shaft sealing type 20 for fan motor		
<b>For models:</b>	CCC102, CCC202, CCD102, CCD202, CCM102, CCM202		

miscellaneous



<b>GEV No.</b>	510573	<b>Ref. No.</b>	5001.0207
<b>description</b>	shaft seal ID ø 17mm ED ø 29mm thickness 4.5mm		
<b>For models:</b>	CC101, CC201, CC6, CCC101, CCC201, CCC61, CCD101, CCD201, CCD61, CCM101, CCM201, CCM61, CD101, CD102, CD201, CD202, CD61, CM101, CM102, CM201, CM202, CM61, CM62, CPC101, CPC102, CPC201, CPC202, CPC61, SCC101, SCC102, SCC201, SCC202, SCC61, SCC62		



<b>GEV No.</b>	511685	<b>Ref. No.</b>	87.00.564
<b>description</b>	shaft seal kit ID ø 15mm ED ø 27mm shaft seal flange mounting gauge with mountign material		



<b>GEV No.</b>	511682	<b>Ref. No.</b>	8514.1343 87.00.563
<b>description</b>	shaft seal kit ID ø 17mm ED ø 29mm shaft seal flange mounting gauge with mountign material		
<b>For models:</b>	CM101, CM102, CM201, CM202, CM61, CPC101, CPC102, CPC201, CPC202, CPC61		

special gaskets

for combi-steamers



<b>GEV No.</b>	560612	<b>Ref. No.</b>	5110.1310
<b>description</b>	flange gasket ED ø 79mm ID ø 51mm thickness 2mm hole distance 34mm CPC-Linie 101-201/G		
<b>For models:</b>	CM101, CM102, CM201, CPC101, CPC102, CPC201		



<b>GEV No.</b>	560599	<b>Ref. No.</b>	5110.1311
<b>description</b>	gasket ED ø 132mm ID ø 105mm thickness 2mm CPC-Linie CM 61-202/G		
<b>For models:</b>	CM101, CM102, CM201, CM202, CM61, CPC101, CPC102, CPC201, CPC202, CPC61		



<b>GEV No.</b>	560597	<b>Ref. No.</b>	54.00.805
<b>description</b>	gasket ED ø 140mm ID ø 128mm SCC Line		
<b>For models:</b>	CM101, CM102, CM201, CM202, CM61, CM62, SCC101, SCC102, SCC201, SCC202, SCC61, SCC62		



<b>GEV No.</b>	560596	<b>Ref. No.</b>	54.01.168
<b>description</b>	gasket ED ø 60mm ID ø 50mm SCC, SCC_WE, CM, CM_P since 04/2004		



1

<b>GEV No.</b>	560622	<b>Ref. No.</b>	70.00.242
<b>description</b>	gasket ED ø 82mm ID ø 50mm thickness 2.5mm hole distance 50mm SCC Line since 04/04		
<b>For models:</b>	CM102, CM201, CM202, SCC102, SCC201, SCC202		

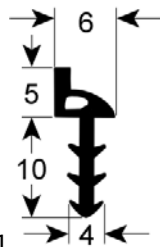

1

<b>GEV No.</b>	560620	<b>Ref. No.</b>	24.00.701
<b>description</b>	gasket L 683mm W 15.5mm external height 6mm for combi-steamer SCC/CM202		
<b>For models:</b>	CM202, SCC202		



1

<b>GEV No.</b>	699803	<b>Ref. No.</b>	70.00.020 72.00.020
<b>description</b>	gasket L 139mm W 130mm silicone thickness 4mm		
<b>For models:</b>	CM101, CM102, CM201, CM202, CM61, CM62, SCC101, SCC102, SCC201, SCC202, SCC61, SCC62		

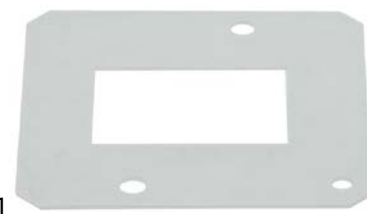

1

<b>GEV No.</b>	560619	<b>Ref. No.</b>	5110.1327
<b>description</b>	gasket L 76mm W 77mm CPC-Linie CM 61-202/G thickness 1mm		
<b>For models:</b>	CM101, CM102, CM201, CM202, CM61, CPC101, CPC102, CPC201, CPC202, CPC61		



1

<b>GEV No.</b>	560611	<b>Ref. No.</b>	40.00.331
<b>description</b>	gasket L 160mm W 75mm for heating element thickness 2mm hole distance 74mm SCC Linie 102/202		
<b>For models:</b>	CM102, CM202, SCC102, SCC202		



1

<b>GEV No.</b>	560629	<b>Ref. No.</b>	5110.1344
<b>description</b>	gasket L 77.5mm W 77mm Viton thickness 1mm combi-steamer CPC-Linie 102/G		
<b>For models:</b>	CM102, CPC102		



1

<b>GEV No.</b>	560613	<b>Ref. No.</b>	74.00.301
<b>description</b>	gasket L 43mm W 67mm thickness 4mm SCC, CM61-202 since 06/2007 for combi-steamer		
<b>For models:</b>	CM101, CM102, CM201, CM202, CM61, CM62, SCC101, SCC102, SCC201, SCC202, SCC61, SCC62		



1

<b>GEV No.</b>	560628	<b>Ref. No.</b>	5110.1339
<b>description</b>	gasket L 77mm W 76mm Viton thickness 1mm combi-steamer CPC-Linie 101/G		
<b>For models:</b>	CM101, CM102, CM201, CPC101, CPC102, CPC201		

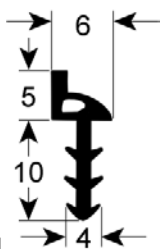

1

<b>GEV No.</b>	560649	<b>Ref. No.</b>	24.00.700
<b>description</b>	gasket L 480mm W 15.5mm external height 6mm for combi-steamer SCC/CM201		
<b>For models:</b>	CM201, SCC201		



1

<b>GEV No.</b>	560598	<b>Ref. No.</b>	5110.1322
<b>description</b>	gasket L 83mm W 76mm thickness 1mm CPC-Linie 201-202/G		
<b>For models:</b>	CM102, CM201, CM202, CPC102, CPC201, CPC202		





1

<b>GEV No.</b>	551350	<b>Ref. No.</b>	8720.1613
<b>description</b>	gasket set for motor CPC, CM, CD		



1

<b>GEV No.</b>	551349	<b>Ref. No.</b>	87.00.562
<b>description</b>	gasket set SCC, CM61-202 since 06/2007		



1

<b>GEV No.</b>	551347	<b>Ref. No.</b>	87.01.188
<b>description</b>	gasket set SCC_WE, CM_P 61-202		

## miscellaneous



1

<b>GEV No.</b>	514508	<b>Ref. No.</b>	50.00.290
<b>description</b>	gasket L 165mm W 140mm for hose reel ED $\phi$ 142/165mm ID $\phi$ 105/120mm		
<b>For models:</b>	CM201, CM202, SCC201, SCC202		



1

<b>GEV No.</b>	692099	<b>Ref. No.</b>	51101342
<b>description</b>	gasket L 78mm W 76mm thickness 1mm		
<b>For models:</b>	CM101, CM201, CPC101, CPC201		

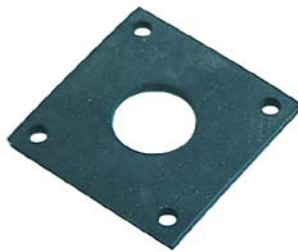

1

<b>GEV No.</b>	510571	<b>Ref. No.</b>	5012.0528 5012.0537
<b>description</b>	gasket suitable for KÜPPERSBUSCH equiv. no. 407308 level regulator		
<b>For models:</b>	CC101, CC201, CC6, CD101, CD20, CD201, CM101, CM201		



1

<b>GEV No.</b>	510566	<b>Ref. No.</b>	5012.0528 5012.0537
<b>description</b>	gasket suitable for RATIONAL equiv. no. 50120537 L 70mm W 70mm electrode thickness 4mm		



1

<b>GEV No.</b>	550895	<b>Ref. No.</b>	5110.1308
<b>description</b>	gasket suitable for RATIONAL equiv. no. 51101308 L 179mm W 90mm electrode thickness 3mm		
<b>For models:</b>	CM101, CM102, CM201, CM202, CM61, CPC101, CPC102, CPC201, CPC202, CPC61		





1

<b>GEV No.</b>	510671	<b>Ref. No.</b>	5012.0525 5012.0555
<b>description</b>	gasket suitable for RATIONAL for drain Qty 1m ED $\phi$ 124mm ID $\phi$ 51mm rubber thickness 4mm hole distance 87mm		
<b>For models:</b>	CC101, CC201, CC6, CD101, CD20, CD201, CM101, CM201		

## springs

### compression springs

			
1			
<b>GEV No.</b>	693541	<b>Ref. No.</b>	2001.0111
<b>description</b>	compression spring ø 11mm L 20mm		
<b>For models:</b>	CCC101, CCC61, CCD101, CCD61, CCM101, CCM61		

			
1			
<b>GEV No.</b>	693551	<b>Ref. No.</b>	2001.0104
<b>description</b>	compression spring ø 11mm L 62mm		
<b>For models:</b>	CD20, CD201, CM201		

			
1			
<b>GEV No.</b>	693591	<b>Ref. No.</b>	2001.0109 2001.0118
<b>description</b>	compression spring ø 14mm L 27mm wire gauge ø 1.5mm		
<b>For models:</b>	CD101, CD102, CD201, CD202, CD61, CM101, CM102, CM201, CM202, CM61, CM62, CPC101, CPC102, CPC201, CPC202, CPC61, SCC101, SCC102, SCC201, SCC202, SCC61, SCC62		

			
1			
<b>GEV No.</b>	693555	<b>Ref. No.</b>	2001.0105
<b>description</b>	compression spring ø 15mm L 35mm		
<b>For models:</b>	CC101, CC6, CD101, CM101		

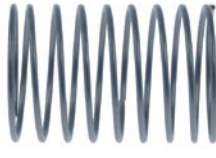
			
1			
<b>GEV No.</b>	692295	<b>Ref. No.</b>	2001.0124
<b>description</b>	compression spring ø 48mm L 71mm wire gauge ø 2.2mm		
<b>For models:</b>	CM101, CM102, CM201, CM202, CPC101, CPC202, SCC101, SCC102, SCC201, SCC202		

			
1			
<b>GEV No.</b>	519578	<b>Ref. No.</b>	2001.0122
<b>description</b>	compression spring ø 6/14mm L 15mm wire gauge ø 1mm windings 4 D1 ø 6mm D2 ø 14mm		
<b>For models:</b>	CD101, CD102, CD61, CM101, CM102, CM61, CPC101, CPC102, CPC61		

			
1			
<b>GEV No.</b>	693553	<b>Ref. No.</b>	2001.0103
<b>description</b>	compression spring ø 9mm L 83mm		
<b>For models:</b>	CD101, CM101		

### miscellaneous

			
1			
<b>GEV No.</b>	701578	<b>Ref. No.</b>	50.00.085
<b>description</b>	spring clip for water dispersion SCC, CM L 27mm W 15mm wire gauge ø 1.5mm		
<b>For models:</b>	CM101, CM102, CM201, CM202, CM61, CM62, SCC101, SCC102, SCC201, SCC202, SCC61, SCC62		

## hose reels and spray guns

### spray guns

			
1			
<b>GEV No.</b>	542380	<b>Ref. No.</b>	5000549 5000590
<b>description</b>	spray gun removable L 165mm		

			
1			
<b>GEV No.</b>	540673	<b>Ref. No.</b>	2060.0100 2060.0300
<b>description</b>	spray gun for appliances 1/2" ET L 135mm conversion kit		
<b>For models:</b>	CC101, CC201, CC6, CD101, CD20, CD201, CM101, CM201, CM62		





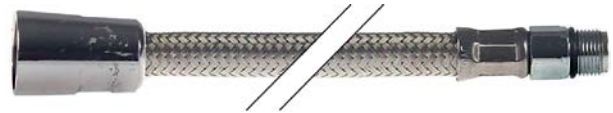

			
1			
<b>GEV No.</b>	540302	<b>Ref. No.</b>	2001.0110 2060.0215 2060.0218 2060.1000 2060.1001 2060.1002 2060.1003 2060.1006 5012.0559
<b>description</b>	spray gun for appliances 1/2" ET L 135mm type RATIONAL		
<b>For models:</b>	CC101, CC201, CC6, CCC101, CCC102, CCC201, CCC202, CCC61, CCD101, CCD102, CCD201, CCD202, CCD61, CCM101, CCM102, CCM201, CCM202, CCM61, CD101, CD102, CD20, CD201, CD202, CD61, CM101, CM102, CM201, CM202, CM61, CM62, CPC101, CPC102, CPC201, CPC202, CPC61		
<b>spare parts for</b>	540302		
	<b>GEV No.</b> 517056	<b>Ref. No.</b>	—
	O-ring EPDM thickness 2mm ID ø 6.5mm Qty 1 pcs		
	<b>GEV No.</b> 532535	<b>Ref. No.</b>	—
	O-ring EPDM thickness 5mm ID ø 10mm Qty 1 pcs		
	<b>GEV No.</b> 548016	<b>Ref. No.</b>	—
	compression spring ø 10mm L 17mm wire gauge ø 0.9mm for hand spray		
	<b>GEV No.</b> 548017	<b>Ref. No.</b>	—
	pressure bolt for hand spray		

			
1			
<b>GEV No.</b>	540664	<b>Ref. No.</b>	50.00.130 50.00.130S
<b>description</b>	spray gun for appliances 1/2" (12.83mm) L 165mm		
<b>For models:</b>	CM101, CM102, CM201, CM202, CM61, CM62, SCC101, SCC102, SCC201, SCC202, SCC61, SCC62		
<b>spare parts for</b>	540664		
	<b>GEV No.</b> 699809	<b>Ref. No.</b>	50.00.156
	clamp for spray gun L 24mm		

			
1			
<b>GEV No.</b>	530604	<b>Ref. No.</b>	2067.0603
<b>description</b>	shower hose connections 1/2" - M12x1 L 1500mm SS		
<b>For models:</b>	CC101, CC6		

			
1			
<b>GEV No.</b>	520730	<b>Ref. No.</b>	2067.0600
<b>description</b>	shower hose connections 1/2" L 2400mm SS operating p. 10bar burst p. 90bar t.max. 90°C approval DVGW with flexible fabric		
<b>For models:</b>	CD101, CM101		

			
1			
<b>GEV No.</b>	520729	<b>Ref. No.</b>	2067.0601
<b>description</b>	shower hose connections 1/2" L 2800mm SS operating p. 10bar burst p. 90bar t.max. 90°C approval DVGW with flexible fabric		
<b>For models:</b>	CD201, CM201		

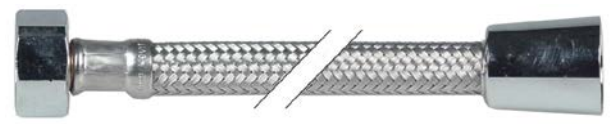
			
1			
<b>GEV No.</b>	520731	<b>Ref. No.</b>	2067.0602
<b>description</b>	shower hose connections 1/2" L 3200mm SS operating p. 10bar burst p. 90bar t.max. 90°C approval DVGW nominal-ø 8mm with flexible fabric		
<b>For models:</b>	CD20		

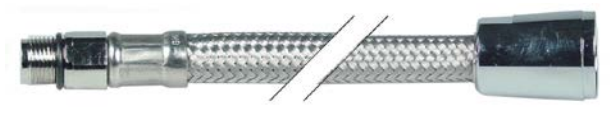
			
1			
<b>GEV No.</b>	520732	<b>Ref. No.</b>	2067.0604
<b>description</b>	shower hose connections 1/4" - 1/2" L 2080mm for combi-steamer		
<b>For models:</b>	CC201		

			
1			
<b>GEV No.</b>	520094	<b>Ref. No.</b>	2067.0605 2067.0610
<b>description</b>	shower hose connections ø12mm - 1/2" L 1500mm for combi-steamer type type 61/101		
<b>For models:</b>	CC101, CC201, CC6, CCC101, CCC102, CCC61, CCD101, CCD102, CCD61, CCM101, CCM102, CCM61, CD101, CD201, CM101, CM201, CM62		

hose reels

appliance hose reels



<b>GEV No.</b>	541442	<b>Ref. No.</b>	8655.3000 8655.3005
<b>description</b>	hose reel complete		
<b>For models:</b>	CCC201, CCD201, CCM201		



<b>GEV No.</b>	541443	<b>Ref. No.</b>	8655.3003 8655.3006
<b>description</b>	hose reel complete		
<b>For models:</b>	CCC202, CCD202, CCM202		



<b>GEV No.</b>	540662	<b>Ref. No.</b>	8410.1013
<b>description</b>	hose reel complete with spray gun hose length 1.5m		
<b>For models:</b>	CC101, CC6, CD101, CM101		



<b>GEV No.</b>	540663	<b>Ref. No.</b>	8655.2006 8655.2007
<b>description</b>	hose reel complete with spray gun hose length 1.5m		
<b>For models:</b>	CCC101, CCC61, CCD61, CCM101, CCM61		

<b>GEV No.</b>	520099	<b>Ref. No.</b>	2067.0607 2067.0611
<b>description</b>	shower hose connections ø12mm - 1/2" L 1800mm for combi-steamer		
<b>For models:</b>	CCC201, CCC202, CCD201, CCD202, CCM201, CCM202		

<b>GEV No.</b>	520108	<b>Ref. No.</b>	2067.0606 2067.0609
<b>description</b>	shower hose connections ø12mm - 1/2" L 2080mm for combi-steamer		
<b>For models:</b>	CM201		

<b>GEV No.</b>	542364	<b>Ref. No.</b>	2067.0710
<b>description</b>	shower hose for combi-steamer CPC-Linie connection 1/2" connection 2: plug-in connection ED ø 12mm L 1345mm		

<b>GEV No.</b>	693526	<b>Ref. No.</b>	2060.1210
<b>description</b>	bush for spray gun		
<b>For models:</b>	CD101, CD102, CD61, CM101, CM102, CM61, CPC101, CPC102, CPC61		

<b>GEV No.</b>	693595	<b>Ref. No.</b>	50.00.135 50.00.752
<b>description</b>	bush for spray gun		
<b>For models:</b>	CM201, CM202, SCC201, SCC202		

<b>GEV No.</b>	540001	<b>Ref. No.</b>	2060.0110
<b>description</b>	screw connection T1: 1/2" T2: 1/2" for spray gun rotary		
<b>For models:</b>	CC101, CC201, CC6, CD101, CD20, CD201, CM101, CM201		

1

<b>GEV No.</b>	541439	<b>Ref. No.</b>	8410.1002 8410.1016
<b>description</b>	hose reel complete with spray gun hose length 1.5mm		
<b>For models:</b>	CC201, CD201, CM201		



1

<b>GEV No.</b>	541440	<b>Ref. No.</b>	8655.2000 8655.2003
<b>description</b>	hose reel complete with spray gun hose length 1.5mm		
<b>For models:</b>	CCC101, CCC61, CCD101, CCD61, CCM101, CCM61		



1

<b>GEV No.</b>	541441	<b>Ref. No.</b>	8655.2009
<b>description</b>	hose reel complete with spray gun hose length 1.5mm		
<b>For models:</b>	CCC102, CCD102, CCM102		







1

<b>GEV No.</b>	541444	<b>Ref. No.</b>	50.00.176 50.00.176P 50.01.239 50.01.239P
<b>description</b>	hose reel without spray gun hose length 1.5m		
<b>For models:</b>	CM201, CM202, SCC201, SCC202		



1

<b>GEV No.</b>	540661	<b>Ref. No.</b>	50.00.140 50.00.140P 50.01.238P	
<b>description</b>	hose reel without spray gun hose length 1m			
<b>For models:</b>	CM101, CM102, CM61, CM62, SCC101, SCC102, SCC61, SCC62			
<b>accessories for</b>	540661			
	<b>GEV No.</b>	540664	<b>Ref. No.</b>	50.00.130 50.00.130S
	spray gun for appliances 1/2" (12.83mm) L 165mm			
	<b>GEV No.</b>	560630	<b>Ref. No.</b>	1107.0100
	clamping washer nominal-ø 4mm ED ø 11.5mm SS thickness 0.2mm			
	<b>GEV No.</b>	694491	<b>Ref. No.</b>	50.00.172
	supply tube for hose reel			
	<b>GEV No.</b>	699802	<b>Ref. No.</b>	50.00.279 50.00.751
	cover for spray gun D1 ø 90/145mm L 145mm H 68mm			



1

<b>GEV No.</b>	540483	<b>Ref. No.</b>	8655.2020 8655.2020P 8655.2021
<b>description</b>	hose reel without spray gun hose length 2.1m		
<b>For models:</b>	CD101, CD102, CD201, CD202, CD61, CM101, CM102, CM201, CM202, CM61, CPC101, CPC102, CPC201, CPC202, CPC61		

spare parts and accessories

hoses

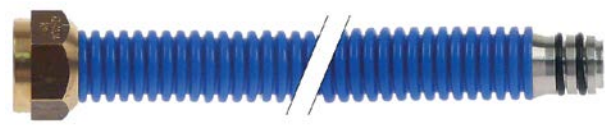

1

<b>GEV No.</b>	520915	<b>Ref. No.</b>	50.01.173
<b>description</b>	connection hose for hose reel connections ø14.6mm / 3/4" length 0.7m		
<b>For models:</b>	SCC101, SCC102, SCC61, SCC62		



## dosing pumps

### accessories

#### hose couplings

##### plastic



1

<b>GEV No.</b>	361102	<b>Ref. No.</b>	2062.0339
<b>description</b>	hose connector plastic angled thread M10x1 hose ø 6mm Qty 1 pcs connection M10x1 hose ø 6mm		



1

<b>GEV No.</b>	361100	<b>Ref. No.</b>	2062.0351
<b>description</b>	hose connector plastic straight thread M10x1 hose ø 6mm Qty 1 pcs connection M10x1 hose ø 6mm		
<b>For models:</b>	CPC101, CPC102, CPC201, CPC202, CPC61		

##### metal



1

<b>GEV No.</b>	361845	<b>Ref. No.</b>	44.00.592
<b>description</b>	hose connector straight hose ø 10mm SS connection 3/8"		
<b>For models:</b>	SCC101, SCC61		

## hoses

### supply hoses

#### PVC supply hoses



1

<b>GEV No.</b>	520954	<b>Ref. No.</b>	50.01.213
<b>description</b>	supply hose PVC straight-straight connection 1/2" L 560mm burst p. 10bar t.max. 90°C red approval EN61770		

#### pre-rinse hoses

##### stainless steel flexi hoses

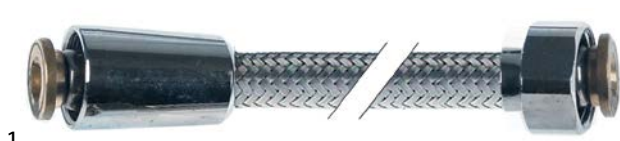

1

<b>GEV No.</b>	520730	<b>Ref. No.</b>	2067.0600
<b>description</b>	shower hose connections 1/2" L 2400mm SS operating p. 10bar burst p. 90bar t.max. 90°C approval DVGW with flexible fabric		
<b>For models:</b>	CD101, CM101		

<b>GEV No.</b>	520729	<b>Ref. No.</b>	2067.0601
<b>description</b>	shower hose connections 1/2" L 2800mm SS operating p. 10bar burst p. 90bar t.max. 90°C approval DVGW with flexible fabric		
<b>For models:</b>	CD201, CM201		

<b>GEV No.</b>	520731	<b>Ref. No.</b>	2067.0602
<b>description</b>	shower hose connections 1/2" L 3200mm SS operating p. 10bar burst p. 90bar t.max. 90°C approval DVGW nominal-ø 8mm with flexible fabric		
<b>For models:</b>	CD20		

### industrial hoses

#### silicone hoses

##### without fabric



1

<b>GEV No.</b>	530067	<b>Ref. No.</b>	2112.1301
<b>description</b>	silicone hose ID ø 50mm ED ø 56mm L 0.13m thickness 3mm t.max. 200°C		
<b>For models:</b>	CD101, CD102, CD201, CD202, CD61, CM101, CM102, CM201, CM202, CM61, CPC101, CPC102, CPC201, CPC202, CPC61		

<b>GEV No.</b>	530796	<b>Ref. No.</b>	2110.1019 2110.1020 2112.1019
<b>description</b>	silicone hose ID ø 5mm ED ø 8mm L 1190mm for combi-steamer CPC/SCC Linie		
<b>For models:</b>	CM101, CM102, CM201, CM61, CPC101, CPC102, CPC201, CPC202, CPC61, SCC101, SCC102, SCC201, SCC202, SCC61, SCC62		





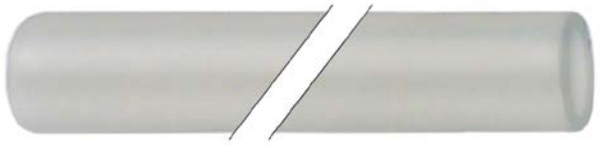

			
1			
<b>GEV No.</b>	530798	<b>Ref. No.</b>	2110.1030
<b>description</b>	silicone hose ID ø 6mm ED ø 10mm L 1120mm for combi-steamer CPC-Linie CM 61-202/G		
<b>For models:</b>	CPC101, CPC102, CPC201, CPC202, CPC61		

			
1	Image not available		
<b>GEV No.</b>	530703	<b>Ref. No.</b>	2067.0313
<b>description</b>	silicone hose ID ø 13mm L 0.38m thickness 4mm		

			
1			
<b>GEV No.</b>	530550	<b>Ref. No.</b>	2110.1008
<b>description</b>	silicone hose ID ø 6mm ED ø 10mm L 5m thickness 2mm operating pressure without pressure burst pressure non defined t.max. 200°C transparent Shore 55°		
<b>For models:</b>	CD101, CD102, CD201, CD202, CD61, CM101, CM102, CM201, CM202, CM61, CM62, CPC101, CPC102, CPC201, CPC202, CPC61, SCC101, SCC102, SCC201, SCC202, SCC61, SCC62		

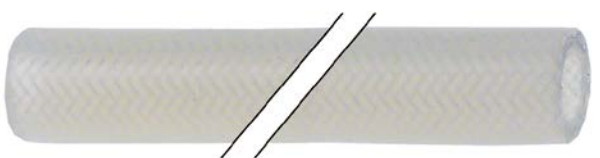
			
1	Image not available		
<b>GEV No.</b>	530699	<b>Ref. No.</b>	2067.0305
<b>description</b>	silicone hose with monofilament braid ED ø 13mm thickness 4mm		
<b>For models:</b>	CD201, CM201		

with fabric			
with monofilament braid			
			
1			
<b>GEV No.</b>	530655	<b>Ref. No.</b>	2067.0115
<b>description</b>	silicone hose ID ø 10mm ED ø 17mm L 1.22m thickness 3.5mm with monofilament braid		
<b>For models:</b>	CC201, CC6, CD201, CM201		

			
1			
<b>GEV No.</b>	530677	<b>Ref. No.</b>	2067.0137
<b>description</b>	silicone hose with monofilament braid ID ø 10mm ED ø 17mm L 0.05m thickness 3.5mm		

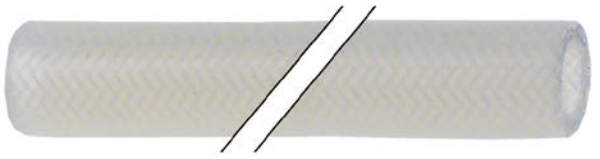
			
1			
<b>GEV No.</b>	530674	<b>Ref. No.</b>	2067.0134
<b>description</b>	silicone hose ID ø 10mm ED ø 17mm L 1.35m thickness 3.5mm with monofilament braid Qty 1.35m		
<b>For models:</b>	CD20		

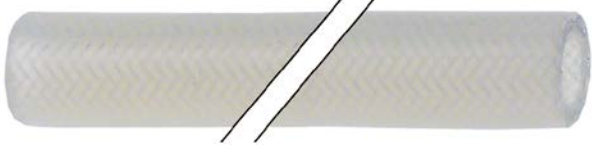
			
1			
<b>GEV No.</b>	530681	<b>Ref. No.</b>	2067.0150
<b>description</b>	silicone hose with monofilament braid ID ø 10mm ED ø 17mm L 0.06m thickness 3.5mm		
<b>For models:</b>	CC201, CD201, CM201		

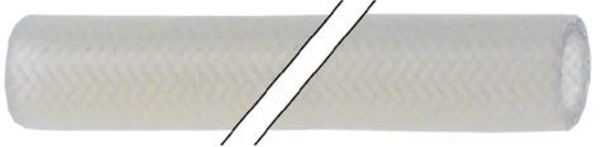
			
1			
<b>GEV No.</b>	530660	<b>Ref. No.</b>	2067.0120
<b>description</b>	silicone hose ID ø 10mm ED ø 17mm L 1.69m thickness 3.5mm with monofilament braid		
<b>For models:</b>	CC101, CC6, CD101, CM101		

			
1			
<b>GEV No.</b>	530667	<b>Ref. No.</b>	2067.0127
<b>description</b>	silicone hose with monofilament braid ID ø 10mm ED ø 17mm L 0.08m thickness 3.5mm		
<b>For models:</b>	CC201, CD201, CM201		

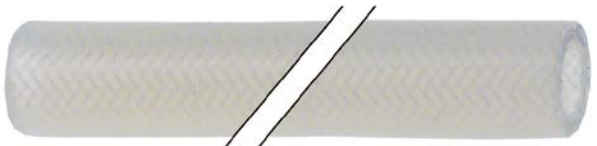
			
1			
<b>GEV No.</b>	530641	<b>Ref. No.</b>	2067.0101
<b>description</b>	silicone hose with monofilament braid ID ø 10mm ED ø 17mm L 0.09m thickness 3.5mm Qty 0.09m		
<b>For models:</b>	CD101, CM101, CM62		



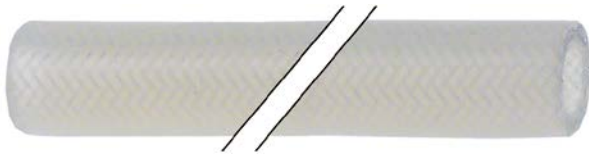

<b>GEV No.</b>	530648	<b>Ref. No.</b>	2067.0108
<b>description</b>	silicone hose with monofilament braid ID ø 10mm ED ø 17mm L 0.12m thickness 3.5mm		
<b>For models:</b>	CD20		

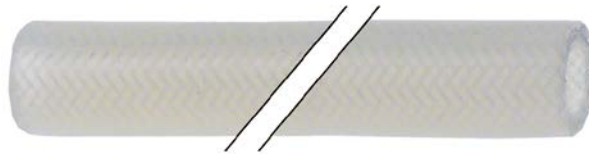

<b>GEV No.</b>	530661	<b>Ref. No.</b>	2067.0121
<b>description</b>	silicone hose with monofilament braid ID ø 10mm ED ø 17mm L 0.29m thickness 3.5mm		
<b>For models:</b>	CM62		

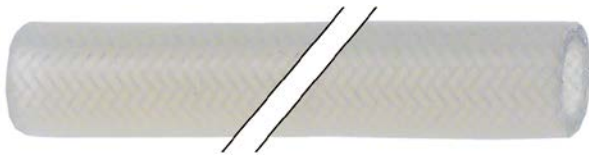

<b>GEV No.</b>	530654	<b>Ref. No.</b>	2067.0114
<b>description</b>	silicone hose with monofilament braid ID ø 10mm ED ø 17mm L 0.15m thickness 3.5mm Qty 0.15m		
<b>For models:</b>	CD201, CM101, CM201		

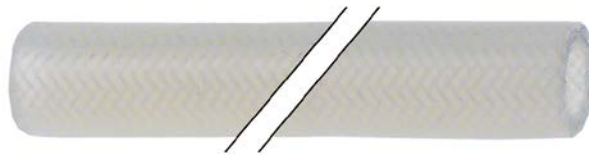

<b>GEV No.</b>	530658	<b>Ref. No.</b>	2067.0118
<b>description</b>	silicone hose with monofilament braid ID ø 10mm ED ø 17mm L 0.2m thickness 3.5mm		

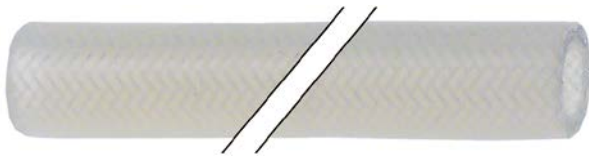

<b>GEV No.</b>	530656	<b>Ref. No.</b>	2067.0116
<b>description</b>	silicone hose with monofilament braid ID ø 10mm ED ø 17mm L 0.17m thickness 3.5mm		

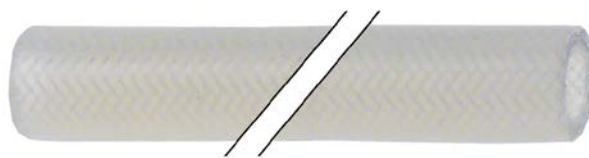

<b>GEV No.</b>	530650	<b>Ref. No.</b>	2067.0110
<b>description</b>	silicone hose with monofilament braid ID ø 10mm ED ø 17mm L 0.36m thickness 3.5mm Qty 0.36m		
<b>For models:</b>	CC201, CD20, CD201, CM201		

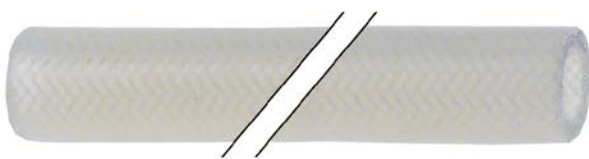

<b>GEV No.</b>	530666	<b>Ref. No.</b>	2067.0126
<b>description</b>	silicone hose with monofilament braid ID ø 10mm ED ø 17mm L 0.1m thickness 3.5mm Qty 0.1m		
<b>For models:</b>	CC101, CC6, CD101, CD201, CM101, CM201		

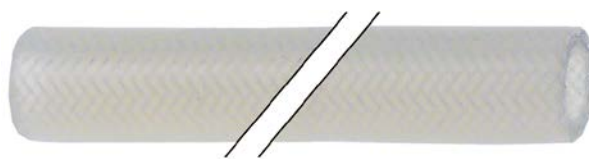

<b>GEV No.</b>	530646	<b>Ref. No.</b>	2067.0106
<b>description</b>	silicone hose with monofilament braid ID ø 10mm ED ø 17mm L 0.37m thickness 3.5mm Qty 0.37m		
<b>For models:</b>	CD201, CM201		

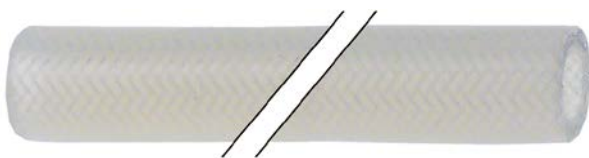

<b>GEV No.</b>	530676	<b>Ref. No.</b>	2067.0136
<b>description</b>	silicone hose with monofilament braid ID ø 10mm ED ø 17mm L 0.23m thickness 3.5mm		

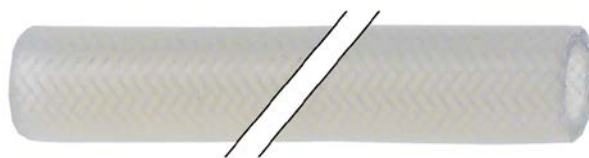

<b>GEV No.</b>	530668	<b>Ref. No.</b>	2067.0128
<b>description</b>	silicone hose with monofilament braid ID ø 10mm ED ø 17mm L 0.42m thickness 3.5mm Qty 0.42m		
<b>For models:</b>	CD20, CD201, CM201		

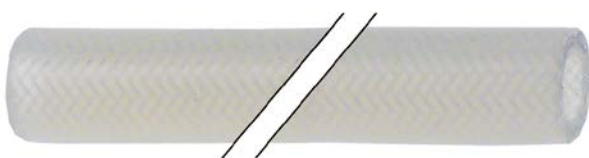

<b>GEV No.</b>	530649	<b>Ref. No.</b>	2067.0109
<b>description</b>	silicone hose with monofilament braid ID ø 10mm ED ø 17mm L 0.25m thickness 3.5mm Qty 0.25m		
<b>For models:</b>	CD20		

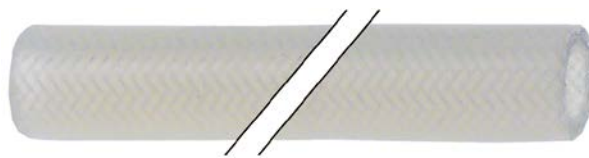

<b>GEV No.</b>	530684	<b>Ref. No.</b>	2067.0156
<b>description</b>	silicone hose with monofilament braid ID ø 10mm ED ø 17mm L 0.44m thickness 3.5mm		
<b>For models:</b>	CC201, CD201, CM201, CM62, SCC101, SCC102, SCC61, SCC62		

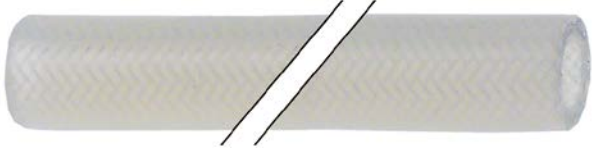

			
1			
<b>GEV No.</b>	530691	<b>Ref. No.</b>	2067.0167
<b>description</b>	silicone hose with monofilament braid ID ø 10mm ED ø 17mm L 0.44m thickness 3.5mm Qty 0.44m		
<b>For models:</b>	CM101		

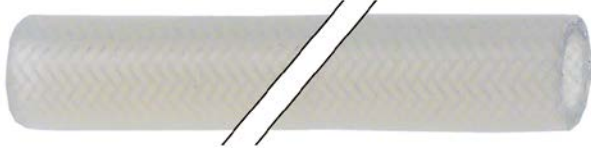
			
1			
<b>GEV No.</b>	530692	<b>Ref. No.</b>	2067.0177
<b>description</b>	silicone hose with monofilament braid ID ø 10mm ED ø 17mm L 0.58m thickness 3.5mm		

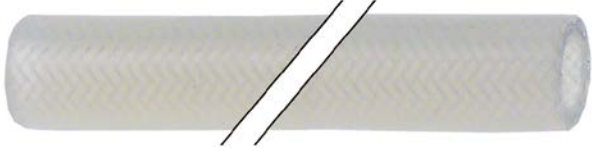
			
1			
<b>GEV No.</b>	530642	<b>Ref. No.</b>	2067.0102
<b>description</b>	silicone hose with monofilament braid ID ø 10mm ED ø 17mm L 0.46m thickness 3.5mm Qty 0.46m		
<b>For models:</b>	CD101, CM101		

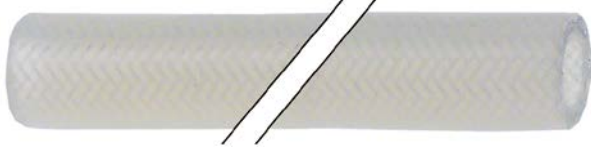
			
1			
<b>GEV No.</b>	530659	<b>Ref. No.</b>	2067.0119
<b>description</b>	silicone hose with monofilament braid ID ø 10mm ED ø 17mm L 0.64m thickness 3.5mm		
<b>For models:</b>	CD101, CD20, CM101, CM61, SCC101, SCC61		

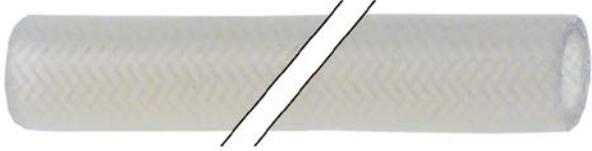
			
1			
<b>GEV No.</b>	530669	<b>Ref. No.</b>	2067.0129
<b>description</b>	silicone hose with monofilament braid ID ø 10mm ED ø 17mm L 0.47m thickness 3.5mm		
<b>For models:</b>	CD201, CM201		

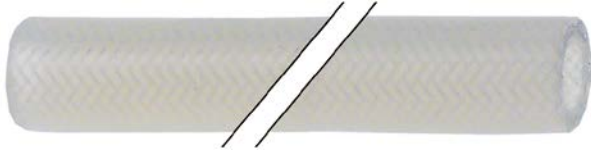
			
1			
<b>GEV No.</b>	530689	<b>Ref. No.</b>	2067.0164
<b>description</b>	silicone hose with monofilament braid ID ø 10mm ED ø 17mm L 0.65m thickness 3.5mm		
<b>For models:</b>	CCC101, CCC61, CCD101, CCD61, CCM101, CCM61		

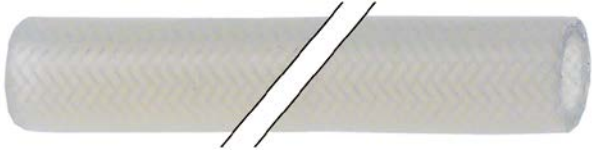
			
1			
<b>GEV No.</b>	530682	<b>Ref. No.</b>	2067.0152
<b>description</b>	silicone hose with monofilament braid ID ø 10mm ED ø 17mm L 0.4m thickness 3.5mm		
<b>For models:</b>	CC201, CD201, CM201		

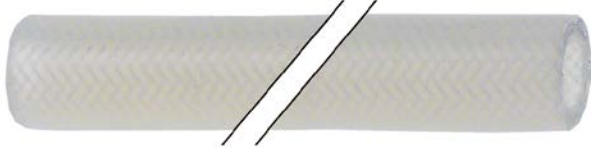
			
1			
<b>GEV No.</b>	530643	<b>Ref. No.</b>	2067.0103
<b>description</b>	silicone hose with monofilament braid ID ø 10mm ED ø 17mm L 0.66m thickness 3.5mm Qty 0.66m		
<b>For models:</b>	CC101, CC6, CD101, CD20, CD201, CM101, CM201		

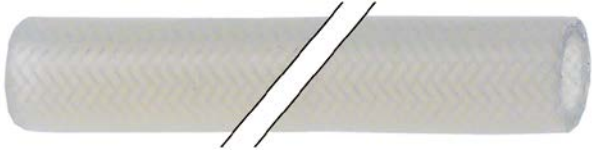
			
1			
<b>GEV No.</b>	530657	<b>Ref. No.</b>	2067.0117
<b>description</b>	silicone hose with monofilament braid ID ø 10mm ED ø 17mm L 0.55m thickness 3.5mm		
<b>For models:</b>	CD201, CM201		

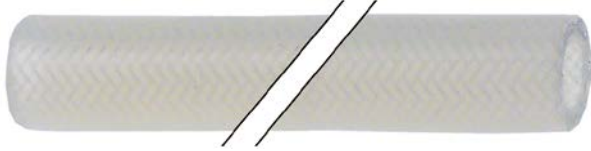
			
1			
<b>GEV No.</b>	530670	<b>Ref. No.</b>	2067.0130
<b>description</b>	silicone hose with monofilament braid ID ø 10mm ED ø 17mm L 0.75m thickness 3.5mm Qty 0.75m		
<b>For models:</b>	CC101, CC6, CD20		

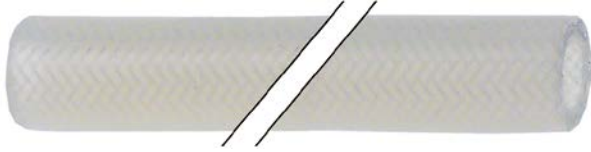
			
1			
<b>GEV No.</b>	530644	<b>Ref. No.</b>	2067.0104
<b>description</b>	silicone hose with monofilament braid ID ø 10mm ED ø 17mm L 0.77m thickness 3.5mm Qty 0.77m		
<b>For models:</b>	CD101, CD20, CM101		

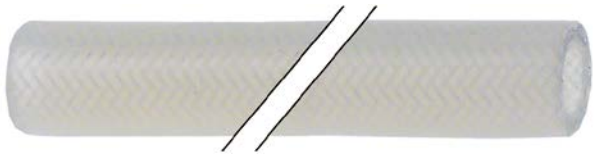

<b>GEV No.</b>	530663	<b>Ref. No.</b>	2067.0123
<b>description</b>	silicone hose with monofilament braid ID ø 10mm ED ø 17mm L 0.7m thickness 3.5mm		
<b>For models:</b>	CC201, CD201, CM201		

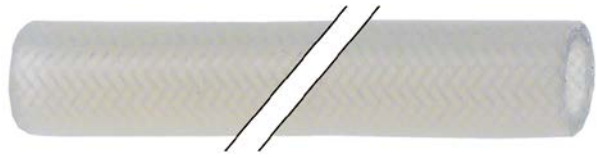

<b>GEV No.</b>	530686	<b>Ref. No.</b>	2067.0159
<b>description</b>	silicone hose with monofilament braid ID ø 10mm ED ø 17mm L 0.9m thickness 3.5mm		
<b>For models:</b>	CCC101, CCC201, CCC202, CCC61, CCD201, CCD202, CCM101, CCM201, CCM202, CCM61, CM62		

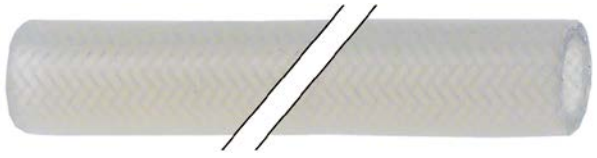

<b>GEV No.</b>	530672	<b>Ref. No.</b>	2067.0132
<b>description</b>	silicone hose with monofilament braid ID ø 10mm ED ø 17mm L 0.81m thickness 3.5mm		
<b>For models:</b>	CC201		

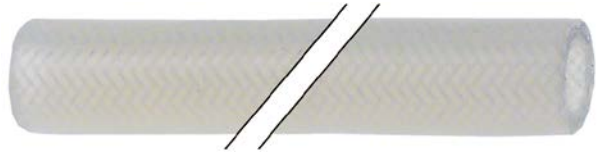

<b>GEV No.</b>	530678	<b>Ref. No.</b>	2067.0141
<b>description</b>	silicone hose with monofilament braid ID ø 10mm ED ø 17mm L 1.06m thickness 3.5mm		
<b>For models:</b>	CCC101, CCC61, CCM101, CCM61, CM62		

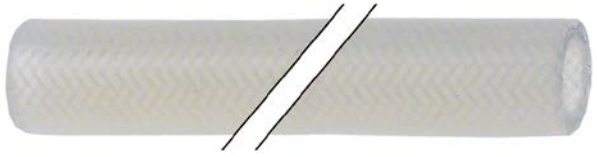

<b>GEV No.</b>	530665	<b>Ref. No.</b>	2067.0125
<b>description</b>	silicone hose with monofilament braid ID ø 10mm ED ø 17mm L 0.88m thickness 3.5mm Qty 0.88m		
<b>For models:</b>	CC6, CCC101, CCC61, CCM101, CCM61		

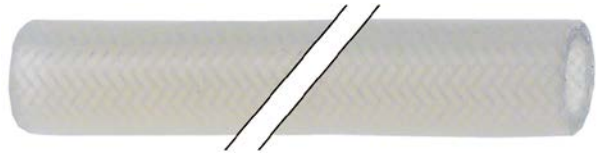

<b>GEV No.</b>	530653	<b>Ref. No.</b>	2067.0113
<b>description</b>	silicone hose with monofilament braid ID ø 10mm ED ø 17mm L 1.1m thickness 3.5mm		
<b>For models:</b>	CD201, CM201		

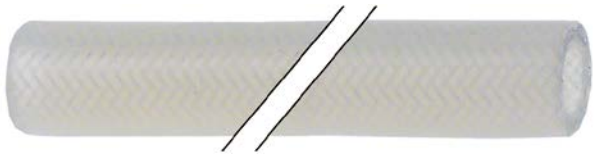

<b>GEV No.</b>	530685	<b>Ref. No.</b>	2067.0158
<b>description</b>	silicone hose with monofilament braid ID ø 10mm ED ø 17mm L 0.92m thickness 3.5mm		
<b>For models:</b>	CC6		

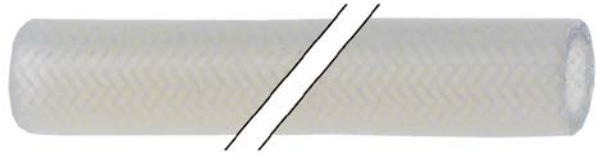

<b>GEV No.</b>	530671	<b>Ref. No.</b>	2067.0131
<b>description</b>	silicone hose with monofilament braid ID ø 10mm ED ø 17mm L 1.23m thickness 3.5mm Qty 1.23m		
<b>For models:</b>	CC101, CD101, CM101		

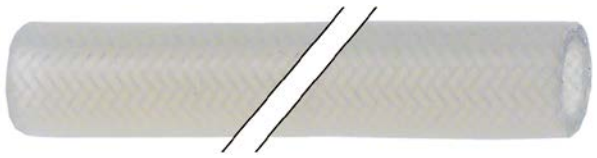

<b>GEV No.</b>	530683	<b>Ref. No.</b>	2067.0153
<b>description</b>	silicone hose with monofilament braid ID ø 10mm ED ø 17mm L 0.95m thickness 3.5mm Qty 0.95m		
<b>For models:</b>	CC101, CC201, CD101, CD201, CM101, CM201		

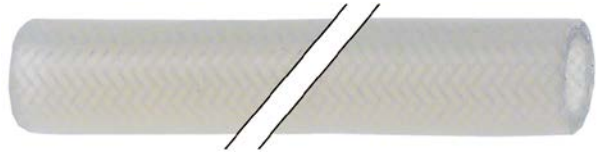

<b>GEV No.</b>	530679	<b>Ref. No.</b>	2067.0143
<b>description</b>	silicone hose with monofilament braid ID ø 10mm ED ø 17mm L 1.27m thickness 3.5mm		
<b>For models:</b>	CM20-3NAC380V50Hz, CM20-3NAC400V50Hz		

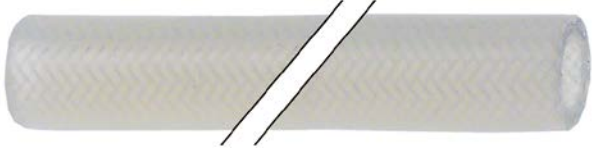

			
<b>GEV No.</b>	530688	<b>Ref. No.</b>	2067.0162
<b>description</b>	silicone hose with monofilament braid ID ø 10mm ED ø 17mm L 1.37m thickness 3.5mm		
<b>For models:</b>	CC101, CC6, CD101, CM101		

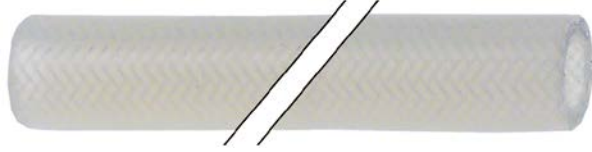
			
<b>GEV No.</b>	530675	<b>Ref. No.</b>	2067.0135
<b>description</b>	silicone hose with monofilament braid ID ø 10mm ED ø 17mm L 1.5m thickness 3.5mm 1.5		
<b>For models:</b>	CD20, CM201		

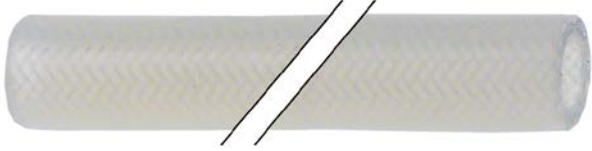
			
<b>GEV No.</b>	530664	<b>Ref. No.</b>	2067.0124
<b>description</b>	silicone hose with monofilament braid ID ø 10mm ED ø 17mm L 1.3m thickness 3.5mm Qty 1.3m		
<b>For models:</b>	CC101, CD101, CD201, CM101, CM201		

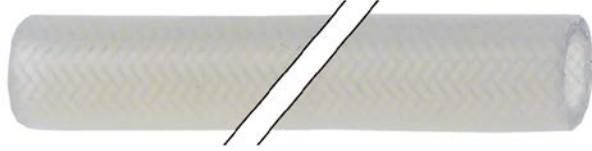
			
<b>GEV No.</b>	530690	<b>Ref. No.</b>	2067.0166
<b>description</b>	silicone hose with monofilament braid ID ø 10mm ED ø 17mm L 1.75m thickness 3.5mm		
<b>For models:</b>	CCC101, CCC61, CCM101, CCM61		

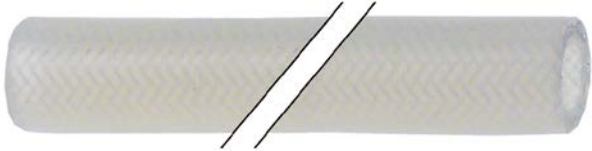
			
<b>GEV No.</b>	530652	<b>Ref. No.</b>	2067.0112
<b>description</b>	silicone hose with monofilament braid ID ø 10mm ED ø 17mm L 1.42m thickness 3.5mm Qty 1.42m		
<b>For models:</b>	CD20		

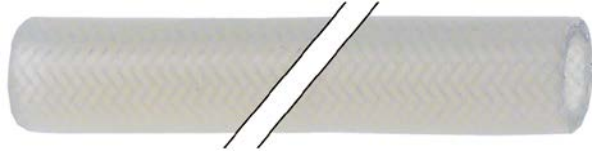
			
<b>GEV No.</b>	530662	<b>Ref. No.</b>	2067.0122
<b>description</b>	silicone hose with monofilament braid ID ø 10mm ED ø 17mm L 1.9m thickness 3.5mm Qty 1.9m		
<b>For models:</b>	CC6		

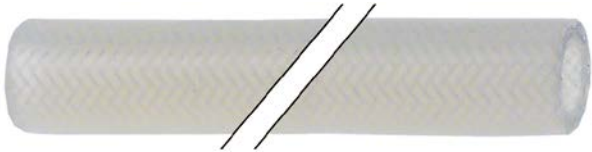
			
<b>GEV No.</b>	530687	<b>Ref. No.</b>	2067.0161
<b>description</b>	silicone hose with monofilament braid ID ø 10mm ED ø 17mm L 1.45m thickness 3.5mm		
<b>For models:</b>	CCC101, CCC61, CCM101, CCM61		

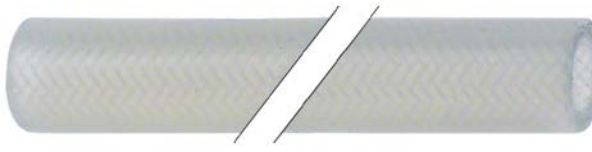
			
<b>GEV No.</b>	530693	<b>Ref. No.</b>	2067.0050 2067.0100 20670101-137
<b>description</b>	silicone hose with monofilament braid ID ø 10mm ED ø 17mm L 1m thickness 3.5mm operating p. 4bar t.max. 200°C Qty 1m		
<b>For models:</b>	CC101, CC201, CC6, CCC101, CCC102, CCC201, CCC202, CCC61, CCD101, CCD102, CCD201, CCD202, CCD61, CCM101, CCM102, CCM201, CCM202, CCM61, CD101, CD102, CD20, CD201, CD202, CD61, CM101, CM102, CM201, CM202, CM61, CM62, CPC101, CPC102, CPC201, CPC202, CPC61, SCC101, SCC102, SCC201, SCC202, SCC61, SCC62		

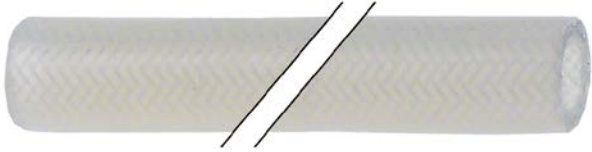
			
<b>GEV No.</b>	530680	<b>Ref. No.</b>	2067.0147
<b>description</b>	silicone hose with monofilament braid ID ø 10mm ED ø 17mm L 1.4m thickness 3.5mm		
<b>For models:</b>	CM20-3NAC380V50Hz, CM20-3NAC400V50Hz		

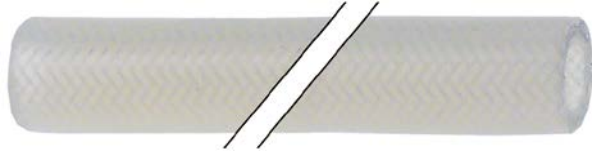
			
<b>GEV No.</b>	530645	<b>Ref. No.</b>	2067.0105
<b>description</b>	silicone hose with monofilament braid ID ø 10mm ED ø 17mm L 1m thickness 3.5mm Qty 1m		
<b>For models:</b>	CD101, CD20, CD201, CM101, CM201		



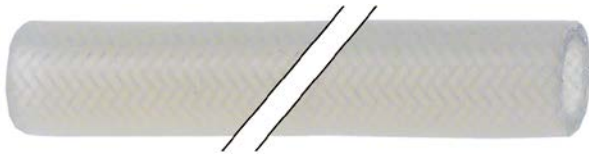

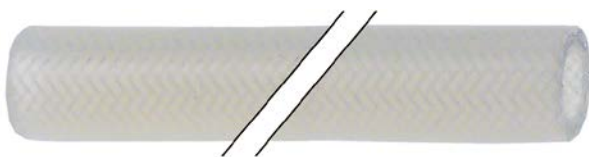

<b>GEV No.</b>	530673	<b>Ref. No.</b>	2067.0133
<b>description</b>	silicone hose with monofilament braid ID ø 10mm ED ø 17mm L 2.07m thickness 3.5mm		
<b>For models:</b>	CC101, CD101, CM101, CM201		

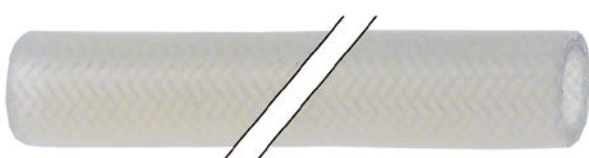

<b>GEV No.</b>	530647	<b>Ref. No.</b>	2067.0107
<b>description</b>	silicone hose with monofilament braid ID ø 10mm ED ø 17mm thickness 3.5mm L 105mm Qty 0.11m		
<b>For models:</b>	CC201, CD20, CD201, CM201		



<b>GEV No.</b>	530651	<b>Ref. No.</b>	2067.0111
<b>description</b>	silicone hose with monofilament braid ID ø 10mm ED ø 17mm thickness 3.5mm L 1085mm Qty 1.09m		
<b>For models:</b>	CD20, CD201, CM201		



<b>GEV No.</b>	530697	<b>Ref. No.</b>	2067.0303
<b>description</b>	silicone hose with monofilament braid ID ø 13mm ED ø 20mm L 0.23m thickness 4mm Qty 0.23m		
<b>For models:</b>	CD20		

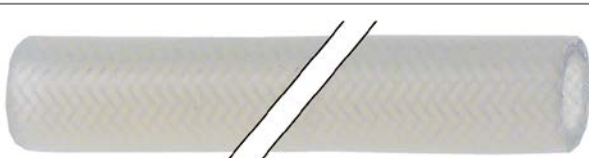

<b>GEV No.</b>	530696	<b>Ref. No.</b>	2067.0302
<b>description</b>	silicone hose with monofilament braid ID ø 13mm ED ø 20mm L 0.29m thickness 4mm Qty 0.29m		
<b>For models:</b>	CD101, CM101		



<b>GEV No.</b>	530698	<b>Ref. No.</b>	2067.0304
<b>description</b>	silicone hose with monofilament braid ID ø 13mm ED ø 20mm L 0.53m thickness 4mm Qty 0.53m		
<b>For models:</b>	CD20		

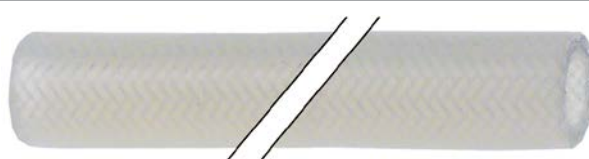

<b>GEV No.</b>	530694	<b>Ref. No.</b>	2067.0300 2110.1017
<b>description</b>	silicone hose with monofilament braid ID ø 13mm ED ø 21mm L 1m thickness 4mm Qty 1m		
<b>For models:</b>	CD101, CPC101, CPC102, CPC201, CPC202, CPC61		



<b>GEV No.</b>	530702	<b>Ref. No.</b>	2067.0312
<b>description</b>	silicone hose with monofilament braid ID ø 13mm L 0.06m thickness 4mm		



<b>GEV No.</b>	530700	<b>Ref. No.</b>	2067.0306
<b>description</b>	silicone hose with monofilament braid ID ø 13mm L 0.11m thickness 4mm		
<b>For models:</b>	CD201, CM201		

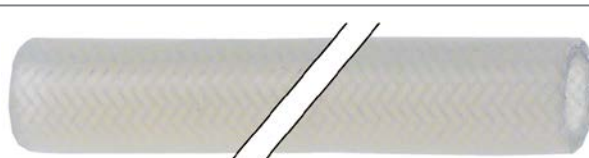

<b>GEV No.</b>	530695	<b>Ref. No.</b>	2067.0301
<b>description</b>	silicone hose with monofilament braid ID ø 13mm L 0.15m thickness 4mm		
<b>For models:</b>	CD101, CM101		





  
Image not available

1

<b>GEV No.</b>	530704	<b>Ref. No.</b>	2067.0314
<b>description</b>	silicone hose with monofilament braid ID ø 13mm L 0.56m thickness 4mm		

  
Image not available

2

<b>GEV No.</b>	530701	<b>Ref. No.</b>	2067.0308
<b>description</b>	silicone hose with monofilament braid ID ø 13mm L 1.22m thickness 4mm		

  
Image not available

1

<b>GEV No.</b>	530705	<b>Ref. No.</b>	2067.0315
<b>description</b>	silicone hose with monofilament braid ID ø 13mm L 1.45m thickness 4mm		



1

<b>GEV No.</b>	530875	<b>Ref. No.</b>	44.00.362
<b>description</b>	steam hose ext. ø 78 ID ø 70mm L 54mm silicone red/black		
<b>For models:</b>	CM202, SCC202		



1

<b>GEV No.</b>	530708	<b>Ref. No.</b>	2067.0202
<b>description</b>	steam hose ID ø 42mm ED ø 58mm L 150mm for combi-steamer		
<b>For models:</b>	CC101, CD101, CM101		



1

<b>GEV No.</b>	530709	<b>Ref. No.</b>	2067.0203
<b>description</b>	steam hose ID ø 42mm ED ø 58mm L 200mm for combi-steamer		
<b>For models:</b>	CC6		



1

<b>GEV No.</b>	530602	<b>Ref. No.</b>	2067.0201 2067.0204
<b>description</b>	steam hose ID ø 42mm ED ø 60mm L 60mm Qty 1 for combi-steamer		
<b>For models:</b>	CC101, CC6, CD101, CM101, CM201		



1

<b>GEV No.</b>	530706	<b>Ref. No.</b>	2067.0200 2067.0210
<b>description</b>	steam hose ID ø 42mm L 1000mm for combi-steamer		
<b>For models:</b>	CD101, CD20, CD201		

formed hoses

straight



1

<b>GEV No.</b>	694321	<b>Ref. No.</b>	2112.1307
<b>description</b>	hose ID ø 70mm ext. ø 80 L 80mm for combi-steamer		
<b>For models:</b>	CD102, CD201, CD202, CM102, CM201, CM202, CPC102, CPC201, CPC202, SCC201, SCC202		



1

<b>GEV No.</b>	530067	<b>Ref. No.</b>	2112.1301
<b>description</b>	silicone hose ID ø 50mm ED ø 56mm L 0.13m thickness 3mm t.max. 200°C		
<b>For models:</b>	CD101, CD102, CD201, CD202, CD61, CM101, CM102, CM201, CM202, CM61, CPC101, CPC102, CPC201, CPC202, CPC61		

			
1			
<b>GEV No.</b>	530711	<b>Ref. No.</b>	2067.0208
<b>description</b>	steam hose ID ø 42mm L 48mm		

			
1			
<b>GEV No.</b>	530710	<b>Ref. No.</b>	2067.0205
<b>description</b>	steam hose ID ø 42mm L 580mm		
<b>For models:</b>	CC201, CD20, CD201, CM201		

 <p>Image not available</p>			
1			
<b>GEV No.</b>	530712	<b>Ref. No.</b>	2067.0209
<b>description</b>	steam hose ID ø 42mm L 90mm for combi-steamer		
<b>For models:</b>	CM201, CM62		

			
1			
<b>GEV No.</b>	530603	<b>Ref. No.</b>	2067.0401
<b>description</b>	steam hose ID ø 60mm ED ø 68mm L 120mm Qty 1 for combi-steamer		
<b>For models:</b>	CC201, CD20, CD201, CM201		

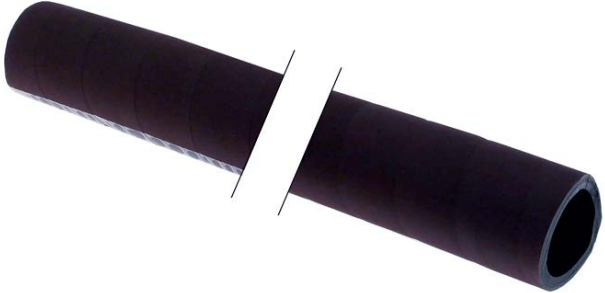
			
1			
<b>GEV No.</b>	530605	<b>Ref. No.</b>	2067.0400 2067.0403
<b>description</b>	steam hose ID ø 60mm L 1000mm steam		
<b>For models:</b>	CD201		

<b>form L</b>			
			
1			
<b>GEV No.</b>	530794	<b>Ref. No.</b>	2112.1304
<b>description</b>	formed hose ED ø 29mm ID ø 23mm L 485mm for combi-steamer CPC-Linie 102/201E		
<b>For models:</b>	CD102, CD201, CM102, CM201, CPC102, CPC201		

			
1			
<b>GEV No.</b>	530791	<b>Ref. No.</b>	44.00.242
<b>description</b>	formed hose ED ø 29mm ID ø 23mm L 730mm for combi-steamer SCC-Linie 202		
<b>For models:</b>	CM202, SCC202		

			
1			
<b>GEV No.</b>	699804	<b>Ref. No.</b>	44.01.219
<b>description</b>	formed hose end piece A ext. ø 28mm end piece A int. ø 22mm AD2 ø 28mm ø end piece B 22mm L 360mm		

			
1			
<b>GEV No.</b>	530917	<b>Ref. No.</b>	56.00.5345
<b>description</b>	formed hose end piece A ext. ø 30mm end piece A int. ø 22mm AD2 ø 23mm ø end piece B 14mm L 330mm		

			
1			
<b>GEV No.</b>	699807	<b>Ref. No.</b>	44.00.212 44.00.234
<b>description</b>	formed hose end piece A ext. ø 30mm end piece A int. ø 22mm AD2 ø 30mm ø end piece B 22mm L 345mm		
<b>For models:</b>	CM61, CM62, SCC61, SCC62		

1

<b>GEV No.</b>	699806	<b>Ref. No.</b>	44.00.216
<b>description</b>	formed hose end piece A ext. ø 30mm end piece A int. ø 22mm AD2 ø 30mm ø end piece B 22mm L 565mm for drain		
<b>For models:</b>	CM102, SCC102		



1

<b>GEV No.</b>	530792	<b>Ref. No.</b>	2112.1305
<b>description</b>	formed hose ID ø 22mm ED ø 29mm L 640mm for combi-steamer CPC 202		
<b>For models:</b>	CD202, CM202, CPC202		



1

<b>GEV No.</b>	530716	<b>Ref. No.</b>	56.00.166
<b>description</b>	formed hose ID ø 18/23mm ED ø 25/28mm L 170mm Qty 1 L-shape for combi-steamer ø ø22(19)mm thickness 3mm		
<b>For models:</b>	SCC101, SCC102, SCC61, SCC62		



1

<b>GEV No.</b>	530816	<b>Ref. No.</b>	2112.1008 2112.1011
<b>description</b>	formed hose ID ø 22mm ED ø 30mm L 550mm for combi-steamer thickness 4mm		
<b>For models:</b>	CCC201, CCC61, CCD201, CCD61, CCM201, CCM61		



1

<b>GEV No.</b>	530717	<b>Ref. No.</b>	56.00.175
<b>description</b>	formed hose ID ø 19/22mm ED ø 25/28mm L 225mm L-shape for combi-steamer thickness 3.5mm		
<b>For models:</b>	SCC201, SCC202		



1

<b>GEV No.</b>	694323	<b>Ref. No.</b>	44.00.241
<b>description</b>	formed hose ID ø 23mm ED ø 28mm L 480mm combi-steamer for drain		
<b>For models:</b>	CM101, SCC101		



1

<b>GEV No.</b>	530793	<b>Ref. No.</b>	44.00.231 44.00.238
<b>description</b>	formed hose ID ø 22mm ED ø 28mm L 640mm for combi-steamer SCC, CM201/202 since 04/2004		
<b>For models:</b>	CM201, CM202, SCC201, SCC202		



1

<b>GEV No.</b>	694324	<b>Ref. No.</b>	2112.1303
<b>description</b>	formed hose ID ø 23mm ED ø 28mm L 480mm for combi-steamer		
<b>For models:</b>	CD101, CD201, CD202, CM101, CPC101		



1

<b>GEV No.</b>	530714	<b>Ref. No.</b>	56.00.120
<b>description</b>	formed hose ID ø 22mm ED ø 29mm L 160/180mm combi-steamer L-shape for combi-steamer		
<b>For models:</b>	SCC102, SCC62		



## form S



1

<b>GEV No.</b>	698610	<b>Ref. No.</b>	54.00.086
<b>description</b>	formed hose ID ø 48mm ED ø 54mm L 100mm for combi-steamer		
<b>For models:</b>	CM101, CM61, SCC101, SCC61		

## form U

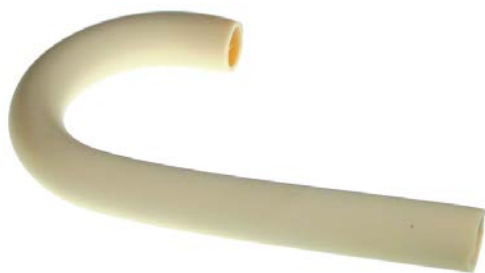

1

<b>GEV No.</b>	530715	<b>Ref. No.</b>	56.00.176
<b>description</b>	formed hose L 450mm ID ø 22mm ED ø 29mm for combi-steamer U-shape		
<b>For models:</b>	SCC201, SCC202		

## miscellaneous



1

<b>GEV No.</b>	524453	<b>Ref. No.</b>	44.00.210
<b>description</b>	formed hose ext. ø 29 D1 ø 23mm D2 ø 23mm L 340mm white Qty 1		
<b>For models:</b>	CM61, SCC61		



1

<b>GEV No.</b>	530908	<b>Ref. No.</b>	44.01.221
<b>description</b>	formed hose ext. ø 30 ID ø 23mm silicone combi-steamer SCC_WE, CM_P		



1

<b>GEV No.</b>	699805	<b>Ref. No.</b>	2112.1306 2118.1250
<b>description</b>	formed hose ext. ø 55 ID ø 50mm L 86mm silicone for ventilation		
<b>For models:</b>	CD101, CD61, CM101, CM61, CPC101, CPC61		



1

<b>GEV No.</b>	694785	<b>Ref. No.</b>	44.00.233
<b>description</b>	formed hose ID ø 23mm ED ø 29mm L 550mm		
<b>For models:</b>	CM201, SCC201		



1

<b>GEV No.</b>	530066	<b>Ref. No.</b>	2112.1302
<b>description</b>	formed hose ID ø 24mm ED ø 30mm L 380mm		
<b>For models:</b>	CD61, CM101, CM61, CPC101, CPC61		

## fittings, hose and pipe connectors

### hose connectors

#### without screw connection



1

<b>GEV No.</b>	361683	<b>Ref. No.</b>	2062.0301
<b>description</b>	hose connector plastic hose ø 10-10mm 2-way		
<b>For models:</b>	CC101, CC201, CC6, CCC101, CCC102, CCC201, CCC202, CCC61, CCD101, CCD102, CCD201, CCD202, CCD61, CCM101, CCM102, CCM201, CCM202, CCM61, CD101, CD20, CD201, CM101, CM201, CPC101, CPC102, CPC201, CPC202, CPC61		



hose connectors

plastic



1

<b>GEV No.</b>	361100	<b>Ref. No.</b>	2062.0351
<b>description</b>	hose connector plastic straight thread M10x1 hose ø 6mm Qty 1 pcs connection M10x1 hose ø 6mm		
<b>For models:</b>	CPC101, CPC102, CPC201, CPC202, CPC61		



1

<b>GEV No.</b>	361754	<b>Ref. No.</b>	2062.0339
<b>description</b>	hose connector plastic angled thread 1/8" hose ø 6mm Qty 1 pcs		
<b>For models:</b>	CPC101, CPC102, CPC201, CPC202, CPC61		



1

<b>GEV No.</b>	361102	<b>Ref. No.</b>	2062.0339
<b>description</b>	hose connector plastic angled thread M10x1 hose ø 6mm Qty 1 pcs connection M10x1 hose ø 6mm		

producer-specific



1

<b>GEV No.</b>	512183	<b>Ref. No.</b>	50.00.070
<b>description</b>	hose connector for hose reel T-shape plastic ø 20/12mm 3/4"		
<b>For models:</b>	CM101, CM102, CM61, CM62, SCC101, SCC102, SCC61, SCC62		



1

<b>GEV No.</b>	512179	<b>Ref. No.</b>	50.00.071
<b>description</b>	hose connector thread 3/4" L-shape ID ø 20/13mm plastic		
<b>For models:</b>	CM101, CM102, CM61, CM62, SCC101, SCC102, SCC61, SCC62		



1

<b>GEV No.</b>	698612	<b>Ref. No.</b>	8464.1300 8664.1300
<b>description</b>	T-piece thread 3/4" ET - 1/2" ET - 3/4" IT plastic		
<b>For models:</b>	CD101, CD102, CD201, CD202, CD61, CM101, CM102, CM201, CM202, CM61, CPC101, CPC102, CPC201, CPC202, CPC61		

drain systems and wash basins

HT drain pipes



1

<b>GEV No.</b>	515165	<b>Ref. No.</b>	8720.1031
<b>description</b>	drain connection set plastic DN 50mm		
<b>For models:</b>	CD101, CD102, CD201, CD202, CD61, CM101, CM102, CM201, CM202, CM61, CPC101, CPC102, CPC201, CPC202, CPC61		
<b>accessories for</b>	515165		
	<b>GEV No.</b>	<b>Ref. No.</b>	—
	520012		
	supply hose PVC straight-curved DN13 connections 3/4" L 2500mm operating p. 10bar burst p. 32bar t.max. 90°C approval VDE flat seal		



## ancillary products

### PTFE tapes



1

<b>GEV No.</b>	890100	<b>Ref. No.</b>	5012.0524
<b>description</b>	PTFE tape reel L 12m W 12mm -200 up to +260°C approval DIN-DVGW, KTW temperature-resistant, elastic for fine thread thickness 0.1mm		
<b>description</b>	PTFE thread sealing tape for fine metal threads Application: All sanitary and heating circuits in hot and cold water areas. DVGW tested. DIN EN751-3. For fine thread DN < 10. Pressure: up to 20 bar. Temperature range: -60°C to +260°C		
<b>For models:</b>	CM101, CM201, CM62		

### silicone

#### food-grade silicones



1

<b>GEV No.</b>	890106	<b>Ref. No.</b>	5006.0200 5006.0202
<b>description</b>	silicone TB40 transparent tube 90g -40 up to +160°C		
<b>description</b>	Tomabond - TB40 - tube 90g - transparent For flexible sealing in drinking water, food, water and industrial kitchen areas. Securely joins glass, metal, wood-based materials, ceramic and plastics with high adhesion (1.1 N/mm <sup>2</sup> ). Fungicide-, algicide- and solvent-free, ageing-resistant. Temperature-resistant from -40 °C to +160 °C Tested and approved by KTW / KSW.		
<b>For models:</b>	CC101, CC201, CC6, CCC101, CCC102, CCC61, CCD101, CCD102, CCD61, CCM101, CCM102, CCM61, CD101, CD102, CD20, CD201, CD202, CD61, CM101, CM102, CM201, CM202, CM61, CM62, CPC101, CPC102, CPC201, CPC202, CPC61		

### clamps

#### hose clamps

##### DIN 3017 - W2



1

<b>GEV No.</b>	520111	<b>Ref. No.</b>	2066.0205
<b>description</b>	hose clamp ø 10-16mm width 9mm Qty 10 pcs DIN 3017		
<b>For models:</b>	CC101, CC201, CC6, CCC101, CCC102, CCC201, CCC61, CCD101, CCD102, CCD201, CCD202, CCD61, CCM101, CCM102, CCM201, CCM202, CCM61, CD101, CD102, CD201, CD202, CD61, CM101, CM102, CM201, CM202, CM61, CM62, CPC101, CPC102, CPC201, CPC202, CPC61, SCC101, SCC102, SCC201, SCC202, SCC61, SCC62		



1

<b>GEV No.</b>	520112	<b>Ref. No.</b>	2066.0200 2066.0202
<b>description</b>	hose clamp ø 12-20mm width 9mm Qty 10 pcs DIN 3017		
<b>For models:</b>	CD101, CD20, CD201, CM101, CM201, SCC101, SCC102, SCC61, SCC62		



1

<b>GEV No.</b>	520114	<b>Ref. No.</b>	2066.0506
<b>description</b>	hose clamp ø 20-32mm width 9mm Qty 10 pcs DIN 3017		
<b>For models:</b>	CC101, CC201, CC6, CD101, CD102, CD20, CD201, CD202, CD61, CM101, CM102, CM201, CM202, CM61, CM62, CPC101, CPC102, CPC201, CPC202, CPC61, SCC101, SCC102, SCC201, SCC202, SCC61, SCC62		





1

<b>GEV No.</b>	520115	<b>Ref. No.</b>	2066.0503
<b>description</b>	hose clamp ø 25-40mm width 9mm Qty 10 pcs DIN 3017		
<b>For models:</b>	CCC101, CCC61, CCD101, CCD61, CCM101, CCM61, CM101, CM102, CM201, CM61, CM62, CPC101, CPC102, CPC201, CPC61		



 <p>1</p>			
<b>GEV No.</b>	520116	<b>Ref. No.</b>	2066.0507
<b>description</b>	hose clamp ø 32-50mm width 9mm Qty 5 pcs DIN 3017		
<b>For models:</b>	CCC101, CCC102, CCC201, CCC202, CCC61, CCD101, CCD102, CCD201, CCD202, CCD61, CCM101, CCM102, CCM201, CCM202, CCM61		

 <p>1</p>			
<b>GEV No.</b>	520118	<b>Ref. No.</b>	2066.0300
<b>description</b>	hose clamp ø 50-70mm width 9mm Qty 5 pcs DIN 3017		
<b>For models:</b>	CCC101, CCC102, CCC201, CCC202, CCC61, CCD101, CCD102, CCD201, CCD202, CCD61, CCM101, CCM102, CCM201, CCM202, CCM61, CD101, CD102, CD201, CD202, CD61, CM101, CM102, CM201, CM202, CM61, CPC101, CPC102, CPC201, CPC202, CPC61, SCC201, SCC202		

 <p>1</p>			
<b>GEV No.</b>	520119	<b>Ref. No.</b>	2066.0516
<b>description</b>	hose clamp ø 60-80mm width 9mm Qty 5 pcs DIN 3017		
<b>For models:</b>	CC101, CC201, CC6, CD101, CD102, CD201, CD202, CM101, CM102, CM201, CM202, CM62, CPC102, CPC201, CPC202, SCC102, SCC201, SCC202, SCC62		

 <p>1</p>			
<b>GEV No.</b>	520454	<b>Ref. No.</b>	2066.0505
<b>description</b>	hose clamp ø 70-90mm width 9mm Qty 5 pcs DIN 3017		
<b>For models:</b>	CC201, CCC101, CCC102, CCC61, CCD101, CCD102, CCD61, CCM101, CCM102, CCM61, CD101, CD20, CD201, CM101, CM201, CM202, SCC202		

 <p>1</p>			
<b>GEV No.</b>	520117	<b>Ref. No.</b>	2066.0504
<b>description</b>	hose clamp stainless steel ø 40-60mm width 9mm Qty 5 pcs DIN 3017		
<b>For models:</b>	CC101, CC201, CC6, CCC101, CCC102, CCC201, CCC202, CCC61, CCD101, CCD201, CCD202, CCD61, CCM101, CCM102, CCM201, CCM202, CCM61, CD101, CD102, CD20, CD201, CD202, CD61, CM101, CM102, CM201, CM202, CM61, CM62, CPC101, CPC102, CPC201, CPC202, CPC61, SCC101, SCC102, SCC201, SCC202, SCC61, SCC62		

<p>DIN 3017 - W4</p>  <p>1</p>			
<b>GEV No.</b>	520121	<b>Ref. No.</b>	10.00.983 2066.0206
<b>description</b>	hose clamp SS W4 ø 16-27mm width 9mm Qty 1 pcs DIN 3017		

<p>double wire clamps</p>  <p>1</p>			
<b>GEV No.</b>	511658	<b>Ref. No.</b>	2066.0533
<b>description</b>	hose clamp ø 10mm wire gauge ø 1.3mm steel Qty 5 pcs		
<b>For models:</b>	CPC101, CPC102, CPC201, CPC202, CPC61		

 <p>1</p>			
<b>GEV No.</b>	520916	<b>Ref. No.</b>	2066.0518
<b>description</b>	hose clamp ø 30mm wire gauge ø 2.7mm chrome-plated steel Qty 1 pcs		
<b>For models:</b>	CC101, CC201, CC6, CD101, CD102, CD201, CD202, CD61, CM101, CM102, CM201, CM202, CM61, CM62, CPC101, CPC102, CPC201, CPC202, CPC61, SCC101, SCC102, SCC201, SCC202, SCC61, SCC62		

 <p>1</p>			
<b>GEV No.</b>	560570	<b>Ref. No.</b>	2066.0519
<b>description</b>	hose clamp ø 35.6mm wire gauge ø 3mm Qty 1 pcs		
<b>For models:</b>	CC101, CC201, CC6, CCC101, CCC102, CCC201, CCC202, CCC61, CCD101, CCD102, CCD201, CCD202, CCD61, CCM101, CCM102, CCM201, CCM202, CCM61, CD101, CD102, CD201, CD202, CD61, CM101, CM102, CM201, CM202, CM61, CM62, CPC101, CPC102, CPC201, CPC202, CPC61, SCC101, SCC102, SCC201, SCC202, SCC61, SCC62		

 <p>1</p>			
<b>GEV No.</b>	512494	<b>Ref. No.</b>	2066.0531
<b>description</b>	hose clamp ø 56mm wire gauge ø 3.5mm steel Qty 5 pcs CPC-Linie CM 61-202/G		
<b>For models:</b>	CD101, CD102, CD201, CD202, CD61, CM101, CM102, CM201, CM202, CM61, CM62, CPC101, CPC102, CPC201, CPC202, CPC61, SCC101, SCC102, SCC201, SCC202, SCC61, SCC62		





			
1			
<b>GEV No.</b>	505351	<b>Ref. No.</b>	20660527
<b>description</b>	wire clamp ø 11.6-12.2mm wire gauge ø 1.5mm zinc-coated steel Qty 100 pcs		
<b>For models:</b>	CD101, CD102, CD201, CD202, CD61, CM101, CM102, CM201, CM202, CM61, CM62, CPC101, CPC102, CPC201, CPC202, CPC61, SCC101, SCC102, SCC201, SCC202, SCC61, SCC62		

			
1			
<b>GEV No.</b>	505358	<b>Ref. No.</b>	2066.0530
<b>description</b>	wire clamp ø 14.4-15.1mm wire gauge ø 1.8mm zinc-coated steel Qty 50 pcs		
<b>For models:</b>	CD101, CD102, CD201, CD202, CD61, CM101, CM102, CM201, CM202, CM61, CM62, CPC101, CPC102, CPC201, CPC202, CPC61, SCC101, SCC102, SCC201, SCC202, SCC61, SCC62		

<b>sealed blind rivets</b>			
			
1			
<b>GEV No.</b>	560180	<b>Ref. No.</b>	1603.0143 1603.0162 1603.0164 1603.0165
<b>description</b>	sealed blank rivets SS ø 3.2mm L 10mm Qty 50 pcs		
<b>For models:</b>	CC201, CD101, CD102, CD20, CD201, CD202, CD61, CM101, CM102, CM201, CM202, CM61, CPC101, CPC102, CPC201, CPC202, CPC61, SCC201, SCC202		

<b>screws</b>			
<b>countersunk screws</b>			
			
1			
<b>GEV No.</b>	560041	<b>Ref. No.</b>	1005.1960
<b>description</b>	countersunk screw thread M5 L 16mm WS 3 SS DIN 7991/ISO 10642 Qty 20 pcs intake hexagonal		
<b>For models:</b>	CC101, CC6, CD101, CD102, CD201, CD202, CD61, CM101, CM102, CM201, CM202, CM61, CM62, CPC101, CPC102, CPC201, CPC202, CPC61		

			
1			
<b>GEV No.</b>	560044	<b>Ref. No.</b>	1006.1960
<b>description</b>	countersunk screw thread M6 L 16mm WS 4 SS DIN 7991/ISO 10642 Qty 20 pcs intake hexagonal		
<b>For models:</b>	CC101, CC201, CC6, CD101, CD102, CD20, CD201, CD61, CM101, CM102, CM201, CM202, CM61, CPC101, CPC102, CPC61		

			
1			
<b>GEV No.</b>	560567	<b>Ref. No.</b>	1008.1963
<b>description</b>	countersunk screw thread M8 L 16mm WS 5 SS DIN 7991/ISO 10642 Qty 1 pcs head ø 15.5mm		
<b>For models:</b>	CD201, CD202, CM201, CM202, CPC201, CPC202, SCC201, SCC202		

<b>hexagonal screws</b>			
			
1			
<b>GEV No.</b>	560309	<b>Ref. No.</b>	1010.0760 1010.0760R
<b>description</b>	hexagonal screw thread M10 thread L 16mm SS WS 17 Qty 1 pcs DIN 933 / ISO 4017		
<b>For models:</b>	CC101, CC201, CC6, CCC101, CCC102, CCC201, CCC61, CCD101, CCD102, CCD201, CCD61, CCM101, CCM102, CCM201, CCM61, CD101, CD20, CD201, CM101, CM201, CM62		

**tools**

**cleaning tools**

**descaling pumps**

**descaling pumps**

			
1			
<b>GEV No.</b>	890294	<b>Ref. No.</b>	6004.0203
<b>description</b>	descaling pump manual 12l/min connection stuff		
<b>For models:</b>	CCC101, CCC102, CCC61, CCD101, CCD102, CCD61, CCM101, CCM102, CCM61, CD101, CD102, CD201, CD202, CD61, CM101, CM102, CM201, CM202, CM61, CPC101, CPC102, CPC201, CPC202, CPC61		

**fastening material**

**rivets/rievt nuts**

**blind rivets DIN 7337 - stainless steel**

			
1			
<b>GEV No.</b>	560161	<b>Ref. No.</b>	16040167
<b>description</b>	blind rivet SS ø 3.9mm L 10mm Qty 50 pcs DIN 1700		
<b>For models:</b>	CD101, CD102, CD201, CD202, CD61, CM101, CM102, CM201, CM202, CM61, CM62, CPC101, CPC102, CPC201, CPC202, CPC61, SCC101, SCC102, SCC201, SCC202, SCC61, SCC62		





 <p>1</p>			
<b>GEV No.</b>	560311	<b>Ref. No.</b>	1010.0762 1010.0762R
<b>description</b>	hexagonal screw thread M10 thread L 20mm SS WS 17 Qty 1 pcs DIN 933 / ISO 4017		
<b>For models:</b>	CCC101, CCC61, CCD101, CCD61, CCM101, CCM61, CD101, CD102, CD201, CD202, CD61, CM101, CM102, CM201, CM202, CM61, CPC101, CPC102, CPC201, CPC202, CPC61		

 <p>1</p>			
<b>GEV No.</b>	560087	<b>Ref. No.</b>	1006.0760
<b>description</b>	hexagonal screw thread M6 thread L 16mm SS WS 10 Qty 20 pcs DIN 933 / ISO 4017		
<b>For models:</b>	CCC102, CCC201, CCC202, CCD102, CCD201, CCD202, CCM102, CCM201, CCM202, CD101, CD102, CD61, CM101, CM102, CM201, CM202, CM61, CM62, CPC101, CPC102, CPC61, SCC101, SCC102, SCC201, SCC202, SCC61, SCC62		

 <p>1</p>			
<b>GEV No.</b>	560308	<b>Ref. No.</b>	1016.0700
<b>description</b>	hexagonal screw thread M16 thread L 20mm SS WS 24 Qty 1 pcs DIN 933 / ISO 4017		
<b>For models:</b>	CCC202, CCD202, CCM202, CD20, SCC101, SCC201, SCC202, SCC61		

 <p>1</p>			
<b>GEV No.</b>	502214	<b>Ref. No.</b>	1008.0760
<b>description</b>	hexagonal screw thread M8 thread L 16mm SS WS 13 Qty 1 pcs head thickness 5.5mm DIN 933 / ISO 4017		
<b>For models:</b>	CD201, CD202, CM201, CM202, CPC201, CPC202, SCC201, SCC202		

 <p>1</p>			
<b>GEV No.</b>	560083	<b>Ref. No.</b>	1008.0752
<b>description</b>	hexagonal screw thread M5 thread L 10mm SS WS 8 Qty 20 pcs DIN 933 / ISO 4017		
<b>For models:</b>	CC101, CC6, CD101, CD102, CD201, CD202, CD61, CM101, CM102, CM201, CM202, CM61, CM62, CPC101, CPC102, CPC201, CPC202, CPC61, SCC201, SCC202		

 <p>1</p>			
<b>GEV No.</b>	550682	<b>Ref. No.</b>	1008.0763
<b>description</b>	hexagonal screw thread M8 thread L 20mm SS WS 13 Qty 1 pcs DIN 933 / ISO 4017		
<b>For models:</b>	CC201, CD20, CD201, CM101, CM102, CM201, CM202, CM61, CM62, SCC101, SCC102, SCC201, SCC202, SCC61, SCC62		

 <p>1</p>			
<b>GEV No.</b>	560448	<b>Ref. No.</b>	1008.0753
<b>description</b>	hexagonal screw thread M5 thread L 8mm SS WS 8 Qty 1 pcs head thickness 4mm DIN 933 / ISO 4017		
<b>For models:</b>	CCC101, CCC102, CCC201, CCC202, CCC61, CCD101, CCD102, CCD201, CCD202, CCD61, CCM101, CCM102, CCM201, CCM202, CCM61, CD101, CD102, CD201, CD202, CD61, CM101, CM102, CM201, CM202, CM61, CPC101, CPC102, CPC201, CPC202, CPC61		

 <p>1</p>			
<b>GEV No.</b>	560204	<b>Ref. No.</b>	1008.0761
<b>description</b>	hexagonal screw thread M8 thread L 25mm SS WS 13 Qty 1 pcs DIN 933 / ISO 4017		
<b>For models:</b>	CCC201, CCC202, CCD201, CCD202, CCM201, CCM202, CD201, CD202, CM101, CM201, CM202, CM61, CM62, CPC201, CPC202, SCC101, SCC102, SCC201, SCC202, SCC61, SCC62		

 <p>1</p>			
<b>GEV No.</b>	560079	<b>Ref. No.</b>	1006.0761
<b>description</b>	hexagonal screw thread M6 thread L 12mm SS WS 10 Qty 20 pcs DIN 933 / ISO 4017		
<b>For models:</b>	CD101, CD102, CD201, CD202, CD61, CM101, CM102, CM201, CM202, CM61, CPC101, CPC102, CPC201, CPC202, CPC61, SCC201, SCC202		

 <p>1</p>			
<b>GEV No.</b>	560205	<b>Ref. No.</b>	1008.0766
<b>description</b>	hexagonal screw thread M8 thread L 30mm SS WS 13 Qty 1 pcs DIN 933 / ISO 4017		
<b>For models:</b>	CD101, CD102, CD201, CD202, CD61, CM101, CM102, CM201, CM202, CM61, CPC101, CPC102, CPC201, CPC202, CPC61, SCC201, SCC202		

 <p>1</p>			
<b>GEV No.</b>	560624	<b>Ref. No.</b>	10.00.109
<b>description</b>	hexagonal screw thread M5x23 thread L 16mm A2-70 WS 8 Qty 5 pcs		
<b>For models:</b>	CM101, CM102, CM201, CM202, CM61, CM62, SCC101, SCC102, SCC201, SCC202, SCC61, SCC62		

			
1			
<b>GEV No.</b>	550528	<b>Ref. No.</b>	1005.2000
<b>description</b>	safety screw thread M5 WS 8 Qty 10 pcs L 8mm head ø 11mm		
<b>For models:</b>	CC101, CC201, CC6, CCC101, CCC102, CCC201, CCC202, CCC61, CCD101, CCD102, CCD201, CCD202, CCD61, CCM101, CCM102, CCM201, CCM202, CCM61, CD101, CD102, CD20, CD201, CD61, CM101, CM102, CM201, CM61, CM62, CPC101, CPC102, CPC61, SCC101, SCC102, SCC61		

## cylinder head bolts

DIN 912/ISO 4762

			
1			
<b>GEV No.</b>	530454	<b>Ref. No.</b>	1004.0665
<b>description</b>	cylinder head bolt thread M4 thread L 6mm L 9.5mm WS 3 SS Qty 1 pcs intake internal hexagon DIN 912/ISO 4762		
<b>For models:</b>	CM201, CM202, CPC101, CPC102, CPC201, CPC202, CPC61, SCC201, SCC202		

			
1			
<b>GEV No.</b>	560402	<b>Ref. No.</b>	1005.0663
<b>description</b>	cylinder head bolt thread M5 thread L 10mm L 15.5mm WS 4 SS Qty 1 pcs intake hexagonal DIN 912/ISO 4762		
<b>For models:</b>	CD101, CM101		

			
1			
<b>GEV No.</b>	560029	<b>Ref. No.</b>	1005.0661
<b>description</b>	cylinder head bolt thread M5 thread L 20mm WS 4 SS Qty 20 pcs DIN 912/ISO 4762		
<b>For models:</b>	CC201, CD20, CD201, CM201		

## miscellaneous

			
1			
<b>GEV No.</b>	694943	<b>Ref. No.</b>	1008.0768
<b>description</b>	safety screw thread M8 L 16mm WS 13 hexagonal head for combi-steamer CPC-Linie		
<b>For models:</b>	CD101, CD102, CD201, CD202, CD61, CM101, CM102, CM201, CM202, CM61, CM62, CPC101, CPC102, CPC201, CPC202, CPC61, SCC101, SCC102, SCC201, SCC202, SCC61, SCC62		

			
1			
<b>GEV No.</b>	694941	<b>Ref. No.</b>	10.00.565 10.00.936
<b>description</b>	safety screw thread M8 L 20mm WS 13 Qty 5 pcs for combi-steamer SCC WE		
<b>For models:</b>	CM101, CM102, CM201, CM202, CM61, CM62, SCC101, SCC102, SCC201, SCC202, SCC61, SCC62		

## nuts

## cap nuts

			
1			
<b>GEV No.</b>	694944	<b>Ref. No.</b>	10.01.076
<b>description</b>	cap nuts thread M5 WS 8 SS Qty 5 pcs for combi-steamer SCC WE		

			
1			
<b>GEV No.</b>	560137	<b>Ref. No.</b>	1106.0360
<b>description</b>	cap nuts thread M6 WS 10 SS Qty 20 pcs DIN/ISO DIN 1587		
<b>For models:</b>	CC201, CCC101, CCC102, CCC201, CCC202, CCC61, CCD101, CCD102, CCD201, CCD202, CCD61, CCM101, CCM102, CCM201, CCM202, CCM61, CD101, CD102, CD20, CD201, CD202, CD61, CM101, CM102, CM201, CM202, CM61, CM62, CPC101, CPC102, CPC201, CPC202, CPC61, SCC101, SCC102, SCC201, SCC202, SCC61, SCC62		

## hexagonal nuts

DIN 934 / ISO 4032/8673

			
1			
<b>GEV No.</b>	560199	<b>Ref. No.</b>	1112.0110
<b>description</b>	hexagonal nut thread M10 H 8mm WS 17 SS DIN/ISO DIN 934 / ISO 4032/8673 Qty 10 pcs		
<b>For models:</b>	CCC101, CCC102, CCC61, CCD101, CCD102, CCD61, CCM101, CCM102, CCM61, CD101, CD102, CD201, CD202, CD61, CM101, CM102, CM201, CM202, CM61, CM62, CPC101, CPC102, CPC201, CPC202, CPC61, SCC101, SCC102, SCC201, SCC202, SCC61, SCC62		







 <p>1</p>			
<b>GEV No.</b>	511212	<b>Ref. No.</b>	1106.0160 1106.0803
<b>description</b>	hexagonal nut thread M6 H 5mm WS 10 SS DIN/ISO DIN 934 / ISO 4032/8673 Qty 1 pcs		
<b>For models:</b>	CC101, CC201, CC6, CCC102, CCC202, CCD102, CCD202, CCM102, CCM202, CD101, CD102, CD20, CD201, CD202, CD61, CM101, CM102, CM201, CM202, CM61, CM62, CPC101, CPC102, CPC201, CPC202, CPC61, SCC101, SCC102, SCC201, SCC202, SCC61, SCC62		

 <p>2</p>			
<b>GEV No.</b>	560134	<b>Ref. No.</b>	1108.0260
<b>description</b>	hexagonal nut thread M8 H 6.5mm WS 13 SS DIN/ISO DIN 934 / ISO 4032/8673 Qty 20 pcs		
<b>For models:</b>	CC101, CC201, CC6, CCC101, CCC201, CCC61, CCD101, CCD201, CCD61, CCM101, CCM201, CCM61, CD101, CD102, CD20, CD201, CD202, CD61, CM101, CM102, CM201, CM202, CM61, CM62, CPC101, CPC102, CPC201, CPC202, CPC61, SCC101, SCC102, SCC201, SCC202, SCC61, SCC62		

<b>DIN 985</b>			
 <p>1</p>			
<b>GEV No.</b>	560451	<b>Ref. No.</b>	1103.0122
<b>description</b>	hexagonal nut thread M3 self-locking H 4mm WS 5.5 Qty 10 pcs DIN/ISO DIN 985		
<b>For models:</b>	CCC101, CCC102, CCC61, CCM101, CCM102, CCM61, CD101, CD102, CD61, CM101, CM102, CM201, CM202, CM61, CM62, CPC101, CPC102, CPC201, CPC202, CPC61, SCC101, SCC102, SCC201, SCC202, SCC61, SCC62		

<b>DIN 6923 / ISO 4161</b>			
 <p>1</p>			
<b>GEV No.</b>	542383	<b>Ref. No.</b>	1105.0121
<b>description</b>	hexagonal nut thread M5 H 6mm zinc-coated steel WS 8 Qty 10 pcs for combi-steamer SCC WE		
<b>For models:</b>	CD101, CD102, CD201, CD202, CD61, CM101, CM102, CM201, CM202, CM61, CM62, CPC101, CPC102, CPC201, CPC202, CPC61, SCC101, SCC102, SCC201, SCC202, SCC61, SCC62		

<b>hexagonal nuts metric (without norm)</b>			
 <p>1</p>			
<b>GEV No.</b>	530881	<b>Ref. No.</b>	1106.0220
<b>description</b>	hexagonal nut thread M6 H 3mm WS 10 SS Qty 25 pcs for combi-steamer CPC-Linie		
<b>For models:</b>	CC101, CC201, CC6, CCC101, CCC102, CCC201, CCC202, CCC61, CCD101, CCD102, CCD201, CCD202, CCD61, CCM101, CCM102, CCM201, CCM202, CCM61, CD101, CD102, CD201, CD202, CD61, CM101, CM102, CM201, CM202, CM61, CM62, CPC101, CPC102, CPC201, CPC202, CPC61, SCC101, SCC102, SCC201, SCC202, SCC61, SCC62		

 <p>1</p>			
<b>GEV No.</b>	520230	<b>Ref. No.</b>	3004.1406
<b>description</b>	nut thread M14x1.5 H 5mm WS 19 zinc-coated steel Qty 1 pcs		
<b>For models:</b>	CC101, CC201, CC6, CD101, CD20, CD201, CM101, CM201		

<b>union nuts</b>			
 <p>1</p>			
<b>GEV No.</b>	694940	<b>Ref. No.</b>	2120.1308
<b>description</b>	union nut for door drip tray for combi-steamer CPC-Linie CPC 61/101/201 L 8mm WS 5 thread M3 Qty 2 pcs		
<b>For models:</b>	CD101, CD102, CD61, CM101, CM102, CM61, CPC101, CPC102, CPC61		

<b>washers</b>			
<b>spring rings</b>			
 <p>1</p>			
<b>GEV No.</b>	560122	<b>Ref. No.</b>	1205.0360
<b>description</b>	lock washer ID ø 5.2mm ED ø 9mm SS DIN127 Qty 20 pcs for thread M5		
<b>For models:</b>	CC101, CC201, CC6, CD101, CD20, CD201, CM101, CM201		

 <p>1</p>			
<b>GEV No.</b>	560123	<b>Ref. No.</b>	1206.0261
<b>description</b>	lock washer ID ø 6.3mm ED ø 11mm SS DIN127 Qty 20 pcs for thread M6		
<b>For models:</b>	CCC101, CCC102, CCC201, CCC202, CCC61, CCD101, CCD102, CCD201, CCD202, CCD61, CCM101, CCM102, CCM201, CCM202, CCM61, CD101, CD102, CD201, CD202, CD61, CM101, CM102, CM201, CM202, CM61, CPC101, CPC102, CPC201, CPC202, CPC61, SCC101, SCC201, SCC202, SCC61		

 <p>1</p>			
<b>GEV No.</b>	560124	<b>Ref. No.</b>	1208.0260
<b>description</b>	lock washer ID ø 8.3mm ED ø 15mm SS DIN127 Qty 20 pcs for thread M8		
<b>For models:</b>	CCC101, CCC61, CCD101, CCD61, CCM101, CCM61, CD101, CD102, CD201, CD202, CD61, CM101, CM102, CM201, CM202, CM61, CM62, CPC101, CPC102, CPC201, CPC202, CPC61, SCC101, SCC102, SCC201, SCC202, SCC61, SCC62		

spring washers



<b>GEV No.</b>	696429	<b>Ref. No.</b>	2016.1455
<b>description</b>	spring washer ID ø 20.5mm ED ø 40mm steel Qty 1 pcs		
<b>For models:</b>	CC201, CD20, CD201, CM201		

spring washers



<b>GEV No.</b>	560630	<b>Ref. No.</b>	1107.0100
<b>description</b>	clamping washer nominal-ø 4mm ED ø 11.5mm SS thickness 0.2mm		
<b>For models:</b>	CCC101, CCC102, CCC201, CCC202, CCC61, CCD101, CCD102, CCD201, CCD202, CCD61, CCM101, CCM102, CCM201, CCM202, CCM61, CD101, CD102, CD201, CD202, CD61, CM101, CM102, CM201, CM202, CM61, CM62, CPC101, CPC102, CPC201, CPC202, CPC61, SCC101, SCC102, SCC201, SCC202, SCC61, SCC62		

washers

DIN 125A



<b>GEV No.</b>	560310	<b>Ref. No.</b>	1308.0123
<b>description</b>	plain washer ED ø 30mm for thread M16		
<b>For models:</b>	CCC202, CCD202, CCM202, CD20		



<b>GEV No.</b>	560312	<b>Ref. No.</b>	1310.0160
<b>description</b>	plain washer ID ø 10.5mm ED ø 20mm thickness 2mm SS Qty 1 pcs DIN 125A for thread M10		
<b>For models:</b>	CC101, CC201, CC6, CCC101, CCC201, CCC61, CCD101, CCD201, CCD61, CCM101, CCM201, CCM61, CD101, CD102, CD20, CD201, CD61, CM101, CM102, CM201, CM61, CM62, CPC101, CPC102, CPC61		



<b>GEV No.</b>	560112	<b>Ref. No.</b>	10.00.802 10.01.321
<b>description</b>	plain washer ID ø 5.3mm ED ø 10mm thickness 1mm SS Qty 20 pcs DIN 125A for thread M5		



<b>GEV No.</b>	560113	<b>Ref. No.</b>	1306.0120
<b>description</b>	plain washer ID ø 6.4mm ED ø 12mm thickness 1.6mm SS Qty 20 pcs DIN 125A for thread M6		
<b>For models:</b>	CC101, CC201, CC6, CCC101, CCC102, CCC201, CCC202, CCC61, CCD101, CCD102, CCD201, CCD202, CCD61, CCM101, CCM102, CCM201, CCM202, CCM61, CD101, CD102, CD20, CD201, CD202, CD61, CM101, CM102, CM201, CM202, CM61, CM62, CPC101, CPC102, CPC201, CPC202, CPC61, SCC101, SCC102, SCC201, SCC202, SCC61, SCC62		



<b>GEV No.</b>	560114	<b>Ref. No.</b>	1308.0160
<b>description</b>	plain washer ID ø 8.4mm ED ø 16mm thickness 1.6mm SS Qty 20 pcs DIN 125A for thread M8		
<b>For models:</b>	CCC201, CCC202, CCD201, CCD202, CCM201, CCM202, CD101, CD102, CD20, CD201, CD202, CD61, CM101, CM102, CM201, CM202, CM61, CM62, CPC101, CPC102, CPC201, CPC202, CPC61, SCC101, SCC102, SCC201, SCC202, SCC61, SCC62		

DIN 9021



<b>GEV No.</b>	560116	<b>Ref. No.</b>	1305.0260
<b>description</b>	plain washer ID ø 5.3mm ED ø 15mm thickness 1.5mm SS Qty 20 pcs DIN 9021 for thread M5		
<b>For models:</b>	CC101, CC201, CC6, CD101, CD102, CD20, CD201, CD61, CM101, CM102, CM201, CM61, CM62, CPC101, CPC102, CPC61		



<b>GEV No.</b>	560117	<b>Ref. No.</b>	1306.0221
<b>description</b>	plain washer ID ø 6.4mm ED ø 18mm thickness 1.5mm SS Qty 20 pcs DIN 9021 for thread M6		
<b>For models:</b>	CC101, CC201, CC6, CD101, CD102, CD20, CD201, CD202, CM101, CM102, CM201, CM202, CM61, CM62, CPC101, CPC102, CPC201, CPC202, CPC61, SCC101, SCC201, SCC202, SCC61		

miscellaneous



<b>GEV No.</b>	560580	<b>Ref. No.</b>	1306.0222
<b>description</b>	plain washer ID ø 6.4mm ED ø 15mm thickness 1.5mm Qty 10 pcs		
<b>For models:</b>	CD101, CD102, CD201, CD202, CD61, CM101, CM102, CM201, CM202, CM61, CM62, CPC101, CPC102, CPC201, CPC202, CPC61, SCC101, SCC102, SCC201, SCC202, SCC61, SCC62		





			
1			
<b>GEV No.</b>	560313	<b>Ref. No.</b>	1328.0102
<b>description</b>	serrated locking washer ID ø 10mm ED ø 22mm thickness 1.5mm SS Qty 1 pcs for thread M10		
<b>For models:</b>	CCC101, CCC61, CCD101, CCD61, CCM101, CCM61, CD101, CD102, CD201, CD202, CD61, CM101, CM102, CM201, CM202, CM61, CM62, CPC101, CPC102, CPC201, CPC202, CPC61, SCC101, SCC102, SCC61, SCC62		

tooth lock washers

DIN 6798A			
			
1			
<b>GEV No.</b>	560192	<b>Ref. No.</b>	1210.0160
<b>description</b>	tooth lock washer ID ø 10.4mm ED ø 18mm SS DIN/ISO DIN 6798A Qty 1 pcs for thread M10		
<b>For models:</b>	CC101, CC201, CC6, CCC101, CCC201, CCC61, CCD101, CCD201, CCD61, CCM101, CCM201, CCM61, CD101, CD20, CD201, CM101, CM201, CM62		

miscellaneous

			
1			
<b>GEV No.</b>	560314	<b>Ref. No.</b>	1217.0159 1217.0160
<b>description</b>	tooth lock washer for thread M16		
<b>For models:</b>	CCC202, CCD202, CCM202, CD20		

			
1			
<b>GEV No.</b>	520228	<b>Ref. No.</b>	3004.1405
<b>description</b>	tooth lock washer ID ø 15.3mm ED ø 24mm steel Qty 1 pcs for thread M14		
<b>For models:</b>	CC101, CC201, CC6, CD101, CD20, CD201, CM101, CM201		

fasteners

clamps

hose clamps

DIN 3017 - W2

			
1			
<b>GEV No.</b>	520111	<b>Ref. No.</b>	2066.0205
<b>description</b>	hose clamp ø 10-16mm width 9mm Qty 10 pcs DIN 3017		
<b>For models:</b>	CC101, CC201, CC6, CCC101, CCC102, CCC201, CCC202, CCC61, CCD101, CCD102, CCD201, CCD202, CCD61, CCM101, CCM102, CCM201, CCM202, CCM61, CD101, CD102, CD201, CD202, CD61, CM101, CM102, CM201, CM202, CM61, CM62, CPC101, CPC102, CPC201, CPC202, CPC61, SCC101, SCC102, SCC201, SCC202, SCC61, SCC62		

			
1			
<b>GEV No.</b>	520112	<b>Ref. No.</b>	2066.0200 2066.0202
<b>description</b>	hose clamp ø 12-20mm width 9mm Qty 10 pcs DIN 3017		
<b>For models:</b>	CD101, CD20, CD201, CM101, CM201, SCC101, SCC102, SCC61, SCC62		

			
1			
<b>GEV No.</b>	520114	<b>Ref. No.</b>	2066.0506
<b>description</b>	hose clamp ø 20-32mm width 9mm Qty 10 pcs DIN 3017		
<b>For models:</b>	CC101, CC201, CC6, CD101, CD102, CD20, CD201, CD202, CD61, CM101, CM102, CM201, CM202, CM61, CM62, CPC101, CPC102, CPC201, CPC202, CPC61, SCC101, SCC102, SCC201, SCC202, SCC61, SCC62		

			
1			
<b>GEV No.</b>	520115	<b>Ref. No.</b>	2066.0503
<b>description</b>	hose clamp ø 25-40mm width 9mm Qty 10 pcs DIN 3017		
<b>For models:</b>	CCC101, CCC61, CCD101, CCD61, CCM101, CCM61, CM101, CM102, CM201, CM61, CM62, CPC101, CPC102, CPC201, CPC61		

			
1			
<b>GEV No.</b>	520116	<b>Ref. No.</b>	2066.0507
<b>description</b>	hose clamp ø 32-50mm width 9mm Qty 5 pcs DIN 3017		
<b>For models:</b>	CCC101, CCC102, CCC201, CCC202, CCC61, CCD101, CCD102, CCD201, CCD202, CCD61, CCM101, CCM102, CCM201, CCM202, CCM61		

			
1			
<b>GEV No.</b>	520118	<b>Ref. No.</b>	2066.0300
<b>description</b>	hose clamp ø 50-70mm width 9mm Qty 5 pcs DIN 3017		
<b>For models:</b>	CCC101, CCC102, CCC201, CCC202, CCC61, CCD101, CCD102, CCD201, CCD202, CCD61, CCM101, CCM102, CCM201, CCM202, CCM61, CD101, CD102, CD201, CD202, CD61, CM101, CM102, CM201, CM202, CM61, CPC101, CPC102, CPC201, CPC202, CPC61, SCC201, SCC202		

			
1			
<b>GEV No.</b>	520119	<b>Ref. No.</b>	2066.0516
<b>description</b>	hose clamp ø 60-80mm width 9mm Qty 5 pcs DIN 3017		
<b>For models:</b>	CC101, CC201, CC6, CD101, CD102, CD201, CD202, CM101, CM102, CM201, CM202, CM62, CPC102, CPC201, CPC202, SCC102, SCC201, SCC202, SCC62		

			
1			
<b>GEV No.</b>	520454	<b>Ref. No.</b>	2066.0505
<b>description</b>	hose clamp ø 70-90mm width 9mm Qty 5 pcs DIN 3017		
<b>For models:</b>	CC201, CCC101, CCC102, CCC61, CCD101, CCD102, CCD61, CCM101, CCM102, CCM201, CCM202, CCM61, CD101, CD20, CD201, CM101, CM201, CM202, SCC202		

			
1			
<b>GEV No.</b>	520117	<b>Ref. No.</b>	2066.0504
<b>description</b>	hose clamp stainless steel ø 40-60mm width 9mm Qty 5 pcs DIN 3017		
<b>For models:</b>	CC101, CC201, CC6, CCC101, CCC102, CCC201, CCC202, CCC61, CCD101, CCD201, CCD202, CCD61, CCM101, CCM102, CCM201, CCM202, CCM61, CD101, CD102, CD20, CD201, CD202, CD61, CM101, CM102, CM201, CM202, CM61, CM62, CPC101, CPC102, CPC201, CPC202, CPC61, SCC101, SCC102, SCC201, SCC202, SCC61, SCC62		

<b>DIN 3017 - W4</b>			
			
1			
<b>GEV No.</b>	520121	<b>Ref. No.</b>	10.00.983 2066.0206
<b>description</b>	hose clamp SS W4 ø 16-27mm width 9mm Qty 1 pcs DIN 3017		

<b>double wire clamps</b>			
			
1			
<b>GEV No.</b>	511658	<b>Ref. No.</b>	2066.0533
<b>description</b>	hose clamp ø 10mm wire gauge ø 1.3mm steel Qty 5 pcs		
<b>For models:</b>	CPC101, CPC102, CPC201, CPC202, CPC61		

			
1			
<b>GEV No.</b>	520916	<b>Ref. No.</b>	2066.0518
<b>description</b>	hose clamp ø 30mm wire gauge ø 2.7mm chrome-plated steel Qty 1 pcs		
<b>For models:</b>	CC101, CC201, CC6, CD101, CD102, CD201, CD202, CD61, CM101, CM102, CM201, CM202, CM61, CM62, CPC101, CPC102, CPC201, CPC202, CPC61, SCC101, SCC102, SCC201, SCC202, SCC61, SCC62		

			
1			
<b>GEV No.</b>	560570	<b>Ref. No.</b>	2066.0519
<b>description</b>	hose clamp ø 35.6mm wire gauge ø 3mm Qty 1 pcs		
<b>For models:</b>	CC101, CC201, CC6, CCC101, CCC102, CCC201, CCC202, CCC61, CCD101, CCD102, CCD201, CCD202, CCD61, CCM101, CCM102, CCM201, CCM202, CCM61, CD101, CD102, CD201, CD202, CD61, CM101, CM102, CM201, CM202, CM61, CM62, CPC101, CPC102, CPC201, CPC202, CPC61, SCC101, SCC102, SCC201, SCC202, SCC61, SCC62		

			
1			
<b>GEV No.</b>	512494	<b>Ref. No.</b>	2066.0531
<b>description</b>	hose clamp ø 56mm wire gauge ø 3.5mm steel Qty 5 pcs CPC-Linie CM 61-202/G		
<b>For models:</b>	CD101, CD102, CD201, CD202, CD61, CM101, CM102, CM201, CM202, CM61, CM62, CPC101, CPC102, CPC201, CPC202, CPC61, SCC101, SCC102, SCC201, SCC202, SCC61, SCC62		



			
1			
<b>GEV No.</b>	505351	<b>Ref. No.</b>	20660527
<b>description</b>	wire clamp ø 11.6-12.2mm wire gauge ø 1.5mm zinc-coated steel Qty 100 pcs		
<b>For models:</b>	CD101, CD102, CD201, CD202, CD61, CM101, CM102, CM201, CM202, CM61, CM62, CPC101, CPC102, CPC201, CPC202, CPC61, SCC101, SCC102, SCC201, SCC202, SCC61, SCC62		

			
1			
<b>GEV No.</b>	505358	<b>Ref. No.</b>	2066.0530
<b>description</b>	wire clamp ø 14.4-15.1mm wire gauge ø 1.8mm zinc-coated steel Qty 50 pcs		
<b>For models:</b>	CD101, CD102, CD201, CD202, CD61, CM101, CM102, CM201, CM202, CM61, CM62, CPC101, CPC102, CPC201, CPC202, CPC61, SCC101, SCC102, SCC201, SCC202, SCC61, SCC62		

## consumables

### sealants and adhesives

#### high temperature silicone

			
1			
<b>GEV No.</b>	890107	<b>Ref. No.</b>	5006.0207
<b>description</b>	high temperature silicone TOMABOND TB76 -40 up to +250°C red/brown tube 90ml		
<b>description</b>	Tomabond TB76 - tube 90ml - red brown Special elastic silicone for general bonding & sealing applications with high thermal loads. TB 76 is primarily used in building services, HVAC and mechanical engineering. Temperature-resistant to 300 °C over the short term		

#### food-grade silicones

			
1			
<b>GEV No.</b>	890106	<b>Ref. No.</b>	5006.0200 5006.0202
<b>description</b>	silicone TB40 transparent tube 90g -40 up to +160°C		
<b>description</b>	Tomabond - TB40 - tube 90g - transparent For flexible sealing in drinking water, food, water and industrial kitchen areas. Securely joins glass, metal, wood-based materials, ceramic and plastics with high adhesion (1.1 N/mm <sup>2</sup> ). Fungicide-, algicide- and solvent-free, ageing-resistant. Temperature-resistant from -40 °C to +160 °C Tested and approved by KTW / KSW.		
<b>For models:</b>	CC101, CC201, CC6, CCC101, CCC102, CCC61, CCD101, CCD102, CCD61, CCM101, CCM102, CCM61, CD101, CD102, CD20, CD201, CD202, CD61, CM101, CM102, CM201, CM202, CM61, CM62, CPC101, CPC102, CPC201, CPC202, CPC61		

#### screw fixings

			
1			
<b>GEV No.</b>	890137	<b>Ref. No.</b>	2001.0040 2001.0042
<b>description</b>	screw fixing LOCTITE 243 medium-strength bottle 5ml		
<b>description</b>	LOCTITE® 243™ - bottle 5ml Is a general purpose threadlocker of medium bond strength. This threadlocker secures and seal bolts, nuts and studs to prevent loosening due to vibration. The product works on all metals, including passive substrates such as stainless steel, aluminium and plated surfaces. It is proven to be tolerant of minor contamination due to industrial oils, e.g. engine oils, corrosion prevention oils and cutting fluids.		
<b>For models:</b>	CC101, CC201, CC6, CCC101, CCC102, CCC61, CCD101, CCD102, CCD61, CCM101, CCM102, CCM61, CD101, CD102, CD20, CD201, CD202, CD61, CM101, CM102, CM201, CM202, CM61, CPC101, CPC102, CPC201, CPC202, CPC61, SCC201, SCC202		

			
1			
<b>GEV No.</b>	890064	<b>Ref. No.</b>	2001.0046
<b>description</b>	screw fixing LOCTITE 272 high-strength bottle 50ml t.max. 200°C		
<b>description</b>	LOCTITE® 272™ - bottle 50ml Designed for the permanent locking and sealing of threaded fasteners. The product cures when confined in the absence of air between close fitting metal surfaces and prevents loosening and leakage from shock and vibration. Typical applications include the locking and sealing of large bolts and studs (M25 and larger).		
<b>For models:</b>	CM201, CM202, SCC201, SCC202		



PTFE tapes



<b>GEV No.</b>	890100	<b>Ref. No.</b>	5012.0524
<b>description</b>	PTFE tape reel L 12m W 12mm -200 up to +260°C approval DIN-DVGW, KTW temperature-resistant, elastic for fine thread thickness 0.1mm		
<b>description</b>	PTFE thread sealing tape for fine metal threads Application: All sanitary and heating circuits in hot and cold water areas. DVGW tested. DIN EN751-3. For fine thread DN < 10. Pressure: up to 20 bar. Temperature range: -60°C to +260°C		
<b>For models:</b>	CM101, CM201, CM62		

cleaning agents

combi-steamer detergents/descalers

*Notice: Articles labelled 'DANGEROUS GOODS' are delivered by road through a forwarder for reasons of safety and are charged separately!*



<b>GEV No.</b>	802060	<b>Ref. No.</b>	40-101072 56.00.562
<b>description</b>	descaler for combi-steamer RATIONAL CleanJet 150 tablets of 40g tablets SelfCooking Center		
<b>description</b>	Rational descaler - 6 kg (150 tables of 40g) RATIONAL Care Tabs for descaling and maintaining the Rational SelfCooking Center SCC with CareControl (from year of manufacture: 10/2008) Effectively removes soiling and limescale. Special limescale dissolving agents in the Care Tabs prevent limescale deposits right when they are formed. Innovative care substances actively protect and lengthen the service life of your Rational SelfCookingCenter®. - Top cleaning results - Maximum yield - Ideal long-lasting care - maximum operational reliability - Reliable hygiene for food safety - Minimal costs of cleaning and maintenance		



<b>GEV No.</b>	802186	<b>Ref. No.</b>	40-101886 9006.0136
<b>description</b>	detergent for combi-steamer 10 litres		
<b>description</b>			



<b>GEV No.</b>	802165	<b>Ref. No.</b>	40-101070 56.00.210
<b>description</b>	detergent for combi-steamer RATIONAL CleanJet 100 tablets of 60g tablets		
<b>description</b>	Rational detergent - 6kg (100 tabs of 60g) The RATIONAL detergent tabs are designed for cleaning the Rational SelfCooking Center with and without CareControl. The detergent tabs have a new intensive active agent complex to guarantee maximum cleaning power at all times. They are highly concentrated and hence have a high yield. - Effectively removes soiling - Top cleaning results - Maximum yield - Ideal long-lasting care - maximum operational reliability - Reliable hygiene for food safety - Minimal costs of cleaning and maintenance		





<b>GEV No.</b>	802185	<b>Ref. No.</b>	40-101887 9006.0137
<b>description</b>	rinse aid for combi-steamer 10 litres		
<b>description</b>			





			
1			
<b>GEV No.</b>	802166	<b>Ref. No.</b>	40-101071 56.00.211
<b>description</b>	rinse aid tabs for combi-steamer RATIONAL CleanJet 50 tablets of 60g tablets		
<b>description</b>	Rational rinse aid - 3kg (50 tabs of 60g) Rinse aid tabs are individually adapted to the requirements for optimal maintenance of the SelfCooking Center® without CareControl and meet the most stringent quality requirements. Rinse aid tab yield is up to 100% higher than with liquid rinse aids.		

descalers			
			
1			
<b>GEV No.</b>	890045	<b>Ref. No.</b>	6006.0110
<b>description</b>	descaler RATIONAL descaler 10 litres		
<b>For models:</b>	CC101, CC201, CC6, CCC101, CCC102, CCC61, CCD101, CCD102, CCD61, CCM101, CCM102, CCM61, CD101, CD102, CD201, CD202, CD61, CM101, CM102, CM201, CM202, CM61, CPC101, CPC102, CPC201, CPC202, CPC61		

fuses			
fine fuses			
			
1			
<b>GEV No.</b>	358677	<b>Ref. No.</b>	30190112
<b>description</b>	fine fuse size ø5x20mm 4A fast-acting rated 250V Qty 10 pcs		
<b>For models:</b>	CM101, CM102, CM201, CM62, CPC102, CPC201		

			
1			
<b>GEV No.</b>	358597	<b>Ref. No.</b>	3019.0400
<b>description</b>	fine fuse size ø5x20mm 0.5A slow-acting rated 250V Qty 10 pcs		
<b>For models:</b>	CC101, CC201, CC6, CD101, CD20, CD201, CM101, CM201, CM62		

			
1			
<b>GEV No.</b>	358603	<b>Ref. No.</b>	3019.0120
<b>description</b>	fine fuse size ø5x20mm 2A slow-acting rated 250V Qty 10 pcs		
<b>For models:</b>	CC101, CC201, CC6, CM101, CM102, CM201, CM202, CM61, CPC101, CPC102, CPC201, CPC202, CPC61		

			
1			
<b>GEV No.</b>	358607	<b>Ref. No.</b>	3019.0200
<b>description</b>	fine fuse size ø5x20mm 6.3A slow-acting rated 250V Qty 10 pcs		
<b>For models:</b>	CD101, CD20, CD201, CM201		

ø5x30mm 500V			
			
1			
<b>GEV No.</b>	358735	<b>Ref. No.</b>	4001.0218
<b>description</b>	fine fuse size ø5x30mm 6.3A medium lag rated 500V Qty 10 pcs		
<b>For models:</b>	CCC101, CCC102, CCC201, CCC61, CCD101, CCD102, CCD201, CCD202, CCD61, CCM101, CCM102, CCM201, CCM61		

ø6.3x32mm 250V			
			
1			
<b>GEV No.</b>	358792	<b>Ref. No.</b>	4001.0225
<b>description</b>	fine fuse size ø6.3x32mm 10A slow-acting rated 250V Qty 10 pcs		
<b>For models:</b>	CD101, CD102, CD201, CD61, CM101, CM102, CM201, CM61, CPC101, CPC102, CPC201, CPC61		

			
1			
<b>GEV No.</b>	358791	<b>Ref. No.</b>	4001.0224
<b>description</b>	fine fuse size ø6.3x32mm 6.3A slow-acting rated 250V Qty 10 pcs		
<b>For models:</b>	CD101, CD102, CD201, CD202, CD61, CM101, CM102, CM201, CM202, CM61, CM62, CPC101, CPC102, CPC201, CPC202, CPC61, SCC101, SCC102, SCC201, SCC202, SCC61, SCC62		

screw locks

D0-system (NEOZED)



1			
<b>GEV No.</b>	358043	<b>Ref. No.</b>	3019.0401
<b>description</b>	fuse size D01 16A rated 250/400V E14 ø 11mm L 36mm Qty 10 pcs		
<b>For models:</b>	CCC202, CCD202, CCM202, CD102, CD201, CD202, CM101, CM102, CM201, CM202, CM61, CPC101, CPC102, CPC201, CPC202, CPC61		



1			
<b>GEV No.</b>	358044	<b>Ref. No.</b>	3019.0402
<b>description</b>	fuse size D02 25A rated 250/400V E18 ø 15mm L 36mm Qty 10 pcs		
<b>For models:</b>	CD202, CM202, CPC202		



1			
<b>GEV No.</b>	358045	<b>Ref. No.</b>	3019.0403
<b>description</b>	fuse size D02 35A rated 250/400V E18 ø 15mm L 36mm Qty 10 pcs		
<b>For models:</b>	CD20		



1			
<b>GEV No.</b>	358046	<b>Ref. No.</b>	3019.0404
<b>description</b>	fuse size D02 50A rated 250/400V E18 ø 15mm L 36mm Qty 10 pcs		
<b>For models:</b>	CCC202, CCD202, CCM202, CD20, CD202, CM202, CPC202		



1			
<b>GEV No.</b>	358047	<b>Ref. No.</b>	3019.0405
<b>description</b>	fuse size D02 63A rated 250/400V E18 ø 15mm L 36mm Qty 10 pcs		
<b>For models:</b>	CD202, CM202, CPC202, SCC202		

gauge pieces (NEOZED)



1			
<b>GEV No.</b>	358064	<b>Ref. No.</b>	4001.1238
<b>description</b>	gauge piece size D02 suitable for 16A		
<b>For models:</b>	CCC202, CCD202, CCM202, CD202, CM202, CPC202		



1			
<b>GEV No.</b>	358066	<b>Ref. No.</b>	4001.1239
<b>description</b>	gauge piece size D02 suitable for 25A		
<b>For models:</b>	CD202, CM202, CPC202		



1			
<b>GEV No.</b>	358067	<b>Ref. No.</b>	4001.1240
<b>description</b>	gauge piece size D02 suitable for 35A		
<b>For models:</b>	CD20		



1			
<b>GEV No.</b>	358068	<b>Ref. No.</b>	4001.1241
<b>description</b>	gauge piece size D02 suitable for 50A		
<b>For models:</b>	CCC202, CCD202, CCM202, CD20, CD202, CM202, CPC202		

<b>A</b>			
alarm devices	23		
appliance hose reels	116		
axial fans	50		
<b>B</b>			
bar burners	75		
bi-metal thermostats	10, 10		
<b>C</b>			
cable glands	67, 67		
cables	67		
cam switches	14		
cap nuts	134		
castors and bumper angles	102		
clamps	130, 137		
cleaning agents	140		
cleaning tools	132		
combi-steamer detergents/descalers	140		
condensators & interference suppression filters	63		
connection cables	67		
consumables	139		
contactors	24		
control equipment	17		
control thermostats	10		
countersunk screws	132		
cross flow fans	52		
cylinder head bolts	134		
<b>D</b>			
descalers	141		
door catches	99		
door seals	104		
dosing pumps	118		
double wire clamps	131, 138		
drain pumps	62		
drain systems and wash basins	129		
<b>E</b>			
edgemount latches	98		
electric accessories	67		
electric timers	23		
electrodes	49		
electronic controllers	35		
<b>F</b>			
fans	50		
fasteners	137		
fastening material	132		
female fastons	68		
filters	64		
fine fuses	141		
		float switches	14
		flow sensors	50
		foam rubber gaskets	110
		food-grade silicones	130, 139
		forced air burners	76
		formed hoses	125
		fuses	65, 141
<b>G</b>			
		gas burners	75
		gas control valves	70
		gas hoses	76
		gaskets for control panels	108
		gaskets for heated units	103
		gaskets for tray rack trolleys	107
		grates	103
<b>H</b>			
		halogen lamp	20
		handle latches	98
		heating elements	3
		heating elements for convection	5
		hexagonal nuts	134
		hexagonal screws	132
		high temperature silicone	139
		hose clamps	130, 137
		hose connectors	128, 129
		hose couplings	118
		hose reels	116
		hoses	118
		hot air motors	52
		HT drain pipes	129
<b>I</b>			
		ignition boxes	72
		immersion heating elements	3
		indicator lights	18
		indicator lights (complete)	19
		industrial hoses	118
<b>L</b>			
		lamps	18
		light bulbs	20
<b>M</b>			
		magnetic switches	15
		microswitches	14
		motors	61
<b>N</b>			
		neon light bulbs	19, 19
		nuts	134

**O**

operating capacitors	63
O-rings	109
oven lamps	20

**P**

plug connectors	68
pre-rinse hoses	118
pressure switches	48, 76
probes	36
PTFE tapes	77, 130, 140
pumps	61
push/momentary push switches	13
PVC supply hoses	118

**R**

radial fans	59
relays	33
rivets/rivet nuts	132
rotary switches	15

**S**

safety thermostats	11
screw fixings	139
screw locks	142
screws	132
sealants and adhesives	139
sealing cords	111
sealing washers	109
shaft gaskets	111
shelves and shelf rails	103
silicone	130, 139
silicone hoses	118
snap locks	99
solenoid valves	44
solid state relays	32
spray guns	114
spray guns with external thread	114
spring rings	135
spring washers	136, 136
stainless steel flexi hoses	118
supply hoses	118
surface burners	75
switches and momentary switches	13

**T**

terminals	69
terminals and connectors	68
thermostats	10
threaded cable glands	67
time relays	33
timers	23

tools	132
tooth lock washers	137
transformers	34
turning lever locks	93

**U**

union nuts	135
------------	-----

**V**

vibration pumps	63
-----------------	----

**W**

walk-in fridge catches	99
wash and rinse pumps	61
washers	136
window seals	103