



GAS COMPONENTS



ELECTRIC COMPONENTS



WATER TECHNOLOGY



MECHANICAL COMPONENTS



TOOLS

Spare parts suitable for

RHIMA

Find the complete and up-to-date range of products in our GEV Webshop



Manufacturer catalogue

The most important spare parts and accessories arranged clearly for every manufacturer

- ✓ Complete product range and all appliance data always up to date in the GEV Webshop
- ✓ Alphabetical Index at the end of the catalogue

GEV Webshop

www.gev-online.co.uk

www.gev-online.com





- 🔍 Add to Favourites
- 🔍 Sign In with email address and usual password
- 🔍 Easy-order – place several items in your basket at the same time
- 🔍 Quick Item search – no login needed





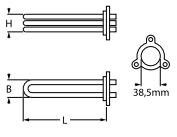

heating elements

immersion heating elements

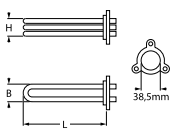
3 hole flange ø38.5mm



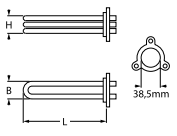

 			
GEV No.	415261	Ref. No.	18206
description	heating element 2400W 230V mounting ø 38.5mm heating circuits 1 L 242mm W 31mm H 22mm number of thermostat sleeves 1 thermostat sleeves ø 7.5mm length thermostat sleeves 180mm thermostat sleeve eccentric, non clinging tube ø 6.3mm hole distance 57mm hole ø 10mm cable length 130mm 3 hole flange connection male faston 6.3mm immersion heater		
spare parts for	415261		
	GEV No.	521120	Ref. No. —
	O-ring EPDM thickness 5.34mm ID ø 37.47mm Qty 1 pcs		
accessories for	415261		
	GEV No.	532577	Ref. No. —
	O-ring EPDM thickness 5.34mm ID ø 40.65mm Qty 1 pcs		

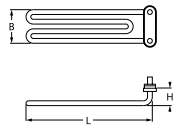
 			
GEV No.	416277	Ref. No.	50200045 50300046
description	heating element 2800W 230V mounting ø 38.5mm heating circuits 1 L 302mm W 37mm H 28mm number of thermostat sleeves 1 thermostat sleeves ø 7mm length thermostat sleeves 199mm thermostat sleeve not clinging tube ø 6.4mm hole distance 57mm hole ø 10mm cable length 114mm 3 hole flange connection 26 immersion heater		
accessories for	416277		
	GEV No.	532577	Ref. No. —
	O-ring EPDM thickness 5.34mm ID ø 40.65mm Qty 1 pcs		

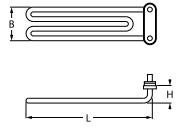
 			
GEV No.	416398	Ref. No.	18215
description	heating element 4000W 230V mounting ø 38.5mm heating circuits 3 L 287mm W 26mm H 34mm number of thermostat sleeves 1 thermostat sleeves ø 7mm length thermostat sleeves 255mm thermostat sleeve centred, adjacent tube ø 6.3mm hole distance 57mm hole ø 10mm 3 hole flange connection male faston 6.3mm immersion heater		
accessories for	416398		
	GEV No.	521120	Ref. No. —
	O-ring EPDM thickness 5.34mm ID ø 37.47mm Qty 1 pcs		

with compression flange 62 x 26mm			
 			
GEV No.	415268	Ref. No.	50300061
description	heating element 1850-2020W 230-240V heating circuits 1 expansion flange flange 62x26mm L 245mm W 40mm H 25mm tube ø 6.5mm connection male faston 6.3mm immersion heater		

 			
GEV No.	415270	Ref. No.	50300040
description	heating element 2700W 230V heating circuits 1 compression flange flange 62x26mm L 335mm W 43mm H 25mm tube ø 6.3mm connection male faston 6.3mm immersion heater		

with compression flange 70 x 26mm			
 			
GEV No.	415000	Ref. No.	230088
description	heating element 2900W 230V heating circuits 1 flange 70x26mm L 272mm W 51mm H tube ø 6.3mm connection M4 immersion heater compression flange		
spare parts for	415000		
	GEV No.	521128	Ref. No. —
	gasket L 66mm W 21mm ømm for heating element suitable for ELETTOBAR, WOLK		
accessories for	415000		
	GEV No.	521128	Ref. No. —
	gasket L 66mm W 21mm ømm for heating element suitable for ELETTOBAR, WOLK		

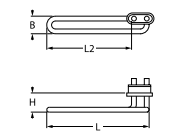
with expansion flange 40 x 14mm			
 			
GEV No.	416276	Ref. No.	50200041 50300041
description	heating element 1100W 230V flange 40x14mm L 203mm W 40mm H 27mm heating circuits 1 connection male faston 6.3mm immersion heater		

electric components



with round flange ø47.5mm



GEV No.	415260	Ref. No.	16036/A
description	heating element 2180/2370W 230/240V heating circuits 1 mounting ø 47.5mm L 185mm W 40mm H 36mm round flange cable length 130mm immersion heater tube ø 6.3mm thermostat sleeves ø 7mm number of thermostat sleeves 1 length thermostat sleeves 165mm		
accessories for	415260		
	GEV No.	510408	Ref. No. 50700046
	O-ring EPDM thickness 5.34mm ID ø 47mm Qty 1 pcs		
	GEV No.	520235	Ref. No. —
	3 hole flange hole distance 70.5mm perforation ø 6.5mm ID ø 53.5mm		
	GEV No.	520236	Ref. No. —
	flange for heating element ID ø 50mm ED ø 90mm hole ø 6.5mm 3 holes		
	GEV No.	521012	Ref. No. —
	gasket graphite ED ø 15mm ID ø 5mm thickness 1.2mm Qty 1 pcs		
	GEV No.	550002	Ref. No. —
	tension strap H 10mm L 21mm W 10mm hole ø 6.5mm for heating element		
	GEV No.	550362	Ref. No. —
	blind flange ø 64mm mounting ø 47.5mm		



GEV No.	415269	Ref. No.	50300037 50300056
description	heating element 2700W 230V heating circuits 3 mounting ø 47.5mm L 257mm W 28mm H 45mm round flange connection male faston 6.3mm immersion heater tube ø 6.3mm H1 11mm H2 34mm connection length 28mm		
accessories for	415269		
	GEV No.	510408	Ref. No. 50700046
	O-ring EPDM thickness 5.34mm ID ø 47mm Qty 1 pcs		
	GEV No.	510562	Ref. No. —
	O-ring silicone thickness 5.34mm ID ø 47mm Qty 1 pcs		
	GEV No.	520235	Ref. No. —
	3 hole flange hole distance 70.5mm perforation ø 6.5mm ID ø 53.5mm		
	GEV No.	520236	Ref. No. —
	flange for heating element ID ø 50mm ED ø 90mm hole ø 6.5mm 3 holes		
	GEV No.	521012	Ref. No. —
	gasket graphite ED ø 15mm ID ø 5mm thickness 1.2mm Qty 1 pcs		
	GEV No.	550002	Ref. No. —
	tension strap H 10mm L 21mm W 10mm hole ø 6.5mm for heating element		
	GEV No.	550362	Ref. No. —
	blind flange ø 64mm mounting ø 47.5mm		





GEV No.	415262	Ref. No.	50300036
description	heating element 3000W 230V heating circuits 3 mounting ø 47.5mm L 260mm W 40mm H 36mm round flange connection male faston 6.3mm immersion heater tube ø 6.3mm thermostat sleeves ø 7mm number of thermostat sleeves 1 length thermostat sleeves 250mm thermostat sleeve upper centre not clinging		
accessories for	415262		
	GEV No.	510408	Ref. No. 50700046
	O-ring EPDM thickness 5.34mm ID ø 47mm Qty 1 pcs		
	GEV No.	510562	Ref. No. —
	O-ring silicone thickness 5.34mm ID ø 47mm Qty 1 pcs		
	GEV No.	520235	Ref. No. —
	3 hole flange hole distance 70.5mm perforation ø 6.5mm ID ø 53.5mm		
	GEV No.	520236	Ref. No. —
	flange for heating element ID ø 50mm ED ø 90mm hole ø 6.5mm 3 holes		
	GEV No.	521012	Ref. No. —
	gasket graphite ED ø 15mm ID ø 5mm thickness 1.2mm Qty 1 pcs		
	GEV No.	550002	Ref. No. —
	tension strap H 10mm L 21mm W 10mm hole ø 6.5mm for heating element		
	GEV No.	550362	Ref. No. —
	blind flange ø 64mm mounting ø 47.5mm		





GEV No.	415263	Ref. No.	— 50200038 50300038
description	heating element 4500W 230V heating circuits 3 mounting ø 47.5mm L 375mm W 38mm H 46mm round flange connection male faston 6.3mm immersion heater tube ø 6.3mm thermostat sleeves ø 7mm number of thermostat sleeves 1 length thermostat sleeves 240mm thermostat sleeve not clinging		
accessories for	415263		
	GEV No.	510408	Ref. No. 50700046
	O-ring EPDM thickness 5.34mm ID ø 47mm Qty 1 pcs		
	GEV No.	520235	Ref. No. —
	3 hole flange hole distance 70.5mm perforation ø 6.5mm ID ø 53.5mm		
	GEV No.	520236	Ref. No. —
	flange for heating element ID ø 50mm ED ø 90mm hole ø 6.5mm 3 holes		
	GEV No.	521012	Ref. No. —
	gasket graphite ED ø 15mm ID ø 5mm thickness 1.2mm Qty 1 pcs		
	GEV No.	550002	Ref. No. —
	tension strap H 10mm L 21mm W 10mm hole ø 6.5mm for heating element		
	GEV No.	550362	Ref. No. —
	blind flange ø 64mm mounting ø 47.5mm		





			
GEV No.	419040	Ref. No.	50300045
description	heating element 6000/6530W 230/240V heating circuits 3 mounting ø 47.5mm L 375mm W 38mm H 39mm round flange connection male faston 6.3mm immersion heater tube ø 6.3mm thermostat sleeves ø 7mm number of thermostat sleeves 1 length thermostat sleeves 240mm thermostat sleeve eccentric, non clinging		

			
GEV No.	416278	Ref. No.	15089/A
description	heating element 6000W 230V heating circuits 3 mounting ø 47.5mm L 435mm W 38mm H 38mm round flange connection male faston 6.3mm immersion heater tube ø 6.3mm thermostat sleeves ø 7mm number of thermostat sleeves 1 length thermostat sleeves 236mm thermostat sleeve eccentric, non clinging		

accessories for	416278		
	GEV No.	510408	Ref. No. 50700046
	O-ring EPDM thickness 5.34mm ID ø 47mm Qty 1 pcs		
	GEV No.	510562	Ref. No. —
	O-ring silicone thickness 5.34mm ID ø 47mm Qty 1 pcs		
	GEV No.	520235	Ref. No. —
	3 hole flange hole distance 70.5mm perforation ø 6.5mm ID ø 53.5mm		
	GEV No.	520236	Ref. No. —
	flange for heating element ID ø 50mm ED ø 90mm hole ø 6.5mm 3 holes		
	GEV No.	550002	Ref. No. —
	tension strap H 10mm L 21mm W 10mm hole ø 6.5mm for heating element		
	GEV No.	550362	Ref. No. —
	blind flange ø 64mm mounting ø 47.5mm		

with round flange ø57.5mm			
			
GEV No.	416279	Ref. No.	30001011/A
description	heating element 12000W 230V heating circuits 3 mounting ø 57.5mm L 470mm W 48mm H 34mm round flange connection M5 immersion heater tube ø 8.5mm connection length 30mm thermostat sleeves ø 7mm number of thermostat sleeves 1 length thermostat sleeves 295mm thermostat sleeve eccentric, non clinging		
accessories for	416279		
	GEV No.	550002	Ref. No. —
	tension strap H 10mm L 21mm W 10mm hole ø 6.5mm for heating element		

			
GEV No.	415264	Ref. No.	50300042
description	heating element 6000W 230V heating circuits 3 mounting ø 57.5mm L 480mm W 33mm H 42mm round flange connection M5 immersion heater tube ø 8.5mm connection length 19mm thermostat sleeves ø 7.5mm number of thermostat sleeves 1 length thermostat sleeves 268mm thermostat sleeve not clinging		
spare parts for	415264		
	GEV No.	510409	Ref. No. 50700015 50700016
	O-ring EPDM thickness 5.34mm ID ø 56.52mm Qty 1 pcs		

accessories for	415264		
	GEV No.	550002	Ref. No. —
	tension strap H 10mm L 21mm W 10mm hole ø 6.5mm for heating element		

			
GEV No.	415265	Ref. No.	50300043
description	heating element 9000W 230V heating circuits 3 mounting ø 57.5mm L 470mm W 35mm H 41mm round flange connection M5 immersion heater tube ø 8.5mm connection length upper centre not clinging-mm thermostat sleeves ø 7.5mm number of thermostat sleeves 1 length thermostat sleeves 295mm		

spare parts for	415265		
	GEV No.	510409	Ref. No. 50700015 50700016
	O-ring EPDM thickness 5.34mm ID ø 56.52mm Qty 1 pcs		

accessories for	415265		
	GEV No.	550002	Ref. No. —
	tension strap H 10mm L 21mm W 10mm hole ø 6.5mm for heating element		

			
GEV No.	420444	Ref. No.	50300050
description	heating element 1800W 230V heating circuits 1 L 205mm W 58mm H 18mm thread M14x1 mounting distance 60mm tube ø 8.5mm tank warewashing		

thermostats

bi-metal thermostats

safety bi-metal thermostats

			
GEV No.	390480	Ref. No.	51010001
description	bi-metal safety thermostat hole distance 23.8mm switch-off temp. 105°C 1NC 1-pole 16A connection F6.3 2 hole fixing		



control and safety thermostats

EGO

safety thermostats

55.32_ series



GEV No.	390244	Ref. No.	5315797
description	safety thermostat switch-off temp. 120°C 3-pole 20A probe ø 6mm probe L 94mm capillary pipe 540mm capillary pipe isolated 500mm gland nut probe SS		

IMIT / TEMPOMATIC / ARTHERMO

control thermostats



GEV No.	390421	Ref. No.	929107
description	thermostat t.max. 85°C temperature range 0-90°C 1-pole 1CO 16A probe ø 6.5mm probe L 95mm capillary pipe 1500mm capillary pipe isolated 1450mm gland nut shaft ømm shaft Lmm shaft position rotation 270° probe material copper		

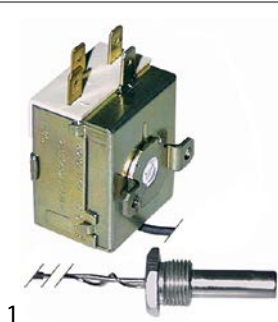

GEV No.	390310	Ref. No.	236042
description	thermostat t.max. 85°C temperature range fixed 55°C 1-pole 1CO 16A probe ø 9.5mm probe L 37mm capillary pipe 600mm capillary pipe isolated 540mm gland nut shaft ømm shaft Lmm shaft position rotation° screw-in probe probe thread 3/8" probe material SS		
accessories for	390310		
	GEV No.	Ref. No.	—
	nut thread 3/8" H 6mm SS WS 22 Qty 1 pcs		
	GEV No.	Ref. No.	—
	flat gasket FIBER ED ø 22mm ID ø 16.5mm thickness 2mm for thread 3/8" Qty 1 pcs		

GEV No.	390192	Ref. No.	10707/2
description	thermostat t.max. 90°C temperature range 0-90°C 1-pole 1CO 16A probe ø 6.5mm probe L 95mm capillary pipe 2000mm capillary pipe isolated 2000mm gland nut shaft ø 6x4.6mm shaft L 19mm shaft position upper° rotation 270° probe material copper		

GEV No.	390460	Ref. No.	DR50
description	thermostat t.max. 90°C temperature range 30-90°C 1-pole 1CO 16A probe ø 6.5mm probe L 95mm capillary pipe 2000mm capillary pipe isolated 1950mm gland nut shaft ømm shaft Lmm shaft position rotation 270° probe material copper		

various control thermostats

GEV No.	390188	Ref. No.	51000005
description	thermostat t.max. 90°C temperature range 0-90°C 1-pole		

GEV No.	390194	Ref. No.	51010006
description	safety thermostat switch-off temp. 90-110°C 1-pole 16A probe ø 6.5mm probe L 87mm capillary pipe 1500mm capillary pipe isolated 1497mm connection male faston 6.3mm adjustable		

switches and momentary switches

microswitches

lever actuated

GEV No.	345257	Ref. No.	50900015
description	microswitch with lever 250V 16A 1CO connection male faston 6.3mm L 29mm L1 33mm ambient temperature max. 120°C mounting distance 22mm actuating force: 130g lever length 31.5mm		



roller actuated			
roller 90°			
 <p>1</p>			
GEV No.	347096	Ref. No.	50900025
description	microswitch with roller plunger 250V 20A 1CO connection screw L1 49mm ambient temperature max. 125°C thread L 14.5mm thread M12x1 mounting distance 25mm actuating force: 370g type Z15G1318		

system switches (ROLD)

 <p>1</p>			
GEV No.	345721	Ref. No.	50900039
description	blank cap holder		

 <p>1</p>			
GEV No.	346249	Ref. No.	50905010
description	indicator light lens size 23x23mm green temperature		

 <p>1</p>			
GEV No.	345605	Ref. No.	50900019 50900038
description	switch 2CO 250V 16A connection male faston 6.3mm		

rotary switches

BREMAS			
A1200 series			
 <p>1</p>			
GEV No.	345909	Ref. No.	50900160
description	rotary switch		

producer-specific rotary switches			
DIHR / KROMO			
 <p>1</p>			
GEV No.	345911	Ref. No.	50900163
description	element holder blue-grey format round 0-3		

 <p>1</p>			
GEV No.	697909	Ref. No.	50900161
description	fastening angle for rotary switch plastic L 76mm W 31mm		

 <p>1</p>			
GEV No.	697910	Ref. No.	50900162
description	fixing plate for rotary switch L 80mm W 60mm thickness 1mm		

 <p>1</p>			
GEV No.	110731	Ref. No.	50900164
description	knob switch zero mark ø 29mm black shaft special		

magnetic switches

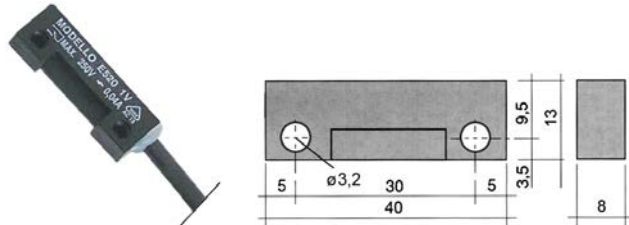
40x13mm			
 <p>1</p>			
GEV No.	345990	Ref. No.	50900017
description	magnetic switch L 40mm W 13mm 1NO 250V 0.04A P max. 10W connection male faston 6.3mm cable length 2000mm		



65x20mm



1

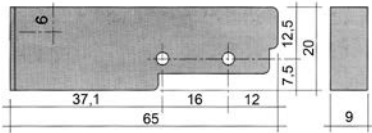

GEV No.	345116	Ref. No.	50940006 50940008
description	magnetic switch L 65mm W 20mm 1NO 250V 0.4A P max. 100W connection cable cable length 3000mm		
accessories for	345116		
	GEV No.	345399	Ref. No. —
	magnet ø 3.3mm L 40mm H 8mm W 13mm hole distance 30mm M3		

accessories

magnets

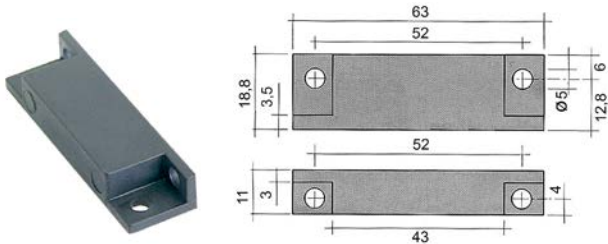

1

GEV No.	345336	Ref. No.	50940004
description	magnet ø 4.8mm L 63mm H 11mm W 18.8mm hole distance 51mm M4		

control equipment

ERSCE



1

GEV No.	345988	Ref. No.	3002054
description	contact block ERSCE C10B 1NO max 230V 10A green		

lamps

indicator lights

indicator lights 2-piece (lens and indicator lamp)

indicator lamps for socket type SRZ / SDK / SDY / SFK



1

GEV No.	359132	Ref. No.	50905012 50905027
description	indicator lamp green 250V connection male faston 6.3mm protection IP54 ambient temperature max. 85°C		

indicator lights (complete)

ø 6mm



1

GEV No.	359004	Ref. No.	10711
description	indicator light ø 6mm 230V green cable length 400mm temp.-resist. 106°C		

ø10mm

with plug-in socket



1

GEV No.	359139	Ref. No.	50905011
description	indicator light ø 10mm green 230V connection male faston 6.3mm Qty 1 pcs		

timers

programme timers





1

GEV No.	360273	Ref. No.	50930011
description	timer CDC 11803 engines 1 chambers 3 operation time 18min 230V shaft ømm shaft Lmm manuf. no. 11803F1 / 16064/A motor type M48R ATS		
spare parts for	360273		
	GEV No.	360118	Ref. No. —
	motor CDC pinion ø 4.9mm teeth 10 230V voltage AC 50/60Hz turn direction right motor ø 47mm H 19.3mm motor type M48R ATS for timer cable length 260mm 1.9/2.5W		





1

GEV No.	360290	Ref. No.	50930010
description	timer CDC 11804F engines 1 chambers 4 operation time 120s 230V shaft ømm shaft Lmm manif. no. 11804F1 / 10708T motor type M48R ATS connection F4.8		
spare parts for	360290		
	GEV No.	360118	Ref. No. —
	motor CDC pinion ø 4.9mm teeth 10 230V voltage AC 50/60Hz turn direction right motor ø 47mm H 19.3mm motor type M48R ATS for timer cable length 260mm 1.9/2.5W		





1

GEV No.	360389	Ref. No.	50930046
description	timer CDC 4904F engines 1 chambers 4 operation time 5min 230V shaft ømm shaft Lmm manif. no. 4904F3 / 10300122 motor type M48L ATS		
spare parts for	360389		
	GEV No.	360083	Ref. No. —
	motor CDC pinion ø 4.9mm teeth 10 230V turn direction left motor ø 47mm H 19.3mm motor type M48L ATS for timer		





1

GEV No.	360293	Ref. No.	50930008
description	timer CDC 7804DV engines 2 chambers 4 operation time 6s / 3min 230V shaft ømm shaft Lmm manif. no. 7804DV / 30001027 motor type M37RN/M37LN		
spare parts for	360293		
	GEV No.	360119	Ref. No. —
	motor CDC pinion ø 5.4mm teeth 12 230V turn direction right motor ø 37mm motor type M37RN for timer		
	GEV No.	360131	Ref. No. —
	motor CDC pinion ø 5.4mm teeth 12 230V turn direction left motor ø 37mm motor type M37LN for timer		





1

GEV No.	360134	Ref. No.	5036121
description	timer CDC 7804DV engines 2 chambers 4 operation time 6s / 3min 230V shaft ømm shaft Lmm manif. no. 7804DV / 360134 motor type M37RN/M37LN		
spare parts for	360134		
	GEV No.	360119	Ref. No. —
	motor CDC pinion ø 5.4mm teeth 12 230V turn direction right motor ø 37mm motor type M37RN for timer		
	GEV No.	360131	Ref. No. —
	motor CDC pinion ø 5.4mm teeth 12 230V turn direction left motor ø 37mm motor type M37LN for timer		





1

GEV No.	360295	Ref. No.	50930007
description	timer CDC 7805DV engines 2 chambers 5 operation time 6s / 4min 230V shaft ømm shaft Lmm manif. no. 7805DV / 22011 motor type M37RN/M37LN		
spare parts for	360295		
	GEV No.	360119	Ref. No. —
	motor CDC pinion ø 5.4mm teeth 12 230V turn direction right motor ø 37mm motor type M37RN for timer		
	GEV No.	360131	Ref. No. —
	motor CDC pinion ø 5.4mm teeth 12 230V turn direction left motor ø 37mm motor type M37LN for timer		



1

GEV No.	360294	Ref. No.	30001031
description	timer CDC 7806DV engines 2 chambers 6 operation time 6s / 3min 230V shaft ømm shaft Lmm manif. no. 7806DV / 30001031 motor type M37RN/M37LN		
spare parts for	360294		
	GEV No.	360119	Ref. No. —
	motor CDC pinion ø 5.4mm teeth 12 230V turn direction right motor ø 37mm motor type M37RN for timer		
	GEV No.	360131	Ref. No. —
	motor CDC pinion ø 5.4mm teeth 12 230V turn direction left motor ø 37mm motor type M37LN for timer		

1

GEV No.	360077	Ref. No.	50930009 50930045
description	timer CROUZET engines 1 chambers 2 operation time 120s 230V shaft ømm shaft Lmm manuf. no. 627/5261 motor type 82340		

LOVATO

power contactors



1

GEV No.	381102	Ref. No.	50910113
description	power contactor resistive load 20A 24VAC (AC3/400V) 9A/4kW main contacts 4NO auxiliary contacts connection screw connection type 11BG09T4A24		

contactors

GENERAL ELECTRIC (AEG)

power contactors



1

GEV No.	381154	Ref. No.	50910007
description	power contactor resistive load 32A 230VAC (AC3/400V) 17A/7.5kW main contacts 3NO auxiliary contacts 1NO connection screw connection type AEG type GE CL02A310R6		

relays

power relays

with bracket mounting



1

GEV No.	380139	Ref. No.	50910005 50910040
description	power relays FINDER 230VAC 16A 2CO connection F6.3 bracket mounting dimensions 68x38.2x35.8mm manuf. no. 62.82.8.230.0000		

ISKRA (FANAL)

power contactors



1

GEV No.	380213	Ref. No.	50910008 50910041
description	power contactor resistive load 20A 230VAC (AC3/400V) 8.5A/5.5kW main contacts 3NO auxiliary contacts 1NO connection screw connection type Fanal DSL7 10 type ISKRA K07M 10		

probes

producer-specific probes

probes



1

GEV No.	378248	Ref. No.	51020003
description	temperature probe NTC 10kOhm cable PVC probe -40 up to +110°C cable -10 up to 100°C connection coded plug thread probe ø6x14mm cable length 2m		



electronics

PCBs



			
1			
GEV No.	403893	Ref. No.	50920210
description	control		

			
1			
GEV No.	403891	Ref. No.	50920208
description	keypad PCB L 135mm W 30mm		

			
1			
GEV No.	402687	Ref. No.	50920006
description	PCB dishwasher DS40/DS50 for flow meter		

			
1			
GEV No.	402677	Ref. No.	50920003
description	PCB dishwasher DS40/DS50 L 161mm W 90mm		

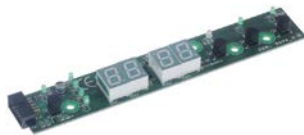
			
1			
GEV No.	402676	Ref. No.	50920115 50920119
description	PCB dishwasher HT11/12 L 102mm W 62mm timer		

			
1			
GEV No.	402675	Ref. No.	50920004
description	PCB dishwasher KD60 L 185mm W 30mm buttons 4		
accessories for	402675		
	GEV No.	400066	Ref. No.
			50320206 50820123 50920123 50920206
ribbon cable 10-pole L 1000mm plug type FC-10P raster size 2.54mm			

			
1			
GEV No.	403283	Ref. No.	50920205
description	PCB dishwasher Optima 400 L 190mm W 110mm with housing H 70mm Qty 1 pcs		

central units

			
1			
GEV No.	402681	Ref. No.	50920008
description	control box timer run-time 50/120/180s		

			
1			
GEV No.	402684	Ref. No.	50920002 50920118
description	control box without EPROM		



			
1			
GEV No.	379026	Ref. No.	50920001
description	electronic timer for dishwasher		

solenoid valves with reducers			
2-fold			
			
1			
GEV No.	370742	Ref. No.	51100024
description	solenoid valve double straight 230VAC inlet 3/4" outlet 11.5mm input 10-12l/min t.max. 60°C RPE plastic flow regulating valve inlet white 1NO/1NC		

keypads

front foils

			
1			
GEV No.	403256	Ref. No.	50920007
description	keypad foil dishwasher 20/29/83ELK 20S5 blue L 557mm W 36mm buttons 4		

			
1			
GEV No.	402685	Ref. No.	50920116 50920117
description	keypad foil dishwasher H63/373E/144E L 134mm W 79mm buttons 6		

			
1			
GEV No.	403289	Ref. No.	50920220
description	keypad foil dishwasher LP25/LP35/LP48/GR800/TwinStar blue L 200mm W 135mm buttons 6		

solenoid valves

solenoid valves (water)











RPE			
			
1			
GEV No.	374016	Ref. No.	51100008
description	solenoid valve single angled 230VAC inlet 3/4" outlet 13mm DN10 duty cycle 100% RPE polyamide		







TP			
			
1			
GEV No.	370021	Ref. No.	51100005
description	solenoid valve double straight 230VAC inlet 3/4" outlet 11.5mm DN10 TP flow regulating valve inlet white		
spare parts for	370021		
	GEV No.	371013	Ref. No. —
	solenoid coil TP 230VAC 50/60Hz		
accessories for	370021		
	GEV No.	371220	Ref. No. —
	reducer TP flow rate 3l/min red tolerance ±15%		
	GEV No.	371221	Ref. No. —
	reducer TP flow rate 5.5l/min yellow tolerance ±15%		
	GEV No.	371222	Ref. No. —
	reducer TP flow rate 6l/min grey tolerance ±15%		
	GEV No.	371223	Ref. No. —
	reducer TP flow rate 10l/min white tolerance ±15%		
	GEV No.	371224	Ref. No. —
	reducer TP flow rate 12l/min bronze tolerance ±15%		
	GEV No.	371225	Ref. No. —
	reducer TP flow rate 16l/min light brown tolerance ±15%		
	GEV No.	371226	Ref. No. —
	reducer TP flow rate 20l/min red tolerance ±15%		
	GEV No.	371230	Ref. No. —
	reducer TP flow rate 0.25l/min red tolerance ±25%		
	GEV No.	371231	Ref. No. —
	reducer TP flow rate 0.35l/min violet tolerance ±25%		
	GEV No.	371232	Ref. No. —
	reducer TP flow rate 0.5l/min orange tolerance ±25%		

Table continues overleaf



accessories for		370021		
GEV No.	Ref. No.	Ref. No.	Ref. No.	—
	371233	Ref. No.	—	reducer TP flow rate 0.8l/min white tolerance ±25%
	371234	Ref. No.	—	reducer TP flow rate 1l/min light blue tolerance ±25%
	371235	Ref. No.	—	reducer TP flow rate 1.2l/min brown tolerance ±25%
	371236	Ref. No.	—	reducer TP flow rate 1.5l/min light brown tolerance ±25%
	371237	Ref. No.	—	reducer TP flow rate 2.5l/min yellow tolerance ±25%
	371238	Ref. No.	51100007	reducer TP flow rate 3.4l/min dark green tolerance ±25%
	371239	Ref. No.	—	reducer TP flow rate 5l/min black tolerance ±25%
	371240	Ref. No.	—	reducer TP flow rate 8l/min blue tolerance ±20%

 <p>componenti per elettrodomestici</p>  <p>1</p>				
GEV No.	370017	Ref. No.	51100004	
description	solenoid valve single straight 230VAC inlet 3/4" outlet 11.5mm DN10 TP p max 10bar			
spare parts for	370017			
	GEV No.	371013	Ref. No.	—
solenoid coil TP 230VAC 50/60Hz				
accessories for	370017			
	GEV No.	371220	Ref. No.	—
reducer TP flow rate 3l/min red tolerance ±15%				
	GEV No.	371221	Ref. No.	—
reducer TP flow rate 5.5l/min yellow tolerance ±15%				
	GEV No.	371222	Ref. No.	—
reducer TP flow rate 6l/min grey tolerance ±15%				
	GEV No.	371223	Ref. No.	—
reducer TP flow rate 10l/min white tolerance ±15%				
	GEV No.	371224	Ref. No.	—
reducer TP flow rate 12l/min bronze tolerance ±15%				
	GEV No.	371225	Ref. No.	—
reducer TP flow rate 16l/min light brown tolerance ±15%				
	GEV No.	371226	Ref. No.	—
reducer TP flow rate 20l/min red tolerance ±15%				

accessories for		370017		
GEV No.	Ref. No.	Ref. No.	Ref. No.	—
	371230	Ref. No.	—	reducer TP flow rate 0.25l/min red tolerance ±25%
	371231	Ref. No.	—	reducer TP flow rate 0.35l/min violet tolerance ±25%
	371232	Ref. No.	—	reducer TP flow rate 0.5l/min orange tolerance ±25%
	371233	Ref. No.	—	reducer TP flow rate 0.8l/min white tolerance ±25%
	371234	Ref. No.	—	reducer TP flow rate 1l/min light blue tolerance ±25%
	371235	Ref. No.	—	reducer TP flow rate 1.2l/min brown tolerance ±25%
	371236	Ref. No.	—	reducer TP flow rate 1.5l/min light brown tolerance ±25%
	371237	Ref. No.	—	reducer TP flow rate 2.5l/min yellow tolerance ±25%
	371238	Ref. No.	51100007	reducer TP flow rate 3.4l/min dark green tolerance ±25%
	371239	Ref. No.	—	reducer TP flow rate 5l/min black tolerance ±25%
	371240	Ref. No.	—	reducer TP flow rate 8l/min blue tolerance ±20%

spare parts and accessories

reducers

outlet side

 <p>1</p>				
GEV No.	371238	Ref. No.	51100007	
description	reducer TP flow rate 3.4l/min dark green tolerance ±25%			



various



GEV No.	370636	Ref. No.	51100021
description	solenoid valve single CO 230VAC outlet 10.5mm MILANO 00168401 plastic 3-ways inlet 10.5mm 50/60Hz male faston 6.3mm		
accessories for	370636		
	GEV No.	371142	Ref. No. —
	reducer for solenoid valve ø 8.2mm		



metal

SIRAI

2-way

L140-B series



GEV No.	370320	Ref. No.	51110007 51110015
description	solenoid valve brass 2-ways 24VAC inlet 1/2" outlet 1/2" connection 1/2" L 41mm DN 10mm slide-on receptacle compact -10 up to +90°C SIRAI type series L140-B coil type Z610A membranes NBR (water) p max 12bar p min 0.35bar		
spare parts for	370320		
	GEV No.	371070	Ref. No. —
	solenoid coil 24VAC 10VA SIRAI coil type Z610A seat ø 10mm		
	GEV No.	371163	Ref. No. —
	membrane connection 1/2" series L140-B membrane type NBR (water)		
accessories for	370320		
	GEV No.	371091	Ref. No. —
	power socket plug type DIN 43650B cable lengthmm small		

pressure switches

for warewashing

ø 58mm with male faston 6.3mm

with connection horizontal



GEV No.	541975	Ref. No.	50990005
description	pressure control pressure range 190/60mbar connection 6mm ø 58mm pressure connection horizontal warewashing pressure connection ø 5.5mm		



GEV No.	541619	Ref. No.	50990004
description	pressure control pressure range 250/40mbar connection 6mm ø 58mm pressure connection ø 6mm		



GEV No.	541314	Ref. No.	50990007
description	pressure control pressure range 46/26mbar connection 6mm ø 58mm pressure connection horizontal warewashing pressure connection ø 6mm		



GEV No.	541140	Ref. No.	50890007
description	pressure control pressure range 55/30mbar connection 6mm ø 58mm pressure connection horizontal warewashing		





GEV No.	541311	Ref. No.	50990006
description	pressure control pressure range 76/38mbar connection 6mm ø 58mm pressure connection horizontal warewashing pressure connection ø 6mm		



pressure transmitters



1			
GEV No.	541149	Ref. No.	50990029
description	pressure transmitter pressure range 0-30mbar output voltage 0.5-3.5VDC input voltage 5VDC max 200mbar		

spare parts for	500440		
	GEV No.	510693	Ref. No. 50420004 50420034
	mechanical shaft seal for shaft \varnothing 12mm slide ring ext. \varnothing 24mm slide ring H 15.5mm slide ring int. \varnothing 11mm counter ring mounting \varnothing 24mm height counter ring 8mm counter ring int. \varnothing 13.5mm		
	GEV No.	521536	Ref. No. —
	pump cover ALBA / LGB inlet \varnothing 62mm outlet \varnothing 50mm auxiliary pressure connection 12mm supporting pressure closed turn direction right \varnothing 180mm ID \varnothing 150mm inner height 38mm		

flow meters and flow sensors

flow meters

miscellaneous







1			
GEV No.	402680	Ref. No.	51650002
description	flow meter pressure range 0.2-10bar connection 10mm L 69mm		

FIR

pumps



1			
GEV No.	501446	Ref. No.	500400080
description	pump inlet \varnothing 28mm outlet \varnothing 26mm type 4213E2250 220-240V 50Hz 1 phase 0.19kW 0.26HP L 190mm rotation direction left capacitor 5 μ F FIR		

spare parts for	501446		
	GEV No.	365017	Ref. No. 50980004
	operating capacitor capacity 5 μ F 450V tolerance 5% 50/60Hz ambient temperature max. -25 to +85°C \varnothing 28mm L 54mm M8 plastic connection male faston 6.3mm 16.10.08 protection		
	GEV No.	510384	Ref. No. —
	pump cover inlet \varnothing 28mm outlet \varnothing 26mm \varnothing 100mm ID \varnothing 76mm		
	GEV No.	510695	Ref. No. —
	mechanical shaft seal height counter ring 5.5mm ID \varnothing 11mm		
	GEV No.	521203	Ref. No. —
	impellor \varnothing 72mm H 18mm thread M7 shaft \varnothing 11mm shaft length 32mm blades 3		
	GEV No.	521703	Ref. No. —
	pump cover gasket EPDM thickness 2.5mm ID \varnothing 75mm Qty 1 pcs		

pumps

wash and rinse pumps

ALBA (C&A)

pumps



1			
GEV No.	500440	Ref. No.	50400089 (alternativ)
description	pump inlet \varnothing 62mm outlet \varnothing 50mm type C12950 230/400V 50Hz 3 phase 0.89kW 1.2HP L 315mm rotation direction right ALBA PUMPS (C&A)		
spare parts for	500440		
	GEV No.	510551	Ref. No. 50700022
	pump cover gasket ID \varnothing 158.3mm pump type 1214/1293/1225/2243/1226/1204/3473/1241 thickness 3.53mm EPDM Qty 1 pcs		







1

GEV No.	500527	Ref. No.	50400045
description	pump inlet \varnothing 60mm outlet \varnothing 50/30mm type 2233.B140 230V 50Hz 1 phase 0.55kW 0.75HP L 210mm rotation direction right capacitor 12.5 μ F FIR inlet \varnothing 60mm		
spare parts for	500527		
	GEV No.	365014	Ref. No. 50980007
	operating capacitor capacity 12.5 μ F 450V tolerance 5%Hz ambient temperature max. -25 to +85°C \varnothing 35mm L 70mm M8 plastic connection male faston 6.3mm 45S.C3DS.12.5 protection		
	GEV No.	510552	Ref. No. —
	pump cover gasket pump type 1292-2/3942/3981/3911/3983		
	GEV No.	510608	Ref. No. 50410024
	impellor \varnothing 93mm H 32mm shaft intake \varnothing 9/8mm blades 6 inner height 11mm		
	GEV No.	510692	Ref. No. —
	mechanical shaft seal for shaft \varnothing 11mm slide ring ext. \varnothing 24mm slide ring H 13mm counter ring mounting \varnothing 26mm height counter ring 8mm counter ring int. \varnothing 14mm		
	GEV No.	521511	Ref. No. 50430022
	pump cover inlet \varnothing 60mm outlet \varnothing 50/30mm supporting pressure M12x1.75 supporting pressure open pump type 2233 turn direction right \varnothing 160mm ID \varnothing 120mm inner height 23mm		





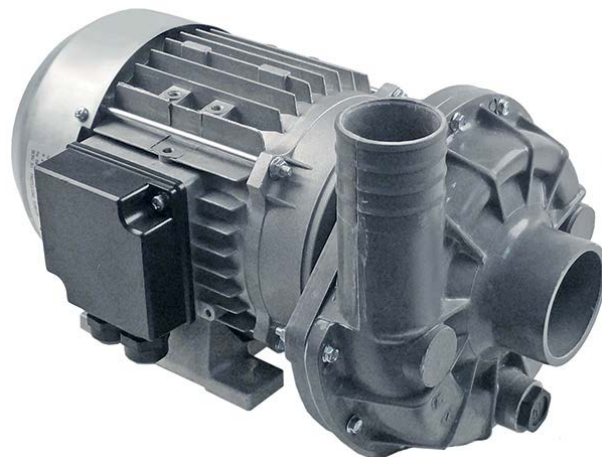

1

GEV No.	499139	Ref. No.	50400023
description	pump inlet \varnothing 62mm outlet \varnothing 62mm type 2275.2722 230/400V 50Hz 3 phase 2.6kW L 400mm rotation direction right FIR		
spare parts for	499139		
	GEV No.	510687	Ref. No. 50420007
	mechanical shaft seal for shaft \varnothing 18mm height counter ring 8mm ID \varnothing 17mm ED \varnothing 39mm H 15mm mounting \varnothing 42mm int. \varnothing 1 21mm		

spare parts for	499139		
	GEV No.	521026	Ref. No. 50700038
	pump cover gasket ID \varnothing 182.5mm thickness 5x4.5mm		
	GEV No.	521028	Ref. No. 50430032
	pump cover FIR inlet \varnothing 62mm outlet \varnothing 62mm turn direction right \varnothing 215mm ID \varnothing 175mm inner height 40mm		
	GEV No.	521277	Ref. No. 50410019
	impellor \varnothing 135mm H 39mm pump type Fir 2275 - 3.6HP thread M14L		
	GEV No.	524676	Ref. No. —
	fan wheel \varnothing 160mm shaft intake \varnothing 24mm plastic blades 12 W 30mm		



1

GEV No.	500029	Ref. No.	50400089
description	pump inlet \varnothing 63mm outlet \varnothing 47mm type 1295.2503 230/400V 50Hz 3 phase 0.88kW 1.2HP L 305mm rotation direction right FIR		
spare parts for	500029		
	GEV No.	510693	Ref. No. 50420004 50420034
	mechanical shaft seal for shaft \varnothing 12mm slide ring ext. \varnothing 24mm slide ring H 15.5mm slide ring int. \varnothing 11mm counter ring mounting \varnothing 24mm height counter ring 8mm counter ring int. \varnothing 13.5mm		
	GEV No.	521213	Ref. No. —
	impellor \varnothing 117mm H 24mm M8L		
	GEV No.	521513	Ref. No. 50430016
	pump cover FIR inlet \varnothing 63mm outlet \varnothing 47mm turn direction right ID \varnothing 150mm inner height 32mm		
	GEV No.	524416	Ref. No. —
	pump cover gasket thickness 4x4mm Qty 1 pcs		



1

GEV No.	501540	Ref. No.	50400043
description	pump inlet ø 63mm outlet ø 47mm type 422522726 230/400V 50Hz 3 phase 1.4kW 2HP L 280mm rotation direction right FIR		
spare parts for	501540		
	GEV No.	510602	Ref. No. 50410026
	impellor ø 110mm H 34mm rotation direction right thread M8L shaft ø 28mm seat ø 12.2mm blades 6		
	GEV No.	510693	Ref. No. 50420004 50420034
	mechanical shaft seal for shaft ø 12mm slide ring ext. ø 24mm slide ring H 15.5mm slide ring int. ø 11mm counter ring mounting ø 24mm height counter ring 8mm counter ring int. ø 13.5mm		
	GEV No.	521513	Ref. No. 50430016
	pump cover FIR inlet ø 63mm outlet ø 47mm turn direction right ID ø 150mm inner height 32mm		
	GEV No.	524416	Ref. No. —
	pump cover gasket thickness 4x4mm Qty 1 pcs		



1

GEV No.	500031	Ref. No.	50400026
description	pump inlet ø 63mm outlet ø 53mm type 1205.2528 230/400V 50Hz 3 phase 2kW 2.7HP L 330mm rotation direction left FIR		
spare parts for	500031		
	GEV No.	510357	Ref. No. 50410023
	impellor ø 124mm H 34/16mm thread M8R blades 6		
	GEV No.	510523	Ref. No. —
	fan wheel ø 142mm shaft intake ø 15mm blades 12		

spare parts for	500031		
	GEV No.	510531	Ref. No. —
	pump cover FIR inlet ø 63mm outlet ø 53mm auxiliary pressure connection M16x1.5mm supporting pressure open turn direction left ø 185mm ID ø 150mm inner height 37mm		
	GEV No.	510693	Ref. No. 50420004 50420034
	mechanical shaft seal for shaft ø 12mm slide ring ext. ø 24mm slide ring H 15.5mm slide ring int. ø 11mm counter ring mounting ø 24mm height counter ring 8mm counter ring int. ø 13.5mm		
	GEV No.	524416	Ref. No. —
	pump cover gasket thickness 4x4mm Qty 1 pcs		



1

GEV No.	500058	Ref. No.	100717
description	pump inlet ø 63mm outlet ø 53mm type 2241.2500 230/400V 50Hz 3 phase 0.89kW 1.2HP L 305mm rotation direction left FIR		
spare parts for	500058		
	GEV No.	510531	Ref. No. —
	pump cover FIR inlet ø 63mm outlet ø 53mm auxiliary pressure connection M16x1.5mm supporting pressure open turn direction left ø 185mm ID ø 150mm inner height 37mm		
	GEV No.	510693	Ref. No. 50420004 50420034
	mechanical shaft seal for shaft ø 12mm slide ring ext. ø 24mm slide ring H 15.5mm slide ring int. ø 11mm counter ring mounting ø 24mm height counter ring 8mm counter ring int. ø 13.5mm		
	GEV No.	510834	Ref. No. —
	impellor ø 110mm H 29mm thread M8R suitable for FIR		
	GEV No.	524416	Ref. No. —
	pump cover gasket thickness 4x4mm Qty 1 pcs		
accessories for	500058		
	GEV No.	504329	Ref. No. —
	blind plug H 17.5mm thread M16x1.5 plastic WS 22 for pump		
	GEV No.	524046	Ref. No. —
	vibration damper L 40mm W 25mm H 25mm for pump		

LGB



1







GEV No.	500461	Ref. No.	50920218
description	pump inlet \varnothing 32mm outlet \varnothing 32mm type ZF210SX 230V 50Hz 1 phase 0.6kW 0.8HP L 180mm capacitor 12.5 μ F LGB		
spare parts for	500461		
	GEV No.	502267	Ref. No. —
	pump cover		
	GEV No.	510702	Ref. No. —
	mechanical shaft seal height counter ring 5.5mm ID \varnothing 12mm		
	GEV No.	521042	Ref. No. —
	impellor \varnothing 103mm H 14mm pump type ZF210SX thread M10L		
	GEV No.	532719	Ref. No. —
	O-ring EPDM thickness 2.62mm ID \varnothing 126.67mm Qty 1 pcs		
accessories for	500461		
	GEV No.	365014	Ref. No. 50980007
	operating capacitor capacity 12.5 μ F 450V tolerance 5%Hz ambient temperature max. -25 to +85°C \varnothing 35mm L 70mm M8 plastic connection male faston 6.3mm 45S.C3DS.12.5 protection		

OLYMPIA

pumps



1

GEV No.	500521	Ref. No.	50400094
description	pump inlet \varnothing 1" IT outlet \varnothing 26mm type T33 230V 50Hz 1 phase 0.25kW 0.34HP L 225mm rotation direction right capacitor 5 μ F auxiliary pressure connection 11mm supporting pressure closed OLYMPIA		
spare parts for	500521		
	GEV No.	365017	Ref. No. 50980004
	operating capacitor capacity 5 μ F 450V tolerance 5% 50/60Hz ambient temperature max. -25 to +85°C \varnothing 28mm L 54mm M8 plastic connection male faston 6.3mm 16.10.08 protection		
	GEV No.	510693	Ref. No. 50420004 50420034
	mechanical shaft seal for shaft \varnothing 12mm slide ring ext. \varnothing 24mm slide ring H 15.5mm slide ring int. \varnothing 11mm counter ring mounting \varnothing 24mm height counter ring 8mm counter ring int. \varnothing 13.5mm		
	GEV No.	521256	Ref. No. 50410060
	impellor \varnothing 74mm H 14mm thread M10L shaft \varnothing 12mm shaft length 7.5mm blades 8		
	GEV No.	521554	Ref. No. 504300036 50430036
	pump cover OLYMPIA inlet 1" \varnothing 90mm ID \varnothing 66mm inner high 5mm		
	GEV No.	521724	Ref. No. 50700094 50700105
	O-ring EPDM thickness 1.78mm ID \varnothing 72.75mm Qty 1 pcs		
	GEV No.	528800	Ref. No. 50700093
	O-ring EPDM thickness 2.62mm ID \varnothing 75.87mm Qty 1 pcs		



1

GEV No.	499257	Ref. No.	50400070
description	pump inlet ø 1" IT outlet ø 30mm type L63.T45F_2V 230V 50Hz 1 phase 0.33kW L 230mm rotation direction left capacitor 8µF OLYMPIA		
spare parts for	499257		
	GEV No.	365013	Ref. No.
			—
	operating capacitor capacity 8µF 400V tolerance 5%Hz ambient temperature max. -25 to +85°C ø 31.5mm L 55mm M8 plastic connection male faston 6.3mm protection		
	GEV No.	509007	Ref. No.
			—
	impellor ø 85mm H 20mm rotation direction left thread M10R shaft ø 12mm shaft length 7.5mm blades 12		
	GEV No.	510693	Ref. No.
			50420004 50420034
	mechanical shaft seal for shaft ø 12mm slide ring ext. ø 24mm slide ring H 15.5mm slide ring int. ø 11mm counter ring mounting ø 24mm height counter ring 8mm counter ring int. ø 13.5mm		
	GEV No.	521167	Ref. No.
			—
	pump cover OLYMPIA inlet ø 1"mm outlet ø 30/30mm ID ø 94mm		
	GEV No.	521723	Ref. No.
			50700021
	pump cover gasket EPDM thickness 2mm ID ø 90mm Qty 1 pcs		

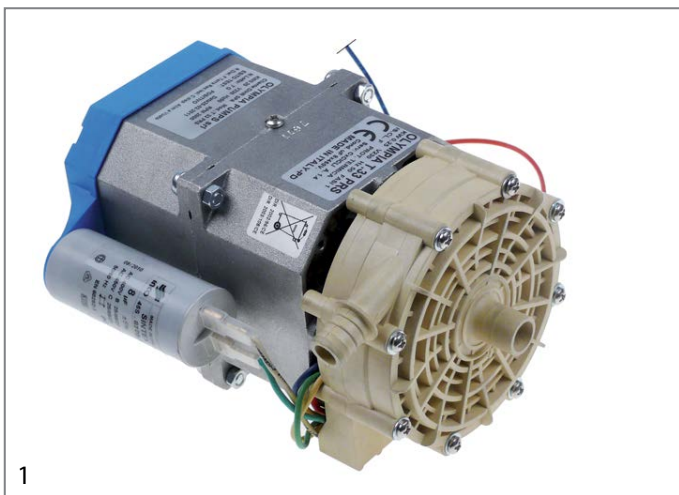

1

GEV No.	499095	Ref. No.	50400038
description	pump inlet ø 15mm outlet ø 14mm type T.33PRS 230V 50Hz 1 phase 0.25kW L 185mm rotation direction right capacitor 8µF OLYMPIA		
spare parts for	499095		
	GEV No.	365013	Ref. No.
			—
	operating capacitor capacity 8µF 400V tolerance 5%Hz ambient temperature max. -25 to +85°C ø 31.5mm L 55mm M8 plastic connection male faston 6.3mm protection		

spare parts for	499095		
	GEV No.	510693	Ref. No.
			50420004 50420034
	mechanical shaft seal for shaft ø 12mm slide ring ext. ø 24mm slide ring H 15.5mm slide ring int. ø 11mm counter ring mounting ø 24mm height counter ring 8mm counter ring int. ø 13.5mm		
	GEV No.	521165	Ref. No.
			—
	pump cover OLYMPIA inlet ø 15mm outlet ø 13mm pump type R63.T33 PRS		
	GEV No.	521166	Ref. No.
			—
	impellor ø 90mm H 9mm pump type R63.T33 PRS thread M10R shaft ø 12mm shaft length 8mm		
	GEV No.	525022	Ref. No.
			50700088
	O-ring EPDM thickness 1.78mm ID ø 75.92mm Qty 1 pcs		



1



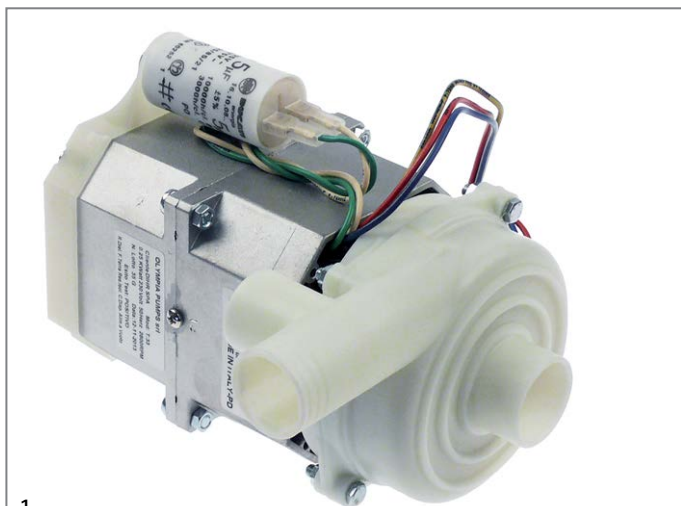

GEV No.	499256	Ref. No.	50400099
description	pump inlet ø 28mm outlet ø 30mm type L63.T40 230V 50Hz 1 phase 0.4kW L 235mm rotation direction right capacitor 5µF OLYMPIA		
spare parts for	499256		
	GEV No.	365017	Ref. No.
			50980004
	operating capacitor capacity 5µF 450V tolerance 5% 50/60Hz ambient temperature max. -25 to +85°C ø 28mm L 54mm M8 plastic connection male faston 6.3mm 16.10.08 protection		
	GEV No.	510693	Ref. No.
			50420004 50420034
	mechanical shaft seal for shaft ø 12mm slide ring ext. ø 24mm slide ring H 15.5mm slide ring int. ø 11mm counter ring mounting ø 24mm height counter ring 8mm counter ring int. ø 13.5mm		
	GEV No.	521170	Ref. No.
			50430039
	pump cover OLYMPIA outlet ø 30mm auxiliary pressure connection 11mm pump type L63.T19		
	GEV No.	521171	Ref. No.
			—
	impellor ø 74mm H 16mm pump type L63.T40 thread M10L		
	GEV No.	521724	Ref. No.
			50700094 50700105
	O-ring EPDM thickness 1.78mm ID ø 72.75mm Qty 1 pcs		



GEV No.	500520	Ref. No.	50400068
description	pump inlet \varnothing 33mm outlet \varnothing 30/28mm type T33 230V 50Hz 1 phase 0.25kW 0.34HP L 190mm rotation direction left capacitor 5 μ F OLYMPIA		
spare parts for	500520		
	GEV No.	365017	Ref. No. 50980004
	operating capacitor capacity 5 μ F 450V tolerance 5% 50/60Hz ambient temperature max. -25 to +85°C \varnothing 28mm L 54mm M8 plastic connection male faston 6.3mm 16.10.08 protection		
	GEV No.	510693	Ref. No. 50420004 50420034
	mechanical shaft seal for shaft \varnothing 12mm slide ring ext. \varnothing 24mm slide ring H 15.5mm slide ring int. \varnothing 11mm counter ring mounting \varnothing 24mm height counter ring 8mm counter ring int. \varnothing 13.5mm		
	GEV No.	521151	Ref. No. —
	impellor \varnothing 71mm H 19mm pump type OLYMPIA thread M10R shaft \varnothing 12mm shaft length 8mm		
	GEV No.	521551	Ref. No. 50430021
	pump cover OLYMPIA inlet \varnothing 33mm outlet \varnothing 30mm outlet 2 \varnothing 28 turn direction left \varnothing 103mm ID \varnothing 93mm inner height 30mm		
	GEV No.	521723	Ref. No. 50700021
	pump cover gasket EPDM thickness 2mm ID \varnothing 90mm Qty 1 pcs		



GEV No.	500958	Ref. No.	50400071
description	pump inlet \varnothing 33mm outlet \varnothing 30/28mm type T45 230V 50Hz 1 phase 0.33kW 0.45HP L 215mm rotation direction left capacitor 8 μ F OLYMPIA		
spare parts for	500958		
	GEV No.	365013	Ref. No. —
	operating capacitor capacity 8 μ F 400V tolerance 5%Hz ambient temperature max. -25 to +85°C \varnothing 31.5mm L 55mm M8 plastic connection male faston 6.3mm protection		

spare parts for	500958		
	GEV No.	510693	Ref. No. 50420004 50420034
	mechanical shaft seal for shaft \varnothing 12mm slide ring ext. \varnothing 24mm slide ring H 15.5mm slide ring int. \varnothing 11mm counter ring mounting \varnothing 24mm height counter ring 8mm counter ring int. \varnothing 13.5mm		
	GEV No.	521257	Ref. No. 50410025 50410054
	impellor \varnothing 80mm H 12mm rotation direction left thread M10R shaft \varnothing 12mm shaft length 7.5mm blades 6		
	GEV No.	521551	Ref. No. 50430021
	pump cover OLYMPIA inlet \varnothing 33mm outlet \varnothing 30mm outlet 2 \varnothing 28 turn direction left \varnothing 103mm ID \varnothing 93mm inner height 30mm		
	GEV No.	521723	Ref. No. 50700021
	pump cover gasket EPDM thickness 2mm ID \varnothing 90mm Qty 1 pcs		



GEV No.	500525	Ref. No.	50400042
description	pump inlet \varnothing 50mm outlet \varnothing 30mm type T7 230V 50Hz 1 phase 0.52kW 0.71HP L 230mm rotation direction right capacitor 12.5 μ F OLYMPIA		
spare parts for	500525		
	GEV No.	365014	Ref. No. 50980007
	operating capacitor capacity 12.5 μ F 450V tolerance 5%Hz ambient temperature max. -25 to +85°C \varnothing 35mm L 70mm M8 plastic connection male faston 6.3mm 45S.C3DS.12.5 protection		
	GEV No.	510554	Ref. No. 50700009
	O-ring EPDM thickness 2mm ID \varnothing 120mm Qty 1 pcs		
	GEV No.	510693	Ref. No. 50420004 50420034
	mechanical shaft seal for shaft \varnothing 12mm slide ring ext. \varnothing 24mm slide ring H 15.5mm slide ring int. \varnothing 11mm counter ring mounting \varnothing 24mm height counter ring 8mm counter ring int. \varnothing 13.5mm		
	GEV No.	517368	Ref. No. 50410028
	impellor \varnothing 102mm H 21mm rotation direction right thread M10L suitable for Dühr blades 8		
	GEV No.	521556	Ref. No. 50430020
	pump cover OLYMPIA inlet \varnothing 50mm outlet \varnothing 30mm outlet 2 \varnothing 30 auxiliary pressure connection 10mm supporting pressure open turn direction right \varnothing 130mm ID \varnothing 124mm inner height 20mm		



1

GEV No.	500529	Ref. No.	T12
description	pump inlet ø 60mm outlet ø 48mm type T12 230V 50Hz 1 phase 0.88kW 1.2HP L 270mm rotation direction right capacitor 16µF auxiliary pressure connection 10mm supporting pressure open OLYMPIA		
spare parts for	500529		
	GEV No.	365021	Ref. No. —
	operating capacitor capacity 16µF 425V tolerance 5% 50/60Hz ambient temperature max. -25 to +85°C ø 35mm L 73mm single M8 plastic connection male faston 6.3mm 416.10.99 protection		
	GEV No.	510693	Ref. No. 50420004 50420034
	mechanical shaft seal for shaft ø 12mm slide ring ext. ø 24mm slide ring H 15.5mm slide ring int. ø 11mm counter ring mounting ø 24mm height counter ring 8mm counter ring int. ø 13.5mm		
	GEV No.	521010	Ref. No. —
	impellor ø 98mm H 12mm M10L blades 8		
	GEV No.	521559	Ref. No. 50430019
	pump cover OLYMPIA inlet ø 60mm outlet ø 48mm outlet 2 ø 31 auxiliary pressure connection 10mm supporting pressure open turn direction right ø 170mm ID ø 150mm inner height 22mm		
	GEV No.	521727	Ref. No. 50700023
	pump cover gasket EPDM thickness 1.78mm ID ø 145mm Qty 1 pcs		







1

GEV No.	500530	Ref. No.	50400041 50400093
description	pump inlet ø 60mm outlet ø 48mm type T15 230V 50Hz 1 phase 1.1kW 1.5HP L 305mm rotation direction right OLYMPIA		
spare parts for	500530		
	GEV No.	365021	Ref. No. —
	operating capacitor capacity 16µF 425V tolerance 5% 50/60Hz ambient temperature max. -25 to +85°C ø 35mm L 73mm single M8 plastic connection male faston 6.3mm 416.10.99 protection		
	GEV No.	510693	Ref. No. 50420004 50420034
	mechanical shaft seal for shaft ø 12mm slide ring ext. ø 24mm slide ring H 15.5mm slide ring int. ø 11mm counter ring mounting ø 24mm height counter ring 8mm counter ring int. ø 13.5mm		
	GEV No.	521039	Ref. No. —
	fanwheel cover ID ø 156mm ED ø 161mm H 76mm for wash pump		
	GEV No.	521262	Ref. No. 50410029 50410059
	impellor ø 102mm H 19mm rotation direction right thread M10L blades 6		
	GEV No.	521559	Ref. No. 50430019
	pump cover OLYMPIA inlet ø 60mm outlet ø 48mm outlet 2 ø 31 auxiliary pressure connection 10mm supporting pressure open turn direction right ø 170mm ID ø 150mm inner height 22mm		
	GEV No.	521727	Ref. No. 50700023
	pump cover gasket EPDM thickness 1.78mm ID ø 145mm Qty 1 pcs		









1

GEV No.	500526	Ref. No.	50400046
description	pump inlet \varnothing 60mm outlet \varnothing 48mm type T75 230V 50Hz 1 phase 0.55kW 0.75HP L 250mm rotation direction right capacitor 12.5 μ F auxiliary pressure connection 10mm supporting pressure open OLYMPIA		
spare parts for	500526		
	GEV No.	365014	Ref. No. 50980007
	operating capacitor capacity 12.5 μ F 450V tolerance 5%Hz ambient temperature max. -25 to +85°C \varnothing 35mm L 70mm M8 plastic connection male faston 6.3mm 45S.C3DS.12.5 protection		
	GEV No.	510693	Ref. No. 50420004 50420034
	mechanical shaft seal for shaft \varnothing 12mm slide ring ext. \varnothing 24mm slide ring H 15.5mm slide ring int. \varnothing 11mm counter ring mounting \varnothing 24mm height counter ring 8mm counter ring int. \varnothing 13.5mm		
	GEV No.	521260	Ref. No. 50410024 50410027
	impellor \varnothing 90mm H 12mm M10L type B		
	GEV No.	521559	Ref. No. 50430019
	pump cover OLYMPIA inlet \varnothing 60mm outlet \varnothing 48mm outlet 2 \varnothing 31 auxiliary pressure connection 10mm supporting pressure open turn direction right \varnothing 170mm ID \varnothing 150mm inner height 22mm		
	GEV No.	521727	Ref. No. 50700023
	pump cover gasket EPDM thickness 1.78mm ID \varnothing 145mm Qty 1 pcs		



1

GEV No.	499226	Ref. No.	50400026alter.
description	pump inlet \varnothing 62mm outlet \varnothing 52mm type MEC80.T200SX 230/400V 50Hz 3 phase 1.5kW 2HP L 340mm rotation direction right OLYMPIA		
spare parts for	499226		
	GEV No.	510693	Ref. No. 50420004 50420034
	mechanical shaft seal for shaft \varnothing 12mm slide ring ext. \varnothing 24mm slide ring H 15.5mm slide ring int. \varnothing 11mm counter ring mounting \varnothing 24mm height counter ring 8mm counter ring int. \varnothing 13.5mm		
	GEV No.	521152	Ref. No. —
	pump cover OLYMPIA inlet 62 \varnothing 190mm		
	GEV No.	521153	Ref. No. —
	pump casing OLYMPIA outlet \varnothing 52mm		
	GEV No.	521154	Ref. No. —
	O-ring ID \varnothing 152.7mm thickness 2.62mm EPDM Qty 1 pcs		
	GEV No.	521155	Ref. No. —
	impellor \varnothing 107mm H 34mm pump type OLYMPIA thread M8L blades 6		
accessories for	499226		
	GEV No.	542157	Ref. No. —
	bracket for wash pump L 267mm W 132mm H 43mm		

booster pumps I



1

GEV No.	500060	Ref. No.	15100
description	pump inlet \varnothing 1" outlet \varnothing 1" type PQM60 230V 50Hz 1 phase 0.37kW PEDRELLO		
accessories for	500060		
	GEV No.	365015	Ref. No. 50980013
	operating capacitor capacity 10 μ F 400V tolerance 5%Hz ambient temperature max. -25 to +85°C \varnothing 35.5mm L 59mm M8 plastic connection male faston 6.3mm protection		



drain pumps

ASKOLL



GEV No.	500202	Ref. No.	50400039
description	drain pump inlet ø 24mm outlet ø 22mm 230V 40W		

booster pumps II

accessories



GEV No.	365015	Ref. No.	50980013
description	operating capacitor capacity 10µF 400V tolerance 5%Hz ambient temperature max. -25 to +85°C ø 35.5mm L 59mm M8 plastic connection male faston 6.3mm protection		



GEV No.	365017	Ref. No.	50980004
description	operating capacitor capacity 5µF 450V tolerance 5% 50/60Hz ambient temperature max. -25 to +85°C ø 28mm L 54mm M8 plastic connection male faston 6.3mm 16.10.08 protection		

condensators & interference suppression filters

operating capacitors

plastic



GEV No.	365015	Ref. No.	50980013
description	operating capacitor capacity 10µF 400V tolerance 5%Hz ambient temperature max. -25 to +85°C ø 35.5mm L 59mm M8 plastic connection male faston 6.3mm protection		



GEV No.	365014	Ref. No.	50980007
description	operating capacitor capacity 12.5µF 450V tolerance 5%Hz ambient temperature max. -25 to +85°C ø 35mm L 70mm M8 plastic connection male faston 6.3mm 45S.C3DS.12.5 protection		



GEV No.	365017	Ref. No.	50980004
description	operating capacitor capacity 5µF 450V tolerance 5% 50/60Hz ambient temperature max. -25 to +85°C ø 28mm L 54mm M8 plastic connection male faston 6.3mm 16.10.08 protection		

filters

interference suppression filters



GEV No.	365044	Ref. No.	50980012
description	interference suppression filter type FC701Y2F 250V 50-60Hz conductor 2 with E connection cable 200mm L 42mm ø 23mm Hmm Wmm plastic Qty 1 pcs		

electric accessories

cables

ribbon cables

group 1



GEV No.	400066	Ref. No.	50320206 50820123 50920123 50920206
description	ribbon cable 10-pole L 1000mm plug type FC-10P raster size 2.54mm		



terminals

connection terminals with screw/faston connections



1

GEV No.	550278	Ref. No.	50970001
description	power terminal block 3-pole max. 40A max 400V connection $\phi 6\text{mm}^2$ / F6.3 temp.-resist. 150°C cross section 6mm ²		

equipment-specific units

for espresso machines

brewing units

filter holder gaskets

O-rings



1

GEV No.	510409	Ref. No.	50700015 50700016
description	O-ring EPDM thickness 5.34mm ID $\phi 56.52\text{mm}$ Qty 1 pcs		

steam/water taps

steam/water pipes

accessories

gaskets



1

GEV No.	510893	Ref. No.	50700004
description	O-ring EPDM thickness 2.62mm ID $\phi 9.92\text{mm}$ Qty 1 pcs		

intake valves

intake valves



1

GEV No.	531009	Ref. No.	50110010
description	intake valve for LA ROCCA		

for coffee grinders

grinding burrs

screws



1

GEV No.	560365	Ref. No.	51310013
description	flat-headed bolt thread M4 thread L 8mm SS DIN 7985/ISO 7045 Qty 1 pcs intake Phillips head $\phi 8\text{mm}$ head thickness 3mm		

for dishwashers

containers

salt tanks



1

GEV No.	517396	Ref. No.	51400007
description	lid $\phi 69\text{mm}$ H 19mm for salt tank ID $\phi 50.5\text{mm}$		



1

GEV No.	517397	Ref. No.	51400006
description	nut $\phi 93\text{mm}$ H 13mm for salt tank ID $\phi 64\text{mm}$		



1







GEV No.	510929	Ref. No.	51400003	
description	salt tank $\phi 120\text{mm}$ H 117mm hose $\phi 10\text{mm}$ mounting $\phi 70\text{mm}$ overall height 157mm			
spare parts for	510929			
	GEV No.	506015	Ref. No.	—
	O-ring EPDM thickness 3.53mm ID $\phi 39.69\text{mm}$ Qty 1 pcs			

Table continues overleaf



spare parts for 510929	
	GEV No. 510018 Ref. No. — nut ø 92mm H 10.5mm for salt tank ID ø 64mm
	GEV No. 524177 Ref. No. — lid ø 69mm H 20mm for salt tank ID ø 50mm
accessories for 510929	
	GEV No. 510071 Ref. No. 50710018 flat gasket rubber ED ø 81mm ID ø 68mm thickness 3mm for salt tank Qty 1 pcs
	GEV No. 510654 Ref. No. — gasket H 6mm D1 ø 82mm D2 ø 68mm
	GEV No. 510883 Ref. No. — gasket rubber ED ø 86mm ID ø 66mm thickness 2mm for salt tank Qty 1 pcs

	
1	
GEV No. 517686	Ref. No. 51400077
description salt tank ø 90mm H 125mm with magnetic switch plastic	

accessories	
	
1	
GEV No. 510071	Ref. No. 50710018
description flat gasket rubber ED ø 81mm ID ø 68mm thickness 3mm for salt tank Qty 1 pcs	

boilers	
boilers for dishwashers	
	
1	
GEV No. 517300	Ref. No. 50200018
description boiler ø 140mm L 390mm	

	
1	
GEV No. 517302	Ref. No. 50200017
description boiler with insulation ø 160mm L 500mm	
accessories for 517302	
	GEV No. 517337 Ref. No. 50200029 50200035
description insulating mat boiler ø 160mm	

accessories	
	
1	
GEV No. 517125	Ref. No. 51680078
description hose connector	

	
1	
GEV No. 517336	Ref. No. 50200030 50200034
description insulating mat boiler L 500mm W 155mm	

	
1	
GEV No. 517337	Ref. No. 50200029 50200035
description insulating mat boiler ø 160mm	

softener cartridges

softening columns



1

GEV No.	530084	Ref. No.	51400004
description	softener 4-fold L 380mm W 180mm		

housing and bezels

fascias



1

GEV No.	517422	Ref. No.	51030013
description	bezel for thermometer L 90mm H 53.5mm		

miscellaneous



1

GEV No.	517400	Ref. No.	51210040
description	bearing for door rubber ID \varnothing 12mm mounting pos. left		



1

GEV No.	524803	Ref. No.	51200076
description	bracket for dishwasher rack SS L 25mm ED \varnothing 10mm thread M6		

hood mechanics for dishwashers

bushes



1

GEV No.	512423	Ref. No.	51210286
description	bush for hood handle		



1

GEV No.	517282	Ref. No.	51210046
description	cylinder liner hood mechanics		



1

GEV No.	694679	Ref. No.	51210289
description	roller ID \varnothing 10.5mm L 33mm for hood mechanics D1 \varnothing 22mm D2 \varnothing 19.8mm		

guide bars



1

GEV No.	517378	Ref. No.	51210054
description	guide bar L 650mm mounting pos. left for hood mechanics thickness 25mm		



1

GEV No.	513019	Ref. No.	51210053
description	guide bar L 695mm mounting pos. right thickness 25mm		

rollers



1

GEV No.	524805	Ref. No.	51210287
description	roller \varnothing 23mm H 9.6mm for hood mechanics plastic white hole \varnothing 8mm		

miscellaneous



1

GEV No.	517283	Ref. No.	51210047
description	roller for hood handle		



basket guides

guide bars



1

GEV No.	517813	Ref. No.	51200017
description	basket guide mounting pos. left/right L 450mm W 3.5mm H 37.5mm		

air traps

air traps



1

GEV No.	517168	Ref. No.	51280008
description	air trap H 56mm		

accessories for 517168

	GEV No.	517173	Ref. No.	50720005
	description	flat gasket FIBER ED ø 14mm ID ø 8mm thickness 1.5mm Qty 1 pcs		

	GEV No.	517174	Ref. No.	51320023
	description	nut thread M8 H 6.5mm WS 13 SS DIN/ISO DIN 934 / ISO 4032/8673 Qty 1 pcs		



1

GEV No.	517171	Ref. No.	51280005 51280006
description	air trap L 90mm W 55mm H 31mm		

accessories for 517171

	GEV No.	517173	Ref. No.	50720005
	description	flat gasket FIBER ED ø 14mm ID ø 8mm thickness 1.5mm Qty 1 pcs		

	GEV No.	517174	Ref. No.	51320023
	description	nut thread M8 H 6.5mm WS 13 SS DIN/ISO DIN 934 / ISO 4032/8673 Qty 1 pcs		

backflow preventers

accessories



1

GEV No.	996010	Ref. No.	51650034
description	ball ø 16mm		



1

GEV No.	996013	Ref. No.	51650032
description	lid for back flow restrictor ø 40mm H 14.5mm plastic		



1

GEV No.	996011	Ref. No.	51650031
description	nut with hole L 32mm W 32mm H 25mm thread M26x1.5 WS 32 plastic		

door mechanics

linkage



1

GEV No.	517269	Ref. No.	51210245
description	door pin tie bar		

sliding plates



1

GEV No.	517264	Ref. No.	51210031
description	sliding plate sliding plate		

hinges







1

GEV No.	517267	Ref. No.	51210030
description	door hinge hinge mounting pos. left		

accessories for 517267

	GEV No.	517266	Ref. No.	51210025 51210029
	description	door hinge hinge mounting pos. right		

	GEV No.	517268	Ref. No.	—
	description	bush ID ø 8mm H 9mm bush thread M11x1 WS 13		

			
1			
GEV No.	517266	Ref. No.	51210025 51210029
description	door hinge hinge mounting pos. right		
accessories for	517266		
	GEV No.	517267	Ref. No. 51210030
	door hinge hinge mounting pos. left		
	GEV No.	517268	Ref. No. —
	bush ID ø 8mm H 9mm bush thread M11x1 WS 13		



door bumpers

			
1			
GEV No.	517265	Ref. No.	51210028
description	door bumper end stop		

locks

			
1			
GEV No.	517278	Ref. No.	51210312
description	counterpart door catch		

			
1			
GEV No.	506157	Ref. No.	51210019
description	door catch catch		

			
1			
GEV No.	517276	Ref. No.	50900158
description	door catch catch		
accessories for	517276		
	GEV No.	517277	Ref. No. 50710079
	gasket for catch		
	GEV No.	517278	Ref. No. 51210312
	counterpart door catch		

miscellaneous

			
1			
GEV No.	524955	Ref. No.	51210039
description	bearing for door ID ø 12mm H 22mm L 32mm W 9mm mounting pos. right		

washing and rinsing systems

			
1			
GEV No.	517098	Ref. No.	50020181
description	cover for rinse arm shaft mounting pos. lower		

			
1			
GEV No.	517129	Ref. No.	50020088 50020166
description	cover wash arm support mounting pos. lower		

			
1			
GEV No.	517130	Ref. No.	50020097
description	cover wash arm support mounting pos. lower		

			
1			
GEV No.	517374	Ref. No.	50710077
description	duct D1 ø 20mm D2 ø 14mm L 17mm int. ø 110mm		





			
1			
GEV No.	517095	Ref. No.	50020199
description	flange ø 60mm		

			
1			
GEV No.	517148	Ref. No.	50710014
description	flat gasket rubber ED ø 57mm ID ø 43mm thickness 2mm Qty 1 pcs		

			
1			
GEV No.	511944	Ref. No.	50710016
description	gasket for wash pipe ø 41mm thickness 10mm ID ø 27mm		

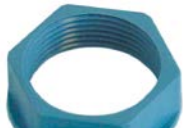
			
1			
GEV No.	517138	Ref. No.	10225
description	guide for rinse arm shaft		

			
1			
GEV No.	517134	Ref. No.	50020168
description	nut		

			
1			
GEV No.	517070	Ref. No.	50020102
description	nut for wash arm		

			
1			
GEV No.	524959	Ref. No.	50020164
description	nut for wash arm mounting pos. upper/lower ø 35mm H 34mm PTFE		

			
1			
GEV No.	517154	Ref. No.	50020084
description	nut mounting pos. upper for wash arm support		

			
1			
GEV No.	524853	Ref. No.	50020200
description	reducer for wash arm support ø 30mm ID ø 14mm ED ø 24.5mm H 9mm		

			
1			
GEV No.	517155	Ref. No.	51660009 51860009
description	rinse arm support for stationary arms mounting pos. upper		

			
1			
GEV No.	517116	Ref. No.	50020149
description	rinse pipe		

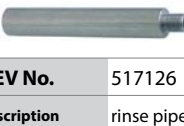
			
1			
GEV No.	517126	Ref. No.	50020089
description	rinse pipe		

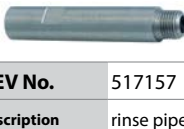
			
1			
GEV No.	517157	Ref. No.	50020157
description	rinse pipe		

			
1			
GEV No.	517144	Ref. No.	50020194
description	rinse pipe angled mounting pos. upper		

			
1			
GEV No.	517140	Ref. No.	50020106
description	rinse pipe mounting pos. lower		

			
1			
GEV No.	517115	Ref. No.	50020104
description	spacer piece		

			
1			
GEV No.	517139	Ref. No.	50020158
description	throttle disc		

			
1			
GEV No.	517071	Ref. No.	50020101 50020112
description	wash arm bearing		

			
1			
GEV No.	517084	Ref. No.	80221
description	wash arm bearing		

			
1			
GEV No.	524798	Ref. No.	50020204
description	wash arm bearing mounting pos. lower 3 holes hole ø 3mm seat ø 20mm ø 46mm H 35mm		

			
1			
GEV No.	524799	Ref. No.	50020186
description	wash arm bearing mounting pos. upper/lower 3 holes hole ø 3mm seat ø 20mm ø 46mm H 32mm		

			
1			
GEV No.	517369	Ref. No.	50020163
description	wash arm bearing ø 16.5mm H 18.5mm		

			
1			
GEV No.	517118	Ref. No.	50020146
description	wash arm support mounting pos. lower		

hinges

door bearing

			
1			
GEV No.	519397	Ref. No.	51210035
description	bush mounting pos. left for hinge		

			
1			
GEV No.	519396	Ref. No.	51210034
description	bush mounting pos. right for hinge		



miscellaneous



1

GEV No.	519399	Ref. No.	51210265
description	door hinge mounting pos. left		
accessories for	519399		
	GEV No.	519397	Ref. No.
			51210035
	bush mounting pos. left for hinge		



1

GEV No.	519398	Ref. No.	51210264
description	door hinge mounting pos. right		
accessories for	519398		
	GEV No.	519396	Ref. No.
			51210034
	bush mounting pos. right for hinge		

gaskets

O-rings

EPDM



1

GEV No.	510302	Ref. No.	50700018
description	O-ring EPDM ID ø 12.42mm thickness 1.78mm Qty 1 pcs		



1

GEV No.	345908	Ref. No.	50710061
description	O-ring EPDM thickness 1.5mm ID ø 58.5mm Qty 1 pcs		



1

GEV No.	510824	Ref. No.	50700003
description	O-ring EPDM thickness 1.78mm ID ø 20.35mm Qty 1 pcs		

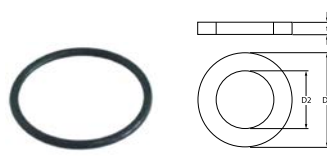

1

GEV No.	517045	Ref. No.	50700019
description	O-ring EPDM thickness 1.78mm ID ø 21.95mm Qty 1 pcs		



1

GEV No.	517035	Ref. No.	50700017
description	O-ring EPDM thickness 1.78mm ID ø 4.48mm Qty 1 pcs		



1

GEV No.	521724	Ref. No.	50700094 50700105
description	O-ring EPDM thickness 1.78mm ID ø 72.75mm Qty 1 pcs		



1

GEV No.	525022	Ref. No.	50700088
description	O-ring EPDM thickness 1.78mm ID ø 75.92mm Qty 1 pcs		



1

GEV No.	532680	Ref. No.	50700103
description	O-ring EPDM thickness 2.5mm ID ø 12mm Qty 1 pcs		



1

GEV No.	517104	Ref. No.	50700082
description	O-ring EPDM thickness 2.62mm ID ø 31.42mm Qty 1 pcs		

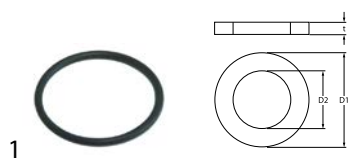

GEV No.	517004	Ref. No.	50700011
description	O-ring EPDM thickness 2.62mm ID ø 34.6mm Qty 1 pcs		



GEV No.	508061	Ref. No.	50700014
description	O-ring EPDM thickness 3.53mm ID ø 42.86mm Qty 1 pcs		



GEV No.	528800	Ref. No.	50700093
description	O-ring EPDM thickness 2.62mm ID ø 75.87mm Qty 1 pcs		

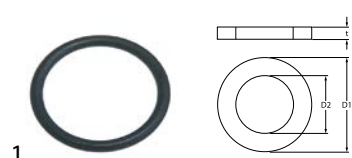

GEV No.	510408	Ref. No.	50700046
description	O-ring EPDM thickness 5.34mm ID ø 47mm Qty 1 pcs		



GEV No.	510893	Ref. No.	50700004
description	O-ring EPDM thickness 2.62mm ID ø 9.92mm Qty 1 pcs		



GEV No.	510409	Ref. No.	50700015 50700016
description	O-ring EPDM thickness 5.34mm ID ø 56.52mm Qty 1 pcs		

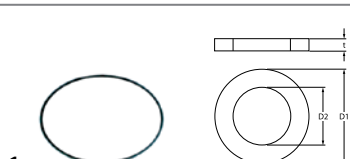

GEV No.	510554	Ref. No.	50700009
description	O-ring EPDM thickness 2mm ID ø 120mm Qty 1 pcs		



GEV No.	510551	Ref. No.	50700022
description	pump cover gasket ID ø 158.3mm pump type 1214/1293/1225/2243/1226/1204/3473/1241 thickness 3.53mm EPDM Qty 1 pcs		



GEV No.	517056	Ref. No.	50700010
description	O-ring EPDM thickness 2mm ID ø 6.5mm Qty 1 pcs		

sealing washers

fibre gaskets



GEV No.	517173	Ref. No.	50720005
description	flat gasket FIBER ED ø 14mm ID ø 8mm thickness 1.5mm Qty 1 pcs		



GEV No.	517087	Ref. No.	50700020
description	O-ring EPDM thickness 3.53mm ID ø 23.4mm Qty 1 pcs		



GEV No.	506072	Ref. No.	50710003
description	flat gasket fibre ED ø 38mm ID ø 27mm thickness 2mm outflow for thread 1¼" Qty 1 pcs		



GEV No.	510895	Ref. No.	50700081
description	O-ring EPDM thickness 3.53mm ID ø 34.52mm Qty 1 pcs		



rubber gaskets

1 

GEV No.	508423	Ref. No.	50710097
description	flat gasket rubber ED ø 40mm ID ø 25.5mm thickness 1.7mm Qty 1 pcs		

1 

GEV No.	517181	Ref. No.	50510071
description	flat gasket rubber ED ø 44mm ID ø 32mm thickness 3mm Qty 1 pcs		

1 

GEV No.	517148	Ref. No.	50710014
description	flat gasket rubber ED ø 57mm ID ø 43mm thickness 2mm Qty 1 pcs		

1 

GEV No.	511940	Ref. No.	50710078
description	flat gasket rubber ED ø 67mm ID ø 51mm thickness 3mm Qty 1 pcs		

1 

GEV No.	510071	Ref. No.	50710018
description	flat gasket rubber ED ø 81mm ID ø 68mm thickness 3mm for salt tank Qty 1 pcs		

1 

GEV No.	517194	Ref. No.	50710013
description	flat gasket rubber ED ø 95mm ID ø 75mm thickness 3mm Qty 1 pcs		

special gaskets

door seals for dishwashers

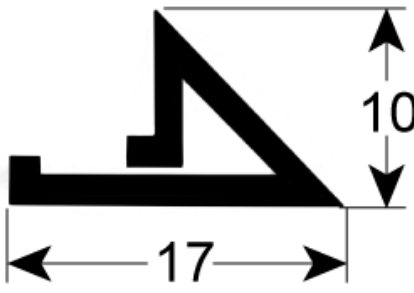
1 

GEV No.	517385	Ref. No.	50710070 50730018
description	door seal		

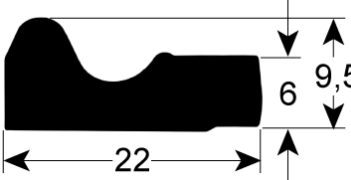
1 

GEV No.	517384	Ref. No.	50730010
description	door seal L 1050mm W 22mm H 9.5mm Qty 1		

sealing discs

1 

GEV No.	511945	Ref. No.	50710101
description	gasket ø 38mm thickness 10mm rubber Qty 1 pcs ID ø 24mm		

miscellaneous

1 

GEV No.	517277	Ref. No.	50710079
description	gasket for catch		

1 

GEV No.	511944	Ref. No.	50710016
description	gasket for wash pipe ø 41mm thickness 10mm ID ø 27mm		

			
1			
GEV No.	511945	Ref. No.	50710101
description	gasket ø 38mm thickness 10mm rubber Qty 1 pcs ID ø 24mm		

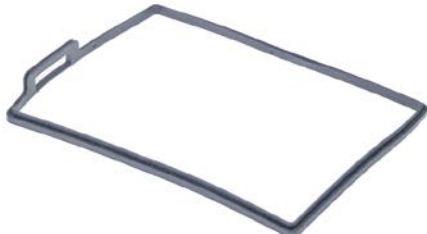
			
1			
GEV No.	524953	Ref. No.	50710103
description	gasket suitable for Dihr for PCB L 170mm W 124mm		

transmission technology and ball bearings

ball bearings

deep-groove ball bearings 2RS

			
1			
GEV No.	523011	Ref. No.	51210043
description	deep-groove ball bearing type 6002-2RS shaft ø 15mm ED ø 32mm W 9mm with sealing discs DIN 625-1		

springs

tension springs

			
1			
GEV No.	517273	Ref. No.	51210059
description	tension spring ø 10mm total length 225mm wire gauge ø 1.5mm mounting pos. upper		

			
1			
GEV No.	517259	Ref. No.	51210232
description	tension spring ø 15.3mm total length 130mm wire gauge ø 2mm for door		

			
1			
GEV No.	517272	Ref. No.	51210037
description	tension spring ø 15mm total length 540mm wire gauge ø 2mm mounting pos. lower		

			
1			
GEV No.	517261	Ref. No.	51210260
description	tension spring ø 20mm total length 140mm wire gauge ø 2.5mm for door		

			
1			
GEV No.	517287	Ref. No.	51210022
description	tension spring ø 38.8mm total length 663mm wire gauge ø 4.2mm		

dosing pumps

peristaltic dosing pumps

GERMAC



spare parts

			
1			
GEV No.	361060	Ref. No.	50110008
description	pump hose GERMAC rinse aid hose type silicone hose ø 4x6mm for model G80/G82/G600		

SEKO

built-in version

with frequency control

			
1			
GEV No.	361791 ¹	Ref. No.	50100008
description	dosing pump SEKO frequency control 3l/h 230VAC detergent hose ø 4x6mm hose type K hose Santoprene suction level 1.5m type NBR 3		
spare parts for	361791		
	GEV No.	361815	Ref. No.
			50110005
			
	pump hose detergent hose ø 6x10mm hose ø 4x6mm hose type K hose Santoprene type SEKO		

¹with accessories

spare parts

			
1			
GEV No.	361815	Ref. No.	50110005
description	pump hose detergent hose ø 6x10mm hose ø 4x6mm hose type K hose Santoprene type SEKO		



membrane dosing pumps

self-priming

various



1	GEV No.	361731	Ref. No.	50100003
	description	dosing pump without auxiliary pressure connection rinse aid inlet 4mm outlet 8mm pressure connection ø 8mm suction connection ø 4mm		

self-priming with supporting pressure

DIHR



1	GEV No.	361912	Ref. No.	50100013
	description	dosing pump kit inlet 5mm outlet 8mm suction connection ø 5mm auxiliary pressure connection 10mm		



1	GEV No.	361744	Ref. No.	50100001
	description	dosing pump type DW with auxiliary pressure connection rinse aid inlet 4mm outlet 8mm suction connection ø 4mm auxiliary pressure connection 10mm		
	spare parts for	361744		
	GEV No.	520026	Ref. No.	—
	description	PVC hose ID ø 4mm ED ø 6mm L 10m thickness 1mm t.max. 60°C transparent		
	GEV No.	520090	Ref. No.	—
	description	PVC hose ID ø 4mm ED ø 6mm L 2m thickness 1mm t.max. 60°C transparent		

GERMAC

spare parts

1			
GEV No.	361704	Ref. No.	51660007
description	hose connector brass straight thread M12x1 hose ø 11mm Qty 1 pcs		

1			
GEV No.	510296	Ref. No.	50110012
description	membrane silicone		

accessories

1			
GEV No.	361141	Ref. No.	50110004
description	container filter with weight ceramic hose ø 4mm		

non-return valves

1			
GEV No.	361899	Ref. No.	50110009
description	non-return valve inletmm outlet ø 7mm L 9mm Qty 2 pcs		

hose couplings

plastic

1			
GEV No.	361090	Ref. No.	51640033
description	hose connector hose ø 4x6mm connection M10x1		

tank inlets

1			
GEV No.	361057	Ref. No.	50120003
description	tank inlet plastic M10 hose ø 4x6mm		

			
1			
GEV No.	361416	Ref. No.	50120003
description	tank inlet SS M12 hose ø 6mm		

hoses

drain hoses

			
1			
GEV No.	511205	Ref. No.	50600002
description	drain hose DN19 L 1500mm A int. ø 23mm A ext. ø 29mm B int. ø 29mm outer hose ø 29mm B ext. ø 35mm		

industrial hoses

Niplaflex hoses

			
1			
GEV No.	530561	Ref. No.	50620008
description	pressure hose ID ø 10mm ED ø 17mm L 5m thickness 3.5mm operating p. 10bar burst p. 30bar t.max. 110°C		

pressure control hoses

			
1			
GEV No.	530560	Ref. No.	50620007 50620027
description	pressure control hose ID ø 5mm ED ø 9mm L 5m operating p. 30bar burst p. 90bar temp.-resist. 60°C		

formed hoses

straight

			
1			
GEV No.	517224	Ref. No.	50610034
description	formed hose dishwasher straight equiv. no. 540005		

form L

			
1			
GEV No.	524850	Ref. No.	50610075
description	formed hose end piece A ext. ø 43mm end piece A int. ø 35mm AD2 ø 58mm ø end piece B 49mm L 450mm Qty 1 warewashing L-shape		

			
1			
GEV No.	517228	Ref. No.	50610041 50610044
description	formed hose warewashing L-shape equiv. no. 15032/A		

			
1			
GEV No.	517245	Ref. No.	50610015 50610018 50610028
description	formed hose warewashing L-shape equiv. no. 15033/A mounting pos. lower		

			
1			
GEV No.	517248	Ref. No.	50610046
description	formed hose warewashing L-shape equiv. no. 16170/M mounting pos. upper		

			
1			
GEV No.	517223	Ref. No.	50610083
description	formed hose warewashing L-shape equiv. no. 18787		



1

GEV No.	517236	Ref. No.	50610037 50610069
description	formed hose warewashing L-shape equiv. no. 3002020		

with branch



1

GEV No.	517364	Ref. No.	50610042
description	formed hose ext. ø 58 D1 ø 50mm D2 ø 35mm L 455mm black Qty 1		

form S



1

GEV No.	517227	Ref. No.	50610032 50810032
description	formed hose S-shape warewashing equiv. no. 25032		



1

GEV No.	517226	Ref. No.	50610047
description	formed hose S-shape warewashing equiv. no. 25032/A		

form U



1

GEV No.	517252	Ref. No.	50610030
description	formed hose ext. ø 35 D1 ø 28mm D2 ø 28mm warewashing U-shape		

miscellaneous



1

GEV No.	524824	Ref. No.	50610071
description	formed hose ID ø 47/53mm ED ø 60/66mm L 340mm warewashing Qty 1 black		



1

GEV No.	517256	Ref. No.	50610043
description	formed hose warewashing equiv. no. 150048/A mounting pos. upper		



1

GEV No.	517243	Ref. No.	50610033
description	formed hose warewashing equiv. no. 150049 mounting pos. lower		



1

GEV No.	517241	Ref. No.	50610084
description	formed hose warewashing equiv. no. 16167 mounting pos. lower		



1

GEV No.	517233	Ref. No.	50610031
description	formed hose warewashing equiv. no. 16168 mounting pos. lower		



1

GEV No.	517253	Ref. No.	50610076
description	formed hose warewashing equiv. no. 540004 mounting pos. upper		

fittings, hose and pipe connectors

hose connectors

without screw connection



1

GEV No.	501210	Ref. No.	50020056
description	Y-piece plastic hose ø 10-10-10mm		



1

GEV No.	517166	Ref. No.	50020111
description	Y-piece plastic hose ø 10-10-10mm 3-way		

hose connectors

brass



1

GEV No.	361704	Ref. No.	51660007
description	hose connector brass straight thread M12x1 hose ø 11mm Qty 1 pcs		

nickel-plated brass



1

GEV No.	517108	Ref. No.	51680085
description	hose connector nickel-plated brass angled thread 3/8" ET - M10x1 IT hose ø 12mm Qty 1 pcs		



ancillary products

clamps

hose clamps

DIN 3017 - W2



1

GEV No.	520112	Ref. No.	51340004 51340005
----------------	--------	-----------------	----------------------

description hose clamp ø 12-20mm width 9mm Qty 10 pcs DIN 3017



1

GEV No.	520115	Ref. No.	51340006
----------------	--------	-----------------	----------

description hose clamp ø 25-40mm width 9mm Qty 10 pcs DIN 3017

measuring equipment

thermometers

built-in thermometers



1

GEV No.	541086	Ref. No.	51030003
----------------	--------	-----------------	----------

description thermometer mounting measurements 58x25.5mm 0 up to +120°C capillary pipe 2000mm probe ø 6mm probe L 23mm



1

GEV No.	541305	Ref. No.	51030012
----------------	--------	-----------------	----------

description thermometer mounting measurements 62x11mm +20 up to +120°C capillary pipe 1500mm probe ø 6.5mm probe L 16mm

fastening material

screws

flat-headed bolts



1

GEV No.	560365	Ref. No.	51310013
----------------	--------	-----------------	----------

description flat-headed bolt thread M4 thread L 8mm SS DIN 7985/ISO 7045 Qty 1 pcs intake Phillips head ø 8mm head thickness 3mm

knurled screws



1

GEV No.	517039	Ref. No.	50020107 50020117
----------------	--------	-----------------	----------------------

description Thumb screw thread M8x1.25 thread L 8mm ø 30mm H 3mm SS mounting pos. lower

nuts

hexagonal nuts

DIN 934 / ISO 4032/8673



1

GEV No.	517174	Ref. No.	51320023
----------------	--------	-----------------	----------

description nut thread M8 H 6.5mm WS 13 SS DIN/ISO DIN 934 / ISO 4032/8673 Qty 1 pcs

hexagonal nuts inch thread



1

GEV No.	517180	Ref. No.	50510025
----------------	--------	-----------------	----------

description nut thread 1" H 5mm WS 36 SS Qty 1 pcs



1

GEV No.	507528	Ref. No.	50020122
----------------	--------	-----------------	----------

description nut thread 3/4" H 8mm WS 32 brass Qty 1 pcs

fasteners

clamps

hose clamps

DIN 3017 - W2



1

GEV No.	520112	Ref. No.	51340004 51340005
description	hose clamp ø 12-20mm width 9mm Qty 10 pcs DIN 3017		



1

GEV No.	520115	Ref. No.	51340006
description	hose clamp ø 25-40mm width 9mm Qty 10 pcs DIN 3017		

B			
bi-metal thermostats	5	magnetic switches	7
booster pumps I	22	measuring equipment	39
booster pumps II	23	microswitches	6
C			
cables	23	N	
clamps	39, 40	Niplaflex hoses	36
condensators & interference suppression filters	23	non-return valves	35
contactors	10	nuts	39
container filters	35	O	
control equipment	8	operating capacitors	23
control thermostats	6	O-rings	31
D			
door seals for dishwashers	33	P	
dosing pumps	34	pressure control hoses	36
drain hoses	36	pressure switches	14
drain pumps	23	probes	10
E		programme timers	8
electric accessories	23	pumps	15
F			
fasteners	40	R	
fastening material	39	relays	10
filters	23	ribbon cables	23
flat-headed bolts	39	rotary switches	7
flow meters	15	S	
formed hoses	36	safety bi-metal thermostats	5
H		safety thermostats	6
heating elements	3	screws	39
hexagonal nuts	39	sealing discs	33
hose clamps	39, 40	sealing washers	32
hose connectors	38, 38	solenoid valves	12
hose couplings	35	switches and momentary switches	6
hoses	36	system switches (ROLD)	7
I			
immersion heating elements	3	T	
indicator lights	8	tank inlets	35
indicator lights (complete)	8	terminals	24
industrial hoses	36	thermostats	5
K		timers	8
knurled screws	39	W	
L		wash and rinse pumps	15
lamps	8		