



**GAS COMPONENTS**



**ELECTRIC COMPONENTS**



**WATER TECHNOLOGY**



**MECHANICAL COMPONENTS**



**TOOLS**

Spare parts suitable for

**ROLLER-GRILL**

Find the complete and up-to-date range of products in our GEV Webshop



# Manufacturer catalogue

The most important spare parts and accessories arranged clearly for every manufacturer

- ✓ Complete product range and all appliance data always up to date in the GEV Webshop
- ✓ Alphabetical Index at the end of the catalogue

## GEV Webshop

[www.gev-online.co.uk](http://www.gev-online.co.uk)

[www.gev-online.com](http://www.gev-online.com)



- 🔍 Add to Favourites
- 🔍 Sign In with email address and usual password
- 🔍 Easy-order – place several items in your basket at the same time
- 🔍 Quick Item search – no login needed



## heating elements

### heating elements for ovens

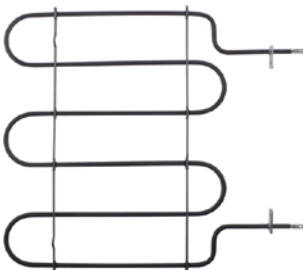

1

<b>GEV No.</b>	420092	<b>Ref. No.</b>	D02157
<b>description</b>	heating element 1200W 230V L 363mm W 360mm lug length 33mm lug width 16mm hole ø 3.4mm tube ø 6.5mm connection male faston 6.3mm heating circuits 1 dry heating element windings 3 for oven		

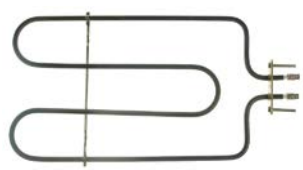

1

<b>GEV No.</b>	416735	<b>Ref. No.</b>	D02147
<b>description</b>	heating element 700W 110V heating circuits 1 L 330mm W 186mm L1 25mm L2 305mm W1 77mm W2 32mm flange length 70mm flange width 22mm hole distance 56mm bridge length 200mm hole ø 4mm tube ø 6.3mm connection male faston 6.3mm rectangular flange with bolt grill setting oven		

### heating elements for bain maries



1

<b>GEV No.</b>	416778	<b>Ref. No.</b>	D02073
<b>description</b>	heating element 1500W 230V heating circuits 1 L 246mm L1 30mm W 430mm connection distance 422mm tube ø 8mm dry heating element bain marie H 33mm		

### heating elements for crepes makers



1

<b>GEV No.</b>	419231	<b>Ref. No.</b>	D02172
<b>description</b>	heating element 3000W 230V ED ø 374mm H 70mm tube ø 8.5mm connection cable connection length 400mm heating circuits 1 crepes maker		

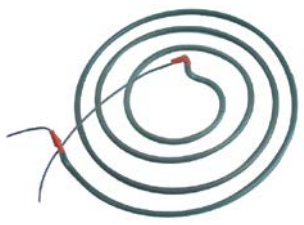

1

<b>GEV No.</b>	416726	<b>Ref. No.</b>	D02013
<b>description</b>	heating element 3000W 230V L 304mm W 300mm H 65mm tube ø 8.5mm connection cable cable length 580mm dry heating element heating circuits 1 ED ø 310mm crepes maker		
<b>For models:</b>	350E, 350ED, 400E, 400ED		

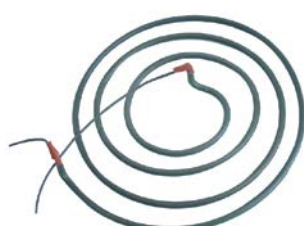

1

<b>GEV No.</b>	416771	<b>Ref. No.</b>	D02022
<b>description</b>	heating element 3600W 230V H 40mm tube ø 8.5mm connection distance 133mm cable length 570mm dry heating element heating circuits 1 ED ø 375mm crepes maker		
<b>For models:</b>	400FE		



1

<b>GEV No.</b>	420085	<b>Ref. No.</b>	D02156
<b>description</b>	heating element 3600W 230V H 45mm tube ø 8mm L1 140mm L2 215mm connection distance 132mm cable length 750mm for crepes maker heating circuits 1 ED ø 380mm		

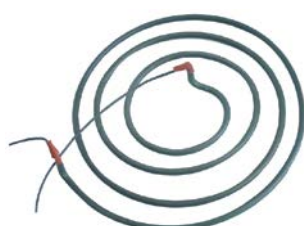

1

<b>GEV No.</b>	420234	<b>Ref. No.</b>	D02163
<b>description</b>	heating element 3600W 230V H 70mm tube ø 8mm L1 190mm L2 170mm connection male faston 6.3mm connection distance 190mm cable length 400mm heating circuits 1 ED ø 360mm crepes maker suitable for crepes maker		



heating elements for fryers

**1**

<b>GEV No.</b>	416746	<b>Ref. No.</b>	D02023
<b>description</b>	heating element 3000W 230V heating circuits 1 L 300mm W 185mm H 180mm L1 23mm L2 270mm W1 78mm W2 29mm flange length 50mm flange width 22mm hole distance 40mm windings 2 tube ø 8mm connection male faston 6.3mm hole ø 4.5mm rectangular flange immersion heater		

**1**

<b>GEV No.</b>	416744	<b>Ref. No.</b>	D02010 D02019
<b>description</b>	heating element 2000W 230V heating circuits 1 L 282mm W 120mm H 175mm rectangular flange connection male faston 6.3mm L1 22mm L2 50mm L3 210mm W1 46mm W2 28mm hole distance 40mm windings 2 hole ø 5mm flange length 50mm flange width 22mm		

**1**

<b>GEV No.</b>	416743	<b>Ref. No.</b>	D02018
<b>description</b>	heating element 2000W 230V heating circuits 1 L 285mm W 118mm H 142mm rectangular flange connection male faston 6.3mm immersion heater L1 25mm L2 50mm L3 210mm W1 45mm W2 28mm hole distance 40mm windings 2 hole ø 5mm flange length 50mm flange width 22mm tube ø 18mm		

**1**

<b>GEV No.</b>	416745	<b>Ref. No.</b>	D02069
<b>description</b>	heating element 2500W 230V heating circuits 1 L 285mm W 125mm H 177mm rectangular flange connection male faston 6.3mm immersion heater L1 25mm L2 50mm L3 210mm W1 48mm W2 28mm hole distance 40mm windings 3 hole ø 5mm flange length 50mm flange width 22mm tube ø 8mm		

**1**

<b>GEV No.</b>	420496	<b>Ref. No.</b>	D02122
<b>description</b>	heating element 3200W 230V heating circuits 1 L 284mm W 115mm H 180mm connection F6.3 L1 22mm L2 45mm L3 215mm W1 25mm hole distance 40mm		

**1**

<b>GEV No.</b>	418833	<b>Ref. No.</b>	D02070
<b>description</b>	heating element 3400W 230V heating circuits 1 L 295mm W 180mm H 175mm rectangular flange connection male faston 6.3mm L1 25mm L2 30mm L3 235mm W1 79mm W2 22mm hole distance 40mm windings 4 hole ø 4.5mm flange length 50mm flange width 22mm tube ø 8mm		

**1**

<b>GEV No.</b>	416739	<b>Ref. No.</b>	D02025
<b>description</b>	heating element 3800W 230/400V heating circuits 3 L 280mm W 185mm H 170mm L1 20mm L2 260mm W1 50mm W2 85mm flange length 115mm flange width 22mm tube ø 8mm hole distance 103mm hole ø 5mm connection male faston 6.3mm rectangular flange immersion heater fryer		

**1**

<b>GEV No.</b>	416740	<b>Ref. No.</b>	D02027
<b>description</b>	heating element 5000W 230/400V heating circuits 3 L 292mm W 186mm H 170mm L1 28mm L2 266mm W1 50mm W2 85mm flange length 115mm flange width 23mm tube ø 8mm hole distance 103mm hole ø 4mm connection male faston 6.3mm connection length 35mm rectangular flange immersion heater fryer		

2 hole fixing

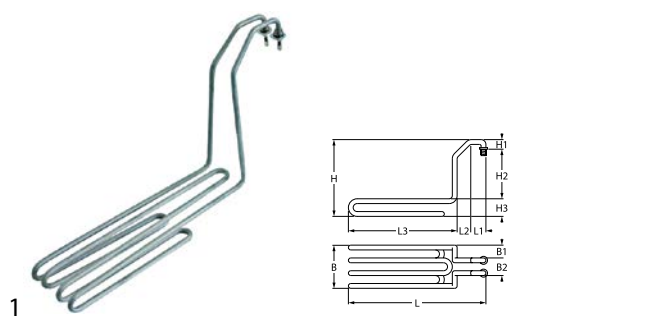

<b>GEV No.</b>	416741	<b>Ref. No.</b>	D02028
<b>description</b>	heating element 4000W 230V heating circuits 1 L 465mm W 82mm H 280mm 2 hole fixing connection M4 immersion heater L1 55mm L2 50mm L3 360mm W1 30mm W2 26mm H1 38mm H2 203mm H3 35mm tube ø 8mm thread M11x1 mounting distance 22mm		
<b>accessories for</b>	416741		
	<b>GEV No.</b>	521103	<b>Ref. No.</b> —
	nut thread M4 H 3mm WS 7 brass Qty 20 pcs		
	<b>GEV No.</b>	521104	<b>Ref. No.</b> —
	washer ID ø 4.3mm ED ø 8mm thickness 0.5mm brass Qty 20 pcs for thread M4		
	<b>GEV No.</b>	560111	<b>Ref. No.</b> —
	plain washer ID ø 4.3mm ED ø 9mm thickness 0.8mm SS Qty 20 pcs DIN 125A for thread M4		
	<b>GEV No.</b>	560131	<b>Ref. No.</b> —
	hexagonal nut thread M4 H 3.2mm WS 7 SS DIN/ISO DIN 934 / ISO 4032/8673 Qty 20 pcs		

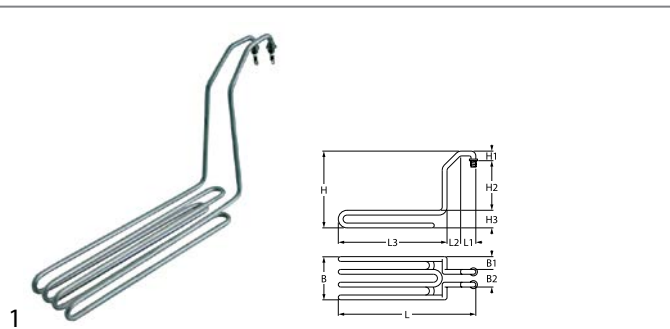

<b>GEV No.</b>	416742	<b>Ref. No.</b>	D02099
<b>description</b>	heating element 6000W 230V heating circuits 1 L 460mm W 86mm H 290mm 2 hole fixing connection M4 immersion heater L1 60mm L2 30mm L3 370mm W1 20mm W2 46mm H1 20mm H2 220mm H3 50mm tube ø 8mm thread M11x1 mounting distance 38mm		
<b>accessories for</b>	416742		
	<b>GEV No.</b>	521103	<b>Ref. No.</b> —
	nut thread M4 H 3mm WS 7 brass Qty 20 pcs		
	<b>GEV No.</b>	521104	<b>Ref. No.</b> —
	washer ID ø 4.3mm ED ø 8mm thickness 0.5mm brass Qty 20 pcs for thread M4		
	<b>GEV No.</b>	560111	<b>Ref. No.</b> —
	plain washer ID ø 4.3mm ED ø 9mm thickness 0.8mm SS Qty 20 pcs DIN 125A for thread M4		
	<b>GEV No.</b>	560131	<b>Ref. No.</b> —
	hexagonal nut thread M4 H 3.2mm WS 7 SS DIN/ISO DIN 934 / ISO 4032/8673 Qty 20 pcs		

heating elements for griddles



<b>GEV No.</b>	419177	<b>Ref. No.</b>	D02169
<b>description</b>	heating element 1750W 230V heating circuits 1 L 255mm W 240mm H 60mm tube ø 6.3mm cable length 600mm bain marie connection distance 234mm dry heating element		

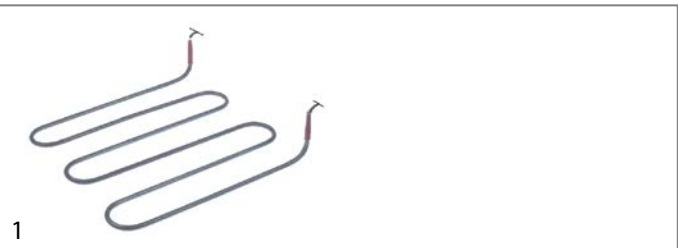

<b>GEV No.</b>	416700	<b>Ref. No.</b>	D02141
<b>description</b>	heating element 1750W 240V heating circuits 1 L 275mm W 270mm tube ø 6.3mm W1 50mm W2 170mm windings 4 bain marie dry heating element		
<b>For models:</b>	PSE600		

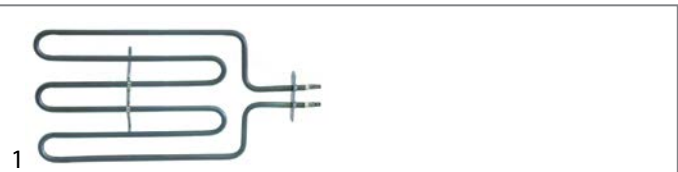

<b>GEV No.</b>	416772	<b>Ref. No.</b>	D02011
<b>description</b>	heating element 2500W 230V heating circuits 1 L 350mm W 182mm tube ø 8.5mm L1 60mm L2 290mm W1 75mm W2 32mm rectangular flange connection male faston 6.3mm hole distance 56mm flange length 70mm flange width 22mm hole ø 4mm dry heating element		

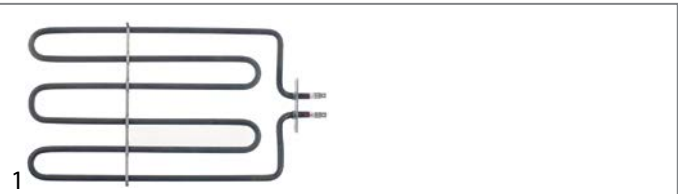

<b>GEV No.</b>	420456	<b>Ref. No.</b>	D02017 D02160
<b>description</b>	heating element 2800W 230V heating circuits 1 L 338mm W 190mm H 25mm tube ø 8mm		
<b>For models:</b>	140, 140D		



1

<b>GEV No.</b>	418622	<b>Ref. No.</b>	D02105
<b>description</b>	heating element 3000W 230V heating circuits 1 L 277mm W 245mm H 55mm tube ø 8mm connection cable cable length 600mm connection length 15mm griddle connection distance 237mm dry heating element		

heating elements for gyros grills



1

<b>GEV No.</b>	420086	<b>Ref. No.</b>	D02154
<b>description</b>	heating element 1450W 230V L 300mm W 100mm H 57mm connection M4 thread M14x1.5 tube ø 8.3mm 2 hole fixing dry heating element		



1

<b>GEV No.</b>	416704	<b>Ref. No.</b>	D02075
<b>description</b>	heating element 2500W 240V L 280mm W 190mm H 130mm connection M4 L1 143mm L2 130mm tube ø 6.3mm 2 hole fixing dry heating element thread M12x1.25		
<b>For models:</b>	GRE40, GRE60, GRE80		
<b>accessories for</b>	416704		
	<b>GEV No.</b>	550681	<b>Ref. No.</b> —
	nut thread M12x1.25 H 5mm WS 17 brass Qty 1 pcs		

heating elements for chicken rotisseries



1

<b>GEV No.</b>	416702	<b>Ref. No.</b>	D02068
<b>description</b>	heating element 1400W 230V 1 hole fixing thread M16x1.5 L 595mm heating circuits 1 connection M5 dry heating element tube ø 12mm chicken rotisserie		
<b>For models:</b>	RBE12, RBE4, RBE8		



1

<b>GEV No.</b>	420457	<b>Ref. No.</b>	D02152
<b>description</b>	heating element 1400W 230V screw mounting L 685mm W 10.5mm H 10.5mm heating circuits 1 connection M4 tube ø 10.5mm		



1

<b>GEV No.</b>	420477	<b>Ref. No.</b>	D02035
<b>description</b>	heating element 1500W 110V screw mounting L 160mm W 140mm H 45mm heating circuits 1 connection F6.3 tube ø 6.5mm		



1

<b>GEV No.</b>	420458	<b>Ref. No.</b>	D02009
<b>description</b>	heating element 1500W 230V screw mounting L 160mm W 140mm H 45mm heating circuits 1 connection F6.3 tube ø 6.5mm		



1

<b>GEV No.</b>	416705	<b>Ref. No.</b>	D02074
<b>description</b>	heating element 2500W 230V 2 hole fixing thread M16x1.5 L 557mm W 53mm heating circuits 1 connection M5 dry heating element tube ø 12.5mm mounting distance 41mm connection length 50mm mounting pos. lower grill		

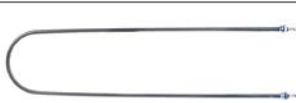

1

<b>GEV No.</b>	418843	<b>Ref. No.</b>	D02016
<b>description</b>	heating element 3000W 230V 2 hole fixing thread M14 L 705mm W 175mm heating circuits 1 connection M4 tube ø 10mm mounting distance 165mm connection length 40mm		

heating elements for hot counters



1

<b>GEV No.</b>	416777	<b>Ref. No.</b>	D02029
<b>description</b>	heating element 500W 230V heating circuits 1 L 245mm W 147mm H 28mm connection distance 140mm tube ø 6.3mm connection 6.3 dry heating element hot bar L1 38mm L2 195mm		

1

<b>GEV No.</b>	420455	<b>Ref. No.</b>	D02097
<b>description</b>	heating element 650W 230V heating circuits 1 L 183mm W 330mm H 15mm connection distance 327.5mm tube ø 6.3mm windings 2 connection F6.3		

heating elements for contact grills



1

<b>GEV No.</b>	416724	<b>Ref. No.</b>	D02095 D02112
<b>description</b>	heating element 1200W 230V L 180mm W 200mm H 38mm W1 100mm W2 50mm connection length 25mm tube ø 6.5mm windings 3 cable length 6.5mm mounting pos. lower dry heating element		
<b>For models:</b>	MAJESTIC, SAVOYE		

heating elements for hot dog machines

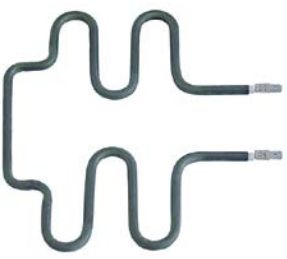

1

<b>GEV No.</b>	416718	<b>Ref. No.</b>	D02002
<b>description</b>	heating element 300W 230V L 170mm W 198mm tube ø 6.3mm L1 50mm L2 120mm W1 68mm W2 62mm connection male faston 6.3mm connection distance 56mm dry heating element heating circuits 1 hot dog machine		



1

<b>GEV No.</b>	417229	<b>Ref. No.</b>	D02159
<b>description</b>	heating element 1200W 230V L 250mm W 120mm tube ø 6.3mm windings 5 egg cooker		



1

<b>GEV No.</b>	416703	<b>Ref. No.</b>	D02001
<b>description</b>	heating element 650W 230V L 140mm W 267mm tube ø 6.5mm L1 50mm L2 89mm W1 120mm W2 56mm connection male faston 6.3mm dry heating element heating circuits 1 hot dog machine		



1

<b>GEV No.</b>	416725	<b>Ref. No.</b>	D02094 D02114
<b>description</b>	heating element 1200W 240V heating circuits 1 L 178mm W 200mm H 35mm W1 60mm W2 80mm connection distance 50mm tube ø 6.3mm windings 4 connection cable cable length 800mm mounting pos. upper dry heating element		
<b>For models:</b>	DOUBLE PANINI, PANINI		

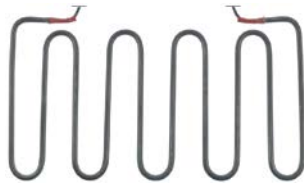

1

<b>GEV No.</b>	420454	<b>Ref. No.</b>	D02171
<b>description</b>	heating element 1200W 240V L 180mm W 320mm H 15mm tube ø 6.5mm connection F6.3 connection length 770mm windings 5		

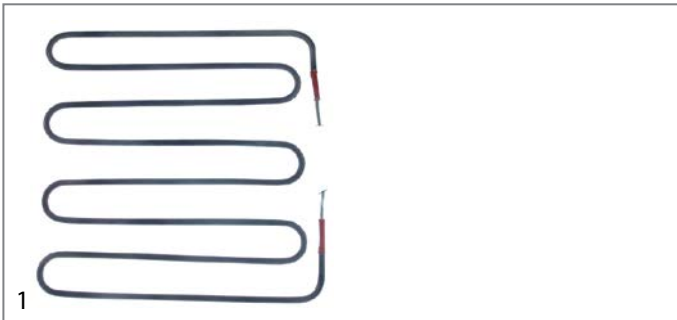

<b>GEV No.</b>	417219	<b>Ref. No.</b>	D02101
<b>description</b>	heating element 1400W 230V heating circuits 1 L 290mm W 320mm H 8mm W1 70mm W2 190mm tube ø 6.5mm windings 4 cable length 800mm bain marie		

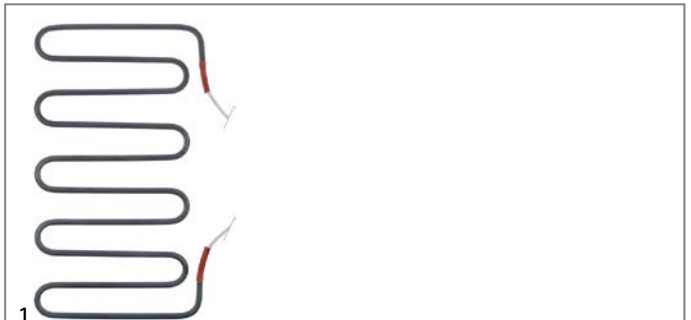

<b>GEV No.</b>	417537	<b>Ref. No.</b>	D02170
<b>description</b>	heating element 1800W 240V L 315mm W 180mm H mm		

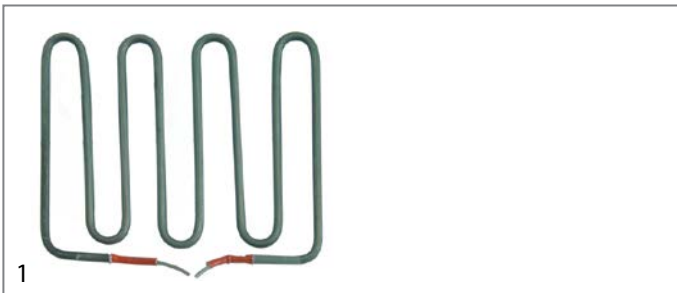

<b>GEV No.</b>	416749	<b>Ref. No.</b>	D02081
<b>description</b>	heating element 1750W 230V windings 4 griddle		
<b>For models:</b>	PSE600		

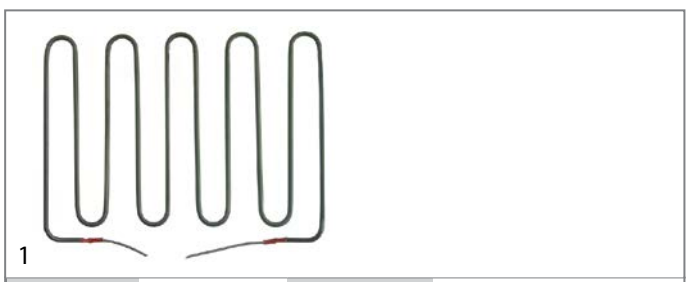

<b>GEV No.</b>	416748	<b>Ref. No.</b>	D02102 D02142
<b>description</b>	heating element 2000W 240V heating circuits 1 L 285mm W 370mm H 40mm W1 60mm W2 165mm connection distance 165mm tube ø 6.3mm windings 5 cable length 550mm dry heating element griddle		
<b>For models:</b>	PSE400		

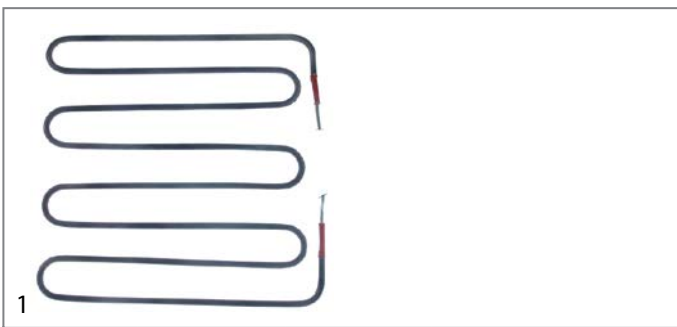

<b>GEV No.</b>	416779	<b>Ref. No.</b>	D02101
<b>description</b>	heating element 1750W 240V heating circuits 1 L 274mm W 273mm connection distance 143mm tube ø 6.3mm windings 4 cable length 550mm dry heating element bain marie		

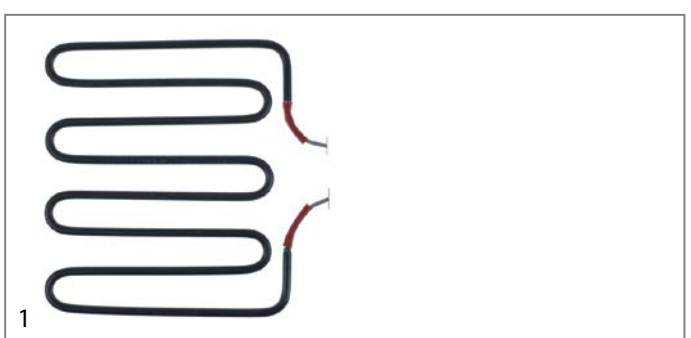

<b>GEV No.</b>	416754	<b>Ref. No.</b>	D02043
<b>description</b>	heating element 500W 110V L 180mm W 200mm W1 48mm W2 105mm tube ø 6.3mm cable length 800mm windings 4 Panini		

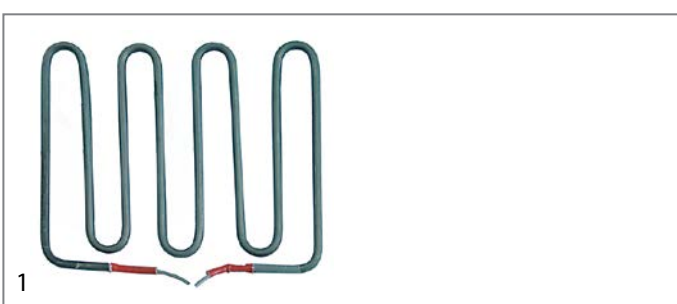

<b>GEV No.</b>	416701	<b>Ref. No.</b>	D02093 D02115
<b>description</b>	heating element 1800W 230V heating circuits 1 L 175mm W 208mm H 30mm W1 52mm W2 71mm connection length 36mm tube ø 6.3mm windings 4 connection cable cable length 300mm dry heating element		
<b>For models:</b>	DOUBLE PANINI, PANINI		

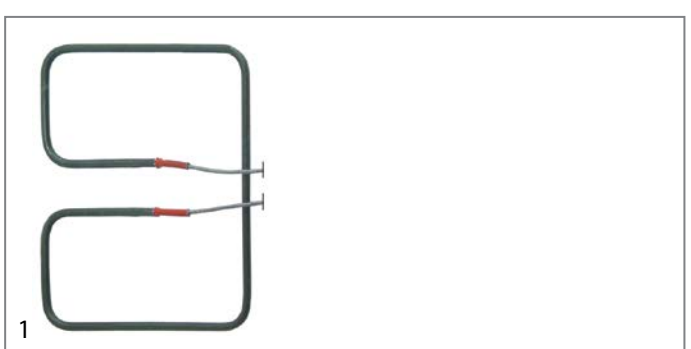

<b>GEV No.</b>	416722	<b>Ref. No.</b>	D02140
<b>description</b>	heating element 750W 230V L 175mm W 212mm H 22mm tube ø 6.5mm W1 90mm W2 33mm connection cable cable length 75mm mounting pos. upper dry heating element heating circuits 1		
<b>For models:</b>	GED10, GED20, GED30, GED40, GES10, GES20, GES30, GES40		





<b>GEV No.</b>	420539	<b>Ref. No.</b>	D02139
<b>description</b>	heating element 800W 230V L 175mm W 212mm H 22mm tube ø 6.5mm W1 90mm W2 33mm connection cable cable length 350mm mounting pos. upper dry heating element heating circuits 1		

<b>GEV No.</b>	416723	<b>Ref. No.</b>	D02096 D02113
<b>description</b>	heating element 800W 230V L 178mm W 196mm H 33mm W1 50mm W2 108mm tube ø 6.3mm windings 3 cable length 740mm mounting pos. upper dry heating element		
<b>For models:</b>	MAJESTIC, SAVOYE		

## heating elements for pasta cookers

<b>GEV No.</b>	416728	<b>Ref. No.</b>	D02084
<b>description</b>	heating element 2200W 230V heating circuits 1 L 265mm W 195mm Hmm 2 hole fixing connection M4 thread 1/4" tube ø 8.5mm mounting distance 187mm pasta cooker immersion heater		
<b>spare parts for</b>	416728		
	<b>GEV No.</b>	510417	<b>Ref. No.</b> —
	flat gasket fibre ED ø 20mm ID ø 14mm thickness 2mm Qty 1 pcs		
<b>accessories for</b>	416728		
	<b>GEV No.</b>	361182	<b>Ref. No.</b> —
	nut thread 1/4" H 5mm nickel-plated brass WS 17 Qty 1 pcs		
	<b>GEV No.</b>	520228	<b>Ref. No.</b> —
	tooth lock washer ID ø 15.3mm ED ø 24mm steel Qty 1 pcs for thread M14		
	<b>GEV No.</b>	527169	<b>Ref. No.</b> —
	hexagonal nut thread M3 H 2.8mm WS 5.5 brass Qty 1 pcs		
	<b>GEV No.</b>	550262	<b>Ref. No.</b> —
	flat gasket copper ED ø 20mm ID ø 14mm thickness 2mm		

<b>accessories for</b>	416728		
	<b>GEV No.</b>	560110	<b>Ref. No.</b> —
	plain washer ID ø 3.2mm ED ø 7mm thickness 0.5mm SS Qty 20 pcs DIN 125A for thread M3		
	<b>GEV No.</b>	560130	<b>Ref. No.</b> —
	hexagonal nut thread M3 H 2.4mm WS 5.5 SS DIN/ISO DIN 934 / ISO 4032/8673 Qty 20 pcs		

## heating elements for pizza ovens

<b>GEV No.</b>	416727	<b>Ref. No.</b>	D02148
<b>description</b>	heating element 700W 230V L 330mm W 185mm flange length 70mm flange width 22mm hole distance 56mm connection length 35mm connection male faston 6.3mm L1 25mm L2 305mm W1 77mm W2 31mm tube ø 6.3mm heating circuits 1 rectangular flange with bolt hole ø 4mm dry heating element		
<b>For models:</b>	PZ400		

## heating elements for rechauds

<b>GEV No.</b>	416712	<b>Ref. No.</b>	D02003
<b>description</b>	heating element 1300W 230V L 290mm W 258mm H 82mm L1 20mm L2 270mm mounting distance 241mm thread M12x1.25 tube ø 8.5mm connection male faston 6.3mm 2 hole fixing dry heating element		

<b>GEV No.</b>	416717	<b>Ref. No.</b>	D02004
<b>description</b>	heating element 650W 230V L 155mm W 258mm H 82mm L1 20mm L2 135mm mounting distance 252mm thread M12x1.25 tube ø 8.5mm connection male faston 6.3mm 2 hole fixing dry heating element		

## heating elements for rolling grills

<b>GEV No.</b>	416755	<b>Ref. No.</b>	D02037
<b>description</b>	heating element 125W 230V heating circuits 1 L 470mm connection M4 tube ø 8mm dry heating element roller grill		
<b>For models:</b>	RG11, RG5, RG7, RG9		



heating elements for salamanders/toast-

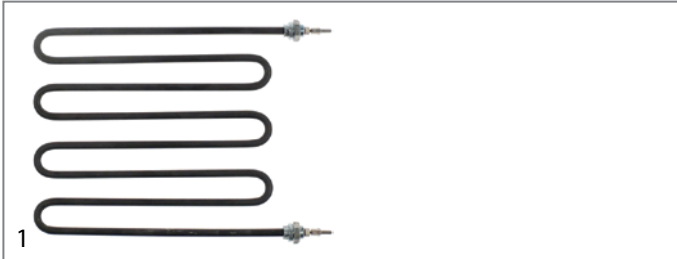

<b>GEV No.</b>	417655	<b>Ref. No.</b>	D02162
<b>description</b>	heating element 1500W 230V L 260mm W 218mm thread M14x1.5 mounting distance 210mm connection length 30mm connection M4 tube ø 8mm heating circuits 1 dry heating element 2 hole fixing		

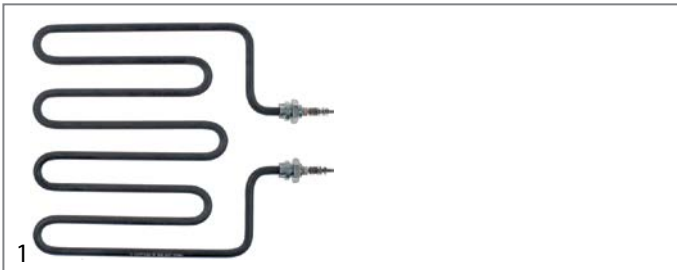

<b>GEV No.</b>	420497	<b>Ref. No.</b>	D02149
<b>description</b>	heating element 2000W 230V L 230mm W 215mm L1 22mm L2 208mm W1 74mm W2 70mm thread M16 mounting distance 55mm tube ø 8mm connection M4		



<b>GEV No.</b>	416759	<b>Ref. No.</b>	D02092
<b>description</b>	heating element 650W 115V L 614mm thread M14x1.5 connection length 25mm tube ø 8.5mm connection M4 heating circuits 1 dry heating element		
<b>For models:</b>	SEF80		



<b>GEV No.</b>	418215	<b>Ref. No.</b>	D02108
<b>description</b>	heating element 700W 245V L 410mm thread M14x1.25 connection length 19mm tube ø 10mm connection M4 heating circuits 1 dry heating element salamander grill W 10mm H 10mm		
<b>For models:</b>	SEM60		



<b>GEV No.</b>	416756	<b>Ref. No.</b>	D02091
<b>description</b>	heating element 950W 230V		
<b>For models:</b>	SEM60		

heating elements for heated cabinets

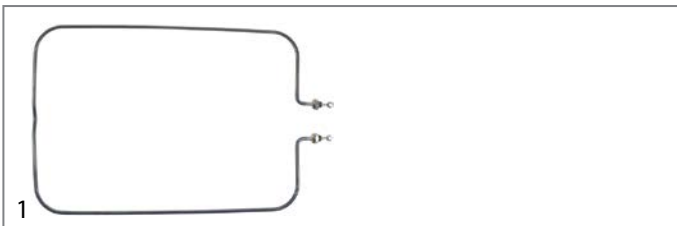

<b>GEV No.</b>	420453	<b>Ref. No.</b>	SD02107
<b>description</b>	heating element 1800W 230V L 580mm W 383mm H 8.5mm tube ø 8.5mm connection screw connection connection distance 75mm windings 1 heating circuits 1		

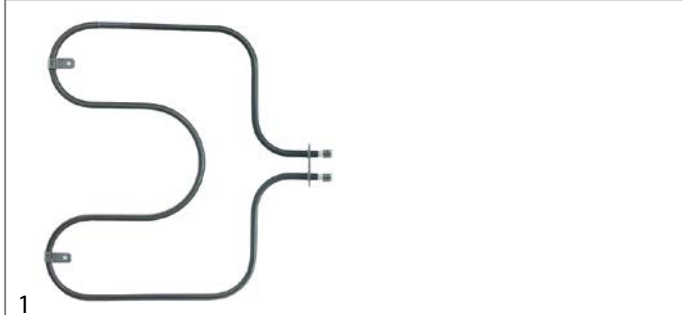

<b>GEV No.</b>	416719	<b>Ref. No.</b>	D02014
<b>description</b>	heating element 600W 230V heating circuits 1 L 259mm W 275mm flange length 44mm flange width 22mm connection male faston 6.3mm tube ø 6.5mm rectangular flange hole ø 4mm dry heating element L1 45mm L2 214mm W1 125mm W2 29mm		
<b>For models:</b>	RELAIS		

heating elements for saladettes

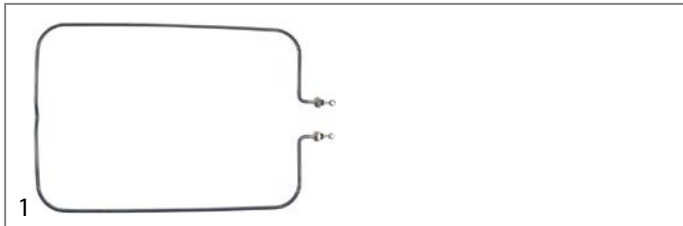

<b>GEV No.</b>	420531	<b>Ref. No.</b>	SD02108
<b>description</b>	heating element 1200W 230V L 580mm W 383mm H 8.5mm tube ø 8.5mm connection screw connection connection distance 75mm windings 1 heating circuits 1		

heaters



<b>GEV No.</b>	418822	<b>Ref. No.</b>	48006BOI
<b>description</b>	heater 250W 230V heating circuits 1 L 360mm W 68mm H 70mm cable length 1500mm with timer		

quartz heating elements



<b>GEV No.</b>	416764	<b>Ref. No.</b>	D01035
<b>description</b>	heating coil 100W 75V for quartz tube 11.50hm L1 300mm L2 255mm ø 5mm		
<b>For models:</b>	RST127, RST227		













<b>GEV No.</b>	416750	<b>Ref. No.</b>	D01033
<b>description</b>	heating coil 1100W 230V for quartz tube 410hm L1 545mm L2 435mm ø 7mm		
<b>For models:</b>	RBE12, RBE4, RBE8		





<b>GEV No.</b>	416737	<b>Ref. No.</b>	D01026
<b>description</b>	heating coil 250W 220-240V for quartz tube L1 320mm L2 220mm ø 4.5mm		
<b>For models:</b>	PZ660		



			
<b>GEV No.</b>	417654	<b>Ref. No.</b>	D01054
<b>description</b>	heating coil 330Ohm L1 160mm L2 112mm ø 5.1mm connection eye		
			
<b>GEV No.</b>	416761	<b>Ref. No.</b>	D01003
<b>description</b>	heating coil 450W 115V for quartz tube L1 340mm L2 240mm ø 4mm		
<b>For models:</b>	BAR100, BAR200		
			
<b>GEV No.</b>	416738	<b>Ref. No.</b>	D01027
<b>description</b>	heating coil 500W 220-240V for quartz tube L1 355mm L2 260mm ø 7mm		
<b>For models:</b>	PZ660		
			
<b>GEV No.</b>	416729	<b>Ref. No.</b>	D01021
<b>description</b>	heating coil 600W 230V for quartz tube L1 330mm L2 230mm ø 6mm		
			
<b>GEV No.</b>	416766	<b>Ref. No.</b>	D01036
<b>description</b>	heating coil 735W 77V for quartz tube L1 425mm L2 320mm ø 6mm		
<b>For models:</b>	RST128, RST228		
			
<b>GEV No.</b>	416708	<b>Ref. No.</b>	D01032
<b>description</b>	heating coil 750W 115V for quartz tube 180Ohm L1 380mm L2 285mm ø 6.5mm connection male faston 6.3mm		
<b>For models:</b>	SEM60		
			
<b>GEV No.</b>	416752	<b>Ref. No.</b>	D01030
<b>description</b>	heating coil for quartz tube 100Ohm L1 620mm L2 500mm ø 9mm		
			
<b>GEV No.</b>	416762	<b>Ref. No.</b>	D01043
<b>description</b>	heating coil for quartz tube L1 250mm L2 160mm ø 5mm		
<b>For models:</b>	BAR106, BAR206		
			
<b>GEV No.</b>	416706	<b>Ref. No.</b>	D01025
<b>description</b>	heating coil for quartz tube L1 260mm L2 165mm ø 6.5mm		
<b>For models:</b>	PZ330		
			
<b>GEV No.</b>	416711	<b>Ref. No.</b>	D01024
<b>description</b>	heating coil L1 245mm L2 160mm ø 5mm		
<b>For models:</b>	PZ330		

			
<b>GEV No.</b>	416758	<b>Ref. No.</b>	D01031
<b>description</b>	heating coil WV for quartz tube 210Ohm L1 290mm L2 200mm ø 6.2mm		
<b>For models:</b>	SEF80		

			
<b>GEV No.</b>	416710	<b>Ref. No.</b>	D01041 D01045
<b>description</b>	heating coil WV for quartz tube L1 160mm L2 125mm ø 5.5mm connection eye		
<b>For models:</b>	CT540		
<b>accessories for</b>	416710		
	<b>GEV No.</b>	416709	<b>Ref. No.</b>
			D04015
	 quartz tube WV L 320mm tube ø 11mm		

			
<b>GEV No.</b>	416714	<b>Ref. No.</b>	D01040 D01044
<b>description</b>	heating coil WV L1 230mm L2 195mm ø 5.5mm connection eye		
<b>For models:</b>	CT540		

			
<b>GEV No.</b>	693022	<b>Ref. No.</b>	A09001
<b>description</b>	insulator female for male faston L 20mm ø 15mm bore ø 11.5mm		

			
<b>GEV No.</b>	416775	<b>Ref. No.</b>	D04016 D04024
<b>description</b>	quartz heating element 1200W 115V L 668mm ø 10mm connection male faston 6.3mm		

			
<b>GEV No.</b>	416776	<b>Ref. No.</b>	D04025
<b>description</b>	quartz heating element 1200W 115V L 680mm ø 11mm connection male faston 6.3mm		
<b>For models:</b>	FC110G		

			
<b>GEV No.</b>	417217	<b>Ref. No.</b>	D04029
<b>description</b>	quartz heating element 200W 115V L 340mm ø 11mm connection male faston 6.3mm for model PZ330 mounting pos. lower		



1			
<b>GEV No.</b>	417216	<b>Ref. No.</b>	D04030
<b>description</b>	quartz heating element 295W 115V L 340mm ø 11mm connection male faston 6.3mm for model PZ330 mounting pos. upper		

1			
<b>GEV No.</b>	418820	<b>Ref. No.</b>	D04033
<b>description</b>	quartz heating element 460W 76V L 545mm ø 11mm connection male faston 6.3mm		

1			
<b>GEV No.</b>	418625	<b>Ref. No.</b>	D04022
<b>description</b>	quartz heating element 500W 115V L 365mm ø 10mm connection male faston 6.3mm		

1			
<b>GEV No.</b>	420460	<b>Ref. No.</b>	D04043
<b>description</b>	quartz heating element 500W 115V L 455mm ø 11mm connection F6.3 pizza oven		

1			
<b>GEV No.</b>	416713	<b>Ref. No.</b>	D04023
<b>description</b>	quartz heating element 525W 76V L 525mm ø 11mm connection male faston 6.3mm 10.8Ohm		

1			
<b>GEV No.</b>	416914	<b>Ref. No.</b>	D04028
<b>description</b>	quartz heating element 530W 77V L 478mm ø 11mm connection male faston 6.3mm		
<b>For models:</b>	FC60G		

1			
<b>GEV No.</b>	420459	<b>Ref. No.</b>	D04040
<b>description</b>	quartz heating element 580W 115V L 455mm ø 11mm connection F6.3 pizza oven		

1				
<b>GEV No.</b>	420089	<b>Ref. No.</b>	D04034	
<b>description</b>	quartz heating element 600W 115V L 365mm ø 11mm connection male faston 6.3mm			
<b>accessories for</b>	420089			
	<b>GEV No.</b>	551108	<b>Ref. No.</b>	B07025
	spring clip stainless steel for quartz heating element L 39mm W 25mm H 13.5mm bore ø 10mm			

1			
<b>GEV No.</b>	416733	<b>Ref. No.</b>	D04001
<b>description</b>	quartz heating element 750W 115V L 415mm		
<b>For models:</b>	FC33		

1			
<b>GEV No.</b>	416732	<b>Ref. No.</b>	D04001 D04020
<b>description</b>	quartz heating element 750W 115V L 415mm ø 11mm connection male faston 6.3mm		

1			
<b>GEV No.</b>	420461	<b>Ref. No.</b>	D04038
<b>description</b>	quartz heating element 750W 115V L 684mm ø 11mm connection F6.3 pizza oven		

1			
<b>GEV No.</b>	416765	<b>Ref. No.</b>	D04010
<b>description</b>	quartz tube L 620mm ID ø 8.5mm ED ø 10.5mm		
<b>For models:</b>	RST128, RST228		

1			
<b>GEV No.</b>	416751	<b>Ref. No.</b>	D04003
<b>description</b>	quartz tube L 625mm ID ø 9.5mm ED ø 15.5mm		
<b>For models:</b>	RBE12, RBE4, RBE8		

1				
<b>GEV No.</b>	420498	<b>Ref. No.</b>	D04037	
<b>description</b>	quartz tube WV heating circuits L 725mm W 15mm H 15mm tube ø 15mm			
<b>accessories for</b>	420498			
	<b>GEV No.</b>	416750	<b>Ref. No.</b>	D01033
	heating coil 1100W 230V for quartz tube 41Ohm L1 545mm L2 435mm ø 7mm			



1			
<b>GEV No.</b>	416757	<b>Ref. No.</b>	D04006
<b>description</b>	quartz tube WV L 315mm tube ø 11mm ID ø 9mm		
<b>For models:</b>	SEF80		

1				
<b>GEV No.</b>	416709	<b>Ref. No.</b>	D04015	
<b>description</b>	quartz tube WV L 320mm tube ø 11mm			
<b>For models:</b>	CT540			
<b>accessories for</b>	416709			
	<b>GEV No.</b>	416766	<b>Ref. No.</b>	D01036
	heating coil 735W 77V for quartz tube L1 425mm L2 320mm ø 6mm			

1			
<b>GEV No.</b>	416760	<b>Ref. No.</b>	D04005
<b>description</b>	quartz tube WV L 365mm tube ø 11mm		
<b>For models:</b>	BAR100, BAR106, BAR200, BAR206		

1			
<b>GEV No.</b>	416715	<b>Ref. No.</b>	D04007
<b>description</b>	quartz tube WV L 460mm tube ø 11mm		
<b>For models:</b>	SEM60		



1 			
<b>GEV No.</b>	416763	<b>Ref. No.</b>	D04009
<b>description</b>	quartz tube WV L 510mm tube ø 11mm		
<b>For models:</b>	RST127, RST227		
<b>accessories for</b>	416763		
	<b>GEV No.</b>	416764	<b>Ref. No.</b> D01035
	heating coil 100W 75V for quartz tube 11.5Ohm L1 300mm L2 255mm ø 5mm		
	<b>GEV No.</b>	693022	<b>Ref. No.</b> A09001
	insulator female for male faston L 20mm ø 15mm bore ø 11.5mm		

1 			
<b>GEV No.</b>	416731	<b>Ref. No.</b>	D02052
<b>description</b>	heating element 1500W 230V rectangular flange		
<b>For models:</b>	FC26, TH1		

1 			
<b>GEV No.</b>	416736	<b>Ref. No.</b>	D04013
<b>description</b>	quartz tube WV L 695mm tube ø 11mm		
<b>For models:</b>	PZ660		

1 			
<b>GEV No.</b>	420088	<b>Ref. No.</b>	D02158
<b>description</b>	heating element 2400W 230V heating circuits 1 ID ø 135mm ED ø 145mm L 162mm H 61mm L1 7mm W1 27mm H1 33mm H2 28mm connection male faston 6.3mm tube ø 6.3mm		

1 			
<b>GEV No.</b>	416753	<b>Ref. No.</b>	D04011
<b>description</b>	quartz tube WV L 780mm ID ø 10.5mm ED ø 14.5mm		

1 			
<b>GEV No.</b>	551108	<b>Ref. No.</b>	B07025
<b>description</b>	spring clip stainless steel for quartz heating element L 39mm W 25mm H 13.5mm bore ø 10mm		



1 			
<b>GEV No.</b>	416730	<b>Ref. No.</b>	D02143
<b>description</b>	heating element 2500W 230V heating circuits 1 ID ø 177mm ED ø 189mm L 253mm H 53mm L1 58mm W1 32mm H1 28mm H2 25mm flange length 47mm flange width 17mm hole distance 36mm connection male faston 6.3mm connection length 28mm tube ø 6.5mm convection heating element mounting thread M4 rectangular flange		
<b>For models:</b>	CN, FC33		

## heating elements for convection

1 			
<b>GEV No.</b>	416770	<b>Ref. No.</b>	D02144
<b>description</b>	heating element 1500W 230V heating circuits 1 ID ø 175mm ED ø 188mm L 256mm H 29mm L1 60mm W1 26mm H1 5mm H2 20mm flange length 45mm flange width 16mm hole distance 36mm connection male faston 6.3mm tube ø 6.3mm convection heating element mounting thread M4 rectangular flange with thread bolt		

1 			
<b>GEV No.</b>	416734	<b>Ref. No.</b>	D02086
<b>description</b>	heating element 2500W 240V heating circuits 1 ID ø 176mm ED ø 188mm L 252mm H 30mm L1 56mm W1 24mm H1 20mm H2 10mm flange length 47mm flange width 17mm hole distance 35mm connection male faston 6.3mm tube ø 6.3mm convection heating element mounting thread M4 rectangular flange with thread bolt		
<b>For models:</b>	FC34		



			
1			
<b>GEV No.</b>	416773	<b>Ref. No.</b>	D02034
<b>description</b>	heating element 3000W 230V heating circuits 1 ID ø 185mm ED ø 198mm L 210mm H 35mm L1 10mm W1 30mm H1 7mm H2 25mm flange length 70mm flange width 22mm hole distance 56mm connection male faston 6.3mm connection length 36mm tube ø 6.3mm convection heating element hole ø 5mm rectangular flange		
<b>For models:</b>	FC60, FC60G		
<b>accessories for</b>	416773		
	<b>GEV No.</b>	510368	<b>Ref. No.</b> —
	gasket L 70mm W 23.5mm hole ø 5mm hole distance 56mm FIBER thickness 2mm for heating element		

			
1			
<b>GEV No.</b>	416774	<b>Ref. No.</b>	D02045
<b>description</b>	heating element 5000W 230V heating circuits 1 ID ø 224mm ED ø 242mm L 273mm H 41mm L1 25mm W1 35mm H1 3mm H2 38mm flange length 101mm flange width 22mm hole distance 86mm connection male faston 6.3mm connection length 43mm tube ø 8.4mm convection heating element hole ø 4mm rectangular flange		
<b>For models:</b>	FC110, FC110G		

			
1			
<b>GEV No.</b>	420087	<b>Ref. No.</b>	D02151
<b>description</b>	heating element 6000W 240V heating circuits 2 ID ø 240mm ED ø 250mm L 267mm H 46mm L1 19mm W1 60mm H1 12mm H2 34mm flange length 100mm flange width 22mm hole distance 86mm connection male faston 6.3mm tube ø 6.2mm convection heating element hole ø 4mm		

## radiation heaters

			
1			
<b>GEV No.</b>	420540	<b>Ref. No.</b>	D06003 D06006 D06009
<b>description</b>	radiation heater 1500W 230V L 295mm W 250mm H 35mm heating circuits eye connection type threaded cable length 1230mm		

## hot plates

## round

## with radiused edge

## for domestic and commercial kitchens

			
1			
<b>GEV No.</b>	490130	<b>Ref. No.</b>	D03016
<b>description</b>	hot plate ø 220mm 2000W 230V connection 4 screw clamps with 8mm spill ring		

## energy regulators

## EGO

## 1-circuit

			
1			
<b>GEV No.</b>	390501	<b>Ref. No.</b>	A04006
<b>description</b>	energy regulator		
<b>For models:</b>	140, 140D, RG11, RG5, RG7, RG9		

			
1			
<b>GEV No.</b>	380015	<b>Ref. No.</b>	A04006
<b>description</b>	energy regulator 230V 13A single-circuit turn direction right shaft ø 6x4.6mm shaft L 23mm mounting thread M4 power release 6-100% no. 50.57021.010		



thermostats

bi-metal thermostats

bi-metal thermostats



<b>GEV No.</b>	390503	<b>Ref. No.</b>	A06034 A06034/1
<b>description</b>	bi-metal thermostat hole distance 23.5mm switch-off temp. 135°C 1NC 1-pole 10A connection F6.3 2 hole fixing		
<b>For models:</b>	FC110, FC110G, FC60		



<b>GEV No.</b>	390652	<b>Ref. No.</b>	A06035 A06035/1
<b>description</b>	bi-metal thermostat hole distance 23.5mm switch-off temp. 170°C 1NCA connection F6.3 vertical		



<b>GEV No.</b>	390504	<b>Ref. No.</b>	A06048
<b>description</b>	bi-metal thermostat hole distance 23.8mm switch-off temp. 90°C 1NO 1-pole 16A 250V connection F6.3 2 hole fixing probe ø 16mm		
<b>For models:</b>	FC110, FC110G		

control and safety thermostats

EGO

control thermostats

55.13\_ series



<b>GEV No.</b>	375007	<b>Ref. No.</b>	A06044
<b>description</b>	thermostat t.max. 110°C temperature range 30-110°C 1-pole 1NO 16A probe ø 6mm probe L 113mm capillary pipe 870mm capillary pipe isolatedmm gland nut M9x1 shaft L 25mm shaft position upper rotation 270°		
<b>accessories for</b>	375007		
	<b>GEV No.</b>	110119	<b>Ref. No.</b> —
	knob thermostat t.max. 110°C ø 50mm shaft ø 6x4.6mm shaft flat upper black temperature range 30-110°C rotation 270°		
	<b>GEV No.</b>	110241	<b>Ref. No.</b> —
	knob thermostat t.max. 110°C ø 50mm shaft ø 6x4.6mm shaft flat upper black temperature range 30-110°C		



<b>GEV No.</b>	375505	<b>Ref. No.</b>	A06042
<b>description</b>	thermostat t.max. 320°C temperature range 50-320°C 1-pole 1NO 16A probe ø 3mm probe L 160mm capillary pipe 870mm capillary pipe isolatedmm gland nut shaft ø 6x4.6mm shaft L 23mm shaft position upper rotation 270°		
<b>For models:</b>	350E, 350ED, 400E, 400ED, 400FE, CN, FC110, FC110G, FC26, FC33, FC34, FC60, FC60G, PSE400, PSE600, PZ330, PZ400, PZ660		



<b>GEV No.</b>	375005	<b>Ref. No.</b>	A06002 A06041
<b>description</b>	thermostat t.max. 85°C temperature range 30-85°C 1-pole 1NO 16A probe ø 6mm probe L 92mm capillary pipe 830mm capillary pipe isolatedmm gland nut shaft L 23mm shaft position upper rotation 270° probe material SS		
<b>For models:</b>	RELAIS		
<b>accessories for</b>	375005		
	<b>GEV No.</b>	110109	<b>Ref. No.</b> —
	knob thermostat t.max. 85°C ø 60mm shaft ø 6x4.6mm shaft flat upper silver temperature range 30-85°C rotation 270°		
	<b>GEV No.</b>	110133	<b>Ref. No.</b> —
	knob thermostat t.max. 85°C ø 50mm shaft ø 6x4.6mm shaft flat upper black temperature range 30-85°C rotation 270°		
	<b>GEV No.</b>	110240	<b>Ref. No.</b> —
	knob thermostat t.max. 85°C ø 50mm shaft ø 6x4.6mm shaft flat upper black temperature range 30-85°C		



<b>GEV No.</b>	375400	<b>Ref. No.</b>	A06021
<b>description</b>	thermostat t.max. 90°C temperature range 30-90°C 1-pole 1CO 16A probe ø 6mm probe L 98mm capillary pipe 2380mm capillary pipe isolated 1700mm gland nut M9x1 shaft ø 6x4.6mm shaft L 18mm shaft position upper rotation 270°		

55.17\_ series

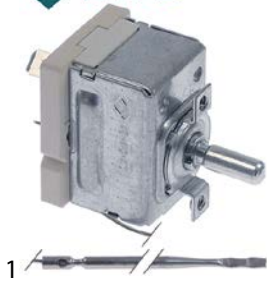

<b>GEV No.</b>	371320	<b>Ref. No.</b>	A06032
<b>description</b>	thermostat t.max. 280°C temperature range 30-280°C 1-pole 1NO 16A probe ø 3mm probe L 170mm capillary pipe 860mm capillary pipe isolatedmm gland nut shaft L 14mm shaft position upper rotation 270°		
<b>For models:</b>	DOUBLE PANINI, GED10, GED20, GED30, GED40, GES10, GES20, GES30, GES40, MAJESTIC, PANINI, SAVOYE		

55.34\_ series



<b>GEV No.</b>	375417	<b>Ref. No.</b>	A06005
<b>description</b>	thermostat t.max. 200°C temperature range 65-200°C 3-pole 3NO 16A probe ø 6mm probe L 79mm capillary pipe 840mm capillary pipe isolatedmm gland nut M9x1 shaft ø 6x4.6mm shaft L 23mm rotation 270°		

safety thermostats

55.11\_ series

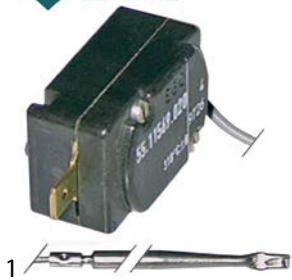

<b>GEV No.</b>	375109	<b>Ref. No.</b>	A06004
<b>description</b>	safety thermostat switch-off temp. 240°C 1-pole 16A probe ø 4mm probe L 91mm capillary pipe 530mm capillary pipe isolated 350mm gland nut probe SS		

55.32\_ series

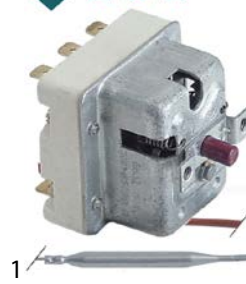

<b>GEV No.</b>	375600	<b>Ref. No.</b>	A06012
<b>description</b>	safety thermostat switch-off temp. 230°C 3-pole 20A probe ø 6mm probe L 87mm capillary pipe 890mm capillary pipe isolatedmm gland nut		

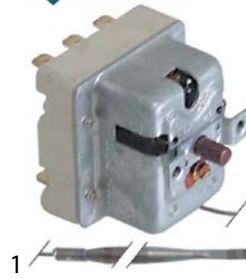

<b>GEV No.</b>	375418	<b>Ref. No.</b>	A06012 A06059
<b>description</b>	safety thermostat switch-off temp. 340°C 3-pole 20A probe ø 4mm probe L 128mm capillary pipe 1190mm capillary pipe isolatedmm gland nut probe SS		

IMIT / TEMPOMATIC / ARTHERMO

control thermostats



<b>GEV No.</b>	390006	<b>Ref. No.</b>	A06003 A06011
<b>description</b>	thermostat t.max. 86°C temperature range 0-86°C 1-pole 1CO 16A probe ø 6.5mm probe L 95mm capillary pipe 1500mm capillary pipe isolatedmm gland nut shaft ø 6x4.6mm shaft L 19mm rotation 270°		

<b>accessories for</b>	390006			
	<b>GEV No.</b>	110100	<b>Ref. No.</b>	—
	knob thermostat t.max. 90°C 0-90°C ø 42mm shaft ø 6x4.6mm shaft flat -135° black			
	<b>GEV No.</b>	110105	<b>Ref. No.</b>	—
	rosette knob ø 42mm ø 56mm zero mark			





TECASA

control thermostats



<b>GEV No.</b>	390502	<b>Ref. No.</b>	A06006
<b>description</b>	thermostat capillary pipe isolatedmm gland nut		

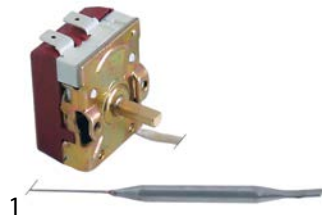

<b>GEV No.</b>	375177	<b>Ref. No.</b>	A06018
<b>description</b>	thermostat t.max. 170°C temperature range 50-170°C 1-pole 1NO 16A probe ø 6mm probe L 75mm capillary pipe 420mm capillary pipe isolated 210mm gland nut shaft L 15mm shaft position upper rotation 270°		

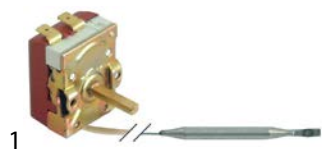

<b>GEV No.</b>	375506	<b>Ref. No.</b>	A06007 A06026 A06056
<b>description</b>	thermostat t.max. 190°C temperature range 50-190°C 1-pole 1NO 16A probe ø 6mm probe L 75mm capillary pipe 630mm capillary pipe isolated 140mm gland nut shaft ø 6x4.6mm shaft L 23mm shaft position upper rotation 270°		

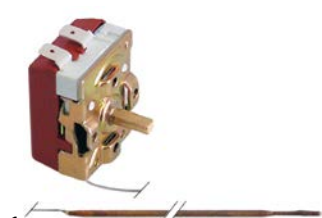

<b>GEV No.</b>	375155	<b>Ref. No.</b>	A06019
<b>description</b>	thermostat t.max. 230°C temperature range 45-230°C 1-pole 1NO 16A probe ø 3.1mm probe L 150mm capillary pipe 530mm capillary pipe isolatedmm gland nut shaft L 14mm shaft position upper rotation 270°		
<b>For models:</b>	TH1		



<b>GEV No.</b>	375134	<b>Ref. No.</b>	A06032 (old version) NT-253M W11/16 40-280°C
<b>description</b>	thermostat t.max. 280°C temperature range 30-280°C 1-pole 1NO 16A probe ø 3mm probe L 170mm capillary pipe 860mm capillary pipe isolatedmm gland nut shaft L 14mm shaft position upper rotation 270°		

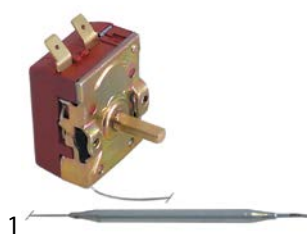

<b>GEV No.</b>	375168	<b>Ref. No.</b>	A06049
<b>description</b>	thermostat t.max. 55°C temperature range 30-55°C 1-pole 1NO 16A probe ø 6mm probe L 105mm capillary pipe 880mm capillary pipe isolatedmm gland nut shaft ø 6x4.6mm shaft L 16mm shaft position upper rotation 270°		



<b>GEV No.</b>	390500	<b>Ref. No.</b>	A06021
<b>description</b>	thermostat t.max. 95°C temperature range 0-95°C 1-pole 1NO 16A probe ø 6mm probe L 105mm capillary pipe 900mm capillary pipe isolatedmm gland nut shaft ø 6x4.6mm shaft L 16mm shaft position upper rotation 270°		

safety thermostats



<b>GEV No.</b>	375452	<b>Ref. No.</b>	A06001
<b>description</b>	safety thermostat switch-off temp. 230°C 1-pole 16A probe ø 6mm probe L 52mm capillary pipe 520mm capillary pipe isolated 70mm gland nut starting temperature 216°C probe SS		
<b>For models:</b>	FD120R		



<b>GEV No.</b>	375176	<b>Ref. No.</b>	A06017
<b>description</b>	safety thermostat switch-off temp. 230°C 1-pole 16A probe ø 6mm probe L 68mm capillary pipe 430mm		

refrigeration thermostats

DANFOSS

control thermostats



<b>GEV No.</b>	391001	<b>Ref. No.</b>	SA06043
<b>description</b>	thermostat type 077B0804L capillary pipe 810mm temperature range +6 up to +15°C		

accessories

connecting bows





<b>GEV No.</b>	550059	<b>Ref. No.</b>	A01023
<b>description</b>	connecting bow short for switch Qty 1 pcs		

switches and momentary switches

rocker/momentary rocker switches

19x13mm



<b>GEV No.</b>	301066	<b>Ref. No.</b>	A07005	
<b>description</b>	rocker switch mounting measurements 19x13mm black 2NO 250V 6A 0-I connection male faston 4.8mm ambient temperature max. 85°C protection IP40			
<b>For models:</b>	TH1			
<b>accessories for</b>	301066			
	<b>GEV No.</b>	301064	<b>Ref. No.</b>	—
	protective cover for pressure switch external size 23.4x17.4mm internal size 19x13mm H 7.5mm clear mounting measurementsmm			

30x11mm



<b>GEV No.</b>	301010	<b>Ref. No.</b>	A07012	
<b>description</b>	rocker switch mounting measurements 30x11mm red 1NO/indicator light 250V 16A 0-I connection male faston 6.3mm ambient temperature max. 85/125°C protection IP40			
<b>For models:</b>	GED10, GED20, GED30, GED40, GES10, GES20, GES30, GES40, PZ330, PZ400, PZ660, WDL100, WDL200			
<b>accessories for</b>	301010			
	<b>GEV No.</b>	301035	<b>Ref. No.</b>	—
	protective cover mounting measurements 30x11mm			

30x22mm



<b>GEV No.</b>	301202 <sup>1</sup>	<b>Ref. No.</b>	A07025 A07027 A07030
<b>description</b>	rocker switch mounting measurements 30x22mm black 2NO 230V 20A 0-1 connection male faston 6.3mm ambient temperature max. 125/55°C protection IP65 with rubber collar		

<sup>1</sup>non-illuminated





<b>GEV No.</b>	346896 <sup>1</sup>	<b>Ref. No.</b>	A07020 A07025 A07027 A07030
<b>description</b>	rocker switch mounting measurements 30x22mm black 2NO 250V 16A 0-I connection male faston 6.3mm ambient temperature max. 125/55°C protection IP65		
<b>For models:</b>	DOUBLE PANINI, MAJESTIC, PANINI, PSE400, PSE600, RG11, RG5, RG7, RG9, SAVOYE		

<sup>1</sup>non-illuminated







<b>GEV No.</b>	347791	<b>Ref. No.</b>	A07034
<b>description</b>	rocker switch mounting measurements 30x22mm green 2NO 230V 20A illuminated 0-I connection male faston 6.3mm ambient temperature max. 125/55°C protection IP65 with rubber collar		







<b>GEV No.</b>	301003	<b>Ref. No.</b>	A07032	
<b>description</b>	rocker switch mounting measurements 30x22mm green 2NO 250V 16A illuminated 0-I connection male faston 6.3mm ambient temperature max. 125/55°C protection IP65			
<b>accessories for</b>	301003			
	<b>GEV No.</b>	301036	<b>Ref. No.</b>	—
	protective cover internal size 30x22mm for rocker switch mounting measurementsmm			



			
1			
<b>GEV No.</b>	301001	<b>Ref. No.</b>	A07003
<b>description</b>	rocker switch mounting measurements 30x22mm red 2NO 250V 16A illuminated 0-I connection male faston 6.3mm ambient temperature max. 125/55°C protection IP65		
<b>For models:</b>	RBG12, RBG4, RBG8		
<b>accessories for</b>	301001		
	<b>GEV No.</b>	301036	<b>Ref. No.</b> —
	protective cover internal size 30x22mm for rocker switch mounting measurementsmm		

			
1			
<b>GEV No.</b>	301004	<b>Ref. No.</b>	A07022
<b>description</b>	rocker switch mounting measurements 30x22mm black 2CO 250V 16A connection male faston 6.3mm ambient temperature max. 125/55°C protection IP40		
<b>For models:</b>	FC33		
<b>accessories for</b>	301004		
	<b>GEV No.</b>	301036	<b>Ref. No.</b> —
	protective cover internal size 30x22mm for rocker switch mounting measurementsmm		

labelled			
			
1			
<b>GEV No.</b>	301200	<b>Ref. No.</b>	A070029
<b>description</b>	rocker switch mounting measurements 30x22mm black 2NO 230V 16A 0-1 connection male faston 6.3mm ambient temperature max. 85°C protection IP65 with cover cap		
<b>For models:</b>	GRE40, GRE60, GRE80, RBE12, RBE4, RBE8		
<b>accessories for</b>	301200		
	<b>GEV No.</b>	301036	<b>Ref. No.</b> —
	protective cover internal size 30x22mm for rocker switch mounting measurementsmm		

			
1			
<b>GEV No.</b>	300125	<b>Ref. No.</b>	A07002
<b>description</b>	rocker switch mounting measurements 30x22mm green 2NO 230V 16A 0-I connection male faston 6.3mm ambient temperature max. 125/55°C protection IP65 with cover cap		
<b>accessories for</b>	300125		
	<b>GEV No.</b>	301036	<b>Ref. No.</b> —
	protective cover internal size 30x22mm for rocker switch mounting measurementsmm		

## push/momentary push switches

### 19x13mm

			
1			
<b>GEV No.</b>	301054	<b>Ref. No.</b>	A07014 A07015
<b>description</b>	momentary push switch mounting measurements 19x13mm red 1NO 250V 16A connection male faston 6.3mm ambient temperature max. 105/55°C protection IP65 with cover cap		

			
1			
<b>GEV No.</b>	347079 <sup>1</sup>	<b>Ref. No.</b>	A07033
<b>description</b>	push switch mounting measurements 19x13mm green 2NO 250V 16A illuminated connection male faston 6.3mm ambient temperature max. 125°C protection IP65 with cover cap		

<sup>1</sup>illuminated

## microswitches

### lever actuated

			
1			
<b>GEV No.</b>	345699	<b>Ref. No.</b>	A07017
<b>description</b>	microswitch with lever 250V 10A 1NO connection male faston 6.3mm ambient temperature max. 85°C		
<b>For models:</b>	FC110, FC110G		

### pin-plunger actuated

			
1			
<b>GEV No.</b>	345060	<b>Ref. No.</b>	A07011
<b>description</b>	microswitch with plunger 250V 16A 1NO connection male faston 6.3mm ambient temperature max. 85°C mounting distance 22mm type BS1010 actuating force: 350g red stroke 9mm		



			
1			
<b>GEV No.</b>	345062	<b>Ref. No.</b>	A07023
<b>description</b>	microswitch with plunger 250V 16A 1NO/1NC connection male faston 6.3mm ambient temperature max. 85°C mounting distance 22mm type BS1012 actuating force: 350g red stroke 8mm		
<b>For models:</b>	FC33		



M10			
			
1			
<b>GEV No.</b>	346864	<b>Ref. No.</b>	A07018 A07035
<b>description</b>	microswitch with plunger thread M10x0.75 thread L 6mm 250V 10A 1NO connection male faston 6.3mm stroke 3mm mounting distance 22mm ambient temperature max. 125°C actuating force: 200g		
<b>For models:</b>	FD120R		

cam switches

on/off

			
1			
<b>GEV No.</b>	300020	<b>Ref. No.</b>	A01015 A01016
<b>description</b>	cam switch 4 operating positions 2NO sequence 0-1-0-1 16A shaft ø 6x4.6mm shaft L 23mm connection screw ceramic		
<b>accessories for</b>	300020		
	<b>GEV No.</b>	110135	<b>Ref. No.</b> —
	rosette knob up to ø 52mm		
	<b>GEV No.</b>	110231	<b>Ref. No.</b> —
	knob switch 0-1-0-1 t.max.°C ø 50mm shaft ø 6x4.6mm shaft flat upper black		

4-position

			
1			
<b>GEV No.</b>	300094	<b>Ref. No.</b>	A01001
<b>description</b>	cam switch 4 operating positions 1NO/2CO sequence 0-1-2-3 16A shaft ø 6x4.6mm shaft L 15mm connection screw 4-position ceramic		
<b>For models:</b>	BAR100, BAR106, BAR200, BAR206, CT540, GRE40, GRE60, GRE80, RBE12, RBE4, RBE8, RST127, RST128, RST227, RST228, SEF80, SEM60		

			
1			
<b>GEV No.</b>	300104	<b>Ref. No.</b>	A01002
<b>description</b>	cam switch 4 operating positions 3NO/1CO sequence 0-1-2-3 32A shaft ø 6x4.6mm shaft L 23mm connection screw ceramic		

4 operating positions

			
1			
<b>GEV No.</b>	347101	<b>Ref. No.</b>	A01017
<b>description</b>	cam switch 4 operating positions 1NO/1CO sequence 0-1-2-3 13A shaft ø 6x4.6mm shaft L 23mm connection male faston 6.3mm plastic		

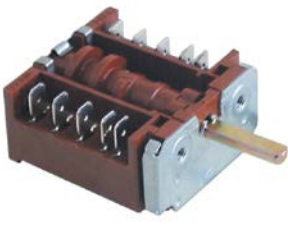
			
1			
<b>GEV No.</b>	345320	<b>Ref. No.</b>	A01009
<b>description</b>	cam switch 4 operating positions 4NO sequence 0-1-2-3 16A shaft ø 6x4.6mm shaft L 23mm connection male faston 6.3mm plastic		

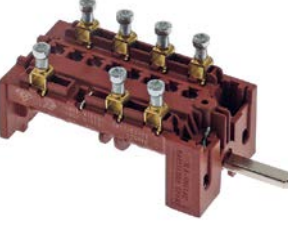
			
1			
<b>GEV No.</b>	348143	<b>Ref. No.</b>	A01001/1
<b>description</b>	cam switch 4 operating positions 5NO sequence 0-1-2-3 16A shaft ø 6x4.6mm shaft L 23mm connection male faston 6.3mm 8410R plastic		

1

<b>GEV No.</b>	300143	<b>Ref. No.</b>	A01014
<b>description</b>	cam switch 4 operating positions sequence 0-1-2-3 13A shaft $\varnothing$ 6x4.6mm shaft L 13mm connection male faston 6.3mm 250V plastic open A+1, B+3 A+1, A+2 A+1, B+4 shaft round sets of contacts 2 ambient temperature max. 150°C		
<b>For models:</b>	FC110G		

### 5 operating positions

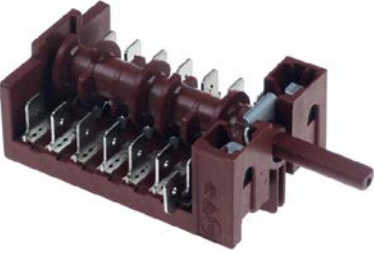

1

<b>GEV No.</b>	300238	<b>Ref. No.</b>	A01006
<b>description</b>	cam switch 5 operating positions shaft $\varnothing$ 6x4.6mm connection male faston 6.3mm 7-pole		
<b>For models:</b>	FC60G		

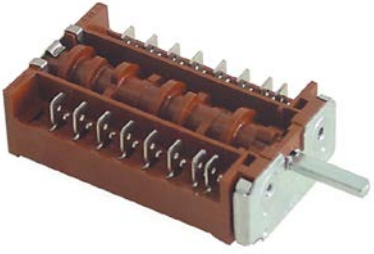

1

<b>GEV No.</b>	300142	<b>Ref. No.</b>	A01006
<b>description</b>	cam switch 5 operating positions shaft $\varnothing$ 6x4.6mm connection male faston 7-pole		

### operation switches

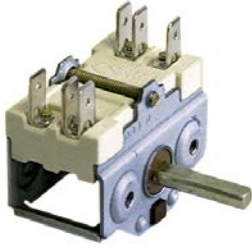

1

<b>GEV No.</b>	300001	<b>Ref. No.</b>	A01022	
<b>description</b>	cam switch operation switch 16A sequence 0-1 shaft $\varnothing$ 6x4.6mm connection male faston 6.3mm 2-pole			
<b>accessories for</b>	300001			
	<b>GEV No.</b>	551456	<b>Ref. No.</b>	—
	gasket for switch ED $\varnothing$ 14mm ID $\varnothing$ 2.5mm thickness 3.5mm white			

### miscellaneous



1

<b>GEV No.</b>	347585	<b>Ref. No.</b>	A01020 A01021
<b>description</b>	rotary switch 2NO shaft $\varnothing$ 6x4.6mm shaft L 23mm 2-pole		

### encoders and potentiometers



1

<b>GEV No.</b>	300144	<b>Ref. No.</b>	A04004 A04005
<b>description</b>	potentiometer 0.5KOhm		
<b>For models:</b>	CT540		



## lamps

## indicator lights

## indicator lights (complete)

ø 9mm



<b>GEV No.</b>	359286	<b>Ref. No.</b>	A08006
----------------	--------	-----------------	--------

<b>description</b>	indicator light ø 9mm 230V green with cord
--------------------	--

<b>For models:</b>	RELAIS
--------------------	--------



<b>GEV No.</b>	359287	<b>Ref. No.</b>	A08001
----------------	--------	-----------------	--------

<b>description</b>	indicator light ø 9mm 230V red
--------------------	--------------------------------

<b>For models:</b>	RELAIS
--------------------	--------

ø12mm

with screw socket



<b>GEV No.</b>	359026	<b>Ref. No.</b>	A08019
----------------	--------	-----------------	--------

<b>description</b>	indicator light ø 12mm 230V red connection male faston 6.3mm model CM/5
--------------------	---



<b>GEV No.</b>	359027	<b>Ref. No.</b>	A08020
----------------	--------	-----------------	--------

<b>description</b>	indicator light ø 12mm 250V green connection male faston 6.3mm
--------------------	--

with plug-in socket



<b>GEV No.</b>	359041	<b>Ref. No.</b>	A08009
----------------	--------	-----------------	--------

<b>description</b>	indicator light ø 12mm green 230V connection male faston 6.3mm temp.-resist. 120°C Qty 1 pcs
--------------------	--

<b>For models:</b>	FC60, FD120R
--------------------	--------------



<b>GEV No.</b>	359043	<b>Ref. No.</b>	A08008
----------------	--------	-----------------	--------

<b>description</b>	indicator light ø 12mm red 230V connection male faston 6.3mm temp.-resist. 120°C Qty 1 pcs
--------------------	--



1

<b>GEV No.</b>	359042	<b>Ref. No.</b>	A08003
----------------	--------	-----------------	--------

<b>description</b>	indicator light ø 12mm yellow 230V connection male faston 6.3mm temp.-resist. 120°C Qty 1 pcs
--------------------	---

<b>For models:</b>	FD120R
--------------------	--------



1

<b>GEV No.</b>	359288	<b>Ref. No.</b>	A08011
----------------	--------	-----------------	--------

<b>description</b>	indicator light ø 12mm 230V green
--------------------	-----------------------------------

<b>For models:</b>	CT540, DOUBLE PANINI, FC26, FC34, GED10, GED20, GED30, GED40, GES10, GES30, GES40, MAJESTIC, PANINI, PSE400, PSE600, PZ330, PZ660, SAVOYE
--------------------	---



1

<b>GEV No.</b>	359900	<b>Ref. No.</b>	A08005
----------------	--------	-----------------	--------

<b>description</b>	indicator light ø 12mm 230V red with cable
--------------------	--

<b>For models:</b>	140, 140D, 350E, 350ED, 400E, 400ED, 400FE, BAR100, BAR106, BAR200, BAR206, CT540, DOUBLE PANINI, FC26, FC34, GED10, GED20, GED30, GED40, GES10, GES20, GES30, GES40, GRE40, GRE60, GRE80, MAJESTIC, PANINI, PSE400, PSE600, PZ330, PZ400, PZ660, RBE12, RBE4, RBE8, RG11, RG5, RG7, RG9, RST127, RST128, RST227, RST228, SAVOYE, SEF80, SEM60
--------------------	--

ø13mm

with plug-in socket



1

<b>GEV No.</b>	359141	<b>Ref. No.</b>	A08008
----------------	--------	-----------------	--------

<b>description</b>	indicator light ø 13mm red 230V connection male faston 6.3mm temp.-resist. 120°C Qty 1 pcs
--------------------	--

## LED

## accessories



1

<b>GEV No.</b>	357248	<b>Ref. No.</b>	SA03093COM
----------------	--------	-----------------	------------

<b>description</b>	power supply for LEDs 30W primary 170-250VACV secondary 2.5A Qty 1 pcs secondary 12VDCV
--------------------	---

## linear lamps

## halogen lamps



1

<b>GEV No.</b>	359647	<b>Ref. No.</b>	A18003
----------------	--------	-----------------	--------

<b>description</b>	halogen lamp socket R7s L 117.6mm 230V 200W IMPORT
--------------------	--



1 			
<b>GEV No.</b>	360556	<b>Ref. No.</b>	A18002
<b>description</b>	halogen lamp socket R7s L 74.9mm 230V 80W OSRAM		

## infrared lamps

### with base type R7s

1 			
<b>GEV No.</b>	359628	<b>Ref. No.</b>	A18003
<b>description</b>	infrared lamp socket R7s L 117.6mm 240V 300W IMPORT unjacketed		

## sockets for linear lamps

### R7s

1 			
<b>GEV No.</b>	359735	<b>Ref. No.</b>	A18011
<b>description</b>	lamp socket socket R7s 250V ømm L 16mm W 25mm H 40mm connection cable 230mm mounting distance mm		

## fluorescent lamps

### fluorescent lamps

#### G13

1 			
<b>GEV No.</b>	359737	<b>Ref. No.</b>	A18013
<b>description</b>	fluorescent lamp socket G13 L 516mm 13W 230V Qty 1 pcs light colour Cool White		
<b>For models:</b>	WDL100, WDL200		

### complete with holder

1 			
<b>GEV No.</b>	359462	<b>Ref. No.</b>	A18024
<b>description</b>	fluorescent lamp L 545mm W 22mm 13W ø 19mm 230V		

1 			
<b>GEV No.</b>	357096	<b>Ref. No.</b>	SA18011
<b>description</b>	fluorescent lamp socket T5 L 900mm W 42mm 21W 230V plug type male/female with switch with mounting clips		



## accessories



sockets			
1 			
<b>GEV No.</b>	359736	<b>Ref. No.</b>	SA18014
<b>description</b>	lamp socket socket G5 L 516mm for fluorescent lamps		

## oven lamps

### universal oven lamps





#### mounting diameter 35.5mm

1 			
<b>GEV No.</b>	359718	<b>Ref. No.</b>	A18004 A18022
<b>description</b>	oven lamp mounting ø 35.5mm 230V 15W socket E14 temp.-resist. 300°C connection male faston 6.3mm hard glas		
<b>For models:</b>	FC60, FC60G		
<b>spare parts for</b>	359718		
	<b>GEV No.</b>	359701	<b>Ref. No.</b> A18022
	lamp socket socket E14 220-230V mounting ø 35.5mm connection male faston 6.3mm 15W		
	<b>GEV No.</b>	359740	<b>Ref. No.</b> —
	light bulb t.max. 300°C socket E14 15W 230V ø 22mm L 48mm lens L 20mm for oven lamp IMPORT		

1 			
<b>GEV No.</b>	359701	<b>Ref. No.</b>	A18022
<b>description</b>	lamp socket socket E14 220-230V mounting ø 35.5mm connection male faston 6.3mm 15W		
<b>accessories for</b>	359701		
	<b>GEV No.</b>	359705	<b>Ref. No.</b> —
	oven lamp glass thr.ø 33.5mm ø 52mm hard glas temp.-resist. 350°C		
	<b>GEV No.</b>	359709	<b>Ref. No.</b> —
	oven lamp glass thr.ø 33.5mm ø 42mm hard glas temp.-resist. 350°C		
	<b>GEV No.</b>	359721	<b>Ref. No.</b> —
	gasket silicone ED ø 48mm ID ø 39.5mm thickness 5mm Qty 1 pcs		
	<b>GEV No.</b>	359942	<b>Ref. No.</b> —
	oven lamp glass thr.ø 33.5mm ø 41mm hard glas temp.-resist. 350°C		

mounting diameter 65.5mm



<b>GEV No.</b>	359712	<b>Ref. No.</b>	A18005
<b>description</b>	oven lamp mounting ø 65.5mm 230V 40W socket E14 temp.-resist. 300°C connection male faston 6.3mm hard glas		
<b>For models:</b>	RBE12, RBE4, RBE8, RBG12, RBG4, RBG8		
<b>spare parts for</b>	359712		
	<b>GEV No.</b>	359022	<b>Ref. No.</b> —
	lamp socket socket E14 mounting ø 65.5mm connection male faston 6.3mm		
	<b>GEV No.</b>	359611	<b>Ref. No.</b> —
	light bulb t.max. 300°C socket E14 40W 230V ø 45mm L 75mm lens L 50mm for oven lamp IMPORT		
	<b>GEV No.</b>	359722	<b>Ref. No.</b> —
	gasket silicone ID ø 57.5mm ED ø 68mm thickness 2mm		
	<b>GEV No.</b>	359724	<b>Ref. No.</b> —
	oven lamp glass thread ø 62mm H 46mm ø 74mm hard glas temp.-resist. 350°C		



<b>GEV No.</b>	360446	<b>Ref. No.</b>	020014 A02028
<b>description</b>	timer M2 with bell 2-pole operation time 120min impulse mechanical 2NO at 250V 16A permanent position yes shaft ø 6x4.6mm shaft 6x4.6mm shaft L 23mm mounting distance 28mm connection rear		



<b>GEV No.</b>	350008	<b>Ref. No.</b>	A02014 A02028
<b>description</b>	timer M2 with bell 2-pole operation time 120min impulse mechanical 2NO at 250V 16A permanent position yes shaft ø 6x4.6mm shaft 6x4.6mm shaft L 24mm mounting distance 28mm connection lateral		



<b>GEV No.</b>	360460	<b>Ref. No.</b>	A02016 A02029
<b>description</b>	timer M2 with bell 2-pole operation time 15min impulse mechanical 2NO at 250V 16A permanent position yes shaft ø 6x4.6mm shaft 6x4.6mm shaft L 23mm with bell mounting distance 28mm connection rear ambient temperature max. 125°C		
<b>For models:</b>	PZ400		

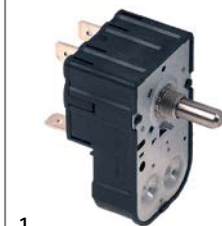

<b>GEV No.</b>	350043	<b>Ref. No.</b>	A02010
<b>description</b>	timer MI7 2-pole operation time 120min impulse mechanical 2NO at 250V 16A permanent position no shaft ø 6x4.6mm shaft 6x4.6mm shaft L 17mm mounting distance 28mm mounting thread M8 connection rear		
<b>For models:</b>	TH1		

timers

mechanical timers





<b>GEV No.</b>	350186	<b>Ref. No.</b>	A02030
<b>description</b>	timer M2 2-pole operation time 120min impulse mechanical 2CO at 250V 16A permanent position yes shaft ø 6x4.6mm shaft 6x4.6mm shaft L 23mm mounting distance 28mm		
<b>accessories for</b>	350186		
	<b>GEV No.</b>	112627	<b>Ref. No.</b> —
	knob time 120min ø 58mm shaft ø 6x4.6mm shaft flat lower		





<b>GEV No.</b>	360173	<b>Ref. No.</b>	A02001 A02002
<b>description</b>	timer M2 3-pole operation time 15min impulse mechanical 3NO at 250V 16A permanent position yes shaft ø 6x4.6mm shaft 6x4.6mm shaft L 16mm mounting distance 28mm connection lateral		



 <p>1</p>			
<b>GEV No.</b>	360164	<b>Ref. No.</b>	A02008
<b>description</b>	timer MT49 2-pole operation time 15min impulse mechanical 2NO at 250V 16A permanent position yes shaft $\varnothing$ 6x4.6mm shaft L 16mm mounting distance 28mm connection lateral		
<b>For models:</b>	BAR100, BAR106, BAR200, BAR206, RST127, RST128, RST227, RST228		

 <p>1</p>			
<b>GEV No.</b>	350000	<b>Ref. No.</b>	A02004
<b>description</b>	audible timer operation time 30min $\varnothing$ 57mm shaft $\varnothing$ 6x4.6mm shaft L 24mm mounting distance 28mm		

 <p>1</p>			
<b>GEV No.</b>	360097	<b>Ref. No.</b>	A02015
<b>description</b>	timer MT59 1-pole operation time 120min impulse mechanical 1NO at 250V 16A permanent position no shaft $\varnothing$ 6x4.6mm shaft 6x4.6mm shaft L 20mm mounting distance 28mm connection lateral shaft flat upper		
<b>For models:</b>	CN, FC26, FC33, FC34		

 <p>1</p>			
<b>GEV No.</b>	360630	<b>Ref. No.</b>	A02004
<b>description</b>	timer operation time 15min $\varnothing$ 57.6mm shaft $\varnothing$ 6.4x4.8mm shaft L 22.4mm mounting distance 28.5mm		

 <p>1</p>			
<b>GEV No.</b>	360690	<b>Ref. No.</b>	A02019
<b>description</b>	timer MT59 2-pole operation time 120min impulse mechanical 2NO at 250V 16A permanent position no shaft $\varnothing$ 6x4.6mm shaft 6x4.6mm shaft L 20mm mounting distance 28mm connection lateral shaft flat upper		

## contactors

### BENEDIKT & JÄGER

#### power contactors

 <p>1</p>			
<b>GEV No.</b>	380774	<b>Ref. No.</b>	A05007
<b>description</b>	power contactor resistive load 32A 230VAC (AC3/400V) 18A/7.5kW main contacts 3NO auxiliary contacts 1NO connection screw connection type K3-18ND10		

### audible timers

 <p>1</p>			
<b>GEV No.</b>	360151	<b>Ref. No.</b>	A02012
<b>description</b>	audible timer operation time 120min $\varnothing$ 52mm shaft $\varnothing$ 6x4.6mm shaft L 23mm mounting distance 28mm		

### GENERAL ELECTRIC (AEG)

#### power contactors

 <p>1</p>			
<b>GEV No.</b>	380238	<b>Ref. No.</b>	A05002 A05006
<b>description</b>	power contactor resistive load 20A 230VAC (AC3/400V) 8.4A/4kW main contacts 3NO auxiliary contacts 1NO connection screw connection type LS0510A type AEG LS0510A type GE MC1A 310A		



## ISKRA (FANAL)

## power contactors



1

<b>GEV No.</b>	380213	<b>Ref. No.</b>	A05008
<b>description</b>	power contactor resistive load 20A 230VAC (AC3/400V) 8.5A/5.5kW main contacts 3NO auxiliary contacts 1NO connection screw connection type Fanal DSL7 10 type ISKRA K07M 10		
<b>For models:</b>	FD120R		

## LOVATO

## power contactors



1

<b>GEV No.</b>	380083	<b>Ref. No.</b>	A05008
<b>description</b>	power contactor resistive load 25A 230VAC (AC3/400V) 9A/4.2kW main contacts 3NO auxiliary contacts 1NC connection screw connection type BF0901A230		

## OMRON

## power contactors



1

<b>GEV No.</b>	380882	<b>Ref. No.</b>	A05002 A05006
<b>description</b>	power contactor resistive load 25A 230VAC AC3 10A main contacts 3NO auxiliary contacts 1NO connection screw connection type J7KN-10D-10 OMRON		

## solid state relays

## accessories

## diodes

## diodes



<b>GEV No.</b>	693039	<b>Ref. No.</b>	A18006
<b>description</b>	diode		



<b>GEV No.</b>	694844	<b>Ref. No.</b>	A18027
<b>description</b>	diode type P2000M		

## electronic controllers

## AKO

## refrigeration controllers

## built-in version



1

<b>GEV No.</b>	379460 <sup>1</sup>	<b>Ref. No.</b>	SA06030
<b>description</b>	electronic controller AKO type AKO-D14123 mounting measurements 71x29mm 230V voltage AC NTC/PTC relay outputs 1 NO-12A(9) NTC/PTC built-in depth 43mm mode of operation protection IP65 built-in version 1x NTC probe inclusive -50 up to +99/+150°C display 3½ digits		
<b>accessories for</b>	379460		
	<b>GEV No.</b>	378261	<b>Ref. No.</b> —
	temperature probe NTC 10kOhm cable thermoplastic probe -40 up to +110°C cable -40 up to +110°C probe ø6x35mm cable length 3m without screw connection 2-wire		
	<b>GEV No.</b>	379052	<b>Ref. No.</b> —
	temperature probe PTC 1kOhm cable silicone probe -50 up to +150°C cable -50 up to +180°C probe ø6x40mm cable length 1.5m without screw connection 2-wire		
	<b>GEV No.</b>	379053	<b>Ref. No.</b> —
	temperature probe PTC 1kOhm cable PVC probe -50 up to +150°C cable -10 up to 100°C probe ø6x30mm cable length 3m without screw connection 2-wire		
	<b>GEV No.</b>	379064	<b>Ref. No.</b> —
	temperature probe PTC 1kOhm cable silicone probe -50 up to +150°C cable -50 up to +180°C probe ø6x40mm cable length 3m without screw connection 2-wire		
	<b>GEV No.</b>	379142	<b>Ref. No.</b> —
	temperature probe PTC 1kOhm cable PVC probe -50 up to +150°C cable -10 up to 100°C probe ø6x30mm cable length 1.5m without screw connection 2-wire		
	<b>GEV No.</b>	379160	<b>Ref. No.</b> —
	temperature probe NTC 10kOhm cable thermoplastic probe -40 up to +110°C cable -40 up to +110°C probe ø6x14mm cable length 1.5m without screw connection 2-wire		

<sup>1</sup>incl. 1x NTC probe  
Table continues overleaf



accessories for		379460	
GEV No.	379161	Ref. No.	—
temperature probe NTC 10kOhm cable thermoplastic probe -40 up to +110°C cable -40 up to +110°C probe ø6x14mm cable length 3m without screw connection 2-wire			
GEV No.	379342	Ref. No.	—
temperature probe NTC 10kOhm cable PVC probe -20 up to +80°C cable -10 up to 100°C probe ø6x25mm cable length 1.5m 2-wire protection IP67			
GEV No.	379343	Ref. No.	—
temperature probe NTC 10kOhm cable silicone probe -40 up to +110°C cable -50 up to +180°C probe ø6x40mm cable length 3m 2-wire			
GEV No.	379458	Ref. No.	—
temperature probe NTC 10kOhm cable silicone probe -40 up to +110°C cable -50 up to +180°C probe ø6x40mm cable length 1.5m without screw connection 2-wire			
GEV No.	379637	Ref. No.	—
temperature probe PTC 1kOhm cable PVC probe -50 up to +150°C cable -10 up to 100°C probe ø6x35mm cable length 2m without screw connection 2-wire			
GEV No.	379781	Ref. No.	—
temperature probe PTC 1kOhm cable thermoplastic probe -50 up to +150°C cable -40 up to +110°C probe ø6x14mm cable length 1.5m without screw connection 2-wire			
GEV No.	379782	Ref. No.	—
temperature probe PTC 1kOhm cable thermoplastic probe -50 up to +150°C cable -40 up to +110°C probe ø6x14mm cable length 3m 2-wire resistor 1kOhm			
GEV No.	379860	Ref. No.	—
temperature probe NTC 10kOhm cable PVC probe -20 up to +80°C cable -10 up to 100°C probe ø6x40mm cable length 1.5m without screw connection 2-wire			

## electronics

### PCBs

			
1			
GEV No.	402941	Ref. No.	A03024
description	PCB for oven FC 110 EG L 97mm W 72mm suitable for ROLLER GRILL		

			
1			
GEV No.	403563	Ref. No.	A02017
description	PCB grill Panini L 32mm W 72mm timer		

## keypads

### front foils

			
1			
GEV No.	403675	Ref. No.	G0G162
description	front foil fryer RM160 L 400mm W 100mm		

## solenoid valves

### solenoid valves (water)

various			
			
1			
GEV No.	370216	Ref. No.	B10006
description	solenoid valve single angled 230VAC inlet 3/4" outlet 11.5mm t.max. 90°C plastic flow regulating valve outlet red suitable for ROLLER GRILL		
For models:	FC110, FC110G		

### metal

### solenoid valves (various)

			
1			
GEV No.	370665	Ref. No.	SB10018
description	solenoid valve 2-ways 24VAC inlet 1/8" outlet 1/8" connection male faston 6.3mm L 31mm Olab type series 6000-9000 coil type 6000BH/B1-FN 50/60Hz brass		



## compressors

### SECOP DANFOSS

R134A

LBP monophase

Lower evaporation temperature below -20°C



<b>GEV No.</b>	605052	<b>Ref. No.</b>	SA03024/F
<b>description</b>	compressor coolant R134a type TL5G 220-240V 50Hz LBP/HBP fully hermetic 7.5kg 1/6HP cylinder capacity 5.08cm <sup>3</sup> RSIR/CSIR H 173mm 69W 97W 132W 172W 220W 277W 345W 423W 461W test method ASHRAE		
<b>spare parts for</b>	605052		
	<b>GEV No.</b>	380076	<b>Ref. No.</b> —
	start relay DANFOSS 117U6000 HST		

HBP monophase

High evaporation temperature above -15°C



<b>GEV No.</b>	605052	<b>Ref. No.</b>	SA03024/F
<b>description</b>	compressor coolant R134a type TL5G 220-240V 50Hz LBP/HBP fully hermetic 7.5kg 1/6HP cylinder capacity 5.08cm <sup>3</sup> RSIR/CSIR H 173mm 69W 97W 132W 172W 220W 277W 345W 423W 461W test method ASHRAE		
<b>spare parts for</b>	605052		
	<b>GEV No.</b>	380076	<b>Ref. No.</b> —
	start relay DANFOSS 117U6000 HST		

## fans

### axial fans

import



<b>GEV No.</b>	601604 <sup>1</sup>	<b>Ref. No.</b>	SA03018
<b>description</b>	axial fan L 119mm W 119mm H 38mm 230VAC 50/60Hz 17/15W bearing slide bearing manuf. no. AA1282HS-AT connection cable 300mm fan wheel ø 110mm temp.-resist. 70°C input current 0.1A airflow 130m <sup>3</sup> /h 2600rpm		

<sup>1</sup>with slide bearings

### refrigeration fans

refrigeration motors universal

ELCO

N series - standard



<b>GEV No.</b>	601843	<b>Ref. No.</b>	SA03012
<b>description</b>	fan motor ELCO 10W 230V 50/60Hz bearing slide bearing L1 49mm L2 65mm L3 87mm W 82mm connection cable 1000mm cable length 1000mm 1300/1550rpm 3 mounting options N10-20/158		
<b>spare parts for</b>	601843		
	<b>GEV No.</b>	601413	<b>Ref. No.</b> —
	fixing plate suitable for fanwheel ED ø 32mm shaft ø 7 mounting distance 26mm		



## hot air motors



1

<b>GEV No.</b>	601122	<b>Ref. No.</b>	A03010
<b>description</b>	hot air fan 230V 1 phase 50Hz 0.12kW 2650rpm speeds 1 L1 100mm L2 34mm L3 33mm L4 178mm fan wheel ø 180mm type R2E180-AH05-10		
<b>For models:</b>	FC110, FC110G		

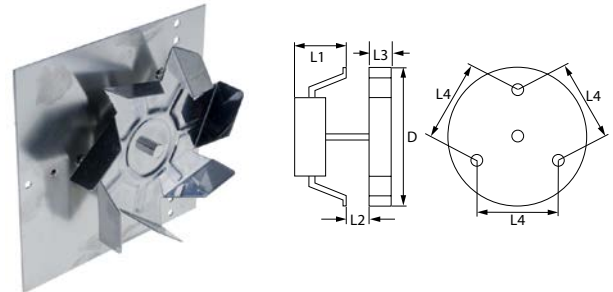

1

<b>GEV No.</b>	601548	<b>Ref. No.</b>	A03006	
<b>description</b>	hot air fan 220-240V 40W 50/60Hz L1 65mm L2 11mm L3 25mm L4 87mm fan wheel ø 150mm FIME type C25R8023CLH			
<b>For models:</b>	CN, FC26, FC33, FC34, TH1			
<b>accessories for</b>	601548			
	<b>GEV No.</b>	601441	<b>Ref. No.</b>	—
	fan wheel ø 150mm W 25mm shaft intake ø 6x5mm stainless steel blades 7			

## hot air fans

### miscellaneous



1

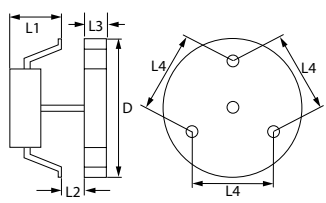



<b>GEV No.</b>	500902	<b>Ref. No.</b>	A03057	
<b>description</b>	fan motor 220V 55W 50/60Hz L1 68mm FIME type L25R without fan wheel			
<b>accessories for</b>	500902			
	<b>GEV No.</b>	550879	<b>Ref. No.</b>	—
	insulation ø 130mm thickness 3mm hole ø 20mm for hot air fan			

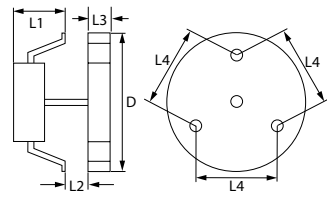

1



<b>GEV No.</b>	601011	<b>Ref. No.</b>	A03001 A03006	
<b>description</b>	hot air fan 220-240V 40W 50/60Hz L1 65mm L2 15mm L3 25mm L4 87mm fan wheel ø 150mm FIME type C25R8023CLH			
<b>accessories for</b>	601011			
	<b>GEV No.</b>	550879	<b>Ref. No.</b>	—
	insulation ø 130mm thickness 3mm hole ø 20mm for hot air fan			
	<b>GEV No.</b>	601260	<b>Ref. No.</b>	—
	nut thread M6L IT for hot air fan			

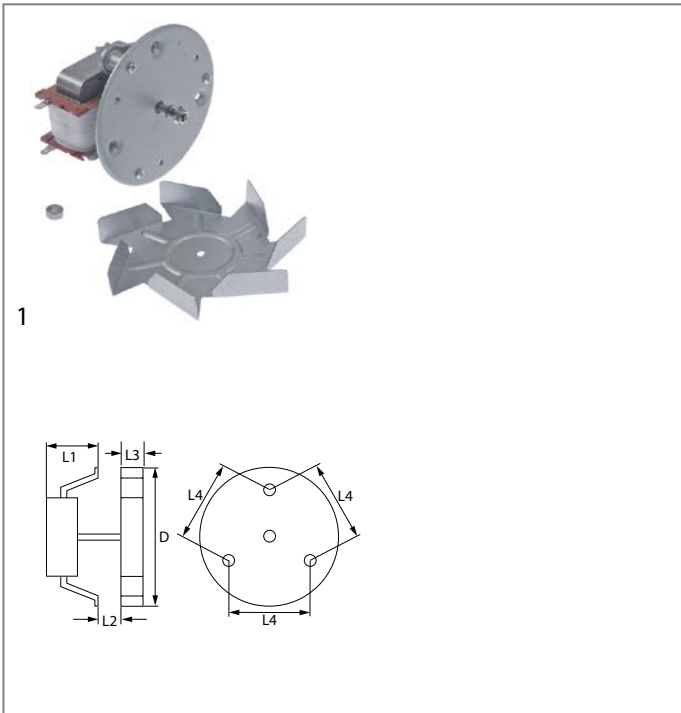

<b>GEV No.</b>	601860	<b>Ref. No.</b>	A03057 + A03058 + B08050
<b>description</b>	hot air fan 230V 55W 50/60Hz L1 83mm L2 19mm L3 20mm L4 87mm fan wheel ø 150mm FIME		

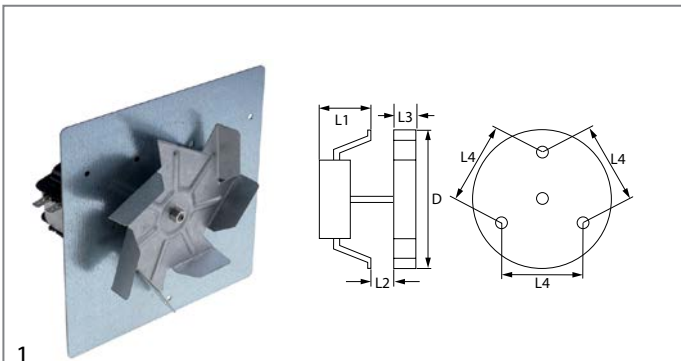

<b>GEV No.</b>	601177	<b>Ref. No.</b>	A03001
<b>description</b>	hot air fan 230V 55W L1 83mm L2 19mm L3 20mm L4 87mm fan wheel ø 150mm L25R7570		
<b>For models:</b>	FC60, FC60G		

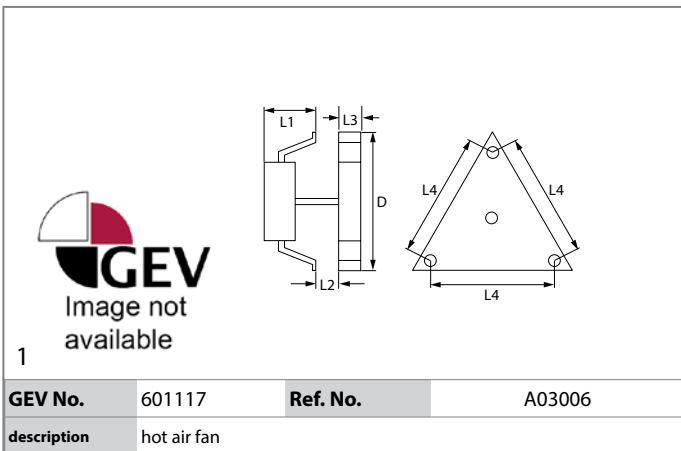

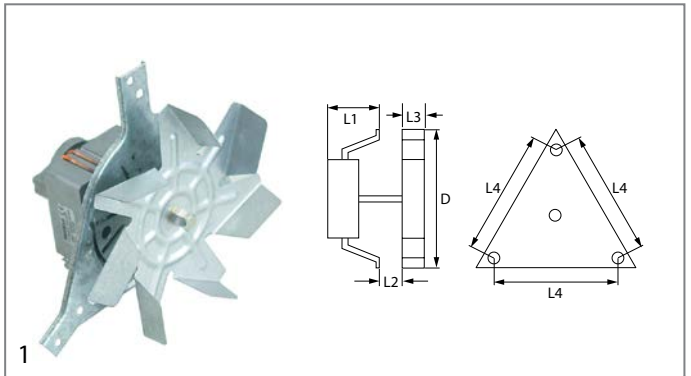

<b>GEV No.</b>	601117	<b>Ref. No.</b>	A03006
<b>description</b>	hot air fan		

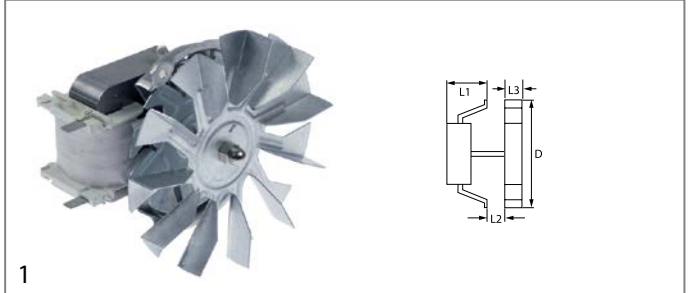

<b>GEV No.</b>	601118	<b>Ref. No.</b>	A03001
<b>description</b>	hot air fan 230V 40W L2 19mm fan wheel ø 150mm		



<b>GEV No.</b>	601796	<b>Ref. No.</b>	A03044 A03063
<b>description</b>	hot air fan 220/240V 30W L1 62mm L2 15mm L3 16.5mm fan wheel ø 120mm PLASET shaft M6L		

<b>spare parts for</b>	601796			
	<b>GEV No.</b>	601259	<b>Ref. No.</b>	—
	fan wheel ø 120mm W 16mm shaft intake ø 6x5mm blades 11			
	<b>GEV No.</b>	601260	<b>Ref. No.</b>	—
	nut thread M6L IT for hot air fan			

accessories

fan wheels for hot air fans



<b>GEV No.</b>	601200	<b>Ref. No.</b>	A03058
<b>description</b>	fan wheel ø 150mm W 20mm shaft intake ø 6x5mm zinc-plated blades 7		



miscellaneous



1			
<b>GEV No.</b>	551320	<b>Ref. No.</b>	B08050
<b>description</b>	distance washers SS ø 12mm thickness 5mm hole ø 6mm		

motors

gear motors

for grills



1			
<b>GEV No.</b>	500603	<b>Ref. No.</b>	A03038 A03064
<b>description</b>	gear motor 230V 50/60Hz shaft ø 8mm L 91mm W 64mm H 118mm for hot dog grill type 2512-B01661-1392 RMS		
<b>For models:</b>	RG11, RG5, RG7, RG9		
<b>accessories for</b>	500603		
	<b>GEV No.</b>	693160	<b>Ref. No.</b> B01004
	gear wheel teeth 20 shaft intake ø 8mm ø 38mm hub ø 20mm stainless steel		



1			
<b>GEV No.</b>	500602	<b>Ref. No.</b>	A03007
<b>description</b>	gear motor CROUZET 220V 50/60Hz 4rpm shaft ø 8x7mm		

for gyros grills



1			
<b>GEV No.</b>	500600	<b>Ref. No.</b>	A03025 A03050+A03051
<b>description</b>	gear motor CROUZET type 80644034 220V 50/60Hz shaft ø 15mm shaft diameter for shaft 8x8mm L 92mm W 63mm H 70mm for gyro grill		
<b>For models:</b>	GRE40, GRE60, GRE80, GRG40, GRG60, GRG80		



1			
<b>GEV No.</b>	500748	<b>Ref. No.</b>	A03008 A03054
<b>description</b>	gear motor KENTA type K9115106 28W 230V 50Hz 2.5rpm shaft ø 15mm shaft diameter 9x9mm		
<b>For models:</b>	RBE12, RBE4, RBE8, RBG12, RBG4, RBG8		

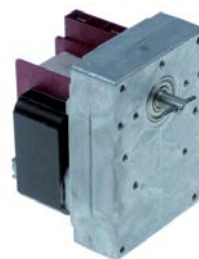

1			
<b>GEV No.</b>	500993	<b>Ref. No.</b>	A03050 A03055
<b>description</b>	gear motor KENTA type K9175001 30W 230V voltage AC 50Hz 1rpm shaft ø 8mm L 105mm W 72mm H 86mm for gyro grill		



1			
<b>GEV No.</b>	601765	<b>Ref. No.</b>	A03053
<b>description</b>	gear motor KENTA type K9177150 50W 230V 50Hz 2rpm shaft ø 21mm L 105mm W 70mm H 130mm skewer 12x12mm		



miscellaneous



1			
<b>GEV No.</b>	500604	<b>Ref. No.</b>	A03036
<b>description</b>	gear motor for toaster		
<b>For models:</b>	CT540		



1			
<b>GEV No.</b>	601728	<b>Ref. No.</b>	A03026
<b>description</b>	gear motor TEMPOMATIC type TY49-II 4W 230V voltage AC 50Hz 2.5rpm shaft ø 5.4x7mm for vitrine		

fuses

fine fuses

fine fuse holders



1			
<b>GEV No.</b>	358125	<b>Ref. No.</b>	A18019 SA18022
<b>description</b>	fuse holder suitable fuse ø6.3x32mm ø 15mm thread M13 1-pole 10A rated 250V connection F4.8		

electric accessories

cables

power supply cables



1			
<b>GEV No.</b>	551085	<b>Ref. No.</b>	C03013 SC03024
<b>description</b>	cable CEE7/7 type E+F 3-pole contacts P+N+E 1.5mm <sup>2</sup> max. 16A max 230V 2m with plug H05VV-F 3G1.5		

1			
<b>GEV No.</b>	551203	<b>Ref. No.</b>	C03007
<b>description</b>	connecting cable CEE7/7 type E+F 3-pole contacts P+N+E 2.5mm <sup>2</sup> max. 16A max 230V 2m H07 RN-F with plug		

1			
<b>GEV No.</b>	551321	<b>Ref. No.</b>	C03011
<b>description</b>	power lead BS1363 3-pole contacts P+N+E 1.5mm <sup>2</sup> max. 13A max 250V 1.6m with fuse countries UK Qty 1 pcs connection female faston 6.3mm black		

1			
<b>GEV No.</b>	551193	<b>Ref. No.</b>	C03002
<b>description</b>	power lead CEE7/7 type E+F 3-pole contacts P+N+E 1.5mm <sup>2</sup> max. 16A max 230V 1.37m H07RN-F 3G1.50mm <sup>2</sup> countries A/B/D/F/I		

accessories

insulated hoses

up to 250°C

1			
<b>GEV No.</b>	550019	<b>Ref. No.</b>	C04007
<b>description</b>	insulating hose ID ø 8mm Qty 10m silicone coated glass fibre braiding permanent temperature 250°C t.max. 290°C flashover voltage 3000V red/brown		

protection hoses

miscellaneous

1			
<b>GEV No.</b>	693042	<b>Ref. No.</b>	C04005 C04008
<b>description</b>	protective metal tube		
<b>For models:</b>	DOUBLE PANINI, MAJESTIC, PANINI, SAVOYE		





## cable glands

### cable glands



1

<b>GEV No.</b>	550313	<b>Ref. No.</b>	A12008
<b>description</b>	cable gland ID $\varnothing$ 9mm mounting $\varnothing$ 11mm ED $\varnothing$ 16mm Neoprene -30 up to +90°C Qty 10 pcs		

## threaded cable glands

### screw connections



1

<b>GEV No.</b>	551288 <sup>1</sup>	<b>Ref. No.</b>	A10032
<b>description</b>	cable gland thread PG16 cable $\varnothing$ 14mm mounting $\varnothing$ 22.5mm WS 27 plastic Qty 1 pcs		
<b>For models:</b>	FD120R		

<sup>1</sup>incl. fastening nut

## terminals

### porcelain clamps



1

<b>GEV No.</b>	550115	<b>Ref. No.</b>	A16021
<b>description</b>	porcelain terminal block 2-pole 10mm <sup>2</sup> max. 30A max 450V L 37mm W 37mm H 23mm mounting distance mm Qty 1 pcs		



1

<b>GEV No.</b>	550112	<b>Ref. No.</b>	A16003
<b>description</b>	porcelain terminal block 2-pole 2.5mm <sup>2</sup> max. 10A max 250V t.max. 200°C L 22mm W 17mm H 15mm mounting distance mm Qty 1 pcs		

## connection terminals with screw/faston connections



1

<b>GEV No.</b>	505212	<b>Ref. No.</b>	A16012
<b>description</b>	power terminal block 2-pole max. 20A max 600V connection $\varnothing$ 2.5mm <sup>2</sup> / F6.3 temp.-resist. 150°C cross section 4mm <sup>2</sup>		
<b>For models:</b>	DOUBLE PANINI, GED10, GED20, GED30, GED40, GES10, GES20, GES30, GES40, MAJESTIC, PANINI, SAVOYE		



1

<b>GEV No.</b>	550458	<b>Ref. No.</b>	A16013
<b>description</b>	power terminal block 3-pole max. 25A max 450V connection $\varnothing$ 2.5mm <sup>2</sup> / F6.3 temp.-resist. 150°C		



1

<b>GEV No.</b>	550411	<b>Ref. No.</b>	A16014
<b>description</b>	power terminal block 6-pole max. 40A max 450V connection $\varnothing$ 6mm <sup>2</sup> / F6.3 temp.-resist. 150°C cross section 6mm <sup>2</sup>		

## connection terminals with strain relief



1

<b>GEV No.</b>	550356	<b>Ref. No.</b>	A10002
<b>description</b>	power terminal block 2-pole max 450V max. 16A cable $\varnothing$ 15mm cross section 1.5mm <sup>2</sup>		
<b>For models:</b>	RELAIS		

## connection boxes



1

<b>GEV No.</b>	550300	<b>Ref. No.</b>	A10007
<b>description</b>	power terminal block 3-pole contacts P+N+E		

## terminal boards



1

<b>GEV No.</b>	550413	<b>Ref. No.</b>	A16010
<b>description</b>	terminal board 3-pole thread M5 L 55mm W 36mm		
<b>For models:</b>	FD120R, GRE40, GRE60, GRE80		



			
1			
<b>GEV No.</b>	550459	<b>Ref. No.</b>	A16004
<b>description</b>	terminal board 3-pole thread M6 L 70mm W 45mm		
<b>For models:</b>	RBE12, RBE4, RBE8		

## gas taps

### PEL

#### 20S series

			
1			
<b>GEV No.</b>	101094	<b>Ref. No.</b>	E02030 E02036
<b>description</b>	gas tap PEL type 20S gas inlet M16x1.5 (tube ø 10mm) bypass nozzle ø 0.35mm gas outlet M16x1.5 (tube ø 10/8mm) thermocouple connection M8x1 pilot connection shaft ø 8x6.5mm shaft L 22/15mm shaft flat lower		
<b>For models:</b>	350G, 350GD, 400G, 400GD		
<b>spare parts for</b>	101094		
	<b>GEV No.</b>	100408	<b>Ref. No.</b> —
	bypass nozzle type PEL20/21 bore ø 0.35mm thread M5x0.5		
	<b>GEV No.</b>	101060	<b>Ref. No.</b> —
	magnet unit standard L 39mm D1 ø 15.4mm D2 ø 11mm suitable for PEL20-21/JUNKERS/EGA		
	<b>GEV No.</b>	101205	<b>Ref. No.</b> —
	gas tap front part shaft ø 8x6.5mm shaft L 22/15mm shaft flat upper/lower suitable for PEL20		
	<b>GEV No.</b>	101230	<b>Ref. No.</b> —
	thermocouple nut T1: M8x1 T2: M18x1 aluminium		
<b>accessories for</b>	101094		
	<b>GEV No.</b>	101278	<b>Ref. No.</b> —
	olive for pipe ø 10mm Qty 1 pcs		
	<b>GEV No.</b>	101300	<b>Ref. No.</b> —
	union nut thread M16x1.5 tube ø 10mm		
	<b>GEV No.</b>	101450	<b>Ref. No.</b> —
	olive for pipe ø 8mm L 12.7mm Qty 1 pcs ED ø 10mm		
	<b>GEV No.</b>	101451	<b>Ref. No.</b> —
	union nut thread M16x1.5 tube ø 8mm		
	<b>GEV No.</b>	110081	<b>Ref. No.</b> —
	knob ø 70mm shaft ø 8x6.5mm shaft flat universal		
	<b>GEV No.</b>	110083	<b>Ref. No.</b> —
	knob dial plate gas tap without ignition flame silver		

			
1			
<b>GEV No.</b>	101491	<b>Ref. No.</b>	E02030
<b>description</b>	gas tap PEL type 20S gas inlet M16x1.5 (tube ø 10mm) bypass nozzle ø 0.35mm gas outlet M16x1.5 (tube ø 10/8mm) thermocouple connection M9x1 pilot connection shaft ø 8x6.5mm shaft L 22/15mm shaft flat lower		
<b>For models:</b>	GRG40, GRG60, GRG80, PSG400, PSG600, RBG12, RBG4, RBG8		
<b>spare parts for</b>	101491		
	<b>GEV No.</b>	100408	<b>Ref. No.</b> —
	bypass nozzle type PEL20/21 bore ø 0.35mm thread M5x0.5		
	<b>GEV No.</b>	101060	<b>Ref. No.</b> —
	magnet unit standard L 39mm D1 ø 15.4mm D2 ø 11mm suitable for PEL20-21/JUNKERS/EGA		
	<b>GEV No.</b>	101205	<b>Ref. No.</b> —
	gas tap front part shaft ø 8x6.5mm shaft L 22/15mm shaft flat upper/lower suitable for PEL20		
	<b>GEV No.</b>	101231	<b>Ref. No.</b> —
	thermocouple nut T1: M9x1 T2: M18x1		
<b>accessories for</b>	101491		
	<b>GEV No.</b>	101287	<b>Ref. No.</b> —
	olive for pipe ø 6mm Qty 1 pcs		
	<b>GEV No.</b>	101300	<b>Ref. No.</b> —
	union nut thread M16x1.5 tube ø 10mm		
	<b>GEV No.</b>	101450	<b>Ref. No.</b> —
	olive for pipe ø 8mm L 12.7mm Qty 1 pcs ED ø 10mm		
	<b>GEV No.</b>	101451	<b>Ref. No.</b> —
	union nut thread M16x1.5 tube ø 8mm		
	<b>GEV No.</b>	110081	<b>Ref. No.</b> —
	knob ø 70mm shaft ø 8x6.5mm shaft flat universal		
	<b>GEV No.</b>	110083	<b>Ref. No.</b> —
	knob dial plate gas tap without ignition flame silver		



#### 21S series

			
1			
<b>GEV No.</b>	101095	<b>Ref. No.</b>	E02031
<b>description</b>	gas tap PEL type 21S gas inlet M16x1.5 (tube ø 10mm) bypass nozzle ø 0.35mm gas outlet M16x1.5 (tube ø 10/8mm) thermocouple connection M8x1 pilot connection M10x1 shaft ø 8x6.5mm shaft L 22/15mm shaft flat lower		
<b>spare parts for</b>	101095		
	<b>GEV No.</b>	100408	<b>Ref. No.</b> —
	bypass nozzle type PEL20/21 bore ø 0.35mm thread M5x0.5		

Table continues overleaf



spare parts for		101095	
	GEV No.	101060	Ref. No. —
magnet unit standard L 39mm D1 ø 15.4mm D2 ø 11mm suitable for PEL20-21/JUNKERS/EGA			
	GEV No.	101206	Ref. No. —
gas tap front part shaft ø 8x6.5mm shaft L 22/15mm shaft flat upper/lower suitable for PEL21			
	GEV No.	101230	Ref. No. —
thermocouple nut T1: M8x1 T2: M18x1 aluminium			
accessories for		101095	
	GEV No.	100908	Ref. No. —
union screw thread M10x1 for pipe ø 4mm Qty 1 pcs			
	GEV No.	100909	Ref. No. —
union screw thread M10x1 for pipe ø 6mm Qty 1 pcs			
	GEV No.	101246	Ref. No. —
olive for pipe ø 4mm Qty 1 pcs			
	GEV No.	101278	Ref. No. —
olive for pipe ø 10mm Qty 1 pcs			
	GEV No.	101286	Ref. No. —
olive ID ø 6mm Qty 1 pcs			
	GEV No.	101300	Ref. No. —
union nut thread M16x1.5 tube ø 10mm			
	GEV No.	101450	Ref. No. —
olive for pipe ø 8mm L 12.7mm Qty 1 pcs ED ø 10mm			
	GEV No.	101451	Ref. No. —
union nut thread M16x1.5 tube ø 8mm			
	GEV No.	110081	Ref. No. —
knob ø 70mm shaft ø 8x6.5mm shaft flat universal			
	GEV No.	112206	Ref. No. —
knob dial plate silver gas tap PEL21/22/23 t.max.°C ED ø 63mm ID ø 45.5mm			

			
1	GEV No.	101397	Ref. No. E02031
<b>description</b> gas tap PEL type 21S gas inlet M16x1.5 (tube ø 10mm) bypass nozzle ø 0.35mm gas outlet M16x1.5 (tube ø 10/8mm) thermocouple connection M9x1 pilot connection M10x1 shaft ø 8x6.5mm shaft L 22/15mm shaft flat lower			
<b>For models:</b> GSM60, SGF80			
spare parts for		101397	
	GEV No.	100408	Ref. No. —
bypass nozzle type PEL20/21 bore ø 0.35mm thread M5x0.5			
	GEV No.	101060	Ref. No. —
magnet unit standard L 39mm D1 ø 15.4mm D2 ø 11mm suitable for PEL20-21/JUNKERS/EGA			

spare parts for		101397	
	GEV No.	101206	Ref. No. —
gas tap front part shaft ø 8x6.5mm shaft L 22/15mm shaft flat upper/lower suitable for PEL21			
	GEV No.	101231	Ref. No. —
thermocouple nut T1: M9x1 T2: M18x1			
accessories for		101397	
	GEV No.	100908	Ref. No. —
union screw thread M10x1 for pipe ø 4mm Qty 1 pcs			
	GEV No.	100909	Ref. No. —
union screw thread M10x1 for pipe ø 6mm Qty 1 pcs			
	GEV No.	101246	Ref. No. —
olive for pipe ø 4mm Qty 1 pcs			
	GEV No.	101278	Ref. No. —
olive for pipe ø 10mm Qty 1 pcs			
	GEV No.	101286	Ref. No. —
olive ID ø 6mm Qty 1 pcs			
	GEV No.	101300	Ref. No. —
union nut thread M16x1.5 tube ø 10mm			
	GEV No.	101450	Ref. No. —
olive for pipe ø 8mm L 12.7mm Qty 1 pcs ED ø 10mm			
	GEV No.	101451	Ref. No. —
union nut thread M16x1.5 tube ø 8mm			
	GEV No.	110081	Ref. No. —
knob ø 70mm shaft ø 8x6.5mm shaft flat universal			
	GEV No.	112206	Ref. No. —
knob dial plate silver gas tap PEL21/22/23 t.max.°C ED ø 63mm ID ø 45.5mm			

## SABAF

			
1	GEV No.	103277	Ref. No. E02218
<b>description</b> gas tap SABAF type 10 gas inlet pipe flange ø14mm bypass nozzle ø 0mm gas outlet 1/4" (tube ø 8mm) front fixing M13x1 thermocouple connection M8x1 shaft ø 8x6.5mm shaft L 23/17mm shaft flat left			

miscellaneous



<b>GEV No.</b>	109105	<b>Ref. No.</b>	E02145
<b>description</b>	gas tap gas inlet 1/2" (tube ø 15mm) bypass nozzle ø 0.4mm gas outlet M14x1.5 (tube ø 8mm) pilot connection thermocouple connection M9x1 shaft ø 8x6.5mm shaft L 18.5/10mm shaft flat left kit front fixing M10x1		



<b>GEV No.</b>	109206	<b>Ref. No.</b>	E02217
<b>description</b>	gas tap thermocouple connection M8x1 shaft ø 8x6.5mm shaft L 24/17mm		

gas thermostats

PEL





25ST series



<b>GEV No.</b>	107780	<b>Ref. No.</b>	E02191 E02279
<b>description</b>	gas thermostat PEL type 25ST up to 190°C gas inlet M16x1.5 (tube ø 10mm) bypass nozzle ø 0mm gas outlet M16x1.5 (tube ø 10/8mm) thermocouple connection M9x1 pilot connection M10x1 capillary pipe 1200mm probe ø 6mm probe L 195mm shaft ø 8x6.5mm shaft L 21/15mm shaft flat upper		

<b>description</b>	gas thermostat PEL type 25ST up to 190°C gas inlet M16x1.5 (tube ø 10mm) bypass nozzle ø 0mm gas outlet M16x1.5 (tube ø 10/8mm) thermocouple connection M9x1 pilot connection M10x1 capillary pipe 1200mm probe ø 6mm probe L 195mm shaft ø 8x6.5mm shaft L 21/15mm shaft flat upper		
--------------------	--	--	--

<b>description</b>	gas thermostat PEL type 25ST up to 190°C gas inlet M16x1.5 (tube ø 10mm) bypass nozzle ø 0mm gas outlet M16x1.5 (tube ø 10/8mm) thermocouple connection M9x1 pilot connection M10x1 capillary pipe 1200mm probe ø 6mm probe L 195mm shaft ø 8x6.5mm shaft L 21/15mm shaft flat upper		
<b>spare parts for</b>	107780		
	<b>GEV No.</b>	101060	<b>Ref. No.</b> —
	magnet unit standard L 39mm D1 ø 15.4mm D2 ø 11mm suitable for PEL20-21/JUNKERS/EGA		
	<b>GEV No.</b>	106191	<b>Ref. No.</b> —
	bypass nozzle type PEL22 bore ø 0mm thread M6x0.5		
	<b>GEV No.</b>	106200	<b>Ref. No.</b> —
	nut thread M9x1 suitable for PEL 24/25S		
<b>accessories for</b>	107780		
	<b>GEV No.</b>	100908	<b>Ref. No.</b> —
	union screw thread M10x1 for pipe ø 4mm Qty 1 pcs		
	<b>GEV No.</b>	100909	<b>Ref. No.</b> —
	union screw thread M10x1 for pipe ø 6mm Qty 1 pcs		
	<b>GEV No.</b>	101246	<b>Ref. No.</b> —
	olive for pipe ø 4mm Qty 1 pcs		
	<b>GEV No.</b>	101278	<b>Ref. No.</b> —
	olive for pipe ø 10mm Qty 1 pcs		

<b>accessories for</b>	107780		
	<b>GEV No.</b>	101286	<b>Ref. No.</b> —
	olive ID ø 6mm Qty 1 pcs		
	<b>GEV No.</b>	101300	<b>Ref. No.</b> —
	union nut thread M16x1.5 tube ø 10mm		
	<b>GEV No.</b>	101450	<b>Ref. No.</b> —
	olive for pipe ø 8mm L 12.7mm Qty 1 pcs ED ø 10mm		
	<b>GEV No.</b>	101451	<b>Ref. No.</b> —
	union nut thread M16x1.5 tube ø 8mm		



<b>GEV No.</b>	107838	<b>Ref. No.</b>	E02298
<b>description</b>	gas thermostat PEL type 25ST up to 210°C gas inlet M16x1.5 (tube ø 10mm) bypass nozzle ø 0mm gas outlet M16x1.5 (tube ø 10/8mm) thermocouple connection M9x1 pilot connection M10x1 capillary pipe 1200mm probe ø 6mm probe L 195mm shaft ø 8x6.5mm shaft L 21/15mm shaft flat upper		

ignition parts

pilot burners

SIT

100 series



























<b>GEV No.</b>	106901	<b>Ref. No.</b>	E02188
<b>description</b>	pilot burner SIT type 100 series 1 flame nozzle ø 0.2mm gas connection 6mm		
<b>spare parts for</b>	106901		
	<b>GEV No.</b>	100854	<b>Ref. No.</b> —
	pilot burner bracket double		
	<b>GEV No.</b>	100916	<b>Ref. No.</b> —
	compression spring for pilot burner Qty 1 pcs		
	<b>GEV No.</b>	100917	<b>Ref. No.</b> —
	gasket for pilot burner Qty 1 pcs aluminium		
	<b>GEV No.</b>	100918	<b>Ref. No.</b> —
	screw for pilot burner		
<b>accessories for</b>	106901		
	<b>GEV No.</b>	100904	<b>Ref. No.</b> —
	locking screw M10x1 for pipe ø 4mm Qty 1 pcs		

Table continues overleaf



accessories for		106901		
GEV No.		100905	Ref. No.	—
	locking screw M10x1 for pipe ø 6mm Qty 1 pcs			
	pilot tube copper pipe ø 4mm thickness 1mm L 3000mm			
	pilot tube copper pipe ø 6mm thickness 1mm L 3000mm			
	pilot burner nozzle LPG code 25 bore ø 0.25mm Qty 1 pcs			

accessories for		106903		
GEV No.		100905	Ref. No.	—
	locking screw M10x1 for pipe ø 6mm Qty 1 pcs			
	pilot tube copper pipe ø 4mm thickness 1mm L 3000mm			
	pilot tube copper pipe ø 6mm thickness 1mm L 3000mm			
	pilot burner nozzle SIT natural/liquid gas bore ø 0.25mm Qty 1 pcs			
	pilot burner bottom part SIT 100 series nozzle ø 0.25mm			
	pilot burner bottom part SIT 100 series nozzle ø 0.35mm			

 <p>1</p>				
GEV No.	106903	Ref. No.	E02032	
description	pilot burner SIT type 100 series 3 flames nozzle ø 0.2mm gas connection 6mm			
For models:	GSM60, SGF80			
spare parts for	106903			
	GEV No.	100245	Ref. No.	E02086
	pilot burner nozzle LPG code 20 bore ø 0.2mm Qty 1 pcs thread M8x0.75			
	GEV No.	100854	Ref. No.	—
	pilot burner bracket double			
	GEV No.	100885	Ref. No.	—
	air mixing sleeve for pilot burner Qty 1 pcs			
	GEV No.	100916	Ref. No.	—
	compression spring for pilot burner Qty 1 pcs			
	GEV No.	100917	Ref. No.	—
	gasket for pilot burner Qty 1 pcs aluminium			
	GEV No.	100918	Ref. No.	—
	screw for pilot burner			
	GEV No.	107162	Ref. No.	—
	pilot burner cap SIT 3 flames Hmm Lmm Qty 1 pcs			
	GEV No.	107701	Ref. No.	—
	pilot burner bottom part SIT 100 series nozzle ø 0.2mm			
accessories for		106903		
	GEV No.	100245	Ref. No.	E02086
	pilot burner nozzle LPG code 20 bore ø 0.2mm Qty 1 pcs thread M8x0.75			
	GEV No.	100246	Ref. No.	E02086
	pilot burner nozzle natural gas bore ø 0.35mm Qty 1 pcs thread M8x0.75			
	GEV No.	100904	Ref. No.	—
	locking screw M10x1 for pipe ø 4mm Qty 1 pcs			

accessories				
pilot burner nozzles				
 <p>1</p>				
GEV No.	100245	Ref. No.	E02086	
description	pilot burner nozzle LPG code 20 bore ø 0.2mm Qty 1 pcs thread M8x0.75			

 <p>1</p>				
GEV No.	100246	Ref. No.	E02086	
description	pilot burner nozzle natural gas bore ø 0.35mm Qty 1 pcs thread M8x0.75			

## piezoelectric igniters

miscellaneous				
 <p>1</p>				
GEV No.	107692	Ref. No.	E02212 E02215	
description	service kit piezoelectric igniter ignition electrode included			



thermocouples

plug-in thermocouples

plug-in thermocouples standard

with barrel socket  $\phi 6(6.5)$ mm

thermocouples SIT

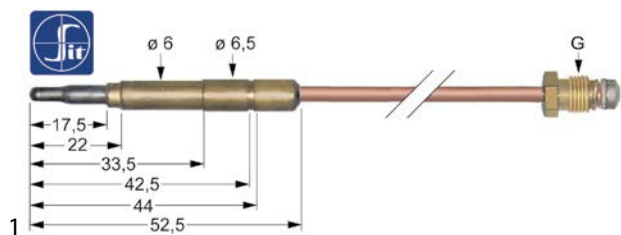

<b>GEV No.</b>	107609	<b>Ref. No.</b>	E02033
<b>description</b>	thermocouple SIT M9x1 L 600mm plug connection $\phi 6.0(6.5)$ mm		
<b>For models:</b>	RBG12, RBG4, RBG8		

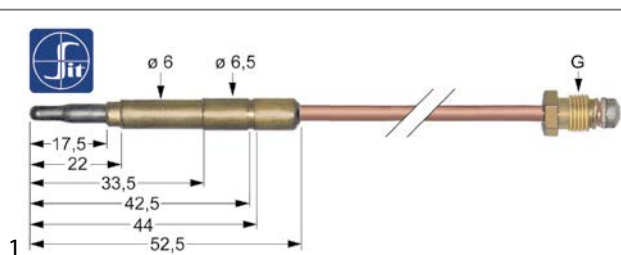

<b>GEV No.</b>	107611	<b>Ref. No.</b>	E02011
<b>description</b>	thermocouple SIT M9x1 L 850mm plug connection $\phi 6.0(6.5)$ mm		

thermocouples with aluminised tip

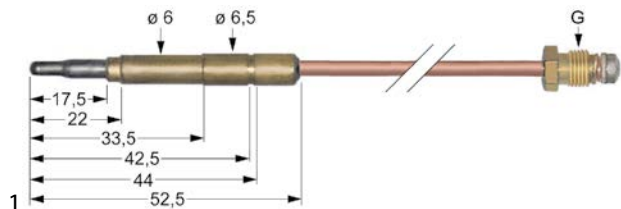

<b>GEV No.</b>	102041	<b>Ref. No.</b>	E02033
<b>description</b>	thermocouple M9x1 L 600mm plug connection $\phi 6.0(6.5)$ mm		



<b>GEV No.</b>	102240	<b>Ref. No.</b>	E02033
<b>description</b>	thermocouple set		

plug-in thermocouples with cable link



<b>GEV No.</b>	107522	<b>Ref. No.</b>	E02201 E02253
<b>description</b>	thermocouple L 1300mm connection M9x1 plug connection $\phi 6.0$ mm		

threaded thermocouples

threaded thermocouples standard

with socket with thread M8x1

SIT

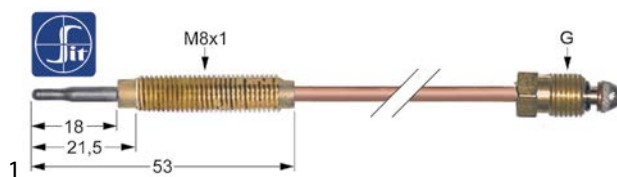

<b>GEV No.</b>	107628	<b>Ref. No.</b>	E02237	
<b>description</b>	thermocouple SIT M8x1 L 320mm M8x1			
<b>accessories for</b>	107628			
	<b>GEV No.</b>	102067	<b>Ref. No.</b>	—
	nut thread M8x1 H 3mm brass Qty 1 pcs type SEF 1			

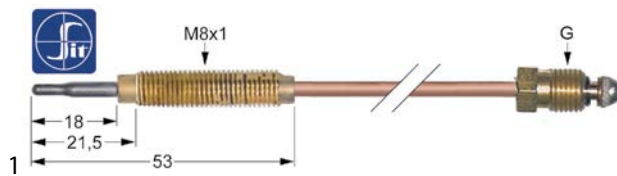

<b>GEV No.</b>	107638	<b>Ref. No.</b>	E02011 E02029
<b>description</b>	thermocouple SIT M9x1 L 1000mm M8x1		
<b>For models:</b>	GRG40, GRG60, GRG80, GSM60, SGF80		

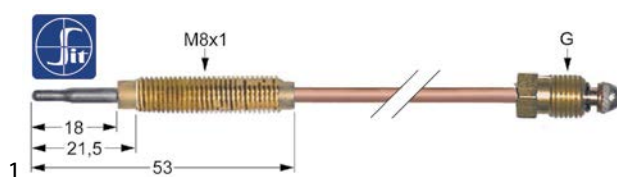

<b>GEV No.</b>	107639	<b>Ref. No.</b>	E02147
<b>description</b>	thermocouple SIT M9x1 L 1200mm M8x1		



## extensions

1 

<b>GEV No.</b>	102241	<b>Ref. No.</b>	E02033 E02081
<b>description</b>	thermocouple extension flexible thread M9x1 - M9x1 L 500mm		

1 

<b>GEV No.</b>	102811	<b>Ref. No.</b>	E02251
<b>description</b>	thermocouple extension thread M9x1 - M9x1 L 600mm		

## gas burners

### hob burners

#### producer-specific hob burners

#### ROLLER GRILL

1 

<b>GEV No.</b>	103059	<b>Ref. No.</b>	E01015
<b>description</b>	burner ø 125mm for burner cap ø 124mm nozzle mounting 1/4" H 102mm with burner cover and nozzle		

### bar burners

#### bar burners

1 

<b>GEV No.</b>	105505	<b>Ref. No.</b>	E01006
<b>description</b>	bar burner ø 40mm Wmm Hmm L 288mm griddle flange ø 61mm		
<b>For models:</b>	PSG400, PSG600		

## ceramic burners

1 

<b>GEV No.</b>	105509	<b>Ref. No.</b>	E01005
<b>description</b>	ceramic burner L 220mm W 168mm firing range 178x125mm for gyro grill		
<b>For models:</b>	GRG40, GRG60, GRG80		

1 

<b>GEV No.</b>	104757	<b>Ref. No.</b>	E01012 E01012 + 71061
<b>description</b>	ceramic burner L 415mm W 80mm firing range 395x65mm 2.6kW		
<b>accessories for</b>	104757		
	<b>GEV No.</b>	104758	<b>Ref. No.</b>
	nozzle set for ceramic burner EG+FG		

1 



<b>GEV No.</b>	107516	<b>Ref. No.</b>	E01001
<b>description</b>	ceramic burner L 430mm W 80mm firing range 390x38mm H 46mm		
<b>For models:</b>	SGM60		

1 

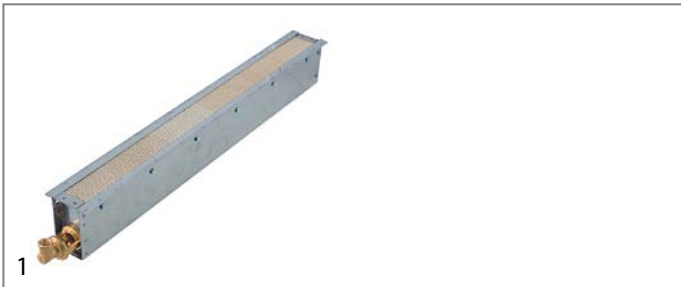
<b>GEV No.</b>	104681	<b>Ref. No.</b>	E01011
<b>description</b>	ceramic burner L 580mm W 85mm firing range 494x63mm 4kW		



1

<b>GEV No.</b>	105506	<b>Ref. No.</b>	E01002
<b>description</b>	ceramic burner L 585mm W 67mm firing range 549x38mm for salamander/chicken rotisserie		
<b>accessories for</b>	105506		
	<b>GEV No.</b>	100982	<b>Ref. No.</b> E02077
	gas injector thread M8x1 WS 12 bore ø 0.85mm		
	<b>GEV No.</b>	102953	<b>Ref. No.</b> —
	gas injector thread M8x1 WS 12 bore ø 1.1mm		



1

<b>GEV No.</b>	107572	<b>Ref. No.</b>	E01002
<b>description</b>	ceramic burner L 585mm W 67mm firing range 549x38mm for salamander/chicken rotisserie		
<b>For models:</b>	RBG12, RBG4, RBG8, SGF80		
<b>accessories for</b>	107572		
	<b>GEV No.</b>	107573	<b>Ref. No.</b> E02158
	screw connection		
	<b>GEV No.</b>	107574	<b>Ref. No.</b> E02157
	cap		
	<b>GEV No.</b>	107575	<b>Ref. No.</b> E02160
	nozzle holder		

**accessories**

**burner grids**



1

<b>GEV No.</b>	850017	<b>Ref. No.</b>	F01059
<b>description</b>	burner grid L 228mm W 163mm for gyro grill		



1

<b>GEV No.</b>	105508	<b>Ref. No.</b>	36063GRI
<b>description</b>	burner grid L 360mm W 200mm		
<b>For models:</b>	GRG40, GRG80		



1

<b>GEV No.</b>	105511	<b>Ref. No.</b>	36064GRI 36065GRI
<b>description</b>	burner grid L 545mm W 200mm		
<b>For models:</b>	GRG60		

**star burners**



1

<b>GEV No.</b>	105500	<b>Ref. No.</b>	E01003
<b>description</b>	star burner 3kW L 330mm W 298mm H 82mm number of burners: 6 for crepes maker		
<b>For models:</b>	350G, 350GD, 400G, 400GD		



1

<b>GEV No.</b>	107000	<b>Ref. No.</b>	E01007
<b>description</b>	star burner L 317mm W 308mm H 90mm number of burners: 6 for crepes maker		

**accessories**

**miscellaneous**





1

<b>GEV No.</b>	107574	<b>Ref. No.</b>	E02157
<b>description</b>	cap		





			
1			
<b>GEV No.</b>	105501	<b>Ref. No.</b>	68009
<b>description</b>	flame spreader		
<b>For models:</b>	350G, 350GD, 400G, 400GD		

			
1			
<b>GEV No.</b>	107575	<b>Ref. No.</b>	E02160
<b>description</b>	nozzle holder		

			
1			
<b>GEV No.</b>	107573	<b>Ref. No.</b>	E02158
<b>description</b>	screw connection		

## gas nozzles

### main nozzles

<b>gas nozzles 3/8"</b>			
			
1			
<b>GEV No.</b>	100984	<b>Ref. No.</b>	E02074
<b>description</b>	gas injector thread 3/8" WS 17 bore ø 0.75mm		
<b>For models:</b>	350G, 350GD, 400G, 400GD, PSG400, PSG600		

			
1			
<b>GEV No.</b>	100985	<b>Ref. No.</b>	E02075
<b>description</b>	gas injector thread 3/8" WS 17 bore ø 0.85mm		
<b>For models:</b>	350G, 350GD, 400GD, PSG400, PSG600		

<b>gas nozzles M7x0.75</b>			
			
1			
<b>GEV No.</b>	106649	<b>Ref. No.</b>	E02170
<b>description</b>	gas injector thread M7x0.75mm WS 8 bore ø 1mm		

<b>gas nozzles M8x1</b>			
			
1			
<b>GEV No.</b>	106999	<b>Ref. No.</b>	E02018
<b>description</b>	gas injector thread M8x1 WS 10 bore ø 0.9mm		

			
1			
<b>GEV No.</b>	100988	<b>Ref. No.</b>	E02076
<b>description</b>	gas injector thread M8x1 WS 10 bore ø 1.35mm		
<b>For models:</b>	350GD, 400G, 400GD		

			
1			
<b>GEV No.</b>	106910	<b>Ref. No.</b>	E02016
<b>description</b>	gas injector thread M8x1 WS 10 bore ø 1.45mm		

			
1			
<b>GEV No.</b>	106911	<b>Ref. No.</b>	E02019
<b>description</b>	gas injector thread M8x1 WS 10 bore ø 1mm		

			
1			
<b>GEV No.</b>	100982	<b>Ref. No.</b>	E02077
<b>description</b>	gas injector thread M8x1 WS 12 bore ø 0.85mm		
<b>For models:</b>	GSM60, SGF80		

			
1			
<b>GEV No.</b>	100987	<b>Ref. No.</b>	E02040 E02079
<b>description</b>	gas injector thread M8x1 WS 12 bore ø 1.3mm		
<b>For models:</b>	GSM60, SGF80		

			
1			
<b>GEV No.</b>	100983	<b>Ref. No.</b>	E02090
<b>description</b>	gas injector thread M8x1 WS 12 bore ø 1.5mm		
<b>For models:</b>	GSM60, SGF80		

pilot burner nozzles

pilot burner nozzles SIT

100 series



<b>GEV No.</b>	100245	<b>Ref. No.</b>	E02086
<b>description</b>	pilot burner nozzle LPG code 20 bore ø 0.2mm Qty 1 pcs thread M8x0.75		



<b>GEV No.</b>	100246	<b>Ref. No.</b>	E02086
<b>description</b>	pilot burner nozzle natural gas bore ø 0.35mm Qty 1 pcs thread M8x0.75		



<b>GEV No.</b>	107170	<b>Ref. No.</b>	E02086
<b>description</b>	pilot burner nozzle SIT natural gas bore ø 0.35mm Qty 1 pcs		
<b>For models:</b>	GSM60, SGF80, SGM60		

burner nozzles



<b>GEV No.</b>	698960	<b>Ref. No.</b>	E02179
<b>description</b>	nozzle for ceramic burner EG+FG L 28.7mm W 21mm H 21mm M14x1.25		

gas nozzles sets



<b>GEV No.</b>	104758	<b>Ref. No.</b>	E02160+E02179+E02180
<b>description</b>	nozzle set for ceramic burner EG+FG		

auxiliary gas parts

gas hoses

miscellaneous



<b>GEV No.</b>	250008	<b>Ref. No.</b>	E02087
<b>description</b>	gas hose L 500mm nominal-ø 6mm		
<b>For models:</b>	GSM60, SGF80		



<b>GEV No.</b>	105512	<b>Ref. No.</b>	E02088
<b>description</b>	gas hose L 560mm hose SS for pipe ø 10mm		
<b>For models:</b>	GSM60, SGF80		

consumables

lava rocks / ceramic briquetts



<b>GEV No.</b>	693326	<b>Ref. No.</b>	F07001
<b>description</b>	lava rocks size ca.20mm Qty 1.5kg		

equipment-specific units

for display coolers

glass panels

glass panels



<b>GEV No.</b>	692050	<b>Ref. No.</b>	SH01017
<b>description</b>	glass panel H 5mm ø 575mm for fridge glas		

for bain marie

drain systems

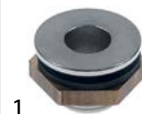

<b>GEV No.</b>	691913	<b>Ref. No.</b>	E02059 E02059 + E02056 + E02057
<b>description</b>	drain fitting thread 3/8" SS ø 24mm H 16mm		

spare parts for

<b>GEV No.</b>	511182	<b>Ref. No.</b>	E02057
<b>description</b>	nut thread 3/8" H 8mm brass WS 24 Qty 1 pcs		



housing and bezels



1

<b>GEV No.</b>	550826	<b>Ref. No.</b>	65004
<b>description</b>	fixing plate for heating element L 275mm W 240mm H 8mm mounting pos. lower hole ø 6mm		



1

<b>GEV No.</b>	418893	<b>Ref. No.</b>	H02028
<b>description</b>	insulating mat L 260mm W 235mm thickness 15mm		

for crepes makers

cast plates



1

<b>GEV No.</b>	693021	<b>Ref. No.</b>	B02016
<b>description</b>	cast plate ø 350mm		



1

<b>GEV No.</b>	693020	<b>Ref. No.</b>	B02015
<b>description</b>	cast plate ø 400mm		
<b>For models:</b>	400E, 400ED, 400FE, 400G, 400GD		

accessories



1

<b>GEV No.</b>	694451	<b>Ref. No.</b>	F05017
<b>description</b>	batter spreader for crepes maker ø 12.3mm L 184mm W 180mm wood		

for deep fryers

lids



1

<b>GEV No.</b>	696404	<b>Ref. No.</b>	07107
<b>description</b>	lid L 325mm W 265mm for fryer FD80		

basket holders



1

<b>GEV No.</b>	970739	<b>Ref. No.</b>	F04011
<b>description</b>	basket support for fryer basket W 265mm H 225mm		

sumps



1

<b>GEV No.</b>	695118	<b>Ref. No.</b>	F05068
<b>description</b>	sump for fryer with hole L 320mm W 260mm H 200mm 8l		



1

<b>GEV No.</b>	691952	<b>Ref. No.</b>	F05002
<b>description</b>	sump for fryer without hole L 320mm W 170mm H 200mm		



1

<b>GEV No.</b>	691923	<b>Ref. No.</b>	F05027
<b>description</b>	sump for fryer without hole L 530mm W 325mm H 170mm		



1

<b>GEV No.</b>	691924	<b>Ref. No.</b>	F05028
<b>description</b>	sump for fryer/pasta cooker with hole L 530mm W 325mm H 170mm		

for drink dispensers

valve bodies



1

<b>GEV No.</b>	698959	<b>Ref. No.</b>	SB04059
<b>description</b>	valve body H 52mm ø 40.8mm M16x2		

for grills

sumps



1

<b>GEV No.</b>	693016	<b>Ref. No.</b>	4900P7110 49015
<b>description</b>	grease collecting tray L 650mm W 50mm H 45mm		
<b>For models:</b>	PSE 600		

for griddles

griddles



1

<b>GEV No.</b>	693361	<b>Ref. No.</b>	B02027
<b>description</b>	cast plate L 400mm W 380mm H 60mm griddle		
<b>For models:</b>	PSE400, PSG400		



1

<b>GEV No.</b>	693015	<b>Ref. No.</b>	B02026
<b>description</b>	griddle		
<b>For models:</b>	PSE600, PSG600		

### sumps



1

<b>GEV No.</b>	698310	<b>Ref. No.</b>	53022
<b>description</b>	drain tray L 414mm W 35mm H 80mm		

## for gyros grills

### skewers

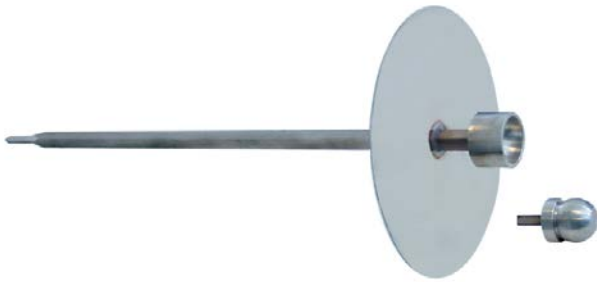

1

<b>GEV No.</b>	693008	<b>Ref. No.</b>	F03028
<b>description</b>	skewer for gyro grill size 12x12mm L 535mm with skewer plates ø 210mm		
<b>For models:</b>	GRE40, GRG40		



1

<b>GEV No.</b>	693034	<b>Ref. No.</b>	F03030
<b>description</b>	skewer for gyro grill size 12x12mm L 715mm with skewer plates ø 210mm		
<b>For models:</b>	GRE80, GRG80		

### miscellaneous



1

<b>GEV No.</b>	301201	<b>Ref. No.</b>	B04048
<b>description</b>	ball for skewer		
<b>For models:</b>	GRE40, GRE60, GRE80, GRG40, GRG60, GRG80		



1

<b>GEV No.</b>	694845	<b>Ref. No.</b>	B06012
<b>description</b>	bracket for ball bearing mounting pos. lower		



1

<b>GEV No.</b>	693013	<b>Ref. No.</b>	B06036
<b>description</b>	rubber pad		



1

<b>GEV No.</b>	694846	<b>Ref. No.</b>	B04071
<b>description</b>	skewer intake mounting pos. lower		

## for chicken rotisserie

### baskets



1

<b>GEV No.</b>	970919	<b>Ref. No.</b>	B04054
<b>description</b>	basket for chicken rotisserie L 664mm W 140mm H 100mm chrome-plated steel		

### skewers



1

<b>GEV No.</b>	693010	<b>Ref. No.</b>	F03019
<b>description</b>	skewer for chicken rotisserie L 588mm thickness 8x8mm shaft intake ø 5x15mm stainless steel		
<b>For models:</b>	RBE12, RBE4, RBE8, RBG12, RBG4, RBG8		



			
1			
<b>GEV No.</b>	693433	<b>Ref. No.</b>	F03003
<b>description</b>	skewer for oven		

spit clamp

			
1			
<b>GEV No.</b>	693011	<b>Ref. No.</b>	F03020
<b>description</b>	skewer clamp for chicken rotisserie ID ø 13mm L 130mm W 73mm		
<b>For models:</b>	RBE12, RBE4, RBE8, RBG12, RBG4, RBG8		

			
1			
<b>GEV No.</b>	691648	<b>Ref. No.</b>	F03021 + F03020 F03034
<b>description</b>	skewer clamp set composed of 3xZ, 2xU		

for hot counters

housing and bezels

 <p>Image not available</p>			
1			
<b>GEV No.</b>	693341	<b>Ref. No.</b>	H01045
<b>description</b>	cover for hot counter plexiglas mounting pos. in the front/at the back		
<b>For models:</b>	WDL 100, WDL 200		

 <p>Image not available</p>			
1			
<b>GEV No.</b>	693343	<b>Ref. No.</b>	H01040
<b>description</b>	cover for hot counter plexiglas mounting pos. in the front/at the back		
<b>For models:</b>	WDL 100, WDL 200		

			
1			
<b>GEV No.</b>	550826	<b>Ref. No.</b>	65004
<b>description</b>	fixing plate for heating element L 275mm W 240mm H 8mm mounting pos. lower hole ø 6mm		

 <p>Image not available</p>			
1			
<b>GEV No.</b>	418893	<b>Ref. No.</b>	H02028
<b>description</b>	insulating mat L 260mm W 235mm thickness 15mm		

 <p>Image not available</p>			
1			
<b>GEV No.</b>	693342	<b>Ref. No.</b>	H01041
<b>description</b>	protector for glass mounting for hot counter		

 <p>Image not available</p>			
1			
<b>GEV No.</b>	693340	<b>Ref. No.</b>	H01043
<b>description</b>	side panel for hot counter plexiglas mounting pos. left/right		
<b>For models:</b>	WD 100, WDL 100		

doors

			
1			
<b>GEV No.</b>	693339	<b>Ref. No.</b>	H01044
<b>description</b>	door complete plexiglas for hot counter		
<b>For models:</b>	WD 100, WDL 100		



## for convection ovens/combi-steamers

### spare parts and accessories

1 

<b>GEV No.</b>	693043	<b>Ref. No.</b>	F02005
<b>description</b>	guard		
<b>For models:</b>	FC26, FC34, TH1		

## for hot dog machines

### lids



<b>GEV No.</b>	693051	<b>Ref. No.</b>	F05038
<b>description</b>	lid		



<b>GEV No.</b>	694450	<b>Ref. No.</b>	F05051
<b>description</b>	lid for hot dog machine ø 205mm		

### glass cylinders



<b>GEV No.</b>	693003	<b>Ref. No.</b>	F05012
<b>description</b>	glass cylinder ø 200mm H 240mm		



<b>GEV No.</b>	693002	<b>Ref. No.</b>	F05009
<b>description</b>	glass cylinder ø 200mm Pyrex glass H 240mm		

### skewers



<b>GEV No.</b>	693018	<b>Ref. No.</b>	F05010
<b>description</b>	bun spikes for hot dog machine		

## water containers



<b>GEV No.</b>	693006	<b>Ref. No.</b>	F05025
<b>description</b>	water container for hot dog machine		



<b>GEV No.</b>	693005	<b>Ref. No.</b>	F05022
<b>description</b>	water container for hot dog machine PTFE/aluminium		

## for panini grill

### guiding pieces



<b>GEV No.</b>	699279	<b>Ref. No.</b>	B03003 B03007+B06063
<b>description</b>	bearing block with bush L 50mm W 20mm H 10mm		

### cast plates



<b>GEV No.</b>	693362	<b>Ref. No.</b>	B02022
<b>description</b>	cast plate mounting pos. lower grooved		
<b>For models:</b>	MAJESTIC		



1

<b>GEV No.</b>	693367	<b>Ref. No.</b>	B02018
<b>description</b>	cast plate mounting pos. lower grooved		
<b>For models:</b>	SAVOYE		



1

<b>GEV No.</b>	693360	<b>Ref. No.</b>	B02021
<b>description</b>	cast plate mounting pos. lower smooth		
<b>For models:</b>	MAJESTIC		



1

<b>GEV No.</b>	693359	<b>Ref. No.</b>	B02023
<b>description</b>	cast plate mounting pos. lower L 373mm W 294mm H 78mm grooved		
<b>For models:</b>	DOUBLE PANINI, PANINI		



1

<b>GEV No.</b>	693366	<b>Ref. No.</b>	B02020
<b>description</b>	cast plate mounting pos. lower smooth		
<b>For models:</b>	SAVOYE		



1

<b>GEV No.</b>	693363	<b>Ref. No.</b>	B02017 B02017+PTR
<b>description</b>	cast plate mounting pos. lower L 550mm W 300mm grooved		
<b>For models:</b>	MAJESTIC		



1

<b>GEV No.</b>	693365	<b>Ref. No.</b>	B02019
<b>description</b>	cast plate mounting pos. upper L 250mm W 240mm grooved		
<b>For models:</b>	MAJESTIC, SAVOYE		



1

<b>GEV No.</b>	693357	<b>Ref. No.</b>	B02025
<b>description</b>	cast plate mounting pos. lower smooth		
<b>For models:</b>	DOUBLE PANINI, PANINI		



1

<b>GEV No.</b>	693356	<b>Ref. No.</b>	B02033
<b>description</b>	cast plate mounting pos. upper L 355mm W 235mm smooth		
<b>For models:</b>	DOUBLE PANINI, PANINI		





1

<b>GEV No.</b>	693358	<b>Ref. No.</b>	B02024
<b>description</b>	cast plate mounting pos. upper L 355mm W 255mm grooved		
<b>For models:</b>	DOUBLE PANINI, PANINI		



1

<b>GEV No.</b>	693364	<b>Ref. No.</b>	B02034
<b>description</b>	cast plate mounting pos. upper smooth		
<b>For models:</b>	MAJESTIC, SAVOYE		

## for contact grills

### griddles

### ceran plates



1

<b>GEV No.</b>	694268	<b>Ref. No.</b>	37250COL
<b>description</b>	ceran plate L 275mm W 252mm H 45mm grooved		

## for ovens

### glass panels



1

<b>GEV No.</b>	698958	<b>Ref. No.</b>	H01076
<b>description</b>	glass panel L 215mm W 90mm H 5mm thickness 5mm Qty 1 pcs		

### miscellaneous



1

<b>GEV No.</b>	698614	<b>Ref. No.</b>	H01011
<b>description</b>	glass panel for door oven L 577mm W 435mm H 4.5mm		
<b>For models:</b>	FC60		

## for pizza ovens

### firebricks



1

<b>GEV No.</b>	693001	<b>Ref. No.</b>	F07005
<b>description</b>	firebrick delivery freight forwarding company only		



1

<b>GEV No.</b>	693009	<b>Ref. No.</b>	F07005 F07008
<b>description</b>	firebrick L 350mm W 322mm H 15mm delivery freight forwarding company only		
<b>For models:</b>	PZ330, PZ660		

miscellaneous



1			
<b>GEV No.</b>	693041	<b>Ref. No.</b>	H02002
<b>description</b>	insulating mat L 215mm W 195mm		
<b>For models:</b>	PZ330, PZ660, SEM60		

for rechauds

warming plates

components



1			
<b>GEV No.</b>	693014	<b>Ref. No.</b>	F07009
<b>description</b>	handle protection for warming plate		

warming plates



1			
<b>GEV No.</b>	416720	<b>Ref. No.</b>	H04051
<b>description</b>	warming plate		

for rolling grills

drive shafts



1			
<b>GEV No.</b>	693032	<b>Ref. No.</b>	B04012 B04072
<b>description</b>	drive shaft L 450mm		
<b>For models:</b>	RG11, RG5, RG7, RG9		

pipes

bushes



1			
<b>GEV No.</b>	693038	<b>Ref. No.</b>	B06029
<b>description</b>	bushing ED ø 37mm ID ø 30mm H 4.5mm PTFE suitable for ROLLER GRILL		
<b>For models:</b>	RG11, RG5, RG7, RG9		

gear wheels



1			
<b>GEV No.</b>	693160	<b>Ref. No.</b>	B01004
<b>description</b>	gear wheel teeth 20 shaft intake ø 8mm ø 38mm hub ø 20mm stainless steel		

for salamander grills



1			
<b>GEV No.</b>	692240	<b>Ref. No.</b>	30045
<b>description</b>	drain tray for salamander grill L 350mm W 245mm		

for toasters

spare parts and accessories



1			
<b>GEV No.</b>	693043	<b>Ref. No.</b>	F02005
<b>description</b>	guard		
<b>For models:</b>	FC26, FC34, TH1		



## miscellaneous



1

<b>GEV No.</b>	694023	<b>Ref. No.</b>	B03004 B03008 B03008+B06063
<b>description</b>	bearing for conveyor toaster mounting pos. front		

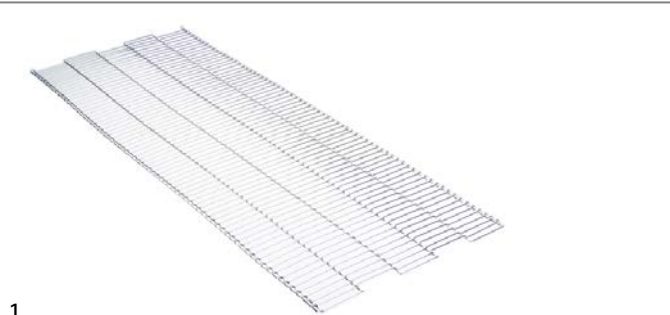

1

<b>GEV No.</b>	694024	<b>Ref. No.</b>	F01045
<b>description</b>	conveyor belt for conveyor toaster		

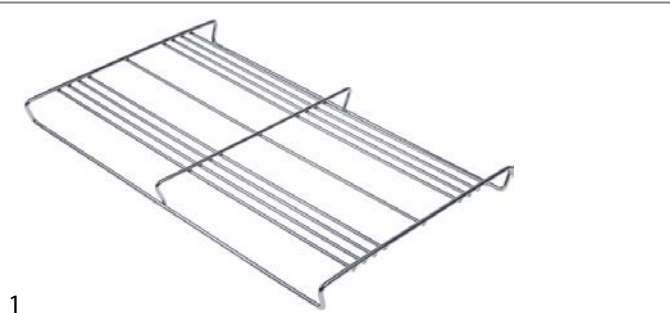

1

<b>GEV No.</b>	694449	<b>Ref. No.</b>	F01069
<b>description</b>	guard L 315mm W 200mm for toaster H 24mm		

## pliers

### pliers



1

<b>GEV No.</b>	690010	<b>Ref. No.</b>	F01013
<b>description</b>	plier for toaster H 180mm total length 100mm		

## for waffle irons

### cast plates



1

<b>GEV No.</b>	693349	<b>Ref. No.</b>	B02029INF
<b>description</b>	cast plate for waffle iron for model GES10 mounting pos. lower		



1

<b>GEV No.</b>	693348	<b>Ref. No.</b>	B02029SUO
<b>description</b>	cast plate for waffle iron for model GES10 mounting pos. upper		
<b>For models:</b>	GED10, GES10		



1

<b>GEV No.</b>	693303	<b>Ref. No.</b>	B02029PTR
<b>description</b>	cast plate for waffle iron for model GES10 set mounting pos. upper/lower L 250mm W 250mm H 60mm		



1

<b>GEV No.</b>	693351	<b>Ref. No.</b>	B02028INF
<b>description</b>	cast plate for waffle iron for model GES20 mounting pos. lower		
<b>For models:</b>	GED20, GES20		



1

<b>GEV No.</b>	693350	<b>Ref. No.</b>	B02028SUP
<b>description</b>	cast plate for waffle iron for model GES20 mounting pos. upper		
<b>For models:</b>	GED20, GES20		



1

<b>GEV No.</b>	691251	<b>Ref. No.</b>	B02032PRT
<b>description</b>	cast plate for waffle iron for model GES20 set mounting pos. upper/lower L 250mm W 250mm H 60mm		



1

<b>GEV No.</b>	693353	<b>Ref. No.</b>	B02030INF
<b>description</b>	cast plate for waffle iron for model GES30 mounting pos. lower		
<b>For models:</b>	GED30, GES30		



1

<b>GEV No.</b>	693426	<b>Ref. No.</b>	B02041INF
<b>description</b>	cast plate for waffle iron for model GES30 mounting pos. lower		



1

<b>GEV No.</b>	693352	<b>Ref. No.</b>	B02030SUP
<b>description</b>	cast plate for waffle iron for model GES30 mounting pos. upper		
<b>For models:</b>	GED30, GES30		



1

<b>GEV No.</b>	693425	<b>Ref. No.</b>	B02041SUP
<b>description</b>	cast plate for waffle iron for model GES30 mounting pos. upper		



1

<b>GEV No.</b>	693355	<b>Ref. No.</b>	B02031INF
<b>description</b>	cast plate for waffle iron for model GES40 mounting pos. lower		
<b>For models:</b>	GED40, GES40		



1

<b>GEV No.</b>	693354	<b>Ref. No.</b>	B02031SUP
<b>description</b>	cast plate for waffle iron for model GES40 mounting pos. upper		
<b>For models:</b>	GED40, GES40		



1

<b>GEV No.</b>	692111	<b>Ref. No.</b>	B02031PTR
<b>description</b>	cast plate for waffle iron for model GES40 set mounting pos. upper/lower L 250mm W 250mm H 60mm		

## knobs

### producer-specific knobs

#### ROLLER GRILL



1

<b>GEV No.</b>	112784	<b>Ref. No.</b>	A14094
<b>description</b>	knob switch zero mark ø 40mm shaft ø 6x4.6mm shaft flat left black		

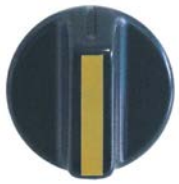

1

<b>GEV No.</b>	110654	<b>Ref. No.</b>	A14090
<b>description</b>	knob switch zero mark ø 40mm shaft ø 6x4.6mm shaft flat lower black		
<b>For models:</b>	CN		



1

<b>GEV No.</b>	110651	<b>Ref. No.</b>	A14078 A14097
<b>description</b>	knob switch zero mark ø 50mm shaft ø 6x4.6mm shaft flat upper black		
<b>For models:</b>	350E, 350ED, 350G, 350GD, 400E, 400ED, 400FE, 400G, 400GD, CT540, DOUBLE PANINI, FC110, FC110G, FC33, FC34, FC60, FC60G, FD120R, GED10, GED20, GED30, GED40, GES10, GES20, GES30, GES40, GRE40, GRE60, GRE80, MAJESTIC, PANINI, PSE400, PSE600, PZ330, PZ400, PZ660, RBE12, RBE4, RBE8, RG11, RG5, RG7, RG9, SAVOYE, SEF80, SEM60		



1

<b>GEV No.</b>	110653	<b>Ref. No.</b>	A14029
<b>description</b>	knob switch zero mark ø 50mm shaft ø 6x4.6mm shaft flat upper black		
<b>For models:</b>	TH1		



1

<b>GEV No.</b>	110652	<b>Ref. No.</b>	A14076
<b>description</b>	knob switch zero mark ø 50mm shaft ø 8x6.5mm shaft flat right black		
<b>For models:</b>	GSM60, RBG12, RBG4, RBG8, SGF80		



1

<b>GEV No.</b>	110656	<b>Ref. No.</b>	A14075
<b>description</b>	knob switch zero mark ø 50mm shaft ø 8x6.5mm shaft flat upper black		
<b>For models:</b>	GRG40, GRG60, GRG80		

			
1			
<b>GEV No.</b>	110655	<b>Ref. No.</b>	A14077 A14113
<b>description</b>	knob switch zero mark ø 50mm shaft ø 8x7mm shaft flat left black		
<b>For models:</b>	PSG400, PSG600		

			
1			
<b>GEV No.</b>	110657	<b>Ref. No.</b>	A14042 A14084 A14121
<b>description</b>	knob switch zero mark t.max.°C temperature range°C ø 40mm shaft ø 6x4.6mm shaft flat lower black		
<b>For models:</b>	140, 140D, BAR100, BAR106, BAR200, BAR206, FC26, RST127, RST128, RST227, RST228		

			
1			
<b>GEV No.</b>	112778	<b>Ref. No.</b>	A14111
<b>description</b>	knob zero mark ø 40mm shaft ø 6x4.6mm shaft flat lower black		

			
1			
<b>GEV No.</b>	112657	<b>Ref. No.</b>	A14109
<b>description</b>	knob zero mark ø 55mm shaft ø 6x4.6mm shaft flat left black		

			
1			
<b>GEV No.</b>	112656	<b>Ref. No.</b>	A14108
<b>description</b>	knob zero mark ø 55mm shaft ø 6x4.6mm shaft flat right black		

			
1			
<b>GEV No.</b>	112658	<b>Ref. No.</b>	A14110
<b>description</b>	knob zero mark ø 55mm shaft ø 6x4.6mm shaft flat upper black		

## handles and hand wheels

### cone handles

			
1			
<b>GEV No.</b>	694952	<b>Ref. No.</b>	A17012
<b>description</b>	cone handle thread M10x1.5 ø 32mm plastic L 105mm		

			
1			
<b>GEV No.</b>	693036	<b>Ref. No.</b>	A15033
<b>description</b>	cone handle thread M8 ø 28mm plastic L 105mm black thread L 11mm		
<b>For models:</b>	BAR106, BAR206, PZ400		

			
1			
<b>GEV No.</b>	693162	<b>Ref. No.</b>	A15008 A15035
<b>description</b>	handle		

			
1			
<b>GEV No.</b>	110920	<b>Ref. No.</b>	A17001 A17003
<b>description</b>	cone handle thread M5 ø 25mm L 26mm plastic black		



ball handles



1

<b>GEV No.</b>	540321	<b>Ref. No.</b>	A17008
<b>description</b>	ball handle thread M6 ø 25mm with metal bush		

bracket handles



1

<b>GEV No.</b>	700551	<b>Ref. No.</b>	A15018
<b>description</b>	pull handle L 200mm H 62mm mounting distance 179mm handle M8		

lever handles



1

<b>GEV No.</b>	693035	<b>Ref. No.</b>	F01025
<b>description</b>	lever handle plastic		

folding grill handles



1

<b>GEV No.</b>	693161	<b>Ref. No.</b>	A15036
<b>description</b>	handle rod		
<b>For models:</b>	DOUBLE PANINI, GED10, GED20, GED30, GED40, GES10, GES20, GES30, GES40, MAJESTIC, PANINI, SAVOYE		

door handles

door handles



1

<b>GEV No.</b>	693079	<b>Ref. No.</b>	A15020/2
<b>description</b>	door handle for chicken rotisserie black		

miscellaneous



1

<b>GEV No.</b>	691960	<b>Ref. No.</b>	A15015
<b>description</b>	handle L 100mm W 32mm hole distance 70mm for lid		
<b>For models:</b>	FD120R		



1

<b>GEV No.</b>	110921	<b>Ref. No.</b>	A15001 A15016
<b>description</b>	handle L 130mm W 39mm hole distance 91mm Qty 1 pcs		

hinges

oven hinges



1

<b>GEV No.</b>	693044	<b>Ref. No.</b>	B09005
<b>description</b>	oven hinge		

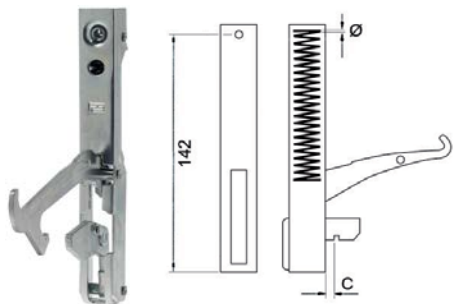

1

<b>GEV No.</b>	700459	<b>Ref. No.</b>	B09005	
<b>description</b>	oven hinge mounting distance 142mm mounting distance 2mm lug mountingmm lever length 117mm groove distance 7mm spring thickness 3.5mm mounting ear position spring length 58mm L 156mm W 22mm			
<b>For models:</b>	FC110, FC110G, FC60, FC60G			
<b>accessories for</b>	700459			
	<b>GEV No.</b>	693045	<b>Ref. No.</b>	—
	opposite support L 110mm W 12mm mounting distance 94mm			

door bearing



1

<b>GEV No.</b>	693023	<b>Ref. No.</b>	H04096
<b>description</b>	hinge bearing without bolt		



1

<b>GEV No.</b>	692235	<b>Ref. No.</b>	A13012
<b>description</b>	equipment foot thread M10 thread L 20mm ø 26mm H 6mm Qty 1 pcs		
<b>For models:</b>	FC60		

fittings for catering equipment

outlet taps

universal

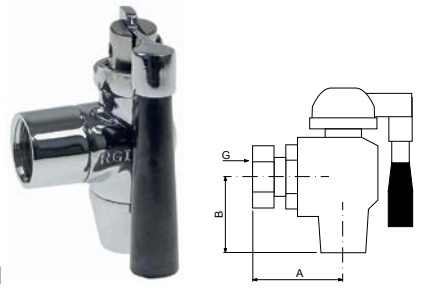

1

<b>GEV No.</b>	514170	<b>Ref. No.</b>	B10012 B10014
<b>description</b>	outlet tap W 35mm H 40mm thread 1/2" IT		
<b>For models:</b>	FD120R		



1

<b>GEV No.</b>	701036	<b>Ref. No.</b>	A13006
<b>description</b>	equipment foot thread M10 thread L 40mm ø 40mm H 52mm Qty 1 pcs		



1

<b>GEV No.</b>	691828	<b>Ref. No.</b>	A13009 A13009+105005
<b>description</b>	equipment foot thread M8 thread L 20mm ø 25mm H 29mm with nut plastic WS 26 Qty 1 pcs		
<b>For models:</b>	FC26, FC33, FC34, PZ330, PZ660, RELAIS		

equipment feet and end caps

equipment feet

with fixing plate



1

<b>GEV No.</b>	701003	<b>Ref. No.</b>	A13008
<b>description</b>	equipment foot tube ømm plate size 95x95mm hole distance 70x70mm H 155-210mm plastic size Qty 1 pcs		

bolting feet



1

<b>GEV No.</b>	691814	<b>Ref. No.</b>	A13003
<b>description</b>	equipment foot ø 22mm H 20mm bore ø 4mm Qty 1 pcs		

screw-in feet



1

<b>GEV No.</b>	701008	<b>Ref. No.</b>	A13005
<b>description</b>	equipment foot thread M10 thread L 14mm H 102-140mm WS 44 Qty 1 pcs D1 ø 24mm D2 ø 36mm for chicken rotisserie		





baskets

fryer baskets

ROLLER GRILL



<b>GEV No.</b>	693017	<b>Ref. No.</b>	F04006 F04038
<b>description</b>	fryer basket L1 250mm W1 225mm H1 105mm		



<b>GEV No.</b>	693025	<b>Ref. No.</b>	F04008 F04039
<b>description</b>	fryer basket L1 250mm W1 285mm H1 115mm		



<b>GEV No.</b>	693029	<b>Ref. No.</b>	F04002 F04030
<b>description</b>	fryer basket L1 260mm W1 125mm H1 100mm hinged handle		



<b>GEV No.</b>	693026	<b>Ref. No.</b>	F04004 F04030
<b>description</b>	fryer basket L1 260mm W1 140mm H1 100mm		



<b>GEV No.</b>	693028	<b>Ref. No.</b>	F04010 F04017
<b>description</b>	fryer basket L1 310mm W1 145mm H1 140mm		



<b>GEV No.</b>	693027	<b>Ref. No.</b>	F04009
<b>description</b>	fryer basket L1 320mm W1 280mm H1 150mm L2 560mm H2 280mm H3 190mm		



<b>GEV No.</b>	694711	<b>Ref. No.</b>	F04046
<b>description</b>	fryer basket W1 130mm L1 321mm H1 145mm		



<b>GEV No.</b>	692156	<b>Ref. No.</b>	F04010
<b>description</b>	fryer basket W1 145mm L1 310mm H1 140mm		

wire baskets for hot dog machines



1

<b>GEV No.</b>	693004	<b>Ref. No.</b>	F04012
<b>description</b>	grid basket for hot dog grill ø 180mm H 210mm		

miscellaneous



1

<b>GEV No.</b>	691216	<b>Ref. No.</b>	F04013
<b>description</b>	egg basket ø 54mm L 160mm W 54mm H 35mm set 4-piece for egg cooker stainless steel		

shelves and shelf rails

grates

universal

without upstand



1

<b>GEV No.</b>	970740	<b>Ref. No.</b>	F01002
<b>description</b>	grate W 315mm D 315mm H 9mm chrome-plated steel for heated cabinet wire gauge frame 6mm lengthwise wires gauge 3.5mm suitable for relays ROLLER GRILL		
<b>For models:</b>	RELAIS		



1

<b>GEV No.</b>	970747	<b>Ref. No.</b>	F01070
<b>description</b>	grate W 350mm D 240mm H 7mm SS for toaster wire gauge frame 4mm lengthwise wires gauge 3mm crossing wires ROLLER GRILL		

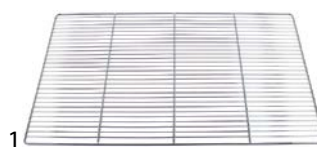

1

<b>GEV No.</b>	970895	<b>Ref. No.</b>	F01021
<b>description</b>	grate W 400mm D 600mm H 5mm chrome-plated steel wire gauge frame 5mm lengthwise wires gauge 2mm crossing wires 3		

producer-specific

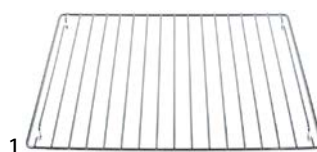

1

<b>GEV No.</b>	970894	<b>Ref. No.</b>	F01035
<b>description</b>	grate W 340mm D 455mm H 20mm chrome-plated steel wire gauge frame 5mm lengthwise wires gauge 3mm		
<b>For models:</b>	FC60		



1

<b>GEV No.</b>	970893	<b>Ref. No.</b>	F01031
<b>description</b>	grate W 400mm D 290mm H 20mm chrome-plated steel wire gauge frame 4.5mm lengthwise wires gauge 3mm		



accessories



1			
<b>GEV No.</b>	691917	<b>Ref. No.</b>	F03006
<b>description</b>	grid handle L 204mm W 80mm		

**gaskets**

refrigeration gaskets

screw-in gaskets

profile 9954

We offer custom-made gaskets for this profile

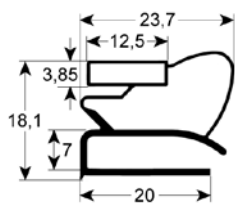

1			
<b>GEV No.</b>	902109	<b>Ref. No.</b>	SH03026
<b>description</b>	refrigeration gasket profile 9954 W 450mm L 1210mm external size		

**gaskets for heated units**

door seals with fixing hook



1			
<b>GEV No.</b>	900242	<b>Ref. No.</b>	H03001
<b>description</b>	door seal		
<b>For models:</b>	FC34, TH1		



1			
<b>GEV No.</b>	900240	<b>Ref. No.</b>	H03002
<b>description</b>	door seal W 310mm H 170mm		
<b>For models:</b>	FC26		



1			
<b>GEV No.</b>	900241	<b>Ref. No.</b>	H03010
<b>description</b>	oven gasket L 235mm W 370mm external size		
<b>For models:</b>	CN, FC33		



1			
<b>GEV No.</b>	900244	<b>Ref. No.</b>	H03006
<b>description</b>	oven gasket L 340mm W 640mm external size		
<b>For models:</b>	FC110, FC110G		

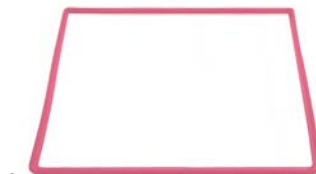

1			
<b>GEV No.</b>	900243	<b>Ref. No.</b>	H03005
<b>description</b>	oven gasket L 350mm W 450mm external size		
<b>For models:</b>	FC60, FC60G		

**evaporators**

for fridges

producer-specific



1			
<b>GEV No.</b>	750623	<b>Ref. No.</b>	SA03083
<b>description</b>	evaporator total length 508mm overall width 106mm overall height 178mm for display refrigerator suitable for ROLLER GRILL		

## transmission technology and ball bearings

### ball bearings

#### deep-groove ball bearings 2Z



1	<b>GEV No.</b>	698613	<b>Ref. No.</b>	B06010
	<b>description</b>	deep-groove ball bearing shaft ø 17mm ED ø 40mm W 12mm type 6203-2Z DIN 625-1		

#### deep-groove ball bearings Z



1	<b>GEV No.</b>	697842	<b>Ref. No.</b>	B06010
	<b>description</b>	deep-groove ball bearing type 6203-Z shaft ø 17mm ED ø 40mm W 12mm DIN 625-1		

### chains

#### roller chains 06B-1 single



1	<b>GEV No.</b>	693030	<b>Ref. No.</b>	B07013
	<b>description</b>	roller chain DIN/ISO 06 B-1 splitting 3/8" / 9.525mm links 53 internal width 5.72mm rolloø 6.35mm single with connector		

### springs

#### torsion springs



1	<b>GEV No.</b>	693019	<b>Ref. No.</b>	B07015
	<b>description</b>	torsion spring ø 20.8mm L1 48mm L2 124mm L3 48mm wire gauge ø 3.7mm		
	<b>For models:</b>	DOUBLE PANINI, MAJESTIC, PANINI, SAVOYE		

1	<b>GEV No.</b>	700822	<b>Ref. No.</b>	B07019 B07029
	<b>description</b>	torsion spring ø 20mm L1 69mm L2 119mm L3 69mm wire gauge ø 3.6mm		

### tension springs



1	<b>GEV No.</b>	693024	<b>Ref. No.</b>	B07002
	<b>description</b>	tension spring ø 8mm total length 130mm wire gauge ø 1mm		
	<b>For models:</b>	CN, FC26, FC33, FC34, TH1		

### hoses

#### drain hoses



1	<b>GEV No.</b>	698962	<b>Ref. No.</b>	SH03018
	<b>description</b>	drain hose L 1550mm ED ø 25mm ID ø 23mm		

#### industrial hoses

##### PE hoses

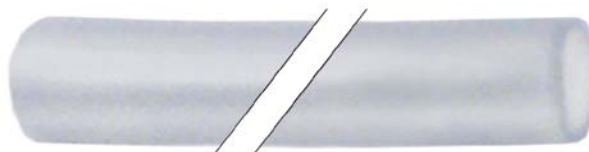

1	<b>GEV No.</b>	520549 <sup>1</sup>	<b>Ref. No.</b>	SH03012
	<b>description</b>	hose Lm operating p. 6bar burst p. 10bar t.max. 65°C LLDPE transparent ID ø 6mm ED ø 8mm John Guest supplied by meter		

<sup>1</sup>by the meter



## fittings, hose and pipe connectors

### push-in fittings

#### JOHN GUEST



1

<b>GEV No.</b>	440561	<b>Ref. No.</b>	SB10015
<b>description</b>	push-in fitting John Guest straight thread 1/8" BSP pipe connection ø8mm		
<b>accessories for</b>	440561		
	<b>GEV No.</b>	520972	<b>Ref. No.</b>
	hose John Guest thickness 1mm LLDPE blue ID ø 6mm ED ø 8mm		



1

<b>GEV No.</b>	520550	<b>Ref. No.</b>	SB10017
<b>description</b>	push-in fitting John Guest T-piece thread 1/8" BSP pipe connection ø8mm - ø8mm SK approved		

## valves and tank inlets

### ball valves

#### universal

#### ball valves with lever handle



1

<b>GEV No.</b>	693046	<b>Ref. No.</b>	B10001
<b>description</b>	ball valve connection 3/8" IT - 3/8" IT DN10 total length 41mm with lever handle		

## water filters

### miscellaneous

#### filters



1

<b>GEV No.</b>	530269	<b>Ref. No.</b>	SB10019
<b>description</b>	water filter AQUA CURE type H60FB capacity/ flow rate 4l/min operation p max 8.5bar water temperature max. 38°C ø 50mm H 155mm for water dispenser		

## drain systems and wash basins

### accessories



1

<b>GEV No.</b>	691916	<b>Ref. No.</b>	B04009
<b>description</b>	drain pipe L 60x30mm ø 12mm brass		

## measuring equipment

### thermometers

#### built-in thermometers



1

<b>GEV No.</b>	541085	<b>Ref. No.</b>	A18007
<b>description</b>	thermometer mounting measurements 58x25.5mm +50 up to +350°C capillary pipe 1000mm probe ø 6.5mm probe L 13mm		



1

<b>GEV No.</b>	541063	<b>Ref. No.</b>	A18010
<b>description</b>	thermometer mounting measurements 58x25.5mm 0 up to +120°C capillary pipe 1500mm probe ø 6.5mm probe L 23mm		

## fastening material

## nuts

## hexagonal nuts

## hexagonal nuts inch thread



1

<b>GEV No.</b>	520500	<b>Ref. No.</b>	E02144
<b>description</b>	hexagonal nut thread 3/8" H 4mm WS 23 nickel-plated brass Qty 1 pcs		



1

<b>GEV No.</b>	511182	<b>Ref. No.</b>	E02057
<b>description</b>	nut thread 3/8" H 8mm brass WS 24 Qty 1 pcs		

## consumables

## containers

## bottles



1

<b>GEV No.</b>	960034	<b>Ref. No.</b>	F07034
<b>description</b>	bottle 0.5l ø 75mm H 200mm plastic		



1

<b>GEV No.</b>	960035	<b>Ref. No.</b>	F07026
<b>description</b>	bottle 1l ø 85mm H 250mm plastic		

## lava rocks / ceramic briquetts



1

<b>GEV No.</b>	693326	<b>Ref. No.</b>	F07001
<b>description</b>	lava rocks size ca.20mm Qty 1.5kg		

<b>A</b>			
audible timers	25	heating elements for fryers	4
axial fans	28	heating elements for griddles	5
<b>B</b>		heating elements for gyros grills	6
ball valves	61	heating elements for heated cabinets	10
bar burners	39	heating elements for ovens	3
bi-metal thermostats	15, 15	heating elements for pasta cookers	9
<b>C</b>		heating elements for pizza ovens	9
cable glands	33, 33	heating elements for rechauds	9
cables	32	heating elements for salamanders/toasters	10
cam switches	20	hexagonal nuts	62
ceramic burners	39	hob burners	39
compressors	28	hoses	60
consumables	62	hot air fans	29
contactors	25	hot air motors	29
containers	62	hot plates	14
control thermostats	15, 16	<b>I</b>	
<b>D</b>		indicator lights	22
door seals with fixing hook	59	indicator lights (complete)	22
drain hoses	60	industrial hoses	60
drain systems and wash basins	61	infrared lamps	23
<b>E</b>		insulated hoses	32
electric accessories	32	<b>L</b>	
electronic controllers	26	lamps	22
energy regulators	14	lava rocks / ceramic briquettes	42, 62
evaporators	59	LED	22
<b>F</b>		linear lamps	22
fans	28	<b>M</b>	
fastening material	62	measuring equipment	61
fluorescent lamps	23, 23	mechanical timers	24
fuses	32	microswitches	19
<b>G</b>		miscellaneous	32
gas burners	39	motors	31
gas hoses	42	<b>N</b>	
gas nozzles	41	nuts	62
gas taps	34	<b>O</b>	
gas thermostats	36	oven hinges	55
gaskets for heated units	59	oven lamps	23
grates	58	<b>P</b>	
<b>H</b>		PE hoses	60
heaters	10	piezoelectric igniters	37
heating elements	3	pilot burners	36
heating elements for bain maries	3	power supply cables	32
heating elements for contact grills	7	protection hoses	32
heating elements for convection	13	push/momentary push switches	19
		push-in fittings	61

**Q**

quartz heating elements 10

**R**

radiation heaters 14

refrigeration fans 28

refrigeration gaskets 59

refrigeration motors universal 28

refrigeration thermostats 18

rocker/momentary rocker switches 18

**S**

safety thermostats 16

screw-in gaskets 59

shelves and shelf rails 58

solenoid valves 27

solid state relays 26

star burners 40

switches and momentary switches 18

**T**

terminals 33

thermocouples 38

thermostats 15

threaded cable glands 33

timers 24

**V**

valves and tank inlets 61

**W**

water filters 61