



**GAS COMPONENTS**



**ELECTRIC COMPONENTS**



**WATER TECHNOLOGY**



**MECHANICAL COMPONENTS**



**TOOLS**

Spare parts suitable for

**ROSINOX**

Find the complete and up-to-date range of products in our GEV Webshop



# Manufacturer catalogue

The most important spare parts and accessories arranged clearly for every manufacturer

- ✓ Complete product range and all appliance data always up to date in the GEV Webshop
- ✓ Alphabetical Index at the end of the catalogue

## GEV Webshop

[www.gev-online.co.uk](http://www.gev-online.co.uk)

[www.gev-online.com](http://www.gev-online.com)



- 🔍 Add to Favourites
- 🔍 Sign In with email address and usual password
- 🔍 Easy-order – place several items in your basket at the same time
- 🔍 Quick Item search – no login needed



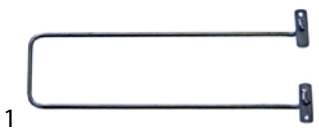

## heating elements

### heating elements for ovens

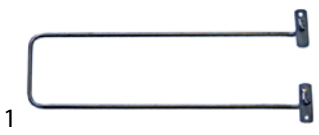
			
1			
<b>GEV No.</b>	415341	<b>Ref. No.</b>	94805777 RX94805777
<b>description</b>	heating element 735W 230V L 387mm W 108mm H 25mm lug length 55mm lug width 29mm hole distance 140mm hole ø 5mm tube ø 6.3mm connection length 30mm connection M4 heating circuits 1 dry heating element bracket mounting		









			
1			
<b>GEV No.</b>	415294	<b>Ref. No.</b>	94806460 RX94806460
<b>description</b>	heating element 900W 230V L 468mm W 112mm H 23mm lug length 60mm lug width 20mm hole distance 153mm hole ø 6mm tube ø 6.3mm heating circuits 1 dry heating element windings 1 rectangular flange oven		

### heating elements for bain maries

			
1			
<b>GEV No.</b>	415091	<b>Ref. No.</b>	94812669 RX94812669
<b>description</b>	heating element 1000W 230V heating circuits 1 L 295mm W 85mm connection length 20mm connection M3 tube ø 6.5mm 2 hole fixing thread M14x1 immersion heater/dry heating element bain marie/ chip scuttle L1 145mm L2 150mm H 18mm mounting distance 79mm		
<b>spare parts for</b>	415091		
	<b>GEV No.</b>	510417	<b>Ref. No.</b> —
	flat gasket fibre ED ø 20mm ID ø 14mm thickness 2mm Qty 1 pcs		
<b>accessories for</b>	415091		
	<b>GEV No.</b>	520228	<b>Ref. No.</b> —
	tooth lock washer ID ø 15.3mm ED ø 24mm steel Qty 1 pcs for thread M14		
	<b>GEV No.</b>	521133	<b>Ref. No.</b> —
	nut thread M14x1.5 H 6mm WS 19 zinc-coated steel Qty 1 pcs		
	<b>GEV No.</b>	527169	<b>Ref. No.</b> —
	hexagonal nut thread M3 H 2.8mm WS 5.5 brass Qty 1 pcs		
	<b>GEV No.</b>	550261	<b>Ref. No.</b> —
	nut thread M14x1 H 4mm WS 19 SS Qty 1 pcs		
	<b>GEV No.</b>	550262	<b>Ref. No.</b> —
	flat gasket copper ED ø 20mm ID ø 14mm thickness 2mm		
	<b>GEV No.</b>	560110	<b>Ref. No.</b> —
	plain washer ID ø 3.2mm ED ø 7mm thickness 0.5mm SS Qty 20 pcs DIN 125A for thread M3		
	<b>GEV No.</b>	560130	<b>Ref. No.</b> —
	hexagonal nut thread M3 H 2.4mm WS 5.5 SS DIN/ISO DIN 934 / ISO 4032/8673 Qty 20 pcs		

### heating elements for chip scuttles

			
1			
<b>GEV No.</b>	416832	<b>Ref. No.</b>	RX94812603
<b>description</b>	heating element 650W 230V heating circuits 1 L 276mm W 73mm flange length 115mm flange width 25mm hole distance 98mm connection length 24mm connection male faston 6.3mm tube ø 8.5mm rectangular flange hole ø 5mm dry heating element		

			
1			
<b>GEV No.</b>	415091	<b>Ref. No.</b>	94812669 RX94812669
<b>description</b>	heating element 1000W 230V heating circuits 1 L 295mm W 85mm connection length 20mm connection M3 tube ø 6.5mm 2 hole fixing thread M14x1 immersion heater/dry heating element bain marie/ chip scuttle L1 145mm L2 150mm H 18mm mounting distance 79mm		
<b>spare parts for</b>	415091		
	<b>GEV No.</b>	510417	<b>Ref. No.</b> —
	flat gasket fibre ED ø 20mm ID ø 14mm thickness 2mm Qty 1 pcs		
<b>accessories for</b>	415091		
	<b>GEV No.</b>	520228	<b>Ref. No.</b> —
	tooth lock washer ID ø 15.3mm ED ø 24mm steel Qty 1 pcs for thread M14		
	<b>GEV No.</b>	521133	<b>Ref. No.</b> —
	nut thread M14x1.5 H 6mm WS 19 zinc-coated steel Qty 1 pcs		
	<b>GEV No.</b>	527169	<b>Ref. No.</b> —
	hexagonal nut thread M3 H 2.8mm WS 5.5 brass Qty 1 pcs		
	<b>GEV No.</b>	550261	<b>Ref. No.</b> —
	nut thread M14x1 H 4mm WS 19 SS Qty 1 pcs		
	<b>GEV No.</b>	550262	<b>Ref. No.</b> —
	flat gasket copper ED ø 20mm ID ø 14mm thickness 2mm		
	<b>GEV No.</b>	560110	<b>Ref. No.</b> —
	plain washer ID ø 3.2mm ED ø 7mm thickness 0.5mm SS Qty 20 pcs DIN 125A for thread M3		
	<b>GEV No.</b>	560130	<b>Ref. No.</b> —
	hexagonal nut thread M3 H 2.4mm WS 5.5 SS DIN/ISO DIN 934 / ISO 4032/8673 Qty 20 pcs		



## heating elements for fryers

## side connection

## with thread

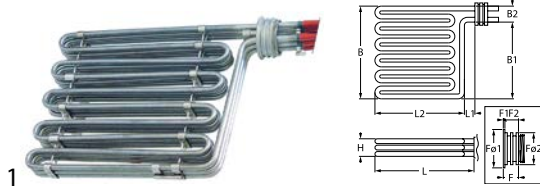

<b>GEV No.</b>	416813	<b>Ref. No.</b>	94812639 RX94812639
<b>description</b>	heating element 10500W 230/400V heating circuits 3 mounting pos. right L 320mm W 240mm H 32mm flange length 21mm flange length 1 2mm flange length 2 19mm flange ø1 63mm flange ø2 57.5mm sensor screw connection 2x M10x1 thermostat sleeve upper/lower L1 20mm L2 300mm W1 204mm W2 33mm thread M54x1.5 windings 5 tube ø 8.5mm cable length 460mm rotation flange fryer fryer connection length 90mm 2		
<b>accessories for</b>	416813		
	<b>GEV No.</b>	550449	<b>Ref. No.</b> —
	special wrench for ring nut		
	<b>GEV No.</b>	550496	<b>Ref. No.</b> RX94812518
	O-ring Viton thickness 3.53mm ID ø 50.39mm Qty 1 pcs		
	<b>GEV No.</b>	550662	<b>Ref. No.</b> 94805330 94812677 RX94805330 RX94812677
	ring nut thread M54x1.5 H 7mm		

## off-center connection

## with thread

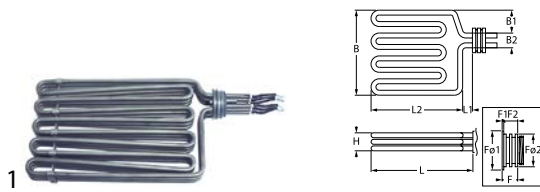

<b>GEV No.</b>	416070	<b>Ref. No.</b>	94805397 RX94805397
<b>description</b>	heating element 10200W 230/400V heating circuits 3 L 300mm W 180mm H 33mm flange length 19.5mm flange length 1 9.5mm flange length 2 9.8mm flange ø1 62mm flange ø2 57mm thermostat sleeves ø 6.5mm sensor screw connection 2x M10x1 thermostat sleeve upper/lower L1 18mm L2 282mm W1 30mm W2 35mm thread M54x1.5 windings 5 tube ø 8.5mm cable length 450mm rotation flange immersion heater fryer connection length 130mm 2		
<b>spare parts for</b>	416070		
	<b>GEV No.</b>	510243	<b>Ref. No.</b> —
	O-ring Viton thickness 3.53mm ID ø 55.56mm Qty 1 pcs		
	<b>GEV No.</b>	550496	<b>Ref. No.</b> RX94812518
	O-ring Viton thickness 3.53mm ID ø 50.39mm Qty 1 pcs		
<b>accessories for</b>	416070		
	<b>GEV No.</b>	510243	<b>Ref. No.</b> —
	O-ring Viton thickness 3.53mm ID ø 55.56mm Qty 1 pcs		

<b>accessories for</b>	416070		
	<b>GEV No.</b>	550662	<b>Ref. No.</b> 94805330 94812677 RX94805330 RX94812677
	ring nut thread M54x1.5 H 7mm		

## center connection



<b>GEV No.</b>	415297	<b>Ref. No.</b>	94806916 RX94806916
<b>description</b>	heating element 6800W 230/400V heating circuits 3 L 299mm W 107mm H 35mm flange length 19.5mm flange length 1 9.5mm flange length 2 9.8mm flange ø1 62mm flange ø2 57mm thermostat sleeves ø 8.5mm sensor screw connection 2x M10x1 thermostat sleeve upper/lower L1 16mm L2 283mm W1 30mm W2 77mm thread M54x1.5 tube ø 8.5mm cable length 450mm rotation flange immersion heater		
<b>accessories for</b>	415297		
	<b>GEV No.</b>	510243	<b>Ref. No.</b> —
	O-ring Viton thickness 3.53mm ID ø 55.56mm Qty 1 pcs		
	<b>GEV No.</b>	510245	<b>Ref. No.</b> —
	O-ring Viton thickness 3.53mm ID ø 50.8mm Qty 1 pcs		
	<b>GEV No.</b>	550447	<b>Ref. No.</b> —
	ring nut thread M54x1.5		

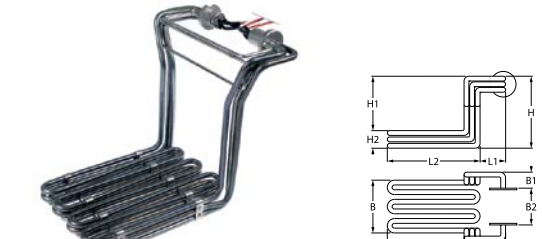

<b>GEV No.</b>	415257	<b>Ref. No.</b>	94812636 RX94812636
<b>description</b>	heating element 6000W 230/400V heating circuits 3 L 300mm W 182mm H 252mm L1 65mm L2 235mm W1 59mm W2 134mm W3 250mm H1 220mm H2 32mm windings 12 flange ø 40mm rotation flange cable length 380mm fryer heaters mounting ø 25mm		

## heating elements for griddles



<b>GEV No.</b>	420406	<b>Ref. No.</b>	RX94035706
<b>description</b>	heating element 1000W 230-240V heating circuits 1 L 69mm W 268mm H 85mm		





			
<b>GEV No.</b>	415651	<b>Ref. No.</b>	RX94805678
<b>description</b>	heating element 1500W 230V heating circuits 1 L 425mm W 72mm H 53mm tube ø 8.5mm L1 22mm connection male faston 6.3mm connection distance 52mm dry heating element		

			
<b>GEV No.</b>	415296	<b>Ref. No.</b>	RX94814020
<b>description</b>	heating element 1580W 230V heating circuits 1 L 460mm W 65mm H 71mm tube ø 8.5mm L1 20mm L2 440mm connection male faston 6.3mm griddle connection distance 57mm dry heating element		

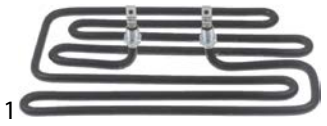
			
<b>GEV No.</b>	419124	<b>Ref. No.</b>	94001872 RX94001872
<b>description</b>	heating element 2000W 230V heating circuits 1 L 270mm W 150mm H 40mm tube ø 8.5mm connection M4 thread M12x1 mounting distance 70mm connection length 35mm		

			
<b>GEV No.</b>	419125	<b>Ref. No.</b>	9400180 94001807 RX94001807
<b>description</b>	heating element 2000W 230V heating circuits 1 L 270mm W 190mm H 40mm tube ø 8.5mm thread M12x1 mounting distance 68mm connection length 35mm		

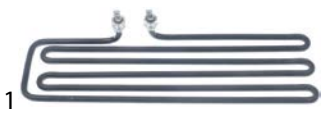
			
<b>GEV No.</b>	420246	<b>Ref. No.</b>	9400193 94001930 RX94001930
<b>description</b>	heating element 2400W 230V heating circuits 1 L 425mm W 115mm H 40mm tube ø 10mm 2 hole fixing connection M4 thread 1/4" mounting distance 46mm dry heating element		

**heating elements for tilting bratt pan**

			
<b>GEV No.</b>	415250	<b>Ref. No.</b>	94800224 RX94800224
<b>description</b>	heating element gril 1650W 230V L 490mm W 42mm H 45mm connection M4 dry heating element heating circuits 1 tube ø 8.5mm 2 hole fixing thread 1/4" mounting distance 37mm		

			
<b>GEV No.</b>	415298	<b>Ref. No.</b>	94806718 RX94806718
<b>description</b>	heating element tilting bratt pan 3400W 230V L 315mm W 195mm H 85mm connection M5 dry heating element heating circuits 1 tube ø 10mm W1 68mm W2 58mm		

**heating elements for pasta cookers**











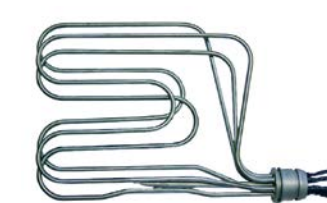

			
<b>GEV No.</b>	415977	<b>Ref. No.</b>	94812607 RX94812607
<b>description</b>	heating element 5670W 230V heating circuits 3 L 292mm W 225mm H 26mm rotation flange tube ø 6.3mm thermostat sleeves ø 9mm length thermostat sleeves 185mm L1 42mm L2 250mm W1 197mm W2 28mm cable length 460mm number of thermostat sleeves 1 connection length 50mm flange length 1 9mm flange length 2 15.5mm flange length 24.5mm flange ø1 43.8mm flange ø2 39.7mm thermostat sleeve centred, adjacent pasta cooker sensor screw connection M10x1		
<b>accessories for</b>	415977		
	<b>GEV No.</b>	514016	<b>Ref. No.</b> —
	flat gasket PTFE ED ø 45mm ID ø 40mm thickness 4mm Qty 1 pcs equiv. no. 1036500400/1814500 suitable for MARENO		
	<b>GEV No.</b>	514017	<b>Ref. No.</b> 94803079 94803616 94812605 RX94803079 RX94803616 RX94812605
	O-ring silicone thickness 3.53mm ID ø 32.93mm Qty 1 pcs		
	<b>GEV No.</b>	514018	<b>Ref. No.</b> 94812604 RX94812604
	bush		
	<b>GEV No.</b>	514020	<b>Ref. No.</b> —
	bush		
	<b>GEV No.</b>	514021	<b>Ref. No.</b> —
	O-ring silicone thickness 3.53mm ID ø 49.21mm Qty 1 pcs		
	<b>GEV No.</b>	514022	<b>Ref. No.</b> —
	nut thread 1½" H 12mm SS WS 59 Qty 1 pcs		
	<b>GEV No.</b>	540435	<b>Ref. No.</b> —
	threaded rod thread M10 hollow		
	<b>GEV No.</b>	540436	<b>Ref. No.</b> —
	hexagonal nut thread M10x1.25 H 4mm WS 13 brass Qty 1 pcs		

Table continues overleaf





<b>accessories for</b>	415977		
	GEV No.	540438	Ref. No. —
	long nut thread M10 L 25mm WS 13 brass Qty 1 pcs		
	GEV No.	540439	Ref. No. —
	distance washer		

## heating elements for chargrills

	1		
GEV No.	415250	Ref. No.	94800224 RX94800224
<b>description</b>	heating element grill 1650W 230V L 490mm W 42mm H 45mm connection M4 dry heating element heating circuits 1 tube ø 8.5mm 2 hole fixing thread 1/4" mounting distance 37mm		

## heating elements for plate warmers



	1		
GEV No.	416827	Ref. No.	94805223 RX94805223
<b>description</b>	heating element 1100W 240V 2 hole fixing thread M10x1 L 375mm W 90mm heating circuits 1 connection plug-in connection 4mm L1 25mm L2 25mm L3 325mm dry heating element tube ø 6.3mm W1 23mm W2 44mm mounting distance 38mm for heated cabinet		
<b>accessories for</b>	416827		
	GEV No.	101860	Ref. No. —
	nut thread M10x1 H 4mm WS 14 chrome-plated brass Qty 1 pcs		

## ceramic heaters

245x60mm

	1		
GEV No.	415103	Ref. No.	94805876 RX94805876
<b>description</b>	ceramic emitter 650W 230V cable beaded cord L 245mm W 60mm H 35mm		
<b>spare parts for</b>	415103		
	GEV No.	415109	Ref. No. —
	spring clip		
<b>accessories for</b>	415103		
	GEV No.	415110	Ref. No. —
	reflector L 245mm W 95mm H 31mm thickness 0.75mm hole ø 15x40mm		

## quartz heating elements

	1		
GEV No.	421000	Ref. No.	RX94933597
<b>description</b>	quartz heating element 650W 230/240V L 542mm W 121mm H 30mm threaded connection screw clamp heating circuits 1		
<b>spare parts for</b>	421000		
	GEV No.	415103	Ref. No. 94805876 RX94805876
	ceramic emitter 650W 230V cable beaded cord L 245mm W 60mm H 35mm		

## coil heating elements

	1		
GEV No.	419039	Ref. No.	94808623 RX94808623
<b>description</b>	heating element 2000/2180W 230/240V L 395mm W 93mm thread 3/8" connection M6 connection length 45mm dishwasher dry heating element heating circuits 1 2 hole fixing		

	1		
GEV No.	420330	Ref. No.	RX94803905
<b>description</b>	heating element 2000W 240V L 454mm W 210mm ø 27.5mm thread M14x1 connection M4 for drying warewashing heating circuits 1 2 hole fixing		

	1		
GEV No.	417640	Ref. No.	94803913 RX94803913
<b>description</b>	heating element 3000W 230V L 455mm W 212mm ø 28mm thread M15x1 heating circuits 1 screw		



**immersion heating elements**

**3 hole flange ø38.5mm**

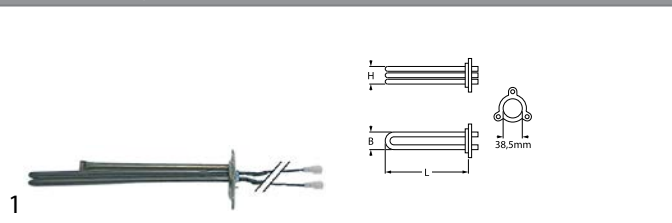

<b>GEV No.</b>	415261	<b>Ref. No.</b>	94808169 RX94808169
<b>description</b>	heating element 2400W 230V mounting ø 38.5mm heating circuits 1 L 242mm W 31mm H 22mm number of thermostat sleeves 1 thermostat sleeves ø 7.5mm length thermostat sleeves 180mm thermostat sleeve eccentric, non clinging tube ø 6.3mm hole distance 57mm hole ø 10mm cable length 130mm 3 hole flange connection male faston 6.3mm immersion heater		
<b>spare parts for</b>	415261		
	GEV No.	521120	Ref. No. —
	O-ring EPDM thickness 5.34mm ID ø 37.47mm Qty 1 pcs		
<b>accessories for</b>	415261		
	GEV No.	532577	Ref. No. —
	O-ring EPDM thickness 5.34mm ID ø 40.65mm Qty 1 pcs		

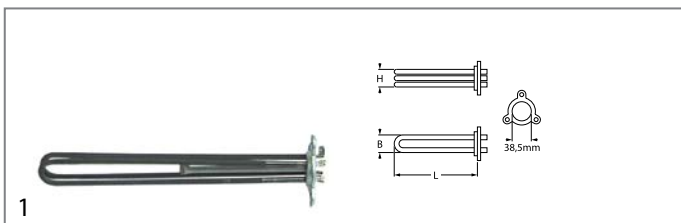

<b>GEV No.</b>	415167	<b>Ref. No.</b>	94801222 RX94801222
<b>description</b>	heating element 3000W 230V mounting ø 38.5mm heating circuits 2 L 300mm W 21mm H 35mm number of thermostat sleeves 1 thermostat sleeves ø 6.5mm length thermostat sleeves 53mm thermostat sleeve not clinging tube ø 6.3mm hole distance 57mm hole ø 10mm 3 hole flange connection male faston 6.3mm immersion heater		
<b>spare parts for</b>	415167		
	GEV No.	521120	Ref. No. —
	O-ring EPDM thickness 5.34mm ID ø 37.47mm Qty 1 pcs		
<b>accessories for</b>	415167		
	GEV No.	532577	Ref. No. —
	O-ring EPDM thickness 5.34mm ID ø 40.65mm Qty 1 pcs		

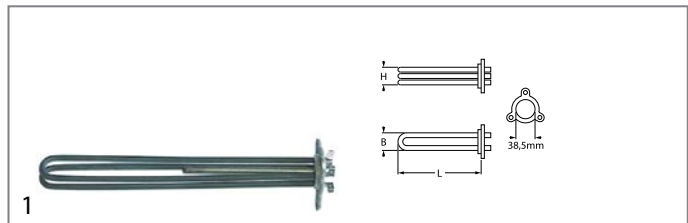

<b>GEV No.</b>	415278	<b>Ref. No.</b>	94801339 RX94801339
<b>description</b>	heating element 4000W 230V mounting ø 38.5mm heating circuits 2 L 290mm W 20mm H 34mm number of thermostat sleeves 1 thermostat sleeves ø 7mm length thermostat sleeves 148mm thermostat sleeve not clinging tube ø 6.3mm hole distance 57mm hole ø 10mm 3 hole flange connection male faston 6.3mm immersion heater		
<b>spare parts for</b>	415278		
	GEV No.	521120	Ref. No. —
	O-ring EPDM thickness 5.34mm ID ø 37.47mm Qty 1 pcs		
<b>accessories for</b>	415278		
	GEV No.	532577	Ref. No. —
	O-ring EPDM thickness 5.34mm ID ø 40.65mm Qty 1 pcs		

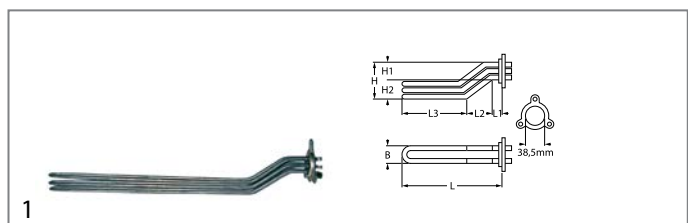

<b>GEV No.</b>	415277	<b>Ref. No.</b>	94802949 RX94802949
<b>description</b>	heating element 6000W 230V mounting ø 38.5mm heating circuits 3 L 360mm W 34mm H 55mm L1 35mm L2 70mm L3 255mm H1 27mm H2 28mm hole distance 57mm hole ø 10mm tube ø 6.3mm connection male faston 6.3mm immersion heater 3 hole flange		
<b>accessories for</b>	415277		
	GEV No.	532577	Ref. No. —
	O-ring EPDM thickness 5.34mm ID ø 40.65mm Qty 1 pcs		

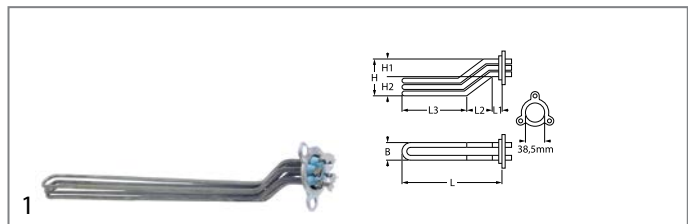

<b>GEV No.</b>	416269	<b>Ref. No.</b>	94800760 RX94800760
<b>description</b>	heating element 8000W 230V mounting ø 38.5mm heating circuits 3 L 545mm W 32mm H 60mm L1 38mm L2 55mm L3 447mm H1 27mm H2 33mm hole distance 57mm hole ø 10mm tube ø 6.3mm connection male faston 6.3mm immersion heater 3 hole flange		
<b>accessories for</b>	416269		
	GEV No.	532577	Ref. No. —
	O-ring EPDM thickness 5.34mm ID ø 40.65mm Qty 1 pcs		



## 3 hole flange ø47.5mm

<b>GEV No.</b>	416390	<b>Ref. No.</b>	94813775 RX94813775
<b>description</b>	heating element 3200W 230V mounting ø 47.5mm heating circuits 2 L 302mm W 37mm H 20mm tube ø 6.3mm hole distance 63mm hole ø 8/10mm connection length 10mm connection male faston 6.3mm 3 hole flange immersion heater		
<b>accessories for</b>	416390		
	<b>GEV No.</b>	510408	<b>Ref. No.</b> RX94807781
	O-ring EPDM thickness 5.34mm ID ø 47mm Qty 1 pcs		
	<b>GEV No.</b>	510562	<b>Ref. No.</b> —
	O-ring silicone thickness 5.34mm ID ø 47mm Qty 1 pcs		

<b>GEV No.</b>	415001	<b>Ref. No.</b>	94803475 RX94803475
<b>description</b>	heating element 4500W 230V mounting ø 47.5mm heating circuits 3 L 316mm W 35mm H 34mm number of thermostat sleeves 1 thermostat sleeves ø 7mm length thermostat sleeves 180mm thermostat sleeve eccentric, non clinging tube ø 6.3mm hole distance 62mm hole ø 8mm connection M4 3 hole flange immersion heater		
<b>spare parts for</b>	415001		
	<b>GEV No.</b>	510408	<b>Ref. No.</b> RX94807781
	O-ring EPDM thickness 5.34mm ID ø 47mm Qty 1 pcs		
<b>accessories for</b>	415001		
	<b>GEV No.</b>	510562	<b>Ref. No.</b> —
	O-ring silicone thickness 5.34mm ID ø 47mm Qty 1 pcs		
	<b>GEV No.</b>	521103	<b>Ref. No.</b> —
	nut thread M4 H 3mm WS 7 brass Qty 20 pcs		
	<b>GEV No.</b>	521104	<b>Ref. No.</b> —
	washer ID ø 4.3mm ED ø 8mm thickness 0.5mm brass Qty 20 pcs for thread M4		
	<b>GEV No.</b>	560111	<b>Ref. No.</b> —
	plain washer ID ø 4.3mm ED ø 9mm thickness 0.8mm SS Qty 20 pcs DIN 125A for thread M4		
	<b>GEV No.</b>	560131	<b>Ref. No.</b> —
	hexagonal nut thread M4 H 3.2mm WS 7 SS DIN/ISO DIN 934 / ISO 4032/8673 Qty 20 pcs		

## 3 hole flange ø57.5mm

<b>GEV No.</b>	418624	<b>Ref. No.</b>	94801602 RX94801602
<b>description</b>	heating element 10000W 230/400V mounting ø 57.5mm heating circuits 3 L 480mm W 35mm H 43mm number of thermostat sleeves 1 thermostat sleeves ø 7mm length thermostat sleeves 285mm tube ø 8.5mm hole distance 72mm hole ø 8mm immersion heater		
<b>spare parts for</b>	418624		
	<b>GEV No.</b>	510409	<b>Ref. No.</b> RX94807294
	O-ring EPDM thickness 5.34mm ID ø 56.52mm Qty 1 pcs		

<b>GEV No.</b>	419191	<b>Ref. No.</b>	RX94810124
<b>description</b>	heating element 3000-3270W 230-240V mounting ø 57.5mm heating circuits 3 L 195mm W 35mm H 40mm with O-ring		

<b>GEV No.</b>	415846	<b>Ref. No.</b>	94803574 RX94803574
<b>description</b>	heating element 4000W 230V mounting ø 57.5mm heating circuits 3 L 327mm W 36mm H 42mm number of thermostat sleeves 1 thermostat sleeves ø 7mm length thermostat sleeves 320mm thermostat sleeve eccentric, non clinging tube ø 6.3mm hole distance 72mm hole ø 8mm connection M4 3 hole flange immersion heater		

<b>GEV No.</b>	415021	<b>Ref. No.</b>	RX94813728
<b>description</b>	heating element 6000W 230V mounting ø 57.5mm heating circuits 3 L 343mm W 37mm H 50mm number of thermostat sleeves 1 thermostat sleeves ø 7mm length thermostat sleeves 294mm thermostat sleeve not clinging tube ø 8.5mm hole distance 72mm hole ø 8mm connection M5 3 hole flange		
<b>spare parts for</b>	415021		
	<b>GEV No.</b>	510409	<b>Ref. No.</b> RX94807294
	O-ring EPDM thickness 5.34mm ID ø 56.52mm Qty 1 pcs		

Table continues overleaf



<b>accessories for</b>	415021			
	GEV No.	550002	Ref. No.	—
	tension strap H 10mm L 21mm W 10mm hole ø 6.5mm for heating element			

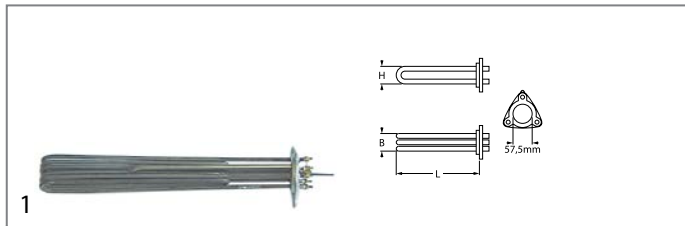

<b>GEV No.</b>	415039	<b>Ref. No.</b>	94803442 RX94803442
----------------	--------	-----------------	------------------------

**description** heating element 8000W 230V mounting ø 57.5mm heating circuits 3 L 375mm W 41mm H 42mm number of thermostat sleeves 1 thermostat sleeves ø 7mm length thermostat sleeves 230mm thermostat sleeve upper centre not clinging tube ø 6mm hole distance 73mm hole ø 10mm connection length 30mm connection M4 3 hole flange immersion heater

<b>spare parts for</b>	415039		
------------------------	--------	--	--

	GEV No.	510409	Ref. No.	RX94807294
	O-ring EPDM thickness 5.34mm ID ø 56.52mm Qty 1 pcs			

<b>accessories for</b>	415039		
------------------------	--------	--	--

	GEV No.	521103	Ref. No.	—
	nut thread M4 H 3mm WS 7 brass Qty 20 pcs			

	GEV No.	521104	Ref. No.	—
	washer ID ø 4.3mm ED ø 8mm thickness 0.5mm brass Qty 20 pcs for thread M4			

	GEV No.	560111	Ref. No.	—
	plain washer ID ø 4.3mm ED ø 9mm thickness 0.8mm SS Qty 20 pcs DIN 125A for thread M4			

	GEV No.	560131	Ref. No.	—
	hexagonal nut thread M4 H 3.2mm WS 7 SS DIN/ISO DIN 934 / ISO 4032/8673 Qty 20 pcs			

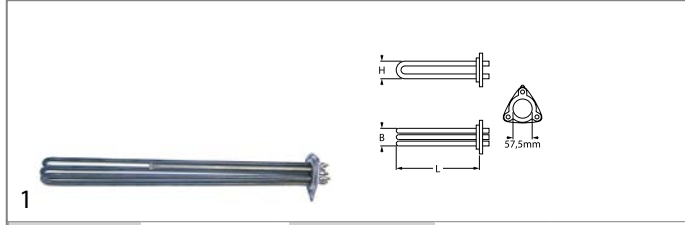

<b>GEV No.</b>	415022	<b>Ref. No.</b>	94814034 RX94814034
----------------	--------	-----------------	------------------------

**description** heating element 9000W 230/400V mounting ø 57.5mm heating circuits 3 L 475mm W 36mm H 43mm number of thermostat sleeves 1 thermostat sleeves ø 7mm length thermostat sleeves 300mm thermostat sleeve eccentric, non clinging tube ø 10mm hole distance 73mm hole ø 10mm connection length 30mm connection M5 3 hole flange immersion heater

<b>spare parts for</b>	415022		
------------------------	--------	--	--

	GEV No.	510409	Ref. No.	RX94807294
	O-ring EPDM thickness 5.34mm ID ø 56.52mm Qty 1 pcs			

**with compression flange 62 x 26mm**

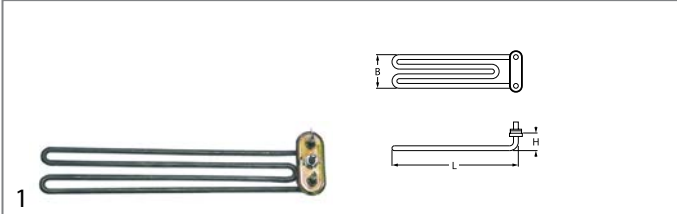

<b>GEV No.</b>	415268	<b>Ref. No.</b>	94808383 RX94808383
----------------	--------	-----------------	------------------------

**description** heating element 1850-2020W 230-240V heating circuits 1 expansion flange flange 62x26mm L 245mm W 40mm H 25mm tube ø 6.5mm connection male faston 6.3mm immersion heater

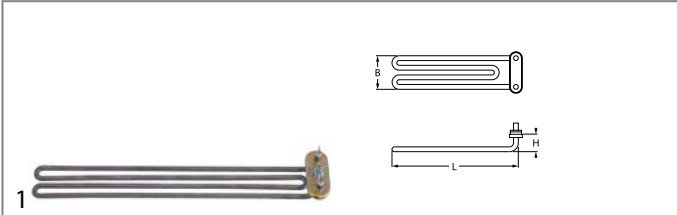

<b>GEV No.</b>	415270	<b>Ref. No.</b>	RX94808391
----------------	--------	-----------------	------------

**description** heating element 2700W 230V heating circuits 1 compression flange flange 62x26mm L 335mm W 43mm H 25mm tube ø 6.3mm connection male faston 6.3mm immersion heater

**with compression flange 70 x 26mm**

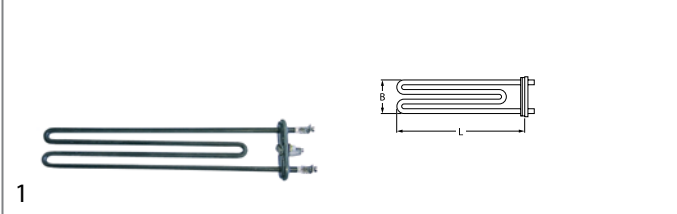

<b>GEV No.</b>	415000	<b>Ref. No.</b>	94803855 RX94803855
----------------	--------	-----------------	------------------------

**description** heating element 2900W 230V heating circuits 1 flange 70x26mm L 272mm W 51mm H tube ø 6.3mm connection M4 immersion heater compression flange

<b>spare parts for</b>	415000		
------------------------	--------	--	--

	GEV No.	521128	Ref. No.	94803665 RX94803665
	gasket L 66mm W 21mm ømm for heating element suitable for ELETTRORBAR, WOLK			



<b>accessories for</b>	415000		
------------------------	--------	--	--

	GEV No.	521128	Ref. No.	94803665 RX94803665
	gasket L 66mm W 21mm ømm for heating element suitable for ELETTRORBAR, WOLK			











## with expansion flange 70 x 18mm



			
1			
<b>GEV No.</b>	415465	<b>Ref. No.</b>	27318591 RX27318591
<b>description</b>	heating element 3000W 230V heating circuits 2 flange 70x18mm L 365mm W 65mm connection male faston 6.3mm tube ø 8.5mm immersion heater expansion flange		
<b>accessories for</b>	415465		
	<b>GEV No.</b>	379078	<b>Ref. No.</b> —
	temperature probe thermocouple K (NiCr-Ni) cable silicone probe -50 up to 1150°C cable -50 up to +180°C connection 2-wire thread probe ø1.5x100mm cable length 1.8m		







			
1			
<b>GEV No.</b>	415016	<b>Ref. No.</b>	94813777 RX94813777
<b>description</b>	heating element 3000W 230V heating circuits 3 flange 70x18mm L 398mm W 60mm H 24mm connection male faston 6.3mm immersion heater expansion flange tube ø 6.3mm		

			
1			
<b>GEV No.</b>	415466	<b>Ref. No.</b>	27318583 RX27318583
<b>description</b>	heating element 6000W 230V heating circuits 2 flange 70x18mm L 365mm W 65mm connection male faston 6.3mm tube ø 8.5mm immersion heater expansion flange connection length 32mm		
<b>accessories for</b>	415466		
	<b>GEV No.</b>	379078	<b>Ref. No.</b> —
	temperature probe thermocouple K (NiCr-Ni) cable silicone probe -50 up to 1150°C cable -50 up to +180°C connection 2-wire thread probe ø1.5x100mm cable length 1.8m		

## with round flange ø47.5mm

			
1			
<b>GEV No.</b>	415269	<b>Ref. No.</b>	RX94807146
<b>description</b>	heating element 2700W 230V heating circuits 3 mounting ø 47.5mm L 257mm W 28mm H 45mm round flange connection male faston 6.3mm immersion heater tube ø 6.3mm H1 11mm H2 34mm connection length 28mm		
<b>accessories for</b>	415269		
	<b>GEV No.</b>	510408	<b>Ref. No.</b> RX94807781
	O-ring EPDM thickness 5.34mm ID ø 47mm Qty 1 pcs		
	<b>GEV No.</b>	510562	<b>Ref. No.</b> —
	O-ring silicone thickness 5.34mm ID ø 47mm Qty 1 pcs		
	<b>GEV No.</b>	520235	<b>Ref. No.</b> 94807955 RX94807955
	3 hole flange hole distance 70.5mm perforation ø 6.5mm ID ø 53.5mm		
	<b>GEV No.</b>	520236	<b>Ref. No.</b> —
	flange for heating element ID ø 50mm ED ø 90mm hole ø 6.5mm 3 holes		

<b>accessories for</b>	415269		
	<b>GEV No.</b>	550002	<b>Ref. No.</b> —
	tension strap H 10mm L 21mm W 10mm hole ø 6.5mm for heating element		
	<b>GEV No.</b>	550362	<b>Ref. No.</b> —
	blind flange ø 64mm mounting ø 47.5mm		

			
1			
<b>GEV No.</b>	415262	<b>Ref. No.</b>	94808375 RX94808375
<b>description</b>	heating element 3000W 230V heating circuits 3 mounting ø 47.5mm L 260mm W 40mm H 36mm round flange connection male faston 6.3mm immersion heater tube ø 6.3mm thermostat sleeves ø 7mm number of thermostat sleeves 1 length thermostat sleeves 250mm thermostat sleeve upper centre not clinging		
<b>accessories for</b>	415262		
	<b>GEV No.</b>	510408	<b>Ref. No.</b> RX94807781
	O-ring EPDM thickness 5.34mm ID ø 47mm Qty 1 pcs		
	<b>GEV No.</b>	510562	<b>Ref. No.</b> —
	O-ring silicone thickness 5.34mm ID ø 47mm Qty 1 pcs		
	<b>GEV No.</b>	520235	<b>Ref. No.</b> 94807955 RX94807955
	3 hole flange hole distance 70.5mm perforation ø 6.5mm ID ø 53.5mm		
	<b>GEV No.</b>	520236	<b>Ref. No.</b> —
	flange for heating element ID ø 50mm ED ø 90mm hole ø 6.5mm 3 holes		
	<b>GEV No.</b>	550002	<b>Ref. No.</b> —
	tension strap H 10mm L 21mm W 10mm hole ø 6.5mm for heating element		
	<b>GEV No.</b>	550362	<b>Ref. No.</b> —
	blind flange ø 64mm mounting ø 47.5mm		











			
1			
<b>GEV No.</b>	415263	<b>Ref. No.</b>	RX94810462
<b>description</b>	heating element 4500W 230V heating circuits 3 mounting ø 47.5mm L 375mm W 38mm H 46mm round flange connection male faston 6.3mm immersion heater tube ø 6.3mm thermostat sleeves ø 7mm number of thermostat sleeves 1 length thermostat sleeves 240mm thermostat sleeve not clinging		
<b>accessories for</b>	415263		
	<b>GEV No.</b>	510408	<b>Ref. No.</b> RX94807781
	O-ring EPDM thickness 5.34mm ID ø 47mm Qty 1 pcs		
	<b>GEV No.</b>	520235	<b>Ref. No.</b> 94807955 RX94807955
	3 hole flange hole distance 70.5mm perforation ø 6.5mm ID ø 53.5mm		
	<b>GEV No.</b>	520236	<b>Ref. No.</b> —
	flange for heating element ID ø 50mm ED ø 90mm hole ø 6.5mm 3 holes		
	<b>GEV No.</b>	521012	<b>Ref. No.</b> —
	gasket graphite ED ø 15mm ID ø 5mm thickness 1.2mm Qty 1 pcs		



Table continues overleaf









<b>accessories for</b>	415263		
	GEV No.	550002	Ref. No. —
	tension strap H 10mm L 21mm W 10mm hole ø 6.5mm for heating element		
	GEV No.	550362	Ref. No. —
	blind flange ø 64mm mounting ø 47.5mm		





<b>with round flange ø57.5mm</b>			
			
<b>GEV No.</b>	416279	<b>Ref. No.</b>	94808631 RX94808631
<b>description</b>	heating element 12000W 230V heating circuits 3 mounting ø 57.5mm L 470mm W 48mm H 34mm round flange connection M5 immersion heater tube ø 8.5mm connection length 30mm thermostat sleeves ø 7mm number of thermostat sleeves 1 length thermostat sleeves 295mm thermostat sleeve eccentric, non clinging		
<b>accessories for</b>	416279		
	GEV No.	550002	Ref. No. —
	tension strap H 10mm L 21mm W 10mm hole ø 6.5mm for heating element		

			
<b>GEV No.</b>	420055	<b>Ref. No.</b>	RX94808789
<b>description</b>	heating element 14000W 230V heating circuits 3 L 480mm W 36mm H 44mm connection M5 tube ø 8.5mm thermostat sleeves ø 7.7mm number of thermostat sleeves 1 length thermostat sleeves 280mm		

			
<b>GEV No.</b>	415264	<b>Ref. No.</b>	94807286 RX94807286
<b>description</b>	heating element 6000W 230V heating circuits 3 mounting ø 57.5mm L 480mm W 33mm H 42mm round flange connection M5 immersion heater tube ø 8.5mm connection length 19mm thermostat sleeves ø 7.5mm number of thermostat sleeves 1 length thermostat sleeves 268mm thermostat sleeve not clinging		
<b>spare parts for</b>	415264		
	GEV No.	510409	Ref. No. RX94807294
	O-ring EPDM thickness 5.34mm ID ø 56.52mm Qty 1 pcs		
<b>accessories for</b>	415264		
	GEV No.	550002	Ref. No. —
	tension strap H 10mm L 21mm W 10mm hole ø 6.5mm for heating element		

			
<b>GEV No.</b>	415265	<b>Ref. No.</b>	RX94807963
<b>description</b>	heating element 9000W 230V heating circuits 3 mounting ø 57.5mm L 470mm W 35mm H 41mm round flange connection M5 immersion heater tube ø 8.5mm connection length upper centre not clinging-mm thermostat sleeves ø 7.5mm number of thermostat sleeves 1 length thermostat sleeves 295mm		
<b>spare parts for</b>	415265		
	GEV No.	510409	Ref. No. RX94807294
	O-ring EPDM thickness 5.34mm ID ø 56.52mm Qty 1 pcs		
<b>accessories for</b>	415265		
	GEV No.	550002	Ref. No. —
	tension strap H 10mm L 21mm W 10mm hole ø 6.5mm for heating element		

<b>1"</b>			
			
<b>GEV No.</b>	415196	<b>Ref. No.</b>	94801438 RX94801438
<b>description</b>	heating element 2000W 230V heating circuits 2 thread 1" L 305mm W 34mm H 45mm H1 22mm H2 23mm tube ø 6.3mm connection male faston 6.3mm immersion heater flange with thread WS 30		
<b>accessories for</b>	415196		
	GEV No.	510404	Ref. No. —
	flat gasket fibre ED ø 44mm ID ø 34mm thickness 2mm Qty 1 pcs		
	GEV No.	510422	Ref. No. —
	gasket copper ED ø 37.7mm ID ø 32.5mm thickness 2.7mm for thread 1"		
	GEV No.	520233	Ref. No. —
	nut thread 1" H 6mm brass WS 47 Qty 1 pcs		

<b>1 1/4"</b>			
			
<b>GEV No.</b>	415153	<b>Ref. No.</b>	94807138 RX94807138
<b>description</b>	heating element 5700W 230V heating circuits 3 thread 1 1/4" L 300mm W 85mm H 42mm L1 120mm L2 180mm W1 29mm W2 28mm H1 21mm H2 21mm tube ø 6.3mm connection male faston 6.3mm connection length 40mm flange with thread immersion heater		
<b>spare parts for</b>	415153		
	GEV No.	510405	Ref. No. —
	flat gasket fibre ED ø 56mm ID ø 42mm thickness 2mm for thread 1 1/4" Qty 1 pcs		
<b>accessories for</b>	415153		
	GEV No.	520232	Ref. No. —
	nut thread 1 1/4" H 5mm nickel-plated brass WS 47 Qty 1 pcs		
	GEV No.	528021	Ref. No. —
	flat gasket PTFE ED ø 53mm ID ø 42.5mm thickness 3mm Qty 1 pcs equiv. no. 12001/02286 suitable for Astoria/Aurora/Brasilia/Wega		

<b>2"</b>			
			
<b>GEV No.</b>	415299	<b>Ref. No.</b>	94806106 RX94806106
<b>description</b>	heating element 6000W 230V heating circuits 3 L 320mm W 40mm H 44mm tube ø 8.5mm thermostat sleeves ø 5mm length thermostat sleeves 280mm connection M4 immersion heater flange with thread 2"		
<b>accessories for</b>	415299		
	GEV No.	510407	Ref. No. —
	flat gasket fibre ED ø 78mm ID ø 60mm thickness 2mm for heating element for thread 2" Qty 1 pcs		





			
1			
<b>GEV No.</b>	415666	<b>Ref. No.</b>	94803566 RX94803566
<b>description</b>	heating element 1100W 230V heating circuits 1 L 151mm W 56mm Hmm thread 1/8" mounting distance 50mm tube ø 6.3mm 2 hole fixing immersion heater connection male faston 6.3mm		

			
1			
<b>GEV No.</b>	415665	<b>Ref. No.</b>	94803053 94803400 RX94803053 RX94803400
<b>description</b>	heating element 2750/3250W 220/240V heating circuits 1 L 380mm W 110mm H 30mm thread M10x1 mounting distance 75mm tube ø 6.5mm connection M4 immersion heater 2 hole fixing		

<b>spare parts for</b>	415665		
	<b>GEV No.</b>	510893	<b>Ref. No.</b> 94807765 RX94807765
	O-ring EPDM thickness 2.62mm ID ø 9.92mm Qty 1 pcs		

<b>accessories for</b>	415665		
	<b>GEV No.</b>	510416	<b>Ref. No.</b> —
	flat gasket fibre ED ø 19mm ID ø 10.5mm thickness 1.5mm for thread M10 Qty 1 pcs		

	<b>GEV No.</b>	520231	<b>Ref. No.</b> —
	nut thread M10x1 H 6mm WS 14 zinc-coated steel Qty 1 pcs		

	<b>GEV No.</b>	521103	<b>Ref. No.</b> —
	nut thread M4 H 3mm WS 7 brass Qty 20 pcs		

	<b>GEV No.</b>	521104	<b>Ref. No.</b> —
	washer ID ø 4.3mm ED ø 8mm thickness 0.5mm brass Qty 20 pcs for thread M4		

	<b>GEV No.</b>	521129	<b>Ref. No.</b> —
	nut thread M10 H 6mm SS WS 17 Qty 1 pcs DIN/ISO DIN 439		

	<b>GEV No.</b>	560111	<b>Ref. No.</b> —
	plain washer ID ø 4.3mm ED ø 9mm thickness 0.8mm SS Qty 20 pcs DIN 125A for thread M4		

	<b>GEV No.</b>	560131	<b>Ref. No.</b> —
	hexagonal nut thread M4 H 3.2mm WS 7 SS DIN/ISO DIN 934 / ISO 4032/8673 Qty 20 pcs		

			
1			
<b>GEV No.</b>	420245	<b>Ref. No.</b>	94050010 RX94050010
<b>description</b>	heating element 3600W 240V heating circuits 1 L 143mm W 335mm connection M4 tube ø 8.3mm thread M12x1 2 hole fixing immersion heater/dry heating element mounting distance 327mm		

			
1			
<b>GEV No.</b>	420247	<b>Ref. No.</b>	9403055 94030558 RX94030558
<b>description</b>	heating element 4200W 240V heating circuits 1 L 580mm W 165mm H 53mm tube ø 10mm connection M4 dry heating element 2 hole fixing		

			
1			
<b>GEV No.</b>	420244	<b>Ref. No.</b>	9400462 94004629 RX94004629
<b>description</b>	heating element 4950W 230V heating circuits 1 L 540mm W 33mm H 33mm tube ø 8.5mm connection M4 immersion heater 2 hole fixing L1 30mm L2 510mm thread M14x1.5 mounting distance 25mm		

## heating elements for convection





			
1			
<b>GEV No.</b>	415251	<b>Ref. No.</b>	94806387 RX94806387
<b>description</b>	heating element 2500W 230V heating circuits 1 ID ø 178mm ED ø 190mm L 242mm H 35mm L1 46mm W1 31mm H1 10mm H2 25mm flange length 70mm flange width 22mm hole distance 56mm connection male faston 6.3mm horizontal tube ø 6.3mm convection heating element hole ø 5mm rectangular flange		
<b>spare parts for</b>	415251		
	<b>GEV No.</b>	510368	<b>Ref. No.</b> —
	gasket L 70mm W 23.5mm hole ø 5mm hole distance 56mm FIBER thickness 2mm for heating element		



			
1			
<b>GEV No.</b>	418131	<b>Ref. No.</b>	RX94814229
<b>description</b>	heating element 6000W 230V heating circuits 3 ID ø 217mm ED ø 231mm L 271mm H 90mm L1 41mm W1 103mm H1 24mm H2 66mm flange length 140mm flange width 22mm hole distance 63mm tube ø 6.3mm convection heating element hole ø 5mm rectangular flange		



 <p>1</p>			
<b>GEV No.</b>	415911	<b>Ref. No.</b>	27307982 RX27307982
<b>description</b>	heating element 9000W 230V heating circuits 4 ID ø 310mm ED ø 333mm L 410mm H 115mm L1 77mm W1 75mm H1 15mm H2 100mm thread M14x1.5 8 hole fixing connection male faston 6.3mm tube ø 8.5mm convection heating element		
<b>accessories for</b>	415911		
	<b>GEV No.</b>	510417	<b>Ref. No.</b> —
	flat gasket fibre ED ø 20mm ID ø 14mm thickness 2mm Qty 1 pcs		
	<b>GEV No.</b>	520228	<b>Ref. No.</b> —
	tooth lock washer ID ø 15.3mm ED ø 24mm steel Qty 1 pcs for thread M14		
	<b>GEV No.</b>	520230	<b>Ref. No.</b> —
	nut thread M14x1.5 H 5mm WS 19 zinc-coated steel Qty 1 pcs		
	<b>GEV No.</b>	521101	<b>Ref. No.</b> —
	nut thread M14x1.5 H 5mm WS 19 SS Qty 1 pcs		
	<b>GEV No.</b>	550262	<b>Ref. No.</b> —
	flat gasket copper ED ø 20mm ID ø 14mm thickness 2mm		

 <p>1</p>			
<b>GEV No.</b>	419201	<b>Ref. No.</b>	Rx94032695
<b>description</b>	heating element 1667W 230V heating circuits 1 L 405mm W 295mm L1 30mm L2 377mm W2 32mm tube ø 8mm thread M12 W1 262mm		

 <p>1</p>			
<b>GEV No.</b>	415469	<b>Ref. No.</b>	27307974 RX27307974
<b>description</b>	heating element 2000W 220V heating circuits 1 L 95mm W 520mm connection length 24mm connection male faston 6.3mm tube ø 6.3mm thread M14x1.5 2 hole fixing convection heating element mounting distance 514mm		
<b>accessories for</b>	415469		
	<b>GEV No.</b>	510417	<b>Ref. No.</b> —
	flat gasket fibre ED ø 20mm ID ø 14mm thickness 2mm Qty 1 pcs		
	<b>GEV No.</b>	520228	<b>Ref. No.</b> —
	tooth lock washer ID ø 15.3mm ED ø 24mm steel Qty 1 pcs for thread M14		
	<b>GEV No.</b>	520230	<b>Ref. No.</b> —
	nut thread M14x1.5 H 5mm WS 19 zinc-coated steel Qty 1 pcs		

<b>accessories for</b>	415469		
	<b>GEV No.</b>	521101	<b>Ref. No.</b> —
	nut thread M14x1.5 H 5mm WS 19 SS Qty 1 pcs		
	<b>GEV No.</b>	550262	<b>Ref. No.</b> —
	flat gasket copper ED ø 20mm ID ø 14mm thickness 2mm		

 <p>1</p>			
<b>GEV No.</b>	415554	<b>Ref. No.</b>	27307966 RX27307966
<b>description</b>	heating element 2500W 230V heating circuits 1 L 148mm W 534mm connection male faston 6.3mm tube ø 6.3mm thread M14x1.5 2 hole fixing convection heating element mounting distance 528mm		
<b>spare parts for</b>	415554		
	<b>GEV No.</b>	510420	<b>Ref. No.</b> —
	gasket copper ED ø 19.9mm ID ø 14.3mm thickness 2mm Qty 1 pcs		
<b>accessories for</b>	415554		
	<b>GEV No.</b>	510417	<b>Ref. No.</b> —
	flat gasket fibre ED ø 20mm ID ø 14mm thickness 2mm Qty 1 pcs		
	<b>GEV No.</b>	520228	<b>Ref. No.</b> —
	tooth lock washer ID ø 15.3mm ED ø 24mm steel Qty 1 pcs for thread M14		
	<b>GEV No.</b>	520230	<b>Ref. No.</b> —
	nut thread M14x1.5 H 5mm WS 19 zinc-coated steel Qty 1 pcs		
	<b>GEV No.</b>	521101	<b>Ref. No.</b> —
	nut thread M14x1.5 H 5mm WS 19 SS Qty 1 pcs		
	<b>GEV No.</b>	550262	<b>Ref. No.</b> —
	flat gasket copper ED ø 20mm ID ø 14mm thickness 2mm		

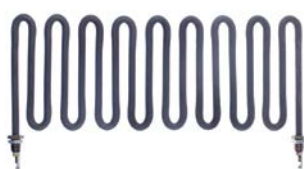
 <p>1</p>			
<b>GEV No.</b>	420245	<b>Ref. No.</b>	94050010 RX94050010
<b>description</b>	heating element 3600W 240V heating circuits 1 L 143mm W 335mm connection M4 tube ø 8.3mm thread M12x1 2 hole fixing immersion heater/dry heating element mounting distance 327mm		



## radiation heaters

## 1-circuit



1

<b>GEV No.</b>	490024	<b>Ref. No.</b>	94806171 RX94806171
<b>description</b>	radiation heater ø 165mm 1200W 230V heating circuits 1 energy regulation with temperature signalization with heating coil connections 2+2 connection type male faston 6.3mm EGO		

## hot plates

## square &amp; rectangular

## with radiused edge



1

<b>GEV No.</b>	490066 <sup>1</sup>	<b>Ref. No.</b>	94806866 RX94806866
<b>description</b>	hot plate dimensions 220x220mm 2600W 230V with spill ring connection 4 screw clamps protector yes square		

<sup>1</sup>incl. protector

## round

## with radiused edge

## for domestic and commercial kitchens



1

<b>GEV No.</b>	490016	<b>Ref. No.</b>	RX94012804
<b>description</b>	hot plate ø 180mm 2000W 230V connection 4 screw clamps with 8mm spill ring		



1

<b>GEV No.</b>	490020	<b>Ref. No.</b>	94012796 RX94012796
<b>description</b>	hot plate ø 220mm 2600W 230V connection 4 screw clamps with 8mm spill ring		
<b>accessories for</b>	490020		
	<b>GEV No.</b>	<b>Ref. No.</b>	—
	550796		
	fixing plate for hot plate ø220mm		



1

<b>GEV No.</b>	490062	<b>Ref. No.</b>	RX94012770
<b>description</b>	hot plate ø 300mm 3500W 220V connection 4 screw clamps with 8mm spill ring		

## energy regulators

## EGO

## 1-circuit



1

<b>GEV No.</b>	380001	<b>Ref. No.</b>	RX94045299
<b>description</b>	energy regulator 230V 12A single-circuit turn direction right		



1

<b>GEV No.</b>	380015	<b>Ref. No.</b>	94812641 RX94812641
<b>description</b>	energy regulator 230V 13A single-circuit turn direction right shaft ø 6x4.6mm shaft L 23mm mounting thread M4 power release 6-100% no. 50.57021.010		

## DIAMOND



1

<b>GEV No.</b>	380037	<b>Ref. No.</b>	RX94027786
<b>description</b>	energy regulator 240V 13.5A turn direction right shaft ø 6x4.6mm shaft L 13mm mounting thread 3/8"-24UNF equiv. no. 35ERE101230V		



1

<b>GEV No.</b>	380039	<b>Ref. No.</b>	RX24848012
<b>description</b>	energy regulator 400V 13.5A turn direction right shaft ø 6x4.6mm mounting thread 3/8"-24UNF equiv. no. 35ERE104400V		
<b>accessories for</b>	380039		
	<b>GEV No.</b>	<b>Ref. No.</b>	—
	361181		
	nut thread 1/8" H 4.5mm nickel-plated brass WS 14 Qty 1 pcs		



## thermostats

### bi-metal thermostats

#### safety bi-metal thermostats



1

<b>GEV No.</b>	390480	<b>Ref. No.</b>	RX94808326
<b>description</b>	bi-metal safety thermostat hole distance 23.8mm switch-off temp. 105°C 1NC 1-pole 16A connection F6.3 2 hole fixing		



1

<b>GEV No.</b>	390318	<b>Ref. No.</b>	94803111 RX94803111
<b>description</b>	bi-metal safety thermostat switch-off temp. 95°C 1-pole 2 hole fixing		

#### bi-metal thermostats



1

<b>GEV No.</b>	390025	<b>Ref. No.</b>	94813739 RX94813739	
<b>description</b>	bi-metal thermostat hole distance 40mm switch-off temp. 55/42°C NC/NO 2-pole 16A 250V connection F6.3 2 hole fixing			
<b>accessories for</b>	390025			
	<b>GEV No.</b>	512154	<b>Ref. No.</b>	94813740 RX94813740
	gasket for thermostat ID ø 20mm equiv. no. 200494/H200494 hole distance 41mm suitable for COMENDA, HOONVED			

### control and safety thermostats

#### EGO

#### control thermostats

#### 55.10/19\_ series



1

<b>GEV No.</b>	376014	<b>Ref. No.</b>	RX94016615
<b>description</b>	thermostat t.max. 110°C temperature range 0-110°C 1-pole 1NO 16A probe ø 6mm probe L 140mm capillary pipe 875mm capillary pipe isolated 780mm gland nut M9x1 shaft ø 6x4.6mm shaft L 23mm shaft position upper		



1

<b>GEV No.</b>	376011	<b>Ref. No.</b>	9401668 94016680 RX94016680
<b>description</b>	thermostat t.max. 200°C temperature range 150-200°C 1-pole 1NO 16A probe ø 6mm probe L 79mm capillary pipe 860mm capillary pipe isolated 610mm gland nut M9x1 shaft ø 6x4.6mm shaft L 23mm shaft position upper		

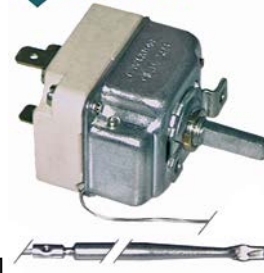

1

<b>GEV No.</b>	375270	<b>Ref. No.</b>	RX94812577
<b>description</b>	thermostat t.max. 295°C temperature range 45-295°C 1-pole 1NO 16A probe ø 4mm probe L 100mm capillary pipe 900mm capillary pipe isolated 350mm gland nut shaft L 23mm shaft position upper rotation 270°		



1

<b>GEV No.</b>	376010	<b>Ref. No.</b>	RX94024957
<b>description</b>	thermostat t.max. 320°C temperature range 50-320°C 1-pole 1NO 16A probe ø 3mm probe L 226mm capillary pipe 880mm capillary pipe isolated 865mm gland nut shaft ø 6x4.6mm shaft L 23mm shaft position upper rotation 270°		



<b>GEV No.</b>	375231	<b>Ref. No.</b>	94805249 RX94805249
<b>description</b>	thermostat t.max. 90°C temperature range 30-90°C 1-pole 1NO 16A probe ø 6mm probe L 130mm capillary pipe 900mm capillary pipe isolated 600mm gland nut M9x1 shaft L 18mm shaft position upper rotation 270°		

55.13\_ series



<b>GEV No.</b>	375401	<b>Ref. No.</b>	24848269 RX24848269
<b>description</b>	thermostat t.max. 185°C temperature range 97-185°C 1-pole 1NO 16A probe ø 6mm probe L 87mm capillary pipe 1430mm capillary pipe isolated 1100mm gland nut M9x1 shaft ø 6x4.6mm shaft L 23mm shaft position upper rotation 270°		



<b>GEV No.</b>	375492	<b>Ref. No.</b>	94805371 RX94805371
<b>description</b>	thermostat t.max. 190°C temperature range 94-190°C 1-pole 1NO 16A probe ø 6mm probe L 94mm capillary pipe 1090mm capillary pipe isolated 960mm gland nut M10x1 shaft ø 6x4.6mm shaft L 23mm shaft position upper rotation 310° probe material SS		



<b>GEV No.</b>	375085	<b>Ref. No.</b>	24848145 RX24848145
<b>description</b>	thermostat t.max. 90°C temperature range 0-90°C 1-pole 1CO 16A probe ø 3.1mm probe L 247mm capillary pipe 1430mm capillary pipe isolated 1400mm gland nut shaft ø 6x4.6mm shaft L 18mm shaft position upper probe material SS		

55.17\_ series



<b>GEV No.</b>	375672	<b>Ref. No.</b>	RX94804655
<b>description</b>	thermostat t.max. 320°C temperature range 50-320°C 1-pole 1NO 16A probe ø 3.03mm probe L 178mm capillary pipe 840mm capillary pipe isolated 840mm gland nut shaft ø 6x4.6mm shaft L 23mm shaft position upper rotation 270°		

55.34\_ series



<b>GEV No.</b>	375602	<b>Ref. No.</b>	RX94805421
<b>description</b>	thermostat t.max. 120°C temperature range 45-120°C 3-pole 3CO 16A probe ø 6mm probe L 140mm capillary pipe 900mm capillary pipe isolated 870mm gland nut shaft ø 6x4.6mm shaft L 23mm shaft position upper rotation 270°		



<b>GEV No.</b>	375097	<b>Ref. No.</b>	94804978 RX94804978
<b>description</b>	thermostat t.max. 195°C temperature range 95-195°C 3-pole 3NO 16A probe ø 6mm probe L 117mm capillary pipe 1780mm capillary pipe isolated 1400mm gland nut M9x1 shaft ø 6x4.6mm shaft L 23mm shaft position upper rotation 270°		



<b>GEV No.</b>	375192	<b>Ref. No.</b>	94805645 RX94805645
<b>description</b>	thermostat t.max. 300°C temperature range 50-300°C 3-pole 3NO 16A probe ø 3mm probe L 219mm capillary pipe 900mm capillary pipe isolated 900mm gland nut shaft ø 6x4.6mm shaft L 23mm shaft position upper rotation 270°		



<b>GEV No.</b>	375417	<b>Ref. No.</b>	RX24845588
<b>description</b>	thermostat t.max. 200°C temperature range 65-200°C 3-pole 3NO 16A probe ø 6mm probe L 79mm capillary pipe 840mm capillary pipe isolated 840mm gland nut M9x1 shaft ø 6x4.6mm shaft L 23mm rotation 270°		



<b>GEV No.</b>	375038	<b>Ref. No.</b>	94032588 RX94032588
<b>description</b>	thermostat t.max. 300°C temperature range 50-300°C 3-pole 3NO 16A probe ø 6mm probe L 79mm capillary pipe 1740mm capillary pipe isolated 800mm gland nut shaft ø 6x4.6mm shaft L 23mm shaft position upper rotation 270°		
<b>accessories for</b>	375038		
	<b>GEV No.</b>	110123	<b>Ref. No.</b> —
	knob thermostat t.max. 300°C ø 50mm shaft ø 6x4.6mm shaft flat upper black temperature range 50-300°C rotation 270°		



<b>GEV No.</b>	376009	<b>Ref. No.</b>	RX94016698
<b>description</b>	thermostat t.max. 200°C temperature range 68-200°C 3-pole 3NO 16A probe ø 6mm probe L 79mm capillary pipe 2390mm capillary pipe isolated 1600mm gland nut M9x1 shaft ø 6x4.6mm shaft L 23mm shaft position upper rotation 270°		

safety thermostats

51\_ series



<b>GEV No.</b>	375268	<b>Ref. No.</b>	94812621 RX94812621
<b>description</b>	thermostat t.max. 295°C temperature range 75-295°C 3-pole 3NO 16A probe ø 4mm probe L 92mm capillary pipe 900mm capillary pipe isolated 350mm gland nut shaft ø 6x4.6mm shaft L 23mm shaft position upper rotation 270°		



<b>GEV No.</b>	375090	<b>Ref. No.</b>	24848111 RX24848111
<b>description</b>	safety thermostat switch-off temp. 365°C 2-pole 16A probe ø 4mm probe L 120mm capillary pipe 1170mm capillary pipe isolated 1100mm gland nut probe SS		

55.10/19\_series



<b>GEV No.</b>	375376	<b>Ref. No.</b>	RX94805702
<b>description</b>	safety thermostat capillary pipe 870mm probe ø 6mm 1-pole probe L 133mm 0.5A capillary pipe isolated gland nut M10x1 switch-off temp. 224°C probe		



<b>GEV No.</b>	375352	<b>Ref. No.</b>	RX94804986
<b>description</b>	safety thermostat switch-off temp. 245°C 1-pole 1NC 16A probe ø 6mm probe L 130mm capillary pipe 1200mm capillary pipe isolated 1200mm gland nut probe		

55.12\_series



<b>GEV No.</b>	375776	<b>Ref. No.</b>	24848343 RX24848343
<b>description</b>	safety thermostat switch-off temp. 135°C 1-pole 10A probe ø 6mm probe L 87mm capillary pipe 1440mm capillary pipe isolated 1400mm gland nut probe SS		

55.13\_series



<b>GEV No.</b>	376079	<b>Ref. No.</b>	94016599 RX94016599 RX94046363
<b>description</b>	safety thermostat switch-off temp. 215°C probe ø 6mm probe L 89mm capillary pipe 900mm capillary pipe isolated 760mm probe SS		

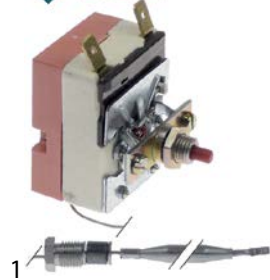

<b>GEV No.</b>	390801	<b>Ref. No.</b>	RX94050911
<b>description</b>	thermostat switch-off temp. 140°C 1-pole 16A probe ø 6mm probe L 78mm capillary pipe 1500mm capillary pipe isolated gland nut probe connection male faston 6.3mm		

55.32\_series



<b>GEV No.</b>	390424	<b>Ref. No.</b>	RX94800505
<b>description</b>	safety thermostat switch-off temp. 110°C 3-pole 20A probe ø 6mm probe L 74mm capillary pipe 2000mm capillary pipe isolated 2000mm gland nut probe		



<b>GEV No.</b>	375275	<b>Ref. No.</b>	94805231 RX94805231
<b>description</b>	safety thermostat switch-off temp. 125°C 1-pole 0.5A probe ø 4mm probe L 120mm capillary pipe 900mm capillary pipe isolated 900mm gland nut probe SS		



<b>GEV No.</b>	375277	<b>Ref. No.</b>	94805413 RX94805413
<b>description</b>	safety thermostat switch-off temp. 150°C 3-pole 3NC 20A probe ø 6mm probe L 79mm capillary pipe 900mm capillary pipe isolated 700mm gland nut probe		



<b>GEV No.</b>	375199	<b>Ref. No.</b>	94812642 RX94812642
<b>description</b>	safety thermostat switch-off temp. 132°C 3-pole 2x20/1x0.5A probe ø 6mm probe L 77mm capillary pipe 890mm capillary pipe isolated-mm gland nut M10x1 probe SS		



<b>GEV No.</b>	375445	<b>Ref. No.</b>	RX94812559
<b>description</b>	safety thermostat switch-off temp. 230°C 3-pole 2x20/1x0.5A probe ø 4mm probe L 120mm capillary pipe 900mm capillary pipe isolated 700mm gland nut probe		



<b>GEV No.</b>	375281	<b>Ref. No.</b>	94812646 RX94812646
<b>description</b>	safety thermostat switch-off temp. 150°C 3-pole 0.5A probe ø 3mm probe L 188mm capillary pipe 1100mm capillary pipe isolatedmm gland nut probe SS		



<b>GEV No.</b>	375258	<b>Ref. No.</b>	94812594 RX94812594
<b>description</b>	safety thermostat switch-off temp. 232°C 3-pole 20A probe ø 6mm probe L 94mm capillary pipe 900mm capillary pipe isolated 670mm gland nut M10x1 probe SS		



<b>GEV No.</b>	375279	<b>Ref. No.</b>	RX94812622
<b>description</b>	safety thermostat switch-off temp. 345°C 3-pole 20A probe ø 4mm probe L 120mm capillary pipe 900mm capillary pipe isolated 900mm gland nut probe SS		



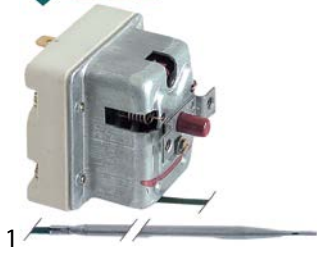

<b>GEV No.</b>	375344	<b>Ref. No.</b>	94800158 RX94800158
<b>description</b>	safety thermostat switch-off temp. 360°C 1-pole 0.5A probe ø 4mm probe L 120mm capillary pipe 1500mm capillary pipe isolated 1500mm gland nut probe		



<b>GEV No.</b>	375684	<b>Ref. No.</b>	94814230 RX94814230
<b>description</b>	safety thermostat switch-off temp. 360°C 1-pole 20A probe ø 11mm probe L 16mm capillary pipe 900mm capillary pipe isolated 900mm gland nut probe screw-in probe probe thread M14x1		

control thermostats with operation switch

55.10/19\_ series

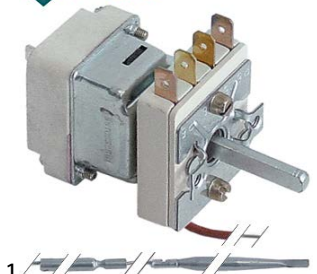

<b>GEV No.</b>	375331	<b>Ref. No.</b>	RX94812560
<b>description</b>	thermostat t.max. 189°C temperature range 62-189°C 1-pole 1NO 0.5A probe ø 4mm probe L 116mm capillary pipe 900mm capillary pipe isolated 700mm gland nut shaft ø 6x4.6mm shaft L 23mm shaft position upper rotation 270° outer switch 2NO		

55.34\_ series

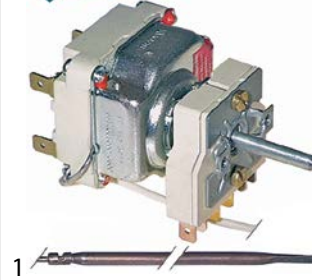

<b>GEV No.</b>	375246	<b>Ref. No.</b>	RX94090032
<b>description</b>	thermostat t.max. 645°C temperature range 100-615/645°C 2-pole 2NO 16A probe ø 4mm probe L 230mm capillary pipe 1100mm capillary pipe isolated 600mm gland nut shaft ø 6x4.6mm shaft L 25mm shaft position lower rotation 270° outer switch 2NO probe material copper		

IMIT / TEMPOMATIC / AR THERMO

control thermostats



<b>GEV No.</b>	390193	<b>Ref. No.</b>	RX94801099
<b>description</b>	thermostat t.max. 56°C temperature range 0-90°C 1-pole 1CO 16A probe ø 6.5mm probe L 95mm capillary pipe 1500mm capillary pipe isolated 1500mm gland nut shaft ømm shaft Lmm shaft position rotation 270° probe material copper		







<b>GEV No.</b>	390314	<b>Ref. No.</b>	94803095 RX94803095
<b>description</b>	thermostat t.max. 60°C temperature range fixed 60°C-pole 1CO 15A probe ø 6.5mm probe L 95mm capillary pipe 2000mm capillary pipe isolated 1950mm gland nut shaft ømm shaft Lmm shaft position rotation° probe material copper		



<b>GEV No.</b>	390421	<b>Ref. No.</b>	94803103 RX94803103
<b>description</b>	thermostat t.max. 85°C temperature range 0-90°C 1-pole 1CO 16A probe ø 6.5mm probe L 95mm capillary pipe 1500mm capillary pipe isolated 1450mm gland nut shaft ømm shaft Lmm shaft position rotation 270° probe material copper		





			
<b>GEV No.</b>	390425	<b>Ref. No.</b>	94803129 RX94803129
<b>description</b>	thermostat t.max. 85°C temperature range fixed 60°C 1-pole 1CO 16A probe ø 9.5mm probe L 37mm capillary pipe 600mm capillary pipe isolated 600mm gland nut shaft ømm shaft Lmm shaft position rotation° screw-in probe probe thread M14x1 probe material SS		
<b>accessories for</b>	390425		
	<b>GEV No.</b>	510417	<b>Ref. No.</b> —
	flat gasket fibre ED ø 20mm ID ø 14mm thickness 2mm Qty 1 pcs		
	<b>GEV No.</b>	511472	<b>Ref. No.</b> —
	nut thread 3/8" H 4mm brass WS 21 Qty 1 pcs		

			
<b>GEV No.</b>	390812	<b>Ref. No.</b>	RX94807732
<b>description</b>	thermostat t.max. 87°C temperature range fixes 87°C 1-pole 1CO 16A probe ø 6.5mm probe L 97mm capillary pipe 1500mm capillary pipe isolatedmm gland nut shaft Lmm rotation 270° 250V contacts male faston 6.3mm		

			
<b>GEV No.</b>	390460	<b>Ref. No.</b>	RX94807732
<b>description</b>	thermostat t.max. 90°C temperature range 30-90°C 1-pole 1CO 16A probe ø 6.5mm probe L 95mm capillary pipe 2000mm capillary pipe isolated 1950mm gland nut shaft ømm shaft Lmm shaft position rotation 270° probe material copper		

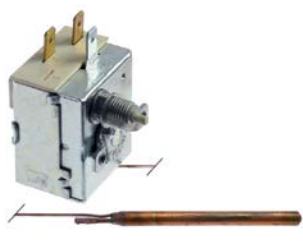
safety thermostats

			
<b>GEV No.</b>	390023	<b>Ref. No.</b>	RX94813555
<b>description</b>	safety thermostat switch-off temp. 90-110°C 1-pole 16A probe ø 6.5mm probe L 90mm capillary pipe 1000mm capillary pipe isolatedmm gland nut probe		

			
<b>GEV No.</b>	390770	<b>Ref. No.</b>	RX94803137
<b>description</b>	safety thermostat switch-off temp. 90-110°C 1-pole 1CO 16/0.5A probe ø 6.5mm probe L 90mm capillary pipe 2000mm capillary pipe isolated 1950mm gland nut probe		

JUMO control thermostats

			
<b>GEV No.</b>	376012	<b>Ref. No.</b>	RX94016573
<b>description</b>	thermostat t.max. 200°C temperature range 0-200°C 1-pole 1CO 6A probe ø 6mm probe L 114mm capillary pipe 1000mm capillary pipe isolatedmm gland nut shaft ø6x4.6mm shaft L 13mm		

			
<b>GEV No.</b>	376013	<b>Ref. No.</b>	RX94016581
<b>description</b>	thermostat t.max. 400°C temperature range 20-400°C 1-pole 1CO 6A probe ø 8mm probe L 138mm capillary pipe 1450mm capillary pipe isolatedmm gland nut shaft ø 6x4.6mm shaft L 18mm		



## CAMPINI

## control thermostats



<b>GEV No.</b>	375934	<b>Ref. No.</b>	RX94813996
<b>description</b>	thermostat t.max. 280°C temperature range 50-280°C 1-pole 1NO 16A probe ø 3mm probe L 185mm capillary pipe 960mm capillary pipe isolated 700mm gland nut shaft ø 6x4.6mm shaft L 23mm shaft position upper rotation 270° probe material SS 250V		

## various

## safety thermostats

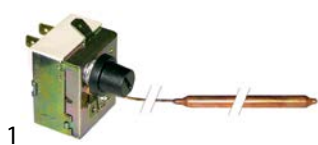

<b>GEV No.</b>	390194	<b>Ref. No.</b>	RX94807430
<b>description</b>	safety thermostat switch-off temp. 90-110°C 1-pole 16A probe ø 6.5mm probe L 87mm capillary pipe 1500mm capillary pipe isolated 1497mm connection male faston 6.3mm adjustable		

## accessories

## gland nut accessories

## ducts



<b>GEV No.</b>	100820	<b>Ref. No.</b>	RX94008893
<b>description</b>	gland duct ET M14x1.5 IT M10x0.75 probe ø max. 6.5mm WS 22		

## locking screws



<b>GEV No.</b>	106605	<b>Ref. No.</b>	94812566 RX94812566
<b>description</b>	union screw thread M10x1 probe ø max. 4.5mm		

## switches and momentary switches

## rocker/momentary rocker switches

## 30x22mm



<b>GEV No.</b>	301003	<b>Ref. No.</b>	94805496 RX94805496
<b>description</b>	rocker switch mounting measurements 30x22mm green 2NO 250V 16A illuminated 0-I connection male faston 6.3mm ambient temperature max. 125/55°C protection IP65		

## accessories for



<b>GEV No.</b>	301036	<b>Ref. No.</b>	—
<b>description</b>	protective cover internal size 30x22mm for rocker switch mounting measurementsmm		

## blank



<b>GEV No.</b>	345982	<b>Ref. No.</b>	94809506 RX94809506
<b>description</b>	rocker switch mounting measurements 30x22mm green 2CO 250V 16A illuminated connection male faston 6.3mm ambient temperature max. 125/55°C protection IP65 with cover cap		

## accessories for



<b>GEV No.</b>	301036	<b>Ref. No.</b>	—
<b>description</b>	protective cover internal size 30x22mm for rocker switch mounting measurementsmm		

## labelled



<b>GEV No.</b>	345981	<b>Ref. No.</b>	94809514 RX94809514
<b>description</b>	rocker switch mounting measurements 30x22mm green 2NO 250V 16A illuminated 0-I connection male faston 6.3mm ambient temperature max. 125/55°C protection IP65 with cover cap		

## accessories for





<b>GEV No.</b>	301036	<b>Ref. No.</b>	—
<b>description</b>	protective cover internal size 30x22mm for rocker switch mounting measurementsmm		





push/momentary push switches

28.5x28.5mm

			
1			
<b>GEV No.</b>	345226	<b>Ref. No.</b>	94801032 RX94801032
<b>description</b>	momentary push switch mounting measurements 28.5x28.5mm grey 1NO 250V 16A connection male faston 6.3mm ambient temperature max. 150°C protection IP40		

			
1			
<b>GEV No.</b>	345979	<b>Ref. No.</b>	94808482 RX94808482
<b>description</b>	push switch mounting measurements 28.5x28.5mm blue 2CO 250V 16A connection male faston 6.3mm ambient temperature max. 150°C protection IP40		

			
1			
<b>GEV No.</b>	345925	<b>Ref. No.</b>	94801388 RX94801388
<b>description</b>	push switch mounting measurements 28.5x28.5mm blue/green 1CO 250V 16A rinsing connection male faston 6.3mm ambient temperature max. 150°C protection IP40 with indicator		

			
1			
<b>GEV No.</b>	345924	<b>Ref. No.</b>	94801396 RX94801396
<b>description</b>	push switch mounting measurements 28.5x28.5mm green/red 1CO 250V 16A main switch connection male faston 6.3mm ambient temperature max. 150°C protection IP40 with indicator green/red		

			
1			
<b>GEV No.</b>	345143	<b>Ref. No.</b>	RX94801560
<b>description</b>	push switch mounting measurements 28.5x28.5mm green/red 2CO 250V 16A main switch connection male faston 6.3mm ambient temperature max. 150°C protection IP40 with indicator		

			
1			
<b>GEV No.</b>	345975	<b>Ref. No.</b>	94808466 RX94808466
<b>description</b>	push switch mounting measurements 28.5x28.5mm green/red 2NO 250V 16A main switch connection male faston 6.3mm ambient temperature max. 150°C protection IP40 with indicator green/red		

28.5x77.5mm

			
1			
<b>GEV No.</b>	345867	<b>Ref. No.</b>	RX94808334
<b>description</b>	switch combination latching mounting measurements 28.5x77.5mm green 2CO/indicator light/1NO 250V 16A START/indicator light/on-off connection male faston 6.3mm ambient temperature max. 85°C protection IP40		

			
1			
<b>GEV No.</b>	345866	<b>Ref. No.</b>	RX94808359
<b>description</b>	switch combination latching mounting measurements 28.5x77.5mm green 2NO/1NO/indicator light 250V 16A START/indicator light/on-off connection male faston 6.3mm ambient temperature max. 85°C protection IP40		

			
1			
<b>GEV No.</b>	345869	<b>Ref. No.</b>	RX94808342
<b>description</b>	switch combination momentary mounting measurements 28.5x77.5mm green 1NO/indicator light/indicator light 250V 16A temperature/regeneration connection male faston 6.3mm ambient temperature max. 85°C protection IP40		

			
1			
<b>GEV No.</b>	345870	<b>Ref. No.</b>	RX94810629
<b>description</b>	switch combination momentary mounting measurements 28.5x77.5mm green 2NO/1NO/indicator light 250V 16A drain/temperature/regeneration connection male faston 6.3mm ambient temperature max. 85°C protection IP40		







			
1			
<b>GEV No.</b>	345868	<b>Ref. No.</b>	94808367 RX94808367
<b>description</b>	switch combination momentary mounting measurements 28.5x77.5mm green 2NO/indicator light 250V 16A drain/temperature connection male faston 6.3mm ambient temperature max. 85°C protection IP40		

<b>ø18.2mm</b>			
			
1			
<b>GEV No.</b>	346508	<b>Ref. No.</b>	26645481 RX26645481
<b>description</b>	momentary push switch mounting ø 18.2mm black 1NC/1NO 250V 2A connection screw ambient temperature max. 85°C protection IP40		

<b>ø25mm</b>			
			
1			
<b>GEV No.</b>	345038	<b>Ref. No.</b>	94805173 RX94805173
<b>description</b>	momentary push switch mounting ø 25mm black 2NO 250V 16A connection male faston 6.3mm ambient temperature max. 85°C protection IP40		

<b>accessories</b>			
<b>protective covers</b>			
			
1			
<b>GEV No.</b>	698490	<b>Ref. No.</b>	RX94029824
<b>description</b>	cover ED ø 17mm suitable for 345047		



<b>toggle switches</b>			
<b>M12x0.75</b>			
			
1			
<b>GEV No.</b>	346519	<b>Ref. No.</b>	RX94026036
<b>description</b>	toggle switch thread M12x0.75 2NO 250V 15A ON-OFF male faston 6.3mm		
<b>accessories for</b>	346519		
	<b>GEV No.</b>	346525	<b>Ref. No.</b> —
	protection cap L 23.5mm W 17.3mm protection cap rubber thread M11		
	<b>GEV No.</b>	347197	<b>Ref. No.</b> —
	bezel ON-OFF for toggle switch M12		

<b>microswitches</b>			
<b>lever actuated</b>			
			
1			
<b>GEV No.</b>	345254	<b>Ref. No.</b>	94812476 RX94812476
<b>description</b>	microswitch with lever 250V 16A 1CO connection male faston 6.3mm ambient temperature max. 120°C mounting distance 22mm actuating force: 60g lever length 58mm		

			
1			
<b>GEV No.</b>	345257	<b>Ref. No.</b>	RX94810935
<b>description</b>	microswitch with lever 250V 16A 1CO connection male faston 6.3mm L 29mm L1 33mm ambient temperature max. 120°C mounting distance 22mm actuating force: 130g lever length 31.5mm		



			
1			
<b>GEV No.</b>	345345	<b>Ref. No.</b>	94805348 RX94805348
<b>description</b>	microswitch with lever 250V 16A 1CO connection male faston 6.3mm L 78mm ambient temperature max. 85°C mounting distance 22mm type X662-88-J27 actuating force: 40g lever length 69mm		

			
1			
<b>GEV No.</b>	345311	<b>Ref. No.</b>	94803293 RX94803293
<b>description</b>	microswitch with lever 250V 16A 1NO connection male faston 6.3mm ambient temperature max. 85°C type TYFE22 lever length 41mm		

<b>pin-plunger actuated</b>			
<b>M12</b>			
			
1			
<b>GEV No.</b>	345350	<b>Ref. No.</b>	RX94806130
<b>description</b>	microswitch with plunger mounting distance 22mm thread M12x0.75 thread L 16mm 250V 16A 1CO connection male faston 6.3mm stroke 4mm ambient temperature max. 125°C type EF83161.3 actuating force: 66g		
<b>accessories for</b>	345350		
	<b>GEV No.</b>	345351	<b>Ref. No.</b> —
	nut thread M12x0.75 H 1.6mm WS 14 chrome-plated brass Qty 1 pcs		







M16			
 <p>1</p>			
<b>GEV No.</b>	345047	<b>Ref. No.</b>	RX94050119
<b>description</b>	microswitch with plunger thread M16x1 thread L 27mm 250V 5A 1NO connection cable stroke 5mm ambient temperature max. 85°C with cable type 837333 actuating force: 400g		
<b>accessories for</b>	345047		
 <p>cover ED ø 17mm suitable for 345047</p>			
<b>GEV No.</b>	698490	<b>Ref. No.</b>	RX94029824

roller actuated			
roller 90°			
 <p>1</p>			
<b>GEV No.</b>	347096	<b>Ref. No.</b>	94807229 RX94807229
<b>description</b>	microswitch with roller plunger 250V 20A 1CO connection screw L1 49mm ambient temperature max. 125°C thread L 14.5mm thread M12x1 mounting distance 25mm actuating force: 370g type Z15G1318		

position switches			
PIZZATO			
FD series			
 <p>1</p>			
<b>GEV No.</b>	345075	<b>Ref. No.</b>	94813727 94813807 RX94813727 RX94813807
<b>description</b>	position switch cast aluminum 1NO/1NC 400V 3A L 141mm W 40mm H 35mm protection IP67 actuating force: 300g screw connection PG13.5 mounting distance 30x60mm type FD503		

FR series			
 <p>1</p>			
<b>GEV No.</b>	345181	<b>Ref. No.</b>	94807872 RX94807872
<b>description</b>	position switch plastic 1NC/1NO 400V 3A L 92mm W 31mm H 31mm protection IP67 actuating force: 450g screw connection PG13.5 mounting distance 22mm screw		

miscellaneous			
 <p>1</p>			
<b>GEV No.</b>	348022	<b>Ref. No.</b>	RX94019163
<b>description</b>	safety switch plastic 1NO/1NC 600V 10A L 44mm W 23mm H 35mm protection IP44 actuating force: 53g screw connection mounting distance 25mm type XC1ZP2905 SCHNEIDER ELECTRIC		

system switches (ROLD)			
 <p>1</p>			
<b>GEV No.</b>	346201	<b>Ref. No.</b>	94804119 RX94804119
<b>description</b>	element holder mounting measurements 28.5x77.5mm grey three-fold element holder		

 <p>1</p>			
<b>GEV No.</b>	345601	<b>Ref. No.</b>	94813812 RX94813812
<b>description</b>	indicator lamp holder V ø 11mm		

 <p>1</p>			
<b>GEV No.</b>	345546	<b>Ref. No.</b>	RX94813820
<b>description</b>	momentary switch unit 1CO 250V 16A connection male faston 6.3mm		

 <p>1</p>			
<b>GEV No.</b>	347193	<b>Ref. No.</b>	94810898 RX94810898
<b>description</b>	momentary switch unit 1NO 250V 16A connection male faston 6.3mm		



			
1			
<b>GEV No.</b>	346816	<b>Ref. No.</b>	94804127 RX94804127
<b>description</b>	push button ø 23mm black		

			
1			
<b>GEV No.</b>	347590	<b>Ref. No.</b>	RX94814065
<b>description</b>	push button size 23x23mm green drain pump		



			
1			
<b>GEV No.</b>	346221	<b>Ref. No.</b>	RX94814066
<b>description</b>	push button size 23x23mm green ON-OFF with lens		

			
1			
<b>GEV No.</b>	345605	<b>Ref. No.</b>	94804143 94810976 RX94804143 RX94810976
<b>description</b>	switch 2CO 250V 16A connection male faston 6.3mm		

## cam switches

## on/off

			
1			
<b>GEV No.</b>	300088	<b>Ref. No.</b>	94805363 RX94805363
<b>description</b>	cam switch 2 operating positions 4NO sequence 0-1 16A shaft ø 6x4.6mm shaft L 23mm connection male faston 6.3mm ceramic		

			
1			
<b>GEV No.</b>	300020	<b>Ref. No.</b>	94805256 RX94805256
<b>description</b>	cam switch 4 operating positions 2NO sequence 0-1-0-1 16A shaft ø 6x4.6mm shaft L 23mm connection screw ceramic		
<b>accessories for</b>	300020		
	<b>GEV No.</b>	110135	<b>Ref. No.</b>
			—
	rosette knob up to ø 52mm		
	<b>GEV No.</b>	110231	<b>Ref. No.</b>
			—
	knob switch 0-1-0-1 t.max.°C ø 50mm shaft ø 6x4.6mm shaft flat upper black		

			
1			
<b>GEV No.</b>	300102	<b>Ref. No.</b>	RX94014842
<b>description</b>	cam switch 4 operating positions 4NO sequence 0-1-0-1 32A shaft ø 6x4.6mm shaft L 23mm connection screw ceramic		

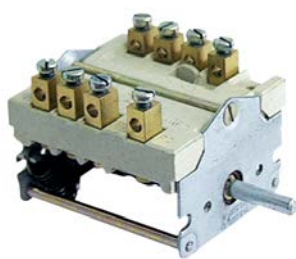
			
1			
<b>GEV No.</b>	300095	<b>Ref. No.</b>	94804994 RX94804994
<b>description</b>	cam switch ON-OFF connection screw clamp		



4-position



1

<b>GEV No.</b>	300103	<b>Ref. No.</b>	RX273349196
<b>description</b>	cam switch 4 operating positions 1NO/2CO sequence 0-1-2-3 32A shaft ø 6x4.6mm shaft L 23mm connection screw ceramic		

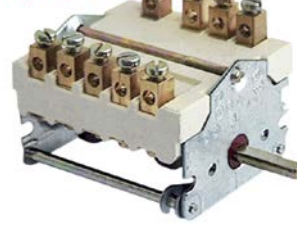

1

<b>GEV No.</b>	300106	<b>Ref. No.</b>	RX94015021
<b>description</b>	cam switch 7 operating positions 1NO/2CO sequence 0-1-2-3-4-5-6 32A shaft ø 6x4.6mm shaft L 23mm connection screw 7-position shaft flat upper		



1

<b>GEV No.</b>	300104	<b>Ref. No.</b>	RX27334937
<b>description</b>	cam switch 4 operating positions 3NO/1CO sequence 0-1-2-3 32A shaft ø 6x4.6mm shaft L 23mm connection screw ceramic		

4 operating positions



1

<b>GEV No.</b>	300049	<b>Ref. No.</b>	27338144 RX27338144
<b>description</b>	cam switch 4 operating positions 8NO sequence 0-1-2-3 16A shaft ø 6x4.6mm shaft L 17mm connection male faston 6.3mm		



7-position



1

<b>GEV No.</b>	300025	<b>Ref. No.</b>	RX94015013
<b>description</b>	cam switch 7 operating positions 1NO/2CO sequence 0-1-2-3-4-5-6 16A shaft ø 6x4.6mm shaft L 23mm connection screw 7-position ceramic		

**accessories for** 300025

	<b>GEV No.</b>	112172	<b>Ref. No.</b>	—
	knob universal ø 70mm black without adaptor/dial plate			
	<b>GEV No.</b>	112213	<b>Ref. No.</b>	—
	knob dial plate silver switch 7-position t.max.°C ED ø 63mm ID ø 45.5mm			
	<b>GEV No.</b>	112311	<b>Ref. No.</b>	—
	knob adapter shaft ø 6x4.6mm L 0mm with spring			

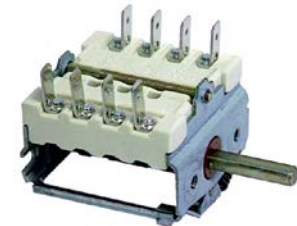

1

<b>GEV No.</b>	300184	<b>Ref. No.</b>	94806478 RX94806478
<b>description</b>	cam switch 4 operating positions sequence 0-3-2-1 shaft ø 6x4.6mm connection male faston 4-pole		

6 operating positions

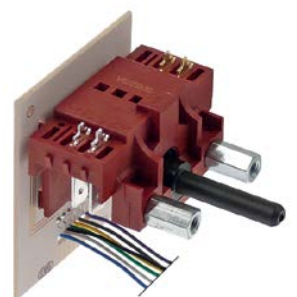

1

<b>GEV No.</b>	300051	<b>Ref. No.</b>	27338136 RX27338136
<b>description</b>	cam switch 6 operating positions 2NO sequence 1-0-2-3-4-5 6A shaft ø 6x4.6mm shaft L 33mm connection male faston 6.3mm plastic		



## with potentiometer



1

<b>GEV No.</b>	345119	<b>Ref. No.</b>	RX94814321
<b>description</b>	cam switch 2 operating positions 2NO sequence 0-1 16A shaft $\varnothing$ 6x4.6mm shaft L 23mm connection soldering connection operation switch cable lengthmm 10kOhm plastic with potentiometer		
<b>accessories for</b>	345119		
	<b>GEV No.</b>	301214	<b>Ref. No.</b> —
	cam switch 2 operating positions operation switch 16A sequence 0-1 shaft $\varnothing$ 6x4.6mm shaft L 33mm connection male faston 6.3mm plastic ambient temperature max. 150°C		

## operation switches



1

<b>GEV No.</b>	300002	<b>Ref. No.</b>	RX94806098
<b>description</b>	cam switch 2 operating positions 4NO 16A sequence 0-1 shaft $\varnothing$ 6x4.6mm shaft L 23mm connection male faston 6.3mm ceramic		



1

<b>GEV No.</b>	300166	<b>Ref. No.</b>	94805405 RX94805405
<b>description</b>	cam switch 2 operating positions 4NO 16A sequence 0-1 shaft $\varnothing$ 6x4.6mm shaft L 23mm connection male faston 6.3mm ceramic 4-pole ambient temperature max. 318°C		



1

<b>GEV No.</b>	300080	<b>Ref. No.</b>	94805892 RX94805892
<b>description</b>	cam switch 2 operating positions 4NO 16A sequence 0-1 shaft $\varnothing$ 6x4.6mm shaft L 23mm connection screw operation switch ceramic ambient temperature max. 150°C		
<b>accessories for</b>	300080		
	<b>GEV No.</b>	551456	<b>Ref. No.</b> —
	gasket for switch ED $\varnothing$ 14mm ID $\varnothing$ 2.5mm thickness 3.5mm white		



1

<b>GEV No.</b>	300200	<b>Ref. No.</b>	RX94015070
<b>description</b>	operation switch 2 operating positions 2NO 16A sequence 0-1 shaft $\varnothing$ 6x4.6mm shaft L 23mm connection male faston 6.3mm operation switch ceramic		

## rotary switches

## BREMAS

## A1200 series



1

<b>GEV No.</b>	345912	<b>Ref. No.</b>	RX94814307
<b>description</b>	rotary switch		



1

<b>GEV No.</b>	345019	<b>Ref. No.</b>	94809944 RX94809944
<b>description</b>	rotary switch sets of contacts 2 2 0-1 type CA0120002 380V 12A shaft $\varnothing$ 5x5mm shaft L 23mm shaft square connection screw		



1

<b>GEV No.</b>	345913	<b>Ref. No.</b>	RX94807120
<b>description</b>	rotary switch sets of contacts 4 4 1-2-3-4 type CS012M014 400V 12A shaft $\varnothing$ 5x5mm shaft L 23mm shaft square with knob connection screw		

## A1700 series



1

<b>GEV No.</b>	345007	<b>Ref. No.</b>	94813779 RX94813779
<b>description</b>	rotary switch 4 0-1-2-3 sets of contacts 6 type CS0178766 400V 20A shaft $\varnothing$ 5x5mm shaft L 25mm shaft square connection screw		





TELEMECANIQUE (Schneider Electric)



1			
<b>GEV No.</b>	300047	<b>Ref. No.</b>	27338060 RX27338060
<b>description</b>	rotary switch 4 operating positions 9-pole		

producer-specific rotary switches

DIHR / KROMO



1			
<b>GEV No.</b>	345913	<b>Ref. No.</b>	RX94807120
<b>description</b>	rotary switch sets of contacts 4 4 1-2-3-4 type CS012M014 400V 12A shaft $\varnothing$ 5x5mm shaft L 23mm shaft square with knob connection screw		

magnetic switches

36x13mm

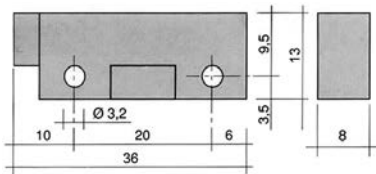

1			
<b>GEV No.</b>	345335	<b>Ref. No.</b>	RX94813862
<b>description</b>	magnetic switch L 36mm W 13mm 1NO 250V 0.04A P max. 10W connection cable cable length 960mm		
<b>accessories for</b>	345335		
	<b>GEV No.</b>	<b>Ref. No.</b>	—
	519049		
	magnet $\varnothing$ mm L 63mm H 10.7mm W 18.8mm hole distance 52mm M2 hole $\varnothing$ 2mm		

40x13mm

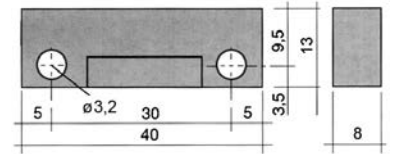

1			
<b>GEV No.</b>	345990	<b>Ref. No.</b>	94808292 RX94808292
<b>description</b>	magnetic switch L 40mm W 13mm 1NO 250V 0.04A P max. 10W connection male faston 6.3mm cable length 2000mm		

65x20mm

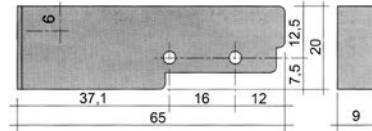

1			
<b>GEV No.</b>	345122 <sup>1</sup>	<b>Ref. No.</b>	94813853 RX94813853
<b>description</b>	magnetic switch L 65mm W 20mm 1NO 24V 8A P max. 192W connection male faston 6.3mm cable length 344mm		

<sup>1</sup>with coded connector

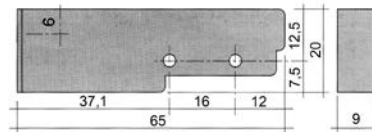
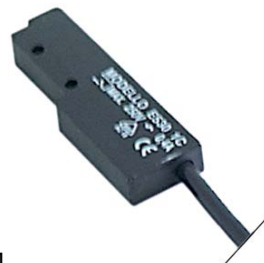

1			
<b>GEV No.</b>	345116	<b>Ref. No.</b>	RX94807161
<b>description</b>	magnetic switch L 65mm W 20mm 1NO 250V 0.4A P max. 100W connection cable cable length 3000mm		
<b>accessories for</b>	345116		
	<b>GEV No.</b>	<b>Ref. No.</b>	—
	345399		
	magnet $\varnothing$ 3.3mm L 40mm H 8mm W 13mm hole distance 30mm M3		



ø 6mm



1

<b>GEV No.</b>	345202	<b>Ref. No.</b>	94803301 RX94803301
<b>description</b>	magnetic switch 250V 0.04A P max. 10W probe L 29mm 1NO connection plug cable length 1400mm		

ø 9mm



1

<b>GEV No.</b>	345991	<b>Ref. No.</b>	RX94810835 RX94813966
<b>description</b>	magnetic switch 250V 0.04A P max. 10W probe L 30mm 1NO connection cable cable length 2000mm		

M8x0.75

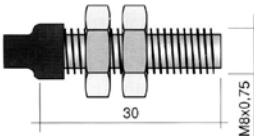



1

<b>GEV No.</b>	345631	<b>Ref. No.</b>	94803285 RX94803285
<b>description</b>	magnetic switch thread M8x0.75 1NO 250V 1A P max. 50W connection cable cable length 2000mm		

accessories

magnets



1

<b>GEV No.</b>	347702	<b>Ref. No.</b>	RX94807420
<b>description</b>	magnet H 10mm ED ø 12mm		

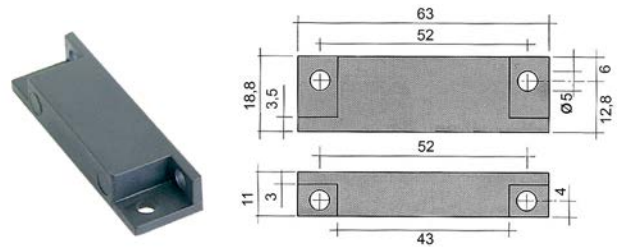

1

<b>GEV No.</b>	345336	<b>Ref. No.</b>	94809266 RX94809266
<b>description</b>	magnet ø 4.8mm L 63mm H 11mm W 18.8mm hole distance 51mm M4		

magnetic holders



1

<b>GEV No.</b>	524076	<b>Ref. No.</b>	94807410 RX94807410	
<b>description</b>	magnet holder internal size 13mm H 60mm for dishwasher			
<b>accessories for</b>	524076			
	<b>GEV No.</b>	524655	<b>Ref. No.</b>	—
	screw cap for magnet holder thread M16x1.25 SS WS 19			

control equipment

MOELLER/EATON

switches (complete)

push/momentary push switches



1

<b>GEV No.</b>	343005	<b>Ref. No.</b>	RX94062072
<b>description</b>	momentary push switch mounting measurements ø22mm black 1NO arrow momentary		

ERSCE

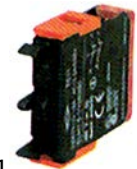

1

<b>GEV No.</b>	346659	<b>Ref. No.</b>	94808961 RX94808961
<b>description</b>	contact block ERSCE C02 2NC max 400V 10(4)A red/red		



1

<b>GEV No.</b>	346658	<b>Ref. No.</b>	94808953 RX94808953
<b>description</b>	contact block ERSCE C02 2NO max 400V 10(4)A green/green		

**JKN (Square D)**

rotary switches



1

<b>GEV No.</b>	110260	<b>Ref. No.</b>	27338078 RX27338078
<b>description</b>	rotary selector mounting measurements ø22mm		
<b>accessories for</b>	110260		
		<b>GEV No.</b>	110261
		<b>Ref. No.</b>	—
	rotary selector		

**TELEMECANIQUE (EFA)**

XB2 series  
switches (complete)



1

<b>GEV No.</b>	345933	<b>Ref. No.</b>	94800893 RX94800893
<b>description</b>	rotary selector mounting measurements ø22mm		

rotary switches



1

<b>GEV No.</b>	345223	<b>Ref. No.</b>	94800885 RX94800885
<b>description</b>	rotary selector mounting measurements ø22mm black latching sequence 1-0-2		

XB4 series



1

<b>GEV No.</b>	347497	<b>Ref. No.</b>	RX94808979
<b>description</b>	contact block 2NC colour coding red		



1

<b>GEV No.</b>	347496	<b>Ref. No.</b>	94808987 RX94808987
<b>description</b>	contact block 2NO colour coding green		

signal element



1

<b>GEV No.</b>	347700	<b>Ref. No.</b>	RX94810587
<b>description</b>	signal element mounting measurements ø22mm green metal		



1

<b>GEV No.</b>	347730	<b>Ref. No.</b>	94814003 RX94814003
<b>description</b>	signal element mounting measurements ø22mm metal		



1

<b>GEV No.</b>	347727	<b>Ref. No.</b>	RX94810579
<b>description</b>	signal element mounting measurements ø22mm red metal		



1

<b>GEV No.</b>	347728	<b>Ref. No.</b>	RX94810561
<b>description</b>	signal element mounting measurements ø22mm yellow metal		



## ZB2 series

## push buttons



1

<b>GEV No.</b>	347934	<b>Ref. No.</b>	94801909 RX94801909
<b>description</b>	push button mounting measurements ø22mm black		

## miscellaneous



1

<b>GEV No.</b>	347698	<b>Ref. No.</b>	94808656 RX94808656
<b>description</b>	push button mounting measurements ø22mm black metal		



1

<b>GEV No.</b>	347699	<b>Ref. No.</b>	94809399 RX94809399
<b>description</b>	rotary selector mounting measurements ø22mm black metal		

## lamps



1

<b>GEV No.</b>	359807	<b>Ref. No.</b>	RX94809894
<b>description</b>	light bulb socket Ba9s 24V 2W ø 10mm L 28mm clear		

## encoders and potentiometers



1

<b>GEV No.</b>	345119	<b>Ref. No.</b>	RX94814321
<b>description</b>	cam switch 2 operating positions 2NO sequence 0-1 16A shaft ø 6x4.6mm shaft L 23mm connection soldering connection operation switch cable lengthmm 10kOhm plastic with potentiometer		
<b>accessories for</b>	345119		
	<b>GEV No.</b>	301214	<b>Ref. No.</b> —
	cam switch 2 operating positions operation switch 16A sequence 0-1 shaft ø 6x4.6mm shaft L 33mm connection male faston 6.3mm plastic ambient temperature max. 150°C		



1

<b>GEV No.</b>	401338	<b>Ref. No.</b>	RX94814233
<b>description</b>	encoder		



1

<b>GEV No.</b>	403273	<b>Ref. No.</b>	94813831 RX94813831
<b>description</b>	encoder rotation 135° shaft ø 6mm shaft L 5mm cycle ø 26mm		



1

<b>GEV No.</b>	300247	<b>Ref. No.</b>	94050333 RX94050333
<b>description</b>	potentiometer 2.2KOhm rotation 270° shaft ø 6mm shaft L 16mm thread M10x0.75 plug type coded cable length 150mm		

## lamps

## indicator lights

## indicator lights 2-piece (lens and indicator lamp)

indicator lamps for socket type SRZ / SDK / SDY / SFK



1

<b>GEV No.</b>	359130	<b>Ref. No.</b>	94801073 94809845 RX94801073 RX94809845
<b>description</b>	indicator lamp 230V clear connection male faston 6.3mm ø 8mm		





1

<b>GEV No.</b>	359132	<b>Ref. No.</b>	94813811 RX94813811
<b>description</b>	indicator lamp green 250V connection male faston 6.3mm protection IP54 ambient temperature max. 85°C		













indicator lights 3-piece (housing, lens and bulb)			
lamps			
light bulbs			
			
1			
<b>GEV No.</b>	359598	<b>Ref. No.</b>	27610302 RX27610302
<b>description</b>	light bulb socket Ba15d 230V 5-7W ø 16mm L 35mm		

			
1			
<b>GEV No.</b>	359608	<b>Ref. No.</b>	27610153 RX27610153
<b>description</b>	light bulb socket E14 10/15W 230V ø 16mm L 51mm lens L 31mm Qty 1 pcs		

			
1			
<b>GEV No.</b>	359597	<b>Ref. No.</b>	27610286 RX27610286
<b>description</b>	light bulb socket T10 24V 2W ø 10mm L 28mm		

			
1			
<b>GEV No.</b>	359807	<b>Ref. No.</b>	RX94809894
<b>description</b>	light bulb socket Ba9s 24V 2W ø 10mm L 28mm clear		

neon light bulbs			
			
1			
<b>GEV No.</b>	359585	<b>Ref. No.</b>	RX27610179
<b>description</b>	neon light bulb socket E10 230V green ø 10mm L 28mm		
<b>accessories for</b>	359585		
	<b>GEV No.</b>	359060	<b>Ref. No.</b> —
lamp socket mounting measurements ø16.2mm socket E10 connection screw			
	<b>GEV No.</b>	359685	<b>Ref. No.</b> —
lamp socket mounting measurements ø16.2mm socket E10			

			
1			
<b>GEV No.</b>	359000	<b>Ref. No.</b>	RX94801891
<b>description</b>	neon light bulb socket Ba9s 24V 3W clear ø 10mm L 24mm		
<b>accessories for</b>	359000		
	<b>GEV No.</b>	359060	<b>Ref. No.</b> —
lamp socket mounting measurements ø16.2mm socket E10 connection screw			
	<b>GEV No.</b>	359063	<b>Ref. No.</b> —
lamp socket mounting measurements ø19.2mm socket E14 connection screw			
	<b>GEV No.</b>	359064	<b>Ref. No.</b> —
lamp socket mounting measurements ø22.3mm socket E14 connection screw 250/380V ambient temperature at 1W 100°C ambient temperature at 2W 85°C			
	<b>GEV No.</b>	359685	<b>Ref. No.</b> —
lamp socket mounting measurements ø16.2mm socket E10			
	<b>GEV No.</b>	359832	<b>Ref. No.</b> —
lamp socket mounting measurements ø16.2mm socket Ba9s connection male faston 6.3mm			
	<b>GEV No.</b>	359853	<b>Ref. No.</b> —
lamp socket mounting measurements ø18.2mm socket Ba9s connection male faston 6.3mm			
	<b>GEV No.</b>	359988	<b>Ref. No.</b> —
lamp socket mounting measurements ø30.5mm 250V connection F6.3 temp.-resist. 55°C E14			

indicator lights (complete)			
ø10mm			
with screw socket			
			
1			
<b>GEV No.</b>	360111	<b>Ref. No.</b>	94808722 RX94808722
<b>description</b>	indicator light ø 10mm 24V red cable length 200mm socket screw base		

			
1			
<b>GEV No.</b>	360502	<b>Ref. No.</b>	94808730 RX94808730
<b>description</b>	indicator light ø 10mm 24V yellow cable length 200mm socket screw base		

with plug-in socket			
			
1			
<b>GEV No.</b>	359140	<b>Ref. No.</b>	94812468 RX94812468
<b>description</b>	indicator light ø 10mm yellow 230V connection male faston 6.3mm Qty 1 pcs		

ø12mm

with screw socket

			
1			
<b>GEV No.</b>	359048	<b>Ref. No.</b>	RX94806353
<b>description</b>	indicator light ø 12mm 230V yellow connection male faston 6.3mm		

			
1			
<b>GEV No.</b>	359291	<b>Ref. No.</b>	RX94806346
<b>description</b>	indicator light ø 12mm 400V green connection male faston 6.3mm		

			
1			
<b>GEV No.</b>	359893	<b>Ref. No.</b>	RX94005832
<b>description</b>	indicator light ø 12mm 400V green connection cable 200mm		

ø13mm

with plug-in socket

			
1			
<b>GEV No.</b>	359045	<b>Ref. No.</b>	94801529 RX94801529
<b>description</b>	indicator light ø 13mm clear 230V connection male faston 6.3mm temp.-resist. 120°C Qty 1 pcs		

			
1			
<b>GEV No.</b>	359141	<b>Ref. No.</b>	94801511 RX94801511
<b>description</b>	indicator light ø 13mm red 230V connection male faston 6.3mm temp.-resist. 120°C Qty 1 pcs		

			
1			
<b>GEV No.</b>	359143	<b>Ref. No.</b>	94801537 RX94801537
<b>description</b>	indicator light ø 13mm yellow 230V connection male faston 6.3mm temp.-resist. 120°C Qty 1 pcs		

28.5x28.5mm

lamps (complete)

			
1			
<b>GEV No.</b>	345978	<b>Ref. No.</b>	94808474 RX94808474
<b>description</b>	indicator light mounting measurements 28.5x28.5mm 230V green		

			
1			
<b>GEV No.</b>	345926	<b>Ref. No.</b>	94801404 RX94801404
<b>description</b>	indicator light housings mounting measurements 28.5x28.5mm orange connection cycle		

			
1			
<b>GEV No.</b>	345927	<b>Ref. No.</b>	94801370 RX94801370
<b>description</b>	indicator light housings mounting measurements 28.5x28.5mm red level		

			
1			
<b>GEV No.</b>	359799	<b>Ref. No.</b>	94801065 RX94801065
<b>description</b>	indicator light housings mounting measurements 28.5x28.5mm red		

			
1			
<b>GEV No.</b>	359798	<b>Ref. No.</b>	94801057 RX94801057
<b>description</b>	indicator light housings mounting measurements 28.5x28.5mm yellow		





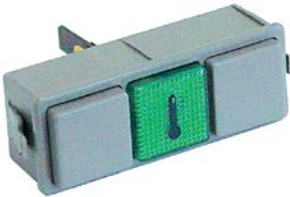

**28.5x77.5mm**



 <p>1</p>			
<b>GEV No.</b>	345873	<b>Ref. No.</b>	94810280 RX94810280
<b>description</b>	indicator light mounting measurements 28.5x77.5mm 230V green connection male faston 6.3mm protection IP40 ambient temperature max. 85°C		



**30x22mm**





 <p>1</p>			
<b>GEV No.</b>	345985	<b>Ref. No.</b>	94809498 RX94809498
<b>description</b>	indicator light mounting measurements 30x22mm 230V green		
<b>accessories for</b>	345985		
		<b>GEV No.</b>	301036 <b>Ref. No.</b> —
	protective cover internal size 30x22mm for rocker switch mounting measurementsmm		

**screw-on/push-on fit**

**neon light bulbs**

 <p>1</p>			
<b>GEV No.</b>	359585	<b>Ref. No.</b>	RX27610179
<b>description</b>	neon light bulb socket E10 230V green ø 10mm L 28mm		
<b>accessories for</b>	359585		
		<b>GEV No.</b>	359060 <b>Ref. No.</b> —
	lamp socket mounting measurements ø16.2mm socket E10 connection screw		
		<b>GEV No.</b>	359685 <b>Ref. No.</b> —
	lamp socket mounting measurements ø16.2mm socket E10		

 <p>1</p>			
<b>GEV No.</b>	359000	<b>Ref. No.</b>	RX94801891
<b>description</b>	neon light bulb socket Ba9s 24V 3W clear ø 10mm L 24mm		
<b>accessories for</b>	359000		
		<b>GEV No.</b>	359060 <b>Ref. No.</b> —
	lamp socket mounting measurements ø16.2mm socket E10 connection screw		
		<b>GEV No.</b>	359063 <b>Ref. No.</b> —
	lamp socket mounting measurements ø19.2mm socket E14 connection screw		

<b>accessories for</b>	359000		
		<b>GEV No.</b>	359064 <b>Ref. No.</b> —
	lamp socket mounting measurements ø22.3mm socket E14 connection screw 250/380V ambient temperature at 1W 100°C ambient temperature at 2W 85°C		
		<b>GEV No.</b>	359685 <b>Ref. No.</b> —
	lamp socket mounting measurements ø16.2mm socket E10		
		<b>GEV No.</b>	359832 <b>Ref. No.</b> —
	lamp socket mounting measurements ø16.2mm socket Ba9s connection male faston 6.3mm		
		<b>GEV No.</b>	359853 <b>Ref. No.</b> —
	lamp socket mounting measurements ø18.2mm socket Ba9s connection male faston 6.3mm		
		<b>GEV No.</b>	359988 <b>Ref. No.</b> —
	lamp socket mounting measurements ø30.5mm 250V connection F6.3 temp.-resist. 55°C E14		

**light bulbs**

**for ovens**

 <p>1</p>			
<b>GEV No.</b>	359610	<b>Ref. No.</b>	RX27610120
<b>description</b>	light bulb t.max. 300°C socket E14 15W 230V ø 22mm L 47mm lens L 20mm for oven lamp type Philips		

**for indicator lights**

 <p>1</p>			
<b>GEV No.</b>	359598	<b>Ref. No.</b>	27610302 RX27610302
<b>description</b>	light bulb socket Ba15d 230V 5-7W ø 16mm L 35mm		

 <p>1</p>			
<b>GEV No.</b>	359608	<b>Ref. No.</b>	27610153 RX27610153
<b>description</b>	light bulb socket E14 10/15W 230V ø 16mm L 51mm lens L 31mm Qty 1 pcs		

 <p>1</p>			
<b>GEV No.</b>	359597	<b>Ref. No.</b>	27610286 RX27610286
<b>description</b>	light bulb socket T10 24V 2W ø 10mm L 28mm		



<b>GEV No.</b>	359807	<b>Ref. No.</b>	RX94809894
<b>description</b>	light bulb socket Ba9s 24V 2W ø 10mm L 28mm clear		

### oven lamps

#### universal oven lamps

mounting diameter 35.5mm

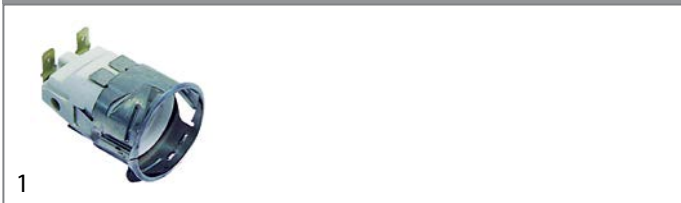

<b>GEV No.</b>	359701	<b>Ref. No.</b>	27610104 RX27610104
<b>description</b>	lamp socket socket E14 220-230V mounting ø 35.5mm connection male faston 6.3mm 15W		

accessories for 359701

	<b>GEV No.</b>	359705	<b>Ref. No.</b>	—
oven lamp glass thr.ø 33.5mm ø 52mm hard glas temp.-resist. 350°C				

	<b>GEV No.</b>	359709	<b>Ref. No.</b>	RX27610112
oven lamp glass thr.ø 33.5mm ø 42mm hard glas temp.-resist. 350°C				

	<b>GEV No.</b>	359721	<b>Ref. No.</b>	RX24390700
gasket silicone ED ø 48mm ID ø 39.5mm thickness 5mm Qty 1 pcs				

	<b>GEV No.</b>	359942	<b>Ref. No.</b>	—
oven lamp glass thr.ø 33.5mm ø 41mm hard glas temp.-resist. 350°C				

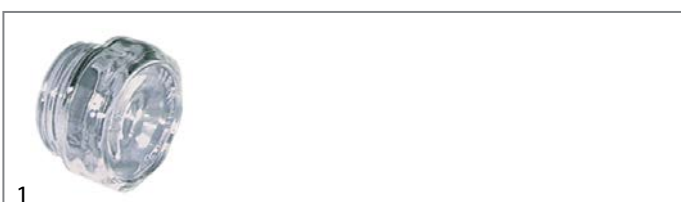

<b>GEV No.</b>	359709	<b>Ref. No.</b>	RX27610112
<b>description</b>	oven lamp glass thr.ø 33.5mm ø 42mm hard glas temp.-resist. 350°C		



<b>GEV No.</b>	359721	<b>Ref. No.</b>	RX24390700
<b>description</b>	gasket silicone ED ø 48mm ID ø 39.5mm thickness 5mm Qty 1 pcs		

### 55x70mm



<b>GEV No.</b>	359375	<b>Ref. No.</b>	94814234 RX94814234
<b>description</b>	lamp socket complete without lamp socket E14 mounting measurements 55x70mm		

### lamps

#### light bulbs



<b>GEV No.</b>	359610	<b>Ref. No.</b>	RX27610120
<b>description</b>	light bulb t.max. 300°C socket E14 15W 230V ø 22mm L 47mm lens L 20mm for oven lamp type Philips		

### timers

#### programme timers



<b>GEV No.</b>	360273	<b>Ref. No.</b>	94807630 RX94807630
<b>description</b>	timer CDC 11803 engines 1 chambers 3 operation time 18min 230V shaft ømm shaft Lmm manif. no. 11803F1 / 16064/A motor type M48R ATS		

spare parts for 360273

	<b>GEV No.</b>	360118	<b>Ref. No.</b>	—
motor CDC pinion ø 4.9mm teeth 10 230V voltage AC 50/60Hz turn direction right motor ø 47mm H 19.3mm motor type M48R ATS for timer cable length 260mm 1.9/2.5W				

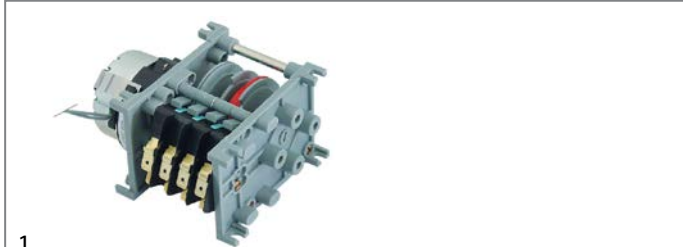

<b>GEV No.</b>	360310	<b>Ref. No.</b>	94801578 RX94801578
<b>description</b>	timer CDC 4804M engines 1 chambers 4 operation time 120s 230V shaft ømm shaft Lmm manif. no. 4804M1 / 29828 motor type M48R ATS		

spare parts for 360310

	<b>GEV No.</b>	360118	<b>Ref. No.</b>	—
motor CDC pinion ø 4.9mm teeth 10 230V voltage AC 50/60Hz turn direction right motor ø 47mm H 19.3mm motor type M48R ATS for timer cable length 260mm 1.9/2.5W				





1

<b>GEV No.</b>	360389	<b>Ref. No.</b>	94813971 RX94813971
<b>description</b>	timer CDC 4904F engines 1 chambers 4 operation time 5min 230V shaft ømm shaft Lmm manuf. no. 4904F3 / 10300122 motor type M48L ATS		
<b>spare parts for</b>	360389		
	<b>GEV No.</b>	360083	<b>Ref. No.</b> —
	motor CDC pinion ø 4.9mm teeth 10 230V turn direction left motor ø 47mm H 19.3mm motor type M48L ATS for timer		





1

<b>GEV No.</b>	360308	<b>Ref. No.</b>	94802634 RX94802634
<b>description</b>	timer CDC 7803 engines 1 chambers 3 operation time 18min 230V shaft ømm shaft Lmm manuf. no. 7803F1 / 26880 motor type M37RN		
<b>spare parts for</b>	360308		
	<b>GEV No.</b>	360119	<b>Ref. No.</b> —
	motor CDC pinion ø 5.4mm teeth 12 230V turn direction right motor ø 37mm motor type M37RN for timer		





1

<b>GEV No.</b>	360133	<b>Ref. No.</b>	94803921 RX94803921
<b>description</b>	timer CDC 7804DV engines 2 chambers 4 operation time 60s / 20min 230V shaft ømm shaft Lmm manuf. no. 7804DV / 360133 motor type M37RN/M37LN		
<b>spare parts for</b>	360133		
	<b>GEV No.</b>	360119	<b>Ref. No.</b> —
	motor CDC pinion ø 5.4mm teeth 12 230V turn direction right motor ø 37mm motor type M37RN for timer		
	<b>GEV No.</b>	360131	<b>Ref. No.</b> —
	motor CDC pinion ø 5.4mm teeth 12 230V turn direction left motor ø 37mm motor type M37LN for timer		



1

<b>GEV No.</b>	360293	<b>Ref. No.</b>	94810896 RX94810896
<b>description</b>	timer CDC 7804DV engines 2 chambers 4 operation time 6s / 3min 230V shaft ømm shaft Lmm manuf. no. 7804DV / 30001027 motor type M37RN/M37LN		
<b>spare parts for</b>	360293		
	<b>GEV No.</b>	360119	<b>Ref. No.</b> —
	motor CDC pinion ø 5.4mm teeth 12 230V turn direction right motor ø 37mm motor type M37RN for timer		
	<b>GEV No.</b>	360131	<b>Ref. No.</b> —
	motor CDC pinion ø 5.4mm teeth 12 230V turn direction left motor ø 37mm motor type M37LN for timer		





1

<b>GEV No.</b>	360077	<b>Ref. No.</b>	94807620 RX94807620
<b>description</b>	timer CROUZET engines 1 chambers 2 operation time 120s 230V shaft ømm shaft Lmm manuf. no. 627/5261 motor type 82340		



1

<b>GEV No.</b>	360435	<b>Ref. No.</b>	RX94807112
<b>description</b>	timer FIBER P25 engines 1 chambers 4 operation time 6min 230V 50Hz shaft ømm shaft Lmm motor type M51BJ0L6400		
<b>spare parts for</b>	360435		
	<b>GEV No.</b>	360674	<b>Ref. No.</b> —
	motor kit pinion ø 6.8mm teeth 15 230V voltage AC 50/60Hz turn direction counterclockwise motor ø 48mm H 18.5mm motor type UDS40NE1RNZ165 cable length 150mm with holder		



1

<b>GEV No.</b>	360086	<b>Ref. No.</b>	94813748 RX94813748
<b>description</b>	timer FIBER P26 engines 1 chambers 4 operation time 120s 230V shaft ø6mm shaft Lmm manif. no. P265J04H315 motor type M61B40R6400		



1

<b>GEV No.</b>	360036	<b>Ref. No.</b>	94801412 RX94801412
<b>description</b>	timer FIBER P39 engines 1 chambers 3 operation time 120s 230V shaft ø 6x4.6mm shaft L 16mm manif. no. P395J03H301 motor type M51BJ0L6400		
<b>spare parts for</b>	360036		
	<b>GEV No.</b>	360674	<b>Ref. No.</b> —
	motor kit pinion ø 6.8mm teeth 15 230V voltage AC 50/60Hz turn direction counterclockwise motor ø 48mm H 18.5mm motor type UDS40NE1RNZ165 cable length 150mm with holder		

electric timers



1

<b>GEV No.</b>	350001	<b>Ref. No.</b>	27298066 RX27298066
<b>description</b>	timer 2CO at 250V 16A permanent position yes impulse electric shaft ø 6x4.6mm shaft L 22mm mounting distance 28mm connection rear 2-pole operation time 120min		

with time spread



1

<b>GEV No.</b>	350074	<b>Ref. No.</b>	RX27298215
<b>description</b>	timer MS65 operation time 120min time spread 30min 1CO/2NO/1NC at 250V 16A permanent position yes impulse electric shaft ø 6x4.6mm shaft L 22mm mounting distance 28mm connection lateral Invensys 4-pole shaft position lower°		

mechanical timers



1

<b>GEV No.</b>	350095	<b>Ref. No.</b>	RX94027836
<b>description</b>	timer C53 4-pole operation time 120min impulse mechanical 2NO/2NC at 250V 16A permanent position no shaft ø6mm shaftmm shaft L 24mm mounting distance 28mm connection lateral front measurements 72x72mm		



1

<b>GEV No.</b>	350093	<b>Ref. No.</b>	RX94027869
<b>description</b>	timer C53 4-pole operation time 30min impulse mechanical 2NO/2NC at 250V 16A permanent position no shaft ø6mm shaftmm shaft L 24mm mounting distance 28mm connection lateral front measurements 72x72mm		

alarm devices

buzzers



1

<b>GEV No.</b>	350050	<b>Ref. No.</b>	94027794 RX94027794
<b>description</b>	buzzer 230VAC connection male faston 6.3mm screw mounting thread M4 60dB		





contactors

GENERAL ELECTRIC (AEG)

power contactors

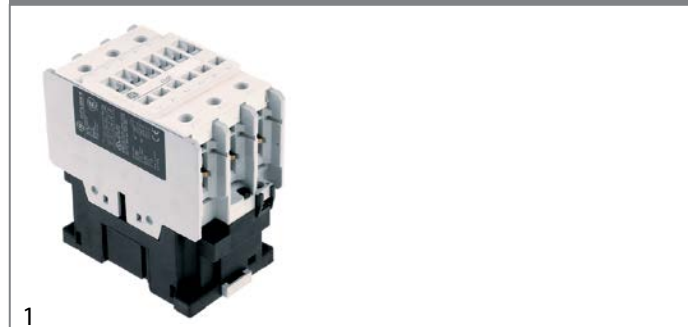

1			
<b>GEV No.</b>	380267	<b>Ref. No.</b>	27400308 RX27400308
<b>description</b>	power contactor resistive load 110A 230VAC (AC3/400V) 65A/30kW main contacts 3NO auxiliary contacts connection screw connection type AEG LS30K 00A type GE CL07A 300		
<b>accessories for</b>	380267		
	<b>GEV No.</b>	380268	<b>Ref. No.</b> —
	auxiliary contact contacts 1NO for contactors CL+LS_K connection screw AC-12 10A type AEG HS07K 10 type GE BCLF 10		
	<b>GEV No.</b>	380269	<b>Ref. No.</b> —
	auxiliary contact contacts 1NC AC15 6A for contactors CL+LS_K connection screw AC-12 10A type AEG HS07K 01 type GE BCLF 01		
	<b>GEV No.</b>	380270	<b>Ref. No.</b> —
	auxiliary contact contacts 1NO/1NC for contactors CL+LS_K connection screw AC-12 10A type AEG HS08K 11 type GE BCLL 11		
	<b>GEV No.</b>	380271	<b>Ref. No.</b> —
	auxiliary contact contacts 2NO for contactors CL+LS_K connection screw AC-12 10A type AEG HS08K 20 type GE BCLL 20		

1			
<b>GEV No.</b>	380239	<b>Ref. No.</b>	94804408 94813830 RX94804408 RX94813830
<b>description</b>	power contactor resistive load 20A 230VAC (AC3/400V) 8.4A/4kW main contacts 3NO auxiliary contacts 1NC connection screw connection type LS05 01A type AEG LS05 01A type GE MC1A 301A		

1			
<b>GEV No.</b>	380238	<b>Ref. No.</b>	94814048 RX94814048
<b>description</b>	power contactor resistive load 20A 230VAC (AC3/400V) 8.4A/4kW main contacts 3NO auxiliary contacts 1NO connection screw connection type LS0510A type AEG LS0510A type GE MC1A 310A		

1			
<b>GEV No.</b>	380839	<b>Ref. No.</b>	94808698 RX94808698
<b>description</b>	power contactor resistive load 20A 24VAC (AC3/400V) 9A/4kW main contacts 3NO auxiliary contacts 1NO connection screw connection type LS0510A type AEG LS0510A type GE MC1A 310A		

1			
<b>GEV No.</b>	380244	<b>Ref. No.</b>	27400324 RX27400324
<b>description</b>	power contactor resistive load 25A 230VAC (AC3/400V) 9A/4kW main contacts 3NO auxiliary contacts 1NO connection screw connection type AEG LS4K 10A type GE CL00A 310		

1			
<b>GEV No.</b>	381136	<b>Ref. No.</b>	94808920 RX94808920
<b>description</b>	power contactor resistive load 25A 24VAC (AC3/400V) 12A/5.5kW main contacts 3NO auxiliary contacts 1NO connection screw connection type AEG type GE CL01A310T1		

1			
<b>GEV No.</b>	380671	<b>Ref. No.</b>	94808938 RX94808938
<b>description</b>	power contactor resistive load 45A 24VAC (AC3/400V) 25A/11kW main contacts 3NO auxiliary contacts connection screw connection type AEG LS11K 00A type GE CL25A300T1		

1 electric components





1

<b>GEV No.</b>	380265	<b>Ref. No.</b>	27400282 RX27400282
<b>description</b>	power contactor resistive load 60A 230VAC (AC3/400V) 32A/16kW main contacts 3NO auxiliary contacts 1NO connection screw connection type AEG LS15K 00A type GE CL04A 310 H 98mm L 87mm W 55mm		



1

<b>GEV No.</b>	380266	<b>Ref. No.</b>	27400290 RX27400290
<b>description</b>	power contactor resistive load 90A 230VAC (AC3/400V) 22kW main contacts 3NO connection screw type AEG LS22K 00A type GE CL06A 300		

motor protection circuit breakers



1

<b>GEV No.</b>	380940	<b>Ref. No.</b>	94810902 RX94810902
<b>description</b>	motor protection circuit breaker type GPS1BSAH setting range 2.5-4A DIN rail contacts screw clamp		



1

<b>GEV No.</b>	380939	<b>Ref. No.</b>	94814091 RX94814091
<b>description</b>	motor protection circuit breaker type GPS1BSAJ setting range 4-6.3A DIN rail connection screw		

LOVATO

power contactors



1

<b>GEV No.</b>	380964	<b>Ref. No.</b>	94807062 RX94807062
<b>description</b>	power contactor resistive load 20A 230VAC (AC3/400V) 9A/4kW main contacts 4NO auxiliary contacts connection screw connection type 11BG09T4A230		

TELEMECANIQUE (Schneider Electric)

power contactors



1

<b>GEV No.</b>	380979	<b>Ref. No.</b>	RX94019155
<b>description</b>	power contactor resistive load 40A 230VAC (AC3/400V) 25A/11kW main contacts 3NO auxiliary contacts 1NO/1NC connection screw connection type LC1D25P7		



relays

power relays

with DIN rail mounting

upper



1

<b>GEV No.</b>	380180	<b>Ref. No.</b>	RX94814289
<b>description</b>	power relays FINDER 230VAC 16A 3CO connection male faston 6.3mm DIN rail manuf. no. 62.83.8.230.4007		

with bracket mounting



1

<b>GEV No.</b>	380312	<b>Ref. No.</b>	94804291 RX94804291
<b>description</b>	power relays FINDER 230VAC 10A 3CO connection male faston 4.8mm bracket mounting dimensions 52x32.2x36.5mm manuf. no. 60.63.8.230.0000		



1

<b>GEV No.</b>	380139	<b>Ref. No.</b>	94807054 94813866 RX94807054 RX94813866
<b>description</b>	power relays FINDER 230VAC 16A 2CO connection F6.3 bracket mounting dimensions 68x38.2x35.8mm manuf. no. 62.82.8.230.0000		



1

<b>GEV No.</b>	380311	<b>Ref. No.</b>	94804853 RX94804853
<b>description</b>	power relays Italiana Relè 230VAC 20A 1NC/1NO connection F6.3 bracket mounting manuf. no. A1B-230AC-FA		

plug-in/print relays

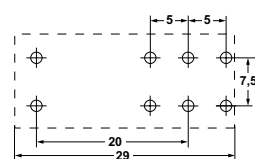

1

<b>GEV No.</b>	381151	<b>Ref. No.</b>	94807070 RX94807070
<b>description</b>	print relay 24VAC 2CO 2-pole at 250V 8A connection pins raster size 5mm FINDER manuf. no. 40.52.8.024.0000 95.65/95.75		

relay sockets



1

<b>GEV No.</b>	380137	<b>Ref. No.</b>	94800943 RX94800943
<b>description</b>	relay socket 8-pole connection plug-in connection round 8-pole dimensions 65x28x40mm 380V voltage AC 10A Italiana Relè manuf. no. ZVE8		
<b>accessories for</b>	380137		
	<b>GEV No.</b>	380805	<b>Ref. No.</b>
			—
	support bracket		



level relays

GICAR



<b>GEV No.</b>	400048	<b>Ref. No.</b>	94801545 RX94801545
<b>description</b>	level relay 1CO 230V voltage AC connection plug-in connection round 8-pole type 27434		

time relays

time relays



<b>GEV No.</b>	360465	<b>Ref. No.</b>	RX94802766
<b>description</b>	time relay FIBER T45 time range 0s-120h 230VAC 5/2A mounting measurements 45x45mm 2CO		
<b>accessories for</b>	360465		
	<b>GEV No.</b>	360485	<b>Ref. No.</b> —
	mounting frame L 72mm W 72mm for time relay for model E47,E48,E58,E59,T45,C58,C59		



<b>GEV No.</b>	380319	<b>Ref. No.</b>	27470236 RX27470236
<b>description</b>	time relay pickup-delayed 0.06-150s		

electronic controllers

DIXELL

refrigeration controllers

built-in version



<b>GEV No.</b>	378249	<b>Ref. No.</b>	RX94807021
<b>description</b>	electronic controller DIXELL XR20C-1P3C0 mounting measurements 71x29mm 24V voltage AC/DC NTC/PTC relay outputs 1 CO-8A(3) NTC/PTC DI protection IP54 -50 up to +150°C display 3½ digits		

electronic thermometers

built-in version



<b>GEV No.</b>	378046	<b>Ref. No.</b>	94810546 RX94810546
<b>description</b>	thermometer DIXELL XT11S mounting measurements 58x25.5mm 24V voltage AC/DC NTC 0 up to +60°C display 2½ digit 1 TempIn1 NTC DigiIn1 defr. funct. front measurements 31x64mm		

EVCO - EVERY CONTROL

universal controllers

built-in version



<b>GEV No.</b>	379029	<b>Ref. No.</b>	94806361 RX94806361
<b>description</b>	electronic controller EVERY CONTROL 230V voltage AC fryer type EC8		



miscellaneous

universal controllers

			
1			
<b>GEV No.</b>	379020	<b>Ref. No.</b>	24848236 RX24848236
<b>description</b>	electronic controller Pt100 steam control		

probes

universal probes

temperature probes

			
1			
<b>GEV No.</b>	379161	<b>Ref. No.</b>	94810538 RX94810538
<b>description</b>	temperature probe NTC 10kOhm cable thermoplastic probe -40 up to +110°C cable -40 up to +110°C probe ø6x14mm cable length 3m without screw connection 2-wire		

			
1			
<b>GEV No.</b>	379130 <sup>1</sup>	<b>Ref. No.</b>	94814231 RX94814231
<b>description</b>	temperature probe Pt100 cable Vetrotex probe -200 up to +600°C cable -50 up to +350°C probe ø6x100mm cable length 1.4m without screw connection 3-wire resistance at 0°C 1000Ohm		

<sup>1</sup>3-wire

			
1			
<b>GEV No.</b>	379199	<b>Ref. No.</b>	RX94807179
<b>description</b>	temperature probe PTC 1kOhm cable PVC probe -50 up to +150°C cable -10 up to 100°C probe ø6x30mm cable length 5m without screw connection 2-wire		

			
1			
<b>GEV No.</b>	379831	<b>Ref. No.</b>	94050341 RX94050341
<b>description</b>	temperature probe thermocouple J (Fe-CuNi) cable Vetrotex probe -50 up to +750°C cable -50 up to +350°C probe ø4x100mm cable length 1m cable colours black/white 2-wire		

producer-specific probes

probes

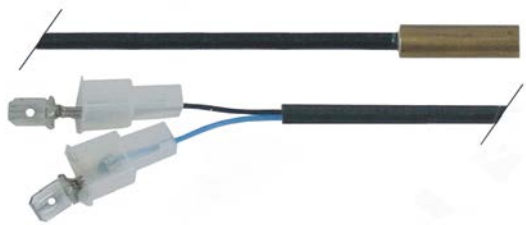
			
1			
<b>GEV No.</b>	379908	<b>Ref. No.</b>	RX94813768
<b>description</b>	temperature probe NTC		

			
1			
<b>GEV No.</b>	378314	<b>Ref. No.</b>	94814005 RX94814005
<b>description</b>	temperature probe NTC 10kOhm cable silicone probe -40 up to +110°C cable -50 up to +180°C connection coded plug thread probe ø5x30mm cable length 0.35m		

			
1			
<b>GEV No.</b>	378268	<b>Ref. No.</b>	94808763 RX94808763
<b>description</b>	temperature probe NTC cable silicone probe -40 up to +110°C cable -50 up to +180°C connection coded plug thread probe ø6x15mm cable length 1.1m		

			
1			
<b>GEV No.</b>	379075	<b>Ref. No.</b>	24849093 RX24849093
<b>description</b>	temperature probe Pt100 cable silicone probe -100 up to 450°C cable -50 up to +180°C connection 2-wire thread M6 probe ø4x100mm cable length 1.5m		

			
1			
<b>GEV No.</b>	379070	<b>Ref. No.</b>	24849036 RX24849036
<b>description</b>	temperature probe Pt100 cable silicone probe -50 up to +250°C cable -50 up to +180°C connection 2-wire thread probe ø4x75mm cable length 1.7m		

			
1			
<b>GEV No.</b>	378413	<b>Ref. No.</b>	RX94046186
<b>description</b>	temperature probe thermocouple J (Fe-CuNi) cable Vetrotex probe -50 up to +750°C cable -50 up to +350°C connection 2-wire thread probe ø3x280mm cable length 3.5m		



core probes			
1 			
<b>GEV No.</b>	381425	<b>Ref. No.</b>	24849135 24849168 RX24849135 RX24849168
<b>description</b>	core temperature probe Pt100 cable PTFE probe -40 up to +250°C cable -40 up to +250°C connection 2-wire probe ø3.2x100mm thread M12 cable length 2.8m handle ø 10mm handle length 80mm		

### electronics

#### PCBs

1 			
<b>GEV No.</b>	400107	<b>Ref. No.</b>	27450238 RX27450238
<b>description</b>	control PCB combi-steamer CM101 edition CM v. 4.91-97		

1 			
<b>GEV No.</b>	404019	<b>Ref. No.</b>	RX94035037 RX94070732
<b>description</b>	control PCB fryer 230V 50Hz heating		

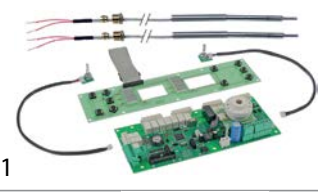
1 			
<b>GEV No.</b>	401661	<b>Ref. No.</b>	94814232 94814236 RX94814232 RX94814236
<b>description</b>	keypad PCB combi-steamer MVE04 kit		

1 			
<b>GEV No.</b>	403231	<b>Ref. No.</b>	RX94814055
<b>description</b>	keypad PCB dishwasher 80E/81E L 155mm W 100mm with display H 25mm buttons 6		

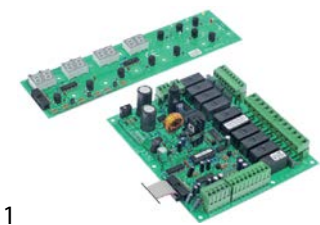
1 			
<b>GEV No.</b>	403221	<b>Ref. No.</b>	94813997 RX94813997
<b>description</b>	main PCB dishwasher AX 250/300/310/320/330 L 168mm W 148mm for display PCB Qty 1 pcs		

1 			
<b>GEV No.</b>	400110	<b>Ref. No.</b>	27450220 RX27450220
<b>description</b>	PCB combi-steamer level control		

1 			
<b>GEV No.</b>	403130	<b>Ref. No.</b>	9402358 94023587 RX94023587
<b>description</b>	PCB combi-steamer TVTS L 90mm W 70mm level control		



1

<b>GEV No.</b>	402881	<b>Ref. No.</b>	94813861 RX94813861
<b>description</b>	PCB dishwasher CE-GE L 126mm W 63mm suitable for COMENDA		



1

<b>GEV No.</b>	402677	<b>Ref. No.</b>	RX94814079
<b>description</b>	PCB dishwasher DS40/DS50 L 161mm W 90mm		



1

<b>GEV No.</b>	402676	<b>Ref. No.</b>	RX94814039
<b>description</b>	PCB dishwasher HT11/12 L 102mm W 62mm timer		



1

<b>GEV No.</b>	402695	<b>Ref. No.</b>	94813816 RX94813816
<b>description</b>	PCB dishwasher L 145mm W 105mm HOONVED		



1

<b>GEV No.</b>	698492	<b>Ref. No.</b>	873513894 RX94019130
<b>description</b>	PCB level regulator combi-steamer suitable for ROSINOX level control		

central units



1

<b>GEV No.</b>	402683	<b>Ref. No.</b>	RX94807104
<b>description</b>	control box timer operation time 3/6/9min		



1

<b>GEV No.</b>	402681	<b>Ref. No.</b>	94814285 RX94814285
<b>description</b>	control box timer run-time 50/120/180s		



1

<b>GEV No.</b>	402684	<b>Ref. No.</b>	RX94814040
<b>description</b>	control box without EPROM		



1

<b>GEV No.</b>	379026	<b>Ref. No.</b>	RX94814050
<b>description</b>	electronic timer for dishwasher		



### keypads

#### front foils



<b>GEV No.</b>	694697	<b>Ref. No.</b>	RX94044752
<b>description</b>	front foil combi-steamer TVTS suitable for ROSINOX L 600mm W 118mm		



<b>GEV No.</b>	402685	<b>Ref. No.</b>	94814049 RX94814049
<b>description</b>	keypad foil dishwasher H63/373E/144E L 134mm W 79mm buttons 6		



<b>GEV No.</b>	505300	<b>Ref. No.</b>	94034345 RX94034345
<b>description</b>	keypad foil fryer blue L 148mm W 91mm buttons 4		

#### keypad units



<b>GEV No.</b>	402913	<b>Ref. No.</b>	94814041 RX94814041
<b>description</b>	keypad unit dishwasher 37E/80E/81E/18ER/19E buttons 6 suitable for Dihr L 145mm W 90mm with cable		

### solenoid valves

#### solenoid valves (water)

ELBI			
			
1			
<b>GEV No.</b>	373020	<b>Ref. No.</b>	94809795 RX94809795
<b>description</b>	solenoid valve double angled 230VAC inlet 3/4" outlet 14mm input 10l/min DN10 t.max. 90°C duty cycle 100% ELBI flow regulating valve inlet white		

MÜLLER			
<i>medium temperature: 90°C</i>			
<i>duty cycle: 100%</i>			











with cable connection				
				
1				
<b>GEV No.</b>	370006	<b>Ref. No.</b>	RX24720054	
<b>description</b>	solenoid valve triple straight 230VAC inlet 3/4" outlet 12.5mm DN10 t.max. 90°C duty cycle 100% MÜLLER cable length 2000mm			
<b>spare parts for</b>	370006			
	<b>GEV No.</b>	370132	<b>Ref. No.</b>	—
solenoid valve body triple straight inlet 3/4" outlet 11.5mm DN10 t.max. 90°C duty cycle 100% MÜLLER 230V				
	<b>GEV No.</b>	371002	<b>Ref. No.</b>	—
solenoid valve holder MÜLLER flange support				
	<b>GEV No.</b>	371009	<b>Ref. No.</b>	—
compression spring for solenoid coil				
	<b>GEV No.</b>	371010	<b>Ref. No.</b>	—
solenoid coil 230VAC connection with cable cable length 2000mm				
	<b>GEV No.</b>	371011	<b>Ref. No.</b>	—
spare parts kit membrane with long star star hight 8mm MÜLLER				
	<b>GEV No.</b>	371122	<b>Ref. No.</b>	—
solenoid valve filter ø 19mm H 10mm suitable for MÜLLER				
	<b>GEV No.</b>	501161	<b>Ref. No.</b>	—
tap head for solenoid valve holder for solenoid coils				
<b>accessories for</b>	370006			
	<b>GEV No.</b>	371017	<b>Ref. No.</b>	—
solenoid coil MÜLLER 230VAC connection male faston 6.3mm				
	<b>GEV No.</b>	371037	<b>Ref. No.</b>	—
solenoid coil 24VAC 50/60Hz connection male faston 6.3mm				

Table continues overleaf



<b>accessories for</b>	370006		
	GEV No.	371038	Ref. No. —
	solenoid coil 230VAC connection appliance plug		

**ROBERTSHAW/INVENSYS**







medium temperature: 90°C 90°C 60°C  
 ambient temperature: 60°C 25°C 60°C  
 duty cycle: 40% 100% 100%



	1		
<b>GEV No.</b>	370371	<b>Ref. No.</b>	RX24720054
<b>description</b>	solenoid valve double straight 230VAC inlet 3/4" outlet 11.5mm DN10 EATON (INVENSYS) cable length 2000mm		

**RPE**

	1		
<b>GEV No.</b>	374060	<b>Ref. No.</b>	RX94813972
<b>description</b>	solenoid valve single angled 24V inlet 3/4" outlet 13mm DN10 duty cycle 100% RPE polyamide		

**TP**

	1		
<b>GEV No.</b>	370021	<b>Ref. No.</b>	RX94807480
<b>description</b>	solenoid valve double straight 230VAC inlet 3/4" outlet 11.5mm DN10 TP flow regulating valve inlet white		
<b>spare parts for</b>	370021		
	GEV No.	371013	Ref. No. —
	solenoid coil TP 230VAC 50/60Hz		
<b>accessories for</b>	370021		
	GEV No.	371220	Ref. No. —
	reducer TP flow rate 3l/min red tolerance ±15%		
	GEV No.	371221	Ref. No. —
	reducer TP flow rate 5.5l/min yellow tolerance ±15%		
	GEV No.	371222	Ref. No. —
	reducer TP flow rate 6l/min grey tolerance ±15%		
	GEV No.	371223	Ref. No. —
	reducer TP flow rate 10l/min white tolerance ±15%		
	GEV No.	371224	Ref. No. —
	reducer TP flow rate 12l/min bronze tolerance ±15%		

<b>accessories for</b>	370021		
	GEV No.	371225	Ref. No. —
	reducer TP flow rate 16l/min light brown tolerance ±15%		
	GEV No.	371226	Ref. No. —
	reducer TP flow rate 20l/min red tolerance ±15%		
	GEV No.	371230	Ref. No. —
	reducer TP flow rate 0.25l/min red tolerance ±25%		
	GEV No.	371231	Ref. No. —
	reducer TP flow rate 0.35l/min violet tolerance ±25%		
	GEV No.	371232	Ref. No. —
	reducer TP flow rate 0.5l/min orange tolerance ±25%		
	GEV No.	371233	Ref. No. —
	reducer TP flow rate 0.8l/min white tolerance ±25%		
	GEV No.	371234	Ref. No. —
	reducer TP flow rate 1l/min light blue tolerance ±25%		
	GEV No.	371235	Ref. No. —
	reducer TP flow rate 1.2l/min brown tolerance ±25%		
	GEV No.	371236	Ref. No. —
	reducer TP flow rate 1.5l/min light brown tolerance ±25%		
	GEV No.	371237	Ref. No. —
	reducer TP flow rate 2.5l/min yellow tolerance ±25%		
	GEV No.	371238	Ref. No. 94810058 RX94810058
	reducer TP flow rate 3.4l/min dark green tolerance ±25%		
	GEV No.	371239	Ref. No. —
	reducer TP flow rate 5l/min black tolerance ±25%		
	GEV No.	371240	Ref. No. —
	reducer TP flow rate 8l/min blue tolerance ±20%		





















	1		
<b>GEV No.</b>	370017	<b>Ref. No.</b>	94805520 RX94805520
<b>description</b>	solenoid valve single straight 230VAC inlet 3/4" outlet 11.5mm DN10 TP p max 10bar		
<b>spare parts for</b>	370017		
	GEV No.	371013	Ref. No. —
	solenoid coil TP 230VAC 50/60Hz		
<b>accessories for</b>	370017		
	GEV No.	371220	Ref. No. —
	reducer TP flow rate 3l/min red tolerance ±15%		

Table continues overleaf

accessories for		370017	
	GEV No.	371221	Ref. No. —
reducer TP flow rate 5.5l/min yellow tolerance ±15%			
	GEV No.	371222	Ref. No. —
reducer TP flow rate 6l/min grey tolerance ±15%			
	GEV No.	371223	Ref. No. —
reducer TP flow rate 10l/min white tolerance ±15%			
	GEV No.	371224	Ref. No. —
reducer TP flow rate 12l/min bronze tolerance ±15%			
	GEV No.	371225	Ref. No. —
reducer TP flow rate 16l/min light brown tolerance ±15%			
	GEV No.	371226	Ref. No. —
reducer TP flow rate 20l/min red tolerance ±15%			
	GEV No.	371230	Ref. No. —
reducer TP flow rate 0.25l/min red tolerance ±25%			
	GEV No.	371231	Ref. No. —
reducer TP flow rate 0.35l/min violet tolerance ±25%			
	GEV No.	371232	Ref. No. —
reducer TP flow rate 0.5l/min orange tolerance ±25%			
	GEV No.	371233	Ref. No. —
reducer TP flow rate 0.8l/min white tolerance ±25%			
	GEV No.	371234	Ref. No. —
reducer TP flow rate 1l/min light blue tolerance ±25%			
	GEV No.	371235	Ref. No. —
reducer TP flow rate 1.2l/min brown tolerance ±25%			
	GEV No.	371236	Ref. No. —
reducer TP flow rate 1.5l/min light brown tolerance ±25%			
	GEV No.	371237	Ref. No. —
reducer TP flow rate 2.5l/min yellow tolerance ±25%			
	GEV No.	371238	Ref. No. 94810058 RX94810058
reducer TP flow rate 3.4l/min dark green tolerance ±25%			
	GEV No.	371239	Ref. No. —
reducer TP flow rate 5l/min black tolerance ±25%			
	GEV No.	371240	Ref. No. —
reducer TP flow rate 8l/min blue tolerance ±20%			









































  1			
GEV No.	370018	Ref. No.	94809282 RX94809282
description	solenoid valve single straight 230VAC inlet 3/4" outlet 14mm DN10 TP		
spare parts for	370018		
	GEV No.	371013	Ref. No. —
solenoid coil TP 230VAC 50/60Hz			
accessories for	370018		
	GEV No.	371220	Ref. No. —
reducer TP flow rate 3l/min red tolerance ±15%			
	GEV No.	371221	Ref. No. —
reducer TP flow rate 5.5l/min yellow tolerance ±15%			
	GEV No.	371222	Ref. No. —
reducer TP flow rate 6l/min grey tolerance ±15%			
	GEV No.	371223	Ref. No. —
reducer TP flow rate 10l/min white tolerance ±15%			
	GEV No.	371224	Ref. No. —
reducer TP flow rate 12l/min bronze tolerance ±15%			
	GEV No.	371225	Ref. No. —
reducer TP flow rate 16l/min light brown tolerance ±15%			
	GEV No.	371226	Ref. No. —
reducer TP flow rate 20l/min red tolerance ±15%			
	GEV No.	371230	Ref. No. —
reducer TP flow rate 0.25l/min red tolerance ±25%			
	GEV No.	371231	Ref. No. —
reducer TP flow rate 0.35l/min violet tolerance ±25%			
	GEV No.	371232	Ref. No. —
reducer TP flow rate 0.5l/min orange tolerance ±25%			
	GEV No.	371233	Ref. No. —
reducer TP flow rate 0.8l/min white tolerance ±25%			
	GEV No.	371234	Ref. No. —
reducer TP flow rate 1l/min light blue tolerance ±25%			
	GEV No.	371235	Ref. No. —
reducer TP flow rate 1.2l/min brown tolerance ±25%			
	GEV No.	371236	Ref. No. —
reducer TP flow rate 1.5l/min light brown tolerance ±25%			

Table continues overleaf



accessories for		370018		
	GEV No.	371237	Ref. No.	—
reducer TP flow rate 2.5l/min yellow tolerance ±25%				
	GEV No.	371238	Ref. No.	94810058 RX94810058
reducer TP flow rate 3.4l/min dark green tolerance ±25%				
	GEV No.	371239	Ref. No.	—
reducer TP flow rate 5l/min black tolerance ±25%				
	GEV No.	371240	Ref. No.	—
reducer TP flow rate 8l/min blue tolerance ±20%				

  1				
GEV No.	370015	Ref. No.	94805520 RX94805520	
description	solenoid valve single angled 230VAC inlet 3/4" outlet 11.5mm DN10 TP			
accessories for		370015		
	GEV No.	371220	Ref. No.	—
reducer TP flow rate 3l/min red tolerance ±15%				
	GEV No.	371221	Ref. No.	—
reducer TP flow rate 5.5l/min yellow tolerance ±15%				
	GEV No.	371222	Ref. No.	—
reducer TP flow rate 6l/min grey tolerance ±15%				
	GEV No.	371223	Ref. No.	—
reducer TP flow rate 10l/min white tolerance ±15%				
	GEV No.	371224	Ref. No.	—
reducer TP flow rate 12l/min bronze tolerance ±15%				
	GEV No.	371225	Ref. No.	—
reducer TP flow rate 16l/min light brown tolerance ±15%				
	GEV No.	371226	Ref. No.	—
reducer TP flow rate 20l/min red tolerance ±15%				
	GEV No.	371230	Ref. No.	—
reducer TP flow rate 0.25l/min red tolerance ±25%				
	GEV No.	371231	Ref. No.	—
reducer TP flow rate 0.35l/min violet tolerance ±25%				
	GEV No.	371232	Ref. No.	—
reducer TP flow rate 0.5l/min orange tolerance ±25%				
	GEV No.	371233	Ref. No.	—
reducer TP flow rate 0.8l/min white tolerance ±25%				
	GEV No.	371234	Ref. No.	—
reducer TP flow rate 1l/min light blue tolerance ±25%				

accessories for		370015		
	GEV No.	371235	Ref. No.	—
reducer TP flow rate 1.2l/min brown tolerance ±25%				
	GEV No.	371236	Ref. No.	—
reducer TP flow rate 1.5l/min light brown tolerance ±25%				
	GEV No.	371237	Ref. No.	—
reducer TP flow rate 2.5l/min yellow tolerance ±25%				
	GEV No.	371238	Ref. No.	94810058 RX94810058
reducer TP flow rate 3.4l/min dark green tolerance ±25%				
	GEV No.	371239	Ref. No.	—
reducer TP flow rate 5l/min black tolerance ±25%				
	GEV No.	371240	Ref. No.	—
reducer TP flow rate 8l/min blue tolerance ±20%				

solenoid valves with reducers

 1				
GEV No.	370628	Ref. No.	94050168 RX94050168	
description	solenoid valve double straight 230VAC inlet 3/4" input 16l/min DN10 TP plastic outlet 11.5mm			

spare parts and accessories

reducers

outlet side

 1				
GEV No.	371238	Ref. No.	94810058 RX94810058	
description	reducer TP flow rate 3.4l/min dark green tolerance ±25%			





metal

ASCO

solenoid valves steam (water)

2-way



1

<b>GEV No.</b>	370728	<b>Ref. No.</b>	94804036 RX94804036
<b>description</b>	solenoid valve 2-ways 24VAC inlet 1/2" IT outlet 1/2" IT connection 1/2" L 62mm DN 12mm t.max. 85°C slide-on receptacle DIN -10 up to +85°C Asco type series E238C coil type 43005421 membranes NBR p max 10bar p min 0.3bar 50/60Hz brass		

LUCIFER

spare parts and accessories

solenoid coils



1

<b>GEV No.</b>	371258	<b>Ref. No.</b>	RX27440049
<b>description</b>	solenoid coil 220VAC 14VA coil type EZ92A7		

PARKER

3-way

121 KS8358 series



1

<b>GEV No.</b>	370709	<b>Ref. No.</b>	94052347 RX94052347
<b>description</b>	solenoid valve brass 3-ways 230V voltage AC connection 1/4" IT L 77mm coil type 4818653D		



SIRAI

2-way

L180-B series



1

<b>GEV No.</b>	370329	<b>Ref. No.</b>	94807864 RX94807864	
<b>description</b>	solenoid valve 2-ways 24VAC inlet 1/2" outlet 1/2" connection 1/2" L 66mm DN 13.5mm slide-on receptacle compact -10 up to +90°C SIRAI type series L180-B coil type Z610A membranes NBR (water) p max 12bar p min 0.35bar			
<b>spare parts for</b>	370329			
	<b>GEV No.</b>	371070	<b>Ref. No.</b>	—
	solenoid coil 24VAC 10VA SIRAI coil type Z610A seat ø 10mm			
	<b>GEV No.</b>	371171	<b>Ref. No.</b>	—
	membrane series L180-B membrane type NBR (water)			
<b>accessories for</b>	370329			
	<b>GEV No.</b>	371091	<b>Ref. No.</b>	—
	power socket plug type DIN 43650B cable lengthmm small			

solenoid valves (various)



1

<b>GEV No.</b>	370832	<b>Ref. No.</b>	9401620 94016201 RX9401620 RX94016201
<b>description</b>	solenoid valve 2-ways 230VAC inlet 1/4" IT outlet 1/4" IT L 43mm p max 7bar		

pressure switches

for warewashing

ø 58mm with male faston 6.3mm

with connection horizontal





1

<b>GEV No.</b>	541105	<b>Ref. No.</b>	94803426 RX94803426
<b>description</b>	pressure control pressure range 180/70mbar connection 6mm ø 58mm pressure connection horizontal warewashing		





			
1			
<b>GEV No.</b>	541619	<b>Ref. No.</b>	RX94807187
<b>description</b>	pressure control pressure range 250/40mbar connection 6mm ø 58mm pressure connection ø 6mm		

			
1			
<b>GEV No.</b>	541311	<b>Ref. No.</b>	94807369 RX94807369
<b>description</b>	pressure control pressure range 76/38mbar connection 6mm ø 58mm pressure connection horizontal warewashing pressure connection ø 6mm		

			
1			
<b>GEV No.</b>	541045	<b>Ref. No.</b>	94801289 RX94801289
<b>description</b>	pressure control pressure range 28/12mbar connection 6mm ø 58mm pressure connection horizontal warewashing		

			
1			
<b>GEV No.</b>	541312	<b>Ref. No.</b>	RX94810911
<b>description</b>	pressure control pressure range 86/59mbar connection 6mm ø 58mm pressure connection horizontal warewashing pressure connection ø 6mm		

			
1			
<b>GEV No.</b>	541140	<b>Ref. No.</b>	94807500 RX94807500
<b>description</b>	pressure control pressure range 55/30mbar connection 6mm ø 58mm pressure connection horizontal warewashing		

			
1			
<b>GEV No.</b>	541017	<b>Ref. No.</b>	94801461 RX94801461
<b>description</b>	pressure control with mounting strap pressure range 40/20mbar connection 6mm ø 58mm pressure connection horizontal warewashing		

			
1			
<b>GEV No.</b>	541003	<b>Ref. No.</b>	94804630 RX94804630
<b>description</b>	pressure control pressure range 55/35mbar connection 6mm ø 58mm pressure connection horizontal warewashing pressure connection ø 6mm		

for steam control

			
1			
<b>GEV No.</b>	541074	<b>Ref. No.</b>	94814247 RX94814247
<b>description</b>	pressure control ø 45mm triggering pressure 0.5bar reset pressure 0.35bar pressure connection vertical steam control pressure range 0.35/0.51 bar connection 1/8" pressure connection 1/8"		

			
1			
<b>GEV No.</b>	541024	<b>Ref. No.</b>	94813806 RX94813806
<b>description</b>	pressure control pressure range 60/40mbar connection 6mm ø 58mm pressure connection horizontal warewashing pressure connection ø 6mm		

			
1			
<b>GEV No.</b>	541878	<b>Ref. No.</b>	9401489 94014891 RX94014891
<b>description</b>	pressure control steam control pressure range 0.2-1bar connection 1/4" HONEYWELL pressure connection 1/4" IT		





## electrodes



			
1			
<b>GEV No.</b>	512072	<b>Ref. No.</b>	94800901 RX94800901
<b>description</b>	level electrode 1/2" total length 78.5mm probe L 63mm insulated probe length 54mm connection M5x0.8 plastic ø 26mm		

			
1			
<b>GEV No.</b>	403131	<b>Ref. No.</b>	9402351 94023512 RX94023512
<b>description</b>	level electrode 1/4" total length 330mm probe L 270mm insulated probe length 24mm connection M4 ø 4mm		

			
1			
<b>GEV No.</b>	400171	<b>Ref. No.</b>	RX94812665
<b>description</b>	level electrode 1/4" total length 350mm probe L 325mm insulated probe length 26mm connection male faston 6.3mm stainless steel ø 2.5mm		

			
1			
<b>GEV No.</b>	400021	<b>Ref. No.</b>	24849150 RX24849150
<b>description</b>	level electrode PG9 total length 110mm probe L 70/47/24mm insulated probe length 62/38/16mm with 3 probes connection grip connection		

			
1			
<b>GEV No.</b>	400022	<b>Ref. No.</b>	24849143 RX24849143
<b>description</b>	level electrode PG9 total length 135mm probe L 89/59/28mm insulated probe length 80mm with 3 probes connection grip connection		
<b>accessories for</b>	400022		

	<b>GEV No.</b>	379729	<b>Ref. No.</b>	—
	connection cable L 1230mm 4-pole for level electrode plug type coded			
	<b>GEV No.</b>	550574	<b>Ref. No.</b>	—
	nut thread PG9 H 3mm WS 28 nickel-plated brass Qty 1 pcs mounting ømm cable ømm			

## fans

## refrigeration fans



## cold air circulating fans (complete)

COPREL

MAP series

			
1			
<b>GEV No.</b>	601056	<b>Ref. No.</b>	94805652 RX94805652
<b>description</b>	fan blowing 230V 9W 50/60Hz fan wheel ø 96mm shaft L 21mm connection with cable for saladette hole distance 135mm ED ø 145mm mounting ø 110mm built-in depth 85mm		

## hot air motors

				
1				
<b>GEV No.</b>	601856	<b>Ref. No.</b>	RX94814228	
<b>description</b>	fan motor 230V 1 phase 50Hz 0.075kW 2650rpm speeds 1 L1 85mm L2 30mm L3 23mm L4 12mm D1 ø 8x6mm D2 ø 8mm 0.6A suitable capacitor 5µF/400V			
<b>accessories for</b>	601856			
	<b>GEV No.</b>	365017	<b>Ref. No.</b>	94807807 RX94807807
	operating capacitor capacity 5µF 450V tolerance 5% 50/60Hz ambient temperature max. -25 to +85°C ø 28mm L 54mm M8 plastic connection male faston 6.3mm 16.10.08 protection			

			
1			
<b>GEV No.</b>	601049	<b>Ref. No.</b>	27490051 RX27490051
<b>description</b>	fan wheel D1 ø 280mm H1 125mm blades 12 D2 ø 11mm D3 ø 16mm H2 37mm		





1

<b>GEV No.</b>	601503	<b>Ref. No.</b>	RX94050051
<b>description</b>	fan wheel D1 ø 350mm H1 125mm blades 12 D2 ø 13mm D3 ø 16mm		
<b>accessories for</b>	601503		
	<b>GEV No.</b>	500505	<b>Ref. No.</b> —
<b>description</b>	fan motor 220-240/380-415V 3 phase 50/60Hz 0.16-0.26kW 1440/1700rpm speeds 2 L1 140mm L2 27mm L3 35mm M10R IT 1.2/0.7A Cos(f) 0.63 type L7zAw4D-014 D1 ø 17mm D2 ø 13mm		

hot air fans

miscellaneous



1

<b>GEV No.</b>	602149	<b>Ref. No.</b>	94813983 RX94813983
<b>description</b>	fan motor 230/400V 0.55W type N552		

accessories

fan wheels for hot air fans



1

<b>GEV No.</b>	602003	<b>Ref. No.</b>	RX94442209
<b>description</b>	fan wheel ø 235mm blades 8 W 55mm shaft intake ø 8mm		

motors

gear motors

for dishwashers



1

<b>GEV No.</b>	601861	<b>Ref. No.</b>	94812161 RX94812161
<b>description</b>	gear motor FIR type 71-B5 180W 400V voltage AC 50/60Hz 3 phase 900/1100rpm shaft ø 14mm L 227mm for transport system without gearbox		

motors



1

<b>GEV No.</b>	501405	<b>Ref. No.</b>	RX94808672
<b>description</b>	motor without gearbox 180/220W 230/400-280/480V 50/60Hz 3 phase 1.2/0.7-1.15/0.67A shaft ø 11mm shaft length 26mm flange ø 89mm 1340/1608rpm type MS63B-4 ø 119mm H 163mm L 215mm E.M.C. for drying 0.18/0.22kW		

motors

for dishwashers



1

<b>GEV No.</b>	501477	<b>Ref. No.</b>	94807590 RX94807590
<b>description</b>	motor 260W 400V 50Hz 0.8A shaft ø 14mm shaft length 40mm flange ø 156mm 900rpm ø 140mm H 215mm OLYMPIA 0.26kW		



1

<b>GEV No.</b>	501405	<b>Ref. No.</b>	RX94808672
<b>description</b>	motor without gearbox 180/220W 230/400-280/480V 50/60Hz 3 phase 1.2/0.7-1.15/0.67A shaft ø 11mm shaft length 26mm flange ø 89mm 1340/1608rpm type MS63B-4 ø 119mm H 163mm L 215mm E.M.C. for drying 0.18/0.22kW		

**pumps**



wash and rinse pumps

ALBA (C&A)

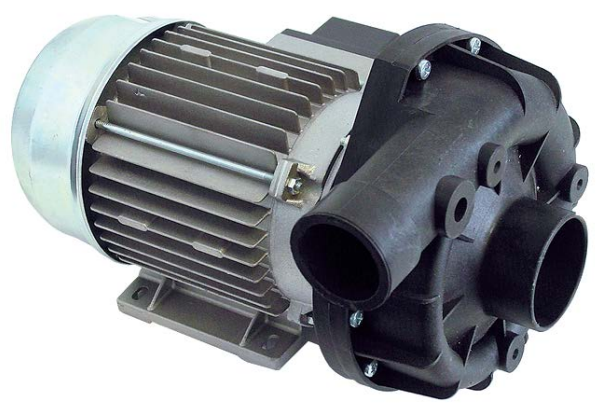
pumps



1

<b>GEV No.</b>	500371	<b>Ref. No.</b>	94801453 RX94801453
<b>description</b>	pump inlet ø 62mm outlet ø 52mm type C2532 230/400V 50Hz 3 phase 0.88kW 1.2HP L 315mm rotation direction left ALBA PUMPS (C&A)		
<b>spare parts for</b>	500371		
	<b>GEV No.</b>	508395	<b>Ref. No.</b> —
	pump cover ALBA PUMPS (C&A) inlet ø 62mm outlet ø 52mm turn direction left ø 180mm ID ø 150mm inner height 38mm		
	<b>GEV No.</b>	510693	<b>Ref. No.</b> —
	mechanical shaft seal for shaft ø 12mm slide ring ext. ø 24mm slide ring H 15.5mm slide ring int. ø 11mm counter ring mounting ø 24mm height counter ring 8mm counter ring int. ø 13.5mm		

FIR

pumps

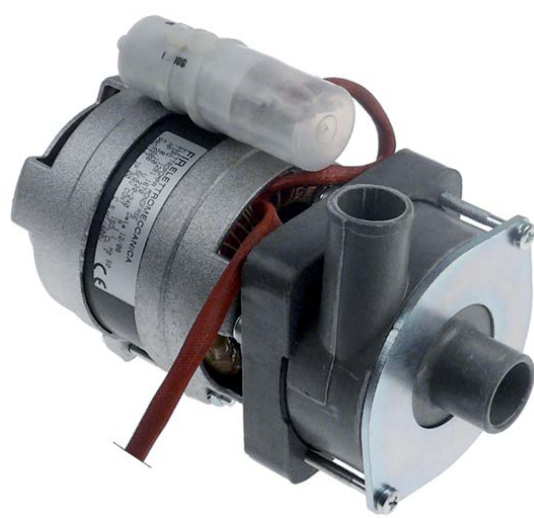

1

<b>GEV No.</b>	499004	<b>Ref. No.</b>	94813993 RX94813993
<b>description</b>	pump inlet ø 28mm outlet ø 26mm type 1291.1670 230V 50Hz 1 phase 0.07kW 0.1HP L 195mm rotation direction right capacitor 5µF FIR		
<b>spare parts for</b>	499004		
	<b>GEV No.</b>	365017	<b>Ref. No.</b> 94807807 RX94807807
	operating capacitor capacity 5µF 450V tolerance 5% 50/60Hz ambient temperature max. -25 to +85°C ø 28mm L 54mm M8 plastic connection male faston 6.3mm 16.10.08 protection		

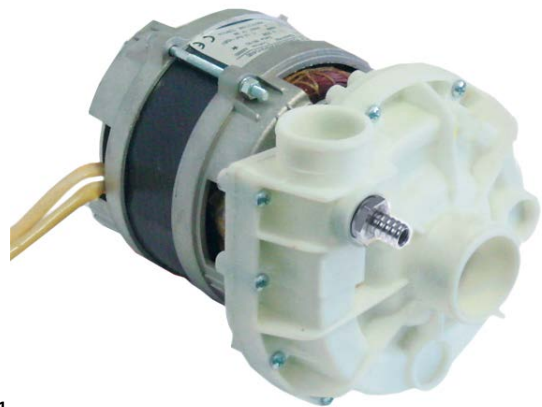

1

<b>GEV No.</b>	500463	<b>Ref. No.</b>	94801248 RX94801248
<b>description</b>	pump inlet ø 45mm outlet ø 30mm type 2253 230V 50Hz 1 phase 0.24kW 0.33HP L 160mm rotation direction right FIR		
<b>spare parts for</b>	500463		
	<b>GEV No.</b>	521148	<b>Ref. No.</b> —
	pump cover pump type Fir 2253(500.463)		







1

<b>GEV No.</b>	499123	<b>Ref. No.</b>	94813734 RX94813734
<b>description</b>	pump inlet ø 45mm outlet ø 40mm type 4296.2350 230V 50Hz 1 phase 0.75kW L 250mm rotation direction right capacitor 16µF FIR		
<b>spare parts for</b>	499123		
	<b>GEV No.</b>	365021	<b>Ref. No.</b> —
	operating capacitor capacity 16µF 425V tolerance 5% 50/60Hz ambient temperature max. -25 to +85°C ø 35mm L 73mm single M8 plastic connection male faston 6.3mm 416.10.99 protection		
	<b>GEV No.</b>	510608	<b>Ref. No.</b> RX94813934
	impellor ø 93mm H 32mm shaft intake ø 9/8mm blades 6 inner height 11mm		
	<b>GEV No.</b>	510692	<b>Ref. No.</b> —
	mechanical shaft seal for shaft ø 11mm slide ring ext. ø 24mm slide ring H 13mm counter ring mounting ø 26mm height counter ring 8mm counter ring int. ø 14mm		
	<b>GEV No.</b>	521539	<b>Ref. No.</b> —
	pump cover FIR inlet ø 45mm outlet ø 40mm auxiliary pressure connection 10mm supporting pressure open turn direction right ø 160mm ID ø 125mm inner height 25mm		
	<b>GEV No.</b>	521702	<b>Ref. No.</b> —
	pump cover gasket thickness 3.5x4.5mm Qty 1 pcs		



1

<b>GEV No.</b>	500527	<b>Ref. No.</b>	94810909 RX94810909
<b>description</b>	pump inlet ø 60mm outlet ø 50/30mm type 2233.B140 230V 50Hz 1 phase 0.55kW 0.75HP L 210mm rotation direction right capacitor 12.5µF FIR inlet ø 60mm		
<b>spare parts for</b>	500527		
	<b>GEV No.</b>	365014	<b>Ref. No.</b> 94814010 RX94814010
	operating capacitor capacity 12.5µF 450V tolerance 5%Hz ambient temperature max. -25 to +85°C ø 35mm L 70mm M8 plastic connection male faston 6.3mm 45S.C3DS.12.5 protection		
	<b>GEV No.</b>	510552	<b>Ref. No.</b> 94813933 RX94813933
	pump cover gasket pump type 1292-2/3942/3981/3911/3983		
	<b>GEV No.</b>	510608	<b>Ref. No.</b> RX94813934
	impellor ø 93mm H 32mm shaft intake ø 9/8mm blades 6 inner height 11mm		
	<b>GEV No.</b>	510692	<b>Ref. No.</b> —
	mechanical shaft seal for shaft ø 11mm slide ring ext. ø 24mm slide ring H 13mm counter ring mounting ø 26mm height counter ring 8mm counter ring int. ø 14mm		



1





<b>GEV No.</b>	499139	<b>Ref. No.</b>	94809324 RX94809324
<b>description</b>	pump inlet ø 62mm outlet ø 62mm type 2275.2722 230/400V 50Hz 3 phase 2.6kW L 400mm rotation direction right FIR		
<b>spare parts for</b>	499139		
	<b>GEV No.</b>	510687	<b>Ref. No.</b> —
	mechanical shaft seal for shaft ø 18mm height counter ring 8mm ID ø 17mm ED ø 39mm H 15mm mounting ø 42mm int. ø 121mm		





Table continues overleaf



<b>spare parts for</b> 499139				
	GEV No.	521026	Ref. No.	94809290 RX94809290
pump cover gasket ID ø 182.5mm thickness 5x4.5mm				
	GEV No.	521028	Ref. No.	—
pump cover FIR inlet ø 62mm outlet ø 62mm turn direction right ø 215mm ID ø 175mm inner height 40mm				
	GEV No.	521277	Ref. No.	94809308 RX94809308
impellor ø 135mm H 39mm pump type Fir 2275 - 3.6HP thread M14L				
	GEV No.	524676	Ref. No.	—
fan wheel ø 160mm shaft intake ø 24mm plastic blades 12 W 30mm				







1

<b>GEV No.</b>	500023	<b>Ref. No.</b>	RX94807203	
<b>description</b>	pump inlet ø 63mm outlet ø 47mm type 1225.2725 230/400V 50Hz 3 phase 1.1kW 1.5HP L 335mm rotation direction right FIR			
<b>spare parts for</b> 500023				
	GEV No.	510602	Ref. No.	94809571 RX94809571
impellor ø 110mm H 34mm rotation direction right thread M8L shaft ø 28mm seat ø 12.2mm blades 6				
	GEV No.	510693	Ref. No.	—
mechanical shaft seal for shaft ø 12mm slide ring ext. ø 24mm slide ring H 15.5mm slide ring int. ø 11mm counter ring mounting ø 24mm height counter ring 8mm counter ring int. ø 13.5mm				
	GEV No.	521513	Ref. No.	—
pump cover FIR inlet ø 63mm outlet ø 47mm turn direction right ID ø 150mm inner height 32mm				
	GEV No.	524416	Ref. No.	—
pump cover gasket thickness 4x4mm Qty 1 pcs				



1

<b>GEV No.</b>	500570	<b>Ref. No.</b>	94804002 RX94804002	
<b>description</b>	pump inlet ø 63mm outlet ø 47mm type 422512725 230/400V 50Hz 3 phase 1.1kW 1.5HP L 285mm rotation direction right FIR			
<b>spare parts for</b> 500570				
	GEV No.	510693	Ref. No.	—
mechanical shaft seal for shaft ø 12mm slide ring ext. ø 24mm slide ring H 15.5mm slide ring int. ø 11mm counter ring mounting ø 24mm height counter ring 8mm counter ring int. ø 13.5mm				
	GEV No.	521082	Ref. No.	—
impellor ø 96mm H 32mm rotation direction right thread M8L				
	GEV No.	521513	Ref. No.	—
pump cover FIR inlet ø 63mm outlet ø 47mm turn direction right ID ø 150mm inner height 32mm				
	GEV No.	524416	Ref. No.	—
pump cover gasket thickness 4x4mm Qty 1 pcs				



1









<b>GEV No.</b>	500031	<b>Ref. No.</b>	94807682 RX94807682	
<b>description</b>	pump inlet ø 63mm outlet ø 53mm type 1205.2528 230/400V 50Hz 3 phase 2kW 2.7HP L 330mm rotation direction left FIR			
<b>spare parts for</b> 500031				
	GEV No.	510357	Ref. No.	RX94814088
impellor ø 124mm H 34/16mm thread M8R blades 6				
	GEV No.	510523	Ref. No.	—
fan wheel ø 142mm shaft intake ø 15mm blades 12				

Table continues overleaf

<b>spare parts for</b> 500031					
	<table border="1"> <tr> <th>GEV No.</th> <th>510531</th> <th>Ref. No.</th> <th>—</th> </tr> </table> <p>pump cover FIR inlet ø 63mm outlet ø 53mm auxiliary pressure connection M16x1.5mm supporting pressure open turn direction left ø 185mm ID ø 150mm inner height 37mm</p>	GEV No.	510531	Ref. No.	—
GEV No.	510531	Ref. No.	—		
	<table border="1"> <tr> <th>GEV No.</th> <th>510693</th> <th>Ref. No.</th> <th>—</th> </tr> </table> <p>mechanical shaft seal for shaft ø 12mm slide ring ext. ø 24mm slide ring H 15.5mm slide ring int. ø 11mm counter ring mounting ø 24mm height counter ring 8mm counter ring int. ø 13.5mm</p>	GEV No.	510693	Ref. No.	—
GEV No.	510693	Ref. No.	—		
	<table border="1"> <tr> <th>GEV No.</th> <th>524416</th> <th>Ref. No.</th> <th>—</th> </tr> </table> <p>pump cover gasket thickness 4x4mm Qty 1 pcs</p>	GEV No.	524416	Ref. No.	—
GEV No.	524416	Ref. No.	—		





1

GEV No.	500111	Ref. No.	94813504 RX94813504		
description	pump inlet ø 63mm outlet ø 53mm type 1241.2500 230/400V 50Hz 3 phase 1.1kW 1.5HP L 330mm rotation direction left FIR				
<b>spare parts for</b> 500111					
	<table border="1"> <tr> <th>GEV No.</th> <th>510531</th> <th>Ref. No.</th> <th>—</th> </tr> </table> <p>pump cover FIR inlet ø 63mm outlet ø 53mm auxiliary pressure connection M16x1.5mm supporting pressure open turn direction left ø 185mm ID ø 150mm inner height 37mm</p>	GEV No.	510531	Ref. No.	—
GEV No.	510531	Ref. No.	—		
	<table border="1"> <tr> <th>GEV No.</th> <th>510612</th> <th>Ref. No.</th> <th>—</th> </tr> </table> <p>impellor ø 110mm H 34mm M8R</p>	GEV No.	510612	Ref. No.	—
GEV No.	510612	Ref. No.	—		
	<table border="1"> <tr> <th>GEV No.</th> <th>510693</th> <th>Ref. No.</th> <th>—</th> </tr> </table> <p>mechanical shaft seal for shaft ø 12mm slide ring ext. ø 24mm slide ring H 15.5mm slide ring int. ø 11mm counter ring mounting ø 24mm height counter ring 8mm counter ring int. ø 13.5mm</p>	GEV No.	510693	Ref. No.	—
GEV No.	510693	Ref. No.	—		
	<table border="1"> <tr> <th>GEV No.</th> <th>524416</th> <th>Ref. No.</th> <th>—</th> </tr> </table> <p>pump cover gasket thickness 4x4mm Qty 1 pcs</p>	GEV No.	524416	Ref. No.	—
GEV No.	524416	Ref. No.	—		

**LGB**







1

GEV No.	500511	Ref. No.	94813781 RX94813781		
description	pump inlet ø 30mm outlet ø 29mm type ZF140SX 230V 50Hz 1 phase 0.36kW 0.5HP L 190mm rotation direction right LGB				
<b>spare parts for</b> 500511					
	<table border="1"> <tr> <th>GEV No.</th> <th>365017</th> <th>Ref. No.</th> <th>94807807 RX94807807</th> </tr> </table> <p>operating capacitor capacity 5µF 450V tolerance 5% 50/60Hz ambient temperature max. -25 to +85°C ø 28mm L 54mm M8 plastic connection male faston 6.3mm 16.10.08 protection</p>	GEV No.	365017	Ref. No.	94807807 RX94807807
GEV No.	365017	Ref. No.	94807807 RX94807807		
	<table border="1"> <tr> <th>GEV No.</th> <th>510703</th> <th>Ref. No.</th> <th>94804085 RX94804085</th> </tr> </table> <p>mechanical shaft seal for shaft ø 13mm slide ring H 13mm height counter ring 5.5mm ED ø 26mm</p>	GEV No.	510703	Ref. No.	94804085 RX94804085
GEV No.	510703	Ref. No.	94804085 RX94804085		
	<table border="1"> <tr> <th>GEV No.</th> <th>521230</th> <th>Ref. No.</th> <th>RX94813790</th> </tr> </table> <p>impellor ø 86mm H 16mm M7L</p>	GEV No.	521230	Ref. No.	RX94813790
GEV No.	521230	Ref. No.	RX94813790		
	<table border="1"> <tr> <th>GEV No.</th> <th>521526</th> <th>Ref. No.</th> <th>—</th> </tr> </table> <p>pump cover LGB inlet ø 30mm outlet ø 30mm auxiliary pressure connection 12mm supporting pressure open turn direction right ø 117mm ID ø 95mm inner height 19mm</p>	GEV No.	521526	Ref. No.	—
GEV No.	521526	Ref. No.	—		
	<table border="1"> <tr> <th>GEV No.</th> <th>521706</th> <th>Ref. No.</th> <th>—</th> </tr> </table> <p>pump cover gasket</p>	GEV No.	521706	Ref. No.	—
GEV No.	521706	Ref. No.	—		





1			
<b>GEV No.</b>	500384	<b>Ref. No.</b>	94813975 RX94813975
<b>description</b>	pump inlet ø 30mm outlet ø 30mm type ZF160SX 230V 50Hz 1 phase 0.41kW 0.55HP L 180mm rotation direction right capacitor 12.5µF LGB		
<b>spare parts for</b>	500384		
	<b>GEV No.</b>	365014	<b>Ref. No.</b> 94814010 RX94814010
	operating capacitor capacity 12.5µF 450V tolerance 5%Hz ambient temperature max. -25 to +85°C ø 35mm L 70mm M8 plastic connection male faston 6.3mm 45S.C3DS.12.5 protection		
	<b>GEV No.</b>	510703	<b>Ref. No.</b> 94804085 RX94804085
	mechanical shaft seal for shaft ø 13mm slide ring H 13mm height counter ring 5.5mm ED ø 26mm		
	<b>GEV No.</b>	521527	<b>Ref. No.</b> —
	pump cover LGB inlet ø 30mm outlet ø 30mm		
	<b>GEV No.</b>	521701	<b>Ref. No.</b> —
	pump cover gasket		
	<b>GEV No.</b>	521707	<b>Ref. No.</b> —
	pump cover gasket		



1			
<b>GEV No.</b>	500156	<b>Ref. No.</b>	94803723 RX94803723
<b>description</b>	pump inlet ø 50mm outlet ø 50mm type ZF400SX 230V 50Hz 1 phase 0.6kW 0.8HP L 210mm rotation direction right capacitor 16µF LGB		
<b>spare parts for</b>	500156		
	<b>GEV No.</b>	509020	<b>Ref. No.</b> 94812278 RX94812278
	impeller ø 104mm H 25mm M8L		
	<b>GEV No.</b>	510703	<b>Ref. No.</b> 94804085 RX94804085
	mechanical shaft seal for shaft ø 13mm slide ring H 13mm height counter ring 5.5mm ED ø 26mm		
	<b>GEV No.</b>	521548	<b>Ref. No.</b> —
	pump cover LGB inlet ø 50mm outlet ø 50mm		
	<b>GEV No.</b>	521734	<b>Ref. No.</b> —
	pump cover bottom part		
	<b>GEV No.</b>	523509	<b>Ref. No.</b> —
	deep-groove ball bearing type 6201-2RS shaft ø 12mm ED ø 32mm W 10mm with sealing discs deep-groove ball bearing DIN 625-1		
	<b>GEV No.</b>	532623	<b>Ref. No.</b> —
	O-ring EPDM thickness 2.62mm ID ø 120.32mm Qty 1 pcs		
<b>accessories for</b>	500156		
	<b>GEV No.</b>	365021	<b>Ref. No.</b> —
	operating capacitor capacity 16µF 425V tolerance 5% 50/60Hz ambient temperature max. -25 to +85°C ø 35mm L 73mm single M8 plastic connection male faston 6.3mm 416.10.99 protection		



1

<b>GEV No.</b>	500377	<b>Ref. No.</b>	94800745 RX94800745
<b>description</b>	pump inlet ø 61mm outlet ø 52mm type ZF800DX 230/400V 50Hz 3 phase 2kW 2.72HP L 330mm rotation direction left LGB		
<b>spare parts for</b>	500377		
	<b>GEV No.</b>	510551	<b>Ref. No.</b> —
	pump cover gasket ID ø 158.3mm pump type 1214/1293/1225/2243/1226/1204/3473/1241 thickness 3.53mm EPDM Qty 1 pcs		
	<b>GEV No.</b>	510694	<b>Ref. No.</b> —
	mechanical shaft seal for shaft ø 13mm height counter ring 8mm ID ø 11.5mm H 16mm mounting ø 24/26mm int. ø 1 14mm		
	<b>GEV No.</b>	521276	<b>Ref. No.</b> —
	impellor ø 120mm H 39mm pump type ZF800DX shaft intake ø 12mm rotation direction left thread M8R pump for ZF800DX blades 6		
	<b>GEV No.</b>	521516	<b>Ref. No.</b> —
	pump cover LGB inlet ø 62mm outlet ø 52mm auxiliary pressure connection 12mm supporting pressure closed turn direction left ø 190mm ID ø 150mm inner height 40mm		



1

<b>GEV No.</b>	500379	<b>Ref. No.</b>	94813979 RX94813979
<b>description</b>	pump inlet ø 62mm outlet ø 50mm type ZF650SX 230/400V 50Hz 3 phase 1.35kW 1.8HP L 335mm rotation direction right LGB		
<b>spare parts for</b>	500379		
	<b>GEV No.</b>	510551	<b>Ref. No.</b> —
	pump cover gasket ID ø 158.3mm pump type 1214/1293/1225/2243/1226/1204/3473/1241 thickness 3.53mm EPDM Qty 1 pcs		
	<b>GEV No.</b>	510694	<b>Ref. No.</b> —
	mechanical shaft seal for shaft ø 13mm height counter ring 8mm ID ø 11.5mm H 16mm mounting ø 24/26mm int. ø 1 14mm		
	<b>GEV No.</b>	521240	<b>Ref. No.</b> 94803996 RX94803996
	impellor ø 110mm H 32mm rotation direction left thread M8L shaft ø 20mm shaft length 10mm seat ø 8.2mm blades 6		

<b>spare parts for</b>	500379		
	<b>GEV No.</b>	521536	<b>Ref. No.</b> —
	pump cover ALBA / LGB inlet ø 62mm outlet ø 50mm auxiliary pressure connection 12mm supporting pressure closed turn direction right ø 180mm ID ø 150mm inner height 38mm		



1

<b>GEV No.</b>	500122	<b>Ref. No.</b>	94801453 RX94801453
<b>description</b>	pump inlet ø 62mm outlet ø 52mm type AM5225DX 230/400V 50Hz 3 phase 1.2kW 1.6HP L 300mm rotation direction left LGB		
<b>spare parts for</b>	500122		
	<b>GEV No.</b>	501495	<b>Ref. No.</b> —
	cover plastic for terminal box for pump LGB		
	<b>GEV No.</b>	510551	<b>Ref. No.</b> —
	pump cover gasket ID ø 158.3mm pump type 1214/1293/1225/2243/1226/1204/3473/1241 thickness 3.53mm EPDM Qty 1 pcs		
	<b>GEV No.</b>	510694	<b>Ref. No.</b> —
	mechanical shaft seal for shaft ø 13mm height counter ring 8mm ID ø 11.5mm H 16mm mounting ø 24/26mm int. ø 1 14mm		
	<b>GEV No.</b>	521236	<b>Ref. No.</b> —
	impellor ø 105mm H 32mm M8R		
	<b>GEV No.</b>	521516	<b>Ref. No.</b> —
	pump cover LGB inlet ø 62mm outlet ø 52mm auxiliary pressure connection 12mm supporting pressure closed turn direction left ø 190mm ID ø 150mm inner height 40mm		





**LOWARA**  
pumps



1

<b>GEV No.</b>	500386	<b>Ref. No.</b>	94813490 RX94813490
<b>description</b>	pump inlet $\varnothing$ 1 1/4" IT outlet $\varnothing$ 1" IT type CEA70/5/A 230 220-240/380-415V 50Hz 0.88kW LOWARA 0.75HP		

**spare parts for** 500521

	<b>GEV No.</b>	528800	<b>Ref. No.</b>	—
O-ring EPDM thickness 2.62mm ID $\varnothing$ 75.87mm Qty 1 pcs				

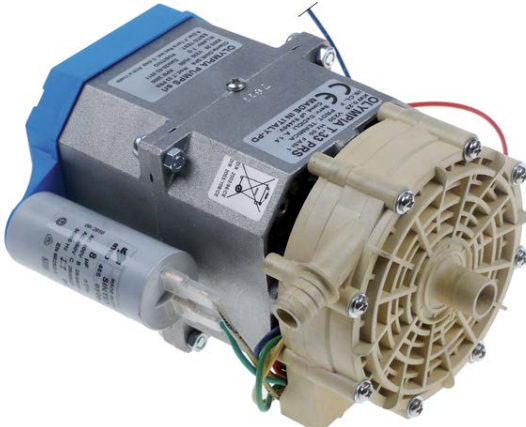

1

<b>GEV No.</b>	499095	<b>Ref. No.</b>	RX94814080
<b>description</b>	pump inlet $\varnothing$ 15mm outlet $\varnothing$ 14mm type T.33PRS 230V 50Hz 1 phase 0.25kW L 185mm rotation direction right capacitor 8 $\mu$ F OLYMPIA		

**spare parts for** 499095

	<b>GEV No.</b>	365013	<b>Ref. No.</b>	—
operating capacitor capacity 8 $\mu$ F 400V tolerance 5%Hz ambient temperature max. -25 to +85°C $\varnothing$ 31.5mm L 55mm M8 plastic connection male faston 6.3mm protection				
	<b>GEV No.</b>	510693	<b>Ref. No.</b>	—
mechanical shaft seal for shaft $\varnothing$ 12mm slide ring ext. $\varnothing$ 24mm slide ring H 15.5mm slide ring int. $\varnothing$ 11mm counter ring mounting $\varnothing$ 24mm height counter ring 8mm counter ring int. $\varnothing$ 13.5mm				
	<b>GEV No.</b>	521165	<b>Ref. No.</b>	—
pump cover OLYMPIA inlet $\varnothing$ 15mm outlet $\varnothing$ 13mm pump type R63. T33 PRS				
	<b>GEV No.</b>	521166	<b>Ref. No.</b>	—
impellor $\varnothing$ 90mm H 9mm pump type R63.T33 PRS thread M10R shaft $\varnothing$ 12mm shaft length 8mm				
	<b>GEV No.</b>	525022	<b>Ref. No.</b>	—
O-ring EPDM thickness 1.78mm ID $\varnothing$ 75.92mm Qty 1 pcs				

**OLYMPIA**  
pumps



1

<b>GEV No.</b>	500521	<b>Ref. No.</b>	94808565 RX94808565	
<b>description</b>	pump inlet $\varnothing$ 1" IT outlet $\varnothing$ 26mm type T33 230V 50Hz 1 phase 0.25kW 0.34HP L 225mm rotation direction right capacitor 5 $\mu$ F auxiliary pressure connection 11mm supporting pressure closed OLYMPIA			
<b>spare parts for</b>	500521			
	<b>GEV No.</b>	365017	<b>Ref. No.</b>	94807807 RX94807807
operating capacitor capacity 5 $\mu$ F 450V tolerance 5% 50/60Hz ambient temperature max. -25 to +85°C $\varnothing$ 28mm L 54mm M8 plastic connection male faston 6.3mm 16.10.08 protection				
	<b>GEV No.</b>	510693	<b>Ref. No.</b>	—
mechanical shaft seal for shaft $\varnothing$ 12mm slide ring ext. $\varnothing$ 24mm slide ring H 15.5mm slide ring int. $\varnothing$ 11mm counter ring mounting $\varnothing$ 24mm height counter ring 8mm counter ring int. $\varnothing$ 13.5mm				
	<b>GEV No.</b>	521256	<b>Ref. No.</b>	—
impellor $\varnothing$ 74mm H 14mm thread M10L shaft $\varnothing$ 12mm shaft length 7.5mm blades 8				
	<b>GEV No.</b>	521554	<b>Ref. No.</b>	—
pump cover OLYMPIA inlet 1" $\varnothing$ 90mm ID $\varnothing$ 66mm inner height 5mm				
	<b>GEV No.</b>	521724	<b>Ref. No.</b>	—
O-ring EPDM thickness 1.78mm ID $\varnothing$ 72.75mm Qty 1 pcs				



1

<b>GEV No.</b>	499318	<b>Ref. No.</b>	94807799 RX94807799
<b>description</b>	pump inlet ø 28mm outlet ø 28mm type L63.T19 230V 50Hz 1 phase 0.19kW L 185mm rotation direction right capacitor 5µF OLYMPIA inlet ø 28mm outlet ø 28mm		
<b>spare parts for</b>	499318		
	<b>GEV No.</b>	365017	<b>Ref. No.</b> 94807807 RX94807807
	operating capacitor capacity 5µF 450V tolerance 5% 50/60Hz ambient temperature max. -25 to +85°C ø 28mm L 54mm M8 plastic connection male faston 6.3mm 16.10.08 protection		
	<b>GEV No.</b>	510693	<b>Ref. No.</b> —
	mechanical shaft seal for shaft ø 12mm slide ring ext. ø 24mm slide ring H 15.5mm slide ring int. ø 11mm counter ring mounting ø 24mm height counter ring 8mm counter ring int. ø 13.5mm		
	<b>GEV No.</b>	521163	<b>Ref. No.</b> —
	pump cover OLYMPIA inlet ø 28mm outlet ø 26mm pump type L63.T19		
	<b>GEV No.</b>	521164	<b>Ref. No.</b> —
	impeller ø 64mm H 15mm pump type L63.T19 thread M7L shaft ø 12mm shaft length 30mm		
	<b>GEV No.</b>	521724	<b>Ref. No.</b> —
	O-ring EPDM thickness 1.78mm ID ø 72.75mm Qty 1 pcs		



1

<b>GEV No.</b>	500199	<b>Ref. No.</b>	94804150 RX94804150
<b>description</b>	pump inlet ø 32mm outlet ø 30/24mm type T80 230V 50Hz 1 phase 0.25kW 0.34HP L 205mm rotation direction left capacitor 5µF OLYMPIA		
<b>spare parts for</b>	500199		
	<b>GEV No.</b>	365017	<b>Ref. No.</b> 94807807 RX94807807
	operating capacitor capacity 5µF 450V tolerance 5% 50/60Hz ambient temperature max. -25 to +85°C ø 28mm L 54mm M8 plastic connection male faston 6.3mm 16.10.08 protection		
	<b>GEV No.</b>	510693	<b>Ref. No.</b> —
	mechanical shaft seal for shaft ø 12mm slide ring ext. ø 24mm slide ring H 15.5mm slide ring int. ø 11mm counter ring mounting ø 24mm height counter ring 8mm counter ring int. ø 13.5mm		
	<b>GEV No.</b>	521151	<b>Ref. No.</b> —
	impeller ø 71mm H 19mm pump type OLYMPIA thread M10R shaft ø 12mm shaft length 8mm		
	<b>GEV No.</b>	521178	<b>Ref. No.</b> —
	pump casing OLYMPIA outlet ø 30/24mm pump type T80		
	<b>GEV No.</b>	521552	<b>Ref. No.</b> —
	pump cover OLYMPIA inlet ø 32mm outlet ø 30/24mm ø 103mm ID ø 93mm		
	<b>GEV No.</b>	521703	<b>Ref. No.</b> —
	pump cover gasket EPDM thickness 2.5mm ID ø 75mm Qty 1 pcs		









1

<b>GEV No.</b>	500525	<b>Ref. No.</b>	94807096 RX94807096
<b>description</b>	pump inlet $\varnothing$ 50mm outlet $\varnothing$ 30mm type T7 230V 50Hz 1 phase 0.52kW 0.71HP L 230mm rotation direction right capacitor 12.5 $\mu$ F OLYMPIA		
<b>spare parts for</b>	500525		
	<b>GEV No.</b>	365014	<b>Ref. No.</b> 94814010 RX94814010
	operating capacitor capacity 12.5 $\mu$ F 450V tolerance 5%Hz ambient temperature max. -25 to +85°C $\varnothing$ 35mm L 70mm M8 plastic connection male faston 6.3mm 455.C3D5.12.5 protection		
	<b>GEV No.</b>	510554	<b>Ref. No.</b> —
	O-ring EPDM thickness 2mm ID $\varnothing$ 120mm Qty 1 pcs		
	<b>GEV No.</b>	510693	<b>Ref. No.</b> —
	mechanical shaft seal for shaft $\varnothing$ 12mm slide ring ext. $\varnothing$ 24mm slide ring H 15.5mm slide ring int. $\varnothing$ 11mm counter ring mounting $\varnothing$ 24mm height counter ring 8mm counter ring int. $\varnothing$ 13.5mm		
	<b>GEV No.</b>	517368	<b>Ref. No.</b> RX94810637
	impellor $\varnothing$ 102mm H 21mm rotation direction right thread M10L suitable for Dihr blades 8		
	<b>GEV No.</b>	521556	<b>Ref. No.</b> 94810645 RX94810645
	pump cover OLYMPIA inlet $\varnothing$ 50mm outlet $\varnothing$ 30mm outlet 2 $\varnothing$ 30 auxiliary pressure connection 10mm supporting pressure open turn direction right $\varnothing$ 130mm ID $\varnothing$ 124mm inner height 20mm		







1

<b>GEV No.</b>	500530	<b>Ref. No.</b>	94807260 RX94807260
<b>description</b>	pump inlet $\varnothing$ 60mm outlet $\varnothing$ 48mm type T15 230V 50Hz 1 phase 1.1kW 1.5HP L 305mm rotation direction right OLYMPIA		
<b>spare parts for</b>	500530		
	<b>GEV No.</b>	365021	<b>Ref. No.</b> —
	operating capacitor capacity 16 $\mu$ F 425V tolerance 5% 50/60Hz ambient temperature max. -25 to +85°C $\varnothing$ 35mm L 73mm single M8 plastic connection male faston 6.3mm 416.10.99 protection		
	<b>GEV No.</b>	510693	<b>Ref. No.</b> —
	mechanical shaft seal for shaft $\varnothing$ 12mm slide ring ext. $\varnothing$ 24mm slide ring H 15.5mm slide ring int. $\varnothing$ 11mm counter ring mounting $\varnothing$ 24mm height counter ring 8mm counter ring int. $\varnothing$ 13.5mm		
	<b>GEV No.</b>	521039	<b>Ref. No.</b> —
	fanwheel cover ID $\varnothing$ 156mm ED $\varnothing$ 161mm H 76mm for wash pump		
	<b>GEV No.</b>	521262	<b>Ref. No.</b> 94809068 RX94809068
	impellor $\varnothing$ 102mm H 19mm rotation direction right thread M10L blades 6		
	<b>GEV No.</b>	521559	<b>Ref. No.</b> 94809050 RX94809050
	pump cover OLYMPIA inlet $\varnothing$ 60mm outlet $\varnothing$ 48mm outlet 2 $\varnothing$ 31 auxiliary pressure connection 10mm supporting pressure open turn direction right $\varnothing$ 170mm ID $\varnothing$ 150mm inner height 22mm		
	<b>GEV No.</b>	521727	<b>Ref. No.</b> 94809035 RX94809035
	pump cover gasket EPDM thickness 1.78mm ID $\varnothing$ 145mm Qty 1 pcs		





<b>GEV No.</b>	499259	<b>Ref. No.</b>	94808995 RX94808995
<b>description</b>	pump inlet $\varnothing$ 62mm outlet $\varnothing$ 52mm type MEC.T120DX 220-240/380-415V 50Hz 3 phase 0.89kW 1.2HP L 310mm rotation direction left OLYMPIA		
<b>spare parts for</b>	499259		
	GEV No.	510693	Ref. No. —
	mechanical shaft seal for shaft $\varnothing$ 12mm slide ring ext. $\varnothing$ 24mm slide ring H 15.5mm slide ring int. $\varnothing$ 11mm counter ring mounting $\varnothing$ 24mm height counter ring 8mm counter ring int. $\varnothing$ 13.5mm		
	GEV No.	521152	Ref. No. —
	pump cover OLYMPIA inlet 62 $\varnothing$ 190mm		
	GEV No.	521153	Ref. No. —
	pump casing OLYMPIA outlet $\varnothing$ 52mm		
	GEV No.	521154	Ref. No. —
	O-ring ID $\varnothing$ 152.7mm thickness 2.62mm EPDM Qty 1 pcs		
	GEV No.	521172	Ref. No. —
	impellor $\varnothing$ 107mm H 28mm pump type MEC.T120DX thread M8R		

<b>spare parts for</b>	499226		
	GEV No.	521152	Ref. No. —
	pump cover OLYMPIA inlet 62 $\varnothing$ 190mm		
	GEV No.	521153	Ref. No. —
	pump casing OLYMPIA outlet $\varnothing$ 52mm		
	GEV No.	521154	Ref. No. —
	O-ring ID $\varnothing$ 152.7mm thickness 2.62mm EPDM Qty 1 pcs		
	GEV No.	521155	Ref. No. —
	impellor $\varnothing$ 107mm H 34mm pump type OLYMPIA thread M8L blades 6		
<b>accessories for</b>	499226		
	GEV No.	542157	Ref. No. —
	bracket for wash pump L 267mm W 132mm H 43mm		

booster pumps I

	1		
<b>GEV No.</b>	500060	<b>Ref. No.</b>	94810946 RX94810946
<b>description</b>	pump inlet $\varnothing$ 1" outlet $\varnothing$ 1" type PQM60 230V 50Hz 1 phase 0.37kW PEDRELLO		
<b>accessories for</b>	500060		
	GEV No.	365015	Ref. No. —
	operating capacitor capacity 10 $\mu$ F 400V tolerance 5%Hz ambient temperature max. -25 to +85°C $\varnothing$ 35.5mm L 59mm M8 plastic connection male faston 6.3mm protection		







<b>GEV No.</b>	499226	<b>Ref. No.</b>	RX94807203 RX94810405
<b>description</b>	pump inlet $\varnothing$ 62mm outlet $\varnothing$ 52mm type MEC80.T200SX 230/400V 50Hz 3 phase 1.5kW 2HP L 340mm rotation direction right OLYMPIA		
<b>spare parts for</b>	499226		
	GEV No.	510693	Ref. No. —
	mechanical shaft seal for shaft $\varnothing$ 12mm slide ring ext. $\varnothing$ 24mm slide ring H 15.5mm slide ring int. $\varnothing$ 11mm counter ring mounting $\varnothing$ 24mm height counter ring 8mm counter ring int. $\varnothing$ 13.5mm		

	1		
<b>GEV No.</b>	500358	<b>Ref. No.</b>	94803046 94814082 RX94803046 RX94814082
<b>description</b>	pump inlet $\varnothing$ 3/8" outlet $\varnothing$ 3/8" type PS46 230V 50Hz 0.45kW $\varnothing$ 100mm L 200mm capacitor 10 $\mu$ F LGB		
<b>spare parts for</b>	500358		
	GEV No.	510713	Ref. No. —
	slide ring for shaft $\varnothing$ 12mm ED $\varnothing$ 24mm H 16mm		
	GEV No.	510723	Ref. No. —
	counter ring H 8mm ED $\varnothing$ 26mm ID $\varnothing$ 13.5mm for mechanical shaft seal		

Table continues overleaf



<b>spare parts for</b> 500358			
	GEV No.	698400	Ref. No. —
pump cover gasket pump type PS46 thickness 2mm ID ø 66mm Qty 1 pcs			
<b>accessories for</b> 500358			
	GEV No.	365015	Ref. No. —
operating capacitor capacity 10µF 400V tolerance 5%Hz ambient temperature max. -25 to +85°C ø 35.5mm L 59mm M8 plastic connection male faston 6.3mm protection			
	GEV No.	511279	Ref. No. —
hose connector brass straight thread 3/8" hose ø 12mm Qty 1 pcs			
	GEV No.	520202	Ref. No. —
hose connector nickel-plated brass straight thread 3/8" hose ø 12mm Qty 1 pcs			
	GEV No.	520677	Ref. No. —
hose connector brass straight thread 3/8" hose ø 13mm Qty 1 pcs			

### drain pumps

#### HANNING

			
1			
<b>GEV No.</b>	499286	<b>Ref. No.</b>	RX94813829
<b>description</b>	drain pump inlet ø 30mm outlet ø 24mm 220-240V 30W 50Hz HANNING type DPS25-131		

			
1			
<b>GEV No.</b>	500044	<b>Ref. No.</b>	RX27500297
<b>description</b>	drain pump inlet ø 30mm outlet ø 24mm 230V 100W 50Hz HANNING type BE28B4-017		
<b>spare parts for</b> 500044			
	GEV No.	510168	Ref. No. —
fan wheel shaft intake ø 5mm ø 62mm H 14mm			

### booster pumps II

#### accessories

			
1			
<b>GEV No.</b>	365017	<b>Ref. No.</b>	94807807 RX94807807
<b>description</b>	operating capacitor capacity 5µF 450V tolerance 5% 50/60Hz ambient temperature max. -25 to +85°C ø 28mm L 54mm M8 plastic connection male faston 6.3mm 16.10.08 protection		

### condensators & interference suppression filters

#### operating capacitors

			
1			
<b>GEV No.</b>	365014	<b>Ref. No.</b>	94814010 RX94814010
<b>description</b>	operating capacitor capacity 12.5µF 450V tolerance 5%Hz ambient temperature max. -25 to +85°C ø 35mm L 70mm M8 plastic connection male faston 6.3mm 45S.C3DS.12.5 protection		

			
1			
<b>GEV No.</b>	365017	<b>Ref. No.</b>	94807807 RX94807807
<b>description</b>	operating capacitor capacity 5µF 450V tolerance 5% 50/60Hz ambient temperature max. -25 to +85°C ø 28mm L 54mm M8 plastic connection male faston 6.3mm 16.10.08 protection		

#### filters

#### interference suppression filters

			
1			
<b>GEV No.</b>	365047	<b>Ref. No.</b>	94808409 RX94808409
<b>description</b>	interference suppression filter capacity 0.33µF(X2)+2x0.015µF		







## fuses

### fine fuses

			
1			
<b>GEV No.</b>	358677	<b>Ref. No.</b>	RX27630268
<b>description</b>	fine fuse size ø5x20mm 4A fast-acting rated 250V Qty 10 pcs		

			
1			
<b>GEV No.</b>	358607	<b>Ref. No.</b>	27630086 RX27630086
<b>description</b>	fine fuse size ø5x20mm 6.3A slow-acting rated 250V Qty 10 pcs		

### fine fuse holders

			
1			
<b>GEV No.</b>	550105	<b>Ref. No.</b>	27630110 RX27630110
<b>description</b>	rail-mounted terminal WIELAND type WK10/SIU 5X20 /V0 suitable fuse ø5x20mm 1.0-16mm <sup>2</sup> 10A rated 250V		

### screw locks

#### fuse holders



			
1			
<b>GEV No.</b>	358059	<b>Ref. No.</b>	27635200 RX27635200
<b>description</b>	fuse holder suitable fuse D01 ø 24mm mounting ø 14mm 1-pole-pole 16A rated 400V L 30mm		

## electric accessories

### cables

#### accessories

##### protection hoses

				
1				
<b>GEV No.</b>	550036	<b>Ref. No.</b>	RX94044806	
<b>description</b>	protective metal tube PG13.5 ID ø 16mm ED ø 19mm zinc-coated steel Qty 10m			
<b>accessories for</b>	550036			
	<b>GEV No.</b>	550301	<b>Ref. No.</b>	—
				
	screw connection for protection hose PG13.5 ID ø 14.5mm ED ømm nickel-plated brass Qty 5 pieces			

#### cable glands

##### threaded cable glands

##### screw connections

			
1			
<b>GEV No.</b>	550569	<b>Ref. No.</b>	RX94038320
<b>description</b>	cable gland thread PG11 cable ø 8.0-10.0mm mounting ø 18.6mm nickel-plated brass Qty 1 pcs		

#### fastening nuts

			
1			
<b>GEV No.</b>	550575	<b>Ref. No.</b>	94010881 R95010881 RX94010881
<b>description</b>	nut thread PG11 H 3mm WS 21 nickel-plated brass Qty 1 pcs		

### terminals

#### porcelain clamps

			
1			
<b>GEV No.</b>	550116	<b>Ref. No.</b>	RX94018090
<b>description</b>	porcelain terminal block 3-pole 10mm <sup>2</sup> hole distance 16mm max. 30A max 450V L 52mm W 30mm H 23mm mounting distance 16mm Qty 1 pcs		

#### connection terminals with screw/faston connections

			
1			
<b>GEV No.</b>	550411	<b>Ref. No.</b>	94810223 RX94810223
<b>description</b>	power terminal block 6-pole max. 40A max 450V connection ø6mm <sup>2</sup> / F6.3 temp.-resist. 150°C cross section 6mm <sup>2</sup>		

1 electric components



### rail-mounted terminals

WIELAND

rail-mounted terminals type 9700A



<b>GEV No.</b>	550376	<b>Ref. No.</b>	27045137 RX27045137
<b>description</b>	rail-mounted terminal WIELAND type 9700A/16 S35 2.5-35mm <sup>2</sup> top-hat rail 35mm grey W 16mm L 59mm		

### fuse terminal blocks

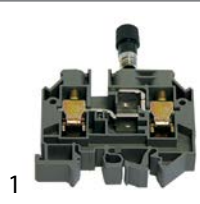

<b>GEV No.</b>	550105	<b>Ref. No.</b>	27630110 RX27630110
<b>description</b>	rail-mounted terminal WIELAND type WK10/SIU 5X20 /V0 suitable fuse $\phi 5 \times 20$ mm 1.0-16mm <sup>2</sup> 10A rated 250V		

## gas taps

### PEL

20S series



<b>GEV No.</b>	101094	<b>Ref. No.</b>	94805017 RX94805017
----------------	--------	-----------------	------------------------

**description** gas tap PEL type 20S gas inlet M16x1.5 (tube  $\phi$  10mm) bypass nozzle  $\phi$  0.35mm gas outlet M16x1.5 (tube  $\phi$  10/8mm) thermocouple connection M8x1 pilot connection shaft  $\phi$  8x6.5mm shaft L 22/15mm shaft flat lower

**spare parts for** 101094

	<b>GEV No.</b>	100408	<b>Ref. No.</b>	—
--	----------------	--------	-----------------	---

bypass nozzle type PEL20/21 bore  $\phi$  0.35mm thread M5x0.5

	<b>GEV No.</b>	101060	<b>Ref. No.</b>	—
--	----------------	--------	-----------------	---

magnet unit standard L 39mm D1  $\phi$  15.4mm D2  $\phi$  11mm suitable for PEL20-21/JUNKERS/EGA

	<b>GEV No.</b>	101205	<b>Ref. No.</b>	—
--	----------------	--------	-----------------	---

gas tap front part shaft  $\phi$  8x6.5mm shaft L 22/15mm shaft flat upper/lower suitable for PEL20

	<b>GEV No.</b>	101230	<b>Ref. No.</b>	—
--	----------------	--------	-----------------	---

thermocouple nut T1: M8x1 T2: M18x1 aluminium

**accessories for** 101094

	<b>GEV No.</b>	101278	<b>Ref. No.</b>	—
--	----------------	--------	-----------------	---

olive for pipe  $\phi$  10mm Qty 1 pcs

**accessories for** 101094

	<b>GEV No.</b>	101300	<b>Ref. No.</b>	—
--	----------------	--------	-----------------	---

union nut thread M16x1.5 tube  $\phi$  10mm

	<b>GEV No.</b>	101450	<b>Ref. No.</b>	—
--	----------------	--------	-----------------	---

olive for pipe  $\phi$  8mm L 12.7mm Qty 1 pcs ED  $\phi$  10mm

	<b>GEV No.</b>	101451	<b>Ref. No.</b>	—
--	----------------	--------	-----------------	---

union nut thread M16x1.5 tube  $\phi$  8mm

	<b>GEV No.</b>	110081	<b>Ref. No.</b>	—
--	----------------	--------	-----------------	---

knob  $\phi$  70mm shaft  $\phi$  8x6.5mm shaft flat universal

	<b>GEV No.</b>	110083	<b>Ref. No.</b>	—
--	----------------	--------	-----------------	---

knob dial plate gas tap without ignition flame silver

### 21N series



<b>GEV No.</b>	109124	<b>Ref. No.</b>	9402050 94020500 RX94020500
----------------	--------	-----------------	-----------------------------------

**description** gas tap PEL type 21N gas inlet M16x1.5 (tube  $\phi$  10mm) bypass nozzle  $\phi$  0mm gas outlet M16x1.5 (tube  $\phi$  10/8mm) thermocouple connection pilot connection M10x1 shaft  $\phi$  6x4.6mm shaft L 40/16mm shaft flat lower

**spare parts for** 109124

	<b>GEV No.</b>	100909	<b>Ref. No.</b>	—
--	----------------	--------	-----------------	---

union screw thread M10x1 for pipe  $\phi$  6mm Qty 1 pcs

	<b>GEV No.</b>	101278	<b>Ref. No.</b>	—
--	----------------	--------	-----------------	---

olive for pipe  $\phi$  10mm Qty 1 pcs

	<b>GEV No.</b>	101300	<b>Ref. No.</b>	—
--	----------------	--------	-----------------	---

union nut thread M16x1.5 tube  $\phi$  10mm

**accessories for** 109124

	<b>GEV No.</b>	100909	<b>Ref. No.</b>	—
--	----------------	--------	-----------------	---

union screw thread M10x1 for pipe  $\phi$  6mm Qty 1 pcs

	<b>GEV No.</b>	101278	<b>Ref. No.</b>	—
--	----------------	--------	-----------------	---

olive for pipe  $\phi$  10mm Qty 1 pcs

	<b>GEV No.</b>	101300	<b>Ref. No.</b>	—
--	----------------	--------	-----------------	---

union nut thread M16x1.5 tube  $\phi$  10mm



21S series

















			
1			
<b>GEV No.</b>	101397	<b>Ref. No.</b>	94805868 RX94805868
<b>description</b>	gas tap PEL type 21S gas inlet M16x1.5 (tube ø 10mm) bypass nozzle ø 0.35mm gas outlet M16x1.5 (tube ø 10/8mm) thermocouple connection M9x1 pilot connection M10x1 shaft ø 8x6.5mm shaft L 22/15mm shaft flat lower		
<b>spare parts for</b>	101397		
	<b>GEV No.</b>	100408	<b>Ref. No.</b> —
	bypass nozzle type PEL20/21 bore ø 0.35mm thread M5x0.5		
	<b>GEV No.</b>	101060	<b>Ref. No.</b> —
	magnet unit standard L 39mm D1 ø 15.4mm D2 ø 11mm suitable for PEL20-21/JUNKERS/EGA		
	<b>GEV No.</b>	101206	<b>Ref. No.</b> —
	gas tap front part shaft ø 8x6.5mm shaft L 22/15mm shaft flat upper/lower suitable for PEL21		
	<b>GEV No.</b>	101231	<b>Ref. No.</b> —
	thermocouple nut T1: M9x1 T2: M18x1		
<b>accessories for</b>	101397		
	<b>GEV No.</b>	100908	<b>Ref. No.</b> 94812587 RX94812587
	union screw thread M10x1 for pipe ø 4mm Qty 1 pcs		
	<b>GEV No.</b>	100909	<b>Ref. No.</b> —
	union screw thread M10x1 for pipe ø 6mm Qty 1 pcs		
	<b>GEV No.</b>	101246	<b>Ref. No.</b> 94812588 RX94812588
	olive for pipe ø 4mm Qty 1 pcs		
	<b>GEV No.</b>	101278	<b>Ref. No.</b> —
	olive for pipe ø 10mm Qty 1 pcs		
	<b>GEV No.</b>	101286	<b>Ref. No.</b> —
	olive ID ø 6mm Qty 1 pcs		
	<b>GEV No.</b>	101300	<b>Ref. No.</b> —
	union nut thread M16x1.5 tube ø 10mm		
	<b>GEV No.</b>	101450	<b>Ref. No.</b> —
	olive for pipe ø 8mm L 12.7mm Qty 1 pcs ED ø 10mm		
	<b>GEV No.</b>	101451	<b>Ref. No.</b> —
	union nut thread M16x1.5 tube ø 8mm		
	<b>GEV No.</b>	110081	<b>Ref. No.</b> —
	knob ø 70mm shaft ø 8x6.5mm shaft flat universal		
	<b>GEV No.</b>	112206	<b>Ref. No.</b> —
	knob dial plate silver gas tap PEL21/22/23 t.max.°C ED ø 63mm ID ø 45.5mm		



			
1			
<b>GEV No.</b>	109125	<b>Ref. No.</b>	9402051 94020518 RX94020518
<b>description</b>	gas tap PEL type 21S gas inlet M16x1.5 (tube ø 10mm) bypass nozzle ø 0mm gas outlet M16x1.5 (tube ø 10/8mm) thermocouple connection M9x1 pilot connection M10x1 shaft ø 6x4.6mm shaft L 40/16mm shaft flat lower		
<b>spare parts for</b>	109125		
	<b>GEV No.</b>	100909	<b>Ref. No.</b> —
	union screw thread M10x1 for pipe ø 6mm Qty 1 pcs		
	<b>GEV No.</b>	101060	<b>Ref. No.</b> —
	magnet unit standard L 39mm D1 ø 15.4mm D2 ø 11mm suitable for PEL20-21/JUNKERS/EGA		
	<b>GEV No.</b>	101231	<b>Ref. No.</b> —
	thermocouple nut T1: M9x1 T2: M18x1		
	<b>GEV No.</b>	101278	<b>Ref. No.</b> —
	olive for pipe ø 10mm Qty 1 pcs		
	<b>GEV No.</b>	101286	<b>Ref. No.</b> —
	olive ID ø 6mm Qty 1 pcs		
	<b>GEV No.</b>	101300	<b>Ref. No.</b> —
	union nut thread M16x1.5 tube ø 10mm		
	<b>GEV No.</b>	106202	<b>Ref. No.</b> —
	bypass nozzle type PEL20/21 bore ø 0mm thread M5x0.5		
<b>accessories for</b>	109125		
	<b>GEV No.</b>	100909	<b>Ref. No.</b> —
	union screw thread M10x1 for pipe ø 6mm Qty 1 pcs		
	<b>GEV No.</b>	101231	<b>Ref. No.</b> —
	thermocouple nut T1: M9x1 T2: M18x1		
	<b>GEV No.</b>	101278	<b>Ref. No.</b> —
	olive for pipe ø 10mm Qty 1 pcs		
	<b>GEV No.</b>	101286	<b>Ref. No.</b> —
	olive ID ø 6mm Qty 1 pcs		
	<b>GEV No.</b>	101300	<b>Ref. No.</b> —
	union nut thread M16x1.5 tube ø 10mm		









**22S/O series**



<b>GEV No.</b>	101086	<b>Ref. No.</b>	RX94805298
<b>description</b>	gas tap PEL type 22S/O gas inlet M20x1.5 (tube ø 12mm) bypass nozzle ø 0.35mm gas outlet M20x1.5 (tube ø 12/10mm) thermocouple connection M9x1 pilot connection M10x1 shaft ø 10x8mm shaft L 25/17mm shaft flat lower		
<b>spare parts for</b>	101086		
	<b>GEV No.</b>	100259	<b>Ref. No.</b> —
	bypass nozzle type PEL22 bore ø 0.35mm thread M6x0.5		
	<b>GEV No.</b>	101058	<b>Ref. No.</b> 244761275 RX244761275
	magnet unit L 39mm D1 ø 15.4mm D2 ø 13.5mm suitable for PEL22/EGA24197 standard		
	<b>GEV No.</b>	101201	<b>Ref. No.</b> —
	gas tap front part shaft ø 10x8mm shaft L 25/17mm shaft flat upper/lower suitable for PEL22		
	<b>GEV No.</b>	101231	<b>Ref. No.</b> —
	thermocouple nut T1: M9x1 T2: M18x1		
	<b>GEV No.</b>	101240	<b>Ref. No.</b> —
	gas connection thread M20x1.5 tube ø 12/10mm for PEL gas taps with gasket and screws horizontal		
	<b>GEV No.</b>	101460	<b>Ref. No.</b> —
	O-ring ø 12.37mm D1 ø 2.62mm suitable for PEL22		
	<b>GEV No.</b>	101461	<b>Ref. No.</b> —
	screw kit suitable for PEL22 Qty 4 pcs		
<b>accessories for</b>	101086		
	<b>GEV No.</b>	100908	<b>Ref. No.</b> 94812587 RX94812587
	union screw thread M10x1 for pipe ø 4mm Qty 1 pcs		
	<b>GEV No.</b>	100909	<b>Ref. No.</b> —
	union screw thread M10x1 for pipe ø 6mm Qty 1 pcs		
	<b>GEV No.</b>	101241	<b>Ref. No.</b> —
	gas connection thread M20x1.5 tube ø 12/10mm for PEL gas taps vertical		
	<b>GEV No.</b>	101246	<b>Ref. No.</b> 94812588 RX94812588
	olive for pipe ø 4mm Qty 1 pcs		
	<b>GEV No.</b>	101248	<b>Ref. No.</b> 94810978 RX94810978
	olive for pipe ø 12mm Qty 1 pcs suitable for PEL		
	<b>GEV No.</b>	101249	<b>Ref. No.</b> —
	olive for pipe ø 10mm Qty 1 pcs		
	<b>GEV No.</b>	101250	<b>Ref. No.</b> —
	union nut thread M20x1.5 for pipe ø 10mm		
	<b>GEV No.</b>	101251	<b>Ref. No.</b> —
	union nut thread M20x1.5 for pipe ø 12mm		
	<b>GEV No.</b>	101286	<b>Ref. No.</b> —
	olive ID ø 6mm Qty 1 pcs		

<b>accessories for</b>	101086		
	<b>GEV No.</b>	110080	<b>Ref. No.</b> —
	knob ø 70mm shaft ø 10x8mm shaft flat universal		
	<b>GEV No.</b>	112206	<b>Ref. No.</b> —
	knob dial plate silver gas tap PEL21/22/23 t.max.°C ED ø 63mm ID ø 45.5mm		



<b>GEV No.</b>	106159	<b>Ref. No.</b>	RX94020484
<b>description</b>	gas tap PEL type 22S/O gas inlet M20x1.5 (tube ø 12mm) bypass nozzle ø 0.35mm gas outlet M20x1.5 (tube ø 12/10mm) thermocouple connection M9x1 pilot connection M10x1 shaft ø 8x8mm shaft L 46/21mm shaft flat diagonal		
<b>spare parts for</b>	106159		
	<b>GEV No.</b>	101058	<b>Ref. No.</b> 244761275 RX244761275
	magnet unit L 39mm D1 ø 15.4mm D2 ø 13.5mm suitable for PEL22/EGA24197 standard		
	<b>GEV No.</b>	101231	<b>Ref. No.</b> —
	thermocouple nut T1: M9x1 T2: M18x1		
<b>accessories for</b>	106159		
	<b>GEV No.</b>	101248	<b>Ref. No.</b> 94810978 RX94810978
	olive for pipe ø 12mm Qty 1 pcs suitable for PEL		
	<b>GEV No.</b>	101249	<b>Ref. No.</b> —
	olive for pipe ø 10mm Qty 1 pcs		
	<b>GEV No.</b>	101250	<b>Ref. No.</b> —
	union nut thread M20x1.5 for pipe ø 10mm		
	<b>GEV No.</b>	101251	<b>Ref. No.</b> —
	union nut thread M20x1.5 for pipe ø 12mm		

**23S/O series**









<b>GEV No.</b>	101092	<b>Ref. No.</b>	94805462 RX94805462
<b>description</b>	gas tap PEL type 23S/O gas inlet M28x1.5 (tube ø 20mm) bypass nozzle ø 0.35mm gas outlet M24x1.5 (tube ø 16mm) thermocouple connection M10x1 pilot connection M10x1 shaft ø 10x8mm shaft L 25/17mm shaft flat upper		
<b>spare parts for</b>	101092		
	<b>GEV No.</b>	100455	<b>Ref. No.</b> —
	bypass nozzle type PEL23/24 bore ø 0.35mm thread M8x0.5		

Table continues overleaf



<b>spare parts for</b> 101092	
	GEV No. 101059 Ref. No. RX244761276 magnet unit T1: M10x1 T2: M22x1 L 46mm ø 18mm suitable for PEL23S M10x1
	GEV No. 101204 Ref. No. — gas tap front part shaft ø 10x8mm shaft L 25/17mm shaft flat upper/lower suitable for PEL23S
	GEV No. 101244 Ref. No. — gas connection thread M24x1.5 tube ø 12/16mm horizontal for PEL gas taps
	GEV No. 101463 Ref. No. — screw suitable for PEL23S Qty 4 pcs
	GEV No. 528455 Ref. No. — O-ring Viton thickness 2.62mm ID ø 18.72mm Qty 1 pcs
<b>accessories for</b> 101092	
	GEV No. 100908 Ref. No. 94812587 RX94812587 union screw thread M10x1 for pipe ø 4mm Qty 1 pcs
	GEV No. 100909 Ref. No. — union screw thread M10x1 for pipe ø 6mm Qty 1 pcs
	GEV No. 101246 Ref. No. 94812588 RX94812588 olive for pipe ø 4mm Qty 1 pcs
	GEV No. 101252 Ref. No. — union nut thread M24x1.5 for pipe ø 12mm
	GEV No. 101253 Ref. No. — union nut thread M24x1.5 PEL for pipe ø 16mm
	GEV No. 101254 Ref. No. — union nut thread M28x1.5 tube ø 20mm
	GEV No. 101255 Ref. No. — olive for pipe ø 12mm Qty 1 pcs
	GEV No. 101256 Ref. No. — olive for pipe ø 16mm Qty 1 pcs
	GEV No. 101257 Ref. No. — olive for pipe ø 20mm Qty 1 pcs
	GEV No. 101286 Ref. No. — olive ID ø 6mm Qty 1 pcs
	GEV No. 110080 Ref. No. — knob ø 70mm shaft ø 10x8mm shaft flat universal
	GEV No. 112206 Ref. No. — knob dial plate silver gas tap PEL21/22/23 t.max.°C ED ø 63mm ID ø 45.5mm

	
1	
<b>GEV No.</b> 109123	<b>Ref. No.</b> 9402049 94020492 RX94020492
<b>description</b>	gas tap PEL type 23S/O gas inlet M28x1.5 (tube ø 20mm) bypass nozzle ø 0mm gas outlet M24x1.5 (tube ø 16mm) thermocouple connection M9x1 pilot connection M10x1 shaft ø 8x8mm shaft L 46/21mm shaft flat diagonal
<b>spare parts for</b> 109123	
	GEV No. 100909 Ref. No. — union screw thread M10x1 for pipe ø 6mm Qty 1 pcs
	GEV No. 101253 Ref. No. — union nut thread M24x1.5 PEL for pipe ø 16mm
	GEV No. 101254 Ref. No. — union nut thread M28x1.5 tube ø 20mm
	GEV No. 101256 Ref. No. — olive for pipe ø 16mm Qty 1 pcs
	GEV No. 101257 Ref. No. — olive for pipe ø 20mm Qty 1 pcs
	GEV No. 101286 Ref. No. — olive ID ø 6mm Qty 1 pcs
<b>accessories for</b> 109123	
	GEV No. 100909 Ref. No. — union screw thread M10x1 for pipe ø 6mm Qty 1 pcs
	GEV No. 101253 Ref. No. — union nut thread M24x1.5 PEL for pipe ø 16mm
	GEV No. 101254 Ref. No. — union nut thread M28x1.5 tube ø 20mm
	GEV No. 101256 Ref. No. — olive for pipe ø 16mm Qty 1 pcs
	GEV No. 101257 Ref. No. — olive for pipe ø 20mm Qty 1 pcs
	GEV No. 101286 Ref. No. — olive ID ø 6mm Qty 1 pcs





**miscellaneous**

			
1			
<b>GEV No.</b>	109121	<b>Ref. No.</b>	94019874 RX94019874
<b>description</b>	gas tap gas inlet pipe flange ø23mm bypass nozzle ø 0.45mm gas outlet M14x1.5 (tube ø 6mm) external nozzle ømm pilot connection thermocouple connection shaft ø 6x4.6mm shaft L 35/24mm shaft flat upper		

			
1			
<b>GEV No.</b>	101409	<b>Ref. No.</b>	RX94805660

<b>description</b>	gas thermostat type 630 Eurosit series t.max. 280°C 40-280°C gas inlet 3/8" gas outlet 3/8" thermocouple connection M9x1 pilot connection M10x1 probe ø 4mm probe L 72mm capillary pipe 1050mm SIT		
--------------------	--	--	--

<b>spare parts for</b>	101409		
------------------------	--------	--	--

	<b>GEV No.</b>	101333	<b>Ref. No.</b>	—
plug thread 3/8" with O-ring				

<b>accessories for</b>	101409		
------------------------	--------	--	--

	<b>GEV No.</b>	100904	<b>Ref. No.</b>	—
locking screw M10x1 for pipe ø 4mm Qty 1 pcs				

	<b>GEV No.</b>	100905	<b>Ref. No.</b>	—
locking screw M10x1 for pipe ø 6mm Qty 1 pcs				

	<b>GEV No.</b>	101273	<b>Ref. No.</b>	—
olive for pipe ø 12mm L 9.5mm brass Qty 1 pcs suitable for universal				

	<b>GEV No.</b>	101276	<b>Ref. No.</b>	—
union screw thread 3/8" tube ø 12mm Qty 1 pcs				

**gas thermostats**

**SIT**

**630 Eurosit series**

			
1			
<b>GEV No.</b>	101188	<b>Ref. No.</b>	94812670 RX94812670

<b>description</b>	gas thermostat type 630 Eurosit series t.max. 190°C 110-190°C gas inlet 3/8" gas outlet 3/8" thermocouple connection M9x1 pilot connection M10x1 probe ø 4mm probe L 202mm capillary pipe 1050mm SIT		
--------------------	--	--	--

<b>accessories for</b>	101188		
------------------------	--------	--	--

	<b>GEV No.</b>	100904	<b>Ref. No.</b>	—
locking screw M10x1 for pipe ø 4mm Qty 1 pcs				

	<b>GEV No.</b>	100905	<b>Ref. No.</b>	—
locking screw M10x1 for pipe ø 6mm Qty 1 pcs				

	<b>GEV No.</b>	101273	<b>Ref. No.</b>	—
olive for pipe ø 12mm L 9.5mm brass Qty 1 pcs suitable for universal				

	<b>GEV No.</b>	101276	<b>Ref. No.</b>	—
union screw thread 3/8" tube ø 12mm Qty 1 pcs				

	<b>GEV No.</b>	101333	<b>Ref. No.</b>	—
plug thread 3/8" with O-ring				

			
1			
<b>GEV No.</b>	101125	<b>Ref. No.</b>	94044054 RX94044054

<b>description</b>	gas thermostat type 630 Eurosit series t.max. 340°C 100-340°C gas inlet 3/8" gas outlet 3/8" thermocouple connection M9x1 pilot connection M10x1 probe ø 4mm probe L 72mm capillary pipe 1050mm SIT		
--------------------	---	--	--

<b>accessories for</b>	101125		
------------------------	--------	--	--

	<b>GEV No.</b>	100825	<b>Ref. No.</b>	—
gas tap spindle shaft ø 8x6.5mm shaft L 22/14mm suitable for EUROSIT				

	<b>GEV No.</b>	100904	<b>Ref. No.</b>	—
locking screw M10x1 for pipe ø 4mm Qty 1 pcs				

	<b>GEV No.</b>	100905	<b>Ref. No.</b>	—
locking screw M10x1 for pipe ø 6mm Qty 1 pcs				

	<b>GEV No.</b>	100949	<b>Ref. No.</b>	—
gasket suitable for 630 Eurosit series				

Table continues overleaf







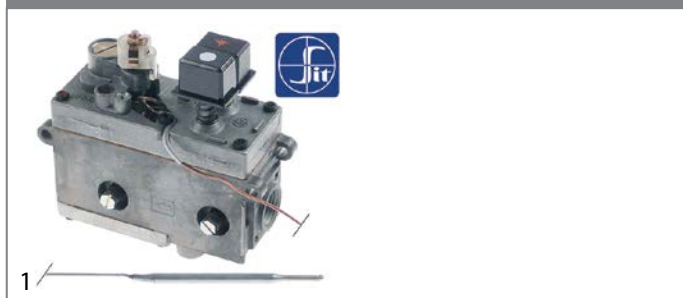

accessories for		101125		
	GEV No.	101273	Ref. No.	—
olive for pipe ø 12mm L 9.5mm brass Qty 1 pcs suitable for universal				
	GEV No.	101276	Ref. No.	—
union screw thread 3/8" tube ø 12mm Qty 1 pcs				
	GEV No.	101333	Ref. No.	—
plug thread 3/8" with O-ring				
	GEV No.	101390	Ref. No.	—
gas tap spindle shaft ø 6x4.6mm shaft L 32/15mm gas tap with ignition flame suitable for ZANUSSI, MARENO for gas thermostat EUROSIT				
	GEV No.	101392	Ref. No.	—
adapter suitable for 630 Eurosit series				
	GEV No.	110357	Ref. No.	—
gas tap spindle shaft ø 8x6.5mm shaft L 36/12mm suitable for 630 Eurosit series				
	GEV No.	110358	Ref. No.	—
adapter shaft ø 10x8mm shaft L 29/18mm suitable for 630 Eurosit series				

accessories for		101135		
	GEV No.	101054	Ref. No.	—
magnet unit T1: M10x1 T2: M24x1 L 45mm ø 17mm suitable for Minisit				
	GEV No.	101136	Ref. No.	—
piezoelectric igniter suitable for Minisit with cover cap ømm connection F6.3x0.8				
	GEV No.	101137	Ref. No.	—
cover cap without piezoelectric igniter				
	GEV No.	101267	Ref. No.	—
reducer IT 3/8" ET 1/2" L 21mm				
	GEV No.	101268	Ref. No.	—
gas connection thread 3/8" angled with O-ring MINISIT 710				
	GEV No.	101269	Ref. No.	—
gas connection thread 1/2" angled with O-ring MINISIT 710				
	GEV No.	101270	Ref. No.	—
screw connection IT 3/8" ET 3/8" L 28mm				
	GEV No.	101272	Ref. No.	—
screw connection IT 1/2" ET 3/8" L 57mm				
	GEV No.	101273	Ref. No.	—
olive for pipe ø 12mm L 9.5mm brass Qty 1 pcs suitable for universal				
	GEV No.	101274	Ref. No.	—
olive for pipe ø 16mm Qty 1 pcs				
	GEV No.	101275	Ref. No.	—
union screw thread 1/2" for pipe ø 16mm Qty 1 pcs				
	GEV No.	101276	Ref. No.	—
union screw thread 3/8" tube ø 12mm Qty 1 pcs				
	GEV No.	110068	Ref. No.	RX26645036
knob suitable for Minisit ø 37mm				

710 Minisit series



GEV No.	101135	Ref. No.	94805793 RX94805793	
<b>description</b>	gas thermostat SIT type MINISIT 710 t.max. 190°C 110-190°C gas inlet 1/2" gas outlet 3/8" thermocouple connection M9x1 pilot connection M10x1 probe ø 6mm probe L 102mm capillary pipe 1050mm probe type type A3 pressure controller no pressure regulator mbar gland nut			
<b>spare parts for</b>	101135			
	GEV No.	101053	Ref. No.	N/A
magnet unit T1: M9x1 T2: M24x1 L 45mm ø 17mm suitable for Minisit				
	GEV No.	102118	Ref. No.	—
probe 110-190°C probe ø 6mm probe L 102mm capillary pipe 1050mm t.max. 190°C fryer probe type type A3 suitable for MINISIT 710				
<b>accessories for</b>	101135			
	GEV No.	100809	Ref. No.	—
O-ring EPDM thickness 2mm ID ø 21mm Qty 1 pcs				
	GEV No.	100820	Ref. No.	RX94008893
gland duct ET M14x1.5 IT M10x0.75 probe ø max. 6.5mm WS 22				
	GEV No.	100904	Ref. No.	—
locking screw M10x1 for pipe ø 4mm Qty 1 pcs				
	GEV No.	100905	Ref. No.	—
locking screw M10x1 for pipe ø 6mm Qty 1 pcs				





GEV No.	106931	Ref. No.	94024916 RX94024916	
<b>description</b>	gas thermostat SIT type MINISIT 710 t.max. 310°C 70-310°C gas inlet 1/2" gas outlet 3/8" thermocouple connection M9x1 pilot connection M10x1 probe ø 4mm probe L 72mm capillary pipe 1300mm pressure controller no pressure regulator mbar gland nut 0710647 ignition gas 6mm probe material stainless steel			
<b>accessories for</b>	106931			
	GEV No.	101137	Ref. No.	—
cover cap without piezoelectric igniter				

Table continues overleaf

<b>accessories for</b> 106931			
	GEV No.	110068	Ref. No. RX26645036
knob suitable for Minisit ø 37mm			















<b>GEV No.</b>	107237	<b>Ref. No.</b>	N/A
<b>description</b>	gas thermostat without cap, button and angle SIT type MINISIT 710 t.max. 210°C 70-210°C gas inlet 1/2" gas outlet 3/8" thermocouple connection M9x1 pilot connection M10x1 probe ø 4mm probe L 122mm capillary pipe 1300mm probe type pressure controller no pressure regulator bar gland nut		
<b>accessories for</b> 107237			
	GEV No.	101137	Ref. No. —
cover cap without piezoelectric igniter			
	GEV No.	101267	Ref. No. —
reducer IT 3/8" ET 1/2" L 21mm			
	GEV No.	101268	Ref. No. —
gas connection thread 3/8" angled with O-ring MINISIT 710			
	GEV No.	110068	Ref. No. RX26645036
knob suitable for Minisit ø 37mm			

PEL

24ST series





<b>GEV No.</b>	101076	<b>Ref. No.</b>	94806536 RX94806536
<b>description</b>	gas thermostat PEL type 24ST 120-320°C gas inlet M20x1.5 (tube ø 12mm) bypass nozzle ø 0.35mm gas outlet M20x1.5 (tube ø 12/10mm) thermocouple connection M9x1 pilot connection M10x1 capillary pipe 1200mm probe ø 6mm probe L 100mm shaft ø 10x8mm shaft L 27/17mm shaft flat upper		
<b>spare parts for</b> 101076			
	GEV No.	100455	Ref. No. —
bypass nozzle type PEL23/24 bore ø 0.35mm thread M8x0.5			
	GEV No.	101058	Ref. No. 244761275 RX244761275
magnet unit L 39mm D1 ø 15.4mm D2 ø 13.5mm suitable for PEL22/ EGA24197 standard			
	GEV No.	106200	Ref. No. —
nut thread M9x1 suitable for PEL 24/25S			

<b>accessories for</b> 101076			
	GEV No.	100908	Ref. No. 94812587 RX94812587
union screw thread M10x1 for pipe ø 4mm Qty 1 pcs			
	GEV No.	100909	Ref. No. —
union screw thread M10x1 for pipe ø 6mm Qty 1 pcs			
	GEV No.	101246	Ref. No. 94812588 RX94812588
olive for pipe ø 4mm Qty 1 pcs			
	GEV No.	101248	Ref. No. 94810978 RX94810978
olive for pipe ø 12mm Qty 1 pcs suitable for PEL			
	GEV No.	101249	Ref. No. —
olive for pipe ø 10mm Qty 1 pcs			
	GEV No.	101250	Ref. No. —
union nut thread M20x1.5 for pipe ø 10mm			
	GEV No.	101251	Ref. No. —
union nut thread M20x1.5 for pipe ø 12mm			
	GEV No.	101286	Ref. No. —
olive ID ø 6mm Qty 1 pcs			
	GEV No.	110079	Ref. No. —
knob dial plate gas thermostat 1-8 silver			
	GEV No.	110080	Ref. No. —
knob ø 70mm shaft ø 10x8mm shaft flat universal			

ROBERTSHAW



<b>GEV No.</b>	580062	<b>Ref. No.</b>	RX24801326
<b>description</b>	gas thermostat type BJW 93-287°C 200-550°F gas inlet flange (tube ø 5/16") bypass nozzle ømm gas outlet 3/8" NPT thermocouple connection pilot connection 5/16" UNEF capillary pipe 48" - 1220mm probe ø 3/16" - 4.7mm probe L 11 1/4" - 285mm ROBERTSHAW pipe input ø 7/16" pipe output ø 7/16"		
<b>accessories for</b> 580062			
	GEV No.	106659	Ref. No. —
gas connection suitable for thermostat			
	GEV No.	112547	Ref. No. —
knob gas thermostat t.max. 500°F 200-500°F ø 49mm shaft ømm shaft flat ROBERTSHAW black			





# gas valves and ignition boxes

## gas control valves

### ROBERTSHAW

#### millivolt controlled valves







1			
<b>GEV No.</b>	106123	<b>Ref. No.</b>	RX24867038
<b>description</b>	gas valve supply Operator millivolt gas inlet 3/4" NPT gas outlet 3/4" NPT thermocouple connection pilot connection 1/4" CCT pressure regulator mbar type 7000BMV-S7CL pressure controller no suitable for ROBERTSHAW		
<b>spare parts for</b>	106123		
	<b>GEV No.</b>	106109	<b>Ref. No.</b> —
	locking screw thread 7/16"-24 UNS for pipe ø 1/4" L 16mm brass Qty 1 pcs WS 7/16" (11.113mm) hole ø 6.4mm		
	<b>GEV No.</b>	580033	<b>Ref. No.</b> RX26645069
	knob suitable for ROBERTSHAW		

### SIT

#### ELETTROSIT



1			
<b>GEV No.</b>	101127	<b>Ref. No.</b>	RX94024965
<b>description</b>	gas valve SIT type ELETTROSIT 230V gas inlet 3/4" gas outlet 3/4" thermocouple connection M9x1 pilot connection M10x1 lateral equiv. no. 0.810.175		
<b>spare parts for</b>	101127		
	<b>GEV No.</b>	101312	<b>Ref. No.</b> 94034683 RX94034683
	microswitch		
	<b>GEV No.</b>	101352	<b>Ref. No.</b> —
	solenoid coil 230V 50Hz suitable for ELETTROSIT		
<b>accessories for</b>	101127		
	<b>GEV No.</b>	100006	<b>Ref. No.</b> —
	piezoelectric igniter suitable for ELETTROSIT body plastic blowing connection ø2.4mm ø 14mm		
	<b>GEV No.</b>	100904	<b>Ref. No.</b> —
	locking screw M10x1 for pipe ø 4mm Qty 1 pcs		

<b>accessories for</b>	101127		
	<b>GEV No.</b>	100905	<b>Ref. No.</b> —
	locking screw M10x1 for pipe ø 6mm Qty 1 pcs		
	<b>GEV No.</b>	101301	<b>Ref. No.</b> —
	gas connection thread 1/2" straight ELETTROSIT screw with O-ring		
	<b>GEV No.</b>	101303	<b>Ref. No.</b> —
	gas connection straight thread 3/4" ELETTROSIT		
	<b>GEV No.</b>	101309	<b>Ref. No.</b> —
	extension		

### NOVASIT

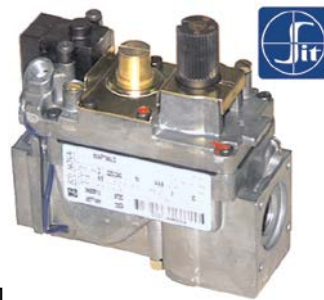











1			
<b>GEV No.</b>	101162	<b>Ref. No.</b>	9402374 RX94023744
<b>description</b>	gas valve SIT series Novasit 820 230V 50Hz gas inlet 1/2" gas outlet 1/2" thermocouple connection M9x1 pilot connection M10x1 ignition pressure 3-5mbar pressure range 3-30mbar pressure regulator connection blind equiv. no. 0.820.010		
<b>spare parts for</b>	101162		
	<b>GEV No.</b>	101065	<b>Ref. No.</b> —
	magnet unit with cable L 44mm D1 ø 30mm D2 ø 20mm suitable for NOVASIT		
	<b>GEV No.</b>	101313	<b>Ref. No.</b> —
	solenoid coil 230V 50Hz		
<b>accessories for</b>	101162		
	<b>GEV No.</b>	100006	<b>Ref. No.</b> —
	piezoelectric igniter suitable for ELETTROSIT body plastic blowing connection ø2.4mm ø 14mm		
	<b>GEV No.</b>	101305	<b>Ref. No.</b> —
	gas connection straight 1/2" flange 45x45mm ELETTROSIT/V4400/4600/4605 suitable for SIT/HONEYWELL hole distance 36x36mm		
	<b>GEV No.</b>	101306	<b>Ref. No.</b> —
	gas connection angled flange 45x45mm hole distance 36x36mm 1/2" ELETTROSIT/V4400/4600/4605 screw with O-ring suitable for SIT/HONEYWELL		
	<b>GEV No.</b>	101307	<b>Ref. No.</b> —
	gas connection straight flange 45x45mm hole distance 36x36mm 3/4" ELETTROSIT/V4400/4600/4605 screw with O-ring suitable for SIT/HONEYWELL		
	<b>GEV No.</b>	101308	<b>Ref. No.</b> —
	gas connection angled flange 45x45mm hole distance 36x36mm 3/4" ELETTROSIT/V4400/4600/4605 screw with O-ring suitable for SIT/HONEYWELL		
	<b>GEV No.</b>	101312	<b>Ref. No.</b> 94034683 RX94034683
	microswitch		

Table continues overleaf



accessories for		101162		
GEV No.	101314	Ref. No.	—	
	solenoid coil 24V 50Hz			
GEV No.	101317	Ref. No.	—	
	plug with cable L 1000mm suitable for NOVASIT			
GEV No.	101318	Ref. No.	—	
	cover cap for solenoid coil suitable for NOVASIT			

## ignition boxes

### HONEYWELL

Honeywell



1	<b>GEV No.</b>	104598	<b>Ref. No.</b>	RX94045529
<b>description</b> ignition box HONEYWELL type S4565XXXXX electrodes 3 waiting times safety time 10s 220-240V 4VA 50/60Hz				





## ignition parts













### pilot burners

#### SIT

#### 100 series



1	<b>GEV No.</b>	106906	<b>Ref. No.</b>	94034659 RX94027471 RX94034659
<b>description</b> pilot burner SIT type 100 series 3 flames nozzle $\varnothing$ 0.2mm gas connection 6mm				
spare parts for		106906		
GEV No.	100245	Ref. No.	—	
	pilot burner nozzle LPG code 20 bore $\varnothing$ 0.2mm Qty 1 pcs thread M8x0.75			
GEV No.	100855	Ref. No.	RX94028602 RX94028604	
	pilot burner bracket triple			
GEV No.	100885	Ref. No.	—	
	air mixing sleeve for pilot burner Qty 1 pcs			
GEV No.	100916	Ref. No.	—	
	compression spring for pilot burner Qty 1 pcs			
GEV No.	100917	Ref. No.	—	
	gasket for pilot burner Qty 1 pcs aluminium			

spare parts for		106906		
GEV No.	100918	Ref. No.	—	
	screw for pilot burner			
GEV No.	107162	Ref. No.	—	
	pilot burner cap SIT 3 flames Hmm Lmm Qty 1 pcs			
GEV No.	107701	Ref. No.	—	
	pilot burner bottom part SIT 100 series nozzle $\varnothing$ 0.2mm			
accessories for		106906		
GEV No.	100245	Ref. No.	—	
	pilot burner nozzle LPG code 20 bore $\varnothing$ 0.2mm Qty 1 pcs thread M8x0.75			
GEV No.	100246	Ref. No.	—	
	pilot burner nozzle natural gas bore $\varnothing$ 0.35mm Qty 1 pcs thread M8x0.75			
GEV No.	100904	Ref. No.	—	
	locking screw M10x1 for pipe $\varnothing$ 4mm Qty 1 pcs			
GEV No.	100905	Ref. No.	—	
	locking screw M10x1 for pipe $\varnothing$ 6mm Qty 1 pcs			
GEV No.	102110	Ref. No.	—	
	pilot tube copper pipe $\varnothing$ 4mm thickness 1mm L 3000mm			
GEV No.	102111	Ref. No.	—	
	pilot tube copper pipe $\varnothing$ 6mm thickness 1mm L 3000mm			
GEV No.	107171	Ref. No.	94812644 RX94812644	
	pilot burner nozzle SIT natural/liquid gas bore $\varnothing$ 0.25mm Qty 1 pcs			
GEV No.	107700	Ref. No.	—	
	pilot burner bottom part SIT 100 series nozzle $\varnothing$ 0.25mm			
GEV No.	107702	Ref. No.	—	
	pilot burner bottom part SIT 100 series nozzle $\varnothing$ 0.35mm			

#### accessories





#### pilot burner caps





1	<b>GEV No.</b>	100837	<b>Ref. No.</b>	RX94034634
<b>description</b> pilot burner cap 3 flames H 24mm L 48mm Qty 1 pcs				





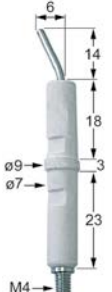

pilot burner brackets			
universal			
 1			
<b>GEV No.</b>	100855	<b>Ref. No.</b>	RX94028602 RX94028604
<b>description</b>	pilot burner bracket triple		
<b>accessories for</b>	100855		
			
<b>GEV No.</b>	100855	<b>Ref. No.</b>	RX94028602 RX94028604
<b>description</b>	pilot burner bracket triple		
			
<b>GEV No.</b>	100886	<b>Ref. No.</b>	—
<b>description</b>	pilot burner bracket suitable for 100 series 3-piece		
			
<b>GEV No.</b>	100888	<b>Ref. No.</b>	—
<b>description</b>	screw bolt for pilot burner		

ignition electrodes			
 1			
<b>GEV No.</b>	100706	<b>Ref. No.</b>	RX94034642 RX94805207
<b>description</b>	ignition electrode connection M4 Qty 1 pcs		

 1			
<b>GEV No.</b>	100707	<b>Ref. No.</b>	94027729 RX94027729
<b>description</b>	ignition electrode D1 7mm D2 9mm connection 2.4mm L1 14mm L2 6mm BL1 18mm BL2 3mm BL3 23mm to clip Qty 1 pcs		

140 - 145 -150 series			
 1			
<b>GEV No.</b>	107114 <sup>1</sup>	<b>Ref. No.</b>	94805041 RX94805041
<b>description</b>	pilot burner SIT type 140 series 2 flames nozzle 0mm gas connectionmm		
<b>spare parts for</b>	107114		
			
<b>GEV No.</b>	100907	<b>Ref. No.</b>	94805090 RX94805090
<b>description</b>	screw connection thread M10x1 Qty 1 pcs type SEF 1 0mm for thermocouple		
<b>accessories for</b>	107114		
			
<b>GEV No.</b>	100204	<b>Ref. No.</b>	—
<b>description</b>	pilot burner nozzle SIT LPG code 14 bore 0.18/0.20mm Qty 1 pcs suitable for 140 series		
			
<b>GEV No.</b>	100205	<b>Ref. No.</b>	RX822140380
<b>description</b>	pilot burner nozzle SIT LPG code 19 bore 0.23/0.26mm Qty 1 pcs suitable for SIT 150 series		
			
<b>GEV No.</b>	100206	<b>Ref. No.</b>	—
<b>description</b>	pilot burner nozzle SIT natural gas code 36 bore 0.60/0.55mm Qty 1 pcs suitable for SIT 150 series		
			
<b>GEV No.</b>	100207	<b>Ref. No.</b>	RX822140120
<b>description</b>	pilot burner nozzle SIT natural gas code 27 bore 0.40/0.38mm suitable for SIT 140 series		
			
<b>GEV No.</b>	100216	<b>Ref. No.</b>	—
<b>description</b>	pilot burner nozzle SIT natural gas code 38 bore 0.45mm Qty 1 pcs suitable for SIT 150 series		
			
<b>GEV No.</b>	100701	<b>Ref. No.</b>	RX94805066 RX94805306 RX94805686
<b>description</b>	ignition electrode connection M4 Qty 1 pcs		
			
<b>GEV No.</b>	100801	<b>Ref. No.</b>	—
<b>description</b>	gasket for pilot burner Qty 1 pcs		
			
<b>GEV No.</b>	100897	<b>Ref. No.</b>	—
<b>description</b>	olive for pipe 4mm Qty 1 pcs for pilot burner		
			
<b>GEV No.</b>	100898	<b>Ref. No.</b>	—
<b>description</b>	olive for pipe 6mm Qty 1 pcs for pilot burner		
			
<b>GEV No.</b>	100906	<b>Ref. No.</b>	94805082 RX94805082
<b>description</b>	screw connection thread M10x1 for ignition electrode brass Qty 1 pcs WS 10		
			
<b>GEV No.</b>	100908	<b>Ref. No.</b>	94812587 RX94812587
<b>description</b>	union screw thread M10x1 for pipe 4mm Qty 1 pcs		
			
<b>GEV No.</b>	100909	<b>Ref. No.</b>	—
<b>description</b>	union screw thread M10x1 for pipe 6mm Qty 1 pcs		
			
<b>GEV No.</b>	102110	<b>Ref. No.</b>	—
<b>description</b>	pilot tube copper pipe 4mm thickness 1mm L 3000mm		
			
<b>GEV No.</b>	102111	<b>Ref. No.</b>	—
<b>description</b>	pilot tube copper pipe 6mm thickness 1mm L 3000mm		

<sup>1</sup>incl. thermocouple fitting



**POLIDORO**

pilot burners



<b>GEV No.</b>	102295	<b>Ref. No.</b>	94034485 RX94034485
<b>description</b>	pilot burner POLIDORO 3 flames code gas connection 4mm		
<b>spare parts for</b>	102295		
	<b>GEV No.</b>	100907	<b>Ref. No.</b> 94805090 RX94805090
	screw connection thread M10x1 Qty 1 pcs type SEF 1 ømm for thermocouple		
<b>accessories for</b>	102295		
	<b>GEV No.</b>	100208	<b>Ref. No.</b> —
	pilot burner nozzle POLIDORO LPG code 20 bore ø 0.2mm Qty 1 pcs		
	<b>GEV No.</b>	100209	<b>Ref. No.</b> —
	pilot burner nozzle POLIDORO natural gas code 40 bore ø 0.4mm Qty 1 pcs		
	<b>GEV No.</b>	100701	<b>Ref. No.</b> RX94805066 RX94805306 RX94805686
	ignition electrode connection M4 Qty 1 pcs		
	<b>GEV No.</b>	100906	<b>Ref. No.</b> 94805082 RX94805082
	screw connection thread M10x1 for ignition electrode brass Qty 1 pcs WS 10		
	<b>GEV No.</b>	100908	<b>Ref. No.</b> 94812587 RX94812587
	union screw thread M10x1 for pipe ø 4mm Qty 1 pcs		
	<b>GEV No.</b>	100909	<b>Ref. No.</b> —
	union screw thread M10x1 for pipe ø 6mm Qty 1 pcs		
	<b>GEV No.</b>	101280	<b>Ref. No.</b> —
	olive for pipe ø 4mm Qty 1 pcs		
	<b>GEV No.</b>	101287	<b>Ref. No.</b> —
	olive for pipe ø 6mm Qty 1 pcs		
	<b>GEV No.</b>	102110	<b>Ref. No.</b> —
	pilot tube copper pipe ø 4mm thickness 1mm L 3000mm		
	<b>GEV No.</b>	102111	<b>Ref. No.</b> —
	pilot tube copper pipe ø 6mm thickness 1mm L 3000mm		

**AEM**

pilot burners



<b>GEV No.</b>	107529	<b>Ref. No.</b>	RX94044476
<b>description</b>	pilot burner 1 flame LPG nozzle ø 0.22mm gas connection 6mm		



<b>GEV No.</b>	107528	<b>Ref. No.</b>	RX94044477
<b>description</b>	pilot burner 1 flame natural gas nozzle ø 0.4mm gas connection 6mm		

producer-specific pilot burners

**ROSINOX**



<b>GEV No.</b>	107529	<b>Ref. No.</b>	RX94044476
<b>description</b>	pilot burner 1 flame LPG nozzle ø 0.22mm gas connection 6mm		



<b>GEV No.</b>	107528	<b>Ref. No.</b>	RX94044477
<b>description</b>	pilot burner 1 flame natural gas nozzle ø 0.4mm gas connection 6mm		



electrodes

<b>GEV No.</b>	100701	<b>Ref. No.</b>	RX94805066 RX94805306 RX94805686
<b>description</b>	ignition electrode connection M4 Qty 1 pcs		
<b>accessories for</b>	100701		
	<b>GEV No.</b>	100906	<b>Ref. No.</b> 94805082 RX94805082
	screw connection thread M10x1 for ignition electrode brass Qty 1 pcs WS 10		

<b>GEV No.</b>	100706	<b>Ref. No.</b>	RX94034642 RX94805207
<b>description</b>	ignition electrode connection M4 Qty 1 pcs		

<b>GEV No.</b>	102907	<b>Ref. No.</b>	9404421 RX94044214
<b>description</b>	ignition electrode D1 ø 7mm connection F 2.8x0.8mm L1 6mm L2 6mm L3 16mm BL1 50mm to clip		

<b>GEV No.</b>	100732	<b>Ref. No.</b>	RX94805157
<b>description</b>	ignition electrode D1 ø 7mm D2 ø 8.5mm cable length 1750mm BL1 28mm BL2 3mm BL3 23mm to clip connection ø 2.4mm		

<b>GEV No.</b>	100733	<b>Ref. No.</b>	94805132 RX94805132
<b>description</b>	ignition electrode D1 ø 7mm D2 ø 8.5mm cable length 600mm BL1 28mm BL2 3mm BL3 23mm to clip connection ø 2.4mm		

<b>GEV No.</b>	100746	<b>Ref. No.</b>	RX94805140
<b>description</b>	ignition electrode D1 ø 7mm D2 ø 8.5mm cable length 950mm BL1 28mm BL2 3mm BL3 23mm connection ø 2.4mm		

<b>GEV No.</b>	102314	<b>Ref. No.</b>	94034493 RX94034493
<b>description</b>	ignition electrode D1 ø 7mm D2 ø 9mm connection M4 L1 2mm BL1 28mm BL2 3mm BL3 23mm to clip		

<b>GEV No.</b>	100707	<b>Ref. No.</b>	94027729 RX94027729
<b>description</b>	ignition electrode D1 ø 7mm D2 ø 9mm connection ø2.4mm L1 14mm L2 6mm BL1 18mm BL2 3mm BL3 23mm to clip Qty 1 pcs		

<b>GEV No.</b>	100729	<b>Ref. No.</b>	RX94805033
<b>description</b>	ignition electrode L1 5mm D1 ø 8mm D2 ø 10mm BL1 41mm BL2 14mm connection F 2.8x0.8mm to clip with spring		

<b>GEV No.</b>	106525	<b>Ref. No.</b>	94814239 RX94814239
<b>description</b>	ignition electrode set Qty 2 flange length 23mm flange width 15/17mm D1 ø 7/9.5mm L1 80/45mm BL1 33/48mm BL2 57/47mm connection F2.8x0.8 fixing dimensions ø4.5mm		

<b>GEV No.</b>	106516	<b>Ref. No.</b>	RX94805066 RX94805306 RX94805686
<b>description</b>	monitoring electrode D1 ø 7mm D2 ø 8mm connection M4 L1 19mm BL1 18mm BL2 3mm BL3 22mm		

<b>GEV No.</b>	109120	<b>Ref. No.</b>	94051521 RX94051521
<b>description</b>	monitoring electrode flange length 48mm D1 ø 8mm flange width 22.5mm L1 62mm BL1 11mm BL2 8mm connection male faston 6.3mm		

<b>GEV No.</b>	100906	<b>Ref. No.</b>	94805082 RX94805082
<b>description</b>	screw connection thread M10x1 for ignition electrode brass Qty 1 pcs WS 10		

ignition cables

pre-assembled cables

<b>GEV No.</b>	100176	<b>Ref. No.</b>	94805322 RX94805322
<b>description</b>	ignition cable cable length 1000mm connection ø2.4mm / ø4mm permanent temperature 200°C		

<b>GEV No.</b>	107591	<b>Ref. No.</b>	RX94045460
<b>description</b>	ignition cable cable length 1500mm connection F2.8mm / F2.8mm 6mm <sup>2</sup> silicone		

<b>GEV No.</b>	102158	<b>Ref. No.</b>	94805199 RX94805199
<b>description</b>	ignition cable cable length 1750mm connection ø4mm / F2.8mm		

<b>GEV No.</b>	100019	<b>Ref. No.</b>	94805694 RX94805694
<b>description</b>	ignition cable cable length 900mm connection ø2.4mm / ø4mm		



piezoelectric igniters

mounting diameter 18mm



<b>GEV No.</b>	100009	<b>Ref. No.</b>	RX94061157 RX94805009
<b>description</b>	piezoelectric igniter body plastic blowing mounting ø 18mm connection ø2.4mm front measurements 26mm M18x1.5		
<b>accessories for</b>	100009		
	<b>GEV No.</b>	101339	<b>Ref. No.</b> —
	cover cap for piezoelectric igniter		
	<b>GEV No.</b>	106869	<b>Ref. No.</b> —
	cover cap for piezoelectric igniter ID ø 22mm ED ø 35mm H 25mm		
	<b>GEV No.</b>	107931	<b>Ref. No.</b> —
	cover cap for piezoelectric igniter ID ø 21mm ED ø 36mm		

ignition units



<b>GEV No.</b>	101002	<b>Ref. No.</b>	RX94027802
<b>description</b>	ignition unit outputs 2 230VAC dimensions 88x23x34mm mounting distance 73mm inlet F6.3x0.8 outlet F2.8x0.8 0.6VA 50/60Hz		

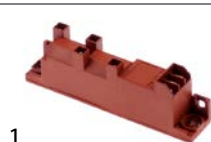

<b>GEV No.</b>	102388	<b>Ref. No.</b>	94039229 94805116 RX94039229 RX94805116
<b>description</b>	ignition unit outputs 4 230VAC dimensions 111x23x34mm mounting distance 100mm inlet F6.3x0.8 outlet F2.8x0.8 type WAC-T4 0.6VA 50/60Hz		

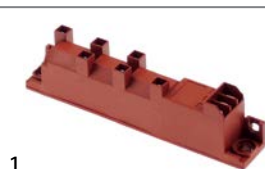

<b>GEV No.</b>	102389	<b>Ref. No.</b>	94805124 RX94805124
<b>description</b>	ignition unit outputs 6 230VAC dimensions 135x23x34mm mounting distance 123mm inlet F6.3x0.8 outlet F2.8x0.8 0.6VA 50/60Hz		

ignition switches



<b>GEV No.</b>	345038	<b>Ref. No.</b>	94805173 RX94805173
<b>description</b>	momentary push switch mounting ø 25mm black 2NO 250V 16A connection male faston 6.3mm ambient temperature max. 85°C protection IP40		

thermocouples

plug-in thermocouples

plug-in thermocouples standard

with barrel socket ø6(6.5)mm

thermocouples SIT

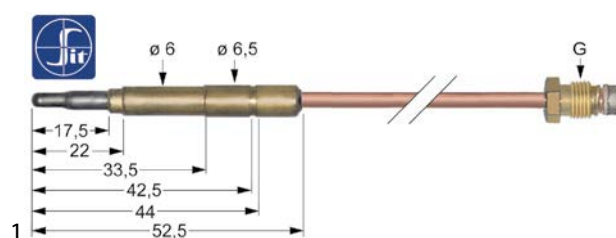

<b>GEV No.</b>	107612	<b>Ref. No.</b>	RX94024973
<b>description</b>	thermocouple SIT M9x1 L 1000mm plug connection ø6.0(6.5)mm		

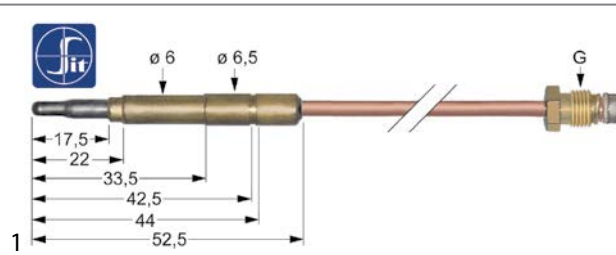

<b>GEV No.</b>	107614	<b>Ref. No.</b>	RX94015112
<b>description</b>	thermocouple SIT M9x1 L 1500mm plug connection ø6.0(6.5)mm		

thermocouples with aluminised tip

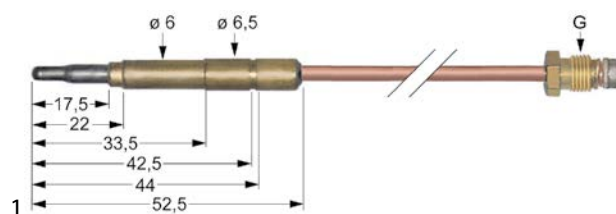

<b>GEV No.</b>	102043	<b>Ref. No.</b>	RX94024973
<b>description</b>	thermocouple M9x1 L 1000mm plug connection ø6.0(6.5)mm		





threaded thermocouples

threaded thermocouples standard

with socket with thread M8x1

SIT

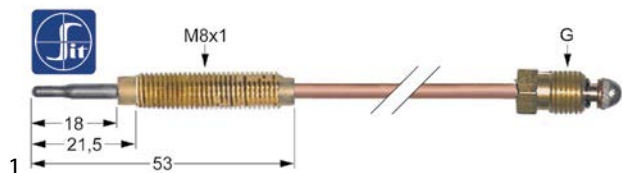

<b>GEV No.</b>	107636	<b>Ref. No.</b>	94805025 RX94805025
<b>description</b>	thermocouple SIT M9x1 L 600mm M8x1		
<b>accessories for</b>	107636		
	<b>GEV No.</b>	102067	<b>Ref. No.</b> —
	nut thread M8x1 H 3mm brass Qty 1 pcs type SEF 1		

thermopiles

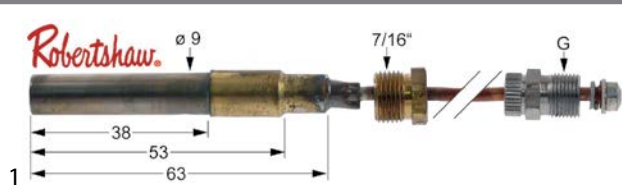

<b>GEV No.</b>	580035	<b>Ref. No.</b>	RX24802365
<b>description</b>	thermopile L 36" - 915mm probe ø 9mm probe L 38mm 250-750mV screw connection 7/16" connection 3/8" NEF		

gas burners

hob burners

universal hob burners

GEV



<b>GEV No.</b>	103068	<b>Ref. No.</b>	RX94805587
<b>description</b>	burner cap ø 100mm		
<b>accessories for</b>	103068		
	<b>GEV No.</b>	103067	<b>Ref. No.</b> 94805595 RX94805595
	burner ring for burner cap ø 100mm		
	<b>GEV No.</b>	104102	<b>Ref. No.</b> RX94805603
	burner head for burner cap ø 100mm ext. ø 130		
	<b>GEV No.</b>	104103	<b>Ref. No.</b> RX94806627
	burner holder suitable for burner ø100mm with nozzle holder		





<b>GEV No.</b>	103066	<b>Ref. No.</b>	RX94805553
<b>description</b>	burner cap ø 80mm		
<b>accessories for</b>	103066		
	<b>GEV No.</b>	103065	<b>Ref. No.</b> RX94805561
	burner ring for burner cap ø 80mm		
	<b>GEV No.</b>	104100	<b>Ref. No.</b> RX94805579
	burner head for burner cap ø 80mm		
	<b>GEV No.</b>	104101	<b>Ref. No.</b> —
	burner holder for burner cap ø 80mm with nozzle holder with mixing sleeve		





<b>GEV No.</b>	104102	<b>Ref. No.</b>	RX94805603
<b>description</b>	burner head for burner cap ø 100mm ext. ø 130		

<b>GEV No.</b>	104100	<b>Ref. No.</b>	RX94805579
<b>description</b>	burner head for burner cap ø 80mm		
<b>accessories for</b>	104100		
	<b>GEV No.</b>	103065	<b>Ref. No.</b> RX94805561
	burner ring for burner cap ø 80mm		
	<b>GEV No.</b>	103066	<b>Ref. No.</b> RX94805553
	burner cap ø 80mm		
	<b>GEV No.</b>	104103	<b>Ref. No.</b> RX94806627
	burner holder suitable for burner ø100mm with nozzle holder		

<b>GEV No.</b>	104103	<b>Ref. No.</b>	RX94806627
<b>description</b>	burner holder suitable for burner ø100mm with nozzle holder		
<b>accessories for</b>	104103		
	<b>GEV No.</b>	103067	<b>Ref. No.</b> 94805595 RX94805595
	burner ring for burner cap ø 100mm		
	<b>GEV No.</b>	103068	<b>Ref. No.</b> RX94805587
	burner cap ø 100mm		
	<b>GEV No.</b>	104102	<b>Ref. No.</b> RX94805603
	burner head for burner cap ø 100mm ext. ø 130		



			
1			
<b>GEV No.</b>	103067	<b>Ref. No.</b>	94805595 RX94805595
<b>description</b>	burner ring for burner cap ø 100mm		
<b>accessories for</b>	103067		
	<b>GEV No.</b>	103068	<b>Ref. No.</b> RX94805587
	burner cap ø 100mm		
	<b>GEV No.</b>	104102	<b>Ref. No.</b> RX94805603
	burner head for burner cap ø 100mm ext. ø 130		
	<b>GEV No.</b>	104103	<b>Ref. No.</b> RX94806627
	burner holder suitable for burner ø100mm with nozzle holder		

			
1			
<b>GEV No.</b>	103065	<b>Ref. No.</b>	RX94805561
<b>description</b>	burner ring for burner cap ø 80mm		
<b>accessories for</b>	103065		
	<b>GEV No.</b>	103066	<b>Ref. No.</b> RX94805553
	burner cap ø 80mm		
	<b>GEV No.</b>	104100	<b>Ref. No.</b> RX94805579
	burner head for burner cap ø 80mm		
	<b>GEV No.</b>	104101	<b>Ref. No.</b> —
	burner holder for burner cap ø 80mm with nozzle holder with mixing sleeve		

			
1			
<b>GEV No.</b>	107332	<b>Ref. No.</b>	94034675 RX94034675
<b>description</b>	burner for burner cap ø 98mm 6kW complete		
<b>spare parts for</b>	107332		
	<b>GEV No.</b>	108015	<b>Ref. No.</b> 9480004 RX94800265
	burner cap ø 100mm mounting ø 97mm		

			
1			
<b>GEV No.</b>	108015	<b>Ref. No.</b>	9480004 RX94800265
<b>description</b>	burner cap ø 100mm mounting ø 97mm		

			
1			
<b>GEV No.</b>	107333	<b>Ref. No.</b>	9780003 RX94800257
<b>description</b>	burner cap ø 78mm 5kW		

producer-specific hob burners

ROSINOX



Era Chef series









			
1			
<b>GEV No.</b>	107334	<b>Ref. No.</b>	94034667 RX94034667
<b>description</b>	burner for burner cap ø 78mm 5kW complete		





Chef 700 series





			
1			
<b>GEV No.</b>	103069	<b>Ref. No.</b>	RX94800182
<b>description</b>	burner cap ø 80mm 4.3kW with central hole		
<b>accessories for</b>	103069		
	<b>GEV No.</b>	100907	<b>Ref. No.</b> 94805090 RX94805090
	screw connection thread M10x1 Qty 1 pcs type SEF 1 ømm for thermocouple		
	<b>GEV No.</b>	101452	<b>Ref. No.</b> 94806049 RX94806049
	ignition electrode support for burner type C/D suitable for 900 series		
	<b>GEV No.</b>	101453	<b>Ref. No.</b> 94806411 RX94806411
	bracket for thermocouple gas range for burner type C/D suitable for 900 series		
	<b>GEV No.</b>	101454	<b>Ref. No.</b> —
	union screw for igniter thread M10x1 ID ø 7mm L 15mm		
	<b>GEV No.</b>	104104	<b>Ref. No.</b> 94800125 RX94800125
	burner head for burner cap ø 80mm 3.5kW code 100212		









Table continues overleaf

<b>accessories for</b> 103069				
	GEV No.	104105	Ref. No.	94806841 RX94806841
burner lower part for burner cap ø 80mm 3.5kW				
	GEV No.	104108	Ref. No.	—
nozzle holder nozzle mounting M10x1 tube ø 10mm gas inlet M16x1.5 gas outlet M14x1				
	GEV No.	105297	Ref. No.	—
burner head for burner cap ø 80mm 4.3kW for pilot burner				

				
<b>1</b>				
<b>GEV No.</b>	103070	<b>Ref. No.</b>	RX94800174	
<b>description</b>	burner cap ø 95mm 6.4kW with central hole			
<b>accessories for</b> 103070				
	GEV No.	100907	Ref. No.	94805090 RX94805090
screw connection thread M10x1 Qty 1 pcs type SEF 1 ømm for thermocouple				
	GEV No.	101452	Ref. No.	94806049 RX94806049
ignition electrode support for burner type C/D suitable for 900 series				
	GEV No.	101453	Ref. No.	94806411 RX94806411
bracket for thermocouple gas range for burner type C/D suitable for 900 series				
	GEV No.	101454	Ref. No.	—
union screw for igniter thread M10x1 ID ø 7mm L 15mm				
	GEV No.	104106	Ref. No.	94800166 RX94800166
burner head for burner cap ø 100mm 5.5kW for igniter				
	GEV No.	104107	Ref. No.	94806437 RX94806437
burner lower part for burner cap ø 100mm 6.4kW				
	GEV No.	104108	Ref. No.	—
nozzle holder nozzle mounting M10x1 tube ø 10mm gas inlet M16x1.5 gas outlet M14x1				

				
<b>1</b>				
<b>GEV No.</b>	104106	<b>Ref. No.</b>	94800166 RX94800166	
<b>description</b>	burner head for burner cap ø 100mm 5.5kW for igniter			
<b>accessories for</b> 104106				
	GEV No.	100907	Ref. No.	94805090 RX94805090
screw connection thread M10x1 Qty 1 pcs type SEF 1 ømm for thermocouple				
	GEV No.	101452	Ref. No.	94806049 RX94806049
ignition electrode support for burner type C/D suitable for 900 series				
	GEV No.	101453	Ref. No.	94806411 RX94806411
bracket for thermocouple gas range for burner type C/D suitable for 900 series				

<b>accessories for</b> 104106				
	GEV No.	101454	Ref. No.	—
union screw for igniter thread M10x1 ID ø 7mm L 15mm				
	GEV No.	103070	Ref. No.	RX94800174
burner cap ø 95mm 6.4kW with central hole				
	GEV No.	104107	Ref. No.	94806437 RX94806437
burner lower part for burner cap ø 100mm 6.4kW				
	GEV No.	104108	Ref. No.	—
nozzle holder nozzle mounting M10x1 tube ø 10mm gas inlet M16x1.5 gas outlet M14x1				

				
<b>1</b>				
<b>GEV No.</b>	104104	<b>Ref. No.</b>	94800125 RX94800125	
<b>description</b>	burner head for burner cap ø 80mm 3.5kW code 100212			
<b>accessories for</b> 104104				
	GEV No.	100907	Ref. No.	94805090 RX94805090
screw connection thread M10x1 Qty 1 pcs type SEF 1 ømm for thermocouple				
	GEV No.	101452	Ref. No.	94806049 RX94806049
ignition electrode support for burner type C/D suitable for 900 series				
	GEV No.	101453	Ref. No.	94806411 RX94806411
bracket for thermocouple gas range for burner type C/D suitable for 900 series				
	GEV No.	101454	Ref. No.	—
union screw for igniter thread M10x1 ID ø 7mm L 15mm				
	GEV No.	103069	Ref. No.	RX94800182
burner cap ø 80mm 4.3kW with central hole				
	GEV No.	104105	Ref. No.	94806841 RX94806841
burner lower part for burner cap ø 80mm 3.5kW				
	GEV No.	104108	Ref. No.	—
nozzle holder nozzle mounting M10x1 tube ø 10mm gas inlet M16x1.5 gas outlet M14x1				



				
<b>1</b>				
<b>GEV No.</b>	104107	<b>Ref. No.</b>	94806437 RX94806437	
<b>description</b>	burner lower part for burner cap ø 100mm 6.4kW			
<b>accessories for</b> 104107				
	GEV No.	100907	Ref. No.	94805090 RX94805090
screw connection thread M10x1 Qty 1 pcs type SEF 1 ømm for thermocouple				

Table continues overleaf



<b>accessories for</b> 104107			
	<b>GEV No.</b>	101452	<b>Ref. No.</b> 94806049 RX94806049
ignition electrode support for burner type C/D suitable for 900 series			
	<b>GEV No.</b>	101453	<b>Ref. No.</b> 94806411 RX94806411
bracket for thermocouple gas range for burner type C/D suitable for 900 series			
	<b>GEV No.</b>	101454	<b>Ref. No.</b> —
union screw for igniter thread M10x1 ID ø 7mm L 15mm			
	<b>GEV No.</b>	103070	<b>Ref. No.</b> RX94800174
burner cap ø 95mm 6.4kW with central hole			
	<b>GEV No.</b>	104106	<b>Ref. No.</b> 94800166 RX94800166
burner head for burner cap ø 100mm 5.5kW for igniter			
	<b>GEV No.</b>	104108	<b>Ref. No.</b> —
nozzle holder nozzle mounting M10x1 tube ø 10mm gas inlet M16x1.5 gas outlet M14x1			

			
<b>GEV No.</b>	104105	<b>Ref. No.</b>	94806841 RX94806841
<b>description</b> burner lower part for burner cap ø 80mm 3.5kW			
<b>accessories for</b> 104105			
	<b>GEV No.</b>	100907	<b>Ref. No.</b> 94805090 RX94805090
screw connection thread M10x1 Qty 1 pcs type SEF 1 ømm for thermocouple			
	<b>GEV No.</b>	101452	<b>Ref. No.</b> 94806049 RX94806049
ignition electrode support for burner type C/D suitable for 900 series			
	<b>GEV No.</b>	101453	<b>Ref. No.</b> 94806411 RX94806411
bracket for thermocouple gas range for burner type C/D suitable for 900 series			
	<b>GEV No.</b>	101454	<b>Ref. No.</b> —
union screw for igniter thread M10x1 ID ø 7mm L 15mm			
	<b>GEV No.</b>	103069	<b>Ref. No.</b> RX94800182
burner cap ø 80mm 4.3kW with central hole			
	<b>GEV No.</b>	104104	<b>Ref. No.</b> 94800125 RX94800125
burner head for burner cap ø 80mm 3.5kW code 100212			
	<b>GEV No.</b>	104108	<b>Ref. No.</b> —
nozzle holder nozzle mounting M10x1 tube ø 10mm gas inlet M16x1.5 gas outlet M14x1			
	<b>GEV No.</b>	105297	<b>Ref. No.</b> —
burner head for burner cap ø 80mm 4.3kW for pilot burner			

<b>Rosi Chef, Royal Chef, Maxi Chef series</b>			
			
<b>GEV No.</b>	107197	<b>Ref. No.</b>	94044420 RX94044420
<b>description</b> burner cap ø 120mm			
<b>accessories for</b> 107197			
	<b>GEV No.</b>	107196	<b>Ref. No.</b> 94044422 RX94044422
burner head for burner cap ø 120mm 10kW H 38mm			
	<b>GEV No.</b>	107198	<b>Ref. No.</b> 94044423 RX94044423
burner lower part for burner cap ø 100/120mm 4.5/7/10kW H 85mm			

			
<b>GEV No.</b>	108078	<b>Ref. No.</b>	RX94044419
<b>description</b> burner cap ø 98mm mounting ø 97mm			

			
<b>GEV No.</b>	107195	<b>Ref. No.</b>	94044421 RX94044421
<b>description</b> burner head for burner cap ø 100mm 7kW H 37mm			
<b>accessories for</b> 107195			
	<b>GEV No.</b>	107198	<b>Ref. No.</b> 94044423 RX94044423
burner lower part for burner cap ø 100/120mm 4.5/7/10kW H 85mm			

			
<b>GEV No.</b>	107196	<b>Ref. No.</b>	94044422 RX94044422
<b>description</b> burner head for burner cap ø 120mm 10kW H 38mm			
<b>accessories for</b> 107196			
	<b>GEV No.</b>	107197	<b>Ref. No.</b> 94044420 RX94044420
burner cap ø 120mm			
	<b>GEV No.</b>	107198	<b>Ref. No.</b> 94044423 RX94044423
burner lower part for burner cap ø 100/120mm 4.5/7/10kW H 85mm			



1

<b>GEV No.</b>	107199	<b>Ref. No.</b>	94044469 RX94044469
<b>description</b>	burner lower part for burner cap ø 100/120mm 4.5/7/10kW H 105mm		



1

<b>GEV No.</b>	107198	<b>Ref. No.</b>	94044423 RX94044423	
<b>description</b>	burner lower part for burner cap ø 100/120mm 4.5/7/10kW H 85mm			
<b>accessories for</b>	107198			
	<b>GEV No.</b>	107195	<b>Ref. No.</b>	94044421 RX94044421
burner head for burner cap ø 100mm 7kW H 37mm				
	<b>GEV No.</b>	107196	<b>Ref. No.</b>	94044422 RX94044422
burner head for burner cap ø 120mm 10kW H 38mm				
	<b>GEV No.</b>	107197	<b>Ref. No.</b>	94044420 RX94044420
burner cap ø 120mm				

**solid tops**



1

<b>GEV No.</b>	107055	<b>Ref. No.</b>	N/A	
<b>description</b>	burner type 1020 ø 80mm L 120mm complete			
<b>spare parts for</b>	107055			
	<b>GEV No.</b>	108031	<b>Ref. No.</b>	—
burner cap ø 78mm with central hole				
	<b>GEV No.</b>	108041	<b>Ref. No.</b>	N/A
burner head ø 84mm seat ø 72mm with central hole				
	<b>GEV No.</b>	108052	<b>Ref. No.</b>	—
nozzle holder size 4/5 thread M26x1				
	<b>GEV No.</b>	108064	<b>Ref. No.</b>	—
air mixing tube size 4/5				



1

<b>GEV No.</b>	108041	<b>Ref. No.</b>	N/A	
<b>description</b>	burner head ø 84mm seat ø 72mm with central hole			
<b>accessories for</b>	108041			
	<b>GEV No.</b>	108031	<b>Ref. No.</b>	—
burner cap ø 78mm with central hole				

**accessories**

**reducers for pan supports**



1

<b>GEV No.</b>	210001	<b>Ref. No.</b>	94806759 RX94806759
<b>description</b>	reducer for pan support L 265mm W 265mm SS suitable for universal		

**pan supports**



1

<b>GEV No.</b>	210264	<b>Ref. No.</b>	RX94039872 RX94070427
<b>description</b>	pan support W 307mm L 388mm H 36mm suitable for ROSINOX		

**bar burners**





1

<b>GEV No.</b>	105494	<b>Ref. No.</b>	94814483 RX94814483
<b>description</b>	bar burner 2 row L 525mm W 200mm ømm H 65mm chargrill		





			
1			
<b>GEV No.</b>	105537	<b>Ref. No.</b>	94812661 RX94812661
<b>description</b>	bar burner angled L 570mm W 310mm ømm Hmm oven		

			
1			
<b>GEV No.</b>	109118	<b>Ref. No.</b>	9456104 RX9400674 RX94006749 RX94561040
<b>description</b>	bar burner L 190mm W 41mm ømm H 56mm flange width 53mm flange length 73mm fryer		

			
1			
<b>GEV No.</b>	109119	<b>Ref. No.</b>	9400671 94006715 RX94006715
<b>description</b>	bar burner L 510mm W 42mm ømm H 57mm flange width 53mm flange length 73mm frying pan		

			
1			
<b>GEV No.</b>	104659	<b>Ref. No.</b>	94494564 RX94494564
<b>description</b>	bar burner ømm W 41.5mm H 56mm L 512mm flange width 53mm flange length 27mm frying pan		

tube burners

			
1			
<b>GEV No.</b>	105527	<b>Ref. No.</b>	94805710 RX94805710
<b>description</b>	tubular burner L 295mm W 55mm H 70mm mounting pos. left for fryer oval		

accessories

nozzle holders

			
1			
<b>GEV No.</b>	104629	<b>Ref. No.</b>	9401873 94018736 RX94018736
<b>description</b>	nozzle holder ID ø 10mm screw pipe fitting M18x1.5 ET 3/8" M13x1 tube ø 12mm		

gas nozzles

main nozzles

gas nozzles 3/8"

			
1			
<b>GEV No.</b>	106543	<b>Ref. No.</b>	RX94033859
<b>description</b>	gas injector thread 3/8" WS 17 bore ø 2.1mm		

gas nozzles M7x1

			
1			
<b>GEV No.</b>	100517	<b>Ref. No.</b>	94812640 RX94812640
<b>description</b>	gas injector thread M7x1 WS 10 bore ø 0.8mm		

			
1			
<b>GEV No.</b>	100519	<b>Ref. No.</b>	94806668 RX94806668
<b>description</b>	gas injector thread M7x1 WS 10 bore ø 0.95mm		

gas nozzles M10x1

			
1			
<b>GEV No.</b>	100635	<b>Ref. No.</b>	RX94812593
<b>description</b>	gas injector thread M10x1 WS 11 bore ø 0.85mm inner peaked		





			
<b>GEV No.</b>	100641	<b>Ref. No.</b>	94806833 RX94806833
<b>description</b>	gas injector thread M10x1 WS 11 bore ø 1.35mm inner peaked		

			
<b>GEV No.</b>	106466	<b>Ref. No.</b>	94806874 RX94806874
<b>description</b>	gas injector thread M10x1 WS 12 bore ø 1.15mm		

			
<b>GEV No.</b>	106453	<b>Ref. No.</b>	RX94033859
<b>description</b>	gas injector thread M10x1 WS 12 bore ø 1.4mm		

			
<b>GEV No.</b>	106295	<b>Ref. No.</b>	94806882 RX94806882
<b>description</b>	gas injector thread M10x1 WS 11 bore ø 0.9mm code 90		

			
<b>GEV No.</b>	102704	<b>Ref. No.</b>	94806890 RX94806890
<b>description</b>	gas injector thread M10x1 WS 11 bore ø 1.2mm		

			
<b>GEV No.</b>	102774	<b>Ref. No.</b>	94812558 RX94812558
<b>description</b>	gas injector thread M10x1 WS 11 bore ø 1.45mm		

			
<b>GEV No.</b>	101997	<b>Ref. No.</b>	94812697 RX94812697
<b>description</b>	gas injector thread M10x1 WS 11 bore ø 1.4mm		

			
<b>GEV No.</b>	102773	<b>Ref. No.</b>	RX94812556
<b>description</b>	gas injector thread M10x1 WS 11 bore ø 1.65mm G20-25		

			
<b>GEV No.</b>	102984	<b>Ref. No.</b>	94812557 RX94812557
<b>description</b>	gas injector thread M10x1 WS 11 bore ø 1.8mm		

			
<b>GEV No.</b>	102703	<b>Ref. No.</b>	94812654 RX94812654
<b>description</b>	gas injector thread M10x1 WS 11 bore ø 1.9mm		

			
<b>GEV No.</b>	106284	<b>Ref. No.</b>	94812555 RX94812555
<b>description</b>	gas injector thread M10x1 WS 11 bore ø 2.15mm		

gas nozzles M13x1

			
<b>GEV No.</b>	107475	<b>Ref. No.</b>	RX94034154
<b>description</b>	gas injector thread M13x1 bore ø 1.85mm WS 13 code 185		



pilot burner nozzles

pilot burner nozzles AEM



1

<b>GEV No.</b>	109126	<b>Ref. No.</b>	94814111 RX94814111
<b>description</b>	pilot burner nozzle natural gas bore ø 0.4mm code 40 thread 7/32" (28G) WS 6 Qty 1 pcs		



1

<b>GEV No.</b>	106427	<b>Ref. No.</b>	9481411 RX94814110
<b>description</b>	pilot burner nozzle natural/liquid gas bore ø 0.3mm code 30 thread 7/32" (28G) WS 6		

pilot burner nozzles POLIDORO



1

<b>GEV No.</b>	106703	<b>Ref. No.</b>	RX94034519
<b>description</b>	pilot burner nozzle POLIDORO natural gas code 27.2 bore ø 2x0.27mm Qty 1 pcs		

pilot burner nozzles SIT

100 series



1

<b>GEV No.</b>	107171	<b>Ref. No.</b>	94812644 RX94812644
<b>description</b>	pilot burner nozzle SIT natural/liquid gas bore ø 0.25mm Qty 1 pcs		

140/150 series



1

<b>GEV No.</b>	100205	<b>Ref. No.</b>	RX822140380
<b>description</b>	pilot burner nozzle SIT LPG code 19 bore ø 0.23/0.26mm Qty 1 pcs suitable for SIT 150 series		



1

<b>GEV No.</b>	100207	<b>Ref. No.</b>	RX822140120
<b>description</b>	pilot burner nozzle SIT natural gas code 27 bore ø 0.40/0.38mm suitable for SIT 140 series		

auxiliary gas parts

screw connections

olives



1

<b>GEV No.</b>	101248	<b>Ref. No.</b>	94810978 RX94810978	
<b>description</b>	olive for pipe ø 12mm Qty 1 pcs suitable for PEL			
<b>accessories for</b>	101248			
	<b>GEV No.</b>	101251	<b>Ref. No.</b>	—
	union nut thread M20x1.5 for pipe ø 12mm			



1

<b>GEV No.</b>	101246	<b>Ref. No.</b>	94812588 RX94812588	
<b>description</b>	olive for pipe ø 4mm Qty 1 pcs			
<b>accessories for</b>	101246			
	<b>GEV No.</b>	100908	<b>Ref. No.</b>	94812587 RX94812587
	union screw thread M10x1 for pipe ø 4mm Qty 1 pcs			

union screws



1

<b>GEV No.</b>	100906	<b>Ref. No.</b>	94805082 RX94805082
<b>description</b>	screw connection thread M10x1 for ignition electrode brass Qty 1 pcs WS 10		



1

<b>GEV No.</b>	100907	<b>Ref. No.</b>	94805090 RX94805090
<b>description</b>	screw connection thread M10x1 Qty 1 pcs type SEF 1 ømm for thermocouple		



1

<b>GEV No.</b>	106597	<b>Ref. No.</b>	94812690 RX94812690
<b>description</b>	union screw thread 3/4" for pipe ø 18mm L 20mm Qty 1 pcs WS 27		



			
1			
<b>GEV No.</b>	100908	<b>Ref. No.</b>	94812587 RX94812587
<b>description</b>	union screw thread M10x1 for pipe ø 4mm Qty 1 pcs		
<b>accessories for</b>	100908		
	<b>GEV No.</b>	100897	<b>Ref. No.</b> —
olive for pipe ø 4mm Qty 1 pcs for pilot burner			
	<b>GEV No.</b>	101246	<b>Ref. No.</b> 94812588 RX94812588
olive for pipe ø 4mm Qty 1 pcs			
	<b>GEV No.</b>	101280	<b>Ref. No.</b> —
olive for pipe ø 4mm Qty 1 pcs			
	<b>GEV No.</b>	101282	<b>Ref. No.</b> —
olive for pipe ø 4mm L 7.4mm Qty 1 pcs			

## angle pieces

			
1			
<b>GEV No.</b>	531261	<b>Ref. No.</b>	RX94025293
<b>description</b>	angle piece thread 1/2" ET - 1/2" ET brass		

## equipment-specific units

## for dough mixers

## flange bearings

			
1			
<b>GEV No.</b>	693112	<b>Ref. No.</b>	RX94806544
<b>description</b>	flange bearing type UCF204 shaft ø 20mm 4 hole flange hole distance 64mm H 33mm flange length 86mm flange width 86mm hole ø 12mm flange F204 ball bearing UC204G2 FH 25.5mm		

## for espresso machines

## brewing units

## filter holder gaskets

## O-rings

			
1			
<b>GEV No.</b>	510409	<b>Ref. No.</b>	RX94807294
<b>description</b>	O-ring EPDM thickness 5.34mm ID ø 56.52mm Qty 1 pcs		

## steam/water taps

## steam/water pipes

## accessories

## gaskets

			
1			
<b>GEV No.</b>	510893	<b>Ref. No.</b>	94807765 RX94807765
<b>description</b>	O-ring EPDM thickness 2.62mm ID ø 9.92mm Qty 1 pcs		

## for coffee grinders

			
1			
<b>GEV No.</b>	345019	<b>Ref. No.</b>	94809944 RX94809944
<b>description</b>	rotary switch sets of contacts 2 2 0-1 type CA0120002 380V 12A shaft ø 5x5mm shaft L 23mm shaft square connection screw		



for pyroceram ranges

ceramic hobs

ceramic glass plates

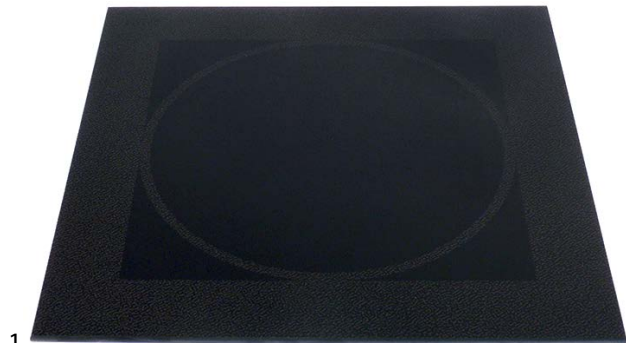

1	<b>GEV No.</b>	694698	<b>Ref. No.</b>	94090016 RX94090016
<b>description</b> ceramic plate L 370mm W 370mm thickness 6mm				

for convection ovens/combi-steamers

spare parts and accessories



1	<b>GEV No.</b>	698483	<b>Ref. No.</b>	RX94003753
<b>description</b> bearing bolt L 17mm ø 12.2mm WS 15 ext. ø M8				



1	<b>GEV No.</b>	512418	<b>Ref. No.</b>	RX94050556
<b>description</b> cotter pin D1 ø 8.6mm hole ø 5.5mm Qty 1 pcs total length 40.4mm				



1	<b>GEV No.</b>	512417	<b>Ref. No.</b>	RX94020211
<b>description</b> hexagonal nut WS 16 thread M10 black suitable for ROSINOX Qty 1m				

miscellaneous



1	<b>GEV No.</b>	510558	<b>Ref. No.</b>	24556078 RX24556078
<b>description</b> connection for pump				



1	<b>GEV No.</b>	694527	<b>Ref. No.</b>	24390627 RX24390627
<b>description</b> gasket rubber ED ø 57mm ID ø 39mm thickness 4mm for combi-steamer Qty 1 pcs suitable for RATIONAL				

for tilting bratt pans

spindles



1	<b>GEV No.</b>	693127	<b>Ref. No.</b>	94806569 RX94806569
<b>description</b> threaded part				



1	<b>GEV No.</b>	693128	<b>Ref. No.</b>	94806551 RX94806551
<b>description</b> threaded rod L 350mm				

for boiling pans

level controllers



1	<b>GEV No.</b>	698489	<b>Ref. No.</b>	RX94045667 RX94445582
<b>description</b> level tank metal bore ø 11.5mm L 257mm W 30mm H 50mm				



## level glasses

## complete



1

<b>GEV No.</b>	540706	<b>Ref. No.</b>	RX94800216
<b>description</b>	level glass hole distance 76mm mounting thread M10 L 107mm W 28mm plastic/SS for kettle model ELESA HCX-76-BW-SST		

## miscellaneous

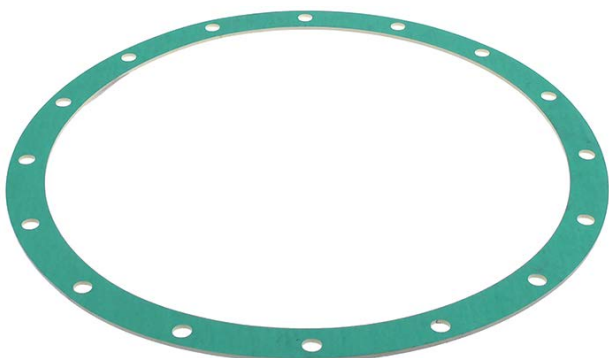

1

<b>GEV No.</b>	698486	<b>Ref. No.</b>	RX94013612
<b>description</b>	gasket ext. $\varnothing$ 390 ID $\varnothing$ 340mm bores 16 hole $\varnothing$ 10mm		

## for ovens

## housing and bezels



1

<b>GEV No.</b>	698493	<b>Ref. No.</b>	RX94545373
<b>description</b>	sheet L 142mm W 30mm H 82mm for ignition electrode		

## miscellaneous



1

<b>GEV No.</b>	696492	<b>Ref. No.</b>	94001971 RX94001971
<b>description</b>	stop for oven door L 137mm W 76mm H 3mm		

## for dishwashers

## containers

## salt tanks



1

<b>GEV No.</b>	517398	<b>Ref. No.</b>	RX94810355
<b>description</b>	flat gasket rubber ED $\varnothing$ 82mm ID $\varnothing$ 66mm thickness 4mm for salt tank Qty 1 pcs		



1

<b>GEV No.</b>	510929	<b>Ref. No.</b>	94808755 RX94808755
<b>description</b>	salt tank $\varnothing$ 120mm H 117mm hose $\varnothing$ 10mm mounting $\varnothing$ 70mm overall height 157mm		

## spare parts for 510929

	<b>GEV No.</b>	506015	<b>Ref. No.</b>	94810256 RX94810256
---	----------------	--------	-----------------	------------------------

O-ring EPDM thickness 3.53mm ID  $\varnothing$  39.69mm Qty 1 pcs

	<b>GEV No.</b>	510018	<b>Ref. No.</b>	—
---	----------------	--------	-----------------	---

nut  $\varnothing$  92mm H 10.5mm for salt tank ID  $\varnothing$  64mm

	<b>GEV No.</b>	524177	<b>Ref. No.</b>	—
---	----------------	--------	-----------------	---

lid  $\varnothing$  69mm H 20mm for salt tank ID  $\varnothing$  50mm

## accessories for 510929

	<b>GEV No.</b>	510071	<b>Ref. No.</b>	—
---	----------------	--------	-----------------	---

flat gasket rubber ED  $\varnothing$  81mm ID  $\varnothing$  68mm thickness 3mm for salt tank Qty 1 pcs

	<b>GEV No.</b>	510654	<b>Ref. No.</b>	—
---	----------------	--------	-----------------	---

gasket H 6mm D1  $\varnothing$  82mm D2  $\varnothing$  68mm

Table continues overleaf



<b>accessories for</b>	510929		
	<b>GEV No.</b>	510883	<b>Ref. No.</b> —
	gasket rubber ED ø 86mm ID ø 66mm thickness 2mm for salt tank Qty 1 pcs		

**boilers**

**boilers for dishwashers**

	1		
<b>GEV No.</b>	517402	<b>Ref. No.</b>	94810306 RX94810306
<b>description</b>	boiler		

	1		
<b>GEV No.</b>	518583	<b>Ref. No.</b>	RX94804416
<b>description</b>	boiler ø 110mm L 295mm		



	1		
<b>GEV No.</b>	517295	<b>Ref. No.</b>	94810913 RX94810913
<b>description</b>	boiler ø 113mm L 370mm		

	1		
<b>GEV No.</b>	517300	<b>Ref. No.</b>	94810660 RX94810660
<b>description</b>	boiler ø 140mm L 390mm		

	1		
<b>GEV No.</b>	518377	<b>Ref. No.</b>	94804051 RX94804051
<b>description</b>	boiler ø 150mm L 360mm		

	1		
<b>GEV No.</b>	524450	<b>Ref. No.</b>	RX94814261
<b>description</b>	boiler ø 150mm L 445mm inlet ø 11		

	1		
<b>GEV No.</b>	512000	<b>Ref. No.</b>	94814267 RX94814267
<b>description</b>	boiler ø 150mm L 500mm		

	1		
<b>GEV No.</b>	517394	<b>Ref. No.</b>	94810314 RX94810314
<b>description</b>	boiler ø 160mm L 530mm with insulation		
<b>spare parts for</b>	517394		
	<b>GEV No.</b>	517336	<b>Ref. No.</b> —
	insulating mat boiler L 500mm W 155mm		
	<b>GEV No.</b>	517337	<b>Ref. No.</b> —
	insulating mat boiler ø 160mm		

	1		
<b>GEV No.</b>	517302	<b>Ref. No.</b>	94807930 RX94807930
<b>description</b>	boiler with insulation ø 160mm L 500mm		
<b>accessories for</b>	517302		
	<b>GEV No.</b>	517337	<b>Ref. No.</b> —
	insulating mat boiler ø 160mm		

			
1			
<b>GEV No.</b>	517303	<b>Ref. No.</b>	94810957 RX94810957
<b>description</b>	boiler with insulation ø 160mm L 530mm flange 4 hole flange inlet ø 12		

## accessories

			
1			
<b>GEV No.</b>	517125	<b>Ref. No.</b>	94809787 RX94809787
<b>description</b>	hose connector		

## softener cartridges

## softening columns

			
1			
<b>GEV No.</b>	530000	<b>Ref. No.</b>	RX94801297
<b>description</b>	softener 4-fold L 380mm W 180mm		

## housing and bezels



## fascias

			
1			
<b>GEV No.</b>	996014	<b>Ref. No.</b>	94814090 RX94814090
<b>description</b>	cover for boiler H 40mm ø 125mm		

## miscellaneous

			
1			
<b>GEV No.</b>	517400	<b>Ref. No.</b>	RX94810876
<b>description</b>	bearing for door rubber ID ø 12mm mounting pos. left		

			
1			
<b>GEV No.</b>	698297	<b>Ref. No.</b>	RX94814294
<b>description</b>	duct ID ø 35mm ED ø 51mm thickness 14mm		

			
1			
<b>GEV No.</b>	524076	<b>Ref. No.</b>	94807410 RX94807410
<b>description</b>	magnet holder internal size 13mm H 60mm for dishwasher		
<b>accessories for</b>	524076		
	<b>GEV No.</b>	524655	<b>Ref. No.</b>
			—
	screw cap for magnet holder thread M16x1.25 SS WS 19		

## gearboxes

			
1			
<b>GEV No.</b>	518634	<b>Ref. No.</b>	94804317 RX94804317
<b>description</b>	gearbox motor shaft ø 14mm flange ø 160mm drive shaft ø 25mm type VF49A60		

hood mechanics for dishwashers

bolts

			
1			
<b>GEV No.</b>	510988	<b>Ref. No.</b>	94813785 RX94813785
<b>description</b>	bolt for hood joint		

bushes

			
1			
<b>GEV No.</b>	512423	<b>Ref. No.</b>	RX94814308
<b>description</b>	bush for hood handle		

			
1			
<b>GEV No.</b>	517282	<b>Ref. No.</b>	94809373 RX94809373
<b>description</b>	cylinder liner hood mechanics		

spring holders

			
1			
<b>GEV No.</b>	517285	<b>Ref. No.</b>	94810934 RX94810934
<b>description</b>	spring holder		

guide bars

			
1			
<b>GEV No.</b>	517358	<b>Ref. No.</b>	RX94814004
<b>description</b>	guide bar L 600mm for hood mechanics		

			
1			
<b>GEV No.</b>	517378	<b>Ref. No.</b>	RX94814059
<b>description</b>	guide bar L 650mm mounting pos. left for hood mechanics thickness 25mm		

			
1			
<b>GEV No.</b>	513019	<b>Ref. No.</b>	RX94814058
<b>description</b>	guide bar L 695mm mounting pos. right thickness 25mm		

			
1			
<b>GEV No.</b>	524800	<b>Ref. No.</b>	RX94814042
<b>description</b>	guide bar L 700mm for hood W 26mm H 21mm		

rollers

			
1			
<b>GEV No.</b>	524805	<b>Ref. No.</b>	RX94810936
<b>description</b>	roller ø 23mm H 9.6mm for hood mechanics plastic white hole ø 8mm		

miscellaneous

			
1			
<b>GEV No.</b>	517283	<b>Ref. No.</b>	RX94809381
<b>description</b>	roller for hood handle		

basket guides

guide bars





			
1			
<b>GEV No.</b>	517813	<b>Ref. No.</b>	94814102 RX94814102
<b>description</b>	basket guide mounting pos. left/right L 450mm W 3.5mm H 37.5mm		

## air traps

## air traps



1

<b>GEV No.</b>	510347	<b>Ref. No.</b>	94813804 RX94813804
<b>description</b>	air trap		
<b>spare parts for</b>	510347		
	GEV No.	510877	Ref. No. —
	flat gasket rubber ED ø 18mm ID ø 10mm thickness 3mm Qty 1 pcs		
	GEV No.	560197	Ref. No. —
	nut thread M10 H 8mm WS 17 SS DIN/ISO DIN 934 / ISO 4032/8673 Qty 1 pcs		
<b>accessories for</b>	510347		
	GEV No.	510877	Ref. No. —
	flat gasket rubber ED ø 18mm ID ø 10mm thickness 3mm Qty 1 pcs		
	GEV No.	560197	Ref. No. —
	nut thread M10 H 8mm WS 17 SS DIN/ISO DIN 934 / ISO 4032/8673 Qty 1 pcs		









1

<b>GEV No.</b>	510757	<b>Ref. No.</b>	RX94804838
<b>description</b>	air trap		



1

<b>GEV No.</b>	510759	<b>Ref. No.</b>	94802857 RX94802857
<b>description</b>	air trap		
<b>spare parts for</b>	510759		
	GEV No.	502036	Ref. No. —
	O-ring EPDM thickness 2.62mm ID ø 28.25mm Qty 1 pcs		
	GEV No.	510760	Ref. No. 94801479 RX94801479
	hose connector		
	GEV No.	510761	Ref. No. 94801495 RX94801495
	flat gasket rubber D1 ø 38mm D2 ø 25mm thickness 2mm Qty 1 pcs		
<b>accessories for</b>	510759		
	GEV No.	510760	Ref. No. 94801479 RX94801479
	hose connector		
	GEV No.	510761	Ref. No. 94801495 RX94801495
	flat gasket rubber D1 ø 38mm D2 ø 25mm thickness 2mm Qty 1 pcs		
	GEV No.	512283	Ref. No. —
	flat gasket rubber D1 ø 38.5mm D2 ø 24.5mm thickness 2mm Qty 1 pcs		





1

<b>GEV No.</b>	517308	<b>Ref. No.</b>	94809852 RX94809852
<b>description</b>	air trap H 65mm		





1

<b>GEV No.</b>	517170	<b>Ref. No.</b>	94809886 RX94809886
<b>description</b>	air trap H 75mm		
<b>accessories for</b>	517170		
	GEV No.	517173	Ref. No. 94810941 RX94810941
	flat gasket FIBER ED ø 14mm ID ø 8mm thickness 1.5mm Qty 1 pcs		
	GEV No.	517174	Ref. No. —
	nut thread M8 H 6.5mm WS 13 SS DIN/ISO DIN 934 / ISO 4032/8673 Qty 1 pcs		



1

<b>GEV No.</b>	517171	<b>Ref. No.</b>	RX94809878
<b>description</b>	air trap L 90mm W 55mm H 31mm		
<b>accessories for</b>	517171		
	GEV No.	517173	Ref. No. 94810941 RX94810941
	flat gasket FIBER ED ø 14mm ID ø 8mm thickness 1.5mm Qty 1 pcs		
	GEV No.	517174	Ref. No. —
	nut thread M8 H 6.5mm WS 13 SS DIN/ISO DIN 934 / ISO 4032/8673 Qty 1 pcs		



1

<b>GEV No.</b>	516218	<b>Ref. No.</b>	94812400 RX94812400
<b>description</b>	air trap ø 34mm		

## air trap accessories



1

<b>GEV No.</b>	510761	<b>Ref. No.</b>	94801495 RX94801495
<b>description</b>	flat gasket rubber D1 ø 38mm D2 ø 25mm thickness 2mm Qty 1 pcs		







			
1			
<b>GEV No.</b>	510760	<b>Ref. No.</b>	94801479 RX94801479
<b>description</b>	hose connector		

mechanics for flight type dishwashers

			
1			
<b>GEV No.</b>	524455	<b>Ref. No.</b>	94810893 RX94810893
<b>description</b>	drive shaft for transport system L 225mm ø 120mm suitable for Dihr		
<b>accessories for</b>	524455		
	<b>GEV No.</b>	524456	<b>Ref. No.</b>
			94807195 RX94807195
	roller for drive shaft L 27.3mm ø 30mm hole ø 12.5mm suitable for Dihr		

			
1			
<b>GEV No.</b>	698412	<b>Ref. No.</b>	94813961 RX94813961
<b>description</b>	gear wheel teeth 8 shaft intake ø 20mm ø 133mm tooth width 11mm plastic W 40mm for transport system suitable for dishwasher		

			
1			
<b>GEV No.</b>	524456	<b>Ref. No.</b>	94807195 RX94807195
<b>description</b>	roller for drive shaft L 27.3mm ø 30mm hole ø 12.5mm suitable for Dihr		
<b>accessories for</b>	524456		
	<b>GEV No.</b>	524455	<b>Ref. No.</b>
			94810893 RX94810893
	drive shaft for transport system L 225mm ø 120mm suitable for Dihr		

			
1			
<b>GEV No.</b>	524511	<b>Ref. No.</b>	RX94804663
<b>description</b>	roller for transport system W 20mm ED ø 24.5mm hole ø 8mm		

			
1			
<b>GEV No.</b>	517371	<b>Ref. No.</b>	RX94807971
<b>description</b>	roller L 22mm ø 24.5mm hole ø 8mm suitable for Dihr		

			
1			
<b>GEV No.</b>	517356	<b>Ref. No.</b>	94809688 RX94809688
<b>description</b>	spacer for spindle ø 32mm		

			
1			
<b>GEV No.</b>	524971	<b>Ref. No.</b>	94814000 RX94814000
<b>description</b>	tappet for dishwasher L 75mm W 36mm H 90mm hole ø 9mm suitable for Dihr		

backflow preventers

			
1			
<b>GEV No.</b>	516101	<b>Ref. No.</b>	94813738 RX94813738
<b>description</b>	backflow preventer dishwasher hose ø 12mm		
<b>spare parts for</b>	516101		
	<b>GEV No.</b>	506367	<b>Ref. No.</b>
			—
	 flat gasket rubber ED ø 40mm ID ø 28mm thickness 1.8mm Qty 1 pcs		

door mechanics

			
1			
<b>GEV No.</b>	518355	<b>Ref. No.</b>	94812350 RX94812350
<b>description</b>	door pin stop rod		

1 

<b>GEV No.</b>	512370	<b>Ref. No.</b>	94813839 RX94813839
<b>description</b>	door pin tie bar		

1 

<b>GEV No.</b>	517269	<b>Ref. No.</b>	94809431 RX94809431
<b>description</b>	door pin tie bar		

1 

<b>GEV No.</b>	512026	<b>Ref. No.</b>	94813842 RX94813842
<b>description</b>	tie bar L 235mm thread M5		

threaded shafts

1 

<b>GEV No.</b>	512371	<b>Ref. No.</b>	94813838 RX94813838
<b>description</b>	threaded part threaded part		

sliding plates

1 

<b>GEV No.</b>	517264	<b>Ref. No.</b>	94810769 RX94810769
<b>description</b>	sliding plate sliding plate		

1 



<b>GEV No.</b>	518356	<b>Ref. No.</b>	94804028 RX94804028
<b>description</b>	sliding plate sliding plate		

hinges



1 

<b>GEV No.</b>	517268	<b>Ref. No.</b>	RX94809449
<b>description</b>	bush ID ø 8mm H 9mm bush thread M11x1 WS 13		

1 

<b>GEV No.</b>	517267	<b>Ref. No.</b>	94809423 RX94809423	
<b>description</b>	door hinge hinge mounting pos. left			
<b>accessories for</b>	517267			
	<b>GEV No.</b>	517266	<b>Ref. No.</b>	94809415 RX94809415
door hinge hinge mounting pos. right				
	<b>GEV No.</b>	517268	<b>Ref. No.</b>	RX94809449
bush ID ø 8mm H 9mm bush thread M11x1 WS 13				

1 

<b>GEV No.</b>	517266	<b>Ref. No.</b>	94809415 RX94809415	
<b>description</b>	door hinge hinge mounting pos. right			
<b>accessories for</b>	517266			
	<b>GEV No.</b>	517267	<b>Ref. No.</b>	94809423 RX94809423
door hinge hinge mounting pos. left				
	<b>GEV No.</b>	517268	<b>Ref. No.</b>	RX94809449
bush ID ø 8mm H 9mm bush thread M11x1 WS 13				

hinge pins

1 

<b>GEV No.</b>	511375	<b>Ref. No.</b>	RX94814270
<b>description</b>	hinge pin ø 6mm D1 ø 4mm L 55mm thread M4 stainless steel		

door guides

1 

<b>GEV No.</b>	508421	<b>Ref. No.</b>	94814063 RX94814063
<b>description</b>	opposite support conversion kit		



door bumpers



1			
<b>GEV No.</b>	510957	<b>Ref. No.</b>	94813763 RX94813763
<b>description</b>	door bumper end stop		



1			
<b>GEV No.</b>	518354	<b>Ref. No.</b>	94804010 RX94804010
<b>description</b>	door bumper slotted hole disc		

locks



1			
<b>GEV No.</b>	512369	<b>Ref. No.</b>	94801024 RX94801024
<b>description</b>	counterpart door catch		



1			
<b>GEV No.</b>	512160	<b>Ref. No.</b>	94801008 RX94801008
<b>description</b>	door catch		

accessories for 512160



<b>GEV No.</b>	512369	<b>Ref. No.</b>	94801024 RX94801024
<b>description</b>	counterpart door catch		



1			
<b>GEV No.</b>	517275	<b>Ref. No.</b>	94808300 RX94808300
<b>description</b>	door catch catch		



1			
<b>GEV No.</b>	510008	<b>Ref. No.</b>	94813865 RX94813865
<b>description</b>	door catch for dishwasher		

miscellaneous



1			
<b>GEV No.</b>	524955	<b>Ref. No.</b>	RX94810868
<b>description</b>	bearing for door ID ø 12mm H 22mm L 32mm W 9mm mounting pos. right		

screw connections



1			
<b>GEV No.</b>	512074	<b>Ref. No.</b>	94813714 RX94813714
<b>description</b>	nut thread 1/2" H 7mm WS 27 plastic Qty 1 pcs		



1			
<b>GEV No.</b>	506027	<b>Ref. No.</b>	94810944 RX94810944
<b>description</b>	nut thread 2" for intake body		



1			
<b>GEV No.</b>	517007	<b>Ref. No.</b>	94808151 RX94808151
<b>description</b>	screw connection		



1

<b>GEV No.</b>	512177	<b>Ref. No.</b>	94813796 RX94813796
<b>description</b>	screw connection thread 1/4" H 27mm Qty 1 pcs		



1

<b>GEV No.</b>	512178	<b>Ref. No.</b>	94813798 RX94813798
<b>description</b>	screw connection thread M16x1.25 H 31mm Qty 1 pcs		

## curtains

## curtains



1

<b>GEV No.</b>	533006	<b>Ref. No.</b>	RX94807039
<b>description</b>	curtain W 545mm H 590mm LANG thickness 1.6mm		

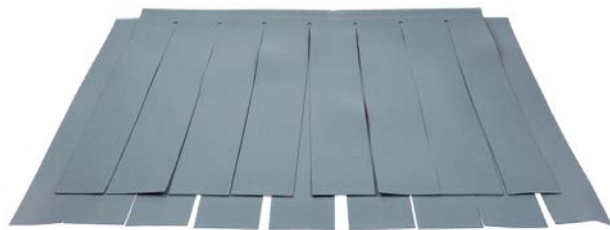

1

<b>GEV No.</b>	524801	<b>Ref. No.</b>	RX94807278
<b>description</b>	curtain W 620mm H 500mm plastic thickness 1.4mm for dishwasher		

## curtain rods



1

<b>GEV No.</b>	533017	<b>Ref. No.</b>	RX94807385
<b>description</b>	curtain rod L 635mm ø 8mm		

## washing and rinsing systems



1

<b>GEV No.</b>	519033	<b>Ref. No.</b>	94800794 RX94800794
<b>description</b>	bush for rinse arm		



1

<b>GEV No.</b>	511240	<b>Ref. No.</b>	RX94813750
<b>description</b>	bush for wash arm		



1

<b>GEV No.</b>	511434	<b>Ref. No.</b>	RX94813751
<b>description</b>	bush for wash arm		



1

<b>GEV No.</b>	512047	<b>Ref. No.</b>	94801131 RX94801131
<b>description</b>	bush for wash arm		





1

<b>GEV No.</b>	512053	<b>Ref. No.</b>	94813724 RX94813724
<b>description</b>	bush for wash arm		





			
1			
<b>GEV No.</b>	512062	<b>Ref. No.</b>	94813850 RX94813850
<b>description</b>	bush for wash arm		

			
1			
<b>GEV No.</b>	517682	<b>Ref. No.</b>	RX94810033
<b>description</b>	bush for wash arm mounting pos. upper H 52mm thread 1¼" D1 ø 54mm D2 ø 41mm Qty 1 pcs		

			
1			
<b>GEV No.</b>	512064	<b>Ref. No.</b>	94814258 RX94814258
<b>description</b>	bush for wash arm		

			
1			
<b>GEV No.</b>	517341	<b>Ref. No.</b>	94813969 RX94813969
<b>description</b>	bush ID ø 16mm ED ø 48mm		

			
1			
<b>GEV No.</b>	512275	<b>Ref. No.</b>	RX94813851
<b>description</b>	bush for wash arm		



			
1			
<b>GEV No.</b>	512211	<b>Ref. No.</b>	94813743 RX94813743
<b>description</b>	bushing for rinse arm		

			
1			
<b>GEV No.</b>	512383	<b>Ref. No.</b>	94802915 RX94802915
<b>description</b>	bush for wash arm		

			
1			
<b>GEV No.</b>	517094	<b>Ref. No.</b>	94813981 RX94813981
<b>description</b>	cover for rinse arm shaft H 108mm D1 ø 28mm		

			
1			
<b>GEV No.</b>	517086	<b>Ref. No.</b>	RX94808110
<b>description</b>	bush for wash arm		

			
1			
<b>GEV No.</b>	517130	<b>Ref. No.</b>	RX94814012
<b>description</b>	cover wash arm support mounting pos. lower		

			
1			
<b>GEV No.</b>	519167	<b>Ref. No.</b>	94800810 RX94800810
<b>description</b>	bush for wash arm		
<b>accessories for</b>	519167		
			
<b>GEV No.</b>	519087	<b>Ref. No.</b>	94800687 RX94800687
<b>description</b>	locknut for wash arm		

			
1			
<b>GEV No.</b>	517629	<b>Ref. No.</b>	RX94802824
<b>description</b>	disc for rinse arm ø 12/18mm		





			
1			
<b>GEV No.</b>	517628	<b>Ref. No.</b>	RX94801644
<b>description</b>	disc for rinse arm ø 16mm		

			
1			
<b>GEV No.</b>	517374	<b>Ref. No.</b>	94808235 RX94808235
<b>description</b>	duct D1 ø 20mm D2 ø 14mm L 17mm int. ø 1 10mm		

			
1			
<b>GEV No.</b>	517114	<b>Ref. No.</b>	94810949 RX94810949
<b>description</b>	extension for wash arm support		

			
1			
<b>GEV No.</b>	512259	<b>Ref. No.</b>	94802980 RX94802980
<b>description</b>	flange for wash arm support		

			
1			
<b>GEV No.</b>	517095	<b>Ref. No.</b>	94810986 RX94810986
<b>description</b>	flange ø 60mm		

			
1			
<b>GEV No.</b>	530430	<b>Ref. No.</b>	RX94813982
<b>description</b>	gasket for rinse pipe rubber ø 33mm ID ø 24mm thickness 11mm for Silanos		

			
1			
<b>GEV No.</b>	505314	<b>Ref. No.</b>	94801735 RX94801735
<b>description</b>	gasket for wash arm thickness 1mm L 74.5mm W 42mm		

			
1			
<b>GEV No.</b>	512257	<b>Ref. No.</b>	94813825 RX94813825
<b>description</b>	knurled nut thread M10L ø 30mm H 6.5mm SS		

			
1			
<b>GEV No.</b>	512212	<b>Ref. No.</b>	94813745 RX94813745
<b>description</b>	knurled nut thread M10x1.5 ø 30mm H 6.4mm SS		

			
1			
<b>GEV No.</b>	519087	<b>Ref. No.</b>	94800687 RX94800687
<b>description</b>	locknut for wash arm		

			
1			
<b>GEV No.</b>	518238	<b>Ref. No.</b>	94803434 RX94803434
<b>description</b>	manifold ø 12mm L 98mm		

			
1			
<b>GEV No.</b>	517070	<b>Ref. No.</b>	94810960 RX94810960
<b>description</b>	nut for wash arm		

			
1			
<b>GEV No.</b>	517154	<b>Ref. No.</b>	94810925 RX94810925
<b>description</b>	nut mounting pos. upper for wash arm support		





 <p>1</p>			
<b>GEV No.</b>	517010	<b>Ref. No.</b>	94808797 RX94808797
<b>description</b>	rinse arm complete		

 <p>1</p>			
<b>GEV No.</b>	519197	<b>Ref. No.</b>	RX94800695
<b>description</b>	rinse arm shaft		

 <p>1</p>			
<b>GEV No.</b>	517155	<b>Ref. No.</b>	94814017 RX94814017
<b>description</b>	rinse arm support for stationary arms mounting pos. upper		

 <p>1</p>			
<b>GEV No.</b>	517161	<b>Ref. No.</b>	94810744 RX94810744
<b>description</b>	rinse arm support mounting pos. upper		

 <p>1</p>			
<b>GEV No.</b>	512280	<b>Ref. No.</b>	94813823 RX94813823
<b>description</b>	rinse pipe		

 <p>1</p>			
<b>GEV No.</b>	517113	<b>Ref. No.</b>	94810948 RX94810948
<b>description</b>	rinse pipe		

 <p>1</p>			
<b>GEV No.</b>	517116	<b>Ref. No.</b>	94807740 RX94807740
<b>description</b>	rinse pipe		

 <p>1</p>			
<b>GEV No.</b>	517119	<b>Ref. No.</b>	RX94814026
<b>description</b>	rinse pipe		

 <p>1</p>			
<b>GEV No.</b>	517132	<b>Ref. No.</b>	94814013 RX94814013
<b>description</b>	rinse pipe		

 <p>1</p>			
<b>GEV No.</b>	517153	<b>Ref. No.</b>	94809456 RX94809456
<b>description</b>	rinse pipe		

 <p>1</p>			
<b>GEV No.</b>	517157	<b>Ref. No.</b>	94814016 RX94814016
<b>description</b>	rinse pipe		

 <p>1</p>			
<b>GEV No.</b>	518471	<b>Ref. No.</b>	94804572 RX94804572
<b>description</b>	rinse pipe		

 <p>1</p>			
<b>GEV No.</b>	517140	<b>Ref. No.</b>	94814072 RX94814072
<b>description</b>	rinse pipe mounting pos. lower		

 <p>1</p>			
<b>GEV No.</b>	512197	<b>Ref. No.</b>	94813786 RX94813786
<b>description</b>	rinse pipe mounting pos. lower ø 10/12mm L 270mm		

 <p>1</p>			
<b>GEV No.</b>	524514	<b>Ref. No.</b>	94813795 RX94813795
<b>description</b>	rinse pipe mounting pos. upper ø 12mm L 265mm		

 <p>1</p>			
<b>GEV No.</b>	518003	<b>Ref. No.</b>	94803962 RX94803962
<b>description</b>	screw cap		

			
1			
<b>GEV No.</b>	517115	<b>Ref. No.</b>	94814413 RX94814413
<b>description</b>	spacer piece		

			
1			
<b>GEV No.</b>	512043	<b>Ref. No.</b>	94813680 RX94813680
<b>description</b>	throttle disc		

			
1			
<b>GEV No.</b>	517139	<b>Ref. No.</b>	94813954 RX94813954
<b>description</b>	throttle disc		

			
1			
<b>GEV No.</b>	519085	<b>Ref. No.</b>	94800802 RX94800802
<b>description</b>	Thumb screw ø 34mm thread M6		

			
1			
<b>GEV No.</b>	510112	<b>Ref. No.</b>	94803970 RX94803970
<b>description</b>	Thumb screw thread M10 thread L 10mm ø 22mm H 4.5mm SS		

			
1			
<b>GEV No.</b>	512307	<b>Ref. No.</b>	94801198 RX94801198
<b>description</b>	wash arm bearing		

			
1			
<b>GEV No.</b>	517071	<b>Ref. No.</b>	94809522 RX94809522
<b>description</b>	wash arm bearing		



			
1			
<b>GEV No.</b>	517118	<b>Ref. No.</b>	94810116 RX94810116
<b>description</b>	wash arm support mounting pos. lower		

			
1			
<b>GEV No.</b>	517382	<b>Ref. No.</b>	94814300 RX94814300
<b>description</b>	wash pipe L 635mm stainless steel suitable for Dihr		

## knobs

### producer-specific knobs

#### ROSINOX

			
1			
<b>GEV No.</b>	111479	<b>Ref. No.</b>	9403093 94030939 RX94030939
<b>description</b>	knob ø 38mm shaft ø 16x16mm chrome		
<b>accessories for</b>	111479		
	<b>GEV No.</b>	111481	<b>Ref. No.</b>
			9400687 94006871 RX94006871
knob adapter shaft ø 8x8mm for water tap			



accessories

fascias



<b>GEV No.</b>	111811	<b>Ref. No.</b>	94812686 RX94812686
----------------	--------	-----------------	------------------------

**description** bezel ø 72.5mm

**accessories for** 111811



<b>GEV No.</b>	560056	<b>Ref. No.</b>	—
----------------	--------	-----------------	---

clamping washer nominal-ø 4mm ED ø 10mm spring steel

knob adaptors



<b>GEV No.</b>	111482	<b>Ref. No.</b>	9400683 94006830 RX94006830
----------------	--------	-----------------	-----------------------------------

**description** knob adapter shaft ø 6x4.6mm for gas tap



<b>GEV No.</b>	111481	<b>Ref. No.</b>	9400687 94006871 RX94006871
----------------	--------	-----------------	-----------------------------------

**description** knob adapter shaft ø 8x8mm for water tap

handles and hand wheels

hand wheels

hand wheels



<b>GEV No.</b>	693113	<b>Ref. No.</b>	94806020 RX94806020
----------------	--------	-----------------	------------------------

**description** hand wheel ø 150mm D1 ø 38mm bore ø 14mm thread groove width 5mm L1 38mm L2 40mm handle length 65mm with folding handle

**spare parts for** 693113

<b>GEV No.</b>	514255	<b>Ref. No.</b>	—
----------------	--------	-----------------	---

**description** folding handle ø 26mm total length 85mm seat ø 20mm shaft ømm thread M6 with pin L 85mm

**accessories for** 693113

<b>GEV No.</b>	690968	<b>Ref. No.</b>	—
----------------	--------	-----------------	---

**description** roll pin ø 5mm L 20mm



<b>GEV No.</b>	692684	<b>Ref. No.</b>	RX94030871
----------------	--------	-----------------	------------

**description** hand wheel ø 200mm D1 ø 50mm bore ø 16mm handle length 79mm with folding handle

ball handles

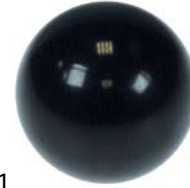

<b>GEV No.</b>	693474	<b>Ref. No.</b>	RX94027398
----------------	--------	-----------------	------------

**description** ball handle ø 40mm bore ø conical 12mm for drive into black

**accessories for** 693474

<b>GEV No.</b>	696529	<b>Ref. No.</b>	RX94037900
----------------	--------	-----------------	------------

**description** lever for ball handle thread M8x1.25 ø 12/14mm angled 90° SS

handle rails

handle rails



<b>GEV No.</b>	704000	<b>Ref. No.</b>	RX94026275
----------------	--------	-----------------	------------

**description** handle plastic L 138mm W 52mm H 25mm black hole distance 110mm Qty 1 pcs

levers

without handle



<b>GEV No.</b>	696529	<b>Ref. No.</b>	RX94037900
----------------	--------	-----------------	------------

**description** lever for ball handle thread M8x1.25 ø 12/14mm angled 90° SS

**accessories for** 696529

<b>GEV No.</b>	693474	<b>Ref. No.</b>	RX94027398
----------------	--------	-----------------	------------

**description** ball handle ø 40mm bore ø conical 12mm for drive into black

hand cranks



<b>GEV No.</b>	580073	<b>Ref. No.</b>	9403051 94030517 RX94030517
<b>description</b>	hand crank bore $\varnothing$ 16mm total length 128mm lever length 65mm seat $\varnothing$ 24mm		
<b>accessories for</b>	580073		
	<b>GEV No.</b>	511947	<b>Ref. No.</b> 9403064 94030640 RX94030640
gasket suitable for ROSINOX for hand wheel external height 7mm Qty 1m ED $\varnothing$ 36mm ID $\varnothing$ 18mm rubber thickness 2.5mm			

locks

turning lever locks

universal

RAHRBACH





<b>GEV No.</b>	700098	<b>Ref. No.</b>	26728212 RX26728212
<b>description</b>	door catch mounting pos. right off-set 38mm L 110mm H 74mm W 33mm mounting distance 68/68mm series 1750		
<b>spare parts for</b>	700098		
	<b>GEV No.</b>	690136	<b>Ref. No.</b> RX22705073
sliding plate mounting pos. right L 28mm H 3mm W 21mm H2 12.5mm			
<b>accessories for</b>	700098		
	<b>GEV No.</b>	514281	<b>Ref. No.</b> —
base plate L 110mm W 35mm for door catch thickness 10mm			

	<b>GEV No.</b>	690136	<b>Ref. No.</b> RX22705073
<b>description</b>	sliding plate mounting pos. right L 28mm H 3mm W 21mm H2 12.5mm		

STUV







<b>GEV No.</b>	700098	<b>Ref. No.</b>	26728212 RX26728212
<b>description</b>	door catch mounting pos. right off-set 38mm L 110mm H 74mm W 33mm mounting distance 68/68mm series 1750		
<b>spare parts for</b>	700098		
	<b>GEV No.</b>	690136	<b>Ref. No.</b> RX22705073
sliding plate mounting pos. right L 28mm H 3mm W 21mm H2 12.5mm			
<b>accessories for</b>	700098		
	<b>GEV No.</b>	514281	<b>Ref. No.</b> —
base plate L 110mm W 35mm for door catch thickness 10mm			

edgemount latches

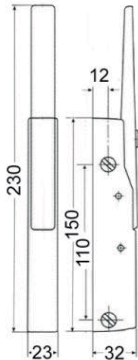
handle latches



CAFF/FERMOD

<b>GEV No.</b>	690455	<b>Ref. No.</b>	RX94026184
<b>description</b>	handle latch L 150mm mounting distance 110mm matt chrome-plated non lockable refrigeration units 570 R-L complete with door catch		
<b>spare parts for</b>	690455		
	<b>GEV No.</b>	690429	<b>Ref. No.</b> —
door catch CT 25.5mm			
<b>accessories for</b>	690455		
	<b>GEV No.</b>	690428	<b>Ref. No.</b> N/A
door catch H 51mm W 13.9mm mounting distance 30mm plastic CT 16.5mm			
	<b>GEV No.</b>	690445	<b>Ref. No.</b> —
base plate H 2mm			
	<b>GEV No.</b>	690446	<b>Ref. No.</b> —
base plate H 5mm L 56mm W 18mm			



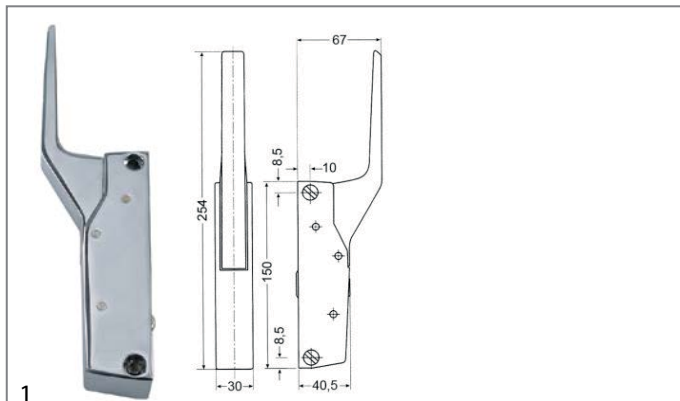

<b>GEV No.</b>	700060	<b>Ref. No.</b>	RX94026168
<b>description</b>	handle latch L 150mm mounting distance 133mm non lockable heated units G 791		
<b>accessories for</b>	700060		
	<b>GEV No.</b>	700061	<b>Ref. No.</b> —
	door catch L 58mm W 20mm H 35mm mounting distance 42mm chrome-plated brass for headed units		
	<b>GEV No.</b>	700062	<b>Ref. No.</b> —
	handle protection heated units		

**STUV**  
3.30.016x.x series

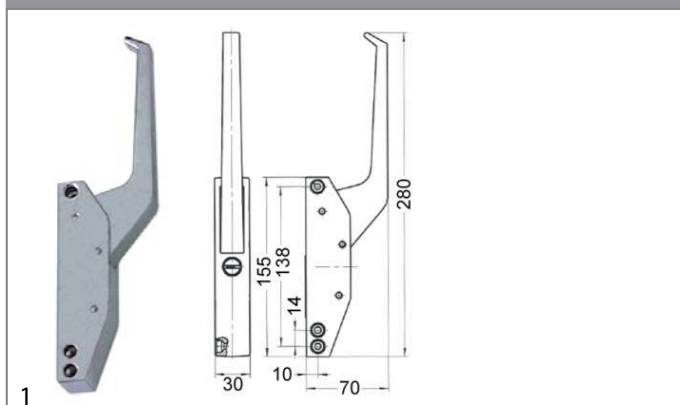

<b>GEV No.</b>	700063	<b>Ref. No.</b>	RX26728030
<b>description</b>	handle latch L 155mm mounting distance 124/138mm non lockable refrigeration units 3.30.0164		
<b>accessories for</b>	700063		
	<b>GEV No.</b>	700064	<b>Ref. No.</b> RX26728022
	door catch H 40mm L 28mm W 22mm		

**door catches**

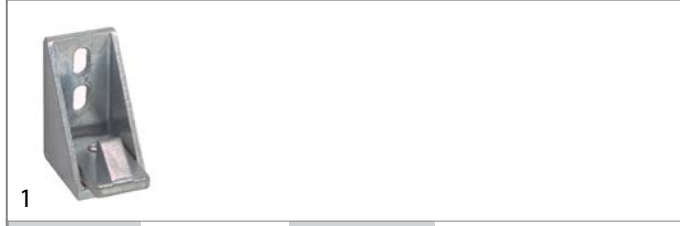

<b>GEV No.</b>	700064	<b>Ref. No.</b>	RX26728022
<b>description</b>	door catch H 40mm L 28mm W 22mm		

<b>GEV No.</b>	690428	<b>Ref. No.</b>	N/A
<b>description</b>	door catch H 51mm W 13.9mm mounting distance 30mm plastic CT 16.5mm		

**walk-in fridge catches**

**STUV**

3.31.015x.x series

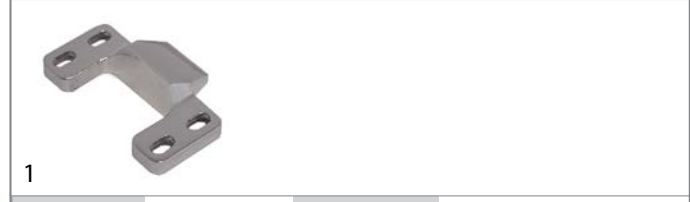

<b>GEV No.</b>	700072	<b>Ref. No.</b>	26728261 RX26728261
<b>description</b>	door catch H 17mm L 84mm W 53mm mounting distance 68mm zinc die cast with wedge heated units		

**snap locks**

**producer-specific**

**ROSINOX**

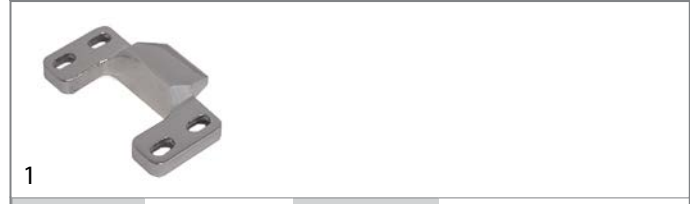

<b>GEV No.</b>	700072	<b>Ref. No.</b>	26728261 RX26728261
<b>description</b>	door catch H 17mm L 84mm W 53mm mounting distance 68mm zinc die cast with wedge heated units		

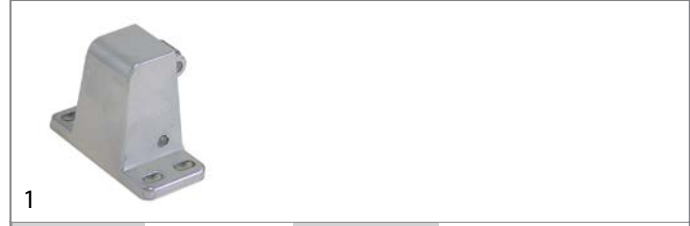

<b>GEV No.</b>	690101	<b>Ref. No.</b>	26728253 RX26728253
<b>description</b>	snap lock L 85mm W 40mm mounting distance 68mm heated units H 63mm type 1750 series		

## hinges

### oven hinges

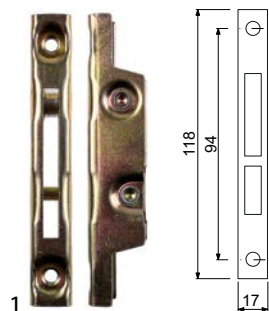

<b>GEV No.</b>	700001	<b>Ref. No.</b>	RX94805280
<b>description</b>	opposite support L 118mm W 17mm mounting distance 94mm		



<b>GEV No.</b>	700006	<b>Ref. No.</b>	94805272 RX94805272
----------------	--------	-----------------	------------------------

<b>description</b>	oven hinge mounting distance 173mm mounting distance 2 105mm lug mounting 14mm lever length 120mm groove distance 11mm spring thickness 3.5mm mounting ear position left spring length 112mm W 25mm		
--------------------	---	--	--

**accessories for** 700006

	<b>GEV No.</b>	700001	<b>Ref. No.</b>	RX94805280
	opposite support L 118mm W 17mm mounting distance 94mm			

	<b>GEV No.</b>	700007	<b>Ref. No.</b>	RX94805264
	oven hinge mounting distance 173mm mounting distance 2 105mm lug mounting 14mm lever length 120mm groove distance 11mm spring thickness 3.5mm mounting ear position right spring length 112mm W 25mm			

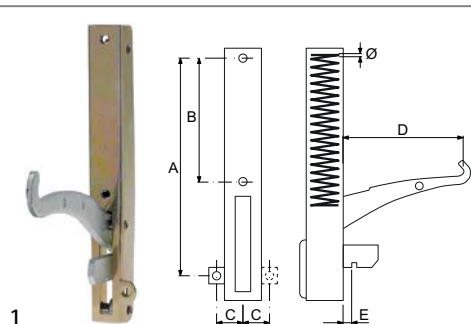

<b>GEV No.</b>	700007	<b>Ref. No.</b>	RX94805264
----------------	--------	-----------------	------------

<b>description</b>	oven hinge mounting distance 173mm mounting distance 2 105mm lug mounting 14mm lever length 120mm groove distance 11mm spring thickness 3.5mm mounting ear position right spring length 112mm W 25mm		
--------------------	--	--	--

**accessories for** 700007

	<b>GEV No.</b>	700001	<b>Ref. No.</b>	RX94805280
	opposite support L 118mm W 17mm mounting distance 94mm			

### miscellaneous



<b>GEV No.</b>	701170	<b>Ref. No.</b>	94002011 RX94002011
<b>description</b>	hinge L 111mm W 95mm mounting distance 90mm mounting pos. right		

## fittings for catering equipment

### aerators and air bleeders



<b>GEV No.</b>	540824	<b>Ref. No.</b>	94806056 RX94806056
<b>description</b>	pressure compensation valve thread 1/4" ET WS 19 chrome-plated L 18mm		

### drain taps

#### brass

#### drain taps



<b>GEV No.</b>	548001	<b>Ref. No.</b>	RX94020237
----------------	--------	-----------------	------------

<b>description</b>	drain tap 1 1/2" IT O-ring seal kettle connection with union nut A 80mm B1 68mm B2 132mm		
--------------------	--	--	--

**spare parts for** 548001

	<b>GEV No.</b>	505092	<b>Ref. No.</b>	—
	O-ring EPDM thickness 5.34mm ID ø 43.82mm Qty 1 pcs			
	<b>GEV No.</b>	540213	<b>Ref. No.</b>	—
	handle ID ø 5mm L 117mm			



safety fittings

accessories



<b>GEV No.</b>	540836	<b>Ref. No.</b>	94812552 RX94812552
<b>description</b>	funnel thread 1/2" with shut-off valve		

safety valves



<b>GEV No.</b>	540721	<b>Ref. No.</b>	94812663 RX94812663
<b>description</b>	safety valve triggering pressure 0.5bar M88 thread 1 1/4"		

accessories for 540721



<b>GEV No.</b>	541501	<b>Ref. No.</b>	—
<b>description</b>	reducer for safety fitting IT 1 1/4" ET 3/4"		

equipment feet and end caps

equipment feet

with screw mounting



<b>GEV No.</b>	513287	<b>Ref. No.</b>	RX94809563
<b>description</b>	equipment foot tube ø 60mm thread M12 thread L 33mm H 155-235mm SS size 2" Qty 1 pcs		

screw-in feet



<b>GEV No.</b>	701292	<b>Ref. No.</b>	RX94810928
<b>description</b>	equipment foot thread M10 thread L 23mm ø 38mm H 12.5mm WS 17 Qty 1 pcs		



<b>GEV No.</b>	691652	<b>Ref. No.</b>	RX94800992
<b>description</b>	equipment foot thread M10 thread L 25mm H 8mm ø 25mm overall height 33mm WS 25 Qty 1 pcs		



<b>GEV No.</b>	695601	<b>Ref. No.</b>	RX94813949
<b>description</b>	equipment foot thread M17 thread L 23mm ø 24mm H 11mm plastic WS 24 Qty 1 pcs		



<b>GEV No.</b>	696536	<b>Ref. No.</b>	94813950 RX94813950
<b>description</b>	equipment foot thread M17 thread L 30mm ø 17mm H 20mm plastic WS 24 Qty 1 pcs		

baskets

fryer baskets

ROSINOX



<b>GEV No.</b>	970880	<b>Ref. No.</b>	RX94030194
<b>description</b>	fryer basket W1 165mm L1 295mm H1 210mm plastic		



<b>GEV No.</b>	970850	<b>Ref. No.</b>	RX94037660
<b>description</b>	fryer basket W1 280mm L1 395mm H1 145mm plastic		

crumb screens



<b>GEV No.</b>	970851	<b>Ref. No.</b>	RX94037686
<b>description</b>	crumb screen L 460mm W 300mm H 6.5mm		

warewashing baskets

accessories

cutlery inserts



<b>GEV No.</b>	976013	<b>Ref. No.</b>	94804689 RX94804689
<b>description</b>	cutlery insert L 105mm W 105mm ømm H 140mm		

sliding corners



<b>GEV No.</b>	970001	<b>Ref. No.</b>	94807401 RX94807401
<b>description</b>	sliding corner wire gauge ø 5mm L 120mm W 120mm H 12mm L-shape		

gaskets

refrigeration gaskets

plug-in gaskets

profile 9048

We offer custom-made gaskets for this profile

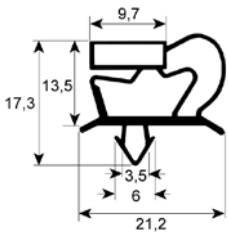

<b>GEV No.</b>	900695	<b>Ref. No.</b>	RX94814475
<b>description</b>	refrigeration gasket profile 9048 W 375mm L 400mm plug size		

gaskets for heated units

window seals

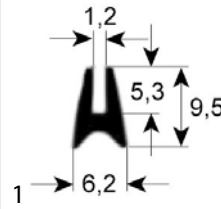

<b>GEV No.</b>	698487	<b>Ref. No.</b>	RX94062544
<b>description</b>	window gasket profile 1530 L 1215mm suitable for ROSINOX		

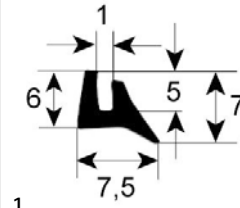

<b>GEV No.</b>	900056	<b>Ref. No.</b>	RX24390502
<b>description</b>	window gasket profile 1570 Qty supplied by meter		

door seals

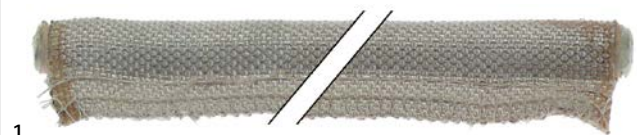

<b>GEV No.</b>	902283	<b>Ref. No.</b>	RX94025962
<b>description</b>	door seal L 1300mm suitable for ROSINOX		

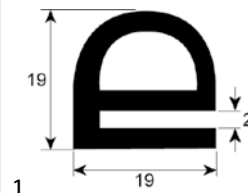

<b>GEV No.</b>	900174	<b>Ref. No.</b>	RX24390288
<b>description</b>	door seal profile 2210 L 4200mm Qty 1		

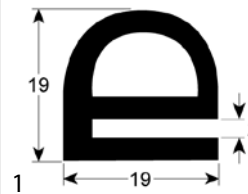

<b>GEV No.</b>	902238	<b>Ref. No.</b>	RX24390288
<b>description</b>	door seal profile 2210 L 4200mm Qty 1		



<b>GEV No.</b>	901561	<b>Ref. No.</b>	9405030 94050309 RX94050309
<b>description</b>	door seal profile 2228 Qty supplied by meter		

<b>GEV No.</b>	902240	<b>Ref. No.</b>	24390379 RX24390379
<b>description</b>	door seal profile 2230 W 470mm L 485mm external size Qty 1		

<b>GEV No.</b>	902241	<b>Ref. No.</b>	24390338 RX24390338
<b>description</b>	door seal profile 2230 W 480mm L 725mm external size Qty 1		

<b>GEV No.</b>	902492	<b>Ref. No.</b>	RX94820003
<b>description</b>	door seal profile 2736 W 695mm L 1000mm outer plug size Qty 1 suitable for ELOMA 12-21 silicone		

<b>GEV No.</b>	900489	<b>Ref. No.</b>	94814225 RX94814225
<b>description</b>	door seal profile 2770/2771 H 440mm W 600mm outer plug size Qty 1		

<b>GEV No.</b>	900727	<b>Ref. No.</b>	RX94806445
<b>description</b>	door seal profile 2930 Qty supplied by meter		

**gaskets for tray rack trolleys**

<b>GEV No.</b>	902225	<b>Ref. No.</b>	RX24390510
<b>description</b>	tray rack trolley gasket profile 4020 L 1100mm Qty 1 silicone foam		

<b>GEV No.</b>	900055	<b>Ref. No.</b>	24390510 RX24390510
<b>description</b>	tray rack trolley gasket profile 4020 Qty supplied by meter silicone foam		



O-rings

EPDM



<b>GEV No.</b>	361304	<b>Ref. No.</b>	94801156 RX94801156
<b>description</b>	O-ring EPDM ID ø 11.11mm thickness 1.78mm Qty 1 pcs for type DIB3E/DIB5E		



<b>GEV No.</b>	510302	<b>Ref. No.</b>	94809639 94813757 RX94809639 RX94813757
<b>description</b>	O-ring EPDM ID ø 12.42mm thickness 1.78mm Qty 1 pcs		

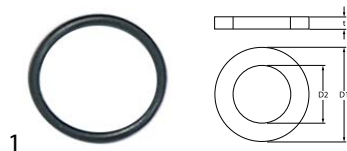

<b>GEV No.</b>	510322	<b>Ref. No.</b>	94801214 RX94801214
<b>description</b>	O-ring EPDM thickness 1.78mm ID ø 17.17mm Qty 1 pcs		

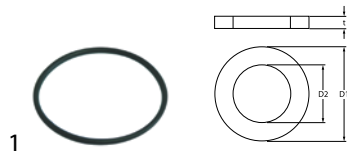

<b>GEV No.</b>	510824	<b>Ref. No.</b>	94807450 RX94807450
<b>description</b>	O-ring EPDM thickness 1.78mm ID ø 20.35mm Qty 1 pcs		

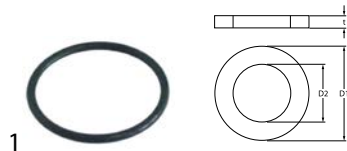

<b>GEV No.</b>	517045	<b>Ref. No.</b>	94807550 RX94807550
<b>description</b>	O-ring EPDM thickness 1.78mm ID ø 21.95mm Qty 1 pcs		

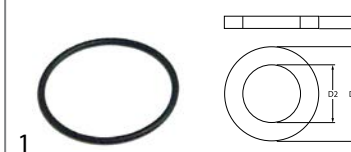

<b>GEV No.</b>	513057	<b>Ref. No.</b>	94801727 RX94801727
<b>description</b>	O-ring EPDM thickness 1.78mm ID ø 28.3mm Qty 1 pcs		



<b>GEV No.</b>	517035	<b>Ref. No.</b>	RX94809555
<b>description</b>	O-ring EPDM thickness 1.78mm ID ø 4.48mm Qty 1 pcs		



<b>GEV No.</b>	510303	<b>Ref. No.</b>	94800778 RX94800778
<b>description</b>	O-ring EPDM thickness 1.78mm ID ø 6.75mm Qty 1 pcs		

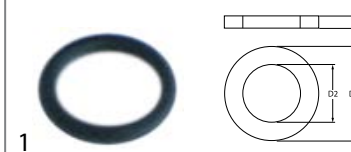

<b>GEV No.</b>	510177	<b>Ref. No.</b>	94809761 RX94809761
<b>description</b>	O-ring EPDM thickness 1.78mm ID ø 7.66mm Qty 1 pcs		

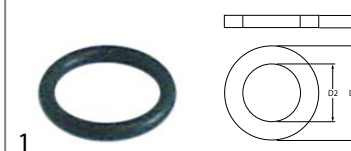

<b>GEV No.</b>	504574	<b>Ref. No.</b>	RX94813741 RX94813762
<b>description</b>	O-ring EPDM thickness 1.78mm ID ø 9.25mm Qty 1 pcs		

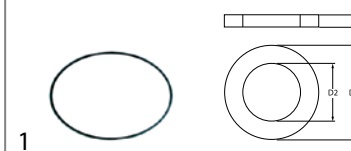

<b>GEV No.</b>	510556	<b>Ref. No.</b>	RX94813788
<b>description</b>	O-ring EPDM thickness 1.78mm ID ø 94.97mm Qty 1 pcs pump type T110		

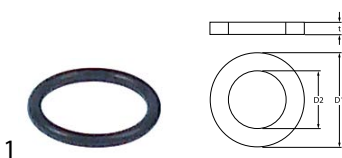
<b>GEV No.</b>	511237	<b>Ref. No.</b>	94813756 RX94813756
<b>description</b>	O-ring EPDM thickness 1mm ID ø 7mm Qty 1 pcs		

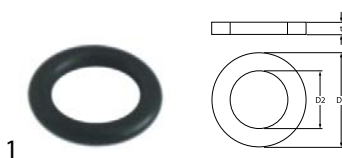

<b>GEV No.</b>	528583	<b>Ref. No.</b>	94813760 RX94813760
<b>description</b>	O-ring EPDM thickness 2.62mm ID ø 9.13mm Qty 1 pcs		



<b>GEV No.</b>	517104	<b>Ref. No.</b>	RX94807440
<b>description</b>	O-ring EPDM thickness 2.62mm ID ø 31.42mm Qty 1 pcs		

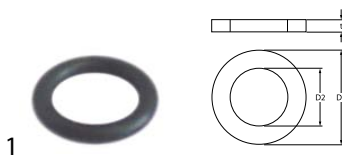

<b>GEV No.</b>	528487	<b>Ref. No.</b>	94812680 RX94812680
<b>description</b>	O-ring EPDM thickness 2.62mm ID ø 9.19mm Qty 1 pcs		

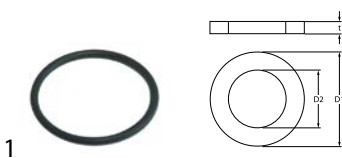

<b>GEV No.</b>	517004	<b>Ref. No.</b>	94807773 RX94807773
<b>description</b>	O-ring EPDM thickness 2.62mm ID ø 34.6mm Qty 1 pcs		

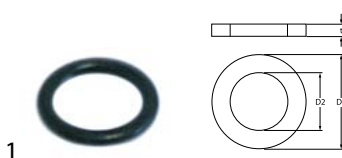

<b>GEV No.</b>	510893	<b>Ref. No.</b>	94807765 RX94807765
<b>description</b>	O-ring EPDM thickness 2.62mm ID ø 9.92mm Qty 1 pcs		

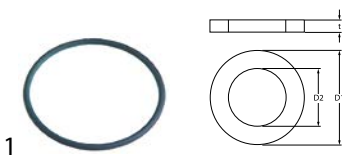

<b>GEV No.</b>	512056	<b>Ref. No.</b>	94814259 RX94814259
<b>description</b>	O-ring EPDM thickness 2.62mm ID ø 50.47mm Qty 1 pcs		

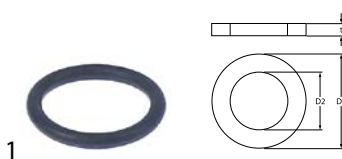

<b>GEV No.</b>	517087	<b>Ref. No.</b>	94807351 RX94807351
<b>description</b>	O-ring EPDM thickness 3.53mm ID ø 23.4mm Qty 1 pcs		

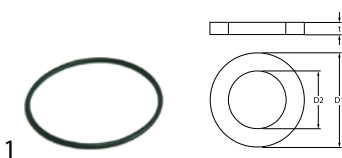

<b>GEV No.</b>	512114	<b>Ref. No.</b>	94802535 RX94802535
<b>description</b>	O-ring EPDM thickness 2.62mm ID ø 55.25mm Qty 1 pcs		



<b>GEV No.</b>	510895	<b>Ref. No.</b>	94813951 RX94813951
<b>description</b>	O-ring EPDM thickness 3.53mm ID ø 34.52mm Qty 1 pcs		

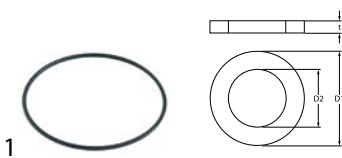

<b>GEV No.</b>	512235	<b>Ref. No.</b>	94801123 RX94801123
<b>description</b>	O-ring EPDM thickness 2.62mm ID ø 88.57mm Qty 1 pcs		

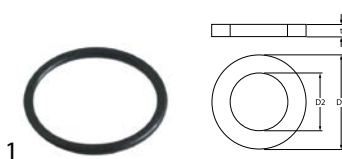

<b>GEV No.</b>	506015	<b>Ref. No.</b>	94810256 RX94810256
<b>description</b>	O-ring EPDM thickness 3.53mm ID ø 39.69mm Qty 1 pcs		

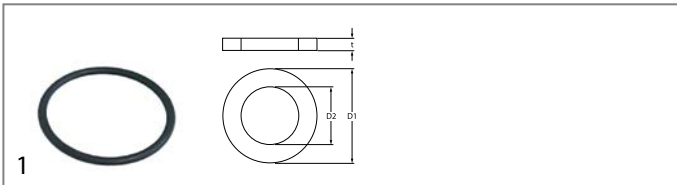

<b>GEV No.</b>	524148	<b>Ref. No.</b>	94800703 RX94800703
<b>description</b>	O-ring EPDM thickness 3.53mm ID ø 40.86mm Qty 1 pcs		

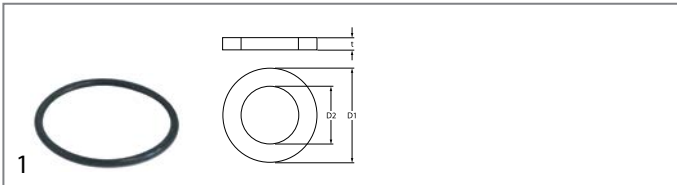

<b>GEV No.</b>	518175	<b>Ref. No.</b>	94806924 94812565 RX94806924 RX94812565
<b>description</b>	O-ring EPDM thickness 3.53mm ID ø 49.21mm Qty 1 pcs		

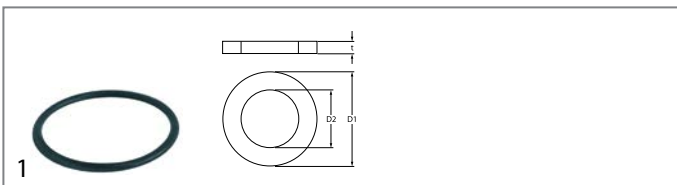

<b>GEV No.</b>	532118	<b>Ref. No.</b>	RX94806155
<b>description</b>	O-ring EPDM thickness 3.53mm ID ø 55.56mm Qty 10 pcs		

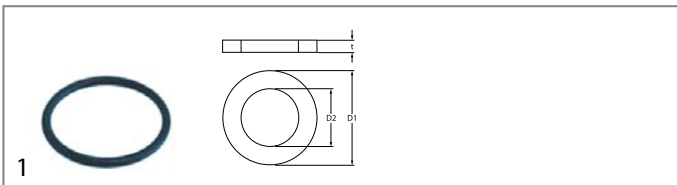

<b>GEV No.</b>	510563	<b>Ref. No.</b>	94801487 RX94801487
<b>description</b>	O-ring EPDM thickness 3mm ID ø 28mm Qty 1 pcs		

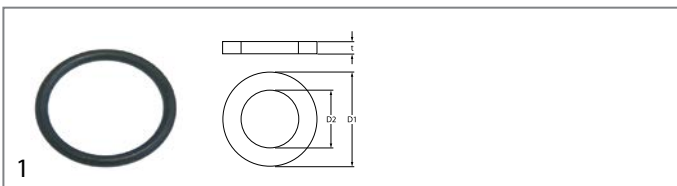

<b>GEV No.</b>	510408	<b>Ref. No.</b>	RX94807781
<b>description</b>	O-ring EPDM thickness 5.34mm ID ø 47mm Qty 1 pcs		

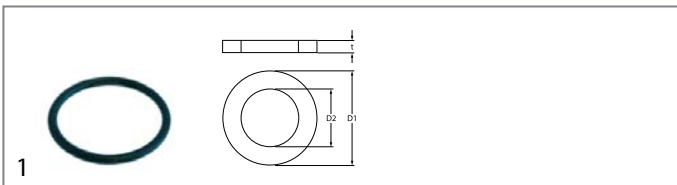

<b>GEV No.</b>	510409	<b>Ref. No.</b>	RX94807294
<b>description</b>	O-ring EPDM thickness 5.34mm ID ø 56.52mm Qty 1 pcs		

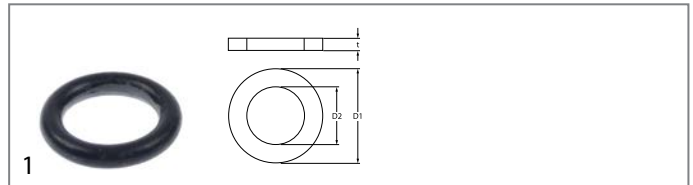

<b>GEV No.</b>	532653	<b>Ref. No.</b>	94808599 RX94808599
<b>description</b>	O-ring EPDM thickness 5mm ID ø 20mm Qty 1 pcs		

### silicone

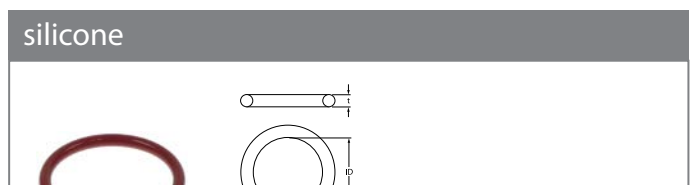

<b>GEV No.</b>	514017	<b>Ref. No.</b>	94803079 94803616 94812605 RX94803079 RX94803616 RX94812605
<b>description</b>	O-ring silicone thickness 3.53mm ID ø 32.93mm Qty 1 pcs		

### Viton

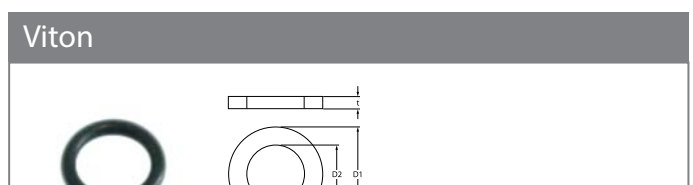

<b>GEV No.</b>	528246	<b>Ref. No.</b>	94814266 RX94814266
<b>description</b>	O-ring Viton thickness 1.78mm ID ø 8.73mm Qty 1 pcs		

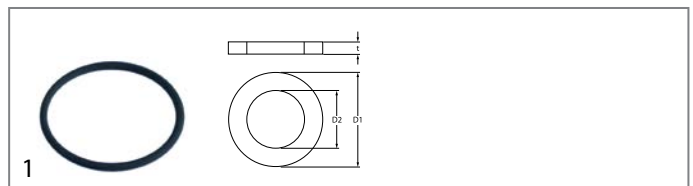

<b>GEV No.</b>	550496	<b>Ref. No.</b>	RX94812518
<b>description</b>	O-ring Viton thickness 3.53mm ID ø 50.39mm Qty 1 pcs		

### NBR

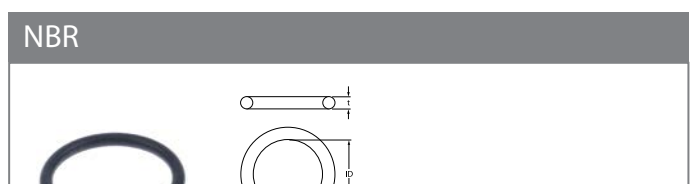



<b>GEV No.</b>	532654	<b>Ref. No.</b>	94813976 RX94813976
<b>description</b>	O-ring NBR thickness 3.6mm ID ø 30.8mm Qty 1 pcs		



sealing washers

fibre gaskets

			
1			
<b>GEV No.</b>	517173	<b>Ref. No.</b>	94810941 RX94810941
<b>description</b>	flat gasket FIBER ED ø 14mm ID ø 8mm thickness 1.5mm Qty 1 pcs		

			
1			
<b>GEV No.</b>	508017	<b>Ref. No.</b>	94813967 RX94813967
<b>description</b>	flat gasket FIBER ED ø 24mm ID ø 17mm thickness 2mm Qty 1 pcs		

			
1			
<b>GEV No.</b>	506072	<b>Ref. No.</b>	94808870 RX94808870
<b>description</b>	flat gasket fibre ED ø 38mm ID ø 27mm thickness 2mm outflow for thread 1¼" Qty 1 pcs		

rubber gaskets

			
1			
<b>GEV No.</b>	505313	<b>Ref. No.</b>	94813799 RX94813799
<b>description</b>	flat gasket Neoprene ED ø 50mm ID ø 35mm thickness 4mm Qty 1 pcs		

			
1			
<b>GEV No.</b>	510761	<b>Ref. No.</b>	94801495 RX94801495
<b>description</b>	flat gasket rubber D1 ø 38mm D2 ø 25mm thickness 2mm Qty 1 pcs		

			
1			
<b>GEV No.</b>	512376	<b>Ref. No.</b>	94802659 RX94802659
<b>description</b>	flat gasket rubber ED ø 18mm ID ø 10mm thickness 2mm Qty 1 pcs		

			
1			
<b>GEV No.</b>	512073	<b>Ref. No.</b>	94802212 RX94802212
<b>description</b>	flat gasket rubber ED ø 31mm ID ø 22mm thickness 2mm Qty 1 pcs		

			
1			
<b>GEV No.</b>	519341	<b>Ref. No.</b>	RX94807245
<b>description</b>	flat gasket rubber ED ø 40mm ID ø 5.5mm thickness 2mm Qty 1 pcs		

			
1			
<b>GEV No.</b>	512346	<b>Ref. No.</b>	RX94801446
<b>description</b>	flat gasket rubber ED ø 44mm ID ø 32mm thickness 2.5mm Qty 1 pcs		

			
1			
<b>GEV No.</b>	517181	<b>Ref. No.</b>	94807520 RX94807520
<b>description</b>	flat gasket rubber ED ø 44mm ID ø 32mm thickness 3mm Qty 1 pcs		

			
1			
<b>GEV No.</b>	513059	<b>Ref. No.</b>	94804325 94804895 RX94804325 RX94804895
<b>description</b>	flat gasket rubber ED ø 52mm ID ø 40mm thickness 3mm Qty 1 pcs		

			
1			
<b>GEV No.</b>	512295	<b>Ref. No.</b>	94814256 RX94814256
<b>description</b>	flat gasket rubber ED ø 65mm ID ø 50mm thickness 3mm Qty 1 pcs equiv. no. 25260 suitable for HOONVED		

			
1			
<b>GEV No.</b>	517205	<b>Ref. No.</b>	RX94808037
<b>description</b>	flat gasket rubber ED ø 75mm ID ø 58mm thickness 3mm Qty 1 pcs		



1

<b>GEV No.</b>	517398	<b>Ref. No.</b>	RX94810355
<b>description</b>	flat gasket rubber ED $\varnothing$ 82mm ID $\varnothing$ 66mm thickness 4mm for salt tank Qty 1 pcs		



1

<b>GEV No.</b>	517194	<b>Ref. No.</b>	94813987 RX94813987
<b>description</b>	flat gasket rubber ED $\varnothing$ 95mm ID $\varnothing$ 75mm thickness 3mm Qty 1 pcs		



1

<b>GEV No.</b>	694527	<b>Ref. No.</b>	24390627 RX24390627
<b>description</b>	gasket rubber ED $\varnothing$ 57mm ID $\varnothing$ 39mm thickness 4mm for combi-steamer Qty 1 pcs suitable for RATIONAL		

## silicone gaskets



1

<b>GEV No.</b>	507520	<b>Ref. No.</b>	94813931 RX94813931
<b>description</b>	gasket silicone ED $\varnothing$ 38mm ID $\varnothing$ 30mm thickness 4mm Qty 1 pcs for wash arm		



1

<b>GEV No.</b>	359721	<b>Ref. No.</b>	RX24390700
<b>description</b>	gasket silicone ED $\varnothing$ 48mm ID $\varnothing$ 39.5mm thickness 5mm Qty 1 pcs		

## foam rubber gaskets



1

<b>GEV No.</b>	505307	<b>Ref. No.</b>	94813780 RX94813780
<b>description</b>	foam rubber gasket W 15mm thickness 5mm suitable for HOONVED with layer		

## sealing cords

## round



1

<b>GEV No.</b>	510572	<b>Ref. No.</b>	RX24390296
<b>description</b>	sealing cord $\varnothing$ 10mm greased L 0.2m Qty 1		



1

<b>GEV No.</b>	694699	<b>Ref. No.</b>	RX94051653
<b>description</b>	sealing cord round $\varnothing$ 16mm braided L 1.4m Qty 1		

## special gaskets

## door seals for dishwashers

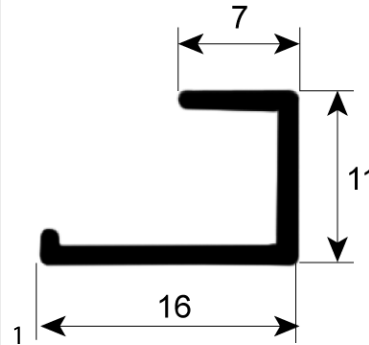

1

<b>GEV No.</b>	518246	<b>Ref. No.</b>	94804523 RX94804523
<b>description</b>	door seal L 395mm dishwasher suitable for ELETTOBAR, WOLK equiv. no. 437057		

## miscellaneous



1

<b>GEV No.</b>	698485	<b>Ref. No.</b>	RX94814199
<b>description</b>	flat gasket external height 9mm ED $\varnothing$ 69mm ID $\varnothing$ 55mm heating		



1

<b>GEV No.</b>	530430	<b>Ref. No.</b>	RX94813982
<b>description</b>	gasket for rinse pipe rubber $\varnothing$ 33mm ID $\varnothing$ 24mm thickness 11mm for Silanos		







			
1			
<b>GEV No.</b>	505314	<b>Ref. No.</b>	94801735 RX94801735
<b>description</b>	gasket for wash arm thickness 1mm L 74.5mm W 42mm		

			
1			
<b>GEV No.</b>	510566	<b>Ref. No.</b>	24390320 RX24390320
<b>description</b>	gasket suitable for RATIONAL equiv. no. 50120537 L 70mm W 70mm electrode thickness 4mm		

			
1			
<b>GEV No.</b>	510671	<b>Ref. No.</b>	RX24390544
<b>description</b>	gasket suitable for RATIONAL for drain Qty 1m ED $\phi$ 124mm ID $\phi$ 51mm rubber thickness 4mm hole distance 87mm		

			
1			
<b>GEV No.</b>	511947	<b>Ref. No.</b>	9403064 94030640 RX94030640
<b>description</b>	gasket suitable for ROSINOX for hand wheel external height 7mm Qty 1m ED $\phi$ 36mm ID $\phi$ 18mm rubber thickness 2.5mm		

			
1			
<b>GEV No.</b>	901562	<b>Ref. No.</b>	9401347 94013471 RX94013471
<b>description</b>	gasket suitable for ROSINOX for switch L 50mm W 20mm Qty 1m silicone thickness 1.5mm hole distance 28mm		

			
1			
<b>GEV No.</b>	698484	<b>Ref. No.</b>	RX94050440
<b>description</b>	lid gasket L 223mm W 148mm ROSINOX		

thermostat gaskets

			
1			
<b>GEV No.</b>	512154	<b>Ref. No.</b>	94813740 RX94813740
<b>description</b>	gasket for thermostat ID $\phi$ 20mm equiv. no. 200494/H200494 hole distance 41mm suitable for COMENDA, HOONVED		

gaskets for wash arm support

			
1			
<b>GEV No.</b>	518025	<b>Ref. No.</b>	94804234 RX94804234
<b>description</b>	gasket D1 $\phi$ 50mm D2 $\phi$ 82mm thickness 2mm with 6 holes wash arm support equiv. no. 437014 suitable for COLGED		

			
1			
<b>GEV No.</b>	518339	<b>Ref. No.</b>	94804929 RX94804929
<b>description</b>	gasket D2 $\phi$ 50mm thickness 2mm with 3 screw holes wash arm support equiv. no. 437064 suitable for COLGED hole $\phi$ 50mm hole distance 67mm		

## springs

### torsion springs



<b>GEV No.</b>	690095	<b>Ref. No.</b>	94814244 RX94814244
<b>description</b>	torsion spring ø 6mm L2 15mm wire gauge ø 0.9mm L1 2x6mm L3 15mm Qty 1 pcs for closing hub		

### compression springs



<b>GEV No.</b>	512102	<b>Ref. No.</b>	94814268 RX94814268
<b>description</b>	compression spring		

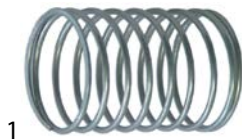

<b>GEV No.</b>	512108	<b>Ref. No.</b>	94801263 RX94801263
<b>description</b>	compression spring ø 41mm L 60mm wire gauge ø 2mm		

### spring compressors



<b>GEV No.</b>	517160	<b>Ref. No.</b>	RX94810915
<b>description</b>	spring compressor thread M10		

### roller springs

#### roller springs



<b>GEV No.</b>	517419	<b>Ref. No.</b>	RX94810728
<b>description</b>	roller spring complete incl. holder type BBSR 22		



<b>GEV No.</b>	517321	<b>Ref. No.</b>	RX94807580
<b>description</b>	roller spring type BBSR 23 W 51mm ID ø 45mm lug length 50mm		

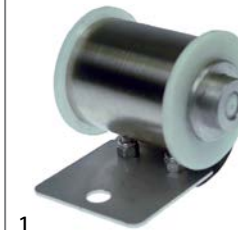

<b>GEV No.</b>	517315	<b>Ref. No.</b>	RX94807570
<b>description</b>	roller spring W 50mm ID ømm lug length 49mm		
<b>accessories for</b>	517315		



<b>GEV No.</b>	517314	<b>Ref. No.</b>	94809712 RX94809712
<b>description</b>	spring holder for roller spring ø 29mm Lmm Wmm H 9mm		

### accessories

#### holders



<b>GEV No.</b>	517314	<b>Ref. No.</b>	94809712 RX94809712
<b>description</b>	spring holder for roller spring ø 29mm Lmm Wmm H 9mm		

### tension springs



<b>GEV No.</b>	698482	<b>Ref. No.</b>	RX94025038
<b>description</b>	spring ø 23.9mm total length 235mm wire gauge ø 3.5mm Qty 1 pcs		





<b>GEV No.</b>	517273	<b>Ref. No.</b>	94814305 RX94814305
<b>description</b>	tension spring ø 10mm total length 225mm wire gauge ø 1.5mm mounting pos. upper		



<b>GEV No.</b>	501296	<b>Ref. No.</b>	RX94810850
<b>description</b>	tension spring ø 12mm total length 275mm wire gauge ø 1.6mm		



1 			
<b>GEV No.</b>	517259	<b>Ref. No.</b>	94814098 RX94814098
<b>description</b>	tension spring ø 15.3mm total length 130mm wire gauge ø 2mm for door		

1 			
<b>GEV No.</b>	512033	<b>Ref. No.</b>	RX94813845
<b>description</b>	tension spring ø 21.6mm total length 190mm wire gauge ø 3mm L1 121.5mm		

1 			
<b>GEV No.</b>	517286	<b>Ref. No.</b>	RX94808557
<b>description</b>	tension spring ø 35mm total length 865mm wire gauge ø 5mm		

1 			
<b>GEV No.</b>	517287	<b>Ref. No.</b>	RX94813999
<b>description</b>	tension spring ø 38.8mm total length 663mm wire gauge ø 4.2mm		

1 			
<b>GEV No.</b>	517048	<b>Ref. No.</b>	RX94810914
<b>description</b>	tension spring ø 39.7mm total length 305mm wire gauge ø 5mm mounting pos. lateral		

## manometers

1 			
<b>GEV No.</b>	541876	<b>Ref. No.</b>	RX94809357
<b>description</b>	manometer ø 49mm pressure range 0-4bar connection lower marking adjustable thread 1/4"		

1 			
<b>GEV No.</b>	541334	<b>Ref. No.</b>	94812660 RX94812660
<b>description</b>	manometer ø 60mm pressure range 0 up to 1bar thread 1/8" marking 0.5 kettle connection on the backside		

## hose reels and spray guns

### spray guns

1 			
<b>GEV No.</b>	520729	<b>Ref. No.</b>	25177072 RX25177072
<b>description</b>	shower hose connections 1/2" L 2800mm SS operating p. 10bar burst p. 90bar t.max. 90°C approval DVGW with flexible fabric		

## dosing pumps

### membrane dosing pumps

#### self-priming

SEKO

#### spare parts

1 			
<b>GEV No.</b>	361304	<b>Ref. No.</b>	94801156 RX94801156
<b>description</b>	O-ring EPDM ID ø 11.11mm thickness 1.78mm Qty 1 pcs for type DIB3E/DIB5E		

#### various



1 				
<b>GEV No.</b>	361015	<b>Ref. No.</b>	RX94807690	
<b>description</b>	dosing pump membrane dosing pump rinse aid inlet 6x8mm outlet 4x6mm pressure connection ø 4x6mm suction connection ø 6x8mm			
<b>spare parts for</b>	361015			
	<b>GEV No.</b>	361132	<b>Ref. No.</b>	—
	membrane dosing pump			
	<b>GEV No.</b>	510298	<b>Ref. No.</b>	—
	lip valve dosing pump suitable for DB2/DS5			

self-priming with supporting pressure

DIHR







1

<b>GEV No.</b>	361744	<b>Ref. No.</b>	94808748 RX94808748
<b>description</b>	dosing pump type DW with auxiliary pressure connection rinse aid inlet 4mm outlet 8mm suction connection ø 4mm auxiliary pressure connection 10mm		
<b>spare parts for</b>	361744		
	GEV No.	520026	Ref. No. —
	PVC hose ID ø 4mm ED ø 6mm L 10m thickness 1mm t.max. 60°C transparent		
	GEV No.	520090	Ref. No. —
	PVC hose ID ø 4mm ED ø 6mm L 2m thickness 1mm t.max. 60°C transparent		

HOONVED



1

<b>GEV No.</b>	361010	<b>Ref. No.</b>	94801271 RX94801271
<b>description</b>	dosing pump rinse aid pressure connection ø 4x6mm suction connection ø 4mm auxiliary pressure connection 10mm HOONVED		
<b>spare parts for</b>	361010		
	GEV No.	361383	Ref. No. —
	lip valve rinse aid pressure connection ømm suction connection ømm auxiliary pressure connectionmm		
	GEV No.	361384	Ref. No. —
	membrane rinse aid pressure connection ømm suction connection ømm auxiliary pressure connectionmm		
<b>accessories for</b>	361010		
	GEV No.	520090	Ref. No. —
	PVC hose ID ø 4mm ED ø 6mm L 2m thickness 1mm t.max. 60°C transparent		
	GEV No.	520091	Ref. No. —
	nylon hose ID ø 4mm ED ø 6mm L 2m thickness 1mm operating p. 10bar burst p. 50bar t.max. 100°C transparent		



1

<b>GEV No.</b>	361387	<b>Ref. No.</b>	94813747 RX94813747
<b>description</b>	dosing pump rinse aid pressure connection ø 8mm suction connection ø 4mm auxiliary pressure connection 10mm		
<b>spare parts for</b>	361387		
	GEV No.	361383	Ref. No. —
	lip valve rinse aid pressure connection ømm suction connection ømm auxiliary pressure connectionmm		
	GEV No.	361384	Ref. No. —
	membrane rinse aid pressure connection ømm suction connection ømm auxiliary pressure connectionmm		
	GEV No.	508008	Ref. No. —
	O-ring EPDM thickness 2.62mm ID ø 15.88mm Qty 1 pcs		
<b>accessories for</b>	361387		
	GEV No.	520022	Ref. No. —
	PVC hose ID ø 8mm ED ø 12mm L 10m thickness 2mm t.max. 60°C transparent		
	GEV No.	520090	Ref. No. —
	PVC hose ID ø 4mm ED ø 6mm L 2m thickness 1mm t.max. 60°C transparent		

SEKO



1

<b>GEV No.</b>	361304	<b>Ref. No.</b>	94801156 RX94801156
<b>description</b>	O-ring EPDM ID ø 11.11mm thickness 1.78mm Qty 1 pcs for type DIB3E/DIB5E		

accessories

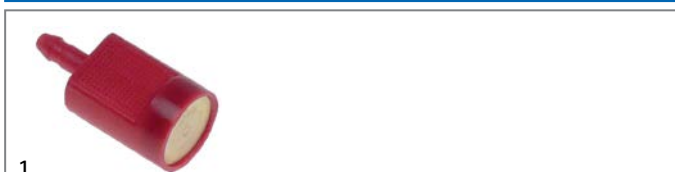

1

<b>GEV No.</b>	361829	<b>Ref. No.</b>	RX94810173 RX94810181
<b>description</b>	container filter complete plastic hose ø 5mm		



container filters with non-return valve

1



<b>GEV No.</b>	361058	<b>Ref. No.</b>	94045172 RX94045172
<b>description</b>	container filter with non-return valve SS hose $\varnothing$ 4x6mm $\varnothing$ 20mm L 56mm		

1



<b>GEV No.</b>	518068	<b>Ref. No.</b>	94804044 RX94804044
<b>description</b>	drain hose DN34 L 2000mm elbow $\varnothing$ inside 50mm elbow ext. $\varnothing$ 59mm inner hose $\varnothing$ 35mm outer hose $\varnothing$ 42mm PVC		



hoses

supply hoses

stainless steel flexi hoses

universal hoses

1

<b>GEV No.</b>	520633	<b>Ref. No.</b>	RX94814124
<b>description</b>	flex hose SS braid straight-straight DN10 connections 1/2" L 2000mm approval DVGW operating p. 10bar test pressure 32bar burst p. 95bar		

1



<b>GEV No.</b>	507207	<b>Ref. No.</b>	94802717 RX94802717
<b>description</b>	drain hose DN24 L 1500mm A int. $\varnothing$ 24mm A ext. $\varnothing$ 28mm B int. $\varnothing$ 24mm B ext. $\varnothing$ 28mm outer hose $\varnothing$ 28mm		

1



<b>GEV No.</b>	530613	<b>Ref. No.</b>	94813844 RX94813844
<b>description</b>	drain hose DN19 L 3000mm straight $\varnothing$ inside 21mm straight ext. $\varnothing$ 27mm elbow $\varnothing$ inside 21mm elbow ext. $\varnothing$ 27mm outer hose $\varnothing$ 20mm		

pre-rinse hoses

stainless steel flexi hoses

1



<b>GEV No.</b>	520729	<b>Ref. No.</b>	25177072 RX25177072
<b>description</b>	shower hose connections 1/2" L 2800mm SS operating p. 10bar burst p. 90bar t.max. 90°C approval DVGW with flexible fabric		

1



<b>GEV No.</b>	530819	<b>Ref. No.</b>	94812310 RX94812310
<b>description</b>	drain hose DN20 L 2500mm straight $\varnothing$ inside 19mm straight ext. $\varnothing$ 24mm elbow $\varnothing$ inside 22mm elbow ext. $\varnothing$ 27mm outer hose $\varnothing$ 24mm		

drain hoses

1



<b>GEV No.</b>	530587	<b>Ref. No.</b>	94813841 RX94813841
<b>description</b>	drain hose DN28 L 2000mm straight $\varnothing$ inside 32mm straight ext. $\varnothing$ 40mm outer hose $\varnothing$ 35mm		

industrial hoses

Niplaflex hoses

1



<b>GEV No.</b>	530562	<b>Ref. No.</b>	RX94813948
<b>description</b>	pressure hose ID $\varnothing$ 13mm ED $\varnothing$ 21mm L 5m operating p. 10bar burst p. 30bar t.max. 110°C		





pressure control hoses



1

<b>GEV No.</b>	530560	<b>Ref. No.</b>	94813947 RX94813947
<b>description</b>	pressure control hose ID $\varnothing$ 5mm ED $\varnothing$ 9mm L 5m operating p. 30bar burst p. 90bar temp.-resist. 60°C		

formed hoses

straight



1

<b>GEV No.</b>	518380	<b>Ref. No.</b>	94804077 RX94804077
<b>description</b>	formed hose ext. $\varnothing$ 53 ID $\varnothing$ 43mm L 65mm dishwasher straight mounting pos. upper equiv. no. 127036		



1

<b>GEV No.</b>	530603	<b>Ref. No.</b>	RX24556094
<b>description</b>	steam hose ID $\varnothing$ 60mm ED $\varnothing$ 68mm L 120mm Qty 1 for combi-steam-er		

form L



1

<b>GEV No.</b>	512129	<b>Ref. No.</b>	94802089 RX94802089
<b>description</b>	formed hose end piece A ext. $\varnothing$ 75mm end piece A int. $\varnothing$ 59mm AD2 $\varnothing$ 75mm $\varnothing$ end piece B 59mm warewashing L-shape equiv. no. 29532		



1

<b>GEV No.</b>	517228	<b>Ref. No.</b>	24685141 94809811 RX24685141 RX94809811
<b>description</b>	formed hose warewashing L-shape equiv. no. 15032/A		



1

<b>GEV No.</b>	517245	<b>Ref. No.</b>	94814085 RX94814085
<b>description</b>	formed hose warewashing L-shape equiv. no. 15033/A mounting pos. lower		



1

<b>GEV No.</b>	517248	<b>Ref. No.</b>	94809803 RX94809803
<b>description</b>	formed hose warewashing L-shape equiv. no. 16170/M mounting pos. upper		



1

<b>GEV No.</b>	517236	<b>Ref. No.</b>	94808839 RX94808839
<b>description</b>	formed hose warewashing L-shape equiv. no. 3002020		

with branch



1

<b>GEV No.</b>	517364	<b>Ref. No.</b>	RX94814008
<b>description</b>	formed hose ext. ø 58 D1 ø 50mm D2 ø 35mm L 455mm black Qty 1		

form S



1

<b>GEV No.</b>	512130	<b>Ref. No.</b>	94802071 RX94802071
<b>description</b>	formed hose ID ø 50mm S-shape warewashing equiv. no. 25227		



1

<b>GEV No.</b>	517237	<b>Ref. No.</b>	94810132 RX94810132
<b>description</b>	formed hose S-shape warewashing equiv. no. 10200124/A		



1

<b>GEV No.</b>	517227	<b>Ref. No.</b>	RX94814077
<b>description</b>	formed hose S-shape warewashing equiv. no. 25032		



1

<b>GEV No.</b>	517226	<b>Ref. No.</b>	94813962 RX94813962
<b>description</b>	formed hose S-shape warewashing equiv. no. 25032/A		

form U



1

<b>GEV No.</b>	518517	<b>Ref. No.</b>	94804879 RX94804879
<b>description</b>	formed hose for drain pump D1 ø 28mm D2 ø 21mm warewashing U-shape		



1

<b>GEV No.</b>	517255	<b>Ref. No.</b>	94811007 RX94811007
<b>description</b>	formed hose warewashing U-shape equiv. no. 560008 mounting pos. upper		



miscellaneous



1	
<b>GEV No.</b>	517256
<b>Ref. No.</b>	26630038 94809092 RX26630038 RX94809092
<b>description</b>	formed hose warewashing equiv. no. 150048/A mounting pos. upper



1	
<b>GEV No.</b>	517243
<b>Ref. No.</b>	94813963 RX94813963
<b>description</b>	formed hose warewashing equiv. no. 150049 mounting pos. lower

fittings

reducers



1	
<b>GEV No.</b>	520177
<b>Ref. No.</b>	94814405 RX94814405
<b>description</b>	reducer thread 1/4" ET - 1/8" IT nickel-plated brass total length 13mm WS 17

angle pieces

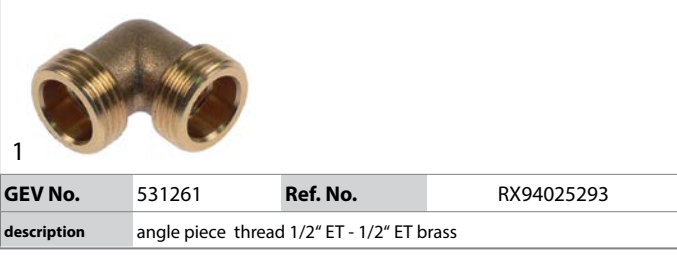

1	
<b>GEV No.</b>	531261
<b>Ref. No.</b>	RX94025293
<b>description</b>	angle piece thread 1/2" ET - 1/2" ET brass

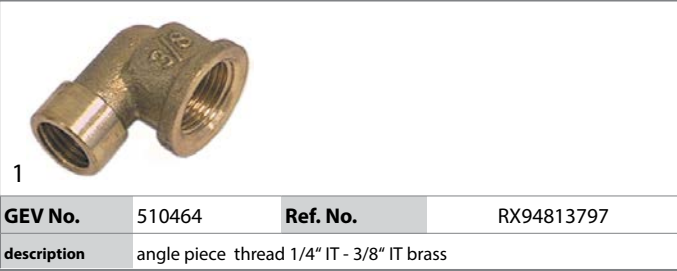

1	
<b>GEV No.</b>	510464
<b>Ref. No.</b>	RX94813797
<b>description</b>	angle piece thread 1/4" IT - 3/8" IT brass

T-pieces

nickel-plated brass



1	
<b>GEV No.</b>	520340
<b>Ref. No.</b>	94814314 RX94814314
<b>description</b>	T-piece thread 1/4" IT - 1/4" IT - 1/4" IT nickel-plated brass L 46mm

fittings, hose and pipe connectors

hose connectors

without screw connection



1	
<b>GEV No.</b>	501210
<b>Ref. No.</b>	94809241 RX94809241
<b>description</b>	Y-piece plastic hose ø 10-10-10mm



hose connectors

brass



1

<b>GEV No.</b>	513253	<b>Ref. No.</b>	RX94804549
<b>description</b>	hose connector brass angled thread 1/4" hose ø 12mm Qty 1 pcs		

nickel-plated brass



1

<b>GEV No.</b>	520203	<b>Ref. No.</b>	94813992 RX94813992
<b>description</b>	hose connector nickel-plated brass straight thread 1/2" hose ø 12mm Qty 1 pcs		



1

<b>GEV No.</b>	520201	<b>Ref. No.</b>	94813991 RX94813991
<b>description</b>	hose connector nickel-plated brass straight thread 1/4" hose ø 12mm Qty 1 pcs		

producer-specific



1

<b>GEV No.</b>	512025	<b>Ref. No.</b>	RX94813769
<b>description</b>	hose connector thread M16x1.25 for hose ID 11mm		

valves and tank inlets

ball valves

universal

ball valves with butterfly handle



1

<b>GEV No.</b>	540658	<b>Ref. No.</b>	RX94032687
<b>description</b>	ball valve connection 3/4" IT - 3/4" IT DN20 total length 69mm		

ball valves with lever handle



1

<b>GEV No.</b>	520282	<b>Ref. No.</b>	94812667 RX94812667
<b>description</b>	ball valve connection 1" IT - 1" IT DN25 total length 67mm with lever handle		





drain systems and wash basins

drain fittings

universal



1

<b>GEV No.</b>	515041	<b>Ref. No.</b>	RX94806775	
<b>description</b>	drain fitting size 3/4" usable heightmm overall height 30mm ED ø 38mm chrome-plated brass			
<b>accessories for</b>	515041			
	<b>GEV No.</b>	515047	<b>Ref. No.</b>	—
	standpipe size 3/4" usable height 28mm overall height 54mm ED ø 20mm chrome-plated brass with O-ring			
	<b>GEV No.</b>	515048	<b>Ref. No.</b>	—
	standpipe size 3/4" usable height 48mm overall height 74mm ED ø 20mm chrome-plated brass with O-ring			
	<b>GEV No.</b>	515049	<b>Ref. No.</b>	—
	standpipe size 3/4" usable height 68mm overall height 94mm ED ø 20mm chrome-plated brass with O-ring			
	<b>GEV No.</b>	515050	<b>Ref. No.</b>	—
	standpipe size 3/4" usable height 98mm overall height 124mm ED ø 20mm chrome-plated brass with O-ring			







## standpipes

3/4"



1

<b>GEV No.</b>	515041	<b>Ref. No.</b>	RX94806775
<b>description</b>	drain fitting size 3/4" usable heightmm overall height 30mm ED ø 38mm chrome-plated brass		
<b>accessories for</b>	515041		
	<b>GEV No.</b>	515047	<b>Ref. No.</b> —
	standpipe size 3/4" usable height 28mm overall height 54mm ED ø 20mm chrome-plated brass with O-ring		
	<b>GEV No.</b>	515048	<b>Ref. No.</b> —
	standpipe size 3/4" usable height 48mm overall height 74mm ED ø 20mm chrome-plated brass with O-ring		
	<b>GEV No.</b>	515049	<b>Ref. No.</b> —
	standpipe size 3/4" usable height 68mm overall height 94mm ED ø 20mm chrome-plated brass with O-ring		
	<b>GEV No.</b>	515050	<b>Ref. No.</b> —
	standpipe size 3/4" usable height 98mm overall height 124mm ED ø 20mm chrome-plated brass with O-ring		

## supply filters



1

<b>GEV No.</b>	520262	<b>Ref. No.</b>	94024528 RX94024528
<b>description</b>	supply filter thread 3/4" IT - 3/4" IT total length 70mm red brass DN20 mesh opening 0.4mm		



1

<b>GEV No.</b>	520898	<b>Ref. No.</b>	RX26612523
<b>description</b>	screen ø 26mm H 52mm suitable for supply filter Caleffi 1"		



1

<b>GEV No.</b>	520790	<b>Ref. No.</b>	94808912 RX94808912
<b>description</b>	supply filter thread 3/4" IT - 3/4" ET total length 72mm nickel-plated brass H 66mm W 46mm		

## water cycle components

### pressure reduction valves

#### pressure reduction valves

##### universal



1

<b>GEV No.</b>	520789	<b>Ref. No.</b>	94810967 RX94810967
<b>description</b>	pressure reduction valve Caleffi series 5362 connection 1/2" default setting 3bar setting range 0.5 up to 6bar p max 25bar t.max. 80°C brass DVGW/SVGW/WRAS/ACS		

## ancillary products

### clamps

#### hose clamps

##### DIN 3017 - W2



1

<b>GEV No.</b>	520118	<b>Ref. No.</b>	94814009 RX94814009
<b>description</b>	hose clamp ø 50-70mm width 9mm Qty 5 pcs DIN 3017		







## tools

### cleaning tools

#### scrapers

			
1			
<b>GEV No.</b>	801816	<b>Ref. No.</b>	RX94806502
<b>description</b>	scraper 1x scraper		

			
1			
<b>GEV No.</b>	705008	<b>Ref. No.</b>	RX94806502
<b>description</b>	scraper for griddle		
<b>spare parts for</b>	705008		
	<b>GEV No.</b>	<b>Ref. No.</b>	—
	 spare blades for scraper Qty 10 pcs		

## measuring equipment

### thermometers

#### built-in thermometers

			
1			
<b>GEV No.</b>	541095	<b>Ref. No.</b>	94801818 94803277 RX94801818 RX94803277
<b>description</b>	thermometer mounting measurements 58x25.5mm 0 up to +120°C capillary pipe 3000mm probe ø 6.5mm probe L 20mm		

## fastening material

### screws

#### hexagonal screws

			
1			
<b>GEV No.</b>	506446	<b>Ref. No.</b>	94016375 RX94016375
<b>description</b>	hexagonal screw thread M8 thread L 40mm SS WS 13 Qty 1 pcs DIN 933 / ISO 4017		

### cylinder head bolts

#### DIN 912/ISO 4762

			
1			
<b>GEV No.</b>	560402	<b>Ref. No.</b>	RX94803210
<b>description</b>	cylinder head bolt thread M5 thread L 10mm L 15.5mm WS 4 SS Qty 1 pcs intake hexagonal DIN 912/ISO 4762		

### grub screws

#### DIN 914/ISO 4027

			
1			
<b>GEV No.</b>	504230	<b>Ref. No.</b>	94814482 RX94814482
<b>description</b>	grub screw thread M5 L 8mm A2-A2L DIN 914/ISO 4027 WS 2.5 Qty 1 pcs		

### miscellaneous

			
1			
<b>GEV No.</b>	560458	<b>Ref. No.</b>	94027281 RX94027281
<b>description</b>	grub screw thread M4 L 5mm intake slotted Qty 1 pcs		

### knurled screws

			
1			
<b>GEV No.</b>	510112	<b>Ref. No.</b>	94803970 RX94803970
<b>description</b>	Thumb screw thread M10 thread L 10mm ø 22mm H 4.5mm SS		

			
1			
<b>GEV No.</b>	517039	<b>Ref. No.</b>	94809910 RX94809910
<b>description</b>	Thumb screw thread M8x1.25 thread L 8mm ø 30mm H 3mm SS mounting pos. lower		

## nuts

## knurled nuts



1

<b>GEV No.</b>	512257	<b>Ref. No.</b>	94813825 RX94813825
----------------	--------	-----------------	------------------------

**description** knurled nut thread M10L ø 30mm H 6.5mm SS



1

<b>GEV No.</b>	512212	<b>Ref. No.</b>	94813745 RX94813745
----------------	--------	-----------------	------------------------

**description** knurled nut thread M10x1.5 ø 30mm H 6.4mm SS



1

<b>GEV No.</b>	510346	<b>Ref. No.</b>	94813742 RX94813742
----------------	--------	-----------------	------------------------

**description** knurled nut thread M17x1 ø 35mm H 6mm SS

## hexagonal nuts

## hexagonal nuts metric (without norm)



1

<b>GEV No.</b>	512416	<b>Ref. No.</b>	RX94007069
----------------	--------	-----------------	------------

**description** hexagonal nut thread M28x1.5 H 8mm WS 46 brass Qty 1 pcs

## hexagonal nuts inch thread



1

<b>GEV No.</b>	517180	<b>Ref. No.</b>	94807530 RX94807530
----------------	--------	-----------------	------------------------

**description** nut thread 1" H 5mm WS 36 SS Qty 1 pcs



1

<b>GEV No.</b>	513025	<b>Ref. No.</b>	94803178 94804168 RX94803178 RX94804168
----------------	--------	-----------------	--

**description** nut thread 1/2" nickel-plated brass H 7.5mm WS 27 Qty 1 pcs



1

<b>GEV No.</b>	520499	<b>Ref. No.</b>	94810881 RX94810881
----------------	--------	-----------------	------------------------

**description** nut thread 1 1/4" H 6mm WS 50 brass Qty 1 pcs



1

<b>GEV No.</b>	503042	<b>Ref. No.</b>	94804812 RX94804812
----------------	--------	-----------------	------------------------

**description** nut thread 3/8" H 6mm brass WS 22 Qty 1 pcs

## hexagonal nuts with PG thread



1

<b>GEV No.</b>	550575	<b>Ref. No.</b>	94010881 R95010881 RX94010881
----------------	--------	-----------------	-------------------------------------

**description** nut thread PG11 H 3mm WS 21 nickel-plated brass Qty 1 pcs

## washers

## spring washers



1

<b>GEV No.</b>	696429	<b>Ref. No.</b>	26160135 RX26160135
----------------	--------	-----------------	------------------------

**description** spring washer ID ø 20.5mm ED ø 40mm steel Qty 1 pcs

## washers

## DIN 125A



1

<b>GEV No.</b>	560112	<b>Ref. No.</b>	94813766 RX94813766
----------------	--------	-----------------	------------------------

**description** plain washer ID ø 5.3mm ED ø 10mm thickness 1mm SS Qty 20 pcs  
DIN 125A for thread M5





1

<b>GEV No.</b>	560333	<b>Ref. No.</b>	RX94801651
----------------	--------	-----------------	------------

**description** plain washer ID ø 6.4mm ED ø 12mm thickness 1.6mm SS Qty 1 pcs  
DIN 125A for thread M6



miscellaneous			
 1			
<b>GEV No.</b>	513223	<b>Ref. No.</b>	94804614 RX94804614
<b>description</b>	disc		

 1			
<b>GEV No.</b>	512041	<b>Ref. No.</b>	94801420 RX94801420
<b>description</b>	plain washer ID ø 14mm ED ø 23.5mm thickness 2mm plastic Qty 1 pcs for wash arm		

### fasteners

slot nuts			
 1			
<b>GEV No.</b>	692006	<b>Ref. No.</b>	RX94004355
<b>description</b>	slot nut W 5mm H 5mm L 20mm		

 1			
<b>GEV No.</b>	560285	<b>Ref. No.</b>	94810964 RX94810964
<b>description</b>	slot nut W 8mm H 7mm L 30mm		

### clamps

hose clamps			
DIN 3017 - W2			
 1			
<b>GEV No.</b>	520118	<b>Ref. No.</b>	94814009 RX94814009
<b>description</b>	hose clamp ø 50-70mm width 9mm Qty 5 pcs DIN 3017		

retaining rings			
DIN 471			
 1			
<b>GEV No.</b>	512260	<b>Ref. No.</b>	94813826 RX94813826
<b>description</b>	retaining ring shaft ø 14mm thickness 1.2mm steel DIN 471		

DIN 6799			
 1			
<b>GEV No.</b>	507015	<b>Ref. No.</b>	94803012 RX94803012
<b>description</b>	retaining ring E D1 ø 7mm D2 ø 14mm SS DIN 6799 thickness 0.9mm for shaft ø 8-11mm		

### consumables

#### sealants and adhesives

high temperature silicone			
 1			
<b>GEV No.</b>	890050	<b>Ref. No.</b>	RX94032679
<b>description</b>	high temperature silicone NOVASIL S76 acetoxy-curing -40 up to +265°C t.max. 280°C anthracite cartridge 310ml		
<b>description</b>	Novasil S56 - cartridge 310ml - anthracite - Developed for applications in the home appliance industry: - Gluing of oven door seals - Gluing of mounting brackets for cooker fascias, oven door seals and handles - Attachment of elastic seals, e.g. to oven doors Temperature resistance: -40°C to +265°C		

#### fuses

fine fuses			
 1			
<b>GEV No.</b>	358677	<b>Ref. No.</b>	RX27630268
<b>description</b>	fine fuse size ø5x20mm 4A fast-acting rated 250V Qty 10 pcs		



1

<b>GEV No.</b>	358607	<b>Ref. No.</b>	27630086 RX27630086
<b>description</b>	fine fuse size ø5x20mm 6.3A slow-acting rated 250V Qty 10 pcs		

<b>A</b>			
alarm devices	38	foam rubber gaskets	114
<b>B</b>		formed hoses	120
ball valves	123	fuses	65, 127
bar burners	84	<b>G</b>	
bi-metal thermostats	15, 15	gas burners	80
booster pumps I	63	gas control valves	73
booster pumps II	64	gas nozzles	85
<b>C</b>		gas taps	66
cable glands	65	gas thermostats	70
cables	65	gaskets for heated units	108
cam switches	26	gaskets for tray rack trolleys	109
ceramic heaters	6	gaskets for wash arm support	115
clamps	124, 127	grub screws	125
cleaning tools	125	<b>H</b>	
coil heating elements	6	handle latches	104
cold air circulating fans (complete)	52	heating elements	3
condensators & interference suppression filters	64	heating elements for bain maries	3
consumables	127	heating elements for chargrills	6
contactors	39	heating elements for chip scuttles	3
container filters	118	heating elements for convection	12
control equipment	30	heating elements for fryers	4
control thermostats	15, 20, 21	heating elements for griddles	4
cylinder head bolts	125	heating elements for ovens	3
<b>D</b>		heating elements for pasta cookers	5
door catches	105	heating elements for plate warmers	6
door seals	108	heating elements for tilting bratt pan	5
door seals for dishwashers	114	hexagonal nuts	126
dosing pumps	117	hexagonal screws	125
drain fittings	123	high temperature silicone	127
drain hoses	119	hob burners	80
drain pumps	64	hose clamps	124, 127
drain systems and wash basins	123	hose connectors	122, 123
<b>E</b>		hoses	119
edgemount latches	104	hot air fans	53
electric accessories	65	hot air motors	52
electric timers	38	hot plates	14
electrodes	52	<b>I</b>	
electronic controllers	42	ignition boxes	74
energy regulators	14	ignition cables	78
<b>F</b>		ignition switches	79
fans	52	ignition units	79
fasteners	127	immersion heating elements	7
fastening material	125	indicator lights	32
filters	64	indicator lights (complete)	33
fine fuses	127	industrial hoses	119
fittings	122	<b>K</b>	
		knurled nuts	126
		knurled screws	125



<b>L</b>			
lamps	32		
light bulbs	35		
<b>M</b>			
magnetic switches	29		
measuring equipment	125		
mechanical timers	38		
microswitches	24		
motors	53		
<b>N</b>			
neon light bulbs	33, 35		
Niplaflex hoses	119		
nuts	126		
<b>O</b>			
operating capacitors	64		
O-rings	110		
oven hinges	106		
oven lamps	36		
<b>P</b>			
piezoelectric igniters	79		
pilot burners	74		
plug-in gaskets	108		
position switches	25		
pre-rinse hoses	119		
pressure control hoses	120		
pressure reduction valves	124, 124		
pressure switches	50		
probes	43		
programme timers	36		
protection hoses	65		
pumps	54		
push/momentary push switches	23		
<b>Q</b>			
quartz heating elements	6		
<b>R</b>			
radiation heaters	14		
reducers	122		
refrigeration fans	52		
refrigeration gaskets	108		
relays	41		
retaining rings	127		
rocker/momentary rocker switches	22		
rotary switches	28		
<b>S</b>			
safety bi-metal thermostats	15		
		safety thermostats	17, 21
		screws	125
		sealants and adhesives	127
		sealing cords	114
		sealing washers	113
		silicone	127
		slot nuts	127
		snap locks	105
		solenoid valves	46
		spray guns	117
		spring washers	126
		stainless steel flexi hoses	119, 119
		standpipes	124
		supply filters	124, 124
		supply hoses	119
		switches and momentary switches	22
		system switches (ROLD)	25
		<b>T</b>	
		temperature probes	43
		terminals	65
		thermocouples	79
		thermostat gaskets	115
		thermostats	15
		threaded cable glands	65
		time relays	42
		timers	36
		toggle switches	24
		tools	125
		tube burners	85
		turning lever locks	104
		<b>U</b>	
		universal hoses	119
		universal probes	43
		<b>V</b>	
		valves and tank inlets	123
		<b>W</b>	
		walk-in fridge catches	105
		wash and rinse pumps	54
		washers	126
		water cycle components	124
		window seals	108