



GAS COMPONENTS



ELECTRIC COMPONENTS



WATER TECHNOLOGY



MECHANICAL COMPONENTS



TOOLS

Spare parts suitable for

ROYAL

Find the complete and up-to-date range of products in our GEV Webshop



Manufacturer catalogue

The most important spare parts and accessories arranged clearly for every manufacturer

- ✓ Complete product range and all appliance data always up to date in the GEV Webshop
- ✓ Alphabetical Index at the end of the catalogue

GEV Webshop

www.gev-online.co.uk

www.gev-online.com





- 🔍 Add to Favourites
- 🔍 Sign In with email address and usual password
- 🔍 Easy-order – place several items in your basket at the same time
- 🔍 Quick Item search – no login needed





heating elements

heating elements for coffee machine

			
1			
GEV No.	417277	Ref. No.	5050009
description	heating element 1300W 220V heating circuits 1 thread 1¼" L 97mm W 26mm H 26mm tube ø 6.5mm connection M4 immersion heater flange with thread WS 37		
accessories for	417277		
	GEV No.	528002	Ref. No. 2001010
	flat gasket PTFE ED ø 57mm ID ø 42mm thickness 3mm Qty 1 pcs equiv. no. 12001/W10470 suitable for		

			
1			
GEV No.	417276	Ref. No.	5050100
description	heating element 2000W 230V heating circuits 1 thread 1¼" L 145mm W 26mm H 28mm tube ø 8.3mm connection M4 immersion heater flange with thread WS 37		

			
1			
GEV No.	417273	Ref. No.	5050710
description	heating element 2400W 230V heating circuits 2 mounting ø 42mm hole distance 74mm L 210mm W 35mm H 27mm hole ø 9.5mm thermostat sleeves ø 7mm length thermostat sleeves 195mm number of thermostat sleeves 1 thermostat sleeve bottom/centre tube ø 8.3mm connection M6 immersion heater 2 hole flange		

			
1			
GEV No.	417275	Ref. No.	5050205
description	heating element 2500W 230V heating circuits 2 thread 1¼" L 285mm W 35mm H 24mm tube ø 8.3mm thermostat sleeves ø 7mm length thermostat sleeves 160mm number of thermostat sleeves 1 thermostat sleeve centre connection M6 immersion heater connection length 30mm flange with thread WS 37		

			
1			
GEV No.	417274	Ref. No.	5050220
description	heating element 3300W 230V heating circuits 2 thread 1¼" L 370mm W 35mm H 24mm tube ø 8.3mm thermostat sleeves ø 7mm length thermostat sleeves 160mm number of thermostat sleeves 1 thermostat sleeve centre connection M6 immersion heater flange with thread WS 37		

			
1			
GEV No.	417272	Ref. No.	5050720 5050720+2001010
description	heating element 3500W 230V heating circuits 2 mounting ø 42mm hole distance 74mm L 335mm W 35mm H 60mm L1 25mm L2 60mm L3 250mm H1 27mm H2 23mm hole ø 9.5mm tube ø 8.3mm thermostat sleeves ø 7mm length thermostat sleeves 195mm thermostat sleeve centre number of thermostat sleeves 1 connection M6 immersion heater 2 hole flange		

			
1			
GEV No.	417270	Ref. No.	5050230
description	heating element 4000W 230V heating circuits 2 thread 1¼" L 495mm W 35mm H 22mm tube ø 8.3mm thermostat sleeves ø 7mm length thermostat sleeves 160mm number of thermostat sleeves 1 thermostat sleeve centre connection M6 immersion heater flange with thread		

			
1			
GEV No.	417271	Ref. No.	5050730
description	heating element 5250-6250W 220-240V heating circuits 2 mounting ø 42mm hole distance 74mm L 515mm W 35mm H 60mm L1 25mm L2 60mm L3 430mm H1 27mm H2 23mm hole ø 9.5mm tube ø 8.3mm thermostat sleeves ø 7mm length thermostat sleeves 195mm thermostat sleeve centre number of thermostat sleeves 1 connection M6 immersion heater 2 hole flange		

			
1			
GEV No.	417269	Ref. No.	5050740
description	heating element 5500W 230V heating circuits 2 mounting ø 42mm hole distance 74mm L 655mm W 35mm H 50mm L1 25mm L2 60mm L3 570mm H1 27mm H2 23mm hole ø 9.5mm tube ø 8.3mm thermostat sleeves ø 7mm length thermostat sleeves 195mm number of thermostat sleeves 1 connection 2 immersion heater 2 hole flange		

accessories

sealing washers

PTFE gaskets

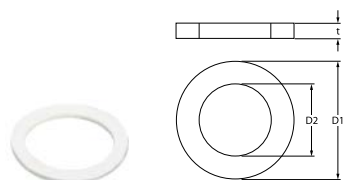
			
1			
GEV No.	528022	Ref. No.	2001001
description	flat gasket PTFE ED ø 52mm ID ø 41mm thickness 2mm size 1¼" Qty 1 pcs suitable for CARIMALI, FAEMA, MARZOCCO, PAVONI		

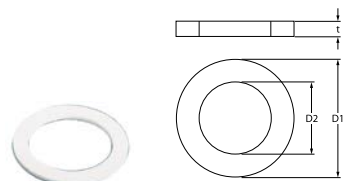
			
1			
GEV No.	528002	Ref. No.	2001010
description	flat gasket PTFE ED ø 57mm ID ø 42mm thickness 3mm Qty 1 pcs equiv. no. 12001/W10470 suitable for		

electric components



thermostats

bi-metal thermostats

safety bi-metal thermostats



1

GEV No.	390690	Ref. No.	5013030
description	bi-metal thermostat switch-off temp. 200°C 1NC 1-pole 10A connection F6.3 thread M4 mounting ø 16mm		

bi-metal thermostats



1

GEV No.	390323	Ref. No.	5013025
description	bi-metal thermostat hole distance mm switch-off temp. 145°C 1NC 1-pole 16A connection F6.3 M4		

control and safety thermostats

PRODIGY / FIRT

control thermostats

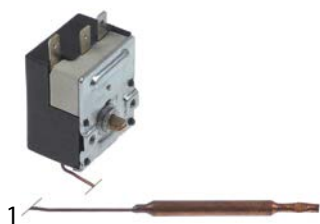

1

GEV No.	390691	Ref. No.	5013010
description	thermostat t.max. 180°C 1-pole 1CO 16A probe ø 6mm probe L 70mm capillary pipe 360mm shaft ø 6x4.6mm shaft L 6mm shaft position upper rotation 270°		

various

safety thermostats



1

GEV No.	375494	Ref. No.	5013005
description	safety thermostat switch-off temp. 155°C 2-pole 2NC 20A probe ø 6mm probe L 92mm capillary pipe 980mm capillary pipe isolated 500mm		

switches and momentary switches

rocker/momentary rocker switches

30x22mm



1

GEV No.	347207	Ref. No.	5003240
description	rocker switch mounting measurements 30x22mm white 2NO 250V 20A illuminated 0-I connection male faston 6.3mm ambient temperature max. 120/55°C protection IP65 with rubber collar		



1

GEV No.	301001	Ref. No.	5003080
description	rocker switch mounting measurements 30x22mm red 2NO 250V 16A illuminated 0-I connection male faston 6.3mm ambient temperature max. 125/55°C protection IP65		

accessories for	301001			
	GEV No.	301036	Ref. No.	—
	protective cover internal size 30x22mm for rocker switch mounting measurements mm			



1

GEV No.	347318	Ref. No.	5003010(Vapore)
description	momentary rocker switch mounting measurements 30x22mm red 2NO 250V 16A steam connection male faston 6.3mm ambient temperature max. 125/55°C protection IP40		



1

GEV No.	346049	Ref. No.	5003040
description	rocker switch mounting measurements 30x22mm red 2NO 250V 16A illuminated cup connection male faston 6.3mm ambient temperature max. 125/55°C protection IP40		

push/momentary push switches

20.6x16.4mm





1

GEV No.	347205	Ref. No.	5003035
description	push switch mounting measurements 20.6x16.4mm chrome 2NO 250V 16A connection male faston 6.3mm ambient temperature max. 85°C protection IP40		



28.5x28.5mm

			
1			
GEV No.	345142	Ref. No.	5003230
description	push switch mounting measurements 28.5x28.5mm red/green 2NO 250V 16A connection male faston 6.3mm ambient temperature max. 150°C protection IP40 with indicator		

			
1			
GEV No.	347206	Ref. No.	5003235
description	push switch mounting measurements 28.5x28.5mm grey 2NO 250V 16A with indicator connection male faston 6.3mm ambient temperature max. 85°C mounting ø 24mm		

ø25mm



			
1			
GEV No.	345160 ¹	Ref. No.	5003210
description	push switch mounting ø 25mm red 2NO 250V 16A illuminated connection male faston 6.3mm ambient temperature max. 85°C protection IP40		

¹illuminated

toggle switches

M12x0.75

			
1			
GEV No.	346520	Ref. No.	5003100
description	toggle switch thread M12x0.75 2CO 250V 15A ON-OFF-ON male faston 6.3mm with neutral position t.max. 85/55°C		

				
1				
GEV No.	346519	Ref. No.	5003045	
description	toggle switch thread M12x0.75 2NO 250V 15A ON-OFF male faston 6.3mm			
accessories for	346519			
	GEV No.	346525	Ref. No.	—
	protection cap L 23.5mm W 17.3mm protection cap rubber thread M11			
	GEV No.	347197	Ref. No.	—
	bezel ON-OFF for toggle switch M12			

microswitches

pin-plunger actuated

			
1			
GEV No.	347211	Ref. No.	5003301
description	microswitch with plunger thread M10x0.75 250V 16A 1CO connection male faston 6.3mm ambient temperature max. 125°C		

			
1			
GEV No.	345325	Ref. No.	5003301
description	microswitch with plunger thread M10x0.75 thread L 14mm 250V 10A 1CO connection male faston 6.3mm stroke 7.5mm mounting distance 22mm L 28mm ambient temperature max. 125°C type NR6K5 actuating force: 260g		

roller actuated

			
1			
GEV No.	345639	Ref. No.	5003310
description	microswitch with roller plunger 230V 16A 1CO connection solder/screw connection L1 49mm ambient temperature max. 125°C thread L 14mm thread M10 mounting distance 25mm actuating force: 300g type MS15-1		

rotary switches

BREMAS			
A1700 series			
			
1			
GEV No.	347198 ¹	Ref. No.	5005105
description	rotary switch 2 0-1 sets of contacts 4 type CA0200004V 400V 20A shaft ø 5x5mm shaft L 19mm shaft square connection screw		

¹incl. rubber protective sleeve

			
1			
GEV No.	346100	Ref. No.	5005035
description	rotary switch 3 1-0-2 sets of contacts 8 type CS0177412 400V 20A shaft ø 5x5mm shaft L 21mm shaft square connection screw		



A2500 series



1

GEV No.	346101	Ref. No.	5005040
description	rotary switch 3 1-0-2 sets of contacts 8 type CS0257412 600V 32A shaft \varnothing 5x5mm shaft L 21mm shaft square connection screw		

KRAUS & NAIMER

rotary switches



1

GEV No.	347209 ¹	Ref. No.	5005020 5005025
description	rotary switch 3 0-1-2 sets of contacts 6 type CA20-ATX12X018 400V 25A shaft \varnothing 22.5mm connection screw code 97/000400 marking I-3461*06		

accessories for 347209



GEV No.	347214	Ref. No.	5005200
description	knob shaft \varnothing 6mm shaft L 20mm complete mounting \varnothing 22mm lever length 35mm		



GEV No.	347215	Ref. No.	5005210
description	knob complete 2 shaft \varnothing 6mm shaft L 20mm complete L 48mm mounting \varnothing 22mm W 48mm mounting distance 36mm		

¹incl. collar

1

GEV No.	347210	Ref. No.	5005028
description	rotary switch sets of contacts 6 type CA25-AT09X016 490V 30A connection screw code I-3461*05		

accessories for 347210



GEV No.	347214	Ref. No.	5005200
description	knob shaft \varnothing 6mm shaft L 20mm complete mounting \varnothing 22mm lever length 35mm		



GEV No.	347215	Ref. No.	5005210
description	knob complete 2 shaft \varnothing 6mm shaft L 20mm complete L 48mm mounting \varnothing 22mm W 48mm mounting distance 36mm		

accessories



1

GEV No.	347215	Ref. No.	5005210
description	knob complete 2 shaft \varnothing 6mm shaft L 20mm complete L 48mm mounting \varnothing 22mm W 48mm mounting distance 36mm		



1

GEV No.	347214	Ref. No.	5005200
description	knob shaft \varnothing 6mm shaft L 20mm complete mounting \varnothing 22mm lever length 35mm		

lamps

indicator lights

indicator lights (complete)

 \varnothing 10mm

with screw socket



1

GEV No.	359476	Ref. No.	5010030
description	indicator light \varnothing 10mm 110/250V red connection male faston 6.3mm		



1

GEV No.	359475	Ref. No.	5010003
description	indicator light \varnothing 10mm 125V green connection male faston 6.3mm		

 \varnothing 16mm

with plug-in socket



1

GEV No.	359474	Ref. No.	5010006
description	indicator light \varnothing 16mm 230V green connection male faston 6.3mm		

spare parts for 359474



GEV No.	345601	Ref. No.	—
description	indicator lamp holder V \varnothing 11mm		









GEV No.	359132	Ref. No.	—
description	indicator lamp green 250V connection male faston 6.3mm protection IP54 ambient temperature max. 85°C		



GEV No.	359247	Ref. No.	—
description	indicator light lens \varnothing 12.2mm green		



 <p>1</p>			
GEV No.	359472	Ref. No.	5010036
description	indicator light ø 16mm 230V red connection male faston 6.3mm		
spare parts for	359472		
	GEV No.	345601	Ref. No. —
indicator lamp holder V ø 11mm			
	GEV No.	359130	Ref. No. —
indicator lamp 230V clear connection male faston 6.3mm ø 8mm			
	GEV No.	359245	Ref. No. —
indicator light lens ø 12.2mm red			

 <p>1</p>			
GEV No.	359473	Ref. No.	5010033
description	indicator light ø 16mm 230V yellow connection male faston 6.3mm		
spare parts for	359473		
	GEV No.	345601	Ref. No. —
indicator lamp holder V ø 11mm			
	GEV No.	359130	Ref. No. —
indicator lamp 230V clear connection male faston 6.3mm ø 8mm			

solid state relays

miscellaneous

 <p>1</p>			
GEV No.	403541	Ref. No.	5012005
description	solid state relay GEFAN 1 phase 50A 480V 3-32VDC L 58mm W 45mm screw type GQ-50-48-D-1-3		

relays

level relays

GICAR

 <p>1</p>			
GEV No.	402103	Ref. No.	5030363
description	level controller 230/240V voltage AC 50/60Hz connection F6.3 type NRL30/1E-2C/F		

 <p>1</p>			
GEV No.	402234	Ref. No.	5030320
description	level controller 230V voltage AC connection F6.3 type RL30/3ES/F/G		

electronics

PCBs

 <p>1</p>			
GEV No.	402235	Ref. No.	5029103
description	display L 117mm W 45mm		

 <p>1</p>			
GEV No.	402246	Ref. No.	5029110
description	display L 135mm W 44mm		

			
1			
GEV No.	402259	Ref. No.	5029105
description	display L 135mm W 44mm		

central units

			
1			
GEV No.	402261	Ref. No.	5030010
description	central unit 230V 50/60Hz 5/10A type 30µZ R/E voltage AC		

			
1			
GEV No.	402245	Ref. No.	5030011 old version
description	central unit 230V 50/60Hz type 30µZ R/E		

			
1			
GEV No.	403926	Ref. No.	5030011
description	central unit kit 230V 50/60Hz		

			
1			
GEV No.	402233	Ref. No.	5030110
description	control box 1-group for coffee machine 230V manual type DOS MAN 1GR NO TEA		

			
1			
GEV No.	402232	Ref. No.	5030115
description	control box 2-group for coffee machine 230V manual type DOS MAN 2GR NO TEA		

			
1			
GEV No.	402241	Ref. No.	5030100
description	control box 3-group for coffee machine 230V type 3d5 MAESTRO DELUXE 6T		

dosing electronics

GICAR

			
1			
GEV No.	402262	Ref. No.	5030120
description	dosing electronics 2-group 230V 50/60Hz 2.1A type DELUXE		

			
1			
GEV No.	402231	Ref. No.	5030080
description	dosing electronics 3-group 230V voltage AC 50/60Hz type 3d5 3GRCTZ XLC (SC) DPG 96 C		

keypads

keypad units



1

GEV No.	402260	Ref. No.	5031380 5031410
description	keypad unit buttons 1 white L 35mm W 26mm		



1

GEV No.	402238	Ref. No.	5031340
description	keypad unit buttons 4 L 135mm W 44mm		



1

GEV No.	402239	Ref. No.	5031350
description	keypad unit buttons 6 L 135mm W 44mm		



1

GEV No.	402240	Ref. No.	5031333
description	keypad unit buttons 6 L 135mm W 44mm with holder		



1

GEV No.	402244	Ref. No.	5031011
description	keypad unit buttons 6 L 88mm W 60mm		



1

GEV No.	402236	Ref. No.	5031015
description	keypad unit coffee machine buttons 5 L 88mm W 60mm		



1

GEV No.	402237	Ref. No.	5031210
description	keypad unit coffee machine Classica/Diadema 2-3-4 gr. buttons 2 L 88mm W 60mm		



1

GEV No.	402258	Ref. No.	5031305
description	keypad unit espresso machine DeLux/Imola/Marenello/Monza 2-3-4 gr. buttons 6 L 135mm W 44mm		



1

GEV No.	402257	Ref. No.	5031280 5301280
description	keypad unit espresso machine Lira 1-2-3-4 gr. buttons 6 L 135mm W 44mm		



solenoid valves

solenoid valves (water)

metal

LUCIFER

spare parts and accessories

valve bodies



1

GEV No.	370061	Ref. No.	BFC01 BFC02
description	solenoid valve body LUCIFER-PARKER 3-ways outer cone		

ODE

solenoid valves steam (water)

21A1 series



1

GEV No.	370093	Ref. No.	5020115
description	solenoid valve 2/2-ways 230VAC body 25-F39 DN 2.5mm slide-on receptacle DIN -10 up to 140°C ODE type series 21A1 coil type BDA membranes FKM p max 14bar 50/60Hz silicone flange 32x32mm		
spare parts for	370093		
	GEV No.	371150	Ref. No. —
accessories for	370093		
	GEV No.	371090	Ref. No. —
	power socket plug type DIN 43650A screw		

31A1 series



1

GEV No.	370572	Ref. No.	5020055
description	solenoid valve brass 3-ways 230VAC DN 1.5mm -10 up to 140°C coil type ADA membranes ruby p max 15bar p min 0bar flange 32x32mm		

PARKER

spare parts and accessories

valve bodies



1

GEV No.	370062	Ref. No.	BFC01 BFC02
description	solenoid valve body PARKER 3-ways outer cone		
accessories for	370062		
	GEV No.	371029	Ref. No. —
description	solenoid coil PARKER 230VAC 9VA coil type ZB09 seat ø 14mm H 33mm W 34mm D 43mm		
	GEV No.	371030	Ref. No. —
description	solenoid coil 24VDC 12VA coil type ZB12 seat ø 14mm		
	GEV No.	371033	Ref. No. —
description	solenoid coil PARKER 230VAC 9VA coil type YB09 with cable seat ø 14mm		
	GEV No.	371036	Ref. No. —
description	solenoid coil 24VAC 9VA coil type ZB09 seat ø 14mm		
	GEV No.	371095	Ref. No. —
description	O-ring Viton thickness 1.78mm ID ø 6.07mm Qty 1 pcs		
	GEV No.	371100	Ref. No. —
description	O-ring silicone thickness 1.78mm ID ø 6.07mm Qty 1 pcs		

pressure switches

for coffee machines

miscellaneous



1

GEV No.	541690	Ref. No.	5006070
description	pressure control pressure range 1.1bar connection 1/4" 16A 1-pole type 250V pressure connection 1/4"		

electrodes



1

GEV No.	401365	Ref. No.	4550005
description	level electrode 1/4" total length 172mm probe L 145mm insulated probe length 26mm connection male faston 6.3mm stainless steel ø 2.5mm		



equipment-specific units

for espresso machines

filter holders

filter holders standard

filter holder without spout



1

GEV No.	525975	Ref. No.	N/A
description	filter holder suitable for BFC/ROYAL1 without outlet mounting \varnothing 83mm outlet 3/8" ID \varnothing 62mm wedge height 10mm wedge position horizontal number of wedges 2 lever inclined		



1

GEV No.	525976	Ref. No.	N/A
description	filter holder suitable for BFC/ROYAL1/RANCILIO without outlet mounting \varnothing 82mm outlet 3/8" ID \varnothing 62mm wedge height 10mm wedge position horizontal number of wedges 2 lever straight		

filter holders short



1

GEV No.	526528	Ref. No.	4650100
description	filter holder mounting \varnothing 82mm outlet 3/8" ID \varnothing 62mm handle M12x1.75 wedge height 10mm wedge position horizontal number of wedges 2 lever straight chrome-plated brass		



1

GEV No.	529050	Ref. No.	4650100
description	filter holder mounting \varnothing 82mm outlet 3/8" ID \varnothing 62mm handle M12x1.75 wedge height 10mm wedge position horizontal number of wedges 2 lever straight chrome-plated brass		
accessories for	529050		
	GEV No.	529045	Ref. No.
			—
	handle \varnothing 35mm thread M12x1.75 thread L 15mm L 125mm black		



1

GEV No.	526527	Ref. No.	4650108
description	filter holder mounting \varnothing 83mm outlet 3/8" ID \varnothing 62mm handle M12x1.75 wedge height 10mm wedge position horizontal number of wedges 2 lever inclined chrome-plated brass		

filters

for 1 cup



1

GEV No.	527631	Ref. No.	N/A
description	coffee filter \varnothing 70mm mounting \varnothing 60.7mm H 17mm cups 1 amount of coffee 8g		



1

GEV No.	529011	Ref. No.	4630051
description	coffee filter \varnothing 70mm mounting \varnothing 60mm H 24.5mm cups 1 amount of coffee 7g perforation \varnothing 0.4mm		

for 2 cups



1

GEV No.	529076	Ref. No.	4630052
description	coffee filter \varnothing 70mm mounting \varnothing 60.8mm H 24.5mm cups 2 amount of coffee 14g ECONOMY		

blind filters



1

GEV No.	529023	Ref. No.	4630100
description	blind filter \varnothing 70mm mounting \varnothing 60mm H 18mm		

brewing units

shower screens

flat



1

GEV No. 529084 **Ref. No.** 4630033

description shower screen ø 52mm hole ø 6.4mm

with upstand



1

GEV No. 528417 **Ref. No.** 0520080

description shower screen ø 58mm H 19mm

filter holder gaskets

flat

with internal notch



1

GEV No. 527986 **Ref. No.** 0520090

description filter holder gasket D1 ø 73.5mm D2 ø 57.5mm H 8.5mm with inside notch Qty 1 pcs



1

GEV No. 527987 **Ref. No.** 2002310

description filter holder gasket D1 ø 73.5mm D2 ø 57.5mm H 8mm with inside notch Qty 1 pcs

brewing units with solenoid valve

components



1

GEV No. 527989 **Ref. No.** 0520096

description drain pipe ø 20mm ID ø 16.5mm L 28mm T1: 1/4" chrome-plated brass



1

GEV No. 527988 **Ref. No.** 0520095

description tap aerator M10x1 L 35mm WS 22

brewing units manual

components

drain units

drain pipes



1

GEV No. 527931 **Ref. No.** 0530060

description drain pipe thread 1/2" int. ø 1 11.5mm int. ø 2 15mm L 35.5mm WS 26



1

GEV No. 527937 **Ref. No.** 0530040

description drain pipe thread 1/2" T1: M30x1.5 L 72mm WS 36



1

GEV No. 528538 **Ref. No.** 0530060

description end piece thread 1/2" int. ø 1 12mm int. ø 2 15mm L 36mm chrome-plated brass WS 26



drain valves

 <p>1</p>			
GEV No.	527936	Ref. No.	0530043
description	valve ED ø 16mm H 27mm		

 <p>1</p>			
GEV No.	526002	Ref. No.	0530043
description	valve support ø 16mm L 27mm brass shaft triangular D1 ø 10mm D2 ø 7mm		

tap aerators

 <p>1</p>			
GEV No.	527932	Ref. No.	0530047
description	tap aerator D1 ø 8mm D2 ø 15mm ID ø 6mm H 6mm brass		

gaskets

 <p>1</p>			
GEV No.	529795	Ref. No.	0510140 0541070
description	gasket D1 ø 13mm D2 ø 4mm thickness 4mm coffee machine		

 <p>1</p>			
GEV No.	527945	Ref. No.	0530080
description	gasket ED ø 16mm ID ø 8mm H 4mm for lever		

nozzle holders

 <p>1</p>			
GEV No.	527949	Ref. No.	0520030
description	nozzle holder thread M30x1.5 IT M16x1.5 IT 1 M6 ø 25.5mm int. ø 1 15mm int. ø 2 17mm L 66mm total length 80mm WS 36 chrome-plated brass		

springs

 <p>1</p>			
GEV No.	527933	Ref. No.	0530045
description	compression spring ø 14.2mm L 21mm wire gauge ø 1.8mm SS		

 <p>1</p>			
GEV No.	527934	Ref. No.	0530030
description	compression spring ø 14.2mm L 45mm wire gauge ø 1.5mm SS		

 <p>1</p>			
GEV No.	527935	Ref. No.	0530095
description	compression spring ø 14.6mm L 33mm wire gauge ø 2mm		

levers

 <p>1</p>			
GEV No.	527943	Ref. No.	0530110
description	lever L 70mm thread M8 shaft diameter 6x6mm		

camshafts

 <p>1</p>			
GEV No.	527940	Ref. No.	0530070
description	camshaft shaft ø 8mm shaft intake ø 6.2mm L 86.5mm W 20mm H 17mm thread M6 brass		

valves







 <p>1</p>			
GEV No.	526008	Ref. No.	0530001
description	valve group outflow L 54.3mm ED ø 16mm shaft ø 4.5mm brass		
accessories for	526008		
	GEV No.	Ref. No.	—
	 compression spring ø 13.8mm L 54.5mm wire gauge ø 1.5mm windings 10 drain valve		

Table continues overleaf

accessories for	526008		
	GEV No.	532550	Ref. No. —
	O-ring NBR 787/70 thickness 2.62mm ID ø 9.13mm Qty 10 pcs		

1			
GEV No.	526007	Ref. No.	0530020
description	valve group supply L 52.8mm ED ø 16mm shaft triangular		

1			
GEV No.	527938	Ref. No.	0530020
description	valve H 52.6mm ED ø 16mm		

1			
GEV No.	527939	Ref. No.	0530001
description	valve H 54.2mm ED ø 16mm		

screw connections

1			
GEV No.	527944	Ref. No.	0530120
description	cap nuts IT M6 ø 15mm L 22mm		

1			
GEV No.	527942	Ref. No.	0530100
description	screw connection thread 1/2" int. ø 1 10.8mm int. ø 2 15mm L 17mm WS 22		

1			
GEV No.	527941	Ref. No.	0530090
description	screw connection thread M30x1.5 IT 1/2" L 39mm WS 26		

components

nozzles

with thread

1			
GEV No.	528486	Ref. No.	0520020
description	nozzle bore ø 0.7mm thread M6x0.75 L 9mm WS 7		

miscellaneous

1			
GEV No.	527948	Ref. No.	4001011
description	protection cap for brewing unit		

screw connections

1			
GEV No.	527270	Ref. No.	0520000
description	end cap thread M16x1.5 ID ø 8.9mm L 21mm chrome-plated WS 22		

water dispersions

water dispersions

group 2

1			
GEV No.	529230	Ref. No.	0520070
description	water distributor ø 30mm hole ø 2mm H 14mm ET M10x1 grooves 6 2mm brass 2 holes perforation ø 1.7mm		

safety valves

safety valves

3/8"



1

GEV No.	527977	Ref. No.	3630030
description	safety valve connection 3/8" triggering pressure 1.8bar approval CE 0036		



1

GEV No.	527976	Ref. No.	3630025
description	safety valve connection 3/8"-1/2" triggering pressure 1.8bar approval CE 0035 sealed		

expansion valves

with hose connection



1

GEV No.	529329	Ref. No.	3630140
description	expansion valve adjustable T1: 3/8" ET hose ø 9.5mm BL 40mm total length 78.6mm		



1

GEV No.	527979	Ref. No.	3630140
description	expansion valve T1: 3/8" ET hose ø 9.5mm L 58mm		

drain pans

drain pans



1

GEV No.	527946	Ref. No.	4008005
description	drain pan L 69mm W 79mm H 54mm hose ø 14mm		

aerators and air bleeders



1

GEV No.	527981	Ref. No.	3630001
description	aerator and air bleeder connection 1/4"		

boilers

heat exchangers

injector tubes



1

GEV No.	527951	Ref. No.	2510002
description	injector pipe tube ø 8mm pipe length 100mm T1: 1/4" T2: 1/4"		



1

GEV No.	527952	Ref. No.	2510005
description	injector pipe tube ø 8mm pipe length 140mm T1: 1/4" T2: 1/4"		

steam/water taps

steam/water taps

steam/water taps



1

GEV No.	527953	Ref. No.	3501030
description	steam/water tap inlet 1/4" outlet 3/8" brass		

steam taps

steam taps (complete)



1

GEV No.	527954	Ref. No.	3501150
description	steam tap mounting pos. external inlet 3/8" outlet 3/8" chrome-plated brass		

components

shafts



1			
GEV No.	527959	Ref. No.	0540080
description	shaft for steam-/water-tap \varnothing 14mm D1 \varnothing 11.5mm D2 \varnothing 7.5mm D3 \varnothing 5.8mm L 88mm brass		

bushes



1			
GEV No.	526010	Ref. No.	0540060
description	bush steam/water tap D1 \varnothing 10.5mm D2 \varnothing 9mm ID \varnothing 6.3mm H 4.6mm brass		
accessories for	526010		
	GEV No.	526005	Ref. No. —
	shaft steam tap \varnothing 14.8mm L 92.5mm thread M6 brass		

gaskets



1			
GEV No.	527961	Ref. No.	0510162 0540090
description	flat gasket copper ED \varnothing 21mm ID \varnothing 17.2mm thickness 1.5mm		



1			
GEV No.	527970	Ref. No.	0541060
description	flat gasket PTFE ED \varnothing 24mm ID \varnothing 18mm thickness 2mm Qty 1 pcs		



1			
GEV No.	527960	Ref. No.	0540085
description	gasket D1 \varnothing 12mm thickness 6mm for steam-/water-tap		



1			
GEV No.	529795	Ref. No.	0510140 0541070
description	gasket D1 \varnothing 13mm D2 \varnothing 4mm thickness 4mm coffee machine		



1			
GEV No.	527972	Ref. No.	0541100
description	gasket set D1 \varnothing 16mm ID \varnothing 7.8mm thickness 4mm rubber for steam-/water-tap		

springs



1			
GEV No.	527958	Ref. No.	0540070
description	compression spring \varnothing 10.5mm L 32mm wire gauge \varnothing 1.3mm for steam-/water-tap		



1			
GEV No.	527968	Ref. No.	0541050
description	compression spring \varnothing 12.5mm L 31mm wire gauge \varnothing 1.8mm		



1			
GEV No.	527969	Ref. No.	0541055
description	compression spring \varnothing 8mm L 21mm wire gauge \varnothing 0.4mm		

tap bodies



1			
GEV No.	527962	Ref. No.	0540095
description	body T1: M16x1 T2: 3/8" T3: 1/4" L 49mm		

washers



1			
GEV No.	527955	Ref. No.	0540030
description	plain washer ID \varnothing 6.1mm ED \varnothing 20mm thickness 1.6mm brass Qty 1 pcs for coffee machine tap		



screw connections

1



GEV No.	527956	Ref. No.	0540040
description	screw connection T1: M16x1 L 61mm ID ø 11mm WS 26 brass		

steam/water pipes

steam pipes

1



GEV No.	527926	Ref. No.	2520530
description	steam pipe thread 3/8" H 120mm L 50mm W 100mm tube ø 10mm SS		

1



GEV No.	527924	Ref. No.	2520512
description	steam pipe thread 3/8" H 170mm W 100mm tube ø 10mm SS		

1



GEV No.	527925	Ref. No.	2520518
description	steam pipe thread 3/8" H 170mm W 120mm tube ø 10mm SS		

1



GEV No.	527927	Ref. No.	2520550
description	steam pipe thread 3/8" H 190mm W 100mm tube ø 10mm SS		

1



GEV No.	527928	Ref. No.	2520555
description	steam pipe thread 3/8" H 250mm W 70mm tube ø 10mm SS		

1



GEV No.	527929	Ref. No.	2520580
description	steam pipe thread 3/8" H 270mm L 70mm W 80mm tube ø 8mm brass		

1



GEV No.	527930	Ref. No.	2520590
description	steam pipe thread 3/8" H 270mm L 70mm W 80mm tube ø 8mm brass		

nozzles for steam pipes

1



GEV No.	527964	Ref. No.	0540150
description	nozzle thread M9x0.75 ø 13mm L 21mm 4 holes bore ø 1.5mm SS		

nozzles for water pipes

gaskets

1



GEV No.	527965	Ref. No.	0540210
description	flat gasket rubber ED ø 21mm ID ø 15mm thickness 3mm Qty 1 pcs		

components



1

GEV No.	527967	Ref. No.	0540220
description	screw connection for flow regulator thread M22x1 L 16mm ϕ 23.5mm ID ϕ 20mm		

tap aerators



1

GEV No.	527966	Ref. No.	0540215
description	tap aerator D1 ϕ 18.8mm D2 ϕ 20.8mm H 12mm		

water pipes



1

GEV No.	527920	Ref. No.	2520007
description	water pipe thread 1/4" ϕ 23.5mm L 105mm WS 17 brass		



1

GEV No.	526614	Ref. No.	2520035
description	water pipe thread 3/8" L 75mm WS 22		



1

GEV No.	527921	Ref. No.	2520015
description	water pipe thread 3/8" ϕ 23.5mm L 112mm WS 22 brass		



1

GEV No.	527923	Ref. No.	2520130
description	water pipe thread 3/8" ϕ 23.5mm L 75mm WS 22 SS		



1

GEV No.	527922	Ref. No.	2520020
description	water pipe thread 3/8" ϕ 23.5mm L 86mm WS 22 brass		

accessories

bushes



1

GEV No.	527971	Ref. No.	0541125
description	bush D1 ϕ 7.8mm D2 ϕ 15mm H 21.5mm brass ID ϕ 6mm		



1

GEV No.	529705	Ref. No.	0540110
description	bush D1 ϕ 8.3mm D2 ϕ 12mm H 6mm brass ID ϕ 7mm		

springs



1

GEV No.	527963	Ref. No.	0540100
description	compression spring ϕ 12mm L 16.5mm wire gauge ϕ 1.5mm steel for steam/water pipes		

tube handles





1

GEV No.	528625	Ref. No.	4005040
description	tube handle L 35mm rubber ID ϕ 8mm		





union nuts			
1			
GEV No.	529706	Ref. No.	0540135
description	union nut thread 3/8" L 21mm hole ø 12.5mm brass		

gaskets			
1			
GEV No.	527995	Ref. No.	0510186
description	gasket ED ø 15mm seat ø 6mm H 5mm overall height 10mm		

various taps			
1			
GEV No.	527975	Ref. No.	3501160
description	water tap inlet 3/8" outlet 3/8" shaft 6.5x6.5 shaft L 19mm brass for cup warmer		

gasket supports			
1			
GEV No.	527997	Ref. No.	0510166
description	gasket support D1 ø 7.3mm D2 ø 13mm H 20mm brass		

fine filters			
1			
GEV No.	528946	Ref. No.	0520010
description	fine filter pipe ø 8.5mm H 22mm		

1			
GEV No.	527996	Ref. No.	0510184
description	gasket support D1 ø 8.6mm D2 ø 17mm int. ø 1 6mm int. ø 2 15mm H 9mm brass		

intake valves			
1			
GEV No.	527957	Ref. No.	4650140
description	intake valve brass with expansion valve inlet 3/8" outlet 1/4"		

levers			
1			
GEV No.	526500	Ref. No.	0510152
description	lever ø 12mm L 48mm brass		

accessories			
1			
GEV No.	526504	Ref. No.	0510142
description	bolt ø 7mm L 47.5mm brass		

miscellaneous			
1			
GEV No.	526503	Ref. No.	0510120
description	piston D1 ø 9mm D2 ø 16mm int. ø 1 13mm H 13mm brass		

bushes			
1			
GEV No.	526501	Ref. No.	0510148
description	bush for lever D1 ø 12mm D2 ø 14.6mm int. ø 1 7mm H 6.7mm brass		

screw connections			
1			
GEV No.	526502	Ref. No.	0510114
description	screw connection thread 1/4" L 28mm WS 24 ID ø 7mm brass		

			
1			
GEV No.	527998	Ref. No.	0510105
description	screw connection thread 1/4" T1: 3/8" L 32mm WS 21 ID ø 7mm brass		

			
1			
GEV No.	527999	Ref. No.	0510150
description	screw connection thread 3/8" L 19mm ø 20mm WS 21 ID ø 12.2mm		

level glasses

level glasses

gaskets

			
1			
GEV No.	529408	Ref. No.	2003010
description	gasket D1 ø 16mm D2 ø 10mm H 8mm water level glass		

balls

			
1			
GEV No.	527947	Ref. No.	4012010
description	ball ø 6mm plastic		

level glass pipes

			
1			
GEV No.	527990	Ref. No.	4580010
description	water level tube ø 11mm H 140mm ID ø 8mm marking Min/Max red		

pipes

pipes

			
1			
GEV No.	527950	Ref. No.	2502006
description	aspiration tube ø 8mm L 98mm		

non-return valves

complete

			
1			
GEV No.	527978	Ref. No.	3630120
description	non-return valve inlet 3/8" outlet 3/8" L 38mm		

screw connections

reducers

			
1			
GEV No.	527980	Ref. No.	3510730
description	reducer T1: 1/8" T2: 1/2" int. ø 1 5mm int. ø 2 14mm L 64mm brass		

T-pieces

			
1			
GEV No.	527985	Ref. No.	3510010
description	T-piece thread 1/4" T1: 1/2" T2: 1/2" int. ø 1 11.5mm int. ø 2 10/14mm L 46mm brass for boiler		

angle pieces

			
1			
GEV No.	527984	Ref. No.	3510005
description	angle piece T1: 1/2" T2: 1/2" int. ø 1 11.5mm int. ø 2 10/14mm L 48mm brass for boiler		

			
1			
GEV No.	527983	Ref. No.	3510004
description	angle piece T1: 1/4" T2: 3/8" int. ø 1 6mm int. ø 2 8mm L 25mm brass		

			
1			
GEV No.	527982	Ref. No.	3510003
description	angle piece T1: 3/8" T2: 3/8" int. ø 1 8.2mm int. ø 2 10mm L 25mm brass		



for dishwashers

washing and rinsing systems



1			
GEV No.	520706	Ref. No.	3530005
description	screw cap thread 1/4" WS 17		

knobs

steam/water taps

steam/water taps



1			
GEV No.	111274	Ref. No.	4001010
description	turning handle ø 41mm thread M18 black		

knob dial plates



1			
GEV No.	111275	Ref. No.	4001020
description	symbol steam ø 32mm L 28mm		



1			
GEV No.	111276	Ref. No.	4001025
description	symbol water ø 32mm L 28mm		

accessories



1			
GEV No.	528762	Ref. No.	0540020
description	cotter pin ø 1.8mm L 17mm		



1			
GEV No.	541691	Ref. No.	4001015
description	star handle shaft 7x7mm ø 64mm L 24mm black thermoplastic		

handles and hand wheels

cone handles



1			
GEV No.	111092	Ref. No.	4001005
description	cone handle thread M8 ø 25mm L 41mm black		

star handles

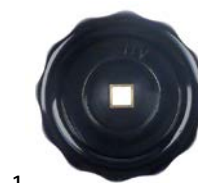

1			
GEV No.	541691	Ref. No.	4001015
description	star handle shaft 7x7mm ø 64mm L 24mm black thermoplastic		

fittings for catering equipment

drain taps

accessories



1			
GEV No.	540222	Ref. No.	2002120
description	O-ring EPDM thickness 2.62mm ID ø 47.3mm Qty 1 pcs		

gaskets

O-rings

EPDM



1			
GEV No.	510177	Ref. No.	0541120
description	O-ring EPDM thickness 1.78mm ID ø 7.66mm Qty 1 pcs		

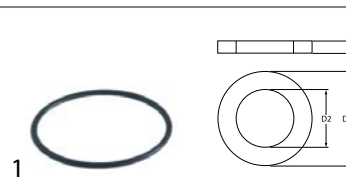

1			
GEV No.	530293	Ref. No.	0510164
description	O-ring EPDM thickness 1.78mm ID ø 8.73mm Qty 1 pcs		

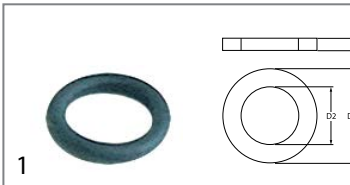

GEV No.	529412	Ref. No.	0541130
description	O-ring EPDM thickness 2.62mm ID ø 10.78mm Qty 1 pcs		

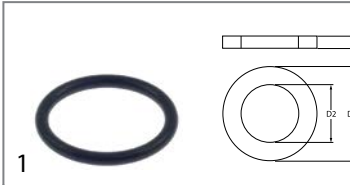

GEV No.	532453	Ref. No.	0520040
description	O-ring EPDM thickness 2.62mm ID ø 21.89mm Qty 1 pcs		

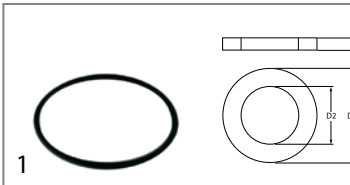

GEV No.	540222	Ref. No.	2002120
description	O-ring EPDM thickness 2.62mm ID ø 47.3mm Qty 1 pcs		

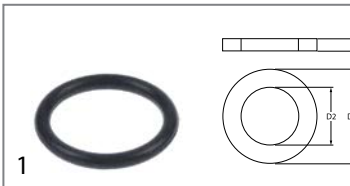

GEV No.	527991	Ref. No.	0510182
description	O-ring EPDM thickness 2mm ID ø 14.5mm Qty 1 pcs		



GEV No.	361311	Ref. No.	0540050
description	O-ring EPDM thickness 2mm ID ø 6mm Qty 1 pcs for type N6		

silicone

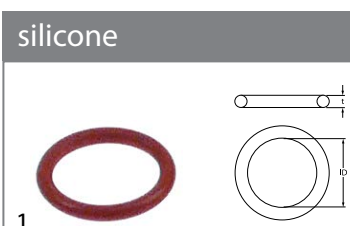

GEV No.	528516	Ref. No.	0540140
description	O-ring silicone thickness 1mm ID ø 6mm Qty 1 pcs		

Viton

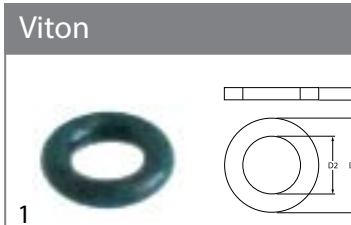

GEV No.	528687	Ref. No.	0510144
description	O-ring Viton thickness 1.78mm ID ø 3.69mm Qty 1 pcs		

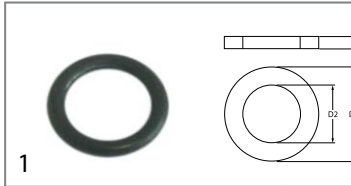

GEV No.	528291	Ref. No.	0540130
description	O-ring Viton thickness 2.62mm ID ø 11.91mm Qty 1 pcs		

sealing washers

rubber gaskets



GEV No.	527965	Ref. No.	0540210
description	flat gasket rubber ED ø 21mm ID ø 15mm thickness 3mm Qty 1 pcs		

copper gaskets

DIN-7603-A



GEV No.	527961	Ref. No.	0510162 0540090
description	flat gasket copper ED ø 21mm ID ø 17.2mm thickness 1.5mm		



GEV No.	527994	Ref. No.	0510112
description	flat gasket copper ED ø 25mm ID ø 19.3mm thickness 1.5mm		

DIN-7603-C





GEV No.	529360	Ref. No.	2004005
description	gasket copper ED ø 26.1mm ID ø 21mm thickness 2.1mm for thread 1/2"		





PTFE gaskets

			
1			
GEV No.	526679	Ref. No.	0510190
description	flat gasket PTFE ED ø 18mm ID ø 13mm thickness 2mm Qty 1 pcs		

			
1			
GEV No.	527993	Ref. No.	0510190
description	flat gasket PTFE ED ø 18mm ID ø 13mm thickness 2mm Qty 1 pcs		

			
1			
GEV No.	528314	Ref. No.	0540120
description	flat gasket PTFE ED ø 20mm ID ø 17mm thickness 2mm Qty 1 pcs suitable for Astoria/Azkoyen/Espressa/Wega		

			
1			
GEV No.	526013	Ref. No.	0520001
description	flat gasket PTFE ED ø 22mm ID ø 17mm thickness 2mm Qty 1 pcs		

			
1			
GEV No.	527970	Ref. No.	0541060
description	flat gasket PTFE ED ø 24mm ID ø 18mm thickness 2mm Qty 1 pcs		

			
1			
GEV No.	528683	Ref. No.	0530050
description	flat gasket PTFE ED ø 26mm ID ø 21mm thickness 2mm Qty 1 pcs suitable for GAGGIA, SPAZIALE		

			
1			
GEV No.	526014	Ref. No.	0520050
description	flat gasket PTFE ED ø 35mm ID ø 30mm thickness 2mm Qty 1 pcs		

			
1			
GEV No.	528022	Ref. No.	2001001
description	flat gasket PTFE ED ø 52mm ID ø 41mm thickness 2mm size 1¼" Qty 1 pcs suitable for CARIMALI, FAEMA, MARZOCCO, PAVONI		

			
1			
GEV No.	528002	Ref. No.	2001010
description	flat gasket PTFE ED ø 57mm ID ø 42mm thickness 3mm Qty 1 pcs equiv. no. 12001/W10470 suitable for		

Viton gaskets

			
1			
GEV No.	528476	Ref. No.	0530010
description	flat gasket Viton ED ø 13mm ID ø 4mm thickness 4mm Qty 1 pcs		

special gaskets

group gaskets

			
1			
GEV No.	528165	Ref. No.	2001310
description	group gasket L 76mm W 72mm thickness 2.5mm aperture 26x64mm hole distance 55mm		

springs

compression springs

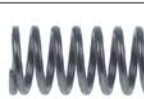
			
1			
GEV No.	527958	Ref. No.	0540070
description	compression spring ø 10.5mm L 32mm wire gauge ø 1.3mm for steam-/water-tap		

			
1			
GEV No.	527968	Ref. No.	0541050
description	compression spring ø 12.5mm L 31mm wire gauge ø 1.8mm		

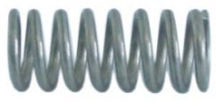
			
1			
GEV No.	528493	Ref. No.	0510110
description	compression spring ø 12.6mm L 30mm wire gauge ø 1.9mm		

			
1			
GEV No.	527963	Ref. No.	0540100
description	compression spring ø 12mm L 16.5mm wire gauge ø 1.5mm steel for steam/water pipes		

			
1			
GEV No.	527933	Ref. No.	0530045
description	compression spring ø 14.2mm L 21mm wire gauge ø 1.8mm SS		

			
1			
GEV No.	527934	Ref. No.	0530030
description	compression spring ø 14.2mm L 45mm wire gauge ø 1.5mm SS		

			
1			
GEV No.	527935	Ref. No.	0530095
description	compression spring ø 14.6mm L 33mm wire gauge ø 2mm		

			
1			
GEV No.	527969	Ref. No.	0541055
description	compression spring ø 8mm L 21mm wire gauge ø 0.4mm		

			
1			
GEV No.	527992	Ref. No.	0510160
description	compression spring ø 8mm L 32mm wire gauge ø 0.5mm		

manometers

			
1			
GEV No.	541685	Ref. No.	4551014
description	manometer double scale ø 63mm pressure range 0-2.5 / 0-15bar connection on the backside thread 1/8"		

			
1			
GEV No.	541686	Ref. No.	4551017
description	manometer double scale ø 63mm pressure range 0-3 / 0-15bar connection on the backside thread 1/8"		

			
1			
GEV No.	541687	Ref. No.	4551035 4551045
description	manometer ø 41mm pressure range 0-15bar thread 1/8" marking 7-8 connection on the backside with capillary pipe		

			
1			
GEV No.	541688	Ref. No.	4551037 4551047
description	manometer ø 41mm pressure range 0-3bar thread 1/8" marking 2 connection on the backside with capillary pipe		

			
1			
GEV No.	541200	Ref. No.	4551022
description	manometer ø 52mm pressure range 0 up to 3bar connection on the backside marking 0.7-1 thread 1/8"		



1 

GEV No.	541201	Ref. No.	4551025
description	manometer ø 53.5mm pressure range 0 up to 16bar connection on the backside thread 1/8"		

1 

GEV No.	541693	Ref. No.	4551040
description	manometer ø 63mm pressure range 0 up to 2.5bar marking 1 up to 1.2 connection 1/8"		

dosing pumps

membrane dosing pumps

self-priming

LANG

spare parts

1 

GEV No.	361311	Ref. No.	0540050
description	O-ring EPDM thickness 2mm ID ø 6mm Qty 1 pcs for type N6		

hoses

industrial hoses

PTFE hoses

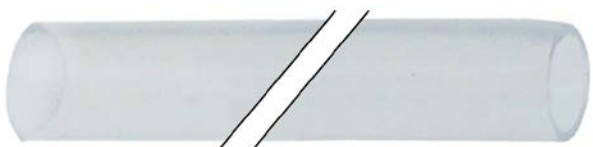
1 

GEV No.	527919	Ref. No.	4010200
description	hose ED ø 12mm ID ø 10mm L 1m PFA		

fittings, hose and pipe connectors

fittings

double nipples

1 

GEV No.	520164	Ref. No.	3510710
description	double nipple nickel-plated brass thread 1/4" - 3/8" Qty 1 pcs		

angle pieces

1 

GEV No.	520824	Ref. No.	3510009
description	angle piece thread 1/8" ET - 1/8" IT nickel-plated brass		

T-pieces

stainless steel

1 

GEV No.	520710	Ref. No.	3510014
description	T-piece thread 1/4" ET - 1/4" ET - 1/4" ET stainless steel L 49mm		

hose connectors

brass

1 

GEV No.	520673	Ref. No.	3520030
description	hose connector brass straight thread 1/2" hose ø 14mm Qty 1 pcs		



valves and tank inlets

ball valves

universal

mini ball valves



1

GEV No.	520722	Ref. No.	3501001
description	ball valve connection 1/4" IT - 1/4" ET DN8 total length 39mm chrome-plated brass		

fastening material

screws

cylinder head bolts

DIN 912/ISO 4762



1

GEV No.	560316	Ref. No.	1103210
description	cylinder head bolt thread M8 thread L 25mm WS 6 SS Qty 20 pcs DIN 912/ISO 4762		

nuts

hexagonal nuts

hexagonal nuts inch thread



1

GEV No.	503042	Ref. No.	0510146
description	nut thread 3/8" H 6mm brass WS 22 Qty 1 pcs		

washers

washers

miscellaneous



1

GEV No.	527955	Ref. No.	0540030
description	plain washer ID ø 6.1mm ED ø 20mm thickness 1.6mm brass Qty 1 pcs for coffee machine tap		

fasteners

cotter pins



1

GEV No.	528762	Ref. No.	0540020
description	cotter pin ø 1.8mm L 17mm		

screw caps



1

GEV No.	520706	Ref. No.	3530005
description	screw cap thread 1/4" WS 17		



1

GEV No.	520705	Ref. No.	3530022
description	screw cap thread 1/8" WS 16		

