



GAS COMPONENTS



ELECTRIC COMPONENTS



WATER TECHNOLOGY



MECHANICAL COMPONENTS



TOOLS

Spare parts suitable for

SPM

Find the complete and up-to-date range of products in our GEV Webshop



Manufacturer catalogue

The most important spare parts and accessories arranged clearly for every manufacturer

- ✓ Complete product range and all appliance data always up to date in the GEV Webshop
- ✓ Alphabetical Index at the end of the catalogue

GEV Webshop

www.gev-online.co.uk

www.gev-online.com



- 🔍 Add to Favourites
- 🔍 Sign In with email address and usual password
- 🔍 Easy-order – place several items in your basket at the same time
- 🔍 Quick Item search – no login needed



thermostats

refrigeration thermostats

RANCO

K50 series

RANCO



GEV No.	390849	Ref. No.	04.BA0031.001
description	thermostat RANCO type K50-L3231/002 probe ø 1.9mm probe Lmm capillary pipe 1200mm		

switches and momentary switches

microswitches

lever actuated



GEV No.	650198	Ref. No.	04.BA0070.001
description	microswitch OMRON 250V 16A connection male faston for SPM		

timers

programme timers



GEV No.	379838	Ref. No.	04.BA0133.001
description	timer GICAR 9.2.20.96G00 electronic engines chambers operation time 230V 50/60Hz shaft ømm shaft Lmm		

electronics

PCBs



GEV No.	650200	Ref. No.	04.GT0003.40K
description	control PCB fast opening suitable for SPM		

solenoïd valves

solenoïd valves (water)

metal

CEME

accessories



GEV No.	371154	Ref. No.	04.ZZ0166.001
description	solenoid coil connection male faston 6.3mm CEME 50Hz 230V H 30mm seat ø 10mm voltage AC		

fans

axial fans

import



GEV No.	601130 ¹	Ref. No.	05.BA0012.002	
description	axial fan L 80mm W 80mm H 25mm 230VAC 50/60Hz 13/14W bearing ball bearing connection male faston 2.8mm metal ADDA fan wheel ø 75mm temp.-resist. 70°C airflow 30.6m ³ /h			
accessories for	601130			
	GEV No.	550898	Ref. No.	—
description	connecting cable cable length 2000mm connection F 2.8 connection distance 7.9mm for axial flow fan			

¹with ball bearings



refrigeration fans

refrigeration motors universal

ELCO

N series - multi fit



1

GEV No.	601528	Ref. No.	04.BB0002.001
----------------	--------	-----------------	---------------

description	fan motor ELCO 16W 230V 50/60Hz bearing slide bearing L1 48mm L2 64mm L3 91.5mm W 83mm connection cable 500mm 1300/1550rpm 5 mounting options VNT16-25/029		
--------------------	--	--	--

spare parts for	601528		
------------------------	--------	--	--



GEV No.	601413	Ref. No.	—
description	fixing plate suitable for fanwheel ED ø 32mm shaft ø 7 mounting distance 26mm		

miscellaneous



1

GEV No.	601823	Ref. No.	04.BC0044.001
----------------	--------	-----------------	---------------

description	fan motor 8W 230V 50Hz L1 50mm L3 88mm cable length 550mm 1900rpm EURO MOTORS 83-2008/1 with capacitor bearing slide bearing capacitor 1.5µF		
--------------------	--	--	--

motors

gear motors

for drink dispensers



1

GEV No.	501440	Ref. No.	04.BA0003.001
----------------	--------	-----------------	---------------

description	gear motor ELCO 230V 50Hz 32rpm shaft ø 6x12mm L 225mm W 70mm H 105mm for drink dispenser		
--------------------	---	--	--

equipment-specific units

for drink dispensers

drain taps

drain taps



1

GEV No.	650203	Ref. No.	05.GC0004.001
----------------	--------	-----------------	---------------

description	tap SPM		
--------------------	---------	--	--



1

GEV No.	650192	Ref. No.	05.BA0007.001
----------------	--------	-----------------	---------------

description	tap white SPM		
--------------------	---------------	--	--

control parts



1

GEV No.	650145	Ref. No.	02.BA0003.001
----------------	--------	-----------------	---------------

description	lever L 58mm W 45mm H 110mm white		
--------------------	-----------------------------------	--	--

springs



1

GEV No.	650146	Ref. No.	04.BA0021.001
----------------	--------	-----------------	---------------

description	compression spring ø 20.5mm L 76mm wire gauge ø 1.7mm windings 7		
--------------------	--	--	--

pistons

			
1			
GEV No.	650148	Ref. No.	02.BA0004.001
description	piston D1 ø 14.5mm D2 ø 24mm D3 ø 20.5mm L 132mm		

miscellaneous

			
1			
GEV No.	650149	Ref. No.	02.BA0053.001 ZZ.VA0004.001
description	pin ø 4mm L 30mm SS		

			
1			
GEV No.	650144	Ref. No.	02.BA0002.001
description	valve body for outlet tap		

transmission technology and ball bearings

flanges

			
1			
GEV No.	650186	Ref. No.	04.CA0019.001
description	flange for mixer UGOLINI		

gear wheels

			
1			
GEV No.	650193	Ref. No.	ZZ.ZZ0001.002
description	gear wheel ø 42.3mm W 28mm SPM		

			
1			
GEV No.	650196	Ref. No.	ZZ.ZZ0002.001
description	gear wheel with bearing SPM		

			
1			
GEV No.	650197	Ref. No.	ZZ.ZZ0001.001
description	gear wheel with bearing SPM		

containers

group 1

			
1			
GEV No.	650190	Ref. No.	02.GT0015.001
description	housing SPM		

accessories

			
1			
GEV No.	650199	Ref. No.	02.GT0023.001
description	lid SPM		

lids

			
1			
GEV No.	650204	Ref. No.	02.BA0006.001
description	lid suitable for SPM		

accessories



1

GEV No.	650194	Ref. No.	02.BA0061.001
----------------	--------	-----------------	---------------

description	mounting wrench for lid SPM		
--------------------	-----------------------------	--	--

gaskets



1

GEV No.	650147	Ref. No.	02.BA0025.001
----------------	--------	-----------------	---------------

description	gasket for auger D1 ø 21mm D2 ø 24mm ID ø 9mm H 18mm silicone		
--------------------	---	--	--



1

GEV No.	650159	Ref. No.	02.BA0009.001
----------------	--------	-----------------	---------------

description	gasket for container D1 ø 160mm ID ø 135mm H 20mm silicone		
--------------------	--	--	--

augers



1

GEV No.	650158	Ref. No.	02.BA0020.002 02.BA0266.001 02.BA0266.SLU
----------------	--------	-----------------	---

description	auger for drink dispenser L 340mm ø 150mm		
--------------------	---	--	--



1

GEV No.	650201	Ref. No.	02.GT0037.001
----------------	--------	-----------------	---------------

description	auger SPM		
--------------------	-----------	--	--



1

GEV No.	650191	Ref. No.	02.GT0036.001
----------------	--------	-----------------	---------------

description	auger SPM L 270mm ø 152mm		
--------------------	---------------------------	--	--

miscellaneous



1

GEV No.	650195	Ref. No.	02.BA0034.001
----------------	--------	-----------------	---------------

description	nut left SPM		
--------------------	--------------	--	--

gaskets

O-rings

EPDM

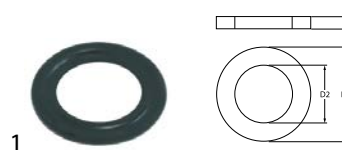

1

GEV No.	532630	Ref. No.	04.BA0026.001
----------------	--------	-----------------	---------------

description	O-ring EPDM thickness 3.53mm ID ø 15.47mm Qty 1 pcs CODE 04061		
--------------------	--	--	--

springs

compression springs



1

GEV No.	650146	Ref. No.	04.BA0021.001
----------------	--------	-----------------	---------------

description	compression spring ø 20.5mm L 76mm wire gauge ø 1.7mm windings 7		
--------------------	--	--	--

fastening material

fasteners

pins



1

GEV No.	650149	Ref. No.	02.BA0053.001 ZZ.VA0004.001
----------------	--------	-----------------	--------------------------------

description	pin ø 4mm L 30mm SS		
--------------------	---------------------	--	--

A

axial fans 3

F

fans 3

fasteners 6

fastening material 6

M

microswitches 3

motors 4

O

O-rings 6

P

pins 6

programme timers 3

R

refrigeration fans 4

refrigeration motors universal 4

refrigeration thermostats 3

S

solenoid valves 3

switches and momentary switches 3

T

thermostats 3

timers 3