



GAS COMPONENTS



ELECTRIC COMPONENTS



WATER TECHNOLOGY



MECHANICAL COMPONENTS



TOOLS

Spare parts suitable for

SAGI

Find the complete and up-to-date range of products in our GEV Webshop



Manufacturer catalogue

The most important spare parts and accessories arranged clearly for every manufacturer

- ✓ Complete product range and all appliance data always up to date in the GEV Webshop
- ✓ Alphabetical Index at the end of the catalogue

GEV Webshop

www.gev-online.co.uk

www.gev-online.com







- 🔍 Add to Favourites
- 🔍 Sign In with email address and usual password
- 🔍 Easy-order – place several items in your basket at the same time
- 🔍 Quick Item search – no login needed





GEV No. 418755 Ref. No. 32G1820
description heating cable 80W 220V ϕ 3mm connection male faston 6.3mm cable length 5250mm
For models: F40CP, F40CPX, F55B, N135BN, N65B, N65BPS, N65NB, P135BN, P135NN, P135NN-3, P65, P65-2, P65B, SX120BN, SX120NN, SX135BB, SX135BCP, SX135BN, SX135BN2, SX135CP, SX135NCP, SX135NN, SX135NN2M, SX55, SX55B, SX55PV, SX65, SX65-2, SX65B, SX65B-2, SX65BAX, SX65BE, SX65BR, SX65CP, SX65CPB, SX65ES, SX65N-3C, SX65NB, SX65PV, SX65R

connection on both sides (metal braided)	
	
GEV No. 419170 Ref. No. 32G0240	
description heating cable 100W 230V L1 (unheated) 600mm L2 (heated) 6600mm ϕ 4mm Qty 1	
For models: CD150BR, TE1A, TE1A-11, TE1A-11A, TE1A-11X, TE1A-2, TE1A-2A, TE1A-2X, TE1A-3, TE1A-3A, TE1A-3X, TE1A-A, TE1A-X, TE1B, TE1B-11, TE1B-11A, TE1B-11X, TE1B-2, TE1B-22, TE1B-22A, TE1B-22X, TE1B-2A, TE1B-2X, TE1B-3, TE1B-3A, TE1B-3X, TE1B-4, TE1B-4A, TE1B-4X, TE1B-A, TE1B-X, TE1C, TE1C-11, TE1C-11A, TE1C-11X, TE1C-2, TE1C-22, TE1C-22A, TE1C-22X, TE1C-2A, TE1C-2X, TE1C-3, TE1C-33, TE1C-33A, TE1C-33X, TE1C-3A, TE1C-3X, TE1C-4, TE1C-4A, TE1C-4X...(Other models you can see in the webshop)	

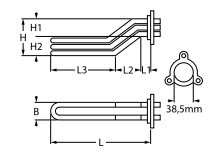

GEV No. 419109 Ref. No. 32G1810
description heating cable 150W 220V L1 (unheated) 2x1000mm L2 (heated) 5000mm ϕ 3.5mm L 7000mm connection male faston 6.3mm
For models: F120B, IMP202R, IMR201R, IMR202R, N135B, N135BPS, P135, P135-3, P135-4, P135B, SX120, SX120B, SX120PV, SX135, SX135-3, SX135-4, SX135B, SX135B-3, SX135B-4, SX135BAX, SX135BE, SX135BR, SX135ES, SX135PV, SX135R

heating cartridges	
	
GEV No. 418892 Ref. No. 32G3310	
description heating cartridge 300W 230V ϕ 12mm L 240mm thread 3/8" cable length 2000mm immersion heater	
For models: AS120, AS120BN, AS120NN, AS140, AS140BN, AS140NN, AS150, AS55, AS65, AS70, AX120, AX120BN, AX120NN, AX130, AX130NN, AX140, AX140BN, AX140NN, AX150, AX150NN, AX55, AX60, AX65, AX70, CD150R, CD70BR, CD70R, DMG102, DMG102-0P141, DMG82, DMG82-0P141, FD150, FD150LT, FD70, FD70LT, GS120, GS120BN, GS120NN, GS130, GS130NN, GS140, GS140BB, GS140BN, GS140BN2, GS140BR, GS140CP, GS140NCP, GS140NN, GS140PV, GS140R...(Other models you can see in the webshop)	
accessories for 418892	
	GEV No. 511472 Ref. No. —
nut thread 3/8" H 4mm brass WS 21 Qty 1 pcs	
	GEV No. 518393 Ref. No. —
flat gasket FIBER ED ϕ 24mm ID ϕ 17mm thickness 2mm Qty 1 pcs	

immersion heating elements

3 hole flange ϕ38.5mm	
	
GEV No. 420061 Ref. No. 3075840	
description heating element 3500W 230V heating circuits 3 L 366mm W 35mm H 60mm L1 30mm L2 56mm L3 280mm H1 36mm H2 24mm hole distance 57mm hole ϕ 10mm tube ϕ 6.2mm connection male faston 6.3mm	
accessories for 420061	
	GEV No. 532577 Ref. No. —
O-ring EPDM thickness 5.34mm ID ϕ 40.65mm Qty 1 pcs	

heating elements for convection

GEV No. 419175 Ref. No. 32G1550
description heating element 2400W 230V heating circuits 1 ID ϕ 190mm ED ϕ 210mm 2 hole fixing connection M4 tube ϕ 8.5mm thread 1/4" heated cabinet
For models: ECB, ECB218, ECN, ECN218, KA12A1E, KA12B1E, KA12B2E, KA12M1E, KA14A1E, KA14B1E, KA14B2E, KA14M1E, KA16A1E, KA16B1E, KA16B2E, KA16M1E, KA18A1E, KA18B1E, KA18B2E, KA18M1E, KA20A1E, KA20B1E, KA20B2E, KA20M1E, KAJ12AE, KAJ12ME, KAJ14AE, KAJ14ME, KAJ16AE, KAJ16ME, QL14CPN, QL14CVB, QL21CPN, QL21CVB

thermostats

control and safety thermostats

EGO

control thermostats

51._ series



1

GEV No.	390033	Ref. No.	32Z0410
description	thermostat t.max. 93°C temperature range 30-93°C 1-pole 1NO 15A probe ø 20/23.5mm probe L 11mm capillary pipe 900mm capillary pipe isolated 800mm gland nut shaft ø 6x4.6mm shaft L 25mm shaft position upper rotation 270° outer switch 2NO probe material SS with knob probe		
For models:	ECB, ECB218, ECN, ECN218, KA12A1E, KA12B1E, KA12B2E, KA12M1E, KA14A1E, KA14B1E, KA14B2E, KA14M1E, KA16A1E, KA16B1E, KA16B2E, KA16M1E, KA18A1E, KA18B1E, KA18B2E, KA18M1E, KA20A1E, KA20B1E, KA20B2E, KA20M1E, KAJ12AE, KAJ12ME, KAJ14AE, KAJ14ME, KAJ16AE, KAJ16ME, KAJ18AE, KAJ18ME, KAJ20AE, KAJ20ME, QL14CPN, QL14CVB, QL21CPN, QL21CVB		
accessories for	390033		
	GEV No.	510167	Ref. No. —
	gasket for thermostat ED ø 41mm ID ø 18mm Qty ANGELO PO/ ZANUSSI pcs equiv. no. 3150270/66717		

55.34_ series



1

GEV No.	375411	Ref. No.	32Z0130
description	thermostat t.max. 93°C temperature range 30-93°C 3-pole 3NO 16A probe ø 6mm probe L 129mm capillary pipe 1480mm capillary pipe isolated 1100mm gland nut M10x1 shaft ø 6x4.6mm shaft L 23mm shaft position upper rotation 270°		

control thermostats with operation switch

55.34_ series



1

GEV No.	390765	Ref. No.	32Z5970
description	thermostat t.max. 110°C temperature range 30-110°C 3-pole 3NO 16A probe ø 6mm probe L 131mm capillary pipe 1160mm gland nut shaft ø 6x4.6mm shaft L 23mm shaft position upper rotation 310°		
For models:	ECB, ECB218, ENB, ENB218, ENB75, QE14VB, QE21VB, QI14VB, QI21VB, QL14CVB, QL14NVB, QL21CVB, QL21NVB, QL7NVB, SVB, SVB218		

refrigeration thermostats

universal without housing



1

GEV No.	390534	Ref. No.	32Z1090 32Z6310 32Z7110
description	thermostat temperature range -35 up to +35°C probe ø6x110mm capillary pipe 1800mm PRODIGY		
For models:	AM03LT7, AM03LT7A, AM03LT7M, AM1LM, AM1LT, AM1LT7, AM1LT7A, AM1LT7M, AS120B, AS120BN, AS140B, AS140BN, AS150B, AS55B, AS65B, AS70B, AT1L, AX120B, AX120BN, AX130B, AX140B, AX140BN, AX150B, AX55B, AX60B, AX65B, AX70B, CD70BPV, DMG51ME, E1200B, E1200B4, E1200BE, E125B, E125B-4, E125BE, E125BPL, E125BPLE, E125BX, E125BX-4, E125BXE, E600B, E600B2, E600BE, E60B, E60B-2, E60BE, E60BPL, E60BPLE, E60BX, E60BX-2...(Other models you can see in the webshop)		
accessories for	390534		
	GEV No.	110305	Ref. No. —
	knob thermostat t.max. 35°C temperature range -35 up to +35°C ø 45mm shaft ø 6x4.6mm shaft flat inclined rotation 270° white		

RANCO

K22 series



1

GEV No.	390209	Ref. No.	32V2280 32V4360
description	thermostat RANCO type K22L1020 probe ø 9mm probe L 40mm capillary pipe 2000mm temperature range -20.5 up to -1.5°C		



K50 series



GEV No.	390278	Ref. No.	32Z6360
description	thermostat RANCO type K50L3207 probe ømm probe Lmm capillary pipe 1500mm temperature range -10 up to -2°C		
For models:	EKP, EKP218, EKP21C, EKPV, EKV, EKV218, EKV21C, EKV, SKP, SKP218, SKP21C, SKPV, SKV, SKV218, SKV21C, SKVV		

K52 series

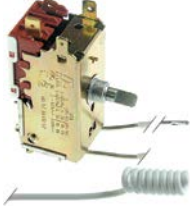

GEV No.	390214	Ref. No.	32Z0920
description	thermostat RANCO type K52L4512 probe ø 11mm probe L 30mm capillary pipe 2100mm temperature range -6.4 up to +3.2°C		
For models:	F40EVP, F40PLA, F40PLE, F40PLPV		

30x22mm

labelled



GEV No.	300125	Ref. No.	32W2331 32W2990
description	rocker switch mounting measurements 30x22mm green 2NO 230V 16A 0-I connection male faston 6.3mm ambient temperature max. 125/55°C protection IP65 with cover cap		
For models:	AM1LM, AT1L, E125, E125-4, E125B, E125B-4, E125BE, E125BPL, E125BPLe, E125BX, E125BX-4, E125BXE, E125E, E125PL, E125PLE, E125PV, E125PVX, E125SP, E125X, E125X-4, E125XE, E125XSP, E60, E60-2, E60B, E60B-2, E60BE, E60BPL, E60BPLe, E60BX, E60BX-2, E60BXE, E60E, E60PL, E60PLE, E60PV, E60PVX, E60SP, E60X, E60X-2, E60XE, E60XSP, EKP, EKP218, EKP21C, EKPV, EKV, EKV218, EKV21C, EKV... (Other models you can see in the webshop)		
accessories for	300125		
	GEV No.	301036	Ref. No. —
	protective cover internal size 30x22mm for rocker switch mounting measurementsmm		



GEV No.	345275	Ref. No.	32W3190
description	rocker switch mounting measurements 30x22mm white 1CO/indicator light 230V 16A 1-2 connection male faston 6.3mm ambient temperature max. 125/55°C protection IP65 with cover cap		
For models:	F120, F120NN, F120PL, F120PV, F120SP, F55, F55PL, F55PV, F55SP, KM1A, KM1A-11, KM1A-11A, KM1A-11X, KM1A-2, KM1A-2A, KM1A-2X, KM1A-4, KM1A-4A, KM1A-4X, KM1A-A, KM1A-X, KM1B, KM1B-11, KM1B-11A, KM1B-11X, KM1B-2, KM1B-22, KM1B-22A, KM1B-22X, KM1B-2A, KM1B-2X, KM1B-4, KM1B-4A, KM1B-4X, KM1B-6, KM1B-6A, KM1B-6X, KM1B-A, KM1B-X, KM1C, KM1C-11, KM1C-11A, KM1C-11X, KM1C-2, KM1C-2A, KM1C-2X, KM1C-4, KM1C-4A, KM1C-4X, KM1C-6... (Other models you can see in the webshop)		

accessories

protective covers



GEV No.	301323	Ref. No.	36C5180
description	protective cover external size 35x35mm H 11mm transparent suitable for rocker switch mounting measurements 25.5x25mm L 35mm W 35mm		

switches and momentary switches

rocker/momentary rocker switches

25.5x25mm



GEV No.	345278 ¹	Ref. No.	32W0990 32W3970
description	rocker switch mounting measurements 25.5x25mm green 2NO 250V 16A illuminated 0-I connection male faston 6.3mm protection IP40		
For models:	AS120, AS120B, AS120BN, AS120NN, AS140, AS140B, AS140BN, AS140NN, AS150, AS150B, AS55, AS55B, AS65, AS65B, AS70, AS70B, AX120, AX120B, AX120BN, AX120NN, AX130, AX130B, AX130NN, AX140, AX140B, AX140BN, AX140NN, AX150, AX150B, AX150NN, AX55, AX55B, AX60, AX60B, AX65, AX65B, AX70, AX70B, CD130, CD130B, CD130BN, CD130NN, CD150, CD150B, CD150BB, CD150BN, CD150BR, CD150CP, CD150NN, CD150PV... (Other models you can see in the webshop)		
accessories for	345278		
	GEV No.	301323	Ref. No. 36C5180
	protective cover external size 35x35mm H 11mm transparent suitable for rocker switch mounting measurements 25.5x25mm L 35mm W 35mm		

¹illuminated



microswitches

lever actuated

 <p>1</p>			
GEV No.	345254	Ref. No.	32W1320
description	microswitch with lever 250V 16A 1CO connection male faston 6.3mm ambient temperature max. 120°C mounting distance 22mm actuating force: 60g lever length 58mm		
For models:	E125, E125-4, E125B, E125B-4, E125BE, E125BPL, E125BPLE, E125BX, E125BX-4, E125BXE, E125E, E125PL, E125PLE, E125PV, E125PVX, E125SP, E125X, E125X-4, E125XE, E125XSP, E60, E60-2, E60B, E60B-2, E60BE, E60BPL, E60BPLE, E60BX, E60BX-2, E60BXE, E60E, E60PL, E60PLE, E60PV, E60PVX, E60SP, E60X, E60X-2, E60XE, E60XSP, F120, F120B, F120NN, F120PL, F120PV, F120SP, F40, F40CP, F40CPX, F40PLA...(Other models you can see in the webshop)		

 <p>1</p>			
GEV No.	345255	Ref. No.	32W1410
description	microswitch with lever 250V 16A 1CO connection male faston 6.3mm L 35mm L1 28mm ambient temperature max. 125°C mounting distance 22mm actuating force: 136g lever length 27mm		

pin-plunger actuated

 <p>1</p>			
GEV No.	345360	Ref. No.	32W1410
description	microswitch with plunger mounting distance 25.4mm thread M12x1 thread L 15mm 250V 10A 1CO connection screw stroke 5mm ambient temperature max. 125°C type Highly D5000 actuating force: 200g		
For models:	SX65CPB		

with push button

switches with snap-fit

 <p>1</p>			
GEV No.	347027	Ref. No.	32W3770
description	microswitch with push button 250V 1A 1CO connection male faston 2.8mm L 26x12mm ambient temperature max. 85°C type XKA-304B1AAJ11 actuating force: 50g		
For models:	AS120, AS120B, AS120BN, AS120NN, AS140, AS140B, AS140BN, AS140NN, AS150, AS150B, AS55, AS55B, AS65, AS65B, AS70, AS70B, AX120, AX120B, AX120BN, AX120NN, AX130, AX130B, AX130NN, AX140, AX140B, AX140BN, AX140NN, AX150, AX150B, AX150NN, AX55, AX55B, AX60, AX60B, AX65, AX65B, AX70, AX70B, E1200, E12004, E1200B, E1200B4, E1200BE, E1200E, E1200PV, E600, E6002, E600B, E600B2, E600BE...(Other models you can see in the webshop)		

 <p>1</p>			
GEV No.	348008	Ref. No.	3096020
description	microswitch with push button 250V 2.5A 1NO/1NC connection male faston 2.8mm/6.3mm L 27mm L1 22mm ambient temperature max. 104°C actuating force: 180g		
For models:	CD130, CD130B, CD130BN, CD130NN, CD150, CD150B, CD150BB, CD150BN, CD150BR, CD150CP, CD150NN, CD150PV, CD150R, CD60, CD60B, CD70, CD702, CD70B, CD70B2, CD70BPV, CD70BR, CD70CP, CD70PV, CD70PVSX, CD70R, CDG150, CDG150B, CDG70, CDG70B, CDPT, CDRI, F40-0P141, F40CP, F40CP-0P141, F40CPX-0P141, F40PV-0P141, F40X-0P141, FD150, FD150B, FD150BT, FD150LT, FD150LTE, FD150T, FD70, FD70B, FD70BT, FD70LT, FD70LTE, FD70T, HD130...(Other models you can see in the webshop)		

magnetic switches

 <p>1</p>			
M10x0.75			
GEV No.	348024	Ref. No.	32w1890 32w3460
description	magnetic switch 1NO 250V 1A P max. 10W connection Faston 6.3mm cable length 2000mm		
For models:	AM14SR, AM1L, AM1L7, AM1L7A, AM1L7M, AM1LR, AM1LW, AM2L, AM2LR, AM2LW, AM2S, AM2SR, AM2SW, AM3S, AM3SR, AM3SW, AM4S, AM4SR, AM4SW, AM7SR, DM101L, DM31, DM31A, DM31M, DM51, DM51A, DM51C, DM51M, DM51ME, DMG101L, DMG51C, DMG51M, DMG51ME-0P141, DMS101L, DMS101S, DMS102S, DMS51, DMS51A, DMS51C, DMS51M, DMS72S, GS65BCP, GS65NB, GS65NCP, GS65NN, IM101L, IM101LR, IM101LW, IM101RAT, IM101S...(Other models you can see in the webshop)		

accessories

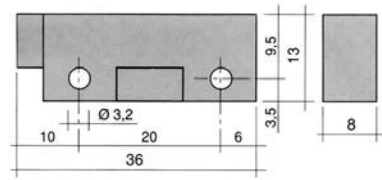
 <p>1</p>			
			
GEV No.	345398	Ref. No.	32V0080
description	magnet ømm L 36mm H 8mm W 13mm hole distance 20mm M3 hole ø 3mm		



lamps

indicator lights

indicator lights (complete)

ø10mm

with screw socket



1

GEV No.	359378	Ref. No.	32W1330
description	indicator light ø 10mm 230V green connection male faston 6.3mm socket screw base		
For models:	ECB, ECB218, ECN, ECN218, ENB, ENB218, ENB75, KA12A1E, KA12B1E, KA12B2E, KA12M1E, KA14A1E, KA14B1E, KA14B2E, KA14M1E, KA16A1E, KA16B1E, KA16B2E, KA16M1E, KA18A1E, KA18B1E, KA18B2E, KA18M1E, KA20A1E, KA20B1E, KA20B2E, KA20M1E, KA-J12AE, KAJ12ME, KAJ14AE, KAJ14ME, KAJ16AE, KAJ16ME, KAJ18AE, KAJ18ME, KAJ20AE, KAJ20ME, QE14VB, QE21VB, QI14VB, QI21VB, QL14CPN, QL14CVB, QL14NVB, QL21CPN, QL21CVB, QL21NVB, QL7NVB, SVB, SVB218		

with plug-in socket



1

GEV No.	359140	Ref. No.	32W0790
description	indicator light ø 10mm yellow 230V connection male faston 6.3mm Qty 1 pcs		
For models:	AM1LW, AM2LW, AM2SW, ECB, ECB218, ECN, ECN218, EKP, EKP218, EKP21C, EKPV, EKV, EKV218, EKV21C, EKVV, ENB, ENB218, ENB75, KA12A1E, KA12B1E, KA12B2E, KA12M1E, KA14A1E, KA14B1E, KA14B2E, KA14M1E, KA16A1E, KA16B1E, KA16B2E, KA16M1E, KA18A1E, KA18B1E, KA18B2E, KA18M1E, KA20A1E, KA20B1E, KA20B2E, KA20M1E, KAJ12AE, KAJ12ME, KAJ14AE, KAJ14ME, KAJ16AE, KAJ16ME, KAJ18AE, KAJ18ME, KAJ20AE, KAJ20ME, QE14PC, QE14VB...(Other models you can see in the webshop)		

30x22mm



1

GEV No.	359156	Ref. No.	32W0270
description	indicator light mounting measurements 30x22mm 230V yellow connection male faston 6.3mm temp.-resist. 125/55°C type RL2		

screw-on/push-on fit

light bulbs

for ovens



1

GEV No.	359614	Ref. No.	32W2350
description	light bulb t.max. 300°C socket E27 230V 40W ø 45mm L 71mm lens L 44mm Qty 1 pcs		
For models:	N135B, N135BN, N135BPS, N65B, N65BPS, N65NB, N65NN, P135, P135-3, P135-4, P135B, P135BN, P135NN, P135NN-3, P65, P65-2, P65B, SX120, SX120B, SX120BN, SX120NN, SX135, SX135-3, SX135-4, SX135B, SX135B-3, SX135B-4, SX135BB, SX135BCP, SX135BN, SX135BN2, SX135BR, SX135CP, SX135NCP, SX135NN, SX135NN2M, SX135R, SX55, SX55B, SX65, SX65-2, SX65B, SX65B-2, SX65BR, SX65CP, SX65CPB, SX65CPN, SX65N-3C, SX65NB, SX65NN...(Other models you can see in the webshop)		

fridge lamps



1

GEV No.	359595	Ref. No.	32W3790
description	light bulb socket E14 15W 230-240V ø 25mm L 56mm lens L 30mm Qty 1 pcs		
For models:	AS120, AS120B, AS120BN, AS120NN, AS140, AS140B, AS140BN, AS140NN, AS55, AS55B, AS65, AS65B, AX120, AX120B, AX120BN, AX120NN, AX140, AX140B, AX140BN, AX140NN, AX55, AX55B, AX65, AX65B, CD130, CD130B, CD130BN, CD130NN, CD150, CD150B, CD150BB, CD150BN, CD150BR, CD150CP, CD150NN, CD150R, CD60, CD60B, CD70, CD702, CD70B, CD70B2, CD70BR, CD70CP, CD70R, CDG150B, CDPT, CDRI, DMG102-0P141, DMG82-0P141...(Other models you can see in the webshop)		



oven lamps

universal oven lamps

mounting diameter 35.5mm



1

GEV No.	360759	Ref. No.	3019720	
description	oven lamp mounting ø 35.5mm 12V 20W socket G4 temp.-resist. 350°C connection cable 450mm hard glas			
spare parts for	360759			
	GEV No.	357192	Ref. No.	—
	halogen lamp socket G4 12V 20W temp.-resist.°C OSRAM HALOSTAR STARLITE			
	GEV No.	357264	Ref. No.	—
	lamp socket socket G4 mounting ø 35.5mm connection cable 450mm			
	GEV No.	359033	Ref. No.	—
	oven lamp glass thr.ø 33.5mm H 36mm ø 41mm hard glas temp.-resist. 350°C			



lamps

light bulbs



1

GEV No.	359614	Ref. No.	32W2350
description	light bulb t.max. 300°C socket E27 230V 40W ø 45mm L 71mm lens L 44mm Qty 1 pcs		
For models:	N135B, N135BN, N135BPS, N65B, N65BPS, N65NB, N65NN, P135, P135-3, P135-4, P135B, P135BN, P135NN, P135NN-3, P65, P65-2, P65B, SX120, SX120B, SX120BN, SX120NN, SX135, SX135-3, SX135-4, SX135B, SX135B-3, SX135B-4, SX135BB, SX135BCP, SX135BN, SX135BN2, SX135BR, SX135CP, SX135NCP, SX135NN, SX135NN2M, SX135R, SX55, SX55B, SX65, SX65-2, SX65B, SX65B-2, SX65BR, SX65CP, SX65CPB, SX65CPN, SX65N-3C, SX65NB, SX65NN...(Other models you can see in the webshop)		

lamp accessories

gaskets



1

GEV No.	511436	Ref. No.	37Q7370
description	gasket for lamp		
For models:	N135B, N135BN, N135BPS, N65B, N65BPS, N65NB, N65NN, P135, P135-3, P135-4, P135B, P135BN, P135NN, P135NN-3, P65, P65-2, P65B, SX120, SX120B, SX120BN, SX120NN, SX135, SX135-3, SX135-4, SX135B, SX135B-3, SX135B-4, SX135BB, SX135BCP, SX135BN, SX135BN2, SX135BR, SX135CP, SX135NCP, SX135NN, SX135NN2M, SX135R, SX55, SX55B, SX65, SX65-2, SX65B, SX65B-2, SX65BR, SX65CP, SX65CPB, SX65CPN, SX65N-3C, SX65NB, SX65NN...(Other models you can see in the webshop)		

timers

programme timers

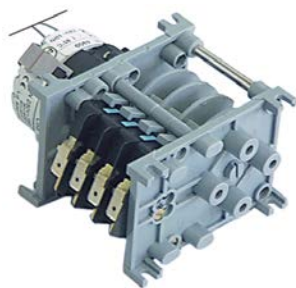



1

GEV No.	360196	Ref. No.	32Z0780
description	timer CDC 4904F engines 1 chambers 4 operation time 60s 230V manif. no. 4904F3 / 3322060 motor type M48L BTN		



1

GEV No.	360215	Ref. No.	32V1940	
description	timer CDC 7805DV engines 2 chambers 5 operation time 6s / 3min 230V shaft ømm shaft Lmm motor type M37RN/M37LN			
spare parts for	360215			
	GEV No.	360119	Ref. No.	—
		motor CDC pinion ø 5.4mm teeth 12 230V turn direction right motor ø 37mm motor type M37RN for timer		
	GEV No.	360131	Ref. No.	—
		motor CDC pinion ø 5.4mm teeth 12 230V turn direction left motor ø 37mm motor type M37LN for timer		



1

GEV No.	360379	Ref. No.	32Z4760	
description	timer CDC 9003F engines 1 chambers 3 operation time 240s 230V shaft ø 6x4.6mm shaft L 20mm manif. no. 9003F1 / 32Z4760 motor type M48R ATS			
spare parts for	360379			
	GEV No.	360118	Ref. No.	—
		motor CDC pinion ø 4.9mm teeth 10 230V voltage AC 50/60Hz turn direction right motor ø 47mm H 19.3mm motor type M48R ATS for timer cable length 260mm 1.9/2.5W		



1

GEV No.	360392	Ref. No.	3175700
description	timer FIBER P25 engines 2 chambers 5 operation time 60s / 3min 230V shaft ømm shaft Lmm		



defrost timers

BIGATTI



1

GEV No.	360058	Ref. No.	32Z7100
description	defrost timer type SB3.82 defrosting interval 1-12x in 24h defrosting time 2-54min fan delay 0-15min 230V defr. funct. 1-12x per 24h		
For models:	F40CP, N65NN, SX65CPN, SX65NN		

CDC



1

GEV No.	360521	Ref. No.	32Z2421
description	defrost timer CDC type 11901F defrosting interval 4x per 24h defrosting time 12min fan delaymin 230V 50-60Hz defr. funct. every 6h		
For models:	F120NN, F120PV, F120SP, F55SP, K160PS, K200PS, N135, N135-3, N135-4, N135BN, N135NN, N135PS, N135PV, N65, N65-2, N65GT, N65PS, N65PV, SX120NN, SX135NN, SX135NN2M, SX65N-3C		



1

GEV No.	360384	Ref. No.	32Z5731
description	defrost timer CDC type 11901F defrosting interval 4x per 24h fan delaymin 230V		
For models:	EM1B, EM1B-2, EM1B-2A, EM1B-2X, EM1B-4, EM1B-4A, EM1B-4X, EM1B-A, EM1B-X, EM1C, EM1C-2, EM1C-2A, EM1C-2X, EM1C-4, EM1C-4A, EM1C-4X, EM1C-6, EM1C-6A, EM1C-6X, EM1C-A, EM1C-X, EXM1B, EXM1B-2, EXM1B-2A, EXM1B-2X, EXM1B-4, EXM1B-4A, EXM1B-4X, EXM1B-A, EXM1B-X, EXM1C, EXM1C-2, EXM1C-2A, EXM1C-2X, EXM1C-4, EXM1C-4A, EXM1C-4X, EXM1C-6, EXM1C-6A, EXM1C-6X, EXM1C-A, EXM1C-X, K100, K100SL, K100SLV, K100X, K100XA, SX135-3E, SX135-4E, SX65-2E...(Other models you can see in the webshop)		

contactors

SIEMENS

power contactors



1

GEV No.	380646	Ref. No.	32Z9250
description	power contactor resistive load 40A 230VAC (AC3/400V) 17A/7.5kW main contacts 3NO auxiliary contacts connection screw connection type 3RT10-25-1AL20		
For models:	AF1L, AF1L7, AF1L7A, AF1L7M, AF2L, AF2S, AF3S, AM1L, AM1L7, AM1L7A, AM1L7M, AM1LR, AM1LT, AM1LT7, AM1LT7A, AM1LT7M, AM1LW, AM2L, AM2LR, AM2LW, AM2S, AM2SR, AM2SW, AM3S, AM3SR, AM3SW, AT1L7, AT1L7A, AT1L7M, DM101L, DMS1, DMS1A, DMS1C, DMS1M, DMG101L, DMG102, DMG102-0P141, DMG51C, DMG51M, DMG82, DMG82-0P141, DMS101L, DMS101S, DMS102S, DMS51, DMS51A, DMS51C, DMS51M, DMS72S, GR135BT...(Other models you can see in the webshop)		

relays

power relays

with bracket mounting



1

GEV No.	380139	Ref. No.	32Z2000
description	power relays FINDER 230VAC 16A 2CO connection F6.3 bracket mounting dimensions 68x38.2x35.8mm manuf. no. 62.82.8.230.0000		



			
1			
GEV No.	380185	Ref. No.	32V3720
description	power relays Italiana Relè 230VAC 30A 1NO connection F6.3 bracket mounting dimensions 36.5x32.2x51.8mm manuf. no. A10-230AC-FA		
For models:	AM03LT7, AM03LT7A, AM03LT7M, AS120B, AS120BN, AS140B, AS140BN, AS150B, AS55B, AS65B, AS70B, AT1L, AT1L7, AT1L7A, AT1L7M, AX120B, AX120BN, AX130B, AX140B, AX140BN, AX150B, AX55B, AX60B, AX65B, AX70B, CD130B, CD130BN, CD150B, CD150BB, CD150BN, CD150BR, CD60B, CD70B, CD70B2, CD70BPV, CD70BR, CDG150B, CDG70B, DM31, DM31A, DM31C, DM31M, DM51ME, DMG-51ME, DMG51ME-0P141, DR51, DR51A, DR51M, E1200B, E1200B4... (Other models you can see in the webshop)		

transformers

open transformers

with plug connection

			
1			
GEV No.	400956	Ref. No.	32V5770
description	transformer primary 230VAC secondary 12VAC 20VA connection male faston 6.3mm 50/60Hz type T602012/E temperature restriction 150°C ambient temperature max. 80°C		
For models:	IF101L, IF51M		

encapsulated transformers

PMA

			
1			
GEV No.	379054	Ref. No.	32Z3470
description	transformer primary 230VAC secondary 12VAC 3VA secondary 0.25A H 40mm L 45mm W 50mm connection screw 50/60Hz type 153/M		
For models:	AM1LM, E125B, E125B-4, E125BE, E125BPL, E125BPLe, E125BX, E125BX-4, E125BXE, E125SP, E125XSP, E60B, E60B-2, E60BE, E60BPL, E60BPLe, E60BX, E60BX-2, E60BXE, E60SP, E60XSP, EKP, EKP218, EKP21C, EKPV, EKV, EKV218, EKV21C, EKV, F120, F120B, F120PL, F120PV, F40CP, F40CPX, F55, F55B, F55PL, F55PV, FD140, FD140B, FD140NN, FD140PV, FD65, FD65B, FD65PV, FDPT, FDRI, HD130B, HD130BN... (Other models you can see in the webshop)		

electronic controllers

ELIWELL

refrigeration controllers

built-in version

			
1			
GEV No.	379114	Ref. No.	32Z3460
description	electronic controller ELIWELL type EWPC961 mounting measurements 71x29mm		

			
1			
GEV No.	379102	Ref. No.	32Z3660
description	electronic controller ELIWELL type EWPC970 mounting measurements 71x29mm 12V relay outputs 8A		

			
1			
GEV No.	379614	Ref. No.	32V7580
description	electronic controller ELIWELL type ID961 mounting measurements 71x29mm 230V voltage AC NTC/PTC front measurements 33x75mm protection IP65 1x NTC probe inclusive -50 up to +150°C display 3½ digit LCD 1999 Digits		
For models:	AS120, AS140, AS150, AS70, AX120, AX130, AX130NN, AX140, AX150, AX150NN, AX60, AX70		
accessories for	379614		
	GEV No.	Ref. No.	32V6000
	temperature probe NTC 10kOhm cable PVC probe -20 up to +80°C cable -10 up to 100°C probe ø7x24.5mm cable length 1.5m without screw connection 2-wire		
	GEV No.	Ref. No.	—
	temperature probe PTC 1kOhm cable silicone probe -50 up to +150°C cable -50 up to +180°C probe ø6x40mm cable length 1.5m without screw connection 2-wire		
	GEV No.	Ref. No.	—
	temperature probe PTC 1kOhm cable PVC probe -50 up to +150°C cable -10 up to 100°C probe ø6x30mm cable length 3m without screw connection 2-wire		
	GEV No.	Ref. No.	—
	temperature probe NTC 10kOhm cable PVC probe -20 up to +80°C cable -10 up to 100°C probe ø6x25mm cable length 3m 2-wire		
	GEV No.	Ref. No.	8223470
	temperature probe PTC 1kOhm cable silicone probe -50 up to +150°C cable -50 up to +180°C probe ø6x40mm cable length 3m without screw connection 2-wire		

Table continues overleaf



accessories for 379614			
GEV No.	379142	Ref. No.	—
temperature probe PTC 1kOhm cable PVC probe -50 up to +150°C cable -10 up to 100°C probe ø6x30mm cable length 1.5m without screw connection 2-wire			
GEV No.	379160	Ref. No.	—
temperature probe NTC 10kOhm cable thermoplastic probe -40 up to +110°C cable -40 up to +110°C probe ø6x14mm cable length 1.5m without screw connection 2-wire			
GEV No.	379161	Ref. No.	32V6010
temperature probe NTC 10kOhm cable thermoplastic probe -40 up to +110°C cable -40 up to +110°C probe ø6x14mm cable length 3m without screw connection 2-wire			
GEV No.	379343	Ref. No.	32V3730
temperature probe NTC 10kOhm cable silicone probe -40 up to +110°C cable -50 up to +180°C probe ø6x40mm cable length 3m 2-wire			
GEV No.	379458	Ref. No.	—
temperature probe NTC 10kOhm cable silicone probe -40 up to +110°C cable -50 up to +180°C probe ø6x40mm cable length 1.5m without screw connection 2-wire			
GEV No.	379781	Ref. No.	—
temperature probe PTC 1kOhm cable thermoplastic probe -50 up to +150°C cable -40 up to +110°C probe ø6x14mm cable length 1.5m without screw connection 2-wire			
GEV No.	379782	Ref. No.	—
temperature probe PTC 1kOhm cable thermoplastic probe -50 up to +150°C cable -40 up to +110°C probe ø6x14mm cable length 3m 2-wire resistor 1kOhm			

EVCO - EVERY CONTROL

universal controllers

built-in version



1

GEV No.	379632	Ref. No.	32V0421
description	electronic controller EVERY CONTROL mounting measurements 135x66mm built-in depth 67mm 230V voltage AC with accessories -50 up to +100°C type ECS805P220D306 front measurements 142x70mm		
For models:	AF2L, AF2S, AF3S		

refrigeration controllers

built-in version



1

GEV No.	379232	Ref. No.	32V6500
description	electronic controller		
For models:	RX70R		



1

GEV No.	381388	Ref. No.	32V2090
description	electronic controller ANGELO PO conversion kit mounting measurements 71x29mm 230V voltage AC NTC front measurements 33x75mm protection IP65 1x NTC probe inclusive -40 up to +99°C		
For models:	EM1A, EM1A-2, EM1A-2A, EM1A-2X, EM1A-A, EM1A-X, EM1B, EM1B-2, EM1B-2A, EM1B-2X, EM1B-4, EM1B-4A, EM1B-4X, EM1B-A, EM1B-X, EM1C, EM1C-2, EM1C-2A, EM1C-2X, EM1C-4, EM1C-4A, EM1C-4X, EM1C-6, EM1C-6A, EM1C-6X, EM1C-A, EM1C-X, EXM1A, EXM1A-2, EXM1A-2A, EXM1A-2X, EXM1A-A, EXM1A-X, EXM1B, EXM1B-2, EXM1B-2A, EXM1B-2X, EXM1B-4, EXM1B-4A, EXM1B-4X, EXM1B-A, EXM1B-X, EXM1C, EXM1C-2, EXM1C-2A, EXM1C-2X, EXM1C-4, EXM1C-4A, EXM1C-4X, EXM1C-6...(Other models you can see in the webshop)		



1

GEV No.	379613	Ref. No.	32V2980
description	electronic controller ANGELO PO mounting measurements 71x29mm 12V voltage AC NTC front measurements 33x75mm protection IP65 2xNTC probe inclusive -40 up to +110°C		
For models:	N135B, N135BN, N135BPS, N65B, N65BPS, RX70BCP, SX120B, SX120BN, SX135B-3, SX135B-4, SX135BB, SX135BCP, SX135BN, SX135BR, SX55B, SX65B, SX65B-2, SX65BR, SX65CPB, SX65NB		



1			
GEV No.	379609	Ref. No.	32V6060
description	electronic controller ANGELO PO mounting measurements 71x29mm 12V voltage AC NTC relay outputs 1 relay front measurements 33x75mm protection IP65 2xNTC probe inclusive -40 up to +99°C compressor relay 16A		
For models:	AS120B, AS120BN, AS140B, AS140BN, AS55B, AS65B, AX120B, AX120BN, AX140B, AX140BN, AX55B, AX65B, E1200B, E1200B4, E1200BE, E600B, E600B2, E600BE, GX130B, GX150B, GX60B, GX70B		



1			
GEV No.	379608	Ref. No.	32V6080
description	electronic controller EVERY CONTROL mounting measurements 71x29mm 12V voltage AC NTC relay outputs 1 relay front measurements 33x75mm protection IP65 2xNTC probe inclusive -40 up to +99°C compressor relay 16A		
For models:	RX150B, RX150BB, RX150BB2, RX150BN, RX150BN2, RX150BR, RX70B, RX70B-2, RX70BR		



1			
GEV No.	378187	Ref. No.	32V6050
description	electronic controller EVERY CONTROL mounting measurements 71x29mm 230V voltage AC NTC/PTC relay outputs 1 CO -50 up to +150°C display 3 1/2 digits		
For models:	GX130, GX130NN, GX150, GX150NN, GX60, GX70		

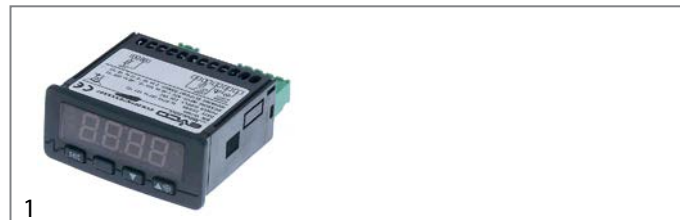

1			
GEV No.	378192	Ref. No.	32V6900
description	electronic controller EVERY CONTROL type EVK201 mounting measurements 71x29mm 230V voltage AC NTC relay outputs 1 relay 1CO NTC defr. funct. no -50 up to +150°C display 3 1/2 digits compressor relay 10A		
For models:	EM1A, EM1A-2, EM1A-2A, EM1A-2X, EM1A-A, EM1A-X, EM1B, EM1B-2, EM1B-2A, EM1B-2X, EM1B-4, EM1B-4A, EM1B-4X, EM1B-A, EM1B-X, EM1C, EM1C-2, EM1C-2A, EM1C-2X, EM1C-4, EM1C-4A, EM1C-4X, EM1C-6, EM1C-6A, EM1C-6X, EM1C-A, EM1C-X, EXM1A, EXM1A-2, EXM1A-2A, EXM1A-2X, EXM1A-A, EXM1A-X, EXM1B, EXM1B-2, EXM1B-2A, EXM1B-2X, EXM1B-4, EXM1B-4A, EXM1B-4X, EXM1B-A, EXM1B-X, EXM1C, EXM1C-2, EXM1C-2A, EXM1C-2X, EXM1C-4, EXM1C-4A, EXM1C-4X, EXM1C-6...(Other models you can see in the webshop)		



1			
GEV No.	378126	Ref. No.	3087950 3107290 3120900 32V6920 32V7490 32V7820 32V8590
description	electronic controller EVERY CONTROL type EVK201N7 mounting measurements 71x29mm 230V voltage AC NTC/PTC relay outputs 1 CO-16A(5) NTC/PTC front measurements 33x75mm built-in depth 59mm protection IP65 -40 up to +105°C display 3 1/2 digits		
For models:	AS120, AS120BN, AS120NN, AS140, AS140BN, AS140NN, AS55, AS65, AX120, AX120BN, AX120NN, AX140, AX140BN, AX140NN, AX55, AX65, F40, F40-0P141, F40PLA, F40PLE, F40PLPV, F40PV, F40PV-0P141, F40X, F40X-0P141, FD150, FD70, HD130, HD130BN, HD130NN, HD150, HD150BN, HD150NN, HD60, HD70, KAL1433, KAL1433V, KAL1437, KAL1437V, KAL1633, KAL1633V, KAL1637, KAL1637V, KAL2033, KAL2033V, KAL2037, KAL2037V, KAL2533, KAL2533V, KAL2537...(Other models you can see in the webshop)		

accessories for	378126		
	GEV No.	379053	Ref. No. —
		temperature probe PTC 1kOhm cable PVC probe -50 up to +150°C cable -10 up to 100°C probe ø6x30mm cable length 3m without screw connection 2-wire	
	GEV No.	379064	Ref. No. 8223470
		temperature probe PTC 1kOhm cable silicone probe -50 up to +150°C cable -50 up to +180°C probe ø6x40mm cable length 3m without screw connection 2-wire	
	GEV No.	379161	Ref. No. 32V6010
		temperature probe NTC 10kOhm cable thermoplastic probe -40 up to +110°C cable -40 up to +110°C probe ø6x14mm cable length 3m without screw connection 2-wire	
	GEV No.	379782	Ref. No. —
		temperature probe PTC 1kOhm cable thermoplastic probe -50 up to +150°C cable -40 up to +110°C probe ø6x14mm cable length 3m 2-wire resistor 1kOhm	



GEV No.	378154	Ref. No.	3048060 3096600 3106300 3107300 3119780
description	electronic controller EVERY CONTROL type EVK203N7VXBS mounting measurements 71x29mm 230V voltage AC NTC/PTC relay outputs 3 NO-16A(5) CO-8A(4) NO-8A(4) NTC/PTC NTC/PTC DI front measurementsmm built-in depth 59mm protection IP65 yes -50 up to +150°C display 3½ digits		
For models:	FD150LT, FD70LT, KBS11, KBS11A, KBS11M, KBS16, KBS16A, KBS16M, KBS21, KBS21A, KBS21M, KBSR11, KBSR11A, KBSR11M, KBSR16, KBSR16A, KBSR16M, KBSR21, KBSR21A, KBSR21M, KIA, KIA11, KIA11A, KIA11M, KIA13, KIA13A, KIA13M, KIA2, KIA2A, KIA2M, KIAA, KIAM, KIB, KIB11, KIB11A, KIB11M, KIB13, KIB13A, KIB13M, KIB2, KIB22, KIB22A, KIB22M, KIB2A, KIB2M, KIB4, KIB4A, KIB4M, KIBA, KIBM...(Other models you can see in the webshop)		
accessories for	378154		
	GEV No.	379053	Ref. No. —
	temperature probe PTC 1kOhm cable PVC probe -50 up to +150°C cable -10 up to 100°C probe ø6x30mm cable length 3m without screw connection 2-wire		
	GEV No.	379064	Ref. No. 8223470
	temperature probe PTC 1kOhm cable silicone probe -50 up to +150°C cable -50 up to +180°C probe ø6x40mm cable length 3m without screw connection 2-wire		
	GEV No.	379161	Ref. No. 32V6010
	temperature probe NTC 10kOhm cable thermoplastic probe -40 up to +110°C cable -40 up to +110°C probe ø6x14mm cable length 3m without screw connection 2-wire		
	GEV No.	379782	Ref. No. —
	temperature probe PTC 1kOhm cable thermoplastic probe -50 up to +150°C cable -40 up to +110°C probe ø6x14mm cable length 3m 2-wire resistor 1kOhm		



GEV No.	378189	Ref. No.	32V6290 32V6300
description	electronic controller EVERY CONTROL type EVK213 mounting measurements 71x29mm 12V voltage AC/DC NTC/PTC relay outputs 3 relays -40 up to +105°C display 3½ digits DEF Relay 8A fan relay 8A compressor relay 16A		
For models:	RX150CP, RX70NB, RX70NCP		



GEV No.	378188	Ref. No.	32V6070 32V6270
description	electronic controller EVERY CONTROL type FK203B mounting measurements 71x29mm 12V voltage AC/DC NTC relay outputs 3 relays -40 up to +99°C DEF Relay 8A fan relay 8A compressor relay 10A		
For models:	FD65PV, RX150, RX150-3, RX150-4, RX150BB, RX150BB2, RX150BN, RX150BN2, RX150CP, RX150NCP, RX150NN, RX150PV, RX150R, RX70, RX70-2, RX70PV		



GEV No.	378190	Ref. No.	32V6280
description	electronic controller EVERY CONTROL type FK203B mounting measurements 71x29mm 12V voltage AC/DC NTC relay outputs 3 relays -40 up to +99°C DEF Relay 8A fan relay 8A compressor relay 10A		
For models:	RX70NB, RX70NCP, RX70NN		



GEV No.	378191	Ref. No.	32V6260
description	electronic controller EVERY CONTROL type FK203B mounting measurements 71x29mm 12V voltage AC/DC NTC relay outputs 3 relays -40 up to +99°C DEF Relay 8A fan relay 8A compressor relay 10A		
For models:	RX150NCP		



GEV No.	378193	Ref. No.	32V2920
description	electronic controller EVERY CONTROL type FK206A mounting measurements 71x29mm 12V voltage AC/DC NTC -40 up to +99°C		
For models:	JA, JA2, JA2A, JA2M, JAA, JAM, JB, JB2, JB2A, JB2M, JB4A, JB4M, JBA, JBM		



accessories



GEV No.	378197	Ref. No.	32V7460
description	printer EVERY CONTROL PM100AX9S201 mounting measurements 90x90mm		
For models:	AM14SR, AM7SR, IMP202R, IMR201R, IMR202R		

SHANGFANG

accessories



GEV No.	379054	Ref. No.	32Z3470
description	transformer primary 230VAC secondary 12VAC 3VA secondary 0.25A H 40mm L 45mm W 50mm connection screw 50/60Hz type 153/M		
For models:	AM1LM, E125B, E125B-4, E125BE, E125BPL, E125BPLE, E125BX, E125BX-4, E125BXE, E125SP, E125XSP, E60B, E60B-2, E60BE, E60BPL, E60BPPE, E60BX, E60BX-2, E60BXE, E60SP, E60XSP, EKP, EKP218, EKP21C, EKPV, EKV, EKV218, EKV21C, EKVV, F120, F120B, F120PL, F120PV, F40CP, F40CPX, F55, F55B, F55PL, F55PV, FD140, FD140B, FD140NN, FD140PV, FD65, FD65B, FD65PV, FDPPT, FDR1, HD130B, HD130BN... (Other models you can see in the webshop)		

probes

universal probes

temperature probes



GEV No.	378194	Ref. No.	32V6000
description	temperature probe NTC 10kOhm cable PVC probe -20 up to +80°C cable -10 up to 100°C probe ø7x24.5mm cable length 1.5m without screw connection 2-wire		
For models:	E1200, E12004, E1200E, E1200PV, E600, E6002, E600E, E600PV, GX130, GX130NN, GX150NN, GX60, KBP41P, KBP41X, KBP53G, KBP53V, KBP53X, KBP64G, KBP64V, KBP64X, KBP83G, KBP83V, KBP83X, KBP94G, KBP94V, KBP94X, KBPZ16, KBPZ163A, KBPZ163B, KBPZ163S, KBPZ167A, KBPZ167B, KBPZ167S, KBPZ20, KBPZ203A, KBPZ203B, KBPZ203S, KBPZ207A, KBPZ207B, KBPZ207S, KBPZ25, KBPZ253A, KBPZ253B, KBPZ257A, KBPZ257B, KUA, KUA2, KUA2A, KUA2M, KUAA... (Other models you can see in the webshop)		

GEV No.	379343	Ref. No.	32V3730
description	temperature probe NTC 10kOhm cable silicone probe -40 up to +110°C cable -50 up to +180°C probe ø6x40mm cable length 3m 2-wire		
For models:	CD130, CD130B, CD130BN, CD130NN, CD150, CD150B, CD150BB, CD150BN, CD150CP, CD150NN, CD150PV, CD60, CD60B, CD70, CD702, CD70B, CD70B2, CD70BPV, CD70CP, CD70PV, CD70PVSX, CDG150, CDG150B, CDG70, CDG70B, CDPT, CDRI, DM31, DM31A, DM31C, DM31M, DM51, DM51A, DM51C, DMS1M, DMG101L, DMG102, DMG102-0P141, DMG51C, DMG51M, DMG82, DMG82-0P141, DMS101L, DMS101S, DMS102S, DMS51, DMS51A, DMS51C, DMS51M, DMS72S... (Other models you can see in the webshop)		

GEV No.	379161	Ref. No.	32V6010
description	temperature probe NTC 10kOhm cable thermoplastic probe -40 up to +110°C cable -40 up to +110°C probe ø6x14mm cable length 3m without screw connection 2-wire		
For models:	AS120, AS120B, AS120BN, AS120NN, AS140, AS140B, AS140BN, AS140NN, AS150, AS150B, AS55, AS55B, AS65, AS65B, AS70, AS70B, AX120, AX120B, AX120BN, AX120NN, AX130, AX130B, AX130NN, AX140, AX140B, AX140BN, AX140NN, AX150, AX150B, AX150NN, AX55, AX55B, AX60, AX60B, AX65, AX65B, AX70, AX70B, CD130, CD130B, CD130BN, CD130NN, CD150, CD150B, CD150BB, CD150BN, CD150BR, CD150CP, CD150NN, CD150PV... (Other models you can see in the webshop)		

GEV No.	379064	Ref. No.	8223470
description	temperature probe PTC 1kOhm cable silicone probe -50 up to +150°C cable -50 up to +180°C probe ø6x40mm cable length 3m without screw connection 2-wire		

GEV No.	379487	Ref. No.	32V0150
description	temperature probe PTC cable silicone probe -50 up to +150°C cable -50 up to +180°C probe ø6x30mm cable length 2.5m without screw connection 2-wire		
For models:	AF1L, AF1L7, AF1L7A, AF1L7M, AF2L, AF2S, AF3S, AM03LT7, AM03LT7A, AM03LT7M, AM14SR, AM1L, AM1L7, AM1L7A, AM1L7M, AM1LM, AM1LR, AM1LT, AM1LT7, AM1LT7A, AM1LT7M, AM1LW, AM2L, AM2LR, AM2LW, AM2S, AM2SR, AM2SW, AM3S, AM3SR, AM3SW, AM4S, AM4SR, AM4SW, AM7SR, AT1L, AT1L7, AT1L7A, AT1L7M, DMG51ME, DR51, DR51A, DR51M, KAF1B, KAF1N, KAF2B, KAF2N, P135, P135-3, P135-4... (Other models you can see in the webshop)		



producer-specific probes

core probes



GEV No.	378550	Ref. No.	32V8360
description	core temperature probe NTC 10kOhm cable silicone probe -40 up to +120°C cable -50 up to +180°C connection 2-wire probe ø4.5x100mm thread cable length 3.8m handle ø 16mm handle length 120mm		
For models:	DM101L, DM31, DM31A, DM31C, DM31M, DM51, DM51A, DM51C, DM51M, DM51ME, DMG101L, DMG102, DMG102-0P141, DMG51C, DMG51M, DMG51ME-0P141, DMG82, DMG82-0P141, DMS101L, DMS101S, DMS102S, DMS51, DMS51A, DMS51C, DMS51M, DMS72S		

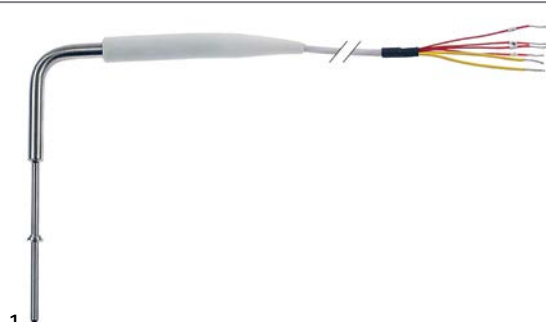

GEV No.	378402 ¹	Ref. No.	32V7960
description	core temperature probe Pt100 cable silicone probe -40 up to +120°C cable -50 up to +180°C connection 5-wire probe ø5x175mm thread cable length 3.5m handle ø 16mm handle length 125mm		
For models:	IM101L, IM101LR, IM101LW, IM101RAT, IM101S, IM101SC, IM101SR, IM102S, IM102SC, IM102SR, IM102SW, IM51, IM51A, IM51AR, IM51C, IM51CR, IM51H, IM51M, IM51MR, IM51R, IM51WC, IM61, IM72S, IM72SR, IM72SW, IMFEB, IMFEB-0P141, IMFEG, IMFEN, IMFEN-0P141, IMP202R, IMR201R, IMR202R, IMS101L, IMS101S, IMS102S, IMS51, IMS51A, IMS51M, IMS72S, IMSFEB, IMSFEN, IR101L, IR101S, IR51, IR51A, IR51C, IR51M, IR72S		

¹multipoint probe



GEV No.	378186	Ref. No.	32V0010 32V0441 32V8600
description	core temperature probe PTC 1kOhm cable silicone probe -40 up to +120°C cable -50 up to +180°C connection 2-wire probe ø4x90mm thread cable length 3.8m handle ø 15mm handle length 120mm L1 175mm L2 190mm		
For models:	AF1L, AF1L7, AF1L7A, AF1L7M, AF2L, AF2S, AF3S, AM14SR, AM1L, AM1L7, AM1L7A, AM1L7M, AM1LM, AM1LR, AM1LT, AM1LT7, AM1LT7A, AM1LT7M, AM1LW, AM2L, AM2LR, AM2LW, AM2S, AM2SR, AM2SW, AM3S, AM3SR, AM3SW, AM4S, AM4SR, AM4SW, AM7SR, DM101L, DM31, DM31A, DM31C, DM31M, DM51, DM51A, DM51C, DM51M, DM51ME, DMG101L, DMG51C, DMG51M, DMG51ME-0P141, DMS101L, DMS101S, DMS102S, DMS51...(Other models you can see in the webshop)		

electronics

PCBs

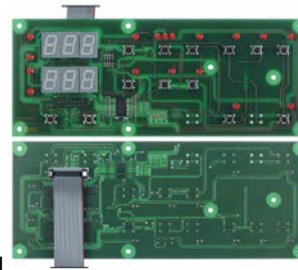

GEV No.	403729	Ref. No.	32V3060
description	control PCB L 203mm W 80mm		
For models:	AM2L, AM2LR, AM2LW, AM2S, AM2SR, AM2SW, AM3S, AM3SR, AM3SW, AM4S, AM4SR, AM4SW, AM7SR		

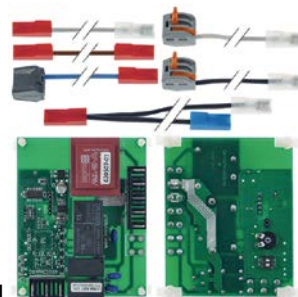

GEV No.	403687	Ref. No.	62044100
description	electronic timer for ice maker Simag mounting measurements 90x70mm 230		



1

GEV No.	401750	Ref. No.	32Z8940
description	keypad PCB		
For models:	AM2L, AM2LR, AM2LW, AM2S, AM2SR, AM2SW, AM3S, AM3SR, AM3SW, AM4S, AM4SR, AM4SW		



1

GEV No.	401747	Ref. No.	32V8030
description	power PCB for blast chiller SERIE IM suitable for SAGI		
For models:	IM101L, IM101LW, IM101RAT, IM101S, IM101SC, IM102S, IM102SC, IM102SW, IMS1, IMS1A, IMS1C, IMS1H, IMS1M, IMS1WC, IM61, IM72S, IM72SW, IMFEB, IMFEB-OP141, IMFEG, IMFEN, IMFEN-OP141, IMS101L, IMS101S, IMS102S, IMS51, IMS51A, IMS51M, IMS72S, IMSFEB, IMSFEN		



1

GEV No.	401751	Ref. No.	32Z8240
description	keypad PCB		
For models:	AM1L, AM1LR, AM1LW		

keypads

front foils

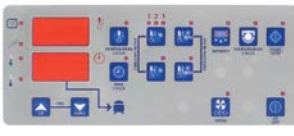

1

GEV No.	378403	Ref. No.	37N0480
description	front foil blast freezer SAGI		
For models:	AM2L, AM2LR, AM2LW, AM2S, AM2SR, AM2SW, AM3S, AM3SR, AM3SW, AM4S, AM4SR, AM4SW, AM7SR		



1

GEV No.	401749	Ref. No.	32Z9640
description	PCB		
For models:	AM1L, AM1LR, AM1LW, AM2L, AM2LR, AM2LW, AM2S, AM2SR, AM2SW, AM3S, AM3SR, AM3SW, AM4S, AM4SR, AM4SW		

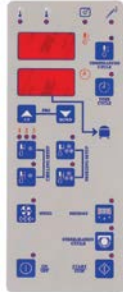

1

GEV No.	401956	Ref. No.	37N0470
description	keypad foil		
For models:	AM14SR, AM1L, AM1L7, AM1L7A, AM1L7M, AM1LR, AM1LW		



1

GEV No.	697908	Ref. No.	32V0740
description	PCB L 102mm W 95mm 50/60Hz 230/400V		



1

GEV No.	401752	Ref. No.	37M7330
description	keypad foil SAGI suitable for for ice maker L 200mm W 60mm buttons 8		
For models:	AM1L, AM1LW		





membrane keypads

			
GEV No.	402027	Ref. No.	37M7340
description	membrane keypad for blast freezer buttons 8 suitable for SAGI L 200mm W 60mm		
For models:	AM2L, AM2LW, AM2S, AM2SR, AM2SW, AM3S, AM3SR, AM3SW, AM4S, AM4SR, AM4SW		

solenoid valves

solenoid valves (water)

TP			
			
GEV No.	370015	Ref. No.	33D1371
description	solenoid valve single angled 230VAC inlet 3/4" outlet 11.5mm DN10 TP		
For models:	KAF1B, KAF1B-OP141, KAF1N, KAF1N-OP141, KAF2B, KAF2B-OP141, KAF2N, KAF2N-OP141, KAFRI, KBF16, KBF16A, KBF16M, KBF21, KBF21A, KBF21M		

accessories for	370015			
	GEV No.	371220	Ref. No.	—
		reducer TP flow rate 3l/min red tolerance ±15%		
	GEV No.	371221	Ref. No.	—
		reducer TP flow rate 5.5l/min yellow tolerance ±15%		
	GEV No.	371222	Ref. No.	—
		reducer TP flow rate 6l/min grey tolerance ±15%		
	GEV No.	371223	Ref. No.	—
		reducer TP flow rate 10l/min white tolerance ±15%		
	GEV No.	371224	Ref. No.	—
		reducer TP flow rate 12l/min bronze tolerance ±15%		
	GEV No.	371225	Ref. No.	—
		reducer TP flow rate 16l/min light brown tolerance ±15%		
	GEV No.	371226	Ref. No.	—
		reducer TP flow rate 20l/min red tolerance ±15%		
	GEV No.	371230	Ref. No.	—
		reducer TP flow rate 0.25l/min red tolerance ±25%		
	GEV No.	371231	Ref. No.	—
		reducer TP flow rate 0.35l/min violet tolerance ±25%		
	GEV No.	371232	Ref. No.	—
		reducer TP flow rate 0.5l/min orange tolerance ±25%		

accessories for	370015			
	GEV No.	371233	Ref. No.	—
		reducer TP flow rate 0.8l/min white tolerance ±25%		
	GEV No.	371234	Ref. No.	—
		reducer TP flow rate 1l/min light blue tolerance ±25%		
	GEV No.	371235	Ref. No.	—
		reducer TP flow rate 1.2l/min brown tolerance ±25%		
	GEV No.	371236	Ref. No.	—
		reducer TP flow rate 1.5l/min light brown tolerance ±25%		
	GEV No.	371237	Ref. No.	—
		reducer TP flow rate 2.5l/min yellow tolerance ±25%		
	GEV No.	371238	Ref. No.	—
		reducer TP flow rate 3.4l/min dark green tolerance ±25%		
	GEV No.	371239	Ref. No.	—
		reducer TP flow rate 5l/min black tolerance ±25%		
	GEV No.	371240	Ref. No.	—
		reducer TP flow rate 8l/min blue tolerance ±20%		

solenoid valves (refrigeration)

PARKER			
valves			
			
GEV No.	370611	Ref. No.	33A0510
description	solenoid valve 2-way 230V 1.9 tube ø 6mm coil type ZB09 50/60Hz		
For models:	E125SP, E125XSP, E60SP, E60XSP, EKP, EKP218, EKP21C, EKPV, EKV, EKV218, EKV21C, EKV, F120, F120NN, F120PL, F120PV, F120SP, F40CP, F40CPX, F55, F55PL, F55PV, F55SP, FD140, FD140NN, FD140PV, FD65, FD65PV, GS140BN2, GS140CP, GS140NCP, GS65CP, JA, JA2, JA2A, JA2M, JAA, JAM, JB, JB2, JB2A, JB2M, JB4A, JB4M, JBA, JBM, K160GPZ, K160PS, K160PZ, K160SL...(Other models you can see in the webshop)		

pressure switches

for refrigeration

RANCO

G60 series



GEV No.	541195	Ref. No.	32Z6350
description	pressure control RANCO G60H1129401		
For models:	AM4S, AM4SR, AM4SW, N135NN, N65NN, SX65CPN, SX65NN		

compressors

ACC/ZEL

R134A

HMBP monophase

High/Medium evaporation temperature above -20/-15 °C



GEV No.	605007	Ref. No.	34D6390
description	compressor coolant R134a type GL60TB 220-240V 50Hz HMBP fully hermetic 9.5kg 1/5HP power input 437W cylinder capacity 5.7cm ³ CSIR H 175.5mm 95W 128W 170W 222W 284W 355W 437W 528W test method ASHRAE ambient temperature max. 43°C		
For models:	E60, E60-2, E60E, E60PL, E60PLE, E60PV, E60PVX, E60SP, E60X, E60X-2, E60XE, E60XSP, F40CP, F40CPX, GS140CP, GS65NB, GS65NCP, GS65NN, K100, K100SL, K100SLV, K100X, K100XA, KM1A, KM1A-11, KM1A-11A, KM1A-11X, KM1A-2, KM1A-2A, KM1A-2X, KM1A-4, KM1A-4A, KM1A-4X, KM1A-A, KM1A-X, KTRA, KTRA2, KTRA2A, KTRA2M, KTRA4, KTRA4A, KTRA4M, KTRAA, KTRAM, RX150CP, RX70BCP, RX70NB, RX70NCP, RX70NN, SX65-2E...(Other models you can see in the webshop)		



GEV No.	605008	Ref. No.	34D6500
description	compressor coolant R134a type GL80TB 220-240V 50Hz HMBP fully hermetic 9.5kg 1/5HP power input 554W cylinder capacity 7.6cm ³ CSIR H 175.5mm 165W 215W 290W 390W 500W 615W 727W 840W test method ASHRAE ambient temperature max. 43°C		
For models:	EM1B, EM1B-2, EM1B-2A, EM1B-2X, EM1B-4, EM1B-4A, EM1B-4X, EM1B-A, EM1B-X, EXM1B, EXM1B-2, EXM1B-2A, EXM1B-2X, EXM1B-4, EXM1B-4A, EXM1B-4X, EXM1B-A, EXM1B-X, F55, F55PL, F55PV, F55SP, JB, JB2, JB2A, JB2M, JB4A, JB4M, JBA, JBM, KPE1633, KPE1633V, KPZ20, KPZ2033A, KPZ2033B, KPZ2037A, KPZ2037B, N135BN, N65, N65-2, N65GT, N65PS, N65PV		



GEV No.	605009	Ref. No.	34D6510
description	compressor coolant R134a type GL90TB 220-240V 50Hz HMBP fully hermetic 10.8kg 1/4HP power input 293W cylinder capacity 8.8cm ³ CSIR H 175.5mmW 143W 194W 259W 339W 432W 539W 661W 796W test method ASHRAE		
For models:	K160PS, K200PS, KM1B, KM1B-11, KM1B-11A, KM1B-11X, KM1B-2, KM1B-22, KM1B-22A, KM1B-22X, KM1B-2A, KM1B-2X, KM1B-4, KM1B-4A, KM1B-4X, KM1B-6, KM1B-6A, KM1B-6X, KM1B-A, KM1B-X, KM1C, KM1C-11, KM1C-11A, KM1C-11X, KM1C-2, KM1C-2A, KM1C-2X, KM1C-4, KM1C-4A, KM1C-4X, KM1C-6, KM1C-6A, KM1C-6X, KM1C-8, KM1C-8A, KM1C-8X, KM1C-A, KM1C-X, KTRB, KTRB11, KTRB11A, KTRB11M, KTRB2, KTRB2A, KTRB2M, KTRB4, KTRB4A, KTRB4M, KTRB6, KTRB6A...(Other models you can see in the webshop)		



1

GEV No.	605010	Ref. No.	34D6520 34D6760
description	compressor coolant R134a type GP12TB 220-240V 50Hz HMBP fully hermetic 11.2kg 3/8HP power input 661W cylinder capacity 12cm ³ CSIR H 203.6mmW 143W 194W 259W 339W 432W 539W 661W 796W test method ASHRAE ambient temperature max. 43°C		
For models:	E125, E125-4, E125E, E125PL, E125PLE, E125PV, E125PVX, E125SP, E125X, E125X-4, E125XE, E125XSP, EM1C, EM1C-2, EM1C-2A, EM1C-2X, EM1C-4, EM1C-4A, EM1C-4X, EM1C-6, EM1C-6A, EM1C-6X, EM1C-A, EM1C-X, EXM1C, EXM1C-2, EXM1C-2A, EXM1C-2X, EXM1C-4A, EXM1C-4X, EXM1C-6, EXM1C-6A, EXM1C-6X, EXM1C-A, EXM1C-X, F120, F120NN, F120PL, F120PV, F120SP, FD140NN, FD65, FD65PV, GR65TN, GS140BN2, GS140CP, GS140NCP, GS65CP, KPE2033... (Other models you can see in the webshop)		

EMBRACO / ASPERA

R134A

HBP monophase

High evaporation temperature above -15°C



1

GEV No.	605209	Ref. No.	34D5490
description	compressor coolant R134a type NEK6187Z-A 220-240V 50Hz HBP 11kg 1/3HP cylinder capacity 10cm ³ CSIR H 200mmWWW 365W 482W 624W 791W 983W 1201W test method EN 12900 ambient temperature max. 55°C		
For models:	TE1B, TE1B-11, TE1B-11A, TE1B-11X, TE1B-2, TE1B-22, TE1B-22A, TE1B-22X, TE1B-2A, TE1B-2X, TE1B-3, TE1B-3A, TE1B-3X, TE1B-4, TE1B-4A, TE1B-4X, TE1B-A, TE1B-X, TE1C, TE1C-11, TE1C-11A, TE1C-11X, TE1C-2, TE1C-22, TE1C-22A, TE1C-22X, TE1C-2A, TE1C-2X, TE1C-3, TE1C-33, TE1C-33A, TE1C-33X, TE1C-3A, TE1C-3X, TE1C-4, TE1C-4A, TE1C-4X, TE1C-6, TE1C-6A, TE1C-6X, TE1C-A, TE1C-X, TM1B, TM1B-11, TM1B-11A, TM1B-11X, TM1B-2, TM1B-22, TM1B-22A, TM1B-22X...(Other models you can see in the webshop)		

evaporation and condensing trays



condensing trays heated

universal

heating cartridges



1

GEV No.	418892	Ref. No.	32G3310
description	heating cartridge 300W 230V ø 12mm L 240mm thread 3/8" cable length 2000mm immersion heater		
For models:	AS120, AS120BN, AS120NN, AS140, AS140BN, AS140NN, AS150, AS55, AS65, AS70, AX120, AX120BN, AX120NN, AX130, AX130NN, AX140, AX140BN, AX140NN, AX150, AX150NN, AX55, AX60, AX65, AX70, CD150R, CD70BR, CD70R, DMG102, DMG102-0P141, DMG82, DMG82-0P141, FD150, FD150LT, FD70, FD70LT, GS120, GS120BN, GS120NN, GS130, GS130NN, GS140, GS140BB, GS140BN, GS140BN2, GS140BR, GS140CP, GS140NCP, GS140NN, GS140PV, GS140R...(Other models you can see in the webshop)		
accessories for	418892		
	GEV No.	511472	Ref. No. —
	nut thread 3/8" H 4mm brass WS 21 Qty 1 pcs		
	GEV No.	518393	Ref. No. —
	flat gasket FIBER ED ø 24mm ID ø 17mm thickness 2mm Qty 1 pcs		

fans

axial fans

import



1

GEV No.	601604 ¹	Ref. No.	32M7130
description	axial fan L 119mm W 119mm H 38mm 230VAC 50/60Hz 17/15W bearing slide bearing manuf. no. AA1282HS-AT connection cable 300mm fan wheel ø 110mm temp.-resist. 70°C input current 0.1A airflow 130m ³ /h 2600rpm		
For models:	S900, S900P		

¹with slide bearings

refrigeration fans

refrigeration motors universal

ELCO

N series - multi fit



1

GEV No.	601427	Ref. No.	32M4041 32M6870
description	fan motor ELCO 10W 230V 50/60Hz bearing slide bearing L1 49mm L2 59mm L3 86.5mm W 83mm connection cable 500mm 1300/1550rpm 5 mounting options VNT10-20/028		
For models:	AM03LT7, AM03LT7A, AM03LT7M, AM1LW, AM2LW, AM2SW, AM3SW, AM4SW, AS120, AS120B, AS120BN, AS120NN, AS140, AS140B, AS140BN, AS140NN, AS150, AS150B, AS55, AS55B, AS65, AS65B, AS70, AS70B, AT1L, AT1L7, AT1L7A, AT1L7M, AX120, AX120B, AX120NN, AX130, AX130B, AX130NN, AX140, AX140B, AX140NN, AX150, AX150B, AX150NN, AX55, AX55B, AX60, AX60B, AX65, AX65B, AX70, AX70B, DR51, DR51A...(Other models you can see in the webshop)		
spare parts for	601427		
	GEV No.	560140	Ref. No. —
	hexagonal nut thread M4 H 4.8mm SS WS 7 Qty 20 pcs DIN/ISO DIN 985 self-locking		
	GEV No.	560332	Ref. No. —
	plain washer ID ø 4.3mm ED ø 9mm thickness 0.8mm SS Qty 1 pcs		
	GEV No.	560340	Ref. No. —
	hexagonal nut thread M4 H 3.2mm WS 7 SS DIN/ISO DIN 934 / ISO 4032/8673 Qty 1 pcs		
	GEV No.	601413	Ref. No. —
	fixing plate suitable for fanwheel ED ø 32mm shaft ø 7 mounting distance 26mm		



1

GEV No.	601430	Ref. No.	32M4351
description	fan motor ELCO 5W 230V 50/60Hz bearing slide bearing L1 48mm L2 52mm L3 79.5mm W 83mm connection cable 500mm 1300/1550rpm 5 mounting options VNT5-13/027		
For models:	E125, E125-4, E125B, E125B-4, E125BE, E125BPL, E125BPPL, E125BX, E125BX-4, E125BXE, E125E, E125PL, E125PLE, E125PV, E125PVX, E125SP, E125X, E125X-4, E125XE, E125XSP, E60, E60-2, E60B, E60B-2, E60BE, E60BPL, E60BPPL, E60BX, E60BX-2, E60BXE, E60E, E60PL, E60PLE, E60PV, E60PVX, E60SP, E60X, E60X-2, E60XE, E60XSP, F40CP, F40CP-0P141, F40CPX, F40CPX-0P141, KAL1633, KAL1633V, KAL1637, KAL1637V, KAL2033, KAL2033V...(Other models you can see in the webshop)		
spare parts for	601430		
	GEV No.	560140	Ref. No. —
	hexagonal nut thread M4 H 4.8mm SS WS 7 Qty 20 pcs DIN/ISO DIN 985 self-locking		
	GEV No.	560332	Ref. No. —
	plain washer ID ø 4.3mm ED ø 9mm thickness 0.8mm SS Qty 1 pcs		
	GEV No.	560340	Ref. No. —
	hexagonal nut thread M4 H 3.2mm WS 7 SS DIN/ISO DIN 934 / ISO 4032/8673 Qty 1 pcs		
	GEV No.	601413	Ref. No. —
	fixing plate suitable for fanwheel ED ø 32mm shaft ø 7 mounting distance 26mm		

N series - standard



1

GEV No.	601708 ¹	Ref. No.	32M7020
description	fan motor ELCO 10W 230V 50/60Hz bearing slide bearing L3 82.5mm W 66mm connection Plug In cable lengthmm 1300/1550rpm VN10-20/1124		
For models:	AM03LT7, AM03LT7A, AS120, AS120B, AS120BN, AS120NN, AS140, AS140B, AS140BN, AS140NN, AS55, AS55B, AS65, AS65B, AT1L7, AT1L7A, AT1L7M, AX120, AX120B, AX120BN, AX120NN, AX140, AX140B, AX140BN, AX140NN, AX55, AX55B, AX65, AX65B, CD130, CD130B, CD130BN, CD130NN, CD150, CD150B, CD150BB, CD150BN, CD150BR, CD150CP, CD150NN, CD150PV, CD150R, CD60, CD60B, CD70, CD702, CD70B, CD70B2, CD70BPV, CD70BR...(Other models you can see in the webshop)		
spare parts for	601708		
	GEV No.	601413	Ref. No. —
	fixing plate suitable for fanwheel ED ø 32mm shaft ø 7 mounting distance 26mm		

¹with coded connector
Table continues overleaf







accessories for	601708		
	GEV No.	601892	Ref. No. —
	connector cable ELCO cable length 1500mm 0.75mm ² protection IP42 for Plug-In		



RE series			
			
1			
GEV No.	602051	Ref. No.	32M7240
description	fan motor 18/62W 230V 50/60Hz 2600rpm		
For models:	IM51H, KAGL6B, KDMS51A, KFSD2B-0P141, KFSD2B2-0P141, KFSDR2B-0P141, KFSDR2B2-0P141, KFSE2B-0P141, KFSE2B2-0P141, KFSER2B-0P141, KFSER2B2-0P141		

BT series - capacitor motors			
			
1			
GEV No.	601820 ¹	Ref. No.	32M4701
description	fan motor 35W 230V 50/60Hz L2 89mm L3 110mm W 82mm cable length 2150mm 1300/1550rpm ELCO incl. capacitor capacitor 2.5µF		
For models:	AF2L, AF2S, AM1L, AM1L7, AM1L7A, AM1L7M, AM1LM, AM1LT, AM1LT7, AM1LT7A, AM1LT7M, AM2L, AM2S, DM101L, DMS1, DMS51A, DMS51C, DMS51M, DMG101L, DMG102, DMG102-0P141, DMG51C, DMG51M, DMG82, DMS101L, DMS101S, DMS51, DMS51A, DMS51C, DMS51M, GR135BT, GR1A, GR2A, IM101L, IM101RAT, IM101S, IM101SC, IM51, IM51A, IM51C, IM51M, IMFEB, IMFEB-0P141, IMFEG, IMFEN, IMFEN-0P141, IMS101L, IMS101S, IMS51, IMS51A...(Other models you can see in the webshop)		

¹incl. capacitor

IMPORT			
multi fit fan motors			
			
			
1			
GEV No.	601022	Ref. No.	32M0220 32M1060 32M4371
description	fan motor 10W 230V 50-60Hz L1 44mm L2 54mm L3 85mm W 84mm cable length 500mm 1300rpm YZF10-20-18/26 5 mounting options bearing slide bearing		

			
			
1			
GEV No.	601023	Ref. No.	32M0220 32M1060 32M4371
description	fan motor 16W 230V 50-60Hz L1 45mm L2 61mm L3 92mm W 84mm cable length 500mm 1300rpm YZF16-25-18/26 5 mounting options bearing slide bearing		

			
			
1			
GEV No.	601020	Ref. No.	32M4350
description	fan motor 5W 230V 50-60Hz L1 44mm L2 48mm L3 79mm W 84mm cable length 500mm 1300rpm YZF5-13-18/26 5 mounting options bearing slide bearing		

accessories

fan wheels

aluminium

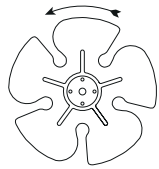
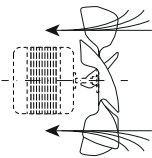
			
			
			
1			
GEV No.	601070	Ref. No.	32M3280
description	fan wheel sucking ø 200mm fan wheel mounting 25.4mm blade angle 28° W 38mm aluminium		
For models:	AS70, AX130NN, AX150NN, AX60, AX70, CD130, CD130B, CD130BN, CD130NN, CD150, CD150B, CD150BB, CD150BN, CD150BR, CD150CP, CD150NN, CD150PV, CD150R, CD60, CD60B, CD70, CD702, CD70B, CD70B2, CD70BPV, CD70BR, CD70CP, CD70PV, CD70PV5X, CD70R, CDPT, CDRI, E125, E125-4, E125B, E125B-4, E125BE, E125BPL, E125B-PL, E125BX, E125BX-4, E125BXE, E125E, E125PL, E125PLE, E125PV, E125PVX, E125SP, E125X, E125X-4...(Other models you can see in the webshop)		



1

GEV No.	601282	Ref. No.	32M1550
description	fan wheel sucking ø 200mm fan wheel mounting 25.4mm blade angle 34° W 44mm aluminium		
For models:	AS120, AS120B, AS120BN, AS120NN, AS140, AS140B, AS140BN, AS140NN, AS150, AS150B, AS55, AS55B, AS65, AS65B, AS70, AS70B, AT1L, AT1L7, AT1L7A, AT1L7M, AX120, AX120B, AX120BN, AX120NN, AX130, AX130B, AX130NN, AX140, AX140B, AX140BN, AX140NN, AX150, AX150B, AX150NN, AX55, AX55B, AX60, AX60B, AX65, AX65B, AX70, AX70B, DM51ME, DMG51ME, DMG51ME-OP141, DR51, DR51A, DR51M, E1200, E1200A...(Other models you can see in the webshop)		

1

GEV No.	601387	Ref. No.	32M2260
description	fan wheel sucking ø 254mm fan wheel mounting 25.4mm blade angle 34° W 50mm aluminium		
For models:	AM1L, AM1LT, AS120B, AS140B, AX120B, AX140B, CD130B, CD150B, CDG150B, E125B, E125B-4, E125BPL, E125BX, E125BX-4, EKP, EKP218, EKP21C, EKPV, EKV, EKV218, EKV21C, EKV, FD140B, FD150B, GS120B, GS130B, GS140B, GS140BPV, GS150B, HD130B, HD150B, IMFEB, IMFEB-OP141, IMFEG, IMFEN, IMFEN-OP141, IMSFEB, IMSFEN, KAF2B, KAF2B-OP141, KAFRI, KD12Q1M, KD12Q2, KD12Q2M, KFG2B, KFSD2B, KFSD2B2, KFSE2B, KFSE2B2, ME150B...(Other models you can see in the webshop)		

1

GEV No.	601072	Ref. No.	32M1080
description	fan wheel sucking ø 250mm fan wheel mounting 25.4mm blade angle 25° W 50mm aluminium		
For models:	AS120, AS120B, AS120BN, AS120NN, AS140, AS140B, AS140BN, AS140NN, AS150, AS150B, AS55, AS65, AX120, AX120B, AX120BN, AX120NN, AX130, AX130B, AX140, AX140B, AX140BN, AX140NN, AX150, AX150B, AX55, AX65, CDG150, E1200B, E1200B4, E1200BE, E125BE, E125BPLE, E125BXE, E60B, E60B-2, E60BPL, E60BX, E60BX-2, F120, F120B, F120NN, F120PL, F120PV, F120SP, FD140, FD140PV, FD65B, FD70, FD70LT, GR65BT...(Other models you can see in the webshop)		

cooling motors (various)

accessories for cooling fan

1

GEV No.	601514	Ref. No.	36C4790
description	guard H 30mm mounting distance 225mm W 240mm evaporator fan		
For models:	AS120, AS120B, AS120BN, AS120NN, AS140, AS140B, AS140BN, AS140NN, AS150, AS150B, AS55, AS55B, AS65, AS65B, AS70, AS70B, AX120, AX120B, AX120BN, AX120NN, AX130, AX130B, AX130NN, AX140, AX140B, AX140BN, AX140NN, AX150, AX150B, AX150NN, AX55, AX55B, AX60, AX60B, AX65, AX65B, AX70, AX70B, E1200, E1200A, E1200B, E1200B4, E1200BE, E1200E, E1200E, E1200PV, E600, E6002, E600B, E600B2, E600BE...(Other models you can see in the webshop)		



cold air circulating fans (complete)

ebm-papst

A2E series

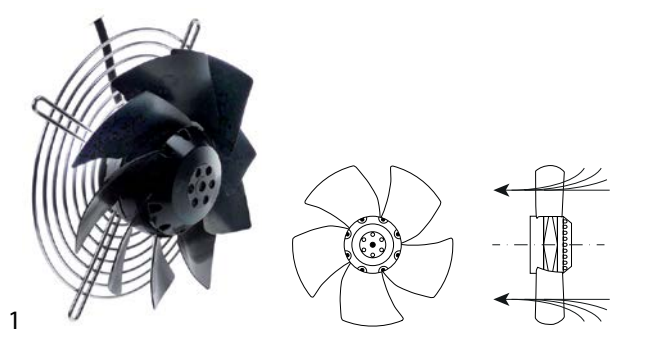

GEV No.	601663 ¹	Ref. No.	32M6610
description	fan A2E200-AI38-10 fan wheel ø 200mm blades 9 230V 50/60Hz 64W 2600rpm cable length 450mm ebm-papst sucking suitable capacitor 1.5µF with protective grid		
For models:	AF2L, AF2S, AF3S, AM03LT7, AM03LT7A, AM03LT7M, AT1L, AT1L7, AT-1L7A, AT1L7M, DM31, DM31A, DM31C, DM31M, DR51, DR51A, DR51M		
spare parts for	601663		
	GEV No.	365171	Ref. No. —
	capacitor capacity 1.5µF 400V tolerance 5% 50/60Hz ambient temperature max. -40 up to +85°C ø 25mm L 50mm M8 plastic connection cable 250mm MLR25PRL		
	GEV No.	601958	Ref. No. —
	guard ø 210mm for fan hole distance 258mm		

¹incl. capacitor and guard

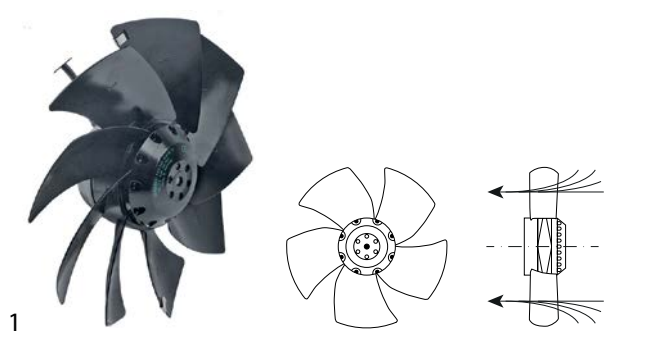

GEV No.	601964	Ref. No.	32M4720 32M6850
description	fan A2E250AM06-12 fan wheel ø 250mm blades 9 230V 50/60Hz 115/150W ø 250mm 2450rpm cable length 1400mm sucking suitable capacitor 3µF		
For models:	AF1L, AF1L7, AF1L7A, AF1L7M, AM1LM, AM1LT, AM1LT7, AM1LT7A, AM1LT7M, DM101L, DM51, DM51A, DM51C, DM51M, DM51ME, DMG101L, DMG102, DMG102-0P141, DMG51C, DMG51M, DMG51ME, DMG51ME-0P141, DMG82, DMG82-0P141, DMS101L, DMS101S, DMS51, DMS51A, DMS51C, DMS51M, DMS72S, IM101L, IM101LR, IM-101LW, IM101RAT, IM101S, IM101SR, IM51, IM51A, IM51AR, IM51C, IM51CR, IM51H, IM51M, IM51MR, IM51R, IM51WC, IM72S, IM72SR...(Other models you can see in the webshop)		
spare parts for	601964		
	GEV No.	365137	Ref. No. —
	capacitor capacity 3µF 450V tolerance 5% 50/60Hz ambient temperature max. -25 to +85°C ø 25mm L 56mm M8 plastic connection cable 250mm 416.17.77GF protection		

miscellaneous



GEV No.	601810	Ref. No.	32M6220
description	fan 230V 50Hz ø 278mm suitable capacitor 4µF ECOFIT type 2VRE35 H 90mm fan wheel ø 250mm cable length 2000mm		
For models:	AM1L, AM1L7, AM1L7A, AM1L7M, AM1LR, AM1LW, AM2L, AM2LR, AM2LW, AM2S, AM2SR, AM2SW, AM3S, AM3SR, AM3SW		

cross flow fans

COPREL

with standard coil



GEV No.	601032	Ref. No.	32M0521 32M2090
description	cross flow fan COPREL TFL(FN) roller ø 60mm roller length 180mm laminated core thickness 15mm motor position left 230V/50Hz 19W bearing rubber connection male faston 6.3mm coil type airflow 107m³/h -10 up to +60°C refrigeration		



GEV No.	601452	Ref. No.	32M0521 32M5920
description	cross flow fan TFL 180 roller ø 60mm roller length 180mm laminated core thickness 20mm motor position left 230V/50Hz 19W universal bearing silicone connection male faston 6.3mm airflow 100m³/h -30 up to +100°C 230V 50Hz		
For models:	EKP, EKP218, EKP21C, EKPV, EKV, EKV218, EKV21C, EKVV, EM1B, EM1B-2, EM1B-2A, EM1B-2X, EM1B-4, EM1B-4A, EM1B-4X, EM1B-A, EM1B-X, EXM1B, EXM1B-2, EXM1B-2A, EXM1B-2X, EXM1B-4, EXM1B-4A, EXM1B-4X, EXM1B-A, EXM1B-X, F120, F120NN, F120PL, F120PV, F120SP, F40, F40-0P141, F40PLA, F40PLPV, F40PV, F40PV-0P141, F40X, F40X-0P141, F55, F55PL, F55PV, F55SP, K100, K100SL, K100SLV, K100X, K100XA, K200PS, KBPZ16...(Other models you can see in the webshop)		



double fans



1			
GEV No.	601026	Ref. No.	32M1220 32M2210
description	cross flow fan COPREL TFD(FD) roller ø 60mm roller length 2x180mm laminated core thickness 35mm motor position centre 230V/50-60Hz 42W refrigeration bearing rubber connection male faston 6.3mm coil type airflow 255m³/h -10 up to +60°C		

hot air fans

miscellaneous

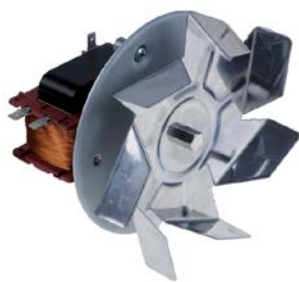

1			
GEV No.	601011	Ref. No.	32M5690
description	hot air fan 220-240V 40W 50/60Hz L1 65mm L2 15mm L3 25mm L4 87mm fan wheel ø 150mm FIME type C25R8023CLH		
For models:	ECB, ECB218, ECN, ECN218, KA12A1E, KA12B1E, KA12B2E, KA12M1E, KA14A1E, KA14B1E, KA14B2E, KA14M1E, KA16A1E, KA16B1E, KA16B2E, KA16M1E, KA18A1E, KA18B1E, KA18B2E, KA18M1E, KA20A1E, KA20B1E, KA20B2E, KA20M1E, KAJ12AE, KAJ12ME, KAJ14AE, KAJ14ME, KAJ16AE, KAJ16ME, KAJ18AE, KAJ18ME, KAJ20AE, KAJ20ME, QL14CPN, QL14CVB, QL21CPN, QL21CVB		

accessories for	601011		
	GEV No.	550879	Ref. No. —
	insulation ø 130mm thickness 3mm hole ø 20mm for hot air fan		
	GEV No.	601260	Ref. No. —
	nut thread M6L IT for hot air fan		

accessories

fan wheels for hot air fans



1			
GEV No.	601710	Ref. No.	32M2510
description	fan wheel ø 225mm shaft intake ø 7mm aluminium blades 5		
For models:	AM03LT7, AM03LT7A, AM03LT7M, AS120BN, AS120NN, AS140BN, AS140NN, AS55, AS55B, AS65, AS65B, AS70B, AX120NN, AX140NN, AX55, AX55B, AX60B, AX65, AX65B, AX70B, CD130BN, CD130NN, CD150BB, CD150BN, CD150CP, CD150NN, CD60, CD60B, CD70, CD702, CD70B, CD70B2, CD70BPV, CD70CP, CD70PV, CD70PVXS, CDG70, CDPT, CDRI, DM31, DM31A, DM31C, DM31M, E1200, E12004, E1200E, E1200PV, E125, E125-4, E125E...(Other models you can see in the webshop)		

condensators & interference suppression filters

starting capacitors

starting capacitors



1			
GEV No.	365095	Ref. No.	32V1490
description	starting capacitor 43µF 330V 50/60Hz duty cycle 3 60A1D-330043NXET ø 36mm L 80mm M8 plastic connection cable 350mm 04P.5523CM		
For models:	E125, E125-4, E125E, E125PL, E125PLE, E125PV, E125PVX, E125SP, E125X, E125X-4, E125XE, E125XSP, E60, E60-2, E60E, E60PL, E60PLE, E60PV, E60PVX, E60SP, E60X, E60X-2, E60XE, E60XSP, EM1A, EM1A-2, EM1A-2A, EM1A-2X, EM1A-A, EM1A-X, EM1B, EM1B-2, EM1B-2A, EM1B-2X, EM1B-4, EM1B-4A, EM1B-4X, EM1B-A, EM1B-X, EM1C, EM1C-2, EM1C-2A, EM1C-2X, EM1C-4, EM1C-4A, EM1C-4X, EM1C-6, EM1C-6A, EM1C-6X, EM1C-A...(Other models you can see in the webshop)		

operating capacitors

plastic



1			
GEV No.	365225	Ref. No.	32V5980
description	operating capacitor capacity 35µF 420V tolerance 5% 50/60Hz ambient temperature max. -25 to +85°C ø 45mm L 95mm M8 plastic connection male faston 6.3mm protection		



electric accessories

terminals and connectors

insulated

plug connectors



1

GEV No.	550326	Ref. No.	32D0080
description	connection terminal 12-pole connection male faston 6.3mm temp.-resist. 140°C		
For models:	SX120BN		

terminals

connection terminals with screw/faston connections



1

GEV No.	550278	Ref. No.	32D0171
description	power terminal block 3-pole max. 40A max 400V connection $\phi 6\text{mm}^2$ / F6.3 temp.-resist. 150°C cross section 6mm^2		



1

GEV No.	550411	Ref. No.	32D0250
description	power terminal block 6-pole max. 40A max 450V connection $\phi 6\text{mm}^2$ / F6.3 temp.-resist. 150°C cross section 6mm^2		
For models:	ECB, ECB218, ENB, ENB218, QE14PC, QE14VB, QE21PC, QE21VB, QI14VB, QI21VB, QL14CVB, QL14NPC, QL14NVB, QL21CVB, QL21NPC, QL21NVB, SVB, SVB218		

ignition parts

electrodes

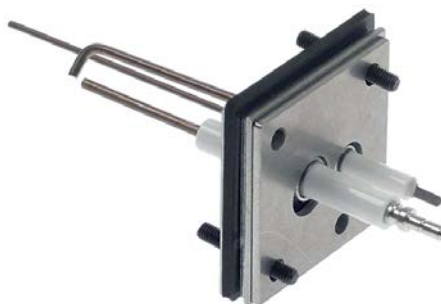

1

GEV No.	104801	Ref. No.	6300567
description	ignition electrode flange length 55mm flange width 55mm D1 ϕ 9mm D2 ϕ 7mm L1 118mm L2 145mm BL1 77mm BL2 65mm		

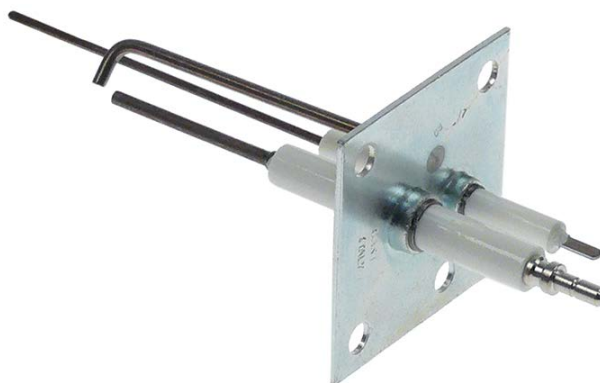

1

GEV No.	104800	Ref. No.	32V4670
description	ignition electrode flange length 55mm flange width 55mm D1 ϕ 9mm D2 ϕ 7mm L1 119mm L2 145mm BL1 60mm BL2 55mm		



1

GEV No.	104799	Ref. No.	6300747
description	ignition electrode flange length 56mm flange width 22mm D1 ϕ 9x62mm D2 ϕ 9x62mm L1 130mm L2 140mm		



ignition cables

pre-assembled cables



GEV No.	103353	Ref. No.	3113510
description	ignition cable cable length 350mm connection F2.8/F6.3		



GEV No.	103352	Ref. No.	3113490
description	ignition cable cable length 550mm connection F2.8mm / F6.3mm		

gas burners

forced air burners



GEV No.	108153	Ref. No.	6300748
description	burner blower combi-steamer 230V 65W hole distance 50mm NRG118/0800-3612-030204		

equipment-specific units

for fridges

miscellaneous



GEV No.	695580	Ref. No.	36D1250
description	frame L 1528mm W 55mm		
For models:	F120, F120B, F120PL, F120PV, F120SP, N135, N135-3, N135-4, N135B, N135BPS, N135PS, N135PV, P135, P135-3, P135-4, P135B, SX120, SX120B, SX120PV, SX135, SX135-3, SX135-3E, SX135-4, SX135-4E, SX135AX, SX135B, SX135B-3, SX135B-4, SX135BAX, SX135BE, SX135BR, SX135CP, SX135E, SX135ES, SX135PV, SX135R		

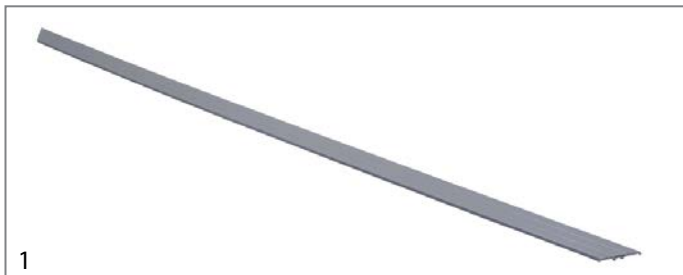

GEV No.	695581	Ref. No.	36D1290
description	frame L 1639mm W 55mm		
For models:	E125, E125-4, E125B, E125B-4, E125BE, E125BPL, E125BPLE, E125BX, E125BX-4, E125BXE, E125E, E125PL, E125PLE, E125PV, E125PVX, E125SP, E125X, E125X-4, E125XE, E125XSP, E60, E60-2, E60B, E60B-2, E60BE, E60BPL, E60BPLE, E60BX, E60BX-2, E60BXE, E60E, E60PL, E60PV, E60PVX, E60SP, E60X, E60X-2, E60XE, E60XSP, F120, F120B, F120NN, F120PL, F120PV, F120SP, F55, F55B, F55PL, F55PV, F55SP...		

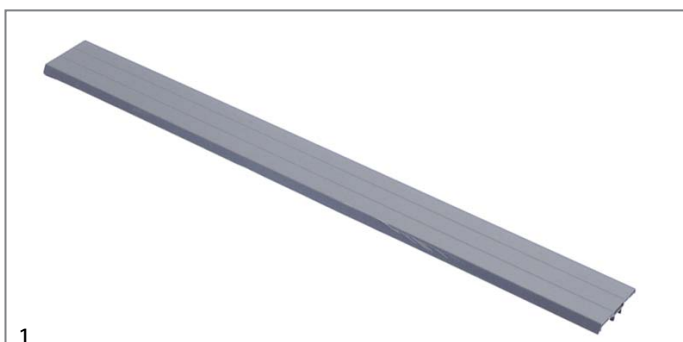

GEV No.	695579	Ref. No.	36D1260
description	frame L 621mm W 55mm		
For models:	E60PLE, N135-3, N135-4, N65-2, N65NB, N65NN, P135-3, P135-4, P135NN-3, P65-2, SX135-3, SX135-3E, SX135-4, SX135-4E, SX135B-3, SX135B-4, SX135BN2, SX135CP, SX65-2, SX65-2E, SX65CPB, SX65CPN, SX65N-3C, SX65NB, SX65NN		

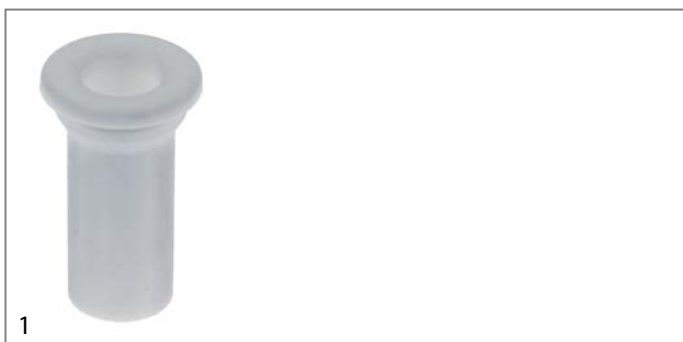

GEV No.	694636	Ref. No.	33Q6300
description	hose ID ø 21mm ED ø 27mm L 66mm ø 40mm thickness 3.5mm		
For models:	KAF2B, KAF2B-0P141, KAF2N, KAF2N-0P141		



GEV No.	690689	Ref. No.	35X3460
description	spacer ring		
For models:	F40EV, F40EVP, F40PLPV, F40PV		

			
1			
GEV No.	690691	Ref. No.	36C2440
description	spacer ring		
For models:	F40EV, F40EVP, F40PLPV, F40PV		

			
1			
GEV No.	698476	Ref. No.	36E3990
description	thermostatic steam trap W 55mm H 45mm for fridge D1 ø 22mm D2 ø 16mm		
For models:	AS120NN, AS140NN, AX120NN, AX130NN, AX140NN, AX150NN, GS120BN, GS120NN, GS130NN, GS140BB, GS140BN, GS140BN2, GS140NN, GS150NN, HD130NN, HD150NN, KBP41P, KBP41X, KBP53G, KBP53V, KBP53X, KBP64G, KBP64V, KBP64X, KBP83G, KBP83V, KBP83X, KBP94G, KBP94V, KBP94X, KBPZ16, KBPZ163A, KBPZ163B, KBPZ163S, KBPZ167A, KBPZ167B, KBPZ167S, KBPZ20, KBPZ203A, KBPZ203B, KBPZ203S, KBPZ207A, KBPZ207B, KBPZ207S, KBPZ25, KBPZ253A, KBPZ253B, KBPZ257A, KBPZ257B, KBS11...(Other models you can see in the webshop)		

for refrigerated counters

lid hinges

			
1			
GEV No.	691099	Ref. No.	35G4630
description	hinge for lid mounting pos. left		
For models:	K100SLV		

spare parts and accessories

			
1			
GEV No.	692916	Ref. No.	36C3100
description	bracket W 37mm H 17mm		

			
1			
GEV No.	691189	Ref. No.	36G8660
description	bush L 9mm ID ø 7mm ext. ø 10		
For models:	AF1L7, AF1L7A, AF1L7M, AM03LT7, AM03LT7A, AM03LT7M, AM1L7, AM1L7A, AM1L7M, AM1LT7, AM1LT7A, AM1LT7M, AT1L7, AT1L7A, AT1L7M, DM31, DM31A, DM31C, DM31M, DM51, DM51A, DM51C, DM51M, DM51ME, DMG51C, DMG51M, DMG51ME, DMS51, DMS51A, DMS51C, DMS51M, DR51, DR51A, DR51M, EM1A, EM1A-2, EM1A-2A, EM1A-2X, EM1A-A, EM1A-X, EM1B, EM1B-2, EM1B-2A, EM1B-2X, EM1B-4, EM1B-4A, EM1B-4X, EM1B-A, EM1B-X, EM1C...(Other models you can see in the webshop)		

for freezer cabinets

glass panels

			
1			
GEV No.	700682	Ref. No.	37W0270
description	glass panel L 190mm W 310mm mounting pos. lateral		
For models:	KAL1433V, KAL1437V, KAL1633V, KAL1637V, KAL2033V, KAL2037V, KAL2533V, KAL2537V, KAR143V, KAR147V, KAR163V, KAR167V, KAR203V, KAR207V, KAR253V, KAR257V, KBP53V, KBP64V, KBP83V, KBP94V, KBPZ163A, KBPZ163B, KBPZ163S, KBPZ167A, KBPZ167B, KBPZ167S, KBPZ203A, KBPZ203B, KBPZ203S, KBPZ207A, KBPZ207B, KBPZ207S, KBPZ253A, KBPZ253B, KBPZ257A, KBPZ257B, KPE1633V, KPE2033V, KPM1633V, KPM2033V, KPZ1633A, KPZ1633B, KPZ1637A, KPZ1637B, KPZ2033A, KPZ2033B, KPZ2037A, KPZ2037B, KPZ2533A, KPZ2533B...(Other models you can see in the webshop)		



for ice-cube maker

hoses

miscellaneous



1

GEV No.	694636	Ref. No.	33Q6300
description	hose ID ø 21mm ED ø 27mm L 66mm ø 40mm thickness 3.5mm		
For models:	KAF2B, KAF2B-0P141, KAF2N, KAF2N-0P141		

for convection ovens/combi-steamers

spare parts and accessories



1

GEV No.	108153	Ref. No.	6300748
description	burner blower combi-steamer 230V 65W hole distance 50mm NRG118/0800-3612-030204		

for dishwashers

washing and rinsing systems



1

GEV No.	524877	Ref. No.	36D0740
description	bush for rinse arm ø 20mm ID ø 16mm H 8mm ED ø 26mm		

handles and hand wheels

handle bars

consoles



1

GEV No.	691135	Ref. No.	36M2910
description	console for door handle		

bracket handles



1

GEV No.	690451	Ref. No.	36M4040
description	pull handle L 426mm H 40mm mounting distance 376mm black		
For models:	F40EVP, F40PLPV, F40PV		

miscellaneous



1

GEV No.	691193	Ref. No.	36M4640
description	handle thread M5		
For models:	QE14PRV, QE14VRV, QI14PRV, QI14VRV, QL14RPRV, QL14RVRV		

locks

locking devices

producer-specific

SAGI



1

GEV No.	690662	Ref. No.	36M0140
description	key cylinder with slide latch ø 23mm thread M19x1 cam width 11mm mounting measurements 16.5x19mm hub 20-28mm thread L 15mm		
For models:	E125, E125-4, E125B, E125B-4, E125BE, E125BPL, E125BPLE, E125BX, E125BX-4, E125BXE, E125E, E125PL, E125PLE, E125PV, E125PVX, E125SP, E125X, E125X-4, E125XE, E125XSP, E60, E60-2, E60B, E60B-2, E60BE, E60BPL, E60BPLE, E60BX, E60BX-2, E60BXE, E60E, E60PL, E60PLE, E60PV, E60PVX, E60SP, E60X, E60X-2, E60XE, E60XSP, F40B, F40CP, F40CPX, F40EV, F40EVP, N135, N135-3, N135-4, N135B, N135BN...(Other models you can see in the webshop)		

edgmount latches

handle latches

CAFF/FERMOD

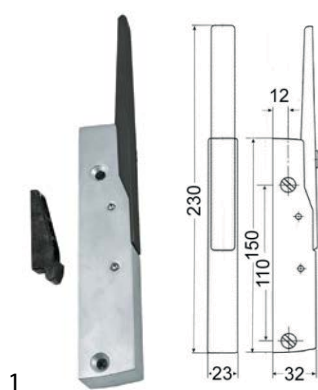

GEV No.	690454	Ref. No.	36M0470
description	handle latch L 150mm mounting distance 110mm matt chrome-plated/Rilsan non lockable heated units 560 black complete with door catch		
spare parts for	690454		
	GEV No.	690429	Ref. No. —
	door catch CT 25.5mm		
accessories for	690454		
	GEV No.	690428	Ref. No. 36M0480
	door catch H 51mm W 13.9mm mounting distance 30mm plastic CT 16.5mm		
	GEV No.	690445	Ref. No. —
	base plate H 2mm		
	GEV No.	690446	Ref. No. —
	base plate H 5mm L 56mm W 18mm		

door catches



GEV No.	690428	Ref. No.	36M0480
description	door catch H 51mm W 13.9mm mounting distance 30mm plastic CT 16.5mm		

hinges

spring assisted hinges

universal

CAFF/FERMOD

group 2

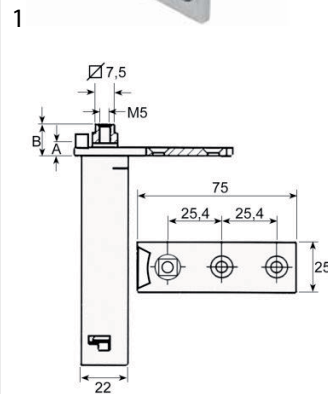

GEV No.	690574	Ref. No.	36M2460
description	spring assisted hinge series 176 mounting pos. left/right L 75mm W 25.6mm A 11mm B 15mm mounting measurements 22x22mm intake 7.5x7.5		

INTERKLIMAT

hinges



1

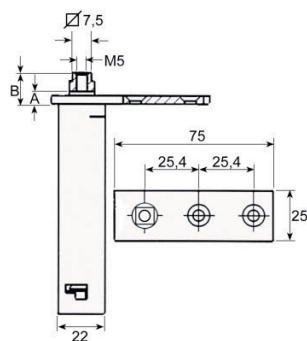

GEV No.	690622	Ref. No.	36G6520
description	spring assisted hinge series 28L mounting pos. left/right L 75mm W 25mm H 103mm A 13mm B 18mm mounting measurements 22x22mm intake 7.5x7.5 refrigeration units		
For models:	AF1L, AF2L, AF2S, AF3S, AM1L, AM1LM, AM1LR, AM1LT, AM1LW, AM2L, AM2LR, AM2LW, AM2S, AM2SR, AM2SW, AM3S, AM3SR, AM3SW, AM4S, AM4SR, AM4SW, AS120, AS120B, AS120BN, AS120NN, AS140, AS140B, AS140BN, AS140NN, AS55, AS55B, AS65, AS65B, AT1L, AX120, AX120B, AX120BN, AX120NN, AX140, AX140B, AX140BN, AX140NN, AX55, AX55B, AX65, AX65B, CD130, CD130B, CD130BN, CD130NN...(Other models you can see in the webshop)		

accessories



1

GEV No.	690747	Ref. No.	3178300
description	bush for hinge ID ϕ 7.5mm L 25.5mm W 25.5mm white mounting measurements 22x22mm H 4.5mm		
For models:	AF1L, AF2L, AF2S, AF3S, AM1L, AM1LM, AM1LR, AM1LT, AM1LW, AM2L, AM2LR, AM2LW, AM2S, AM2SR, AM2SW, AM3S, AM3SR, AM3SW, AM4S, AM4SR, AM4SW, AS120, AS120B, AS120BN, AS120NN, AS140, AS140B, AS140BN, AS140NN, AS150, AS150B, AS55, AS55B, AS65, AS65B, AS70, AS70B, AT1L, AX120, AX120B, AX120BN, AX120NN, AX130, AX130B, AX130NN, AX140, AX140B, AX140BN, AX140NN, AX150...(Other models you can see in the webshop)		

producer-specific

ELECTROLUX/ZANUSSI



1

GEV No.	690747	Ref. No.	3178300
description	bush for hinge ID ϕ 7.5mm L 25.5mm W 25.5mm white mounting measurements 22x22mm H 4.5mm		
For models:	AF1L, AF2L, AF2S, AF3S, AM1L, AM1LM, AM1LR, AM1LT, AM1LW, AM2L, AM2LR, AM2LW, AM2S, AM2SR, AM2SW, AM3S, AM3SR, AM3SW, AM4S, AM4SR, AM4SW, AS120, AS120B, AS120BN, AS120NN, AS140, AS140B, AS140BN, AS140NN, AS150, AS150B, AS55, AS55B, AS65, AS65B, AS70, AS70B, AT1L, AX120, AX120B, AX120BN, AX120NN, AX130, AX130B, AX130NN, AX140, AX140B, AX140BN, AX140NN, AX150...(Other models you can see in the webshop)		

SAGI



1

GEV No.	690747	Ref. No.	3178300
description	bush for hinge ID ϕ 7.5mm L 25.5mm W 25.5mm white mounting measurements 22x22mm H 4.5mm		
For models:	AF1L, AF2L, AF2S, AF3S, AM1L, AM1LM, AM1LR, AM1LT, AM1LW, AM2L, AM2LR, AM2LW, AM2S, AM2SR, AM2SW, AM3S, AM3SR, AM3SW, AM4S, AM4SR, AM4SW, AS120, AS120B, AS120BN, AS120NN, AS140, AS140B, AS140BN, AS140NN, AS150, AS150B, AS55, AS55B, AS65, AS65B, AS70, AS70B, AT1L, AX120, AX120B, AX120BN, AX120NN, AX130, AX130B, AX130NN, AX140, AX140B, AX140BN, AX140NN, AX150...(Other models you can see in the webshop)		



1

GEV No.	690675	Ref. No.	6008500
description	spring assisted hinge left		
For models:	N135PV, SX120PV, SX135PV		



1

GEV No.	690573	Ref. No.	30M0350 36M0350
description	spring assisted hinge left refrigerator suitable for SAGI		



GEV No.	690674	Ref. No.	6008490
description	spring assisted hinge right L 128mm spring thickness 2.5mm		
For models:	F55PV, N135PV, N65GT, N65PV, SX120PV, SX135PV, SX55PV, SX65PV		



GEV No.	690572	Ref. No.	36M0340
description	spring assisted hinge right refrigerator suitable for SAGI		

door bearing



GEV No.	690686	Ref. No.	36G2810
description	bush for door hinge		
For models:	AF1L7, AF1L7A, AF1L7M, AM03LT7, AM03LT7A, AM03LT7M, AM1L7, AM1L7A, AM1L7M, AM1LT7, AM1LT7A, AM1LT7M, AT1L7, AT1L7A, AT1L7M, EKP, EKP218, EKP21C, EKPV, EKV, EKV218, EKV21C, EKVV, F40, F40B, F40CP, F40CPX, F40PLA, F40PLE, F40X, K100, K100SL, K100SLV, K100X, K100XA, K160PS, K160PZ, K160SL, K200PS		



GEV No.	690742	Ref. No.	36D4610
description	bush for door hinge		
For models:	EM1A, EM1A-2, EM1A-2A, EM1A-2X, EM1A-A, EM1A-X, EM1B, EM1B-2, EM1B-2A, EM1B-2X, EM1B-4, EM1B-4A, EM1B-4X, EM1B-A, EM1B-X, EM1C, EM1C-2, EM1C-2A, EM1C-2X, EM1C-4, EM1C-4A, EM1C-4X, EM1C-6, EM1C-6A, EM1C-6X, EM1C-A, EM1C-X, EXM1A, EXM1A-2, EXM1A-2A, EXM1A-2X, EXM1A-A, EXM1A-X, EXM1B, EXM1B-2, EXM1B-2A, EXM1B-2X, EXM1B-4, EXM1B-4A, EXM1B-4X, EXM1B-A, EXM1B-X, EXM1C, EXM1C-2, EXM1C-2A, EXM1C-2X, EXM1C-4, EXM1C-4A, EXM1C-4X, EXM1C-6...(Other models you can see in the webshop)		



GEV No.	690743	Ref. No.	36D4700
description	bush for door hinge		
For models:	KM1A, KM1A-11, KM1A-11A, KM1A-11X, KM1A-2, KM1A-2A, KM1A-2X, KM1A-4, KM1A-4A, KM1A-4X, KM1A-A, KM1A-X, KM1B, KM1B-11, KM1B-11A, KM1B-11X, KM1B-2, KM1B-22, KM1B-22A, KM1B-22X, KM1B-2A, KM1B-2X, KM1B-4, KM1B-4A, KM1B-4X, KM1B-6, KM1B-6A, KM1B-6X, KM1B-A, KM1B-X, KM1C, KM1C-11, KM1C-11A, KM1C-11X, KM1C-2, KM1C-2A, KM1C-2X, KM1C-4, KM1C-4A, KM1C-4X, KM1C-6, KM1C-6A, KM1C-6X, KM1C-8, KM1C-8A, KM1C-8X, KM1C-A, KM1C-X, TE1A, TE1A-11...(Other models you can see in the webshop)		



GEV No.	695571	Ref. No.	36M0090
description	bush for door hinge		
For models:	CD150CP, CD702, CD70B2, DMG102, DMG102-0P141, DMG82, DMG82-0P141, E12004, E1200B4, E125-4, E125B-4, E125BX-4, E125X-4, E6002, E600B2, E60-2, E60B-2, E60BX-2, E60X-2, GS140BN2, GS140CP, GS652, GS65BCP, GS65NB, GS65NCP, GS65NN, IMFEB, IMFEB-0P141, IMFEG, IMFEN, IMFEN-0P141, IMSFEB, IMSFEN, KFSD2B2, KFSD2B2-0P141, KFSD2N2, KFSD2N2-0P141, KFSDR2B2-0P141, KFS-DR2N2-0P141, KFSE2B2, KFSE2B2-0P141, KFSE2N2, KFSE2N2-0P141, KFSER2B2, KFSER2B2-0P141, KFSER2N2-0P141, N135-3, N135-4, N65-2, N65NB...(Other models you can see in the webshop)		





GEV No.	690795	Ref. No.	36D9490
description	counterpart for spring hinge		
For models:	AF1L, AF2L, AF2S, AF3S, AM1L, AM1LM, AM1LR, AM1LT, AM1LW, AM2L, AM2LR, AM2LW, AM2S, AM2SR, AM2SW, AM3S, AM3SR, AM3SW, AM4S, AM4SR, AM4SW, AT1L, E125, E125-4, E125B, E125B-4, E125BE, E125BPL, E125BPLE, E125BX, E125BX-4, E125BXE, E125E, E125PL, E125PLE, E125SP, E125X, E125X-4, E125XE, E125XSP, E60, E60-2, E60B, E60B-2, E60BE, E60BPL, E60BPLE, E60BX, E60BX-2, E60BXE...(Other models you can see in the webshop)		





GEV No.	690489	Ref. No.	30T5910
description	hinge L 138mm mounting pos. upper/lower		
For models:	E125-4, E125B-4, E125BX-4, E125X-4, E60-2, E60B-2, E60BX-2, E60X-2, N135-3, N135-4, N65-2, N65NB, N65NN, P135-3, P135-4, P135NN-3, P65-2, SX135-3, SX135-3E, SX135-4, SX135-4E, SX135B-3, SX135B-4, SX135BN2, SX135CP, SX65-2, SX65-2E, SX65B-2, SX65CPB, SX65CPN, SX65NB, SX65NN		



			
1			
GEV No.	690793	Ref. No.	30T4780
description	hinge mounting pos. bottom right		
For models:	E125PV, E125PVX, E60PV, E60PVX, F55PV, N135PV, N65GT, N65PV, SX120PV, SX135PV, SX55PV, SX65PV		

			
1			
GEV No.	690794	Ref. No.	30T4800
description	hinge mounting pos. upper left		
For models:	E125PV, E125PVX, N135PV, SX120PV, SX135PV		

			
1			
GEV No.	690788	Ref. No.	36M2610
description	hinge mounting pos. centre with bolt		

			
1			
GEV No.	690790	Ref. No.	30T1080
description	hinge mounting pos. upper right		

			
1			
GEV No.	700740	Ref. No.	3043190 3088700
description	hinge mounting pos. lower		
For models:	KBF16, KBF16A, KBF16M, KBF21, KBF21A, KBF21M, KBP41P, KBP41X, KBP53G, KBP53V, KBP53X, KBP64G, KBP64V, KBP64X, KBP83G, KBP83V, KBP83X, KBP94G, KBP94V, KBP94X, KBPZ16, KBPZ163A, KBPZ163B, KBPZ163S, KBPZ167A, KBPZ167B, KBPZ167S, KBPZ20, KBPZ203A, KBPZ203B, KBPZ203S, KBPZ207A, KBPZ207B, KBPZ207S, KBPZ25, KBPZ253A, KBPZ253B, KBPZ257A, KBPZ257B, KBS11, KBS11A, KBS11M, KBS16, KBS16A, KBS16M, KBS21, KBS21A, KBS21M, KBSR11, KBSR11A... (Other models you can see in the webshop)		

			
1			
GEV No.	690746	Ref. No.	30T5900
description	hinge bearing mounting pos. centre with bolt		
For models:	E125-4, E125B-4, E125BX-4, E125X-4, E60-2, E60B-2, E60BX-2, E60X-2, N135-3, N135-4, N65-2, N65NB, N65NN, P135-3, P135-4, P135NN-3, P65-2, SX135-3, SX135-3E, SX135-4, SX135-4E, SX135B-3, SX135B-4, SX135BN2, SX135CP, SX65-2, SX65-2E, SX65B-2, SX65CPB, SX65CPN, SX65NB, SX65NN		

			
1			
GEV No.	700741	Ref. No.	3043180
description	hinge mounting pos. upper		
For models:	KBF16, KBF16A, KBF16M, KBF21, KBF21A, KBF21M, KBP41P, KBP41X, KBP53G, KBP53V, KBP53X, KBP64G, KBP64V, KBP64X, KBP83G, KBP83V, KBP83X, KBP94G, KBP94V, KBP94X, KBPZ16, KBPZ163A, KBPZ163B, KBPZ163S, KBPZ167A, KBPZ167B, KBPZ167S, KBPZ20, KBPZ203A, KBPZ203B, KBPZ203S, KBPZ207A, KBPZ207B, KBPZ207S, KBPZ25, KBPZ253A, KBPZ253B, KBPZ257A, KBPZ257B, KBS11, KBS11A, KBS11M, KBS16, KBS16A, KBS16M, KBS21, KBS21A, KBS21M, KBSR11, KBSR11A... (Other models you can see in the webshop)		

			
1			
GEV No.	690741	Ref. No.	30T6230
description	hinge bearing mounting pos. lower with bolt		
For models:	KM1A, KM1A-11, KM1A-11A, KM1A-11X, KM1A-2, KM1A-2A, KM1A-2X, KM1A-4, KM1A-4A, KM1A-4X, KM1A-A, KM1A-X, KM1B, KM1B-11, KM1B-11A, KM1B-11X, KM1B-2, KM1B-22, KM1B-22A, KM1B-22X, KM1B-2A, KM1B-2X, KM1B-4, KM1B-4A, KM1B-4X, KM1B-6, KM1B-6A, KM1B-6X, KM1B-A, KM1B-X, KM1C, KM1C-11, KM1C-11A, KM1C-11X, KM1C-2, KM1C-2A, KM1C-2X, KM1C-4, KM1C-4A, KM1C-4X, KM1C-6, KM1C-6A, KM1C-6X, KM1C-8, KM1C-8A, KM1C-8X, KM1C-A, KM1C-X, TE1A, TE1A-11... (Other models you can see in the webshop)		

			
1			
GEV No.	690787	Ref. No.	30T1980
description	hinge mounting pos. upper left		

			
1			
GEV No.	690755	Ref. No.	30T1950
description	hinge bearing mounting pos. lower with bolt		



GEV No.	690749	Ref. No.	36M2740
description	hinge bearing mounting pos. lower without bolt		
For models:	K160GPZ, K160PS, K160PZ, K160SL, K160XPZ, K200PS		



GEV No.	690672	Ref. No.	30T5970
description	hinge bearing mounting pos. upper left with bolt		
For models:	E125PV, E125PVX, N135PV, SX120PV, SX135PV		



GEV No.	690792	Ref. No.	30T4810
description	hinge bearing mounting pos. upper left with bolt		



GEV No.	690671	Ref. No.	30T5800
description	hinge bearing mounting pos. upper right with bolt		
For models:	E125PV, E125PVX, E60PV, E60PVX, F55PV, N135PV, N65GT, N65PV, SX120PV, SX135PV, SX55PV, SX65PV		



GEV No.	690748	Ref. No.	36M2730
description	hinge bearing mounting pos. upper right with bolt		
For models:	K160GPZ, K160PS, K160PZ, K160SL, K160XPZ, K200PS		



GEV No.	690740	Ref. No.	30T6220
description	hinge bearing mounting pos. upper with bolt		
For models:	KM1A, KM1A-11, KM1A-11A, KM1A-11X, KM1A-2, KM1A-2A, KM1A-2X, KM1A-4, KM1A-4A, KM1A-4X, KM1A-A, KM1A-X, KM1B, KM1B-11, KM1B-11A, KM1B-11X, KM1B-2, KM1B-22, KM1B-22A, KM1B-22X, KM1B-2A, KM1B-2X, KM1B-4, KM1B-4A, KM1B-4X, KM1B-6, KM1B-6A, KM1B-6X, KM1B-A, KM1B-X, KM1C, KM1C-11, KM1C-11A, KM1C-11X, KM1C-2, KM1C-2A, KM1C-2X, KM1C-4, KM1C-4A, KM1C-4X, KM1C-6, KM1C-6A, KM1C-6X, KM1C-8, KM1C-8A, KM1C-8X, KM1C-A, KM1C-X, TE1A, TE1A-11...(Other models you can see in the webshop)		



GEV No.	690684	Ref. No.	35V7760
description	hinge bearing mounting pos. upper without bolt		
For models:	F40, F40B, F40CP, F40CPX, F40PLA, F40PLE, F40X		



GEV No.	690688	Ref. No.	35V8800
description	hinge bearing mounting pos. upper without bolt		
For models:	F40EV, F40EVP, F40PLPV, F40PV		



GEV No.	690571	Ref. No.	30T5810
description	hinge bearing with bolt suitable for SAGI		
For models:	E125, E125B, E125BE, E125BPL, E125BPLE, E125BX, E125BXE, E125E, E125PL, E125PLE, E125SP, E125X, E125XE, E125XSP, E60, E60B, E60BE, E60BPL, E60BPLE, E60BX, E60BXE, E60E, E60PL, E60PLE, E60SP, E60X, E60XE, E60XSP, F120, F120B, F120NN, F120PL, F120PV, F120SP, F55, F55B, F55PL, F55SP, N135, N135-3, N135B, N135BN, N135BPS, N135NN, N135PS, N65, N65B, N65BPS, N65PS, P135...(Other models you can see in the webshop)		





 <p>1</p>			
GEV No.	690751	Ref. No.	30T2050 30T2051
description	hinge bearing with bolt suitable for SAGI		
For models:	K160GPZ, K160PS, K160PZ, K160SL, K160XPZ, K200PS		

accessories

miscellaneous

 <p>1</p>			
GEV No.	690687	Ref. No.	36D2880
description	plain washer		
For models:	F40, F40B, F40CP, F40CPX, F40PLA, F40PLE, F40X, K100, K100SL, K100SLV, K100X, K100XA		

 <p>1</p>			
GEV No.	690689	Ref. No.	35X3460
description	spacer ring		
For models:	F40EV, F40EVP, F40PLPV, F40PV		

 <p>1</p>			
GEV No.	690691	Ref. No.	36C2440
description	spacer ring		
For models:	F40EV, F40EVP, F40PLPV, F40PV		

pullouts
drawer slides

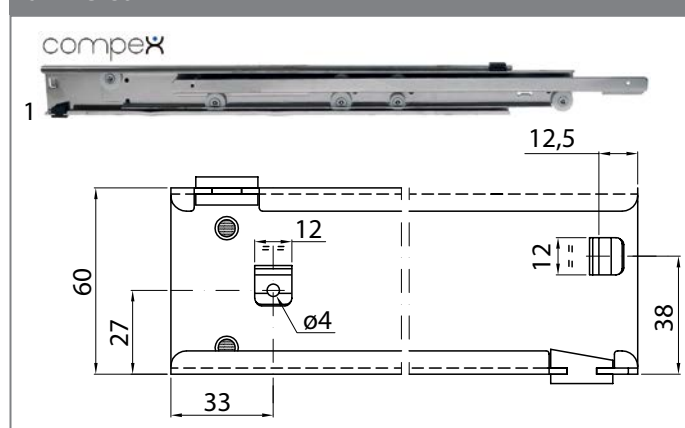

universal



GEV No.	696714 ¹	Ref. No.	36M8080 36M8090
description	drawer slide L 550mm pull-out length 610mm total length 1160mm Qty 1 pair capacity 50kg W 16mm H 60mm SS telescopic		
For models:	CD150CP, CD70CP, KBSR11, KBSR11A, KBSR11M, KBSR16, KBSR16A, KBSR16M, KIA11, KIA11A, KIA11M, KIA13, KIA13A, KIA13M, KIA2, KIA2A, KIA2M, KIB11, KIB11A, KIB11M, KIB13, KIB13A, KIB13M, KIB2, KIB22, KIB22A, KIB22M, KIB2A, KIB2M, KIB4, KIB4A, KIB4M, KIC11, KIC11A, KIC11M, KIC13, KIC13A, KIC13M, KIC2, KIC22, KIC22A, KIC22M, KIC2A, KIC2M, KIC4, KIC4A, KIC4AM, KIRA, KIRA-0P141, KIRA2...(Other models you can see in the webshop)		
spare parts for	696714		
	GEV No.	690750	Ref. No. —
	stop for telescopic rail L 20mm plastic H 12mm D 9mm		

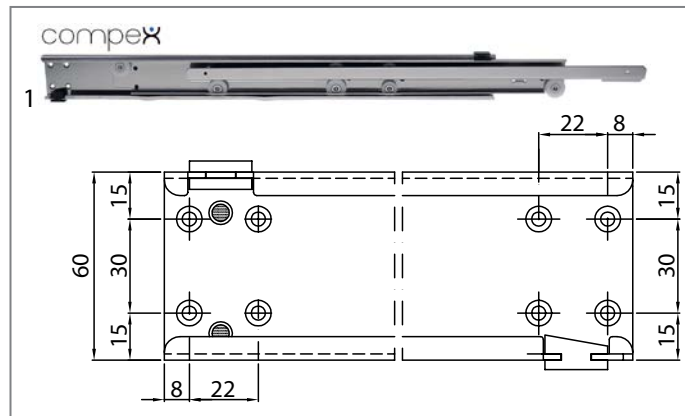

¹multiple slide (60mm more than nominal length)

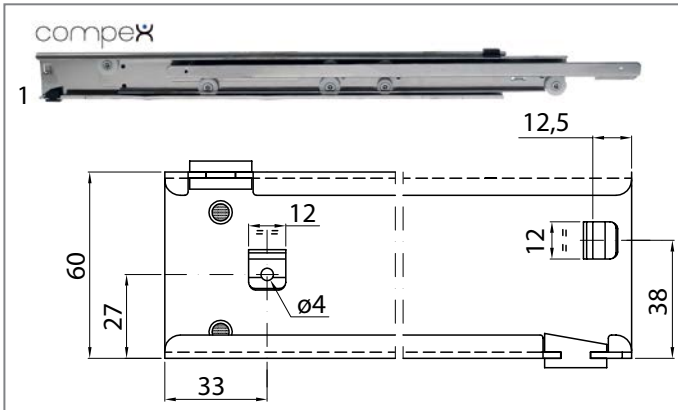

GEV No.	690752 ¹	Ref. No.	36M2700 36M2710 36M4920 36M4940
description	drawer slide L 600mm pull-out length 660mm total length 1260mm Qty 1 pair capacity 45kg H 60mm SS telescopic		
spare parts for	690752		
	GEV No.	690750	Ref. No. —
	stop for telescopic rail L 20mm plastic H 12mm D 9mm		
	GEV No.	696333	Ref. No. —
	stop for telescopic rail L 20mm plastic H 15mm D 8mm		

¹multiple slide (60mm more than nominal length)



GEV No.	690744 ¹	Ref. No.	36M5380 36M5390
description	drawer slide L 600mm pull-out length 660mm total length 1260mm Qty 1 pair capacity 45kg W 17mm H 60mm mounting pos. right/left SS telescopic		
For models:	EM1A-2, EM1A-2A, EM1A-2X, EM1B-2, EM1B-2A, EM1B-2X, EM1B-4, EM1B-4A, EM1B-4X, EM1C-2, EM1C-2A, EM1C-2X, EM1C-4, EM1C-4A, EM1C-4X, EM1C-6, EM1C-6A, EM1C-6X, EXM1A-2, EXM1A-2A, EXM1A-2X, EXM1B-2, EXM1B-2A, EXM1B-2X, EXM1B-4, EXM1B-4A, EXM1B-4X, EXM1C-2, EXM1C-2A, EXM1C-2X, EXM1C-4, EXM1C-4A, EXM1C-4X, EXM1C-6, EXM1C-6A, EXM1C-6X, KM1A, KM1A-11, KM1A-11A, KM1A-11X, KM1A-2, KM1A-2A, KM1A-2X, KM1A-4, KM1A-4A, KM1A-4X, KM1A-A, KM1A-X, KM1B, KM1B-11...(Other models you can see in the webshop)		
spare parts for	690744		
	GEV No.	690750	Ref. No. —
	stop for telescopic rail L 20mm plastic H 12mm D 9mm		
	GEV No.	696333	Ref. No. —
	stop for telescopic rail L 20mm plastic H 15mm D 8mm		

¹multiple slide (60mm more than nominal length)

rollers

rollers

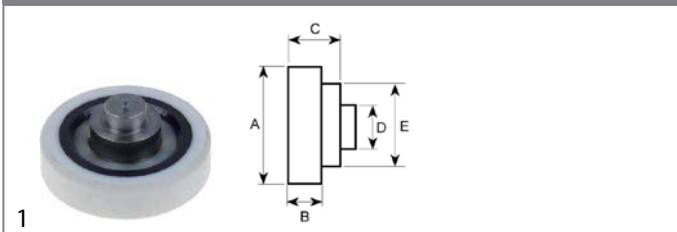

GEV No.	690680	Ref. No.	36G2810
description	roller rollerø 24mm B1 6mm overall width 9mm A 24mm B 6mm C 9mm D 6mm E 10mm ceramic bearing ball bearing		

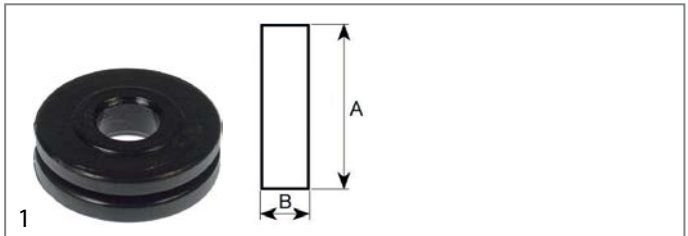

GEV No.	691197	Ref. No.	36G3940
description	roller rollerø 30mm overall width 10mm A 90mm B 10mm plastic		
For models:	AF1L, AF2L, AF2S, AF3S, AM03LT7, AM03LT7A, AM03LT7M, AM1L, AM1LM, AM1LR, AM1LT, AM1LW, AM2L, AM2LR, AM2LW, AM2S, AM2SR, AM2SW, AM3S, AM3SR, AM3SW, AM4S, AM4SR, AM4SW, ECB, ECB218, ECN, ECN218, EKPV, EKV, ENB, ENB218, KA12A1E, KA12B1E, KA12B2E, KA12M1E, KA14A1E, KA14B1E, KA14B2E, KA14M1E, KA16A1E, KA16B1E, KA16B2E, KA16M1E, KA18A1E, KA18B1E, KA18B2E, KA18M1E, KA20A1E, KA20B1E...(Other models you can see in the webshop)		
accessories for	691197		

	GEV No.	691126	Ref. No.	36D4440
	bushing H 11mm for roller			

accessories



GEV No.	691126	Ref. No.	36D4440
description	bushing H 11mm for roller		
For models:	AF1L, AF2L, AF2S, AF3S, AM03LT7, AM03LT7A, AM03LT7M, AM1L, AM1LM, AM1LR, AM1LT, AM1LW, AM2L, AM2LR, AM2LW, AM2S, AM2SR, AM2SW, AM3S, AM3SR, AM3SW, AM4S, AM4SR, AM4SW, ECB, ECB218, ECN, ECN218, EKPV, EKV, ENB, ENB218, KA12A1E, KA12B1E, KA12B2E, KA12M1E, KA14A1E, KA14B1E, KA14B2E, KA14M1E, KA16A1E, KA16B1E, KA16B2E, KA16M1E, KA18A1E, KA18B1E, KA18B2E, KA18M1E, KA20A1E, KA20B1E...(Other models you can see in the webshop)		

filters

air filters

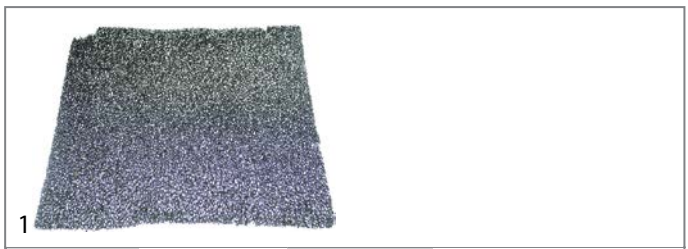

GEV No.	750164	Ref. No.	36D5560
description	air filter L 240mm W 190mm H 5mm		
For models:	KAL1433, KAL1433V, KAL1437, KAL1437V, KAL1633, KAL1633V, KAL2033, KAL2033V, KAL2533, KAL2533V, KPE1633, KPE1633V, KPE2033, KPE2033V, KPM1633, KPM1633V, KPM2033, KPM2033V, KPZ1633A, KPZ1633B, KPZ2033A, KPZ2033B, KPZ2533A, KPZ2533B, P135, P135-3, P135-4, P135BN, P135NN, P135NN-3, P65, P65-2, P65B		



equipment feet and end caps

equipment feet

with fixing plate

			
1			
GEV No.	701379	Ref. No.	3137690 36C5600
description	equipment foot tube ø 64mm plate size 80-100mm hole distance 60-80mm H 105-155mm SS size 2 1/2" Qty 1 pcs		
For models:	CD130, CD130B, CD130BN, CD130NN, CD150, CD150B, CD150BB, CD150BN, CD150BR, CD150CP, CD150NN, CD150PV, CD150R, CD60, CD60B, CD70, CD702, CD70B, CD70B2, CD70BPV, CD70BR, CD70CP, CD70PV, CD70PVSX, CD70R, CDG150, CDG150B, CDG70, CDG70B, DM101L, DMG101L, DMG102, DMG102-0P141, DMG82, DMG82-0P141, DMS101L, DMS101S, DMS102S, DMS72S, FD140, FD140B, FD140NN, FD140PV, FD150, FD150B, FD150LT, FD150LTE, FD70, FD70B, FD70LT...(Other models you can see in the webshop)		

			
1			
GEV No.	700709	Ref. No.	36C5550
description	equipment foot tube ø 64mm plate size 80x100mm hole distance 60x80mm H 115-170mm SS size 2 2/3" Qty 1 pcs		
For models:	AS120, AS120B, AS120BN, AS120NN, AS140, AS140B, AS140BN, AS140NN, AS150, AS150B, AS55, AS55B, AS65, AS65B, AS70, AS70B, AX120, AX120B, AX120BN, AX120NN, AX130, AX130B, AX130NN, AX140, AX140B, AX140BN, AX140NN, AX150, AX150B, AX150NN, AX55, AX55B, AX60, AX60B, AX65, AX65B, AX70, AX70B, CD130, CD130B, CD130BN, CD130NN, CD150, CD150B, CD150BB, CD150BN, CD150BR, CD150CP, CD150NN, CD150PV...(Other models you can see in the webshop)		

			
1			
GEV No.	701378	Ref. No.	3145280
description	equipment foot tube ø 64mm plate size 80x100mm hole distance 60x80mm H 150-200mm SS size 2 1/2" Qty 1 pcs		
For models:	IM101SC, IM51H, KBF16, KBF16A, KBF16M, KBF21, KBF21A, KBF21M, KBP41P, KBP41X, KBP53G, KBP53V, KBP53X, KBP64G, KBP64V, KBP64X, KBP83G, KBP83V, KBP83X, KBP94G, KBP94V, KBP94X, KBPZ16, KBPZ163A, KBPZ163B, KBPZ163S, KBPZ167A, KBPZ167B, KBPZ167S, KBPZ20, KBPZ203A, KBPZ203B, KBPZ203S, KBPZ207A, KBPZ207B, KBPZ207S, KBPZ25, KBPZ253A, KBPZ257A, KBPZ257B, KBS10, KBS10A, KBS10M, KBS11, KBS11A, KBS11M, KBS14, KBS14A, KBS14M, KBS16...(Other models you can see in the webshop)		

			
1			
GEV No.	700708	Ref. No.	36C4540
description	equipment foot tube ø 64mm plate size 90x90mm hole distance 70x70mm H 140-195mm SS size 2 1/2" Qty 1 pcs		
For models:	RX150, RX150-3, RX150-4, RX150B, RX150BB, RX150BB2, RX150BN, RX150BN2, RX150BR, RX150CP, RX150NCP, RX150NN, RX150PV, RX150R, RX70, RX70-2, RX70B, RX70B-2, RX70BCP, RX70BR, RX70NB, RX70NCP, RX70NN, RX70PV, RX70R		

<h3>components</h3>			
			
1			
GEV No.	701090	Ref. No.	36D4000
description	equipment foot tube ø 51mm plate size 145mm hole distance 145mm plastic size 2" ET Qty 1 pcs		
For models:	F120, F120B, F120NN, F120PL, F120PV, F120SP, F40, F40B, F40CP, F40CPX, F40EV, F40EVP, F40PLA, F40PLE, F40PLPV, F40PV, F40X, F55, F55B, F55PL, F55PV, F55SP, SX135AX, SX135BAX, SX65AX, SX65BAX		

shelves and shelf rails

grates

universal

without upstand







				
1				
GEV No.	970125	Ref. No.	32A2430 36A2430	
description	grate W 325mm D 530mm GN 1/1 plastic-coated steel crossing wires 1 white suitable for refrigerator			
For models:	EKP218, EKP21C, EKV218, EKV21C, K160GPZ, K160PZ, K160SL, K160XPZ, QL21RPR, QL21RVR			
accessories for	970125			
	GEV No.	690330	Ref. No.	—
	rack L 1000mm W 22mm H 4mm aperture 3x8mm hole distance 12.5mm stainless steel			
	GEV No.	694700	Ref. No.	—
	shelf support L 31/28mm W 22mm H 18mm SS Qty 12 pcs			

Table continues overleaf

accessories for	970125		
	GEV No.	694701	Ref. No. —
	shelf support L 31/28mm W 22mm H 17mm SS with hook Qty 12 pcs		

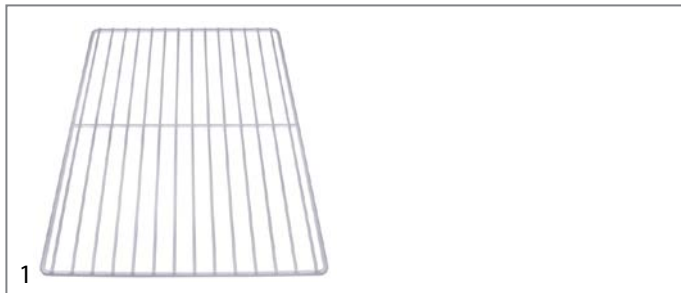



GEV No.	970132	Ref. No.	36A0131
description	grate W 400mm D 600mm plastic-coated steel crossing wires 1 white suitable for refrigerator		
For models:	F40, F40-0P141, F40CP, F40CP-0P141, F40CPX, F40CPX-0P141, F40P-LA, F40PLE, F40PLPV, F40PV, F40PV-0P141, F40X, F40X-0P141		

accessories for	970132		
	GEV No.	690330	Ref. No. —
	rack L 1000mm W 22mm H 4mm aperture 3x8mm hole distance 12.5mm stainless steel		
	GEV No.	694700	Ref. No. —
	shelf support L 31/28mm W 22mm H 18mm SS Qty 12 pcs		
	GEV No.	694701	Ref. No. —
	shelf support L 31/28mm W 22mm H 17mm SS with hook Qty 12 pcs		

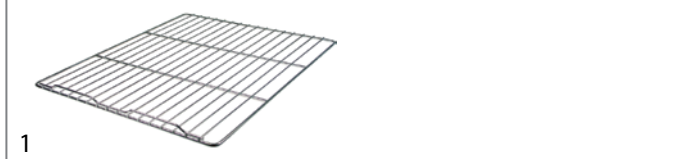
with upstand





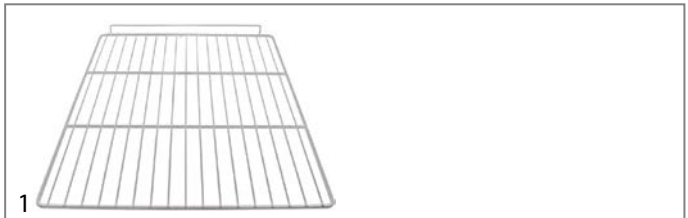

GEV No.	970527	Ref. No.	36A0990
description	grate W 530mm D 650mm GN 2/1 chrome-plated steel with hinge camp crossing wires 2 suitable for refrigerator		

accessories for	970527		
	GEV No.	690330	Ref. No. —
	rack L 1000mm W 22mm H 4mm aperture 3x8mm hole distance 12.5mm stainless steel		
	GEV No.	694700	Ref. No. —
	shelf support L 31/28mm W 22mm H 18mm SS Qty 12 pcs		
	GEV No.	694701	Ref. No. —
	shelf support L 31/28mm W 22mm H 17mm SS with hook Qty 12 pcs		



GEV No.	970556	Ref. No.	36A0710 RGP/2-1
description	grate W 530mm D 650mm GN 2/1 plastic-coated steel with hinge camp wire gauge frame 9mm lengthwise wires gauge 5mm crossing wires 2 white suitable for refrigerator		



For models:	AS140, AS140B, AS140BN, AS140NN, AS150, AS150B, AS65, AS65B, AS70, AS70B, AX140, AX140B, AX140BN, AX140NN, AX150, AX150B, AX150NN, AX65, AX65B, AX70, AX70B, CD150, CD150B, CD150BB, CD150BN, CD150BR, CD150CP, CD150NN, CD150PV, CD150R, CD70, CD702, CD70B, CD70B2, CD70BPV, CD70BR, CD70PV, CD70PVSX, CD70R, CDG150, CDG150B, CDG70, CDG70B, E1200, E12004, E1200B, E1200B4, E1200BE, E1200E, E1200PV...(Other models you can see in the webshop)		
--------------------	--	--	--

accessories for	970556		
	GEV No.	690330	Ref. No. —
	rack L 1000mm W 22mm H 4mm aperture 3x8mm hole distance 12.5mm stainless steel		
	GEV No.	690332	Ref. No. —
	shelf support L 31/28mm W 22mm H 17mm SS with hook Qty 1 pcs		
	GEV No.	694700	Ref. No. —
	shelf support L 31/28mm W 22mm H 18mm SS Qty 12 pcs		
	GEV No.	694701	Ref. No. —
	shelf support L 31/28mm W 22mm H 17mm SS with hook Qty 12 pcs		







GEV No.	970643	Ref. No.	36A3010
description	grate W 555mm D 510mm H 60mm plastic-coated steel with hinge camp crossing wires 1		

For models:	F120, F120B, F120NN, F120PL, F120PV, F120SP, F55, F55B, F55PL, F55SP, SX120, SX120B, SX120BN, SX120NN, SX55, SX55B		
--------------------	--	--	--

accessories for	970643		
	GEV No.	690330	Ref. No. —
	rack L 1000mm W 22mm H 4mm aperture 3x8mm hole distance 12.5mm stainless steel		
	GEV No.	694700	Ref. No. —
	shelf support L 31/28mm W 22mm H 18mm SS Qty 12 pcs		
	GEV No.	694701	Ref. No. —
	shelf support L 31/28mm W 22mm H 17mm SS with hook Qty 12 pcs		



			
1			
GEV No.	970557	Ref. No.	36A3020
description	grate W 555mm D 670mm plastic-coated steel with hinge camp crossing wires 2 suitable for refrigerator		
accessories for	970557		
	GEV No.	690330	Ref. No. —
	 rack L 1000mm W 22mm H 4mm aperture 3x8mm hole distance 12.5mm stainless steel		
	GEV No.	694700	Ref. No. —
	 shelf support L 31/28mm W 22mm H 18mm SS Qty 12 pcs		
	GEV No.	694701	Ref. No. —
	 shelf support L 31/28mm W 22mm H 17mm SS with hook Qty 12 pcs		

grid attachments

			
1			
GEV No.	695572	Ref. No.	36M7340
description	rack support		
For models:	KMRA, KMRA2, KMRA2A, KMRA2M, KMRA4, KMRA4A, KMRA4M, KMRAA, KMRAM, KMRB, KMRB11, KMRB11A, KMRB11M, KMRB2, KMRB2A, KMRB2M, KMRB4, KMRB4A, KMRB4M, KMRB6, KMRB6M, KMRBA, KMRBM, KMRC, KMRC11, KMRC11A, KMRC11M, KMRC2, KMRC2A, KMRC2M, KMRC4, KMRC4A, KMRC4M, KMRC6, KMRC6A, KMRC6M, KMRC6M, KMRC6M, KMRC6M, KPM1633, KPM1633V, KPM2033, KPM2033V		

			
1			
GEV No.	695577	Ref. No.	36G8640
description	rack support L 20mm H 15.5mm W 11mm plastic		
For models:	EM1A, EM1A-2, EM1A-2A, EM1A-2X, EM1A-A, EM1A-X, EM1B, EM1B-2, EM1B-2A, EM1B-2X, EM1B-4, EM1B-4A, EM1B-4X, EM1B-A, EM1B-X, EM1C, EM1C-2, EM1C-2A, EM1C-2X, EM1C-4, EM1C-4A, EM1C-4X, EM1C-6, EM1C-6A, EM1C-6X, EM1C-A, EM1C-X, EXM1A, EXM1A-2, EXM1A-2A, EXM1A-2X, EXM1A-A, EXM1A-X, EXM1B, EXM1B-2, EXM1B-2A, EXM1B-2X, EXM1B-4, EXM1B-4A, EXM1B-4X, EXM1B-A, EXM1B-X, EXM1C, EXM1C-2, EXM1C-2A, EXM1C-2X, EXM1C-4, EXM1C-4A, EXM1C-4X, EXM1C-6... (Other models you can see in the webshop)		

shelf rails and supports

producer-specific

			
1			
GEV No.	701465	Ref. No.	3069950
description	guide L-shape L 600mm W 20mm H 30mm mounting pos. left		
For models:	KBF16, KBF16A, KBF16M, KBF21, KBF21A, KBF21M, KBP53G, KBP53V, KBP53X, KBP64G, KBP64V, KBP64X, KBP83G, KBP83V, KBP83X, KBP94G, KBP94V, KBP94X, KBPZ16, KBPZ163A, KBPZ163B, KBPZ163S, KBPZ167A, KBPZ167B, KBPZ167S, KBPZ20, KBPZ203A, KBPZ203B, KBPZ203S, KBPZ207A, KBPZ207B, KBPZ207S, KBPZ25, KBPZ253A, KBPZ253B, KBPZ257A, KBPZ257B, KBS11, KBS11A, KBS11M, KBS16, KBS16A, KBS16M, KBS21, KBS21A, KBS21M, KBSR11, KBSR11A, KBSR11M, KBSR16... (Other models you can see in the webshop)		

			
1			
GEV No.	701466	Ref. No.	3069940
description	guide L-shape L 600mm W 20mm H 30mm mounting pos. right		
For models:	KBF16, KBF16A, KBF16M, KBF21, KBF21A, KBF21M, KBP53G, KBP53V, KBP53X, KBP64G, KBP64V, KBP64X, KBP83G, KBP83V, KBP83X, KBP94G, KBP94V, KBP94X, KBPZ16, KBPZ163A, KBPZ163B, KBPZ163S, KBPZ167A, KBPZ167B, KBPZ167S, KBPZ20, KBPZ203A, KBPZ203B, KBPZ203S, KBPZ207A, KBPZ207B, KBPZ207S, KBPZ25, KBPZ253A, KBPZ253B, KBPZ257A, KBPZ257B, KBS11, KBS11A, KBS11M, KBS16, KBS16A, KBS16M, KBS21, KBS21A, KBS21M, KBSR11, KBSR11A, KBSR11M, KBSR16... (Other models you can see in the webshop)		

			
1			
GEV No.	691841	Ref. No.	35V6620
description	guide U-shape L 430mm W 13mm mounting pos. left inner height 21mm		
For models:	F40CP, F40CPX		

			
1			
GEV No.	691925	Ref. No.	35V6610
description	guide U-shape L 430mm W 13mm mounting pos. right inner height 21mm		
For models:	F40CP, F40CPX		

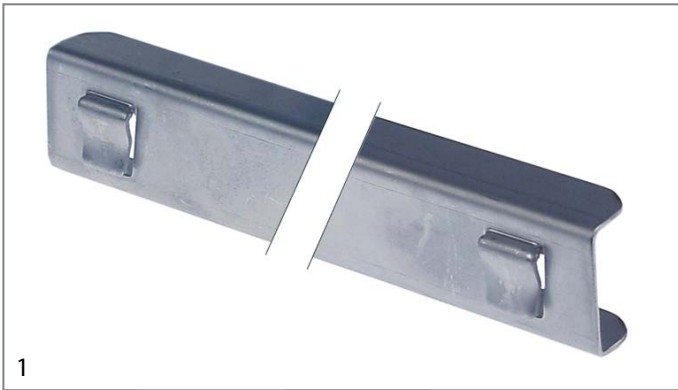

GEV No.	970888	Ref. No.	35R9140
description	guide U-shape L 638mm W 13mm H 20mm mounting pos. right/left		
For models:	AS140, AS140B, AS140BN, AS140NN, AS150, AS150B, AS65, AS65B, AS70, AS70B, AX140, AX140B, AX140BN, AX140NN, AX150, AX150B, AX150NN, AX65, AX65B, AX70, AX70B, CD150, CD150B, CD150BB, CD150BN, CD150BR, CD150CP, CD150NN, CD150PV, CD150R, CD70, CD702, CD70B, CD70B2, CD70BPV, CD70BR, CD70PV, CD70PVSX, CD70R, CDG150, CDG150B, CDG70, CDG70B, DMG82, DMG82-OP141, FD140, FD140B, FD140NN, FD140PV, FD65...(Other models you can see in the webshop)		

GEV No.	690657	Ref. No.	36D9470
description	rack L 650mm W 34mm H 57mm mounting pos. vertical		
For models:	F55PV, N135, N135-3, N135-4, N135B, N135BN, N135NN, N135PV, N65, N65-2, N65B, N65PV, SX135-3E		

GEV No.	900862	Ref. No.	37Q4720
description	refrigeration gasket profile 9048 W 246mm L 373mm plug size		
For models:	KIA2, KIA2A, KIA2M, KIB2, KIB2A, KIB2M, KIB4, KIB4A, KIB4M, KIC2, KIC2A, KIC2M, KIC4, KIC4A, KIC4AM, KIRA2, KIRA2-OP141, KIRA2A, KIRA2A-OP141, KIRA2M, KIRA2M-OP141, KIRB2, KIRB2-OP141, KIRB2A, KIRB2A-OP141, KIRB2M, KIRB2M-OP141, KIRB4, KIRB4-OP141, KIRB4A, KIRB4A-OP141, KIRB4M, KIRB4M-OP141, KIRC2, KIRC2-OP141, KIRC2A, KIRC2A-OP141, KIRC2M, KIRC2M-OP141, KIRC4, KIRC4-OP141, KIRC4A, KIRC4A-OP141, KIRC4M, KIRC4M-OP141, KMRA2, KMRA2A, KMRA2M, KMRA4, KMRA4A...(Other models you can see in the webshop)		

GEV No.	900860	Ref. No.	37Q3950
description	refrigeration gasket profile 9048 W 253mm L 373mm plug size		
For models:	EM1A-2, EM1A-2A, EM1A-2X, EM1B-2, EM1B-2A, EM1B-2X, EM1B-4, EM1B-4A, EM1B-4X, EM1C-2, EM1C-2A, EM1C-2X, EM1C-4, EM1C-4A, EM1C-4X, EM1C-6, EM1C-6A, EM1C-6X, EXM1A-2, EXM1A-2A, EXM1A-2X, EXM1B-2, EXM1B-2A, EXM1B-2X, EXM1B-4, EXM1B-4A, EXM1B-4X, EXM1C-2, EXM1C-2A, EXM1C-2X, EXM1C-4, EXM1C-4A, EXM1C-4X, EXM1C-6, EXM1C-6A, EXM1C-6X, JA2, JA2A, JA2M, JB2, JB2A, JB2M, JB4A, JB4M		

GEV No.	900864	Ref. No.	37Q4740
description	refrigeration gasket profile 9048 W 354mm L 373mm plug size		
For models:	KIA11, KIA11A, KIA11M, KIB11, KIB11A, KIB11M, KIB22, KIB22A, KIB22M, KIC11, KIC11A, KIC11M, KIC22, KIC22A, KIC22M, KMRB11, KMRB11A, KMRB11M, KMRC11, KMRC11A, KMRC11M, KTIA11, KTIA11A, KTIA11M, KTIB11, KTIB11A, KTIB11M, KTIC11, KTIC11A, KTIC11M, KTIC22, KTIC22A, KTIC22M, KTRB11, KTRB11A, KTRB11M, KTRC11, KTRC11A, KTRC11M, KUB11, KUB11A, KUB11M, KUC11, KUC11A, KUC11M, KUEB11, KUEB11A, KUEB11M, KWRB11, KWRB11A...(Other models you can see in the webshop)		

gaskets

refrigeration gaskets

plug-in gaskets

profile 9048

We offer custom-made gaskets for this profile

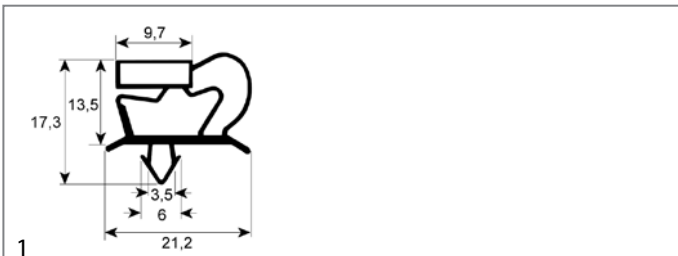

GEV No.	900863	Ref. No.	37Q4730
description	refrigeration gasket profile 9048 W 138mm L 373mm plug size		
For models:	KIA11, KIA11A, KIA11M, KIA13, KIA13A, KIA13M, KIB11, KIB11A, KIB11M, KIB13, KIB13A, KIB13M, KIB22, KIB22A, KIB22M, KIC11, KIC11A, KIC11M, KIC13, KIC13A, KIC13M, KIC22, KIC22A, KIC22M, KMRB11, KMRB11A, KMRB11M, KMRC11, KMRC11A, KMRC11M, KTIA11, KTIA11A, KTIA11M, KTIA13, KTIA13A, KTIA13M, KTIB11, KTIB11A, KTIB11M, KTIB13, KTIB13A, KTIB13M, KTIC11, KTIC11A, KTIC11M, KTIC13, KTIC13A, KTIC13M, KTIC22, KTIC22A...(Other models you can see in the webshop)		

GEV No.	900861	Ref. No.	37Q4710
description	refrigeration gasket profile 9048 W 373mm L 570mm plug size		
For models:	KIRA, KIRA-OP141, KIRA2, KIRA2-OP141, KIRA2A, KIRA2A-OP141, KIRA2M, KIRA2M-OP141, KIRAA, KIRAA-OP141, KIRAB, KIRAB-OP141, KIRABA, KIRABM, KIRABM-OP141, KIRAM, KIRAM-OP141, KIRB, KIRB-OP141, KIRB2, KIRB2-OP141, KIRB2A, KIRB2A-OP141, KIRB2M, KIRB2M-OP141, KIRB4, KIRB4-OP141, KIRB4A, KIRB4A-OP141, KIRB4M, KIRB4M-OP141, KIRBA, KIRBA-OP141, KIRBB, KIRBB-OP141, KIRBBA, KIRBBA-OP141, KIRBBM, KIRBBM-OP141, KIRBM, KIRBM-OP141, KIRC, KIRC-OP141, KIRC2, KIRC2-OP141, KIRC2A, KIRC2A-OP141, KIRC2M, KIRC2M-OP141, KIRC4...(Other models you can see in the webshop)		

GEV No.	901207	Ref. No.	37Q3810
description	refrigeration gasket profile 9048 W 429mm L 675mm plug size for blast chiller		
For models:	AF1L, AM1L, AM1LM, AM1LR, AM1LT, AM1LW, AT1L, IM51H		

GEV No.	900709	Ref. No.	37Q3870
description	refrigeration gasket profile 9048 W 373mm L 580mm plug size		
For models:	EM1A, EM1A-2, EM1A-2A, EM1A-2X, EM1A-A, EM1A-X, EM1B, EM1B-2, EM1B-2A, EM1B-2X, EM1B-4, EM1B-4A, EM1B-4X, EM1B-A, EM1B-X, EM1C, EM1C-2, EM1C-2A, EM1C-2X, EM1C-4, EM1C-4A, EM1C-4X, EM1C-6, EM1C-6A, EM1C-6X, EM1C-A, EM1C-X, EXM1A, EXM1A-2, EXM1A-2A, EXM1A-2X, EXM1A-A, EXM1A-X, EXM1B, EXM1B-2, EXM1B-2A, EXM1B-2X, EXM1B-4, EXM1B-4A, EXM1B-4X, EXM1B-A, EXM1B-X, EXM1C, EXM1C-2, EXM1C-2A, EXM1C-2X, EXM1C-4, EXM1C-4A, EXM1C-4X, EXM1C-6...(Other models you can see in the webshop)		

GEV No.	902533	Ref. No.	37Q4140
description	refrigeration gasket profile 9048 W 450mm L 600mm plug size		

GEV No.	900812	Ref. No.	37Q4490
description	refrigeration gasket profile 9048 W 400mm L 650mm plug size for blast chiller		
For models:	AF1L7, AF1L7A, AF1L7M, AM03LT7, AM03LT7A, AM03LT7M, AM1L7, AM1L7A, AM1L7M, AM1LT7, AM1LT7A, AM1LT7M, AT1L7, AT1L7A, AT1L7M, DC51, DF51M, DM31, DM31A, DM31C, DM31M, DM51, DM51A, DM51C, DM51M, DM51ME, DMG51C, DMG51M, DMG51ME, DMG51ME-OP141, DMS51, DMS51A, DMS51C, DMS51M, DR51, DR51A, DR51M, IF51M, IM51, IM51A, IM51AR, IM51C, IM51CR, IM51M, IM51MR, IM51R, IM51WC, IMS51, IMS51A, IMS51M...(Other models you can see in the webshop)		

GEV No.	900712	Ref. No.	37Q1020 37Q4850
description	refrigeration gasket profile 9048 W 595mm L 1590mm plug size		
For models:	E1200, E1200B, E1200BE, E1200E, E125, E125B, E125BE, E125BPL, E125BPPL, E125BX, E125BXE, E125E, E125PL, E125PLE, E125SP, E125XE, E125XSP, E60, E600, E600B, E600BE, E600E, E60B, E60BE, E60BPPL, E60BPPL, E60BX, E60BXE, E60E, E60PL, E60PLE, E60SP, E60X, E60XE, E60XSP		

GEV No.	900710	Ref. No.	37Q5450
description	refrigeration gasket profile 9048 W 655mm L 1500mm plug size		
For models:	AS120, AS120B, AS120BN, AS120NN, AS140, AS140B, AS140BN, AS140NN, AS55, AS55B, AS65, AS65B, AX120, AX120B, AX120BN, AX120NN, AX140, AX140B, AX140BN, AX140NN, AX55, AX55B, AX65, AX65B, CD130, CD130B, CD130BN, CD130NN, CD150, CD150B, CD150BB, CD150BN, CD150BR, CD150CP, CD150NN, CD150PV, CD150R, CD60, CD60B, CD70, CD70B, CD70BR, CD70CP, CD70R, CDG150, CDG150B, CDG70, CDG70B, FD140, FD140B...(Other models you can see in the webshop)		

GEV No.	901329	Ref. No.	37Q5460
description	refrigeration gasket profile 9048 W 655mm L 704mm plug size		
For models:	CD150CP, CD702, CD70B2, DMG82, DMG82-0P141, GS140BN2, GS140CP, GS652, GS65BCP, GS65NB, GS65NCP, GS65NN, VD1504, VD150B4, VD702, VD70B2, VD70BCP, VD70NB, VD70NCP, VD70NN		

GEV No.	900706	Ref. No.	37Q4370
description	refrigeration gasket profile 9048 W 660mm L 1610mm plug size		
For models:	AS150, AS150B, AS70, AS70B, AX130, AX130B, AX130NN, AX150, AX150B, AX150NN, AX60, AX60B, AX70, AX70B, GS130, GS130B, GS130NN, GS150, GS150B, GS150NN, GS60, GS60B, GS70, GS70B, GX130, GX130B, GX130NN, GX150, GX150B, GX150NN, GX60, GX60B, GX70, GX70B, RX150, RX150-3, RX150B, RX150BB, RX150BB2, RX150BN, RX150BN2, RX150BR, RX150CP, RX150NCP, RX150NN, RX150R, RX70, RX70B, RX70BR, RX70R		

GEV No.	900350	Ref. No.	37Q2600
description	refrigeration gasket profile 9048 W 670mm L 760mm plug size 1/2 door		
For models:	N135-3, N135-4, N65-2, N65NB, N65NN, P135-3, P135-4, P135NN-3, P65-2, SX135-3, SX135-3E, SX135-4, SX135-4E, SX135B-3, SX135B-4, SX135BN2, SX135CP, SX65-2, SX65-2E, SX65B-2, SX65CPB, SX65CPN, SX65N-3C, SX65NB, SX65NN		

GEV No.	900351	Ref. No.	37Q2590
description	refrigeration gasket profile 9048 W 672mm L 1587mm plug size door		
For models:	E125PV, E125PVX, F120, F120B, F120NN, F120PL, F120PV, F120SP, F55, F55B, F55PL, F55PV, F55SP, N135, N135-3, N135B, N135BN, N135BPS, N135NN, N135PS, N65, N65B, N65BPS, N65PS, P135, P135-3, P135B, P135BN, P135NN, P135NN-3, P65, P65B, SX120, SX120B, SX120BN, SX120NN, SX135, SX135-3, SX135-3E, SX135AX, SX135B, SX135B-3, SX135BAX, SX135BB, SX135BCP, SX135BE, SX135BN, SX135BN2, SX135BR, SX135CP..(Other models you can see in the webshop)		

GEV No.	900328	Ref. No.	37Q1370
description	refrigeration gasket profile 9048 W 675mm L 1525mm plug size glass door		
For models:	E1200PV, E60PV, E60PVX, F40EV, F40EVP, F40PLPV, F40PV		

GEV No.	901206	Ref. No.	37Q3800
description	refrigeration gasket profile 9048 W 675mm L 820mm plug size for blast chiller		
For models:	AF2L, AF2S, AM2L, AM2LR, AM2LW, AM2S, AM2SW		

GEV No.	900326	Ref. No.	37Q1380
description	refrigeration gasket profile 9048 W 685mm L 1600mm plug size glass door		
For models:	N135PV, N65PV, SX120PV, SX135PV, SX55PV, SX65PV		

GEV No.	901205	Ref. No.	37Q5340
description	refrigeration gasket profile 9048 W 690mm L 835mm plug size for blast chiller		
For models:	DM101L, DMG101L, DMS101L, DMS101S, IF101L, IM101L, IM101LR, IM101LW, IM101RAT, IM101S, IM101SC, IM101SR, IMS101L, IMS101S, IR101L, IR101S, TC101L, TC101S, TF101L, TF101S		

GEV No.	901204	Ref. No.	37Q5380
description	refrigeration gasket profile 9048 W 941mm L 1002mm plug size for blast chiller		
For models:	DMS102S, DMS72S, IM102S, IM102SC, IM102SR, IM102SW, IM72S, IM72SR, IM72SW, IMS102S, IMS72S, IR72S		

GEV No.	901801	Ref. No.	37Q4470
description	refrigeration gasket profile 9046 W 650mm L 750mm plug size		
For models:	RX150-3, RX150-4, RX150BB2, RX150BN2, RX150CP, RX70-2, RX70B-2, RX70BCP, RX70NB, RX70NCP, RX70NN		

GEV No.	902258	Ref. No.	N/A
description	refrigeration gasket profile 9048 Wmm L 2500mm		

GEV No.	902257	Ref. No.	N/A
description	refrigeration gasket profile 9046 Wmm L 2500mm		

profile 9046

We offer custom-made gaskets for this profile

GEV No.	902515	Ref. No.	3125970
description	refrigeration gasket profile 9046 W 377mm L 395mm plug size		
For models:	KSA, KSA2, KSA2M, KSAM, KSB, KSB2, KSB2M, KSBM		

profile 9704

We offer custom-made gaskets for this profile

GEV No.	902315	Ref. No.	37Q5490
description	refrigeration gasket profile 9704 W 655mm L 1500mm plug size		
For models:	CD70BPV, CD70PV, CD70PVSX, FD140PV, FD65PV, GS140BPV, GS140PV, GS65BPV, GS65PV, VD150BPV, VD150PV, VD70BPV, VD70PV		

GEV No.	902314	Ref. No.	37Q5510
description	refrigeration gasket profile 9046 W 520mm L 1495mm plug size		
For models:	KAF1B, KAF1B-0P141, KAF1N, KAF1N-0P141, KFSD1B, KFSD1B-0P141, KFSD1N, KFSD1N-0P141, KFSDR1B-0P141, KFSDR1N-0P141		

profile 9753

We offer custom-made gaskets for this profile

GEV No.	900875	Ref. No.	N/A
description	refrigeration gasket profile 9753 Wmm L 2500mm		

profile 9333

We offer custom-made gaskets for this profile

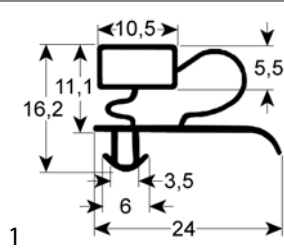

GEV No.	900016	Ref. No.	37Q1890
description	refrigeration gasket profile 9333 W 650mm L 1550mm plug size 1/2 door		

profile 9012

We offer custom-made gaskets for this profile

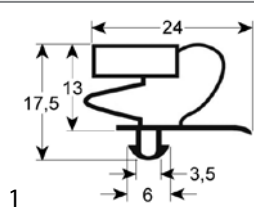

GEV No.	900354	Ref. No.	37Q7730
description	refrigeration gasket profile 9012 W 130mm L 367mm plug size drawer size 1/3		
For models:	KM1A-11, KM1A-11A, KM1A-11X, KM1B-11, KM1B-11A, KM1B-11X, KM1B-22, KM1B-22A, KM1B-22X, KM1C-11, KM1C-11A, KM1C-11X, TE1A-11, TE1A-11A, TE1A-11X, TE1A-3, TE1A-3A, TE1A-3X, TE1B-11, TE1B-11A, TE1B-11X, TE1B-22, TE1B-22A, TE1B-22X, TE1B-3, TE1B-3A, TE1B-3X, TE1C-11, TE1C-11A, TE1C-11X, TE1C-22, TE1C-22A, TE1C-22X, TE1C-3, TE1C-33, TE1C-33A, TE1C-33X, TE1C-3A, TE1C-3X, TM1A-11, TM1A-11A, TM1A-11X, TM1A-3, TM1A-3A, TM1A-3X, TM1B-11, TM1B-11A, TM1B-11X, TM1B-22, TM1B-22A...(Other models you can see in the webshop)		

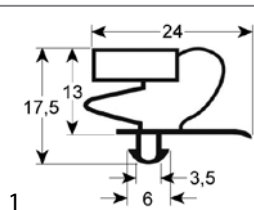

GEV No.	900353	Ref. No.	37Q7690
description	refrigeration gasket profile 9012 W 242mm L 367mm plug size drawer size 1/2		
For models:	KM1A, KM1A-11, KM1A-11A, KM1A-11X, KM1A-2, KM1A-2A, KM1A-2X, KM1A-4, KM1A-4A, KM1A-4X, KM1A-A, KM1A-X, KM1B, KM1B-11, KM1B-11A, KM1B-11X, KM1B-2, KM1B-22, KM1B-22A, KM1B-22X, KM1B-2A, KM1B-2X, KM1B-4, KM1B-4A, KM1B-4X, KM1B-6, KM1B-6A, KM1B-6X, KM1B-A, KM1B-X, KM1C, KM1C-11, KM1C-11A, KM1C-11X, KM1C-2, KM1C-2A, KM1C-2X, KM1C-4, KM1C-4A, KM1C-4X, KM1C-6, KM1C-6A, KM1C-6X, KM1C-8, KM1C-8A, KM1C-8X, KM1C-A, KM1C-X, TE1A-2, TE1A-2A...(Other models you can see in the webshop)		

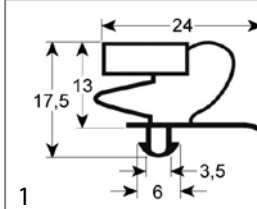

GEV No.	900325	Ref. No.	37Q7720
description	refrigeration gasket profile 9012 W 345mm L 362mm plug size drawer size 2/3		
For models:	KM1A-11, KM1A-11A, KM1A-11X, KM1B-11, KM1B-11A, KM1B-11X, KM1B-22, KM1B-22A, KM1B-22X, KM1C-11, KM1C-11A, KM1C-11X, TE1A-11, TE1A-11A, TE1A-11X, TE1B-11, TE1B-11A, TE1B-11X, TE1B-22, TE1B-22A, TE1B-22X, TE1C-11, TE1C-11A, TE1C-11X, TE1C-22, TE1C-22A, TE1C-22X, TE1C-33, TE1C-33A, TE1C-33X, TM1A-11, TM1A-11A, TM1A-11X, TM1B-11, TM1B-11A, TM1B-11X, TM1B-22, TM1B-22A, TM1B-22X, TM1C-11, TM1C-11A, TM1C-11X, TM1C-22, TM1C-22A, TM1C-22X, TM1C-33, TM1C-33A, TM1C-33X		

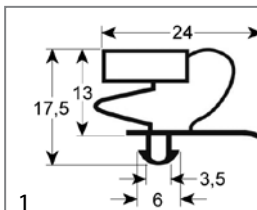

GEV No.	900352	Ref. No.	37Q7590
description	refrigeration gasket profile 9012 W 367mm L 567mm plug size door size 1/1		
For models:	KM1A, KM1A-11, KM1A-11A, KM1A-11X, KM1A-2, KM1A-2A, KM1A-2X, KM1A-A, KM1A-X, KM1B, KM1B-11, KM1B-11A, KM1B-11X, KM1B-2, KM1B-22, KM1B-22A, KM1B-22X, KM1B-2A, KM1B-2X, KM1B-4, KM1B-4A, KM1B-4X, KM1B-A, KM1B-X, KM1C, KM1C-11, KM1C-11A, KM1C-11X, KM1C-2, KM1C-2A, KM1C-2X, KM1C-4, KM1C-4A, KM1C-4X, KM1C-6, KM1C-6A, KM1C-6X, KM1C-A, KM1C-X, TE1A, TE1A-11, TE1A-11A, TE1A-11X, TE1A-2, TE1A-2A, TE1A-2X, TE1A-3, TE1A-3A, TE1A-3X, TE1A-A...(Other models you can see in the webshop)		

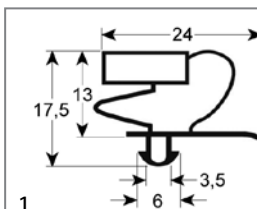

GEV No.	900327	Ref. No.	37Q0210
description	refrigeration gasket profile 9012 W 657mm L 1512mm plug size door refrigeration		
For models:	F40, F40B, F40CP, F40CPX, F40PLA, F40PLE, F40X		

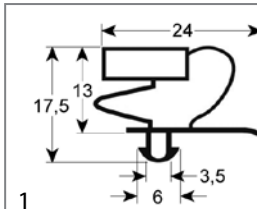

GEV No.	900017	Ref. No.	37Q2010
description	refrigeration gasket profile 9012 W 657mm L 747mm plug size door/glass door		

GEV No.	902252	Ref. No.	N/A
description	refrigeration gasket profile 9012 Wmm L 2500mm		

GEV No.	900717	Ref. No.	37Q2380
description	refrigeration gasket profile 9140 W 575mm L 610mm external size		

screw-in gaskets

profile 9140

We offer custom-made gaskets for this profile

GEV No.	900705	Ref. No.	37Q2050
description	refrigeration gasket profile 9140 W 295mm L 380mm external size		
For models:	K160GPZ, K160PZ, K160SL, K160XPZ		

GEV No.	901606	Ref. No.	37Q3320
description	refrigeration gasket profile 9140 W 600mm L 645mm external size		
For models:	EKP, EKP218, EKP21C, EKPV, EKV, EKV218, EKV21C, EKV		

GEV No.	900009	Ref. No.	37Q2040
description	refrigeration gasket profile 9140 W 380mm L 610mm external size		
For models:	K160GPZ, K160PZ, K160SL, K160XPZ		

GEV No.	901657	Ref. No.	37Q0760
description	refrigeration gasket profile 9140 W 655mm L 1555mm external size		

GEV No.	900858	Ref. No.	37Q3210
description	refrigeration gasket profile 9140 W 383mm L 531mm external size		
For models:	K100, K100SL, K100SLV, K100X, K100XA		

GEV No.	902264	Ref. No.	N/A
description	refrigeration gasket profile 9140 Wmm L 2500mm		

profile 9106

We offer custom-made gaskets for this profile

GEV No.	900859	Ref. No.	37Q3250
description	refrigeration gasket profile 9140 W 459mm L 613mm external size		
For models:	K160PS, K200PS		

GEV No.	902262	Ref. No.	N/A
description	refrigeration gasket profile 9106 Wmm L 2500mm		

profile 9207

We offer custom-made gaskets for this profile

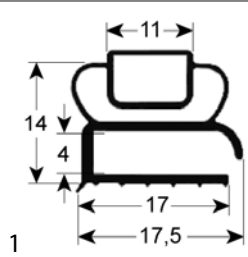

GEV No.	902277	Ref. No.	N/A
description	refrigeration gasket profile 9207 Wmm L 2500mm		

O-rings

silicone

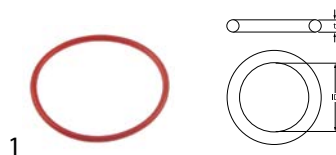

GEV No.	532521	Ref. No.	3152370
description	O-ring silicone thickness 1.78mm ID ø 34.65mm Qty 1 pcs		

filter driers

miscellaneous



GEV No.	750177	Ref. No.	33A0180
description	dryer ø 24mm L 155mm connection 6,3/6,3mm		
For models:	AM03LT7, AM03LT7A, AM03LT7M, AS120, AS120B, AS120BN, AS120NN, AS140, AS140B, AS140BN, AS140NN, AS150, AS55, AS55B, AS65, AS65B, AS70B, AX120, AX120B, AX120BN, AX120NN, AX130, AX140, AX140B, AX140BN, AX140NN, AX150, AX55, AX55B, AX60B, AX65, AX65B, AX70B, DM31, DM31A, DM31C, DM31M, E1200, E12004, E1200E, E1200PV, E125, E125-4, E125E, E125PL, E125PLE, E125PV, E125PVX, E125SP, E125X...(Other models you can see in the webshop)		



GEV No.	750058	Ref. No.	33A1150
description	dryer ø 24mm L 158mm connection 3.1/6.3mm		
For models:	E60, E60-2, E60E, E60PL, E60PLE, E60X-2, E60XE, F120, F120PL, SKVV, SX120BN		

refrigeration cycle components

valves

expansion valves

DANFOSS

valves

type TS2/TE52



GEV No.	750520	Ref. No.	33A0500
description	expansion valve DANFOSS type TES2 coolant R404a/R507 angled 90° inlet 3/8" SAE outlet 12mm soldering connection 6mm soldering connection p max 34bar capillary pipe 1500mm		
For models:	AM2L, AM2LR, AM2LW, AM2S, AM2SR, AM2SW, AM3S, AM3SR, AM3SW, AM4S, AM4SR, AM4SW, DMS102S, IM102S, IM102SC, IM102SR, IM102SW, IMS102S		



GEV No.	750304	Ref. No.	33A0870
description	expansion valve DANFOSS type TES2 coolant R404a/R507 angled 90° thermostatically controlled inlet 3/8" SAE outlet 12mm soldering connection 6mm soldering connection p max 34bar -40 up to +10°C capillary pipe 1500mm		
For models:	AF2L, AF2S, AF3S, GR4A-0N141, IR101L, IR101S, IR72S, TC101L, TC101S		

evaporators

for fridges

producer-specific



GEV No.	750248	Ref. No.	34E0640
description	evaporator complete with fan		
For models:	AS120, AS140, AS150, AX120, AX130, AX140, AX150		



1

GEV No.	750049	Ref. No.	34D0360
description	evaporator L 1340mm W 430mm H 5mm type		
For models:	F120, F120NN, F120PL, F120PV, F120SP, F55, F55PL, F55PV, F55SP, N135, N135-3, N135-4, N135BN, N135NN, N135PS, N135PV, N65, N65-2, N65GT, N65PS, N65PV		



1

GEV No.	750658	Ref. No.	34E2930
description	evaporator L 415mm W 105mm H 330mm		
For models:	KBF16, KBF16A, KBF16M, KBF21, KBF21A, KBF21M, KBP41P, KBP41X, KBP53G, KBP53V, KBP53X, KBP64G, KBP64V, KBP64X, KBP83G, KBP83V, KBP83X, KBP94G, KBP94V, KBP94X, KBPZ163S, KBPZ167S, KBPZ20, KBPZ203A, KBPZ203B, KBPZ203S, KBPZ207A, KBPZ207B, KBPZ207S, KBPZ25, KBPZ253A, KBPZ253B, KBPZ257A, KBPZ257B, KBS16, KBS16A, KBS16M, KBS21, KBS21A, KBS21M, KBSR16, KBSR16A, KBSR16M, KBSR21, KBSR21A, KBSR21M, KIB, KIB11, KIB11A, KIB11M...(Other models you can see in the webshop)		



1

GEV No.	750247	Ref. No.	32Z3420
description	evaporator L 255mm H 255mm W 50mm		
For models:	TE1A, TE1A-11, TE1A-11A, TE1A-11X, TE1A-2, TE1A-2A, TE1A-2X, TE1A-3, TE1A-3A, TE1A-3X, TE1A-A, TE1A-X, TM1A, TM1A-11, TM1A-11A, TM1A-11X, TM1A-2, TM1A-2A, TM1A-2X, TM1A-3, TM1A-3A, TM1A-3X, TM1A-A, TM1A-X		



1

GEV No.	750069	Ref. No.	34D7670
description	evaporator L 420mm W 47mm H 300mm		
For models:	JA, JA2, JA2A, JA2M, JAA, JAM, JB, JB2, JB2A, JB2M, JB4A, JB4M, JBA, JBM		



1

GEV No.	750230	Ref. No.	34D3390
description	evaporator L 360mm W 110mm H 200mm		
For models:	K100, K100SL, K100SLV, K100X, K100XA, WM1A, WM1A-2, WM1A-2A, WM1A-2X, WM1A-A, WM1A-X, WM1B, WM1B-2, WM1B-2A, WM1B-2X, WM1B-4, WM1B-4A, WM1B-4X, WM1B-A, WM1B-X		



1

GEV No.	750000	Ref. No.	34D4300
description	evaporator L 730mm W 90mm H 130mm		
For models:	E125, E125-4, E125E, E125PL, E125PLE, E125PV, E125PVX, E125SP, E125X, E125X-4, E125XE, E125XSP, RX150, RX150-3, RX150-4, RX150PV, RX150R		



1

GEV No.	750118	Ref. No.	34D4260
description	evaporator L 410mm W 90mm H 130mm		
For models:	E60, E60-2, E60E, E60PL, E60PLE, E60PV, E60PVX, E60SP, E60X, E60X-2, E60XE, E60XSP, GS140BN2, GS140CP, GS140NCP, GS65BCP, GS65CP, GS65NB, GS65NCP, GS65NN, IMFEN, IMSFEN, RX150BB, RX150BB2, RX150BN, RX150BN2, RX150CP, RX150NCP, RX150NN, RX70, RX70-2, RX70BCP, RX70NB, RX70NCP, RX70NN, RX70PV, RX70R		

condensers

condensers



GEV No.	605131	Ref. No.	34D4831
description	condenser W 260mm D 110mm H 260mm		
For models:	AM03LT7, AM03LT7A, AM03LT7M, AS70B, AX60B, AX70B, DM31, DM31A, DM31C, DM31M, E600B, E600B2, E600BE, E60BE, E60BPLE, E60BXE, F55B, GX60B, GX70B, SX120BN, SX55B, SX65BAX, SX65BE		



GEV No.	750543	Ref. No.	34D6180
description	condenser W 275mm D 100mm H 260mm		
For models:	E600, E6002, E600E, E600PV, E60PV, E60PVX, E60SP, E60X, E60XSP, EM1B, EM1B-2, EM1B-2A, EM1B-2X, EM1B-4, EM1B-4A, EM1B-4X, EM1B-A, EM1B-X, EM1C, EM1C-2, EM1C-2A, EM1C-2X, EM1C-4, EM1C-4A, EM1C-4X, EM1C-6, EM1C-6A, EM1C-6X, EM1C-A, EM1C-X, EXM1B, EXM1B-2, EXM1B-2A, EXM1B-2X, EXM1B-4, EXM1B-4A, EXM1B-4X, EXM1B-A, EXM1B-X, EXM1C, EXM1C-2, EXM1C-2A, EXM1C-2X, EXM1C-4, EXM1C-4A, EXM1C-4X, EXM1C-6, EXM1C-6A, EXM1C-6X, EXM1C-A... (Other models you can see in the webshop)		

evaporation and condensing trays

evaporation trays



GEV No.	750716	Ref. No.	36Z0300
description	evaporation tray L 610mm W 295mm H 50mm		
For models:	AF1L, AF1L7, AF1L7A, AF1L7M, AF2L, AF2S, AM03LT7, AM03LT7A, AM03LT7M, AM1L, AM1L7, AM1L7A, AM1L7M, AM1LM, AM1LR, AM1LT, AM1LT7, AM1LT7A, AM1LT7M, AM1LW, AM2L, AM2LR, AM2LW, AM2S, AM2SR, AM2SW, AT1L, AT1L7, AT1L7A, AT1L7M, DC51, DF51M, DM101L, DM31, DM31A, DM31C, DM31M, DM51, DM51A, DM51C, DM51M, DM51ME, DMG101L, DMG51C, DMG51M, DMG51ME, DMG51ME-0P141, DMS101L, DMS101S, DMS51... (Other models you can see in the webshop)		

miscellaneous



GEV No.	750059	Ref. No.	36Z6471
description	evaporation tray for condenser L 440mm W 357mm		
For models:	N135BN, N65B, N65BPS, P135BN, P65B, SX135BB, SX135BCP, SX135BN, SX65B, SX65B-2, SX65BAX, SX65BE, SX65BR		

hoses

industrial hoses

PU hoses



GEV No.	512475	Ref. No.	3003920
description	dosing hose ED ø 8mm ID ø 6mm polyurethane blue Qty supplied by meter		



GEV No.	510677	Ref. No.	3000290
description	dosing hose ED ø 8mm ID ø 6mm polyurethane red Qty supplied by meter		



fittings, hose and pipe connectors

fittings

angle pieces



1

GEV No.	541494	Ref. No.	33Q0600
description	angle piece thread 3/4" ET - 3/4" IT zinc-coated cast iron		
For models:	ECB, ECB218, ENB, ENB218, ENB75, QE14VB, QE21VB, QI14VB, QI21VB, QL14CVB, QL14NVB, QL21CVB, QL21NVB, QL7NVB, SVB, SVB218		

hose connectors

producer-specific



1

GEV No.	541490	Ref. No.	33Q0590
description	hose connector thread 1/2" grommet ø 15mm		
For models:	ECB, ECB218, ENB75, QL14CVB, QL21CVB, QL7NVB		

valves and tank inlets

accessories

turning handles



1

GEV No.	540691	Ref. No.	36M2640
description	hood handle for valve red		
For models:	ECB, ECB218, ENB, ENB218, ENB75, QE14VB, QE21VB, QI14VB, QI21VB, QL14CVB, QL14NVB, QL21CVB, QL21NVB, QL7NVB, SVB, SVB218		

fastening material

washers

washers

miscellaneous



1

GEV No.	690687	Ref. No.	36D2880
description	plain washer		
For models:	F40, F40B, F40CP, F40CPX, F40PLA, F40PLE, F40X, K100, K100SL, K100SLV, K100X, K100XA		

A			
axial fans	20	indicator lights	8
C		indicator lights (complete)	8
cold air circulating fans (complete)	24	industrial hoses	48
compressors	19	L	
condensators & interference suppression filters	25	lamp accessories	9
condensing trays heated	20	lamps	8
contactors	10	light bulbs	8
control thermostats	5	M	
cross flow fans	24	magnetic switches	7
D		microswitches	7
defrost timers	10	O	
door catches	30	operating capacitors	25
E		O-rings	46
edgemount latches	30	oven lamps	8
electric accessories	26	P	
electronic controllers	11	plug connectors	26
evaporators	46	plug-in gaskets	40
expansion valves	46	pressure switches	19
F		probes	15
fans	20	programme timers	9
fastening material	49	PU hoses	48
filter driers	46	R	
fittings	49	refrigeration cycle components	46
forced air burners	27	refrigeration fans	21
fridge lamps	8	refrigeration gaskets	40
G		refrigeration motors universal	21
gas burners	27	refrigeration thermostats	5
grates	37	relays	10
H		rocker/momentary rocker switches	6
handle latches	30	S	
heating cables	3	screw-in gaskets	45
heating cartridges	4	shelves and shelf rails	37
heating elements	3	solenoid valves	18
heating elements for bain maries	3	spring assisted hinges	30
heating elements for convection	4	starting capacitors	25
heating elements for defrosting	3	switches and momentary switches	6
heating elements for pasta cookers	3	T	
heating elements for refrigeration	3	temperature probes	15
hose connectors	49	terminals	26
hoses	48	terminals and connectors	26
hot air fans	25	thermostats	5
I		timers	9
ignition cables	27	transformers	11
immersion heating elements	4	U	
		universal probes	15

V

valves and tank inlets 49

W

washers 49