



**GAS COMPONENTS**



**ELECTRIC COMPONENTS**



**WATER TECHNOLOGY**



**MECHANICAL COMPONENTS**



**TOOLS**

Spare parts suitable for

**SALVIS**

Find the complete and up-to-date range of products in our GEV Webshop



# Manufacturer catalogue

The most important spare parts and accessories arranged clearly for every manufacturer

- ✓ Complete product range and all appliance data always up to date in the GEV Webshop
- ✓ Alphabetical Index at the end of the catalogue

## GEV Webshop

[www.gev-online.co.uk](http://www.gev-online.co.uk)

[www.gev-online.com](http://www.gev-online.com)



- 🔍 Add to Favourites
- 🔍 Sign In with email address and usual password
- 🔍 Easy-order – place several items in your basket at the same time
- 🔍 Quick Item search – no login needed



## heating elements

### heating elements for chip scuttles

			
<b>GEV No.</b>	418465	<b>Ref. No.</b>	178980 1G592028
<b>description</b>	heating element 800W 230V heating circuits 1 L 370mm W 95mm connection male faston 6.3mm tube ø 6.3mm dry heating element connection distance 89mm		

### heating elements for fryers

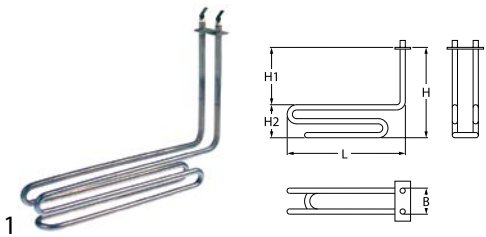
			
<b>GEV No.</b>	418460	<b>Ref. No.</b>	178613 1G592018
<b>description</b>	heating element 2000W 230V heating circuits 1 L 280mm W 42mm H 200mm rectangular flange connection male faston 6.3mm H1 146mm H2 54mm hole ø 5mm flange length 48mm flange width 18mm fryer		

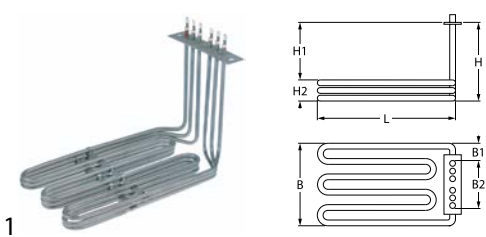
			
<b>GEV No.</b>	418474	<b>Ref. No.</b>	1G564035 689297
<b>description</b>	heating element 6000W 230/400V heating circuits 3 L 285mm W 155mm H 173mm rectangular flange connection male faston 6.3mm immersion heater W1 32.5mm W2 90mm H1 151mm H2 22mm hole distance 124mm hole ø 8mm flange length 136mm flange width 30mm tube ø 6.5mm connection length 33mm		

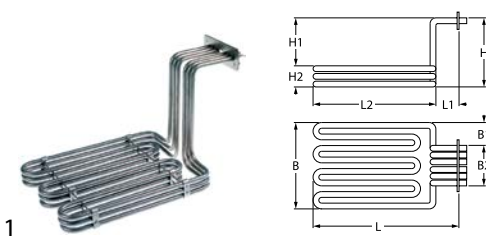
			
<b>GEV No.</b>	418461	<b>Ref. No.</b>	178871
<b>description</b>	heating element 6000W 230/400V heating circuits 3 L 357mm W 208mm H 210mm L1 77mm L2 283mm W1 67mm W2 74mm H1 178mm H2 32mm windings 9 flange length 100mm flange width 40mm hole distance 83mm connection male faston 6.3mm mounting thread M5 tube ø 8.5mm rectangular flange immersion heater		

### heating elements for griddles

			
<b>GEV No.</b>	418575	<b>Ref. No.</b>	1V421471
<b>description</b>	heating element 100W 230V heating circuits 1 L 94mm W 68mm tube ø 6.5mm cable length 70mm connection length 20mm dry heating element		

			
<b>GEV No.</b>	418463	<b>Ref. No.</b>	1G563025
<b>description</b>	heating element 3300W 400V heating circuits 1 L 420mm W 255mm H 45mm tube ø 6.5mm cable length 450mm connection length 23mm connection distance 249mm dry heating element		

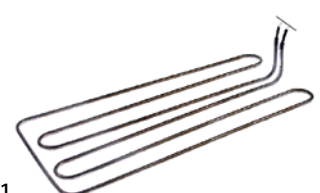
			
<b>GEV No.</b>	418435	<b>Ref. No.</b>	178859 1G70069 1G870069
<b>description</b>	heating element 3500W 230V heating circuits 1 L 460mm W 233mm H 73mm tube ø 6.3mm cable length 1050mm connection length 25mm griddle dry heating element		

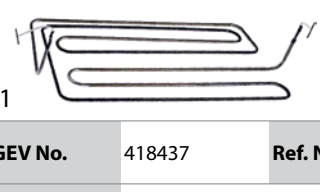
			
<b>GEV No.</b>	418437	<b>Ref. No.</b>	178996 1G870136
<b>description</b>	heating element 3500W 380V heating circuits 1 L 478mm W 250mm H 70mm tube ø 6.3mm cable length 115mm mounting pos. right griddle dry heating element		

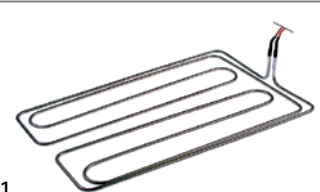
			
<b>GEV No.</b>	418434	<b>Ref. No.</b>	178993 1G870133
<b>description</b>	heating element 3500W 380V heating circuits 1 L 480mm W 310mm H 70mm tube ø 6.5mm cable length 550mm connection length 35mm griddle dry heating element		



1 			
<b>GEV No.</b>	418406	<b>Ref. No.</b>	178857 1G870071
<b>description</b>	heating element 3500W 400V heating circuits 1 L 455mm W 287mm H 77mm tube ø 6.5mm cable length 1100mm dry heating element		

1 			
<b>GEV No.</b>	418436	<b>Ref. No.</b>	178995 1G870135 BK178995
<b>description</b>	heating element 3500W 400V heating circuits 1 L 480mm W 250mm H 70mm tube ø 6.5mm cable length 115mm mounting pos. left griddle dry heating element		

1 			
<b>GEV No.</b>	419015	<b>Ref. No.</b>	1G592028
<b>description</b>	heating element 800W 230V heating circuits 1 L 365mm W 108mm tube ø 6.5mm connection male faston 6.3mm connection length 20mm connection distance 102mm dry heating element		

## heating elements for large hobs

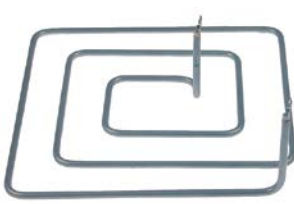
1 			
<b>GEV No.</b>	418485	<b>Ref. No.</b>	1G532081
<b>description</b>	heating element 1100W 400V L 258mm W 258mm H 82mm heating circuits 1 tube ø 6.5mm mounting pos. centre/inside connection length 20mm connection M4 dry heating element		

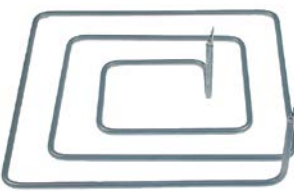
1 			
<b>GEV No.</b>	418484	<b>Ref. No.</b>	1G532080
<b>description</b>	heating element 1300W 400V L 284mm W 284mm H 81mm heating circuits 1 tube ø 6.5mm mounting pos. centre/outside connection length 20mm connection M4 dry heating element		

1 			
<b>GEV No.</b>	418483	<b>Ref. No.</b>	1G532079
<b>description</b>	heating element 650W 400V L 315mm W 315mm H 80mm heating circuits 1 tube ø 6.5mm mounting pos. outer connection length 20mm connection M4 dry heating element		

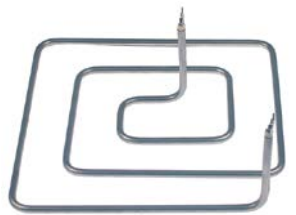
1 			
<b>GEV No.</b>	418486	<b>Ref. No.</b>	1G532082
<b>description</b>	heating element 900W 400V L 230mm W 230mm H 81mm heating circuits 1 tube ø 6.5mm mounting pos. inner connection length 20mm connection M4 dry heating element		

## heating elements for salamanders/toast-

1 			
<b>GEV No.</b>	419184	<b>Ref. No.</b>	1E409100
<b>description</b>	heating element 2000W 230V heating circuits 1 L 205mm W 262mm W2 305mm flange length 26mm flange width 11mm tube ø 4mm connection length 36mm dry heating element connection F6.3 salamander grill H 4mm		

1 			
<b>GEV No.</b>	415541	<b>Ref. No.</b>	10279801
<b>description</b>	heating element 2000W 230V heating circuits 1 mounting pos. left L 250mm W 210mm H 120mm W2 170mm connection distance 164mm tube ø 6.3mm cable length 500mm dry heating element salamander grill		

1

<b>GEV No.</b>	415540	<b>Ref. No.</b>	10279802
<b>description</b>	heating element 2000W 230V heating circuits 1 mounting pos. right L 250mm W 210mm H 120mm W2 170mm connection distance 164mm tube ø 6.5mm cable length 500mm dry heating element salamander grill		

bottom heaters





1

<b>GEV No.</b>	390410	<b>Ref. No.</b>	1G963100
<b>description</b>	bi-metal safety thermostat hole distance 24mm switch-off temp. 200°C 1NC 1-pole 16A connection F6.3 2 hole fixing		



1

<b>GEV No.</b>	418429	<b>Ref. No.</b>	1G564207	
<b>description</b>	bottom heater 1800W 230V heating circuits 1 ø 196mm safety thermostat 250°C M5 mounting distance 180mm			
<b>spare parts for</b>	418429			
	<b>GEV No.</b>	375137	<b>Ref. No.</b>	—
	safety thermostat switch-off temp. 250°C 1-pole 16A probe ø 3.03mm probe L 160mm capillary pipe 880mm capillary pipe isolated 800mm gland nut probe SS with curved probe			







1

<b>GEV No.</b>	418473	<b>Ref. No.</b>	1G963111
<b>description</b>	bottom heater 1800W 230V heating circuits 1 ø 196mm safety thermostat°C M5 mounting distance 180mm		





1

<b>GEV No.</b>	418466	<b>Ref. No.</b>	1G963110	
<b>description</b>	bottom heater 1800W 230V heating circuits 1 ø 196mm thermostat 128°C M5 mounting distance 180mm			
<b>spare parts for</b>	418466			
	<b>GEV No.</b>	375782	<b>Ref. No.</b>	—
	thermostat t.max. 128°C temperature range 30-128°C 1-pole 1NO 16A probe ø 3.03mm probe L 178mm capillary pipe 870mm capillary pipe isolated 800mm gland nut shaft ømm shaft L 23mm shaft position upper rotation 270° outer switch 2NO with curved probe			
	<b>GEV No.</b>	520323	<b>Ref. No.</b>	1G963116 721921 963116
	gasket ID ø 160mm ED ø 200mm hole distance 90/180mm hole ø 7mm silicone for bottom heaters			
<b>accessories for</b>	418466			
	<b>GEV No.</b>	520323	<b>Ref. No.</b>	1G963116 721921 963116
	gasket ID ø 160mm ED ø 200mm hole distance 90/180mm hole ø 7mm silicone for bottom heaters			









1

<b>GEV No.</b>	418467	<b>Ref. No.</b>	1G564199 726672	
<b>description</b>	bottom heater 1800W 230V heating circuits 2 ø 196mm safety thermostat 250°C thermostat 105°C M5 mounting distance 180mm			
<b>spare parts for</b>	418467			
	<b>GEV No.</b>	375137	<b>Ref. No.</b>	—
	safety thermostat switch-off temp. 250°C 1-pole 16A probe ø 3.03mm probe L 160mm capillary pipe 880mm capillary pipe isolated 800mm gland nut probe SS with curved probe			
	<b>GEV No.</b>	375794	<b>Ref. No.</b>	—
	thermostat t.max. 105°C temperature range 30-105°C 1-pole 1NO 16A probe ø 3.03mm probe L 178mm capillary pipe 870mm capillary pipe isolated 800mm gland nut shaft ø6x4.6mm shaft L 23mm shaft position upper rotation 270° outer switch 2NO with curved probe			
<b>accessories for</b>	418467			
	<b>GEV No.</b>	520323	<b>Ref. No.</b>	1G963116 721921 963116
	gasket ID ø 160mm ED ø 200mm hole distance 90/180mm hole ø 7mm silicone for bottom heaters			







			
1			
<b>GEV No.</b>	418482	<b>Ref. No.</b>	1G564209
<b>description</b>	bottom heater 2000W 400V heating circuits 1 $\varnothing$ 196mm safety thermostat 250°C thermostat 128°C M5 H 5mm mounting distance 180mm connection male faston 6.3mm		
<b>spare parts for</b>	418482		
	<b>GEV No.</b>	375137	<b>Ref. No.</b> —
	safety thermostat switch-off temp. 250°C 1-pole 16A probe $\varnothing$ 3.03mm probe L 160mm capillary pipe 880mm capillary pipe isolated 800mm gland nut probe SS with curved probe		
	<b>GEV No.</b>	375782	<b>Ref. No.</b> —
	thermostat t.max. 128°C temperature range 30-128°C 1-pole 1NO 16A probe $\varnothing$ 3.03mm probe L 178mm capillary pipe 870mm capillary pipe isolated 800mm gland nut shaft $\varnothing$ mm shaft L 23mm shaft position upper rotation 270° outer switch 2NO with curved probe		







			
1			
<b>GEV No.</b>	419008	<b>Ref. No.</b>	1G564319 834963
<b>description</b>	bottom heater 3000W 400V heating circuits 2 $\varnothing$ 196mm safety thermostat 250°C thermostat 128°C M5 H 180mm		
<b>spare parts for</b>	419008		
	<b>GEV No.</b>	375137	<b>Ref. No.</b> —
	safety thermostat switch-off temp. 250°C 1-pole 16A probe $\varnothing$ 3.03mm probe L 160mm capillary pipe 880mm capillary pipe isolated 800mm gland nut probe SS with curved probe		
	<b>GEV No.</b>	375782	<b>Ref. No.</b> —
	thermostat t.max. 128°C temperature range 30-128°C 1-pole 1NO 16A probe $\varnothing$ 3.03mm probe L 178mm capillary pipe 870mm capillary pipe isolated 800mm gland nut shaft $\varnothing$ mm shaft L 23mm shaft position upper rotation 270° outer switch 2NO with curved probe		

## heating plates

			
1			
<b>GEV No.</b>	418438	<b>Ref. No.</b>	178987 1G592036 BK178987
<b>description</b>	hot plate 700W 230V heating circuits 1 cable length 750mm L 480mm W 80mm		

## heating elements for convection

			
1			
<b>GEV No.</b>	419052	<b>Ref. No.</b>	10177222
<b>description</b>	heating element 1600W 230V heating circuits 1 ID $\varnothing$ 220mm ED $\varnothing$ 250mm L 345mm L1 100mm thread M10x1 connection male faston 6.3mm tube $\varnothing$ 6.5mm convection heating element for combi-steamer		

			
1			
<b>GEV No.</b>	418690	<b>Ref. No.</b>	10295641
<b>description</b>	heating element 2000W 230V L 90mm W 390mm connection F 6.3 tube $\varnothing$ 8.5mm M14x1.5 mounting distance 390mm		
<b>accessories for</b>	418690		
	<b>GEV No.</b>	510417	<b>Ref. No.</b> —
	flat gasket fibre ED $\varnothing$ 20mm ID $\varnothing$ 14mm thickness 2mm Qty 1 pcs		
	<b>GEV No.</b>	520228	<b>Ref. No.</b> —
	tooth lock washer ID $\varnothing$ 15.3mm ED $\varnothing$ 24mm steel Qty 1 pcs for thread M14		
	<b>GEV No.</b>	520230	<b>Ref. No.</b> —
	nut thread M14x1.5 H 5mm WS 19 zinc-coated steel Qty 1 pcs		
	<b>GEV No.</b>	521101	<b>Ref. No.</b> —
	nut thread M14x1.5 H 5mm WS 19 SS Qty 1 pcs		
	<b>GEV No.</b>	550262	<b>Ref. No.</b> —
	flat gasket copper ED $\varnothing$ 20mm ID $\varnothing$ 14mm thickness 2mm		

## radiation heaters

			
1			
<b>GEV No.</b>	490148	<b>Ref. No.</b>	1G962926
<b>description</b>	radiation heater rectangular 2500W 400V without pan detection L 300mm W 570mm heating circuits 2 EGO		

			
1			
<b>GEV No.</b>	490147	<b>Ref. No.</b>	1G962922
<b>description</b>	radiation heater rectangular 3500W 230V with pan detection L 300mm W 570mm heating circuits 2 EGO		

1

<b>GEV No.</b>	490198	<b>Ref. No.</b>	1E409101 409.101
<b>description</b>	radiation heater rectangular flange 2300W 230V L 320mm W 230mm H 35mm heating circuits 1 EGO		

1-circuit



1

<b>GEV No.</b>	490131	<b>Ref. No.</b>	1G962948
<b>description</b>	radiation heater ø 250mm 2500W 400V heating circuits 1 energy regulation with temperature signalization with ribbon heater connections 2+2 connection type male faston 6.3mm EGO		

foil heating elements



1

<b>GEV No.</b>	418472	<b>Ref. No.</b>	1G962947 689653
<b>description</b>	foil heating element L 400mm W 230mm 175W 230V aluminium cable length 490mm thickness 3mm		

accessories

flange gaskets



1

<b>GEV No.</b>	520324	<b>Ref. No.</b>	1G963115	
<b>description</b>	counterflange ID ø 160mm ED ø 200mm hole distance 90/180mm hole ø 7mm SS for bottom heaters			
<b>accessories for</b>	520324			
	<b>GEV No.</b>	520323	<b>Ref. No.</b>	1G963116 721921 963116
	gasket ID ø 160mm ED ø 200mm hole distance 90/180mm hole ø 7mm silicone for bottom heaters			



1

<b>GEV No.</b>	520323	<b>Ref. No.</b>	1G963116 721921
<b>description</b>	gasket ID ø 160mm ED ø 200mm hole distance 90/180mm hole ø 7mm silicone for bottom heaters		

counterflanges



1

<b>GEV No.</b>	520324	<b>Ref. No.</b>	1G963115	
<b>description</b>	counterflange ID ø 160mm ED ø 200mm hole distance 90/180mm hole ø 7mm SS for bottom heaters			
<b>accessories for</b>	520324			
	<b>GEV No.</b>	520323	<b>Ref. No.</b>	1G963116 721921 963116
	gasket ID ø 160mm ED ø 200mm hole distance 90/180mm hole ø 7mm silicone for bottom heaters			

energy regulators

EGO

1-circuit



1

<b>GEV No.</b>	380015	<b>Ref. No.</b>	1G962529 314544
<b>description</b>	energy regulator 230V 13A single-circuit turn direction right shaft ø 6x4.6mm shaft L 23mm mounting thread M4 power release 6-100% no. 50.57021.010		

thermostats

bi-metal thermostats

safety bi-metal thermostats



1

<b>GEV No.</b>	390410	<b>Ref. No.</b>	1G963100
<b>description</b>	bi-metal safety thermostat hole distance 24mm switch-off temp. 200°C 1NC 1-pole 16A connection F6.3 2 hole fixing		

bi-metal thermostats



<b>GEV No.</b>	390592	<b>Ref. No.</b>	1V421472
<b>description</b>	bi-metal thermostat hole distance 24mm switch-off temp. 100°C 1NC 1-pole 2 hole fixing		

control and safety thermostats



EGO

control thermostats

55.13\_ series



<b>GEV No.</b>	375007	<b>Ref. No.</b>	178983
<b>description</b>	thermostat t.max. 110°C temperature range 30-110°C 1-pole 1NO 16A probe ø 6mm probe L 113mm capillary pipe 870mm capillary pipe isolatedmm gland nut M9x1 shaft L 25mm shaft position upper rotation 270°		

<b>accessories for</b>	375007			
	<b>GEV No.</b>	110119	<b>Ref. No.</b>	—
	knob thermostat t.max. 110°C ø 50mm shaft ø 6x4.6mm shaft flat upper black temperature range 30-110°C rotation 270°			
	<b>GEV No.</b>	110241	<b>Ref. No.</b>	—
	knob thermostat t.max. 110°C ø 50mm shaft ø 6x4.6mm shaft flat upper black temperature range 30-110°C			

safety thermostats

55.11\_ series



<b>GEV No.</b>	375790	<b>Ref. No.</b>	178610 178882 BK178610
<b>description</b>	safety thermostat switch-off temp. 273°C 1-pole 16A probe ø 6mm probe L 77mm capillary pipe 400mm capillary pipe isolatedmm gland nut probe SS		

55.13\_ series



<b>GEV No.</b>	375784	<b>Ref. No.</b>	178982
<b>description</b>	safety thermostat switch-off temp. 140°C 1-pole 16A probe ø 6mm probe L 77mm capillary pipe 870mm capillary pipe isolated 790mm gland nut probe SS		

55.32\_ series



<b>GEV No.</b>	375787	<b>Ref. No.</b>	1G962526
<b>description</b>	safety thermostat switch-off temp. 380°C 2-pole 20A probe ø 4mm probe L 163mm capillary pipe 1190mm capillary pipe isolated 800mm gland nut probe SS		

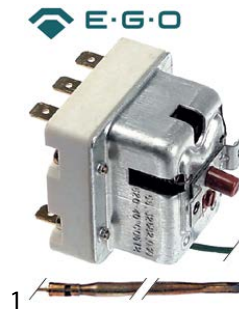

<b>GEV No.</b>	375681	<b>Ref. No.</b>	619221
<b>description</b>	safety thermostat switch-off temp. 520°C 3-pole 20A probe ø 3.9mm probe L 228mm capillary pipe 890mm capillary pipe isolated 400mm gland nut		





55.33\_series



<b>GEV No.</b>	375781	<b>Ref. No.</b>	1G962532 689300
<b>description</b>	safety thermostat switch-off temp. 275°C 3-pole 20A probe ø 4mm probe L 157mm capillary pipe 870mm capillary pipe isolated 350mm gland nut probe SS		

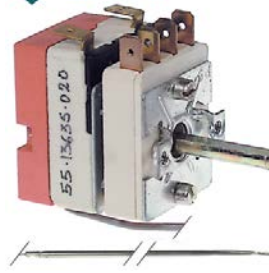

<b>GEV No.</b>	375780	<b>Ref. No.</b>	1G962531
<b>description</b>	thermostat temperature range 120-190°C 1-pole 1NO 16A probe ø 3mm probe L 248mm capillary pipe 1730mm capillary pipe isolated 1660mm gland nut shaft ø 6x4.6mm shaft L 23mm shaft position upper rotation 270° outer switch 2NO		

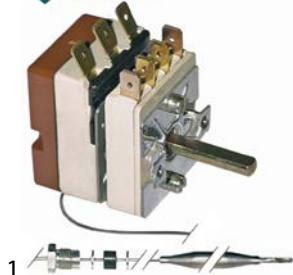

control thermostats with operation switch

55.13\_series



<b>GEV No.</b>	375406	<b>Ref. No.</b>	1G873027
<b>description</b>	thermostat t.max. 110°C temperature range 30-110°C 1-pole 1CO 16A probe ø 6mm probe L 113mm capillary pipe 2380mm capillary pipe isolated 1700mm gland nut M9x1 shaft ø 6x4.6mm shaft L 18mm shaft position upper rotation 270° outer switch 2NO		

accessories for 375406

	<b>GEV No.</b>	110545	<b>Ref. No.</b>	—
	knob dial plate silver thermostat t.max. 110°C 30-110°C rotation 310° ED ø 59mm ID ø 45.5mm			
	<b>GEV No.</b>	112173	<b>Ref. No.</b>	—
	knob universal ø 62mm black without adaptor/dial plate			
	<b>GEV No.</b>	112311	<b>Ref. No.</b>	—
	knob adapter shaft ø 6x4.6mm L 0mm with spring			

55.34\_series

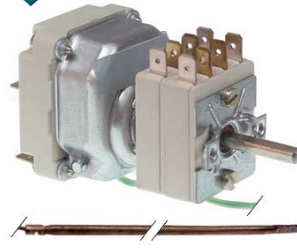

<b>GEV No.</b>	375691	<b>Ref. No.</b>	619248
<b>description</b>	thermostat t.max. 390°C temperature range 60-390°C 3-pole 3NO 16A probe ø 3.9mm probe L 228mm capillary pipe 1110mm capillary pipe isolated 600/700mm gland nut shaft ø 6x4.6mm shaft L 23mm shaft position upper rotation 270° outer switch 2NO/2NO		

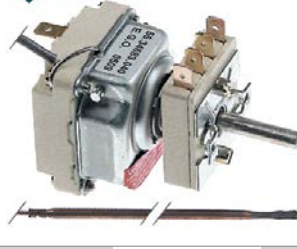

<b>GEV No.</b>	375570	<b>Ref. No.</b>	179312
<b>description</b>	thermostat t.max. 470°C temperature range 100-470°C 1-pole 1NO 16A probe ø 3.9mm probe L 228mm capillary pipe 1110mm capillary pipe isolated 600mm gland nut shaft ø 6x4.6mm shaft L 24mm shaft position upper rotation 270° outer switch 2NO		

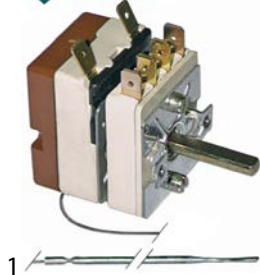

<b>GEV No.</b>	375408	<b>Ref. No.</b>	1G873056 689599
<b>description</b>	thermostat t.max. 320°C temperature range 50-320°C 1-pole 1NO 16A probe ø 3.03mm probe L 160mm capillary pipe 1150mm capillary pipe isolatedmm gland nut shaft ø 6x4.6mm shaft L 23mm shaft position upper rotation 270° outer switch 2NO		



<b>GEV No.</b>	375140	<b>Ref. No.</b>	179302
<b>description</b>	thermostat t.max. 650°C temperature range 50°C/50-600°C/70-650°C 3-pole 3NO 16A probe ø 4mm probe L 228mm capillary pipe 1200mm capillary pipe isolated 1200mm gland nut shaft ø 6x4.6mm shaft L 23mm shaft position left rotation 318° outer switch 2NO		





## switches and momentary switches

### rocker/momentary rocker switches

30x22mm			
			
1			
<b>GEV No.</b>	346899	<b>Ref. No.</b>	1V420303
<b>description</b>	rocker switch mounting measurements 30x22mm yellow 2NO 230V 16A illuminated 0-1 connection male faston 6.3mm ambient temperature max. 125/55°C protection IP65 with rubber collar		

### push/momentary push switches

ø12mm			
			
1			
<b>GEV No.</b>	346594	<b>Ref. No.</b>	1G564257
<b>description</b>	momentary push switch mounting ø 12mm black 1NO 250V 4A connection male faston 6.3mm ambient temperature max. 85°C protection IP40		

			
1			
<b>GEV No.</b>	346583	<b>Ref. No.</b>	178883
<b>description</b>	push switch mounting ø 12mm black 1NO 250V 6A connection male faston 4.8mm ambient temperature max. 100/55°C protection IP40		

### microswitches

#### pin-plunger actuated

M10			
			
1			
<b>GEV No.</b>	348013	<b>Ref. No.</b>	10279075 279-075
<b>description</b>	microswitch with plunger thread M10x0.75 thread L 20mm 250V 6A 1NO connection cable stroke 5.8mm mounting distance 22mm ambient temperature max. 125°C for door actuating force: 360g		

### mercury tilt switches

			
1			
<b>GEV No.</b>	346582	<b>Ref. No.</b>	178612 1G594020
<b>description</b>	mercury tilt switch		

### cam switches

#### on/off

			
1			
<b>GEV No.</b>	300074	<b>Ref. No.</b>	178843 1G960702
<b>description</b>	cam switch 4 operating positions 2NO sequence 0-1-0-1 16A shaft ø 6x4.6mm shaft L 23mm connection male faston 6.3mm ceramic		

#### 7-position

				
1				
<b>GEV No.</b>	300025	<b>Ref. No.</b>	178851	
<b>description</b>	cam switch 7 operating positions 1NO/2CO sequence 0-1-2-3-4-5-6 16A shaft ø 6x4.6mm shaft L 23mm connection screw 7-position ceramic			
<b>accessories for</b>	300025			
	<b>GEV No.</b>	112172	<b>Ref. No.</b>	—
knob universal ø 70mm black without adaptor/dial plate				
	<b>GEV No.</b>	112213	<b>Ref. No.</b>	—
knob dial plate silver switch 7-position t.max.°C ED ø 63mm ID ø 45.5mm				
	<b>GEV No.</b>	112311	<b>Ref. No.</b>	—
knob adapter shaft ø 6x4.6mm L 0mm with spring				



5 operating positions



1

<b>GEV No.</b>	345199	<b>Ref. No.</b>	10279800 720534
<b>description</b>	cam switch 5 operating positions 2NO/1CO sequence 0-1-2-3-4 16A shaft ø 6x4.6mm shaft L 23mm connection male faston 6.3mm		



1

<b>GEV No.</b>	347708	<b>Ref. No.</b>	1E409312
<b>description</b>	cam switch shaft ø 6x4.6mm shaft L 23.5mm connection male faston 6.3mm 3-pole conversion kit		
<b>spare parts for</b>	347708		
	<b>GEV No.</b>	301319	<b>Ref. No.</b>
			1E409103 409103
<b>description</b>	cam switch 16A shaft ø 6x4.6mm shaft L 23mm connection male faston 6.3mm plastic		

10 operating positions



1

<b>GEV No.</b>	348183	<b>Ref. No.</b>	1G960000
<b>description</b>	cam switch 10 operating positions sequence 0-1-2-3-4-5-6-7-8-9 16A shaft ø 6x4.6mm shaft L 23mm connection male faston 6.3mm		

miscellaneous



1

<b>GEV No.</b>	301319	<b>Ref. No.</b>	1E409103
<b>description</b>	cam switch 16A shaft ø 6x4.6mm shaft L 23mm connection male faston 6.3mm plastic		

control equipment

lamps



1

<b>GEV No.</b>	359896	<b>Ref. No.</b>	1G887026
<b>description</b>	neon light bulb socket Ba9s 230V green ø 10mm L 28mm		

lamps

indicator lights

indicator lights 3-piece (housing, lens and bulb)

ø18.2mm



1

<b>GEV No.</b>	359855	<b>Ref. No.</b>	178839
<b>description</b>	indicator light housings mounting measurements ø18.2mm socket Ba9s green		

lamps

neon light bulbs



1

<b>GEV No.</b>	359896	<b>Ref. No.</b>	1G887026
<b>description</b>	neon light bulb socket Ba9s 230V green ø 10mm L 28mm		

indicator lights (complete)

ø10mm

with plug-in socket



1

<b>GEV No.</b>	359139	<b>Ref. No.</b>	10177681 177.681
<b>description</b>	indicator light ø 10mm green 230V connection male faston 6.3mm Qty 1 pcs		



1

<b>GEV No.</b>	359138	<b>Ref. No.</b>	10177680
<b>description</b>	indicator light ø 10mm red 230V connection male faston 6.3mm Qty 1 pcs		



ø16mm

with plug-in socket



1

<b>GEV No.</b>	359909	<b>Ref. No.</b>	178985 1G887032 BK178985
<b>description</b>	indicator light ø 16mm 230V green cable length 200mm cable material silicone wire		



1

<b>GEV No.</b>	359908	<b>Ref. No.</b>	178999
<b>description</b>	indicator light ø 16mm 230V yellow cable length 200mm cable material silicone wire		



1

<b>GEV No.</b>	359094	<b>Ref. No.</b>	1G962017
<b>description</b>	indicator light ø 16mm 400V yellow cable length 200mm cable material silicone wire		

## screw-on/push-on fit

## neon light bulbs



1

<b>GEV No.</b>	359896	<b>Ref. No.</b>	1G887026
<b>description</b>	neon light bulb socket Ba9s 230V green ø 10mm L 28mm		

## timers

## mechanical timers



1

<b>GEV No.</b>	360534	<b>Ref. No.</b>	1E409147 409.147
<b>description</b>	timer 600 with bell 2-pole operation time 15min impulse mechanical 2NO at 250V 16A shaft ø 6x4.6mm shaft L 22mm with bell mounting distance 29mm connection male faston 6.3mm DIEHL ambient temperature max. 85°C		

## audible timers



1

<b>GEV No.</b>	350014	<b>Ref. No.</b>	10279803
<b>description</b>	audible timer operation time 15min ø 56mm shaft ø 6x4.6mm shaft L 24mm mounting distance 28mm		

## contactors

## ABB

## power contactors



1

<b>GEV No.</b>	380104	<b>Ref. No.</b>	10279788 523909
<b>description</b>	power contactor resistive load 25A 230VAC (AC3/400V) 9A/4kW main contacts 3NO auxiliary contacts 1NO connection screw connection type A9-30-10		

## solid state relays

## CRYDOM



1

<b>GEV No.</b>	401563	<b>Ref. No.</b>	1G533279
<b>description</b>	solid state relay CRYDOM 1 phase 50A 600V 4-32VDC L 59mm W 46mm screw type HD4850-10		
<b>accessories for</b>	401563		
	<b>GEV No.</b>	401564	<b>Ref. No.</b>
			1G946000 946000
	heat-conducting foil L 62mm W 45mm for solid state relay		





heat-conducting foils



1

<b>GEV No.</b>	401564	<b>Ref. No.</b>	1G946000
<b>description</b>	heat-conducting foil L 62mm W 45mm for solid state relay		

relays

power relays

with bracket mounting



1

<b>GEV No.</b>	380403	<b>Ref. No.</b>	1G962019
<b>description</b>	power relays FINDER 230VAC 16A 3CO connection F6.3 bracket mounting manuf. no. 62.83.8.230.0500		



1

<b>GEV No.</b>	380185	<b>Ref. No.</b>	1V420302
<b>description</b>	power relays Italiana Relè 230VAC 30A 1NO connection F6.3 bracket mounting dimensions 36.5x32.2x51.8mm manuf. no. A10-230AC-FA		

electronic controllers

LAE

refrigeration controllers

built-in version



1

<b>GEV No.</b>	379852	<b>Ref. No.</b>	1K267923
<b>description</b>	electronic controller LAE type AT1-5AS4D-G mounting measurements 71x29mm 12V voltage AC/DC NTC/PTC relay outputs 2 NO-16A(5) NO-4A(1) NTC/PTC front measurements 77x35mm built-in depth 70mm protection IP55 accuracy 1% defr. funct. -50 to +120°C display 3 digits		



1

<b>GEV No.</b>	378043	<b>Ref. No.</b>	1K267923 old
<b>description</b>	electronic controller LAE type SDU12T0RD mounting measurements 71x29mm 12V voltage AC/DC PTC relay outputs 1 relay protection IP54 -19 up to +99°C compressor relay 5A		

probes

universal probes

temperature probes



1

<b>GEV No.</b>	379860	<b>Ref. No.</b>	1V421494
<b>description</b>	temperature probe NTC 10kOhm cable PVC probe -20 up to +80°C cable -10 up to 100°C probe ø6x40mm cable length 1.5m without screw connection 2-wire		

producer-specific probes

probes



1



<b>GEV No.</b>	379880	<b>Ref. No.</b>	178881
<b>description</b>	temperature probe NTC 900kOhm cable silicone probe -40 up to +150°C cable -50 up to +180°C connection male faston thread probe ø6x80/170mm cable length 0.4m		



1

<b>GEV No.</b>	379879	<b>Ref. No.</b>	178611 BK178611
<b>description</b>	temperature probe NTC 900kOhm cable silicone probe -40 up to +150°C cable -50 up to +180°C connection male faston thread probe ø6x80/170mm cable length 0.65m		



1 			
<b>GEV No.</b>	379882	<b>Ref. No.</b>	1G943000
<b>description</b>	temperature probe thermocouple K (NiCr-Ni) cable glass fibre probe -50 up to 1150°C cable -50 up to +350°C connection 2-wire probe ø4x20mm		
<b>accessories for</b>	379882		
	<b>GEV No.</b>	379881	<b>Ref. No.</b> 1G534536 534536
bayonet adapter L 66mm thread M6x1 ID ø 7/4mm ED ø 12mm			

accessories

adapters

1 			
<b>GEV No.</b>	379881	<b>Ref. No.</b>	1G534536
<b>description</b>	bayonet adapter L 66mm thread M6x1 ID ø 7/4mm ED ø 12mm		

electronics

PCBs

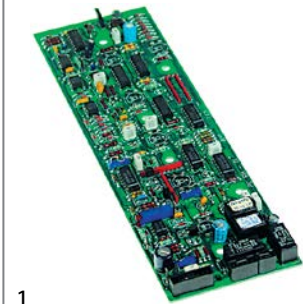
1 			
<b>GEV No.</b>	401516	<b>Ref. No.</b>	178616 BK178616
<b>description</b>	keypad PCB L 250mm W 75mm		

1 			
<b>GEV No.</b>	401562	<b>Ref. No.</b>	1G534537
<b>description</b>	PCB		

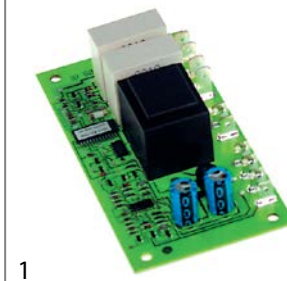
1 			
<b>GEV No.</b>	400411	<b>Ref. No.</b>	179303
<b>description</b>	PCB pyroceram range CH 40/45/80 230V		

solenoid valves

solenoid valves (water)

metal			
ASCO			
spare parts and accessories			
solenoid coils			

1 			
<b>GEV No.</b>	371113	<b>Ref. No.</b>	278270 BK278270
<b>description</b>	solenoid coil Asco 230VAC 50Hz coil type 400526-117 seat ø 16mm		

fans

cross flow fans

ebm-papst

1 			
<b>GEV No.</b>	601437	<b>Ref. No.</b>	1V422429
<b>description</b>	cross flow fan ebm-papst QLZ06/1800-2518 roller ø 60mm roller length 180mm laminated core thickness 18mm motor position right 230V/50Hz 28W refrigeration bearing rubber connection male faston 6.3mm airflow 130m³/h 0 up to +60°C		



hot air motors



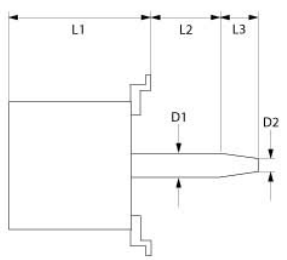

1

<b>GEV No.</b>	499186	<b>Ref. No.</b>	293474 BK293474
<b>description</b>	fan motor 230V 1 phase 50Hz 0.32kW 1320rpm L1 170mm L2 33mm L3 34mm M10x1.5 2.3A suitable capacitor 25µF D1 ø 17mm D2 ø 13.5mm with plug		

hot air fans

miscellaneous



1

<b>GEV No.</b>	500128	<b>Ref. No.</b>	295.101 BK295101
<b>description</b>	hot air fan 230V 120W 0.53A 2000rpm L2 135mm L3 35mm L4 40mm fan wheel ø 180mm ebm-papst type R2E180-AI01-12		
<b>spare parts for</b>	500128		
	<b>GEV No.</b>	365170	<b>Ref. No.</b> —
<b>description</b>	capacitor capacity 2µF 425V tolerance 5% 50/60Hz ambient temperature max. -25 to +85°C ø 25mm L 49mm M8 plastic connection cable 250mm 416.17.74 protection		

fuses

thermal fuses



1

<b>GEV No.</b>	358298	<b>Ref. No.</b>	1V421473
<b>description</b>	thermal fuse switch-off temp. 128°C nominal 10A		

electric accessories

terminals

connection terminals with faston connections



1

<b>GEV No.</b>	550953	<b>Ref. No.</b>	1V420304
<b>description</b>	connection terminal 6-pole max. 20A max 450V connection F6.3/F6.3 temp.-resist. 90°C		



1

<b>GEV No.</b>	550954	<b>Ref. No.</b>	1V421490
<b>description</b>	connection terminal 9-pole max. 20A max 450V connection F6.3/F6.3 temp.-resist. 90°C		

electronic components

varistors



1

<b>GEV No.</b>	401565	<b>Ref. No.</b>	1G946001
<b>description</b>	varistor		

resistors



1

<b>GEV No.</b>	359502	<b>Ref. No.</b>	16-888002 178853 BK178853
<b>description</b>	resistor 120KOhm 3W		



1

<b>GEV No.</b>	359503	<b>Ref. No.</b>	178854 1G888001
<b>description</b>	resistor 680KOhm		



## miscellaneous

## battery holders

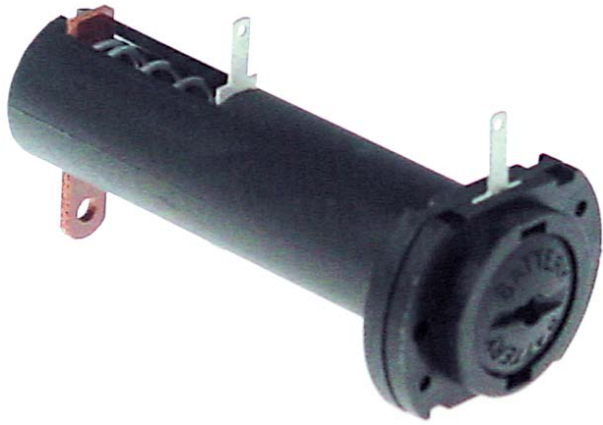

1

<b>GEV No.</b>	102909	<b>Ref. No.</b>	1G564255
<b>description</b>	battery holder for battery type AA 1.5V mounting $\varnothing$ 19mm connection male faston 2.8mm		

## gas taps











## PEL

## 22S/O series



1

<b>GEV No.</b>	106056	<b>Ref. No.</b>	178901 1G820096 BK178901
<b>description</b>	gas tap PEL type 22S/O gas inlet M20x1.5 (tube $\varnothing$ 12mm) bypass nozzle $\varnothing$ 0.35mm gas outlet M20x1.5 (tube $\varnothing$ 12/10mm) thermocouple connection M10x1 pilot connection M10x1 shaft $\varnothing$ 6x4.6mm shaft L 45/20mm shaft flat left		
<b>spare parts for</b>	106056		
	<b>GEV No.</b>	101058	<b>Ref. No.</b> —
	magnet unit L 39mm D1 $\varnothing$ 15.4mm D2 $\varnothing$ 13.5mm suitable for PEL22/EGA24197 standard		
	<b>GEV No.</b>	101213	<b>Ref. No.</b> —
	gas tap front part shaft $\varnothing$ 6x4.6mm shaft L 45/20mm shaft flat right/left suitable for PEL22		
	<b>GEV No.</b>	101240	<b>Ref. No.</b> —
	gas connection thread M20x1.5 tube $\varnothing$ 12/10mm for PEL gas taps with gasket and screws horizontal		
	<b>GEV No.</b>	101290	<b>Ref. No.</b> —
	thermocouple nut T1: M10x1 T2: M18x1 suitable for PEL20/21		
	<b>GEV No.</b>	101460	<b>Ref. No.</b> —
	O-ring $\varnothing$ 12.37mm D1 $\varnothing$ 2.62mm suitable for PEL22		
	<b>GEV No.</b>	101461	<b>Ref. No.</b> —
	screw kit suitable for PEL22 Qty 4 pcs		
<b>accessories for</b>	106056		
	<b>GEV No.</b>	100908	<b>Ref. No.</b> —
	union screw thread M10x1 for pipe $\varnothing$ 4mm Qty 1 pcs		

<b>accessories for</b>	106056		
	<b>GEV No.</b>	100909	<b>Ref. No.</b> —
	union screw thread M10x1 for pipe $\varnothing$ 6mm Qty 1 pcs		
	<b>GEV No.</b>	101241	<b>Ref. No.</b> —
	gas connection thread M20x1.5 tube $\varnothing$ 12/10mm for PEL gas taps vertical		
	<b>GEV No.</b>	101246	<b>Ref. No.</b> —
	olive for pipe $\varnothing$ 4mm Qty 1 pcs		
	<b>GEV No.</b>	101248	<b>Ref. No.</b> —
	olive for pipe $\varnothing$ 12mm Qty 1 pcs suitable for PEL		
	<b>GEV No.</b>	101249	<b>Ref. No.</b> —
	olive for pipe $\varnothing$ 10mm Qty 1 pcs		
	<b>GEV No.</b>	101250	<b>Ref. No.</b> —
	union nut thread M20x1.5 for pipe $\varnothing$ 10mm		
	<b>GEV No.</b>	101251	<b>Ref. No.</b> —
	union nut thread M20x1.5 for pipe $\varnothing$ 12mm		
	<b>GEV No.</b>	101286	<b>Ref. No.</b> —
	olive ID $\varnothing$ 6mm Qty 1 pcs		
	<b>GEV No.</b>	110080	<b>Ref. No.</b> —
	knob $\varnothing$ 70mm shaft $\varnothing$ 10x8mm shaft flat universal		
	<b>GEV No.</b>	112206	<b>Ref. No.</b> —
	knob dial plate silver gas tap PEL21/22/23 t.max.°C ED $\varnothing$ 63mm ID $\varnothing$ 45.5mm		

## ignition parts



## pilot burners

## AEM

## pilot burners



1

<b>GEV No.</b>	102906	<b>Ref. No.</b>	1G564253
<b>description</b>	pilot burner 1 flame gas connection 6mm mounting thread M5		
<b>accessories for</b>	102906		
	<b>GEV No.</b>	106427	<b>Ref. No.</b> —
	pilot burner nozzle natural/liquid gas bore $\varnothing$ 0.3mm code 30 thread 7/32" (28G) WS 6		
	<b>GEV No.</b>	106428	<b>Ref. No.</b> —
	pilot burner nozzle LPG bore $\varnothing$ 0.25mm code 25 thread 7/32" (28G) WS 6		
	<b>GEV No.</b>	106429	<b>Ref. No.</b> —
	pilot burner nozzle natural gas bore $\varnothing$ 0.35mm thread M5x0.75 WS 6		





producer-specific pilot burners

SALVIS

Combiline series

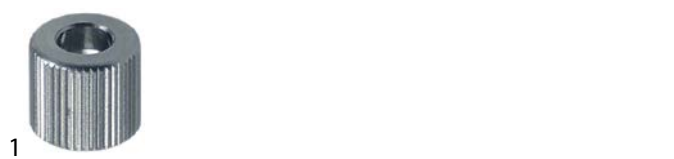

<b>GEV No.</b>	107293	<b>Ref. No.</b>	1G820042
<b>description</b>	knurled nut for pilot burner nozzle M10x0.9		

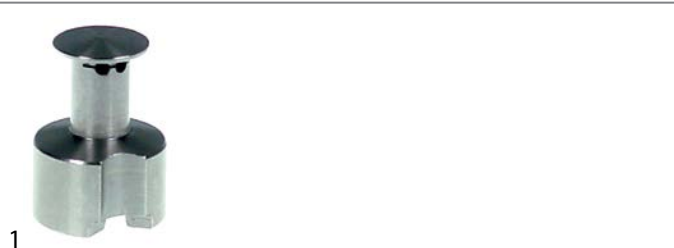

<b>GEV No.</b>	102902	<b>Ref. No.</b>	178897 1G820051
<b>description</b>	pilot burner 2 flames		



<b>GEV No.</b>	107292	<b>Ref. No.</b>	1G820043
<b>description</b>	pilot burner bottom part M10x0.9		

**accessories for** 107292

	<b>GEV No.</b>	107293	<b>Ref. No.</b>	1G820042 820042
	knurled nut for pilot burner nozzle M10x0.9			

Smartline series



<b>GEV No.</b>	102906	<b>Ref. No.</b>	1G564253
<b>description</b>	pilot burner 1 flame gas connection 6mm mounting thread M5		

**accessories for** 102906

	<b>GEV No.</b>	106427	<b>Ref. No.</b>	—
	pilot burner nozzle natural/liquid gas bore $\varnothing$ 0.3mm code 30 thread 7/32" (28G) WS 6			
	<b>GEV No.</b>	106428	<b>Ref. No.</b>	—
	pilot burner nozzle LPG bore $\varnothing$ 0.25mm code 25 thread 7/32" (28G) WS 6			
	<b>GEV No.</b>	106429	<b>Ref. No.</b>	—
	pilot burner nozzle natural gas bore $\varnothing$ 0.35mm thread M5x0.75 WS 6			

electrodes

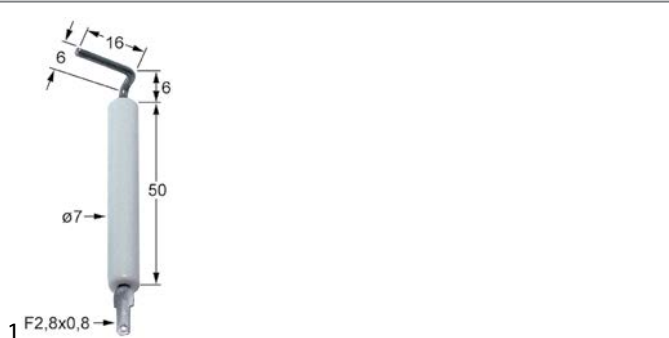

<b>GEV No.</b>	102907	<b>Ref. No.</b>	1G564251
<b>description</b>	ignition electrode D1 $\varnothing$ 7mm connection F 2.8x0.8mm L1 50mm L2 6mm L3 16mm BL 16mm to clip		

ignition units

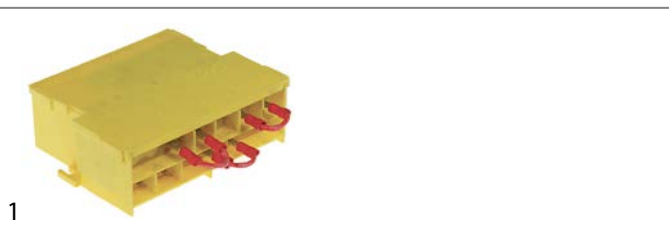

<b>GEV No.</b>	102908	<b>Ref. No.</b>	1G564254
<b>description</b>	ignition unit outputs 8 1.5 V/DC inlet F6.3x0.8 outlet F2.8x0.8 mounting $\varnothing$ 103mm		

ignition switches

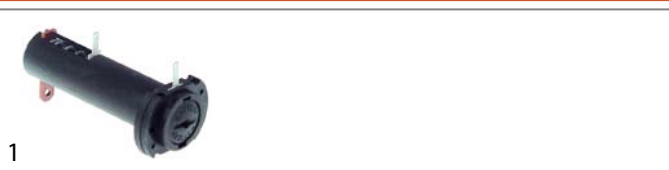

<b>GEV No.</b>	102909	<b>Ref. No.</b>	1G564255
<b>description</b>	battery holder for battery type AA 1.5V mounting $\varnothing$ 19mm connection male faston 2.8mm		

thermocouples

plug-in thermocouples

plug-in thermocouples standard

with barrel socket  $\varnothing$  6mm

type Junkers with aluminised tip

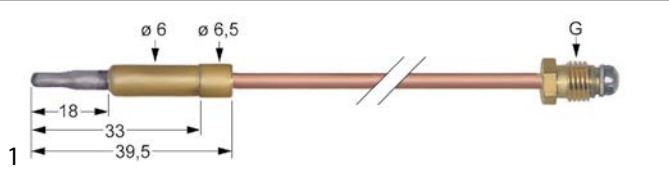

<b>GEV No.</b>	102229	<b>Ref. No.</b>	178899
<b>description</b>	thermocouple M10x1 L 1000mm plug connection $\varnothing$ 6.0mm		

with barrel socket  $\varnothing 6(6.5)$ mm

thermocouples SIT

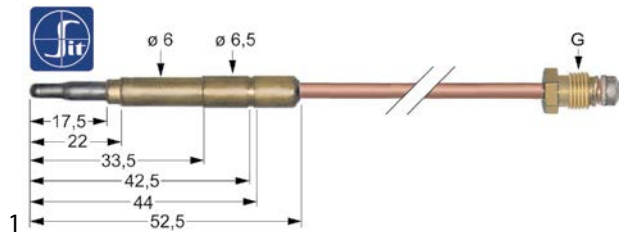

<b>GEV No.</b>	107604	<b>Ref. No.</b>	1G564261
<b>description</b>	thermocouple SIT M8x1 L 1200mm plug connection $\varnothing 6.0(6.5)$ mm		

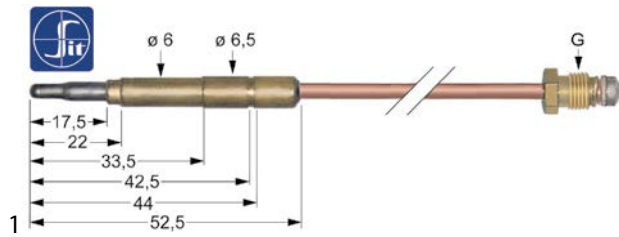

<b>GEV No.</b>	107601	<b>Ref. No.</b>	1G564250
<b>description</b>	thermocouple SIT M8x1 L 600mm plug connection $\varnothing 6.0(6.5)$ mm		

accessories

screws



<b>GEV No.</b>	100920	<b>Ref. No.</b>	1G820069
<b>description</b>	thermocouple fitting thread M8x1 / M9x1 Qty 1 pcs		

gas burners

hob burners

producer-specific hob burners

FRANKE/SALVIS

Combiline series



<b>GEV No.</b>	108032	<b>Ref. No.</b>	178908 1G820047
<b>description</b>	burner cap $\varnothing 50$ mm		



<b>GEV No.</b>	108010	<b>Ref. No.</b>	178907
<b>description</b>	burner cap $\varnothing 78$ mm		

<b>accessories for</b>	108010			
	<b>GEV No.</b>	108003	<b>Ref. No.</b>	178891
	burner head for burner cap $\varnothing 78$ mm seat $\varnothing 35$ mm ID $\varnothing 30$ mm ED $\varnothing 83$ mm			



<b>GEV No.</b>	108033	<b>Ref. No.</b>	178890 1G820084
<b>description</b>	burner head for burner cap $\varnothing 50$ mm		



<b>GEV No.</b>	108003	<b>Ref. No.</b>	178891
<b>description</b>	burner head for burner cap $\varnothing 78$ mm seat $\varnothing 35$ mm ID $\varnothing 30$ mm ED $\varnothing 83$ mm		

<b>accessories for</b>	108003			
	<b>GEV No.</b>	108004	<b>Ref. No.</b>	—
	burner cap $\varnothing 78$ mm 5kW mounting $\varnothing 72$ mm			



<b>GEV No.</b>	108034	<b>Ref. No.</b>	178889 1G820013
<b>description</b>	burner lower part $\varnothing 35$ mm for burner cap $\varnothing 50/78$ mm L 100mm		

Smartline series



<b>GEV No.</b>	108035	<b>Ref. No.</b>	1G564260 835307
<b>description</b>	burner cap $\varnothing 50$ mm		



<b>GEV No.</b>	108038	<b>Ref. No.</b>	1G564259 835293
<b>description</b>	burner cap $\varnothing 78$ mm		

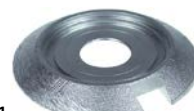

<b>GEV No.</b>	108036	<b>Ref. No.</b>	1G564261 835315
<b>description</b>	burner head $\varnothing 111$ mm for burner cap $\varnothing 78$ mm		



			
1			
<b>GEV No.</b>	108039	<b>Ref. No.</b>	1G564262 835323
<b>description</b>	burner head ø89mm for burner cap ø50mm		

			
1			
<b>GEV No.</b>	108037	<b>Ref. No.</b>	1G564263 835331
<b>description</b>	burner lower part complete		

## gas nozzles

### pilot burner nozzles

#### pilot burner nozzles JUNKERS

CB 50203\_/503\_ series

			
1			
<b>GEV No.</b>	100222	<b>Ref. No.</b>	178895 1G820090
<b>description</b>	pilot burner nozzle LPG gas pressure 50mbar code 5 Qty 1 pcs suitable for JUNKERS CB50203_		

## equipment-specific units

### for convection ovens/combi-steamers

#### injection pipes

			
1			
<b>GEV No.</b>	692838	<b>Ref. No.</b>	1C753793
<b>description</b>	injection pipe for combi-steamer straight ED ø 12mm ID ø 8mm L 180mm -		

#### glass panels

			
1			
<b>GEV No.</b>	691256	<b>Ref. No.</b>	1L295582
<b>description</b>	glass panel L 755mm W 690mm thickness 4mm		

#### cleaning system

##### cleaning arms

			
1			
<b>GEV No.</b>	542416	<b>Ref. No.</b>	1C775177
<b>description</b>	mounting flange ø55mm hub with gasket for wash arm suitable for ELOMA combi-steamer		

#### door mechanics

##### locking mechanism

			
1			
<b>GEV No.</b>	692714	<b>Ref. No.</b>	791652
<b>description</b>	disc for catch ø44mm hole ø6x8mm		

## knobs

### producer-specific knobs

#### SALVIS

			
1			
<b>GEV No.</b>	112040	<b>Ref. No.</b>	178844 1G864061 BK178844
<b>description</b>	knob switch 0-1-0-1 ø55mm shaft ø6x4.6mm shaft flat upper black		



1

<b>GEV No.</b>	112052	<b>Ref. No.</b>	278457 688940 946.273
<b>description</b>	knob switch zero mark t.max.°C temperature range°C ø 54mm shaft ø 6x4.6mm shaft flat upper black		



1

<b>GEV No.</b>	112038	<b>Ref. No.</b>	179305 1G594095
<b>description</b>	knob thermostat 1-6 ø 54mm shaft ø 6x4.6mm shaft flat upper		



1

<b>GEV No.</b>	112041	<b>Ref. No.</b>	178838 1G864059 BK178838
<b>description</b>	knob thermostat Min/Max ø 55mm shaft ø 6x4.6mm shaft flat upper		



1

<b>GEV No.</b>	111967	<b>Ref. No.</b>	178856 1G864058
<b>description</b>	knob thermostat t.max. 300°C temperature range 50-300°C ø 54mm shaft ø 6x4.6mm shaft flat lower black		



1

<b>GEV No.</b>	112039	<b>Ref. No.</b>	179314 1G594074
<b>description</b>	knob thermostat t.max. 300°C temperature range 50-300°C ø 55mm shaft ø 6x4.6mm shaft flat upper rotation 270° black		



1

<b>GEV No.</b>	112060	<b>Ref. No.</b>	1G914236
<b>description</b>	knob switch zero mark ø 52mm shaft ø 6x4.6mm shaft flat upper black		



1

<b>GEV No.</b>	112061	<b>Ref. No.</b>	1G534227 1G534514
<b>description</b>	knob dial plate 1-10		

locks

edgemount latches

handle latches

RAHRBACH

6188 ERGO series

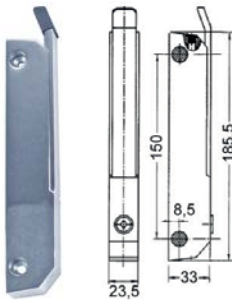

1

<b>GEV No.</b>	690808	<b>Ref. No.</b>	1C565458
<b>description</b>	handle latch L 185mm mounting distance 150mm chrome-plated non lockable for headed units 6188 type ERGO		

**accessories for** 690808

	<b>GEV No.</b>	690110	<b>Ref. No.</b>	—
	base plate H 1mm L 38mm W 11mm mounting distance 26mm plastic			

	<b>GEV No.</b>	690111	<b>Ref. No.</b>	—
	base plate H 2mm L 38mm W 11mm mounting distance 26mm plastic			

	<b>GEV No.</b>	690114	<b>Ref. No.</b>	—
	base plate H 3.5mm L 185mm W 30mm mounting distance 150mm with inclination thread M5			

	<b>GEV No.</b>	700082	<b>Ref. No.</b>	—
	door catch L 38mm W 18mm mounting distance 26mm			





## pullouts

### frame



1

<b>GEV No.</b>	695464	<b>Ref. No.</b>	1V421650
<b>description</b>	frame for pullout size 1/1 L 660mm		



1

<b>GEV No.</b>	695468	<b>Ref. No.</b>	1V421651
<b>description</b>	frame for telescopic rail size 1/1 L 660mm capacity 120kg		



1

<b>GEV No.</b>	695474	<b>Ref. No.</b>	1V421653
<b>description</b>	frame for telescopic rail size 2/1 L 760mm capacity 120kg		



1

<b>GEV No.</b>	695471	<b>Ref. No.</b>	1V421652
<b>description</b>	frame for telescopic rail size 2/1 L 760mm capacity 70kg		

### rails



1

<b>GEV No.</b>	695470	<b>Ref. No.</b>	1V421658
<b>description</b>	rail L 660mm size 1/1 for telescopic rail capacity 120kg		



1

<b>GEV No.</b>	695466	<b>Ref. No.</b>	1V421682
<b>description</b>	rail L 660mm size 1/1 for telescopic rail capacity 70kg		



1

<b>GEV No.</b>	695476	<b>Ref. No.</b>	1V421659
<b>description</b>	rail L 760mm size 2/1 for telescopic rail capacity 120kg		



1

<b>GEV No.</b>	695473	<b>Ref. No.</b>	1V421683
<b>description</b>	rail L 760mm size 2/1 for telescopic rail capacity 70kg		

### drawer slides

#### producer-specific



1

<b>GEV No.</b>	695469	<b>Ref. No.</b>	1V421655
<b>description</b>	pullout size 1/1 L 660mm capacity 120kg		



1

<b>GEV No.</b>	695465	<b>Ref. No.</b>	1V421654
<b>description</b>	pullout size 1/1 L 660mm capacity 70kg		



1

<b>GEV No.</b>	695475	<b>Ref. No.</b>	1V421657
<b>description</b>	pullout size 2/1 L 760mm capacity 120kg		



1

<b>GEV No.</b>	695472	<b>Ref. No.</b>	1V421656
<b>description</b>	pullout size 2/1 L 760mm capacity 70kg		

## baskets

### fryer baskets

SALVIS



1

<b>GEV No.</b>	970493	<b>Ref. No.</b>	178618 178862 BI371740 CA50006
<b>description</b>	fryer basket L1 260mm W1 220mm H1 105mm		

## shelves and shelf rails

### grates

#### universal

#### without upstand



1

<b>GEV No.</b>	970122	<b>Ref. No.</b>	BI177994	
<b>description</b>	grate W 325mm D 530mm GN 1/1 H 8mm stainless steel wire gauge frame 7mm lengthwise wires gauge 4mm crossing wires 1			
<b>accessories for</b>	970122			
	<b>GEV No.</b>	690330	<b>Ref. No.</b>	—
	rack L 1000mm W 22mm H 4mm aperture 3x8mm hole distance 12.5mm stainless steel			
	<b>GEV No.</b>	694700	<b>Ref. No.</b>	—
	shelf support L 31/28mm W 22mm H 18mm SS Qty 12 pcs			
	<b>GEV No.</b>	694701	<b>Ref. No.</b>	—
	shelf support L 31/28mm W 22mm H 17mm SS with hook Qty 12 pcs			

## gaskets

### refrigeration gaskets

#### plug-in gaskets

#### profile 9162

#### Salvis series 1999

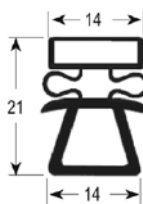

1

<b>GEV No.</b>	900640	<b>Ref. No.</b>	1V420000
<b>description</b>	refrigeration gasket profile 9162 W 385mm L 184mm external size		

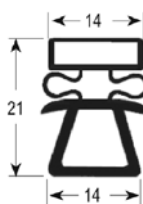

1

<b>GEV No.</b>	900641	<b>Ref. No.</b>	1V420001
<b>description</b>	refrigeration gasket profile 9162 W 385mm L 206mm external size		

<b>GEV No.</b>	900642	<b>Ref. No.</b>	1V420002
<b>description</b>	refrigeration gasket profile 9162 W 385mm L 229mm external size		

<b>GEV No.</b>	900648	<b>Ref. No.</b>	1V420008
<b>description</b>	refrigeration gasket profile 9162 W 385mm L 651mm external size		

<b>GEV No.</b>	900643	<b>Ref. No.</b>	1V420003
<b>description</b>	refrigeration gasket profile 9162 W 385mm L 314mm external size		

<b>GEV No.</b>	900649	<b>Ref. No.</b>	1V420009
<b>description</b>	refrigeration gasket profile 9162 W 385mm L 781mm external size		

<b>GEV No.</b>	900644	<b>Ref. No.</b>	1V420004
<b>description</b>	refrigeration gasket profile 9162 W 385mm L 321mm external size		

<b>GEV No.</b>	900650	<b>Ref. No.</b>	1V420010
<b>description</b>	refrigeration gasket profile 9162 W 585mm L 184mm external size		

<b>GEV No.</b>	900645	<b>Ref. No.</b>	1V420005
<b>description</b>	refrigeration gasket profile 9162 W 385mm L 359mm external size		

<b>GEV No.</b>	900651	<b>Ref. No.</b>	1V420011
<b>description</b>	refrigeration gasket profile 9162 W 585mm L 206mm external size		

<b>GEV No.</b>	900647	<b>Ref. No.</b>	1V420007
<b>description</b>	refrigeration gasket profile 9162 W 385mm L 451mm external size		

<b>GEV No.</b>	900652	<b>Ref. No.</b>	1V420012
<b>description</b>	refrigeration gasket profile 9162 W 585mm L 229mm external size		

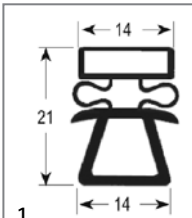

<b>GEV No.</b>	900653	<b>Ref. No.</b>	1V420013
<b>description</b>	refrigeration gasket profile 9162 W 585mm L 314mm external size		

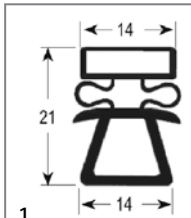

<b>GEV No.</b>	900658	<b>Ref. No.</b>	1V420018
<b>description</b>	refrigeration gasket profile 9162 W 585mm L 651mm external size		

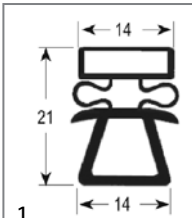

<b>GEV No.</b>	900654	<b>Ref. No.</b>	1V420014
<b>description</b>	refrigeration gasket profile 9162 W 585mm L 321mm external size		

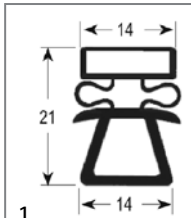

<b>GEV No.</b>	900659	<b>Ref. No.</b>	1V420019
<b>description</b>	refrigeration gasket profile 9162 W 585mm L 781mm external size		

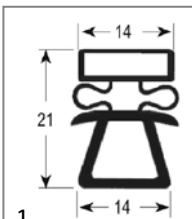

<b>GEV No.</b>	900655	<b>Ref. No.</b>	1V420015
<b>description</b>	refrigeration gasket profile 9162 W 585mm L 359mm external size		

Salvis series 2000



<b>GEV No.</b>	900660	<b>Ref. No.</b>	1V421560
<b>description</b>	refrigeration gasket profile 9162 W 385mm L 185mm external size		

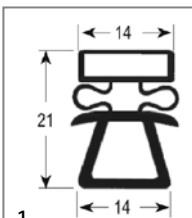

<b>GEV No.</b>	900656	<b>Ref. No.</b>	1V420016
<b>description</b>	refrigeration gasket profile 9162 W 585mm L 406mm external size		

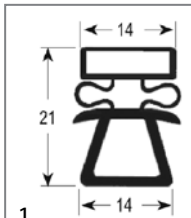

<b>GEV No.</b>	900661	<b>Ref. No.</b>	1V421561
<b>description</b>	refrigeration gasket profile 9162 W 385mm L 206mm external size		

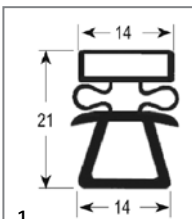

<b>GEV No.</b>	900657	<b>Ref. No.</b>	1V420017
<b>description</b>	refrigeration gasket profile 9162 W 585mm L 451mm external size		

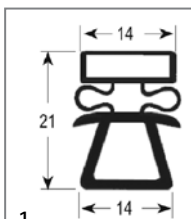

<b>GEV No.</b>	900662	<b>Ref. No.</b>	1V421562
<b>description</b>	refrigeration gasket profile 9162 W 385mm L 224mm external size		

<b>GEV No.</b>	900663	<b>Ref. No.</b>	1V421563
<b>description</b>	refrigeration gasket profile 9162 W 385mm L 309mm external size		

<b>GEV No.</b>	900668	<b>Ref. No.</b>	1V421568
<b>description</b>	refrigeration gasket profile 9162 W 385mm L 445mm external size		

<b>GEV No.</b>	900664	<b>Ref. No.</b>	1V421564
<b>description</b>	refrigeration gasket profile 9162 W 385mm L 318mm external size		

<b>GEV No.</b>	900669	<b>Ref. No.</b>	1V421569
<b>description</b>	refrigeration gasket profile 9162 W 385mm L 642mm external size		

<b>GEV No.</b>	900665	<b>Ref. No.</b>	1V421565
<b>description</b>	refrigeration gasket profile 9162 W 385mm L 320mm external size		

<b>GEV No.</b>	900670	<b>Ref. No.</b>	1V421570
<b>description</b>	refrigeration gasket profile 9162 W 385mm L 772mm external size		

<b>GEV No.</b>	900666	<b>Ref. No.</b>	1V421566
<b>description</b>	refrigeration gasket profile 9162 W 385mm L 354mm external size		

<b>GEV No.</b>	900671	<b>Ref. No.</b>	1V421580
<b>description</b>	refrigeration gasket profile 9162 W 585mm L 188mm external size		

<b>GEV No.</b>	900667	<b>Ref. No.</b>	1V421567
<b>description</b>	refrigeration gasket profile 9162 W 385mm L 405mm external size		

<b>GEV No.</b>	900672	<b>Ref. No.</b>	1V421581
<b>description</b>	refrigeration gasket profile 9162 W 585mm L 206mm external size		



<b>GEV No.</b>	900673	<b>Ref. No.</b>	1V421582
<b>description</b>	refrigeration gasket profile 9162 W 585mm L 224mm external size		

<b>GEV No.</b>	900678	<b>Ref. No.</b>	1V421587
<b>description</b>	refrigeration gasket profile 9162 W 585mm L 406mm external size		

<b>GEV No.</b>	900674	<b>Ref. No.</b>	1V421583
<b>description</b>	refrigeration gasket profile 9162 W 585mm L 309mm external size		

<b>GEV No.</b>	900679	<b>Ref. No.</b>	1V421588
<b>description</b>	refrigeration gasket profile 9162 W 585mm L 442mm external size		

<b>GEV No.</b>	900675	<b>Ref. No.</b>	1V421584
<b>description</b>	refrigeration gasket profile 9162 W 585mm L 318mm external size		

<b>GEV No.</b>	900680	<b>Ref. No.</b>	1V421589
<b>description</b>	refrigeration gasket profile 9162 W 585mm L 642mm external size		

<b>GEV No.</b>	900676	<b>Ref. No.</b>	1V421585
<b>description</b>	refrigeration gasket profile 9162 W 585mm L 321mm external size		

<b>GEV No.</b>	900681	<b>Ref. No.</b>	1V421590
<b>description</b>	refrigeration gasket profile 9162 W 585mm L 772mm external size		

<b>GEV No.</b>	900677	<b>Ref. No.</b>	1V421586
<b>description</b>	refrigeration gasket profile 9162 W 585mm L 354mm external size		

**gaskets for heated units**

**door seals**

<b>GEV No.</b>	900100	<b>Ref. No.</b>	1L295594 384410
<b>description</b>	door seal profile 2070 W 460mm L 645mm external size Qty 1 6 x 1/1		



<b>GEV No.</b>	900101	<b>Ref. No.</b>	1L295593 382310
<b>description</b>	door seal profile 2070 W 645mm L 700mm external size Qty 1 10 x 1/1		

<b>GEV No.</b>	900497	<b>Ref. No.</b>	1C742376
<b>description</b>	door seal profile 2449 W 520mm L 775mm Qty 1		

## springs

### torsion springs

<b>GEV No.</b>	692911	<b>Ref. No.</b>	791520
<b>description</b>	torsion spring $\varnothing$ 27mm wire gauge $\varnothing$ 2.3mm mounting pos. door handle L1 11mm Qty 1 pcs		

## fastening material

### nuts

#### hexagonal nuts

#### hexagonal nuts metric (without norm)



<b>GEV No.</b>	101860	<b>Ref. No.</b>	1G820049
<b>description</b>	nut thread M10x1 H 4mm WS 14 chrome-plated brass Qty 1 pcs		

## consumables

### fuses

#### thermal fuses



<b>GEV No.</b>	358298	<b>Ref. No.</b>	1V421473
<b>description</b>	thermal fuse switch-off temp. 128°C nominal 10A		



<b>A</b>			
audible timers	12		
<b>B</b>			
battery holders	16		
bi-metal thermostats	7, 8		
bottom heaters	5		
<b>C</b>			
cam switches	10		
consumables	27		
contactors	12		
control equipment	11		
control thermostats	8		
cross flow fans	14		
<b>D</b>			
door seals	26		
<b>E</b>			
edgemount latches	20		
electric accessories	15		
electronic controllers	13		
energy regulators	7		
<b>F</b>			
fans	14		
fastening material	27		
foil heating elements	7		
fuses	15, 27		
<b>G</b>			
gas burners	18		
gas nozzles	19		
gas taps	16		
gaskets for heated units	26		
grates	22		
<b>H</b>			
handle latches	20		
heating elements	3		
heating elements for chip scuttles	3		
heating elements for convection	6		
heating elements for fryers	3		
heating elements for griddles	3		
heating elements for large hobs	4		
heating elements for salamanders/toasters	4		
heating plates	6		
hexagonal nuts	27		
hob burners	18		
hot air fans	15		
hot air motors	15		
<b>I</b>			
ignition switches	17		
ignition units	17		
indicator lights	11		
indicator lights (complete)	11		
<b>L</b>			
lamps	11		
<b>M</b>			
mechanical timers	12		
mercury tilt switches	10		
microswitches	10		
<b>N</b>			
neon light bulbs	11, 12		
nuts	27		
<b>P</b>			
pilot burners	16		
plug-in gaskets	22		
probes	13		
push/momentary push switches	10		
<b>R</b>			
radiation heaters	6		
refrigeration gaskets	22		
relays	13		
rocker/momentary rocker switches	10		
<b>S</b>			
safety bi-metal thermostats	7		
safety thermostats	8		
shelves and shelf rails	22		
solenoid valves	14		
solid state relays	12		
switches and momentary switches	10		
<b>T</b>			
temperature probes	13		
terminals	15		
thermal fuses	27		
thermocouples	17		
thermostats	7		
timers	12		
<b>U</b>			
universal probes	13		