



GAS COMPONENTS



ELECTRIC COMPONENTS



WATER TECHNOLOGY



MECHANICAL COMPONENTS



TOOLS

Spare parts suitable for

SANREMO

Find the complete and up-to-date range of products in our GEV Webshop



Manufacturer catalogue

The most important spare parts and accessories arranged clearly for every manufacturer

- ✓ Complete product range and all appliance data always up to date in the GEV Webshop
- ✓ Alphabetical Index at the end of the catalogue

GEV Webshop

www.gev-online.co.uk

www.gev-online.com





- 🔍 Add to Favourites
- 🔍 Sign In with email address and usual password
- 🔍 Easy-order – place several items in your basket at the same time
- 🔍 Quick Item search – no login needed





heating elements

heating elements for coffee machine

| | | | |
|---|---|-----------------|----------|
|  | | | |
| 1 | | | |
| GEV No. | 417280 | Ref. No. | 10455014 |
| description | heating element 1000W 220V heating circuits 1 ø 50mm H 60mm W1 45mm H1 20mm H2 40mm mounting distance 35mm thread M10x1 windings 4 tube ø 6.3mm immersion heater 2 hole fixing connection male faston 6.3mm | | |

| | | | |
|---|---|-----------------|----------|
|  | | | |
| 1 | | | |
| GEV No. | 417377 | Ref. No. | 10455050 |
| description | heating element 1950W 230V heating circuits 3 thread 1¼" L 180mm W 28mm tube ø 8.5mm thermostat sleeves ø 7mm length thermostat sleeves 150mm number of thermostat sleeves 1 thermostat sleeve centre connection M4 immersion heater WS 38 suitable for SANREMO | | |

| | | | |
|---|--|-----------------|----------|
|  | | | |
| 1 | | | |
| GEV No. | 417378 | Ref. No. | 10455052 |
| description | heating element 2700W 230V heating circuits 3 thread 1¼" L 325mm W 34mm H 35mm tube ø 8.5mm thermostat sleeves ø 7mm length thermostat sleeves 220mm thermostat sleeve centre connection M4 immersion heater connection length 12mm WS 38 suitable for SANREMO | | |

| | | | |
|---|--|-----------------|----------|
|  | | | |
| 1 | | | |
| GEV No. | 417379 | Ref. No. | 10455080 |
| description | heating element 4500W 230V heating circuits 3 thread 1¼" L 325mm W 35mm H 35mm tube ø 8.5mm thermostat sleeves ø 7mm length thermostat sleeves 220mm thermostat sleeve centre connection M4 immersion heater connection length 12mm WS 38 suitable for SANREMO | | |

| | | | |
|---|--|-----------------|----------|
|  | | | |
| 1 | | | |
| GEV No. | 417380 | Ref. No. | 10455054 |
| description | heating element 5100W 230V heating circuits 3 thread 1¼" L 485mm W 35mm H 35mm tube ø 8.5mm thermostat sleeves ø 7mm length thermostat sleeves 140mm thermostat sleeve centre connection M3 immersion heater connection length 12mm WS 38 suitable for SANREMO | | |

thermostats

bi-metal thermostats

| | | | |
|---|--|-----------------|----------|
| <h4>safety bi-metal thermostats</h4> | | | |
|  | | | |
| 1 | | | |
| GEV No. | 390311 | Ref. No. | 10111049 |
| description | bi-metal safety thermostat hole distance mm switch-off temp. 135°C 1NC 1-pole 16A connection F6.3 M4 | | |

control and safety thermostats

| | | | |
|---|---|-----------------|----------|
| <h4>EGO</h4> | | | |
| <h4>safety thermostats</h4> | | | |
| <h4>55.32_series</h4> | | | |
|  | | | |
| 1 | | | |
| GEV No. | 390324 | Ref. No. | 10111015 |
| description | safety thermostat switch-off temp. 169°C 3-pole 3NC 20A probe ø 4mm probe L 128mm capillary pipe 890mm capillary pipe isolated 210/210mm gland nut probe S5 | | |

switches and momentary switches

rocker/momentary rocker switches

| | | | |
|---|--|-----------------|-----------|
| <h4>30x22mm</h4> | | | |
|  | | | |
| 1 | | | |
| GEV No. | 301036 | Ref. No. | 10105243A |
| description | protective cover internal size 30x22mm for rocker switch mounting measurementsmm | | |

| | | | |
|---|--|-----------------|----------|
|  | | | |
| 1 | | | |
| GEV No. | 347306 | Ref. No. | 10555042 |
| description | momentary rocker switch mounting measurements 30x22mm orange 2NO 250V 16A illuminated water connection male faston 6.3mm ambient temperature max. 85°C protection IP40 | | |



1

| | | | |
|--------------------|--|-----------------|----------|
| GEV No. | 346110 | Ref. No. | 10555060 |
| description | rocker switch mounting measurements 30x22mm red 2NO 250V 16A illuminated coffee connection male faston 6.3mm ambient temperature max. 125/55°C protection IP40 | | |

push/momentary push switches

30x22mm



1

| | | | |
|--------------------|--|-----------------|-----------|
| GEV No. | 301036 | Ref. No. | 10105243A |
| description | protective cover internal size 30x22mm for rocker switch mounting measurementsmm | | |

system switches (ROLD)



1

| | | | |
|--------------------|---|-----------------|----------|
| GEV No. | 347308 | Ref. No. | 10553078 |
| description | element holder mounting ø 16mm arched black ø 15.9mm ED ø 20mm H 23.5mm | | |



1

| | | | |
|--------------------|---|-----------------|----------|
| GEV No. | 347309 | Ref. No. | 10553086 |
| description | push button ø 11.9mm black coffee shaft L 4mm shaft 3.7x3.7mm | | |



1

| | | | |
|--------------------|---|-----------------|----------|
| GEV No. | 347310 | Ref. No. | 10553088 |
| description | push button ø 11.9mm black cup warmer shaft L 4mm shaft 3.7x3.7mm | | |



1

| | | | |
|--------------------|----------------------------------|-----------------|----------|
| GEV No. | 347315 | Ref. No. | 10553090 |
| description | push button ø 11.9mm black light | | |



1

| | | | |
|---|--|-----------------|-----------------|
| GEV No. | 347192 | Ref. No. | 10553080 |
| description | switch 2NO 250V 16A connection male faston 6.3mm | | |
| accessories for | 347192 | | |
|  | GEV No. | 347183 | Ref. No. |
| | | | — |
| | push button mounting ø 14.3mm chrome-plated | | |

rotary switches

GIOVENZANA

rotary switches



1

| | | | |
|---|--|-----------------|-----------------------------------|
| GEV No. | 347302 | Ref. No. | 10122016 10122036A 10122050 |
| description | rotary switch 2 0-1 sets of contacts 6 type P0200514S 690V 20A shaft ø 8x7mm shaft L 19mm shaft star-shaped connection screw | | |
| accessories for | 347302 | | |
|  | GEV No. | 112615 | Ref. No. |
| | | | 10122015 |
| | knob with indicator ø 35mm H 22mm shaft diameter 8x7mm black | | |



1

| | | | |
|---|---|-----------------|-----------------------------------|
| GEV No. | 347303 | Ref. No. | 10122018 10122038A 10122060 |
| description | rotary switch 3 0-1 sets of contacts 6 type PO20 690V 20A shaft ø 8x7mm shaft L 19mm shaft star-shaped connection screw | | |
| accessories for | 347303 | | |
|  | GEV No. | 112615 | Ref. No. |
| | | | 10122015 |
| | knob with indicator ø 35mm H 22mm shaft diameter 8x7mm black | | |



accessories

knobs



1

| | | | |
|--------------------|--|-----------------|----------|
| GEV No. | 111371 | Ref. No. | 10122012 |
| description | knob ø 27/46mm black shaft diameter 6x6mm with screw | | |



1

| | | | |
|--------------------|--|-----------------|----------|
| GEV No. | 112615 | Ref. No. | 10122015 |
| description | knob with indicator ø 35mm H 22mm shaft diameter 8x7mm black | | |

lamps

indicator lights

indicator lights (complete)

ø 6mm



1

| | | | |
|--------------------|--|-----------------|----------|
| GEV No. | 359569 | Ref. No. | 10553021 |
| description | indicator light ø 6mm 230V yellow cable length 250mm temp.-resist. 150°C | | |

solid state relays

CRYDOM



1

| | | | |
|--------------------|--|-----------------|-----------|
| GEV No. | 402490 | Ref. No. | 10112216A |
| description | solid state relay CRYDOM 3 phase 50A 530V 4-32VDC L 105mm W 74mm screw type D53TP50D | | |

CROUZET



1

| | | | |
|--------------------|--|-----------------|-----------|
| GEV No. | 403542 | Ref. No. | 10112216A |
| description | solid state relay CROUZET 3 phase 50A 48-600V 4-32VDC L 105mm W 80mm screw type GN350DLZ | | |

relays

level relays

GICAR



1

| | | | |
|--------------------|---|-----------------|-----------|
| GEV No. | 402103 | Ref. No. | 10112010A |
| description | level controller 230/240V voltage AC 50/60Hz connection F6.3 type NRL30/1E-2C/F | | |

probes

producer-specific probes

probes



1

| | | | |
|--------------------|--|-----------------|----------|
| GEV No. | 379452 | Ref. No. | 10112178 |
| description | temperature probe NTC cable glass fibre probe -40 up to +125°C cable -50 up to +350°C connection plug thread 1/4" probe ø3.5x20mm cable length 0.24m | | |

electronics

electronics accessories



1

| | | | |
|--------------------|---|-----------------|----------|
| GEV No. | 525622 | Ref. No. | 10401034 |
| description | spacer piece for keypad L 13.5mm ø 6mm ID ø 3.5mm | | |



PCBs



1

| | | | |
|--------------------|--|-----------------|----------|
| GEV No. | 402481 | Ref. No. | 10112044 |
| description | display for coffee machine L 106mm W 36mm suitable for SANREMO | | |



1

| | | | |
|--------------------|--|-----------------|----------|
| GEV No. | 402483 | Ref. No. | 10112168 |
| description | display for coffee machine L 74mm W 26mm suitable for SANREMO model ROMA | | |



1

| | | | |
|--------------------|--|-----------------|----------|
| GEV No. | 402482 | Ref. No. | 10112162 |
| description | display for coffee machine L 74mm W 26mm suitable for SANREMO model VERONA | | |

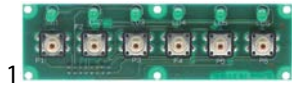

1

| | | | |
|--------------------|---|-----------------|-----------|
| GEV No. | 402486 | Ref. No. | 10112087B |
| description | keypad PCB coffee machine MILANO L 123mm W 35mm buttons 6 | | |



1

| | | | |
|--------------------|--|-----------------|-----------|
| GEV No. | 402484 | Ref. No. | 10112099B |
| description | keypad PCB for coffee machine L 123mm W 35mm buttons 2 | | |



1

| | | | |
|--------------------|--|-----------------|-----------|
| GEV No. | 402485 | Ref. No. | 10112057B |
| description | keypad PCB for coffee machine L 123mm W 35mm buttons 5 | | |

central units



1

| | | | |
|--------------------|--------------|-----------------|------------------------|
| GEV No. | 402468 | Ref. No. | 10112091A 10112091D |
| description | central unit | | |



1

| | | | |
|--------------------|--|-----------------|---|
| GEV No. | 402801 | Ref. No. | 10112071A 10112071C 10112072A 10112072B 10112072D |
| description | central unit 230V 50/60Hz type 3d5 3GRCT XLC (SC) „T.M.-DL“ voltage AC | | |



1

| | | | |
|--------------------|---|-----------------|--|
| GEV No. | 402802 | Ref. No. | 10112171 10112172 10112174 10112175 |
| description | central unit 240V 50/60Hz type 3d5 MAESTRO DELUXE 6T voltage AC | | |



1

| | | | |
|--------------------|--|-----------------|------------------------|
| GEV No. | 402803 | Ref. No. | 10112091A 10112091D |
| description | central unit 250V 50/60Hz type E.T.30 F 2GRCT voltage AC | | |



1

| | | | |
|--------------------|-------------|-----------------|----------|
| GEV No. | 402464 | Ref. No. | 10112182 |
| description | control box | | |

1

| | | | |
|--------------------|-------------|-----------------|-----------|
| GEV No. | 402465 | Ref. No. | 10112058A |
| description | control box | | |



1

| | | | |
|--------------------|-------------|-----------------|-----------|
| GEV No. | 402472 | Ref. No. | 10112173B |
| description | control box | | |



1

| | | | |
|--------------------|-------------|-----------------|-----------|
| GEV No. | 402466 | Ref. No. | 10112086B |
| description | control box | | |



1

| | | | |
|--------------------|-------------|-----------------|----------|
| GEV No. | 402474 | Ref. No. | 10112186 |
| description | control box | | |



1

| | | | |
|--------------------|-------------|-----------------|-----------|
| GEV No. | 402467 | Ref. No. | 10112102A |
| description | control box | | |



1

| | | | |
|--------------------|-------------|-----------------|-----------|
| GEV No. | 402849 | Ref. No. | 10112180A |
| description | control box | | |



1

| | | | |
|--------------------|-------------|-----------------|------------------------|
| GEV No. | 402469 | Ref. No. | 10112072C 10112083C |
| description | control box | | |



1

| | | | |
|--------------------|--|-----------------|-----------------------|
| GEV No. | 402471 | Ref. No. | 10112112B 8SR12112 |
| description | control box 230/240V 50/60Hz type 3d5 3GRCT XLC (SC) | | |



keypads

keypad units



1

| | | | |
|--------------------|---|-----------------|----------|
| GEV No. | 402477 | Ref. No. | 10112164 |
| description | keypad unit buttons 2 suitable for SANREMO L 146mm W 46mm | | |



1

| | | | |
|--------------------|---|-----------------|----------|
| GEV No. | 402479 | Ref. No. | 10112122 |
| description | keypad unit buttons 5 suitable for SANREMO L 120mm W 50mm | | |



1

| | | | |
|--------------------|---|-----------------|-----------|
| GEV No. | 402480 | Ref. No. | 10112066A |
| description | keypad unit buttons 5 suitable for SANREMO L 120mm W 50mm | | |



1

| | | | |
|--------------------|---|-----------------|----------|
| GEV No. | 402475 | Ref. No. | 10112166 |
| description | keypad unit buttons 6 suitable for SANREMO L 133mm W 40mm | | |



1

| | | | |
|--------------------|---|-----------------|----------|
| GEV No. | 402478 | Ref. No. | 10112138 |
| description | keypad unit buttons 6 suitable for SANREMO L 142mm W 50mm | | |



1

| | | | |
|--------------------|---|-----------------|-----------|
| GEV No. | 402476 | Ref. No. | 10112158A |
| description | keypad unit buttons 6 suitable for SANREMO L 146mm W 42mm | | |

accessories



1

| | | | |
|--------------------|---|-----------------|-----------|
| GEV No. | 525576 | Ref. No. | 10029630A |
| description | button round ø 17mm plastic black 1 cup large SANREMO | | |



1

| | | | |
|--------------------|---|-----------------|-----------|
| GEV No. | 525573 | Ref. No. | 10029626A |
| description | button round ø 17mm plastic black 1 cup small SANREMO | | |



1

| | | | |
|--------------------|--|-----------------|-----------|
| GEV No. | 525582 | Ref. No. | 10029632A |
| description | button round ø 17mm plastic black 2 cups large SANREMO | | |



1

| | | | |
|--------------------|--|-----------------|-----------|
| GEV No. | 525579 | Ref. No. | 10029631A |
| description | button round ø 17mm plastic black 2 cups small SANREMO | | |



1

| | | | |
|--------------------|---|-----------------|-----------|
| GEV No. | 525585 | Ref. No. | 10029641A |
| description | button round ø 17mm plastic black coffee start/stop SANREMO | | |



| | | | |
|---|--|-----------------|-----------|
|  | | | |
| 1 | | | |
| GEV No. | 525575 | Ref. No. | 10029636A |
| description | button round ø 17mm plastic blue 1 cup large SANREMO | | |

| | | | |
|--|---|-----------------|-----------|
|  | | | |
| 1 | | | |
| GEV No. | 525574 | Ref. No. | 10029616A |
| description | button round ø 17mm plastic red 1 cup small SANREMO | | |

| | | | |
|---|--|-----------------|-----------|
|  | | | |
| 1 | | | |
| GEV No. | 525572 | Ref. No. | 10029635A |
| description | button round ø 17mm plastic blue 1 cup small SANREMO | | |

| | | | |
|--|--|-----------------|-----------|
|  | | | |
| 1 | | | |
| GEV No. | 525583 | Ref. No. | 10029621A |
| description | button round ø 17mm plastic red 2 cups large SANREMO | | |

| | | | |
|---|---|-----------------|-----------|
|  | | | |
| 1 | | | |
| GEV No. | 525581 | Ref. No. | 10029639A |
| description | button round ø 17mm plastic blue 2 cups large SANREMO | | |

| | | | |
|--|--|-----------------|-----------|
|  | | | |
| 1 | | | |
| GEV No. | 525580 | Ref. No. | 10029620A |
| description | button round ø 17mm plastic red 2 cups small SANREMO | | |

| | | | |
|---|---|-----------------|-----------|
|  | | | |
| 1 | | | |
| GEV No. | 525578 | Ref. No. | 10029637A |
| description | button round ø 17mm plastic blue 2 cups small SANREMO | | |

| | | | |
|--|---|-----------------|-----------|
|  | | | |
| 1 | | | |
| GEV No. | 525586 | Ref. No. | 10029622A |
| description | button round ø 17mm plastic red coffee start/stop SANREMO | | |

| | | | |
|---|--|-----------------|-----------|
|  | | | |
| 1 | | | |
| GEV No. | 525584 | Ref. No. | 10029638A |
| description | button round ø 17mm plastic blue coffee start/stop SANREMO | | |

| | | | |
|--|--|-----------------|------------------------|
|  | | | |
| 1 | | | |
| GEV No. | 525588 | Ref. No. | 10029662A 10029662B |
| description | keys round ø 17mm plastic set 2-piece black coffee/water SANREMO | | |

| | | | |
|---|---|-----------------|-----------|
|  | | | |
| 1 | | | |
| GEV No. | 525577 | Ref. No. | 10029619A |
| description | button round ø 17mm plastic red 1 cup large SANREMO | | |



| | | | |
|--|---|-----------------|----------|
|  | | | |
| 1 | | | |
| GEV No. | 525587 | Ref. No. | 10029661 |
| description | keys round ø 17mm plastic set 2-piece blue coffee/water SANREMO | | |

| | | | |
|---|--|-----------------|-----------|
|  | | | |
| 1 | | | |
| GEV No. | 525589 | Ref. No. | 10029663A |
| description | keys round ø 17mm plastic set 2-piece red coffee/water SANREMO | | |







| | | | |
|---|---|-----------------|-----------|
|  | | | |
| 1 | | | |
| GEV No. | 525591 | Ref. No. | 10029656A |
| description | keys round ø 17mm plastic set 6-piece black SANREMO | | |

| | | | |
|---|--|-----------------|----------|
|  | | | |
| 1 | | | |
| GEV No. | 525590 | Ref. No. | 10029657 |
| description | keys round ø 17mm plastic set 6-piece blue SANREMO | | |

| | | | |
|--|---|-----------------|----------------------|
|  | | | |
| 1 | | | |
| GEV No. | 525592 | Ref. No. | 10029645A 8SR9645 |
| description | keys round ø 17mm plastic set 6-piece red SANREMO | | |

| | | | | |
|---|---|-----------------|-----------------|---|
| E-146 series | | | | |
|  | | | | |
| 1 | | | | |
| GEV No. | 370574 | Ref. No. | 10303088 | |
| description | solenoid valve 2-ways 230VAC inlet 1/8" outlet 1/8" connection 1/8" L 30mm DN 2.5mm slide-on receptacle DIN -20° up to 130°C PARKER type series VE-146.2FV coil type ZB09 membranes FKM (water) p max 15bar brass | | | |
| spare parts for | 370574 | | | |
|  | GEV No. | 371029 | Ref. No. | — |
| | solenoid coil PARKER 230VAC 9VA coil type ZB09 seat ø 14mm H 33mm W 34mm D 43mm | | | |

| | | | |
|---|--|-----------------|----------|
| VE-175BV series | | | |
|  | | | |
| 1 | | | |
| GEV No. | 370576 | Ref. No. | 10303080 |
| description | solenoid valve brass 2-ways 230VAC connection DN 2mm -10 up to 140°C PARKER type series VE-175BV coil type WB4.5 membranes FKM (water/steam) p max 15bar p min 0bar flange 25x25mm | | |

| | | | | |
|---|---|-----------------|-----------------|---|
| 3-way | | | | |
| VE-128 series | | | | |
|  | | | | |
| 1 | | | | |
| GEV No. | 370057 | Ref. No. | 10302066 | |
| description | solenoid valve 3-ways 230VAC body outer cone DN 1.2mm slide-on receptacle DIN -20° up to 140°C PARKER type series VE-128 coil type ZB09 membranes ruby p max 10bar brass flange 32x32mm | | | |
| spare parts for | 370057 | | | |
|  | GEV No. | 370062 | Ref. No. | — |
| | solenoid valve body PARKER 3-ways outer cone | | | |
|  | GEV No. | 371029 | Ref. No. | — |
| | solenoid coil PARKER 230VAC 9VA coil type ZB09 seat ø 14mm H 33mm W 34mm D 43mm | | | |
| accessories for | 370057 | | | |
|  | GEV No. | 371090 | Ref. No. | — |
| | power socket plug type DIN 43650A screw | | | |
|  | GEV No. | 371095 | Ref. No. | — |
| | O-ring Viton thickness 1.78mm ID ø 6.07mm Qty 1 pcs | | | |
|  | GEV No. | 371100 | Ref. No. | — |
| | O-ring silicone thickness 1.78mm ID ø 6.07mm Qty 1 pcs | | | |

solenoid valves



solenoid valves (water)

metal

PARKER

2-way

VE-140 series

| | | | | |
|---|---|-----------------|-----------------|---|
|  | | | | |
| 1 | | | | |
| GEV No. | 370575 | Ref. No. | 10303086 | |
| description | solenoid valve 2-ways 230VAC connection 1/8" L 30mm DN 2.5mm slide-on receptacle DIN -10 up to 140°C PARKER type series 11804F1 / 10708T coil type ZB09 membranes ruby p max 30bar 230V nickel-plated brass | | | |
| spare parts for | 370575 | | | |
|  | GEV No. | 371029 | Ref. No. | — |
| | solenoid coil PARKER 230VAC 9VA coil type ZB09 seat ø 14mm H 33mm W 34mm D 43mm | | | |





pressure switches

for coffee machines

miscellaneous



1

| | | | |
|---|---|-----------------|-------------------|
| GEV No. | 541021 | Ref. No. | 10602010A |
| description | pressure control pressure range adjustable 0.5-1.4bar connection 1/4" 30A 3-pole type P302 coffee machine parts SIRAI | | |
| accessories for | 541021 | | |
|  | GEV No. | 550262 | Ref. No. — |
| | flat gasket copper ED ø 20mm ID ø 14mm thickness 2mm | | |
|  | GEV No. | 890100 | Ref. No. — |
| | PTFE tape reel L 12m W 12mm -200 up to +260°C approval DIN-DVGW, KTW temperature-resistant, elastic for fine thread thickness 0.1mm | | |

electrodes

| | | | |
|--|---|-----------------|----------|
|  | | | |
| 1 | | | |
| GEV No. | 400212 | Ref. No. | 10112064 |
| description | level electrode 1/4" total length 120mm probe L 94mm insulated probe length 26mm connection male faston 6.3mm stainless steel ø 2.5mm | | |

| | | | |
|---|--|-----------------|----------|
|  | | | |
| 1 | | | |
| GEV No. | 400214 | Ref. No. | 10112042 |
| description | level electrode 1/4" total length 140mm probe L 112mm insulated probe length 26mm connection male faston 6.3mm stainless steel ø 2.5mm | | |

equipment-specific units

for espresso machines

filter holders

filter holders standard

filter holder without spout



1

| | | | |
|--------------------|--|-----------------|-----|
| GEV No. | 525977 | Ref. No. | N/A |
| description | filter holder suitable for CREM-EXPOBAR/WEGA/GRIMAC/SANRAMO without outlet mounting ø 83mm outlet 3/8" ID ø 61.5mm wedge high 10mm wedge position horizontal number of wedges 2 lever inclined | | |

filter holders short



1

| | | | |
|--------------------|--|-----------------|----------|
| GEV No. | 529933 | Ref. No. | 10052034 |
| description | filter holder mounting ø 82.4mm outlet 3/8" ID ø 61.5mm handle M12x1.75 wedge high 9.5mm wedge position horizontal number of wedges 2 lever inclined chrome-plated, polished | | |



1

| | | | |
|--------------------|---|-----------------|----------|
| GEV No. | 525603 | Ref. No. | 10052034 |
| description | filter holder mounting ø 83mm outlet 3/8" ID ø 61.5mm handle M12x1.75 wedge high 10mm wedge position horizontal number of wedges 2 lever inclined chrome-plated brass | | |

spouts

with thread 3/8"



1

| | | | |
|--------------------|--|-----------------|----------|
| GEV No. | 529003 | Ref. No. | 10052080 |
| description | filter holder spout thread 3/8" 1-way curved/long outlet distancemm thread L 5mm | | |

filters

for 1 cup



1

| | | | |
|--------------------|--|-----------------|----------|
| GEV No. | 529012 | Ref. No. | 10052101 |
| description | coffee filter ø 70mm mounting ø 60.8mm H 19.5mm cups 1 amount of coffee 6g | | |



1

| | | | |
|--------------------|--|-----------------|----------|
| GEV No. | 529011 | Ref. No. | 10052100 |
| description | coffee filter ø 70mm mounting ø 60mm H 24.5mm cups 1 amount of coffee 7g perforation ø 0.4mm | | |

for 2 cups



1

| | | | |
|--------------------|--|-----------------|----------|
| GEV No. | 529013 | Ref. No. | 10052110 |
| description | coffee filter ø 70mm mounting ø 60.5mm H 25.5mm cups 2 amount of coffee 14g perforation ø 0.3x0.3mm square | | |

filter holder springs



1

| | | | |
|--------------------|---|-----------------|----------|
| GEV No. | 531243 | Ref. No. | 10052055 |
| description | filter holder spring L 70mm W 60mm wire gauge ø 1.3mm for espresso filter holder Qty 20 pcs | | |

brewing units

shower screens

flat



1

| | | | |
|--------------------|-----------------------------------|-----------------|----------|
| GEV No. | 529084 | Ref. No. | 10052170 |
| description | shower screen ø 52mm hole ø 6.4mm | | |

with upstand



1

| | | | |
|--------------------|-----------------------------|-----------------|----------|
| GEV No. | 529080 | Ref. No. | 10052120 |
| description | shower screen ø 58mm H 20mm | | |

filter holder gaskets

flat

standard



1

| | | | |
|--------------------|--|-----------------|----------|
| GEV No. | 525607 | Ref. No. | 10502110 |
| description | filter holder gasket D1 ø 73mm D2 ø 57mm H 8.2mm Qty 1 pcs | | |

with bevel 45x2



1

| | | | |
|--------------------|---|-----------------|----------|
| GEV No. | 525606 | Ref. No. | 10502038 |
| description | filter holder gasket D1 ø 73mm D2 ø 56.5mm H 8mm with outside notch | | |

components

nozzles

with thread



1

| | | | |
|--------------------|---|-----------------|----------|
| GEV No. | 528486 | Ref. No. | 10052135 |
| description | nozzle bore ø 0.7mm thread M6x0.75 L 9mm WS 7 | | |

water dispersions

water dispersions

group 2



1

| | | | |
|--------------------|---|-----------------|----------|
| GEV No. | 529081 | Ref. No. | 10052141 |
| description | water distributor ø 30mm hole ø 1.5mm H 15mm ET M10x1 grooves 6 2.5mm brass | | |

safety valves

safety valves

3/8"



1

| | | | |
|--------------------|--|-----------------|----------------------|
| GEV No. | 525619 | Ref. No. | 10652010 10652012 |
| description | safety valve connection 3/8" triggering pressure 1.8bar approval CE 0036 suitable for SANREMO sealed | | |

expansion valves

with hose connection



1

| | | | |
|--------------------|--|-----------------|----------|
| GEV No. | 524667 | Ref. No. | 10655557 |
| description | expansion valve T1: 1/8" ET hose ø 7mm total length 47mm | | |



1

| | | | |
|--------------------|--|-----------------|----------|
| GEV No. | 525618 | Ref. No. | 10655555 |
| description | expansion valve T1: 1/8" ET hose ø 7mm total length 69mm | | |

drain valves



1

| | | | |
|--------------------|---|-----------------|----------|
| GEV No. | 525620 | Ref. No. | 10402059 |
| description | drain fitting inlet 1/8" outlet 1/8" 1/4" shaft 5x5 | | |

drain pans

drain pans



1

| | | | |
|--------------------|---|-----------------|----------|
| GEV No. | 525605 | Ref. No. | 10022461 |
| description | drain pan L 135mm W 110mm H 45mm hole ø 16mm connection rear suitable for SANREMO thread L 14mm | | |



1

| | | | |
|--------------------|--|-----------------|----------|
| GEV No. | 525604 | Ref. No. | 10022429 |
| description | drain pan L 135mm W 110mm H 45mm hole ø 16mm connection right suitable for SANREMO thread L 14mm | | |



1

| | | | |
|--------------------|---|-----------------|----------|
| GEV No. | 525615 | Ref. No. | 10022474 |
| description | drain pan L 90mm W 80mm H 43mm hole ø 16mm suitable for SANREMO | | |

aerators and air bleeders



1

| | | | | |
|---|---|-----------------|-----------------|---|
| GEV No. | 529303 | Ref. No. | 10652040A | |
| description | aerator and air bleeder connection 1/4" only steam | | | |
| spare parts for | 529303 | | | |
|  | GEV No. | 528687 | Ref. No. | — |
| | O-ring Viton thickness 1.78mm ID ø 3.69mm Qty 1 pcs | | | |

steam/water taps

steam/water taps

steam/water taps



1

| | | | |
|--------------------|--------------------------------------|-----------------|-----------|
| GEV No. | 525593 | Ref. No. | 10402120A |
| description | steam/water tap suitable for SANREMO | | |

steam taps

steam taps (complete)



1

| | | | |
|--------------------|---|-----------------|-----|
| GEV No. | 525491 | Ref. No. | N/A |
| description | steam tap complete with handle inlet 1/4" brass pipe SS pipe length 180mm tube ø 10mm | | |



1

| | | | |
|--------------------|--|-----------------|-----|
| GEV No. | 525492 | Ref. No. | N/A |
| description | water pipe complete with handle inlet 1/4" brass pipe SS pipe length 100mm tube ø 10mm | | |

components

bushes



1

| | | | |
|--------------------|--|-----------------|----------|
| GEV No. | 526010 | Ref. No. | 10402015 |
| description | bush steam/water tap D1 ø 10.5mm D2 ø 9mm ID ø 6.3mm H 4.6mm brass | | |

accessories for

| | | | |
|--------------------|---|-----------------|---|
| GEV No. | 526005 | Ref. No. | — |
| description | shaft steam tap ø 14.8mm L 92.5mm thread M6 brass | | |

gaskets



1

| | | | |
|--------------------|---|-----------------|----------|
| GEV No. | 527960 | Ref. No. | 10505558 |
| description | gasket D1 ø 12mm thickness 6mm for steam-/water-tap | | |

steam/water pipes

steam pipes



1

| | | | |
|--------------------|---|-----------------|-----------|
| GEV No. | 525600 | Ref. No. | 10402270A |
| description | steam pipe L 160mm tube ø 10mm IT 3/8" SS SANREMO | | |



1

| | | | |
|--------------------|---|-----------------|-----------|
| GEV No. | 525599 | Ref. No. | 10402286D |
| description | steam pipe L 170mm tube ø 10mm IT 3/8" SS SANREMO | | |



1

| | | | |
|--------------------|---|-----------------|-----------|
| GEV No. | 525598 | Ref. No. | 10402260A |
| description | steam pipe L 200mm tube ø 10mm IT 3/8" SS SANREMO | | |



1

| | | | |
|--------------------|---|-----------------|-----------|
| GEV No. | 525601 | Ref. No. | 10402280A |
| description | steam pipe L 210mm tube ø 10mm IT 3/8" SS SANREMO | | |



1

| | | | |
|--------------------|---|-----------------|----------|
| GEV No. | 525602 | Ref. No. | 10402284 |
| description | steam pipe L 210mm tube ø 10mm IT 3/8" SS SANREMO | | |

nozzles for water pipes

nozzles for water pipes



1

| | | | |
|--------------------|---|-----------------|----------|
| GEV No. | 526637 | Ref. No. | 10402140 |
| description | water nozzle D1 ø 24mm H 29mm int. ø 19mm | | |



water pipes



1

| | | | |
|---|--|-----------------|--------------------------|
| GEV No. | 525616 | Ref. No. | 10402145 |
| description | water pipe thread 3/8" ø 23.5mm L 112mm tube ø 8mm WS 22 | | |
| accessories for | 525616 | | |
|  | GEV No. | 526637 | Ref. No. 10402140 |
| | water nozzle D1 ø 24mm H 29mm int. ø 19mm | | |

accessories

bushes



1

| | | | |
|--------------------|--|-----------------|----------|
| GEV No. | 529705 | Ref. No. | 10402054 |
| description | bush D1 ø 8.3mm D2 ø 12mm H 6mm brass ID ø 7mm | | |

springs



1

| | | | |
|--------------------|---|-----------------|----------|
| GEV No. | 529704 | Ref. No. | 10402043 |
| description | compression spring ø 11.8mm L 16mm wire gauge ø 1.6mm steel | | |

tube handles



1

| | | | |
|--------------------|--|-----------------|----------|
| GEV No. | 525042 | Ref. No. | 10753052 |
| description | tube handle for pipe ø 10mm ø 13.5mm L 50mm rubber | | |



1

| | | | |
|--------------------|------------------------------------|-----------------|----------|
| GEV No. | 528625 | Ref. No. | 10753050 |
| description | tube handle L 35mm rubber ID ø 8mm | | |

fine filters

fine filters



1

| | | | |
|--------------------|----------------------------|-----------------|----------|
| GEV No. | 529979 | Ref. No. | 10052136 |
| description | fine filter ø 8.8mm H 22mm | | |

intake valves

intake valves





1

| | | | |
|--------------------|-----------------------|-----------------|------------------------|
| GEV No. | 531074 | Ref. No. | 10052080B 10056080B |
| description | intake valve complete | | |







1

| | | | |
|---|---|-----------------|--------------------------|
| GEV No. | 525567 | Ref. No. | 10056076A |
| description | intake valve complete for SANREMO | | |
| spare parts for | 525567 | | |
|  | GEV No. | 370575 | Ref. No. 10303086 |
| | solenoid valve 2-ways 230VAC connection 1/8" L 30mm DN 2.5mm slide-on receptacle DIN -10 up to 140°C PARKER type series 11804F1 / 10708T coil type ZB09 membranes ruby p max 30bar 230V nickel-plated brass | | |
|  | GEV No. | 371029 | Ref. No. — |
| | solenoid coil PARKER 230VAC 9VA coil type ZB09 seat ø 14mm H 33mm W 34mm D 43mm | | |









1

| | | | |
|---|---|-----------------|--------------------------|
| GEV No. | 525568 | Ref. No. | 10056061A |
| description | intake valve complete for SANREMO | | |
| spare parts for | 525568 | | |
|  | GEV No. | 370575 | Ref. No. 10303086 |
| | solenoid valve 2-ways 230VAC connection 1/8" L 30mm DN 2.5mm slide-on receptacle DIN -10 up to 140°C PARKER type series 11804F1 / 10708T coil type ZB09 membranes ruby p max 30bar 230V nickel-plated brass | | |
|  | GEV No. | 371029 | Ref. No. — |
| | solenoid coil PARKER 230VAC 9VA coil type ZB09 seat ø 14mm H 33mm W 34mm D 43mm | | |

| | | | |
|---|-----------------------------------|-----------------|-------------------|
|  | | | |
| 1 | | | |
| GEV No. | 525569 | Ref. No. | 10056088 |
| description | intake valve complete for SANREMO | | |
| spare parts for | 525569 | | |
|  | GEV No. | 370575 | Ref. No. 10303086 |
| solenoid valve 2-ways 230VAC connection 1/8" L 30mm DN 2.5mm slide-on receptacle DIN -10 up to 140°C PARKER type series 11804F1 / 10708T coil type ZB09 membranes ruby p max 30bar 230V nickel-plated brass | | | |
|  | GEV No. | 371029 | Ref. No. — |
| solenoid coil PARKER 230VAC 9VA coil type ZB09 seat ø 14mm H 33mm W 34mm D 43mm | | | |

| | | | |
|---|-----------------------------------|-----------------|------------|
|  | | | |
| 1 | | | |
| GEV No. | 525570 | Ref. No. | 10056084 |
| description | intake valve complete for SANREMO | | |
| spare parts for | 525570 | | |
|  | GEV No. | 370202 | Ref. No. — |
| solenoid valve 2-ways 230VAC connection DN 2.5mm slide-on receptacle DIN -20° up to 130°C PARKER type series VE-125 coil type ZB09 membranes FKM (water) p max 10bar flange 32x32mm | | | |
|  | GEV No. | 371029 | Ref. No. — |
| solenoid coil PARKER 230VAC 9VA coil type ZB09 seat ø 14mm H 33mm W 34mm D 43mm | | | |
| accessories for | 525570 | | |
|  | GEV No. | 371090 | Ref. No. — |
| power socket plug type DIN 43650A screw | | | |
|  | GEV No. | 532553 | Ref. No. — |
| O-ring silicone thickness 1.5mm ID ø 13.15mm Qty 1 pcs | | | |
|  | GEV No. | 532554 | Ref. No. — |
| O-ring silicone thickness 1.5mm ID ø 4.1mm Qty 1 pcs | | | |

| | | | |
|---|-----------------------------------|-----------------|------------|
|  | | | |
| 1 | | | |
| GEV No. | 525571 | Ref. No. | 10053162 |
| description | intake valve complete for SANREMO | | |
| spare parts for | 525571 | | |
|  | GEV No. | 370202 | Ref. No. — |
| solenoid valve 2-ways 230VAC connection DN 2.5mm slide-on receptacle DIN -20° up to 130°C PARKER type series VE-125 coil type ZB09 membranes FKM (water) p max 10bar flange 32x32mm | | | |
|  | GEV No. | 371029 | Ref. No. — |
| solenoid coil PARKER 230VAC 9VA coil type ZB09 seat ø 14mm H 33mm W 34mm D 43mm | | | |
| accessories for | 525571 | | |
|  | GEV No. | 371090 | Ref. No. — |
| power socket plug type DIN 43650A screw | | | |

| | | | |
|---|---------|--------|------------|
| accessories for | 525571 | | |
|  | GEV No. | 532553 | Ref. No. — |
| O-ring silicone thickness 1.5mm ID ø 13.15mm Qty 1 pcs | | | |
|  | GEV No. | 532554 | Ref. No. — |
| O-ring silicone thickness 1.5mm ID ø 4.1mm Qty 1 pcs | | | |

level glasses

level glasses

level glasses (complete)

| | | | |
|---|---|-----------------|----------|
|  | | | |
| 1 | | | |
| GEV No. | 525595 | Ref. No. | 10402110 |
| description | water level tube L 212mm W 55mm thread 1/4" | | |

| | | | |
|--|---|-----------------|-----------|
|  | | | |
| 1 | | | |
| GEV No. | 525594 | Ref. No. | 10402170A |
| description | water level tube L 212mm W 55mm thread 3/8" | | |

| | | | |
|---|--|-----------------|----------|
|  | | | |
| 1 | | | |
| GEV No. | 525596 | Ref. No. | 10402109 |
| description | water level tube L 215mm W 60mm complete thread 3/8" | | |



1

| | | | |
|--------------------|--|-----------------|----------|
| GEV No. | 525597 | Ref. No. | 10402168 |
| description | water level tube L 222mm W 55mm complete thread 3/8" | | |

level glass pipes



1

| | | | |
|--------------------|--|-----------------|----------|
| GEV No. | 529393 | Ref. No. | 10402100 |
| description | water level tube ø 11mm H 140mm ID ø 8mm marking Min/Max | | |

non-return valves

complete



1

| | | | |
|--------------------|---|-----------------|-----------|
| GEV No. | 525617 | Ref. No. | 10652020B |
| description | non-return valve inlet 1/4" outlet 1/8" L 62mm suitable for SANREMO | | |

miscellaneous



1

| | | | |
|--------------------|--|-----------------|-----------|
| GEV No. | 525621 | Ref. No. | 10255028A |
| description | connecting fitting for solenoid valve T1: 1/8" for SANREMO | | |

knobs

producer-specific knobs

SANREMO



1

| | | | |
|--------------------|--|-----------------|----------|
| GEV No. | 111371 | Ref. No. | 10122012 |
| description | knob ø 27/46mm black shaft diameter 6x6mm with screw | | |

steam/water taps

steam/water taps



1

| | | | |
|--------------------|-------------------------------|-----------------|-----------|
| GEV No. | 111341 | Ref. No. | 10092160A |
| description | knob ø 43mm for rotary switch | | |



1

| | | | |
|--------------------|---|-----------------|----------|
| GEV No. | 111334 | Ref. No. | 10402074 |
| description | turning handle without symbol ø 41mm L 50mm black | | |



1

| | | | |
|--------------------|--|-----------------|----------|
| GEV No. | 111337 | Ref. No. | 10092164 |
| description | turning handle without symbol ø 48mm black | | |



1

| | | | |
|--------------------|--|-----------------|----------|
| GEV No. | 111338 | Ref. No. | 10091140 |
| description | turning handle without symbol ø 52mm black | | |

knob dial plates



1

| | | | |
|--------------------|----------------------------|-----------------|----------|
| GEV No. | 111275 | Ref. No. | 10351104 |
| description | symbol steam ø 32mm L 28mm | | |



1

| | | | |
|--------------------|----------------------------------|-----------------|----------|
| GEV No. | 111335 | Ref. No. | 10351114 |
| description | symbol steam ø 32mm L 29mm black | | |





1

| | | | |
|--------------------|------------------------------|-----------------|----------|
| GEV No. | 111340 | Ref. No. | 10091142 |
| description | symbol tail +/- ø 45mm black | | |

| | | | |
|--------------------|---|-----------------|----------|
| 1 |  | | |
| GEV No. | 111339 | Ref. No. | 10092162 |
| description | symbol tail +/- ø 47mm black | | |

| | | | |
|--------------------|---|-----------------|----------|
| 1 |  | | |
| GEV No. | 111276 | Ref. No. | 10351105 |
| description | symbol water ø 32mm L 28mm | | |

| | | | |
|--------------------|---|-----------------|----------|
| 1 |  | | |
| GEV No. | 111336 | Ref. No. | 10351115 |
| description | symbol water ø 32mm L 29mm black | | |

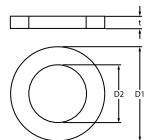
| | | | |
|--------------------|---|---|-----------|
| 1 |  |  | |
| GEV No. | 528223 | Ref. No. | 10402063A |
| description | O-ring EPDM thickness 2.62mm ID ø 11.91mm Qty 1 pcs | | |

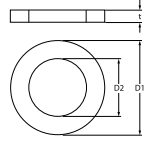
| | | | |
|--------------------|---|---|----------|
| 1 |  |  | |
| GEV No. | 505073 | Ref. No. | 10502100 |
| description | O-ring EPDM thickness 2.62mm ID ø 20.63mm Qty 1 pcs | | |

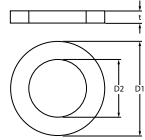
| | | | |
|--------------------|---|---|-----------|
| 1 |  |  | |
| GEV No. | 540222 | Ref. No. | 10502070A |
| description | O-ring EPDM thickness 2.62mm ID ø 47.3mm Qty 1 pcs | | |

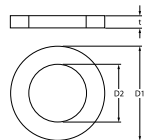
| | | | |
|--------------------|--|--|----------|
| 1 |  |  | |
| GEV No. | 525608 | Ref. No. | 10402082 |
| description | O-ring EPDM thickness 2.7mm ID ø 12.1mm | | |

fittings for catering equipment

drain taps

accessories

| | | | |
|--------------------|--|-----------------|-----------|
| 1 |  | | |
| GEV No. | 540222 | Ref. No. | 10502070A |
| description | O-ring EPDM thickness 2.62mm ID ø 47.3mm Qty 1 pcs | | |

gaskets

O-rings

EPDM

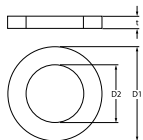
| | | | |
|--------------------|---|---|-----------|
| 1 |  |  | |
| GEV No. | 528485 | Ref. No. | 10502041A |
| description | O-ring EPDM thickness 1.78mm ID ø 6.07mm Qty 1 pcs | | |

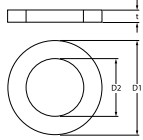
| | | | |
|--------------------|---|---|----------|
| 1 |  |  | |
| GEV No. | 529412 | Ref. No. | 10705015 |
| description | O-ring EPDM thickness 2.62mm ID ø 10.78mm Qty 1 pcs | | |

silicone

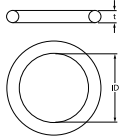
| | | | |
|--------------------|---|---|----------|
| 1 |  |  | |
| GEV No. | 523014 | Ref. No. | 10505082 |
| description | O-ring silicone thickness 2.2mm ID ø 9mm Qty 1 pcs | | |

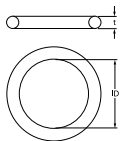
| | | | |
|--------------------|---|---|----------|
| 1 |  |  | |
| GEV No. | 532561 | Ref. No. | 10505080 |
| description | O-ring silicone thickness 2.62mm ID ø 71.12mm Qty 1 pcs | | |

Viton

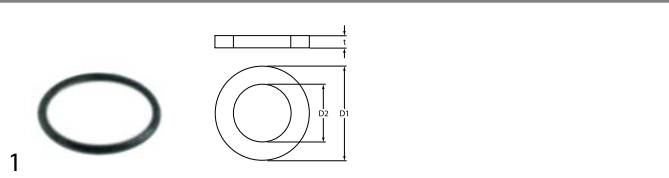

| | | | |
|--------------------|---|-----------------|-----------|
| GEV No. | 532565 | Ref. No. | 10402056A |
| description | O-ring Viton thickness 1.78mm ID ø 15.6mm Qty 1 pcs | | |

NBR

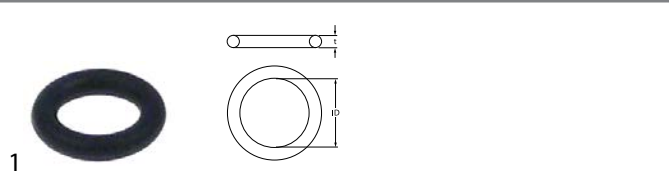

| | | | |
|--------------------|---|-----------------|----------|
| GEV No. | 525614 | Ref. No. | 10505121 |
| description | O-ring NBR thickness 1.9mm ID ø 5.7mm Qty 1 pcs | | |

miscellaneous

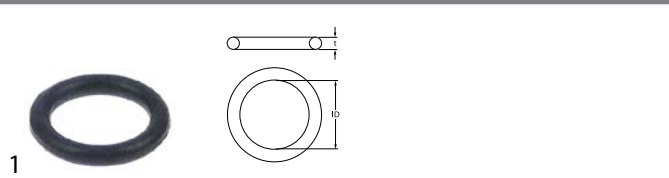

| | | | |
|--------------------|---|-----------------|----------|
| GEV No. | 525608 | Ref. No. | 10402082 |
| description | O-ring EPDM thickness 2.7mm ID ø 12.1mm | | |

sealing washers

copper gaskets

DIN-7603-A



| | | | |
|--------------------|--|-----------------|----------|
| GEV No. | 526860 | Ref. No. | 10042017 |
| description | flat gasket copper ED ø 19mm ID ø 13.5mm thickness 1.5mm for thread 1/4" Qty 1 pcs | | |

DIN-7603-C



| | | | |
|--------------------|---|-----------------|----------|
| GEV No. | 528501 | Ref. No. | 10505561 |
| description | gasket copper ED ø 22mm ID ø 16mm thickness 3mm | | |

PTFE gaskets



| | | | |
|--------------------|--|-----------------|----------|
| GEV No. | 525609 | Ref. No. | 10505550 |
| description | flat gasket PTFE ED ø 18mm ID ø 13.5mm thickness 2mm Qty 1 pcs | | |



| | | | |
|--------------------|--|-----------------|-----------|
| GEV No. | 528314 | Ref. No. | 105052143 |
| description | flat gasket PTFE ED ø 20mm ID ø 17mm thickness 2mm Qty 1 pcs suitable for Astoria/Azkoyen/Espresa/Wega | | |



| | | | |
|--------------------|--|-----------------|------------------------|
| GEV No. | 525611 | Ref. No. | 10502105A 10502109A |
| description | flat gasket PTFE ED ø 22mm ID ø 17mm thickness 2mm Qty 1 pcs | | |



| | | | |
|--------------------|--|-----------------|-----------|
| GEV No. | 525610 | Ref. No. | 10502090A |
| description | flat gasket PTFE ED ø 35mm ID ø 30mm thickness 2mm Qty 1 pcs | | |



| | | | |
|--------------------|--|-----------------|----------|
| GEV No. | 525612 | Ref. No. | 10502020 |
| description | flat gasket PTFE ED ø 56mm ID ø 42mm thickness 2mm Qty 1 pcs | | |

special gaskets

group gaskets

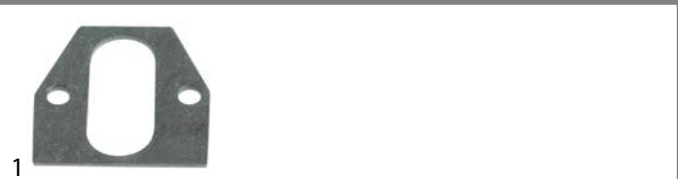

| | | | |
|--------------------|--|-----------------|----------|
| GEV No. | 528165 | Ref. No. | 10502130 |
| description | group gasket L 76mm W 72mm thickness 2.5mm aperture 26x64mm hole distance 55mm | | |

springs

compression springs



1

GEV No. 528503 **Ref. No.** 10402014

description compression spring ø 10.5mm L 32mm wire gauge ø 1.4mm

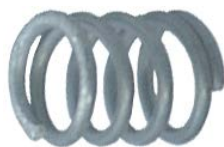

1

GEV No. 529704 **Ref. No.** 10402043

description compression spring ø 11.8mm L 16mm wire gauge ø 1.6mm steel

manometers



1

GEV No. 541729 **Ref. No.** 10552015

description manometer double scale ø 60mm pressure range 0-3 / 0-15bar connection on the backside thread 1/8" suitable for SANREMO



1

GEV No. 541730 **Ref. No.** 10552021A

description manometer double scale ø 60mm pressure range 0-3 / 0-15bar connection on the backside thread 1/8" suitable for SANREMO



1

GEV No. 541731 **Ref. No.** 10552013A

description manometer double scale ø 63mm pressure range 0-3 / 0-15bar connection on the backside thread 1/8" suitable for SANREMO

fastening material

screws

countersunk screws



1

GEV No. 560040 **Ref. No.** 10801032
10805303

description countersunk screw thread M5 L 12mm WS 3 SS DIN 7991/ISO 10642 Qty 20 pcs intake hexagonal

B

bi-metal thermostats 3

C

countersunk screws 20

E

electrodes 11

F

fastening material 20

H

heating elements 3

heating elements for coffee machine 3

I

indicator lights 5

indicator lights (complete) 5

L

lamps 5

O

O-rings 18

P

pressure switches 11

probes 5

push/momentary push switches 4

R

relays 5

rocker/momentary rocker switches 3

rotary switches 4

S

safety bi-metal thermostats 3

safety thermostats 3

screws 20

sealing washers 19

solenoid valves 10

solid state relays 5

switches and momentary switches 3

system switches (ROLD) 4

T

thermostats 3