



**GAS COMPONENTS**



**ELECTRIC COMPONENTS**



**WATER TECHNOLOGY**



**MECHANICAL COMPONENTS**



**TOOLS**

Spare parts suitable for

**SANTOS**

Find the complete and up-to-date range of products in our GEV Webshop



# Manufacturer catalogue

The most important spare parts and accessories arranged clearly for every manufacturer

- ✓ Complete product range and all appliance data always up to date in the GEV Webshop
- ✓ Alphabetical Index at the end of the catalogue

## GEV Webshop

[www.gev-online.co.uk](http://www.gev-online.co.uk)

[www.gev-online.com](http://www.gev-online.com)



- 🔍 Add to Favourites
- 🔍 Sign In with email address and usual password
- 🔍 Easy-order – place several items in your basket at the same time
- 🔍 Quick Item search – no login needed



switches and momentary switches

rocker/momentary rocker switches

30x22mm

labelled



<b>GEV No.</b>	301006	<b>Ref. No.</b>	40670 55670 60670
<b>description</b>	rocker switch mounting measurements 30x22mm orange 2NO 250V 16A illuminated connection male faston 6.3mm ambient temperature max. 125/55°C protection IP65 with cover cap		
<b>For models:</b>	N40A-Snr-238645-360811, Nr40A-Snr-217500-268355, Nr40A-Snr-268356-272259, Nr40A-Snr-272260-289551, Nr40A-Snr-360812-639299, Nr40A-Snr-639300-, Nr40-Snr-289552-338644, Nr55, Nr55-Snr-598198-639299, Nr55-Snr-639300-, Nr60-Snr-576986-646551, Nr60-Snr-646552-		
<b>accessories for</b>	301006		
	<b>GEV No.</b>	301036	<b>Ref. No.</b> —
	protective cover internal size 30x22mm for rocker switch mounting measurementsmm		

microswitches

lever actuated



<b>GEV No.</b>	345742	<b>Ref. No.</b>	40752A
<b>description</b>	microswitch with lever 250V 16A 1CO connection male faston 6.3mm L 55mm ambient temperature max. 120°C mounting distance 22mm actuating force: 75g lever length 46mm		
<b>For models:</b>	N40A-Snr-238645-360811, Nr40APP, Nr40A-Snr-217500-268355, Nr40A-Snr-268356-272259, Nr40A-Snr-272260-289551, Nr40A-Snr-360812-639299, Nr40A-Snr-639300-, Nr40-Snr-289552-338644		

pin-plunger actuated



<b>GEV No.</b>	345326	<b>Ref. No.</b>	27309 48374
<b>description</b>	microswitch with plunger 250V 16A 1NO connection male faston 6.3mm ambient temperature max. 85°C mounting distance 22mm type XP52Z11 actuating force: 350g red stroke 15mm		
<b>For models:</b>	Nr27-Snr-000000-164272, Nr27-Snr-164272-275588, Nr27-Snr-275588-383714, Nr27-Snr-383715-, Nr48		



<b>GEV No.</b>	527603	<b>Ref. No.</b>	55800
<b>description</b>	microswitch set 30V 0.3A 1NO connection male faston 4.8mm ambient temperature max. 85°C		
<b>For models:</b>	Nr55, Nr55-Snr-598198-639299, Nr55-Snr-639300-		

rotary switches

GOTTAK



<b>GEV No.</b>	347179	<b>Ref. No.</b>	06612
<b>description</b>	rotary switch 2 0-1-0-1 sets of contacts 1 250V 16A shaft ø 6x4mm shaft L 25mm shaft oval connection male faston 2 operating positions for coffee grinder		
<b>For models:</b>	Nr6-249928-, Nr6-Snr-249929-264559, Nr6-Snr-264560-339744, Nr6-Snr-385437-		
<b>accessories for</b>	347179		
	<b>GEV No.</b>	527598	<b>Ref. No.</b> 06614
	knob ø 35mm shaft ø 6x4.6mm shaft flat lateral		

electronics

PCBs



<b>GEV No.</b>	402205	<b>Ref. No.</b>	55730
<b>description</b>	display PCB for dosing pump L 95mm W 60mm		
<b>For models:</b>	Nr55-Snr-598198-639299, Nr55-Snr-639300-		



<b>GEV No.</b>	402206	<b>Ref. No.</b>	55632
<b>description</b>	PCB for dosing pump L 98mm W 72mm 220/240V		
<b>For models:</b>	Nr55-Snr-598198-639299		



<b>GEV No.</b>	402204	<b>Ref. No.</b>	60620
<b>description</b>	PCB for dosing pump L 98mm W 72mm 230V		
<b>For models:</b>	Nr60-Snr-576986-646551, Nr60-Snr-646552-		

## keypads

### front foils



<b>GEV No.</b>	402203	<b>Ref. No.</b>	55704
<b>description</b>	keypad foil for dosing pump L 98mm W 29mm buttons 4		
<b>For models:</b>	Nr55, Nr55-Snr-598198-639299, Nr55-Snr-639300-		

### accessories



<b>GEV No.</b>	527595	<b>Ref. No.</b>	55810
<b>description</b>	button L 30mm W 25mm for dosing pump		
<b>For models:</b>	Nr55, Nr55-Snr-598198-639299, Nr55-Snr-639300-		

## compressors

### accessories

#### starting relays

##### klixons



<b>GEV No.</b>	380890	<b>Ref. No.</b>	06606 40606
<b>description</b>	start relay 2CR3-142 230V connection F6.3		
<b>For models:</b>	N40A-Snr-238645-360811, Nr40A-Snr-217500-268355, Nr40A-Snr-268356-272259, Nr40A-Snr-272260-289551, Nr40A-Snr-360812-639299, Nr40A-Snr-639300-, Nr40-Snr-289552-338644, Nr6, Nr6-249928-, Nr6-Snr-249929-264559, Nr6-Snr-264560-339744, Nr6-Snr-385437-		



<b>GEV No.</b>	380893	<b>Ref. No.</b>	09409
<b>description</b>	start relay 2CR4-175 230V connection F6.3		



<b>GEV No.</b>	380904	<b>Ref. No.</b>	09409
<b>description</b>	start relay 4CR-1-675 220V mounting distance 55mm F6.3		
<b>For models:</b>	Nr9-Snr-119318-, Nr9-Snr-288850-, Nr9-Snr-347841-449742, Nr9-Snr-449743-		



<b>GEV No.</b>	381360	<b>Ref. No.</b>	28505
<b>description</b>	start relay Klixon 4CR-1-730 220/240V voltage AC		
<b>For models:</b>	Nr28_Version1, Nr28-Snr-170543-, Nr28-Snr-170544-290190, Nr28-Snr-290191-		

## condensators & interference suppression filters

### starting capacitors

#### starting capacitors



<b>GEV No.</b>	365106	<b>Ref. No.</b>	06609 40609
<b>description</b>	starting capacitor 100µF 250V 50/60Hz duty cycle 3s 04P.47804S ø 46mm L 85mm plastic connection male faston 6.3mm		
<b>For models:</b>	N40A-Snr-238645-360811, Nr40A-Snr-217500-268355, Nr40A-Snr-268356-272259, Nr40A-Snr-272260-289551, Nr40A-Snr-360812-639299, Nr40A-Snr-639300-, Nr40-Snr-289552-338644, Nr6-249928-, Nr6-Snr-249929-264559, Nr6-Snr-264560-339744, Nr6-Snr-385437-		

## fuses

### overload switches



<b>GEV No.</b>	358013	<b>Ref. No.</b>	06752A 40616
<b>description</b>	overload switch 1-pole drop-away current 3A rated 220/240V type 106-P10-3A		
<b>For models:</b>	N40A-Snr-238645-360811, Nr40A-Snr-217500-268355, Nr40A-Snr-360812-639299, Nr40A-Snr-639300-		



<b>GEV No.</b>	358014	<b>Ref. No.</b>	55616
<b>description</b>	overload switch 1-pole drop-away current 5A rated 220/240V type 106-P10-5A		
<b>For models:</b>	Nr55, Nr55-Snr-598198-639299, Nr55-Snr-639300-		



 <p>1</p>			
<b>GEV No.</b>	358137	<b>Ref. No.</b>	27505 48605 50730
<b>description</b>	switch drop-away current 4A		
<b>For models:</b>	Nr27-Snr-275588-383714, Nr27-Snr-383715-, Nr48, Nr50-Snr-000000-661901, Nr50-Snr-661901-		

## electronic components

### accessories

 <p>1</p>			
<b>GEV No.</b>	527596	<b>Ref. No.</b>	55711
<b>description</b>	bracket for PCB L 103mm W 71mm plastic		
<b>For models:</b>	Nr55, Nr55-Snr-598198-639299, Nr55-Snr-639300-		

## equipment-specific units

### for planetary mixers

#### miscellaneous

 <p>1</p>			
<b>GEV No.</b>	697861	<b>Ref. No.</b>	27200
<b>description</b>	safety switch suitable for SANTOS		
<b>For models:</b>	Nr27-Snr-000000-164272, Nr27-Snr-164272-275588, Nr27-Snr-354091-383714		

### for bar blender

#### blenders

#### jar components

#### gaskets

 <p>1</p>			
<b>GEV No.</b>	650274	<b>Ref. No.</b>	37104 37109
<b>description</b>	lid gasket rubber D1 ø 170mm D2 ø 200mm thickness 16mm capacity 4l		
<b>For models:</b>	Nr37-Snr-116617-164864, Nr37-Snr-164865-256894, Nr37-Snr-256895-		

#### blades

#### blades with adaptor (complete)

 <p>1</p>			
<b>GEV No.</b>	650289	<b>Ref. No.</b>	37170 37180
<b>description</b>	slicing unit complete for mixer ø 86.5mm		
<b>For models:</b>	Nr37-Snr-116617-164864, Nr37-Snr-164865-256894, Nr37-Snr-256895-		

#### miscellaneous

 <p>1</p>			
<b>GEV No.</b>	650291	<b>Ref. No.</b>	37176
<b>description</b>	V-ring ømm Lmm thread ID ø 14mm ED ø 20mm IT H 5.5mm WS Qty pcs thicknessmm		
<b>For models:</b>	Nr37-Snr-116617-164864, Nr37-Snr-164865-256894, Nr37-Snr-256895-		

#### actuators

#### group 2

 <p>1</p>			
<b>GEV No.</b>	650287	<b>Ref. No.</b>	37196
<b>description</b>	coupling for knife ø 52mm H 20mm teeth 12		
<b>For models:</b>	Nr37-Snr-256895-		

 <p>1</p>			
<b>GEV No.</b>	650286	<b>Ref. No.</b>	33245
<b>description</b>	coupling for motor ø 29.5mm H 11mm teeth 12 no. 33		
<b>For models:</b>	Nr33-Snr-260269-339386, Nr33-Snr-339387-		





1

<b>GEV No.</b>	650284	<b>Ref. No.</b>	37340
----------------	--------	-----------------	-------

<b>description</b>	coupling for motor $\varnothing$ 40.5mm H 12mm teeth 12		
--------------------	---	--	--



1

<b>GEV No.</b>	650285	<b>Ref. No.</b>	37330
----------------	--------	-----------------	-------

<b>description</b>	coupling for motor $\varnothing$ 41mm H 12mm teeth 12		
--------------------	---	--	--

<b>For models:</b>	Nr37-Snr-256895-		
--------------------	------------------	--	--



1

<b>GEV No.</b>	650288	<b>Ref. No.</b>	37199
----------------	--------	-----------------	-------

<b>description</b>	coupling set for mixer $\varnothing$ mm Hmm teeth		
--------------------	---	--	--

<b>spare parts for</b>	650288		
------------------------	--------	--	--



<b>GEV No.</b>	650285	<b>Ref. No.</b>	37330
----------------	--------	-----------------	-------

<b>description</b>	coupling for motor $\varnothing$ 41mm H 12mm teeth 12		
--------------------	---	--	--



<b>GEV No.</b>	650287	<b>Ref. No.</b>	37196
----------------	--------	-----------------	-------

<b>description</b>	coupling for knife $\varnothing$ 52mm H 20mm teeth 12		
--------------------	---	--	--

## mixers

### miscellaneous



1

<b>GEV No.</b>	650279	<b>Ref. No.</b>	37184
----------------	--------	-----------------	-------

<b>description</b>	gasket for knife Lmm Wmm ID $\varnothing$ 76mm ED $\varnothing$ 85mm H 7.8mm		
--------------------	--	--	--

<b>For models:</b>	Nr37-Snr-116617-164864, Nr37-Snr-164865-256894, Nr37-Snr-256895-		
--------------------	--	--	--

## for hand blenders

### spare parts and accessories



1

<b>GEV No.</b>	692756	<b>Ref. No.</b>	33107
----------------	--------	-----------------	-------

<b>description</b>	slicing unit $\varnothing$ 70mm		
--------------------	---------------------------------	--	--

<b>For models:</b>	Nr33-Snr-000000-116000, Nr33-Snr-116000-229284, Nr33-Snr-229284-260268, Nr33-Snr-260269-339386		
--------------------	--	--	--

## for juicers/centrifuges

### lids



1

<b>GEV No.</b>	650227	<b>Ref. No.</b>	50151
----------------	--------	-----------------	-------

<b>description</b>	lid for juicer suitable for SANTOS N50		
--------------------	--	--	--

<b>For models:</b>	Nr50-Snr-000000-661901, Nr50-Snr-661901-		
--------------------	--	--	--

### couplings



1

<b>GEV No.</b>	650233	<b>Ref. No.</b>	33240
----------------	--------	-----------------	-------

<b>description</b>	coupling set $\varnothing$ 37mm H 15mm		
--------------------	--	--	--

<b>For models:</b>	Nr33-Snr-260269-339386, Nr33-Snr-339387-		
--------------------	--	--	--

### actuators



1

<b>GEV No.</b>	650229	<b>Ref. No.</b>	58350
----------------	--------	-----------------	-------

<b>description</b>	mixer coupling with accessories $\varnothing$ 82mm H 54mm ID $\varnothing$ 15mm with screw		
--------------------	--	--	--

<b>For models:</b>	Nr58, Nr58-Snr-652469-696539, Nr58-Snr-697619-		
--------------------	--	--	--



1

<b>GEV No.</b>	650282	<b>Ref. No.</b>	50400
<b>description</b>	mixer coupling with screw ø 82mm H 53mm ID ø 15mm IT		
<b>For models:</b>	Nr50-Snr-000000-661901, Nr50-Snr-661901-		
<b>spare parts for</b>	650282		
	<b>GEV No.</b>	650280	<b>Ref. No.</b>
			50411 58361
	rubber gasket		



1

<b>GEV No.</b>	650281	<b>Ref. No.</b>	58360
<b>description</b>	mixer coupling without accessories ø 82mm H 54mm IT ID ø 15mm		
<b>For models:</b>	Nr58, Nr58-Snr-652469-696539, Nr58-Snr-697619-		
<b>spare parts for</b>	650281		
	<b>GEV No.</b>	650280	<b>Ref. No.</b>
			50411 58361
	rubber gasket		

centrifuge baskets

grating discs



1

<b>GEV No.</b>	696410	<b>Ref. No.</b>	50210
<b>description</b>	grating disc for juicer ø 111mm seat ø 8x10mm		
<b>For models:</b>	Nr50-Snr-000000-661901, Nr50-Snr-661901-		



1

<b>GEV No.</b>	696433	<b>Ref. No.</b>	28202
<b>description</b>	grating disc for juicer ø 165mm seat ø 7mm		
<b>For models:</b>	Nr28_Version1, Nr28-Snr-170543-, Nr28-Snr-170544-290190, Nr28-Snr-290191-		



1

<b>GEV No.</b>	650228	<b>Ref. No.</b>	28201
<b>description</b>	grating disc SS complete ø 165mm H 2.5mm suitable for SANTOS		
<b>For models:</b>	Nr28_Version1, Nr28-Snr-170543-, Nr28-Snr-170544-290190, Nr28-Snr-290191-		



1

<b>GEV No.</b>	650230	<b>Ref. No.</b>	58202
<b>description</b>	grating disc SS ø 165mm H 2.5mm		
<b>For models:</b>	Nr58, Nr58-Snr-652469-696539, Nr58-Snr-697619-		

centrifuge baskets



1

<b>GEV No.</b>	698331	<b>Ref. No.</b>	50200
<b>description</b>	centrifuge basket plastic/SS complete ø 205mm H 125mm		
<b>For models:</b>	Nr50-Snr-000000-661901, Nr50-Snr-661901-		



1

<b>GEV No.</b>	650234	<b>Ref. No.</b>	28200
<b>description</b>	centrifuge basket SS complete ø 259mm H 126mm		
<b>For models:</b>	Nr28_Version1, Nr28-Snr-170543-, Nr28-Snr-170544-290190, Nr28-Snr-290191-		

## miscellaneous



1

<b>GEV No.</b>	650270	<b>Ref. No.</b>	50950
<b>description</b>	container for juicer NR50		
<b>For models:</b>	Nr50-Snr-000000-661901, Nr50-Snr-661901-		



1

<b>GEV No.</b>	650280	<b>Ref. No.</b>	50411 58361
<b>description</b>	rubber gasket		
<b>For models:</b>	Nr50-Snr-000000-661901, Nr50-Snr-661901-, Nr58, Nr58-Snr-652469-696539, Nr58-Snr-697619-		

## plungers



1

<b>GEV No.</b>	650231	<b>Ref. No.</b>	28100
<b>description</b>	plunger ø 60mm L 158mm total length 204mm		
<b>For models:</b>	Nr28_Version1, Nr28-Snr-170543-, Nr28-Snr-170544-290190, Nr28-Snr-290191-		



1

<b>GEV No.</b>	650276	<b>Ref. No.</b>	58100 68100
<b>description</b>	plunger ø 75.5mm L 155mm total length 250mm for citrus juicers		
<b>For models:</b>	Nr58, Nr58-Snr-652469-696539, Nr58-Snr-697619-		



1

<b>GEV No.</b>	650275	<b>Ref. No.</b>	50101
<b>description</b>	plunger ø 76mm L 160mm total length 175mm for juicer		
<b>For models:</b>	Nr50-Snr-000000-661901, Nr50-Snr-661901-		

## for citrus juicers

## levers



1

<b>GEV No.</b>	650290	<b>Ref. No.</b>	10100
<b>description</b>	press lever for citrus juicers complete Lmm Wmm thread hole ømm no.10		
<b>For models:</b>	Nr10-Snr-000000-101050, Nr10-Snr-101051-402800, Nr10-Snr-402801-, Nr10-Snr-673752-		

## juicer insert



1

<b>GEV No.</b>	650235	<b>Ref. No.</b>	11201
<b>description</b>	filter for citrus juicers ø 155mm H 23mm plastic		
<b>For models:</b>	Nr11, Nr11-Snr-201132-, Nr11-Snr-201133-, Nr11-Snr-472893-, Nr11-Snr-472894-606107, Nr11-Snr-606108-		







			
1			
<b>GEV No.</b>	650237	<b>Ref. No.</b>	11103
<b>description</b>	juicer insert for citrus juicers ø 81mm H 52mm plastic		
<b>For models:</b>	Nr11-Snr-472893-, Nr11-Snr-472894-606107, Nr11-Snr-606108-		

			
1			
<b>GEV No.</b>	694599	<b>Ref. No.</b>	50230
<b>description</b>	bracket ø 150mm H 56mm		
<b>For models:</b>	Nr50-Snr-000000-661901, Nr50-Snr-661901-		

			
1			
<b>GEV No.</b>	650277	<b>Ref. No.</b>	11150 29150
<b>description</b>	juicer insert for citrus juicers ø 81mm H 55mm plastic		
<b>For models:</b>	Nr11-Snr-472894-606107, Nr11-Snr-606108-		

			
1			
<b>GEV No.</b>	650273	<b>Ref. No.</b>	11204 11204NJ
<b>description</b>	drain tray for citrus juicers with outlet ø 165mm H 125mm plastic yellow		
<b>For models:</b>	Nr11, Nr11-Snr-201132-, Nr11-Snr-201133-, Nr11-Snr-472893-, Nr11-Snr-472894-606107, Nr11-Snr-606108-		

			
1			
<b>GEV No.</b>	650278	<b>Ref. No.</b>	52200
<b>description</b>	juicer insert for citrus juicers ø 81mm H 55mm plastic		
<b>For models:</b>	Nr52		

			
1			
<b>GEV No.</b>	650232	<b>Ref. No.</b>	10606
<b>description</b>	pin ø 5mm L 18mm SS		
<b>For models:</b>	Nr10-Snr-000000-101050, Nr10-Snr-101051-402800, Nr10-Snr-402801-, Nr10-Snr-673752-		

			
1			
<b>GEV No.</b>	650236	<b>Ref. No.</b>	11101
<b>description</b>	juicer insert for citrus juicers ø 82mm H 55mm plastic		
<b>For models:</b>	Nr11, Nr11-Snr-472894-606107, Nr11-Snr-606108-		

for coffee grinders

grinding burrs

grinding burrs straight

standard

			
1			
<b>GEV No.</b>	650206	<b>Ref. No.</b>	10200
<b>description</b>	juicer insert with filter for juice extractor ø 110mm H 75mm SS		
<b>For models:</b>	Nr10-Snr-000000-101050, Nr10-Snr-101051-402800, Nr10-Snr-402801-, Nr10-Snr-673752-		

			
1			
<b>GEV No.</b>	527238	<b>Ref. No.</b>	00001B 01222+01227 06205+06302 2x55205 2x60205 40205+40302
<b>description</b>	grinding burrs pair turn direction left D1 ø 63.5mm ID ø 35.5mm H 9mm tooth spacing 3.5mm hole ø 5.5mm bore ø 8.5mm mounting ø 47.5 straight suitable for SANTOS teeth 50		

<b>miscellaneous</b>			
			
1			
<b>GEV No.</b>	694290	<b>Ref. No.</b>	50230
<b>description</b>	bracket ø 150mm H 56mm		

			
1			
<b>GEV No.</b>	527604	<b>Ref. No.</b>	00001B 06205+06302 2x55205 2x60205 40205+40302
<b>description</b>	grinding burrs pair turn direction left D1 ø 63.5mm ID ø 35.8mm H 9mm tooth spacing 4mm hole ø 5.5mm bore ø 8.5mm mounting ø 47		

## grinding burrs holders

			
1			
<b>GEV No.</b>	527575	<b>Ref. No.</b>	06300 40300 60300
<b>description</b>	grinding burr holder turn direction left D1 ø 63.5mm D2 ø 70mm H 32mm with grinding burr mounting pos. lower		
<b>For models:</b>	N40A-Snr-238645-360811, Nr40APPM, Nr40A-Snr-217500-268355, Nr40A-Snr-268356-272259, Nr40A-Snr-272260-289551, Nr40A-Snr-360812-639299, Nr40A-Snr-639300-, Nr40-Snr-289552-338644, Nr6, Nr60-Snr-576986-646551, Nr60-Snr-646552-, Nr6-249928-, Nr6-Snr-249929-264559, Nr6-Snr-264560-339744, Nr6-Snr-385437-		

			
1			
<b>GEV No.</b>	527597	<b>Ref. No.</b>	55300
<b>description</b>	grinding burr holder turn direction right D1 ø 82mm D2 ø 12mm H 76.5mm complete mounting pos. lower		
<b>For models:</b>	Nr55, Nr55-Snr-598198-639299		

## spillage trays

			
1			
<b>GEV No.</b>	527486	<b>Ref. No.</b>	40662B 55662 60662
<b>description</b>	drain tray L 200mm W 160mm for dosing pump		
<b>For models:</b>	Nr40A-Snr-360812-639299, Nr40A-Snr-639300-, Nr55, Nr55-Snr-598198-639299, Nr55-Snr-639300-, Nr60-Snr-576986-646551, Nr60-Snr-646552-		

## dosing containers

## wipers

			
1			
<b>GEV No.</b>	527493	<b>Ref. No.</b>	40790 60790
<b>description</b>	wiper for dosing container W 110mm H 72mm thread M6 stainless steel		
<b>For models:</b>	N40A-Snr-238645-360811, Nr40A-Snr-360812-639299, Nr40A-Snr-639300-, Nr60-Snr-576986-646551, Nr60-Snr-646552-		

## dosing containers (complete)

			
1			
<b>GEV No.</b>	527580	<b>Ref. No.</b>	40800
<b>description</b>	dosing unit complete ø 120mm suitable for Mod. 40		
<b>For models:</b>	N40A-Snr-238645-360811, Nr40A-Snr-360812-639299, Nr40A-Snr-639300-		



1

<b>GEV No.</b>	527579	<b>Ref. No.</b>	60800
<b>description</b>	dosing unit complete ø 120mm suitable for Mod. 60		
<b>For models:</b>	Nr60-Snr-576986-646551, Nr60-Snr-646552-		



1

<b>GEV No.</b>	527489	<b>Ref. No.</b>	40830
<b>description</b>	dosing unit with lever mounting pos. right ø 120mm H 90mm plastic for Mod. 40		
<b>For models:</b>	Nr40A-Snr-360812-639299, Nr40A-Snr-639300-		

dosing container lids



1

<b>GEV No.</b>	527491	<b>Ref. No.</b>	06701 40701
<b>description</b>	lid for dosing container ø 118mm		
<b>For models:</b>	N40A-Snr-238645-360811, Nr22-Snr-000000-264449, Nr22-Snr-264449-, Nr40APPM, Nr40A-Snr-217500-268355, Nr40A-Snr-268356-272259, Nr40A-Snr-272260-289551, Nr40A-Snr-360812-639299, Nr40A-Snr-639300-, Nr40-Snr-289552-338644, Nr6, Nr6-249928-, Nr6-Snr-249929-264559, Nr6-Snr-264560-339744, Nr6-Snr-385437-		

springs

group 1



1

<b>GEV No.</b>	527498	<b>Ref. No.</b>	40716 60716
<b>description</b>	compression spring ø 5mm L 12mm wire gauge ø 0.5mm		
<b>For models:</b>	N40A-Snr-238645-360811, Nr40APPM, Nr40A-Snr-217500-268355, Nr40A-Snr-268356-272259, Nr40A-Snr-272260-289551, Nr40A-Snr-360812-639299, Nr40A-Snr-639300-, Nr40-Snr-289552-338644, Nr60-Snr-576986-646551, Nr60-Snr-646552-, Nr6-Snr-385437-		

dosing units



1

<b>GEV No.</b>	527605	<b>Ref. No.</b>	60830
<b>description</b>	dosing unit with lever mounting pos. right ø 120mm H 117mm plastic for Mod. 60		
<b>For models:</b>	Nr60-Snr-576986-646551, Nr60-Snr-646552-		



1

<b>GEV No.</b>	527497	<b>Ref. No.</b>	40715 60715
<b>description</b>	torsion spring ø 35mm L2 22mm wire gauge ø 1.5mm L1 22mm L3 22mm		
<b>For models:</b>	N40A-Snr-238645-360811, Nr40APPM, Nr40A-Snr-217500-268355, Nr40A-Snr-268356-272259, Nr40A-Snr-272260-289551, Nr40A-Snr-360812-639299, Nr40A-Snr-639300-, Nr40-Snr-289552-338644, Nr60-Snr-576986-646551, Nr60-Snr-646552-, Nr6-Snr-385437-		

glass panels



1

<b>GEV No.</b>	527585	<b>Ref. No.</b>	40702
<b>description</b>	glass panel for dosing container L 370mm H 43mm plexiglas		
<b>For models:</b>	N40A-Snr-238645-360811, Nr40APPM, Nr40A-Snr-217500-268355, Nr40A-Snr-268356-272259, Nr40A-Snr-272260-289551, Nr40A-Snr-360812-639299, Nr40A-Snr-639300-, Nr40-Snr-289552-338644		

## levers

## levers



1

<b>GEV No.</b>	527492	<b>Ref. No.</b>	40718 60718
<b>description</b>	lever for dosing unit hole ø 12mm brass		
<b>For models:</b>	N40A-Snr-238645-360811, Nr40APPM, Nr40A-Snr-217500-268355, Nr40A-Snr-268356-272259, Nr40A-Snr-272260-289551, Nr40A-Snr-360812-639299, Nr40A-Snr-639300-, Nr40-Snr-289552-338644, Nr60-Snr-576986-646551, Nr60-Snr-646552-, Nr6-Snr-385437-		

## stoppers



1

<b>GEV No.</b>	527574	<b>Ref. No.</b>	40745 60745
<b>description</b>	stopper for lever D1 ø 12mm D2 ø 7mm H 7.5mm rubber		
<b>For models:</b>	N40A-Snr-238645-360811, Nr40APPM, Nr40A-Snr-217500-268355, Nr40A-Snr-268356-272259, Nr40A-Snr-272260-289551, Nr40A-Snr-360812-639299, Nr40A-Snr-639300-, Nr40-Snr-289552-338644, Nr60-Snr-576986-646551, Nr60-Snr-646552-, Nr6-Snr-385437-		



1

<b>GEV No.</b>	527499	<b>Ref. No.</b>	40746 60746
<b>description</b>	stopper for lever D1 ø 17mm D2 ø 7mm H 4mm rubber		
<b>For models:</b>	N40A-Snr-238645-360811, Nr40APPM, Nr40A-Snr-360812-639299, Nr40A-Snr-639300-, Nr60-Snr-576986-646551, Nr60-Snr-646552-, Nr6-Snr-385437-		

## coffee powder dispenser



1

<b>GEV No.</b>	527594	<b>Ref. No.</b>	55760
<b>description</b>	coffee discharge chute angled perforation ø 5mm hole distance 38mm plastic for dosing pump		

## coffee presses

## components

## springs



1

<b>GEV No.</b>	527587	<b>Ref. No.</b>	55847 56847 60847
<b>description</b>	compression spring ø 26.5mm L 80mm wire gauge ø 1.3mm for coffee press		
<b>For models:</b>	Nr55, Nr55-Snr-598198-639299, Nr55-Snr-639300-, Nr56, Nr56-Snr-580964-, Nr60-Snr-576986-646551, Nr60-Snr-646552-		

## pressers



1

<b>GEV No.</b>	525090	<b>Ref. No.</b>	40707 55841A
<b>description</b>	coffee press ø 53mm H 17mm plastic		
<b>For models:</b>	Nr40A-Snr-217500-268355, Nr40A-Snr-268356-272259, Nr40A-Snr-272260-289551, Nr40-Snr-289552-338644		



1

<b>GEV No.</b>	527582	<b>Ref. No.</b>	40707B 55841 60841
<b>description</b>	coffee press ø 55mm H 19mm plastic		
<b>For models:</b>	N40A-Snr-238645-360811, Nr40APPM, Nr40A-Snr-360812-639299, Nr40A-Snr-639300-, Nr55, Nr55-Snr-598198-639299, Nr55-Snr-639300-, Nr60-Snr-576986-646551, Nr60-Snr-646552-		



1

<b>GEV No.</b>	525091	<b>Ref. No.</b>	40707C 55841C
<b>description</b>	coffee press ø 57mm H 16mm plastic		

## coffee presses





1

<b>GEV No.</b>	527589	<b>Ref. No.</b>	60840
<b>description</b>	coffee press complete ø 55mm H 128mm plastic		
<b>For models:</b>	Nr60-Snr-576986-646551, Nr60-Snr-646552-		



			
1			
<b>GEV No.</b>	527588	<b>Ref. No.</b>	55840
<b>description</b>	coffee press complete ø 55mm H 129mm plastic		
<b>For models:</b>	Nr55, Nr55-Snr-598198-639299, Nr55-Snr-639300-		

			
1			
<b>GEV No.</b>	527606	<b>Ref. No.</b>	06705 06706+06707+06708+06709
<b>description</b>	coffee press complete ø 56mm L 68mm H 60mm plastic		
<b>For models:</b>	Nr22-Snr-000000-264449, Nr22-Snr-264449-, Nr6, Nr6-249928-, Nr6-Snr-249929-264559, Nr6-Snr-264560-339744		

			
1			
<b>GEV No.</b>	527487	<b>Ref. No.</b>	40705
<b>description</b>	coffee press ø 55mm L 70mm H 72mm		
<b>For models:</b>	N40A-Snr-238645-360811, Nr40A-Snr-217500-268355, Nr40A-Snr-268356-272259, Nr40A-Snr-272260-289551, Nr40A-Snr-360812-639299, Nr40A-Snr-639300-, Nr40-Snr-289552-338644		

automatic grinding

automatic grinding

			
1			
<b>GEV No.</b>	527488	<b>Ref. No.</b>	40860A
<b>description</b>	ring for dosing container with microswitch ø 122mm H 30mm plastic		
<b>For models:</b>	N40A-Snr-238645-360811, Nr40A-Snr-360812-639299		

			
1			
<b>GEV No.</b>	527581	<b>Ref. No.</b>	06750A
<b>description</b>	ring for dosing container with microswitch ø 122mm H 30mm plastic		

miscellaneous

			
1			
<b>GEV No.</b>	527599	<b>Ref. No.</b>	55755
<b>description</b>	lamella for dosing unit L 47mm W 14mm thickness 0.1mm		
<b>For models:</b>	Nr55, Nr55-Snr-598198-639299, Nr55-Snr-639300-		

ratches

ratches

			
1			
<b>GEV No.</b>	527496	<b>Ref. No.</b>	40772 60772
<b>description</b>	ratchet for dosing unit ø 30mm int. ø 1 12mm		
<b>For models:</b>	N40A-Snr-238645-360811, Nr40APPM, Nr40A-Snr-268356-272259, Nr40A-Snr-272260-289551, Nr40A-Snr-360812-639299, Nr40A-Snr-639300-, Nr40-Snr-289552-338644, Nr60-Snr-576986-646551, Nr60-Snr-646552-, Nr6-Snr-385437-		

stars

complete

			
1			
<b>GEV No.</b>	527490	<b>Ref. No.</b>	40730B 60730
<b>description</b>	star complete ø 112mm shaft ø 7		
<b>For models:</b>	N40A-Snr-238645-360811, Nr40APPM, Nr40A-Snr-360812-639299, Nr40A-Snr-639300-, Nr60-Snr-576986-646551, Nr60-Snr-646552-, Nr6-Snr-385437-		

accessories

			
1			
<b>GEV No.</b>	560360	<b>Ref. No.</b>	06788 40788 60788
<b>description</b>	long nut thread M4 L 20mm WS 10 SS Qty 1 pcs		
<b>For models:</b>	N40A-Snr-238645-360811, Nr40APPM, Nr40A-Snr-360812-639299, Nr40A-Snr-639300-, Nr60-Snr-576986-646551, Nr60-Snr-646552-, Nr6-Snr-385437-		



## spindles



1

<b>GEV No.</b>	527494	<b>Ref. No.</b>	40777B 60742+60774
<b>description</b>	spindle for dosing container shaft length 112mm T1: M4 T2: M6 handle ø 25mm shaft ø 6		
<b>For models:</b>	N40A-Snr-238645-360811, Nr6-Snr-385437-		



1

<b>GEV No.</b>	527495	<b>Ref. No.</b>	06771 40771 60771
<b>description</b>	spindle for dosing unit shaft ø 12/16mm shaft length 50mm		
<b>For models:</b>	N40A-Snr-238645-360811, Nr22-Snr-264449-, Nr40APPM, Nr40A-Snr-360812-639299, Nr40A-Snr-639300-, Nr60-Snr-576986-646551, Nr60-Snr-646552-, Nr6-Snr-264560-339744, Nr6-Snr-385437-		



1

<b>GEV No.</b>	527578	<b>Ref. No.</b>	40717 60717
<b>description</b>	spindle for dosing unit shaft ø 5mm shaft length 26mm		
<b>For models:</b>	N40A-Snr-238645-360811, Nr40APPM, Nr40A-Snr-217500-268355, Nr40A-Snr-268356-272259, Nr40A-Snr-272260-289551, Nr40A-Snr-360812-639299, Nr40A-Snr-639300-, Nr40-Snr-289552-338644, Nr60-Snr-576986-646551, Nr60-Snr-646552-, Nr6-Snr-385437-		

## adjustment mechanism

## lockable adjustment



1

<b>GEV No.</b>	527577	<b>Ref. No.</b>	06310 40310 55310 60310
<b>description</b>	push button L 33mm W 30mm shaft ø 10mm shaft length 34mm with spring		
<b>For models:</b>	N40A-Snr-238645-360811, Nr40APPM, Nr40A-Snr-217500-268355, Nr40A-Snr-268356-272259, Nr40A-Snr-272260-289551, Nr40A-Snr-360812-639299, Nr40A-Snr-639300-, Nr40-Snr-289552-338644, Nr55, Nr55-Snr-598198-639299, Nr55-Snr-639300-, Nr6, Nr60-Snr-576986-646551, Nr60-Snr-646552-, Nr6-249928-, Nr6-Snr-249929-264559, Nr6-Snr-264560-339744, Nr6-Snr-385437-		

## setting rings



1

<b>GEV No.</b>	527601	<b>Ref. No.</b>	06201 40201
<b>description</b>	grinding burr holder mounting ø 85mm ø 121mm ID ø 36mm H 42mm mounting pos. upper		
<b>For models:</b>	N40A-Snr-238645-360811, Nr40APPM, Nr40A-Snr-217500-268355, Nr40A-Snr-268356-272259, Nr40A-Snr-272260-289551, Nr40A-Snr-360812-639299, Nr40A-Snr-639300-, Nr40-Snr-289552-338644, Nr6, Nr6-249928-, Nr6-Snr-249929-264559, Nr6-Snr-264560-339744, Nr6-Snr-385437-		



1

<b>GEV No.</b>	527576	<b>Ref. No.</b>	40200 55200 60200
<b>description</b>	grinding burr holder with grinding burr mounting ø 85mm ø 121mm ID ø 36mm H 50mm mounting pos. upper		
<b>For models:</b>	N40A-Snr-238645-360811, Nr40APPM, Nr40A-Snr-217500-268355, Nr40A-Snr-268356-272259, Nr40A-Snr-272260-289551, Nr40A-Snr-360812-639299, Nr40A-Snr-639300-, Nr40-Snr-289552-338644, Nr55, Nr55-Snr-598198-639299, Nr55-Snr-639300-, Nr60-Snr-576986-646551, Nr60-Snr-646552-		

## coffee beans containers

## container lids



1

<b>GEV No.</b>	527482	<b>Ref. No.</b>	40101 55101 60101
<b>description</b>	lid for coffee beans container L 302mm W 180mm		
<b>For models:</b>	N40A-Snr-238645-360811, Nr40APPM, Nr40A-Snr-217500-268355, Nr40A-Snr-268356-272259, Nr40A-Snr-272260-289551, Nr40A-Snr-360812-639299, Nr40A-Snr-639300-, Nr40-Snr-289552-338644, Nr55, Nr55-Snr-598198-639299, Nr55-Snr-639300-, Nr60-Snr-576986-646551, Nr60-Snr-646552-		



1

<b>GEV No.</b>	527485	<b>Ref. No.</b>	06101
<b>description</b>	lid for coffee beans container ø 206mm		
<b>For models:</b>	Nr6, Nr6-249928-, Nr6-Snr-249929-264559, Nr6-Snr-264560-339744, Nr6-Snr-385437-		



coffee beans containers



1			
<b>GEV No.</b>	527484	<b>Ref. No.</b>	40100 55100 60100
<b>description</b>	coffee beans container L 310mm W 190mm H 250mm seat ø 60mm		
<b>For models:</b>	N40A-Snr-238645-360811, Nr40APPM, Nr40A-Snr-217500-268355, Nr40A-Snr-268356-272259, Nr40A-Snr-272260-289551, Nr40A-Snr-360812-639299, Nr40A-Snr-639300-, Nr40-Snr-289552-338644, Nr55, Nr55-Snr-598198-639299, Nr55-Snr-639300-, Nr60-Snr-576986-646551, Nr60-Snr-646552-		



1			
<b>GEV No.</b>	527483	<b>Ref. No.</b>	06100
<b>description</b>	coffee beans container ø 215mm H 240mm seat ø 65mm		
<b>For models:</b>	Nr6, Nr6-249928-, Nr6-Snr-249929-264559, Nr6-Snr-264560-339744, Nr6-Snr-385437-		

support for filter holder

1			
<b>GEV No.</b>	527593	<b>Ref. No.</b>	60424
<b>description</b>	filter holder support for dosing pump L 175mm W 80mm H 42mm		
<b>For models:</b>	Nr60-Snr-576986-646551, Nr60-Snr-646552-		

1			
<b>GEV No.</b>	527584	<b>Ref. No.</b>	40654
<b>description</b>	filter holder support L 130mm W 120mm H 82mm aluminium		
<b>For models:</b>	N40A-Snr-238645-360811, Nr40A-Snr-217500-268355, Nr40A-Snr-268356-272259, Nr40A-Snr-272260-289551, Nr40A-Snr-360812-639299, Nr40A-Snr-639300-, Nr40-Snr-289552-338644		

1			
<b>GEV No.</b>	527583	<b>Ref. No.</b>	06602
<b>description</b>	filter holder support L 68mm W 64mm H 52mm aluminium		
<b>For models:</b>	Nr22-Snr-000000-264449, Nr22-Snr-264449-, Nr6, Nr6-249928-, Nr6-Snr-249929-264559, Nr6-Snr-264560-339744, Nr6-Snr-385437-		

for drink dispensers

drain taps

1			
<b>GEV No.</b>	650283	<b>Ref. No.</b>	34105C
<b>description</b>	outlet tap complete for dispenser L 70mm W 75mm H 150mm black no. 34		
<b>For models:</b>	Nr34-1-1Bowl, Nr34-2-2Bowls_Version2, Nr34-3-3Bowls		

containers

group 2

1			
<b>GEV No.</b>	650271	<b>Ref. No.</b>	34102 34102C
<b>description</b>	container without lid L 430mm W 190mm ømm H 210mm seat ø 110mm container capacity 12l no. 34 for dispenser		
<b>For models:</b>	Nr34-1-1Bowl, Nr34-2-2Bowls_Version1, Nr34-2-2Bowls_Version2, Nr34-3-3Bowls		
<b>accessories for</b>	650271		
	<b>GEV No.</b>	<b>Ref. No.</b>	34103
	gasket for container ED ø 123mm ID ø 87mm no. 34 for dispenser		

## accessories



1

<b>GEV No.</b>	650272	<b>Ref. No.</b>	34103
<b>description</b>	gasket for container ED $\phi$ 123mm ID $\phi$ 87mm no. 34 for dispenser		
<b>For models:</b>	Nr34-1-1Bowl, Nr34-2-2Bowls_Version1, Nr34-2-2Bowls_Version2, Nr34-3-3Bowls		

## holders

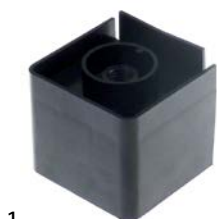

1

<b>GEV No.</b>	650107	<b>Ref. No.</b>	34104
<b>description</b>	bracket L 75mm W 70mm H 60mm plastic		
<b>For models:</b>	Nr34-1-1Bowl, Nr34-2-2Bowls_Version1, Nr34-2-2Bowls_Version2, Nr34-3-3Bowls		

## knobs

## miscellaneous



1

<b>GEV No.</b>	527598	<b>Ref. No.</b>	06614
<b>description</b>	knob $\phi$ 35mm shaft $\phi$ 6x4.6mm shaft flat lateral		
<b>For models:</b>	Nr6, Nr6-249928-, Nr6-Snr-249929-264559, Nr6-Snr-264560-339744, Nr6-Snr-385437-		

## equipment feet and end caps

## bolting feet



1

<b>GEV No.</b>	692091	<b>Ref. No.</b>	10907
<b>description</b>	equipment foot $\phi$ 21mm H 10mm bore $\phi$ 4mm Qty 1 pcs MD50		
<b>For models:</b>	Nr10-Snr-000000-101050, Nr10-Snr-101051-402800, Nr10-Snr-402801-, Nr10-Snr-673752-		

## gaskets

## O-rings

## EPDM

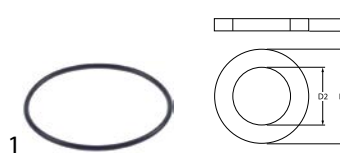

1

<b>GEV No.</b>	532708	<b>Ref. No.</b>	50417
<b>description</b>	O-ring EPDM thickness 2.5mm ID $\phi$ 62mm Qty 1 pcs		
<b>For models:</b>	Nr50-Snr-000000-661901, Nr50-Snr-661901-		

## miscellaneous



1

<b>GEV No.</b>	532709	<b>Ref. No.</b>	34110
<b>description</b>	O-ring EPDM thickness 2.7mm ID $\phi$ 12.2mm Qty 1 pcs		
<b>For models:</b>	Nr34-1-1Bowl, Nr34-2-2Bowls_Version1, Nr34-2-2Bowls_Version2, Nr34-3-3Bowls		

## shaft gaskets

## v-rings



1

<b>GEV No.</b>	650291	<b>Ref. No.</b>	37176
<b>description</b>	V-ring $\phi$ mm Lmm thread ID $\phi$ 14mm ED $\phi$ 20mm IT H 5.5mm WS Qty pcs thicknessmm		
<b>For models:</b>	Nr37-Snr-116617-164864, Nr37-Snr-164865-256894, Nr37-Snr-256895-		

## shaft gaskets



1

<b>GEV No.</b>	694287	<b>Ref. No.</b>	28897
<b>description</b>	shaft seal ID $\phi$ 16mm ED $\phi$ 26mm thickness 7mm		
<b>For models:</b>	Nr28_Version1, Nr28-Snr-170543-, Nr28-Snr-170544-290190, Nr28-Snr-290191-		



special gaskets

miscellaneous



1

<b>GEV No.</b>	650272	<b>Ref. No.</b>	34103
<b>description</b>	gasket for container ED ø 123mm ID ø 87mm no. 34 for dispenser		
<b>For models:</b>	Nr34-1-1Bowls, Nr34-2-2Bowls_Version1, Nr34-2-2Bowls_Version2, Nr34-3-3Bowls		



1

<b>GEV No.</b>	650279	<b>Ref. No.</b>	37184
<b>description</b>	gasket for knife Lmm Wmm ID ø 76mm ED ø 85mm H 7.8mm		
<b>For models:</b>	Nr37-Snr-116617-164864, Nr37-Snr-164865-256894, Nr37-Snr-256895-		



1

<b>GEV No.</b>	650274	<b>Ref. No.</b>	37104 37109
<b>description</b>	lid gasket rubber D1 ø 170mm D2 ø 200mm thickness 16mm capacity 4l		
<b>For models:</b>	Nr37-Snr-116617-164864, Nr37-Snr-164865-256894, Nr37-Snr-256895-		



1

<b>GEV No.</b>	650280	<b>Ref. No.</b>	50411 58361
<b>description</b>	rubber gasket		
<b>For models:</b>	Nr50-Snr-000000-661901, Nr50-Snr-661901-, Nr58, Nr58-Snr-652469-696539, Nr58-Snr-697619-		

springs

torsion springs



1

<b>GEV No.</b>	527497	<b>Ref. No.</b>	40715 60715
<b>description</b>	torsion spring ø 35mm L2 22mm wire gauge ø 1.5mm L1 22mm L3 22mm		
<b>For models:</b>	N40A-Snr-238645-360811, Nr40APPM, Nr40A-Snr-217500-268355, Nr40A-Snr-268356-272259, Nr40A-Snr-272260-289551, Nr40A-Snr-360812-639299, Nr40A-Snr-639300-, Nr40-Snr-289552-338644, Nr60-Snr-576986-646551, Nr60-Snr-646552-, Nr6-Snr-385437-		

compression springs



1

<b>GEV No.</b>	527587	<b>Ref. No.</b>	55847 56847 60847
<b>description</b>	compression spring ø 26.5mm L 80mm wire gauge ø 1.3mm for coffee press		
<b>For models:</b>	Nr55, Nr55-Snr-598198-639299, Nr55-Snr-639300-, Nr56, Nr56-Snr-580964-, Nr60-Snr-576986-646551, Nr60-Snr-646552-		



1

<b>GEV No.</b>	527498	<b>Ref. No.</b>	40716 60716
<b>description</b>	compression spring ø 5mm L 12mm wire gauge ø 0.5mm		
<b>For models:</b>	N40A-Snr-238645-360811, Nr40APPM, Nr40A-Snr-217500-268355, Nr40A-Snr-268356-272259, Nr40A-Snr-272260-289551, Nr40A-Snr-360812-639299, Nr40A-Snr-639300-, Nr40-Snr-289552-338644, Nr60-Snr-576986-646551, Nr60-Snr-646552-, Nr6-Snr-385437-		

fastening material

screws

flat-headed bolts



1

<b>GEV No.</b>	560361	<b>Ref. No.</b>	06206 40206
<b>description</b>	flat-headed bolt thread M4 thread L 10mm 7500 Qty 1 pcs head ø 8mm head thickness 3mm WS T25 for grind stone		
<b>For models:</b>	N40A-Snr-238645-360811, Nr40APPM, Nr40A-Snr-217500-268355, Nr40A-Snr-268356-272259, Nr40A-Snr-272260-289551, Nr40A-Snr-360812-639299, Nr40A-Snr-639300-, Nr40-Snr-289552-338644, Nr6, Nr6-249928-, Nr6-Snr-249929-264559, Nr6-Snr-264560-339744, Nr6-Snr-385437-		

## hexagonal screws



1

<b>GEV No.</b>	560083	<b>Ref. No.</b>	11323
<b>description</b>	hexagonal screw thread M5 thread L 10mm SS WS 8 Qty 20 pcs DIN 933 / ISO 4017		
<b>For models:</b>	Nr11, Nr11-Snr-201132-, Nr11-Snr-201133-, Nr11-Snr-472893-, Nr11-Snr-472894-606107, Nr11-Snr-606108-		

## grub screws

## DIN 916/ISO 4029



1

<b>GEV No.</b>	560366	<b>Ref. No.</b>	28890
<b>description</b>	grub screw thread M6 L 20mm SS intake internal hexagon WS 3 Qty 1 pcs		
<b>For models:</b>	Nr28_Version1, Nr28-Snr-170543-, Nr28-Snr-170544-290190, Nr28-Snr-290191-		

## nuts

## cap nuts



1

<b>GEV No.</b>	560137	<b>Ref. No.</b>	28878
<b>description</b>	cap nuts thread M6 WS 10 SS Qty 20 pcs DIN/ISO DIN 1587		
<b>For models:</b>	Nr28_Version1, Nr28-Snr-170543-, Nr28-Snr-170544-290190, Nr28-Snr-290191-		

## long nuts



1

<b>GEV No.</b>	560360	<b>Ref. No.</b>	06788 40788 60788
<b>description</b>	long nut thread M4 L 20mm WS 10 SS Qty 1 pcs		
<b>For models:</b>	N40A-Snr-238645-360811, Nr40APPM, Nr40A-Snr-360812-639299, Nr40A-Snr-639300-, Nr60-Snr-576986-646551, Nr60-Snr-646552-, Nr6-Snr-385437-		

## washers

## washers

## miscellaneous



1

<b>GEV No.</b>	560362	<b>Ref. No.</b>	40780 60780
<b>description</b>	plain washer ID ø 12mm ED ø 18mm thickness 0.6mm Qty 1 pcs for coffee grinder		
<b>For models:</b>	N40A-Snr-238645-360811, Nr40APPM, Nr40A-Snr-360812-639299, Nr40A-Snr-639300-, Nr60-Snr-576986-646551, Nr60-Snr-646552-		



1

<b>GEV No.</b>	560363	<b>Ref. No.</b>	40714 60714
<b>description</b>	plain washer ID ø 16.8mm ED ø 34mm thickness 1mm Qty 1 pcs for coffee grinder		
<b>For models:</b>	N40A-Snr-238645-360811, Nr40APPM, Nr40A-Snr-217500-268355, Nr40A-Snr-268356-272259, Nr40A-Snr-272260-289551, Nr40A-Snr-360812-639299, Nr40A-Snr-639300-, Nr40-Snr-289552-338644, Nr60-Snr-576986-646551, Nr60-Snr-646552-, Nr6-Snr-385437-		

## tooth lock washers

## DIN 6798A



1

<b>GEV No.</b>	560126	<b>Ref. No.</b>	11324
<b>description</b>	tooth lock washer ID ø 5.2mm ED ø 10mm SS DIN/ISO DIN 6798A Qty 20 pcs for thread M5		
<b>For models:</b>	Nr11, Nr11-Snr-201132-, Nr11-Snr-201133-, Nr11-Snr-472893-, Nr11-Snr-472894-606107, Nr11-Snr-606108-		

## fasteners

## slot nuts



1

<b>GEV No.</b>	527600	<b>Ref. No.</b>	40775 60775
<b>description</b>	slot nut W 2mm H 2.6mm L 7.6mm for dosing unit		
<b>For models:</b>	N40A-Snr-238645-360811, Nr40APPM, Nr40A-Snr-268356-272259, Nr40A-Snr-272260-289551, Nr40A-Snr-360812-639299, Nr40A-Snr-639300-, Nr40-Snr-289552-338644, Nr60-Snr-576986-646551, Nr60-Snr-646552-		





retaining rings			
DIN 471			
<b>GEV No.</b>	516222	<b>Ref. No.</b>	40776 60776
<b>description</b>	retaining ring shaft ø 12mm thickness 1mm SS DIN 471		
<b>For models:</b>	N40A-Snr-238645-360811, Nr40APPM, Nr40A-Snr-268356-272259, Nr40A-Snr-272260-289551, Nr40A-Snr-360812-639299, Nr40A-Snr-639300-, Nr40-Snr-289552-338644, Nr60-Snr-576986-646551, Nr60-Snr-646552-, Nr6-Snr-385437-		

roll pins			
<b>GEV No.</b>	560367	<b>Ref. No.</b>	28871
<b>description</b>	roll pin ø 5mm L 25mm		
<b>For models:</b>	Nr28_Version1, Nr28-Snr-170543-, Nr28-Snr-170544-290190, Nr28-Snr-290191-		



**C**

cap nuts	18
compressors	4
condensators & interference suppression filters	4

**F**

fasteners	18
fastening material	17
flat-headed bolts	17
fuses	4

**G**

grub screws	18
-------------	----

**H**

hexagonal screws	18
------------------	----

**L**

long nuts	18
-----------	----

**M**

microswitches	3
---------------	---

**N**

nuts	18
------	----

**O**

O-rings	16
---------	----

**R**

retaining rings	19
rocker/momentary rocker switches	3
roll pins	19
rotary switches	3

**S**

screws	17
shaft gaskets	16
slot nuts	18
starting capacitors	4
switches and momentary switches	3

**T**

tooth lock washers	18
--------------------	----

**W**

washers	18
---------	----