



GAS COMPONENTS



ELECTRIC COMPONENTS



WATER TECHNOLOGY



MECHANICAL COMPONENTS



TOOLS

Spare parts suitable for

SCOTSMAN

Find the complete and up-to-date range of products in our GEV Webshop



Manufacturer catalogue

The most important spare parts and accessories arranged clearly for every manufacturer

- ✓ Complete product range and all appliance data always up to date in the GEV Webshop
- ✓ Alphabetical Index at the end of the catalogue

GEV Webshop

www.gev-online.co.uk

www.gev-online.com



- 🔍 Add to Favourites
- 🔍 Sign In with email address and usual password
- 🔍 Easy-order – place several items in your basket at the same time
- 🔍 Quick Item search – no login needed



thermostats

control and safety thermostats

RANCO

safety thermostats

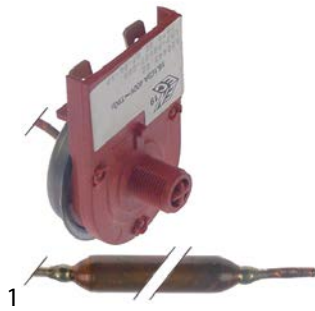

GEV No.	375832	Ref. No.	62044300 62044302
description	safety thermostat t.max. 70°C temperature range 0-70°C 1-pole 1NO 16A probe ø 8mm probe L 60mm capillary pipe 870mm capillary pipe isolatedmm gland nut shaft ømm shaft Lmm shaft position rotation° probe material copper switch-off temp. 70°C		
For models:	Barline-20, Barline-21, Barline-30, Barline-31, Barline-40, Barline-50, Barline-65, Barline-90, ICE-ONE, ICE-THREE, ICE-TWO, SD18		

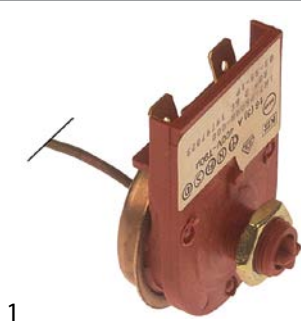

GEV No.	390583	Ref. No.	CM19797023
description	safety thermostat t.max. 80°C temperature range°C 1-pole 1NC 16A probe ø 9mm probe L 50mm capillary pipe 800mm capillary pipe isolatedmm gland nut shaft ømm shaft Lmm shaft position rotation° probe material copper with coiled probe screw connection M10x0.75 switch-off temp. 80°C		

refrigeration thermostats

DANFOSS

service thermostats DANFOSS

All Danfoss thermostats are supplied with fastening material application:

- 390552 - **fridges
- 390553 - **Refrigerators with defrosting push button
- 390554 - **/**Refrigerators with automatic defrosting
- 390555 - absorption refrigerators
- 390557 - Deep cooler with active signal
- 390558 - Freezing with passive signal
- 390559 - bottle cooler 390559



GEV No.	390559	Ref. No.	19797007 CM19797007 CM19797012
description	thermostat type 077B7008 capillary pipe 2000mm temperature range -8.5 up to +11.5°C probe ømm probe Lmm		

RANCO

K22 series



GEV No.	390207	Ref. No.	62026414
description	thermostat RANCO type K22L2030 probe ø 2mm probe Lmm capillary pipe 2000mm temperature range -13 up to -4°C		



GEV No.	390646	Ref. No.	62026303
description	thermostat RANCO type K22-L1075 capillary pipe 2900mm probe ø9.5x107mm		
For models:	MAR125, MF102, MF82, MF83		



GEV No.	390644	Ref. No.	1100052121
description	thermostat RANCO type A22-1297-000 capillary pipe 1500mm probe \varnothing 10x100mm		



GEV No.	390280	Ref. No.	62012500
description	thermostat RANCO type K22L3021 probe \varnothing 9mm probe L 35mm capillary pipe 1600mm temperature range -14 up to -9°C		



GEV No.	390209	Ref. No.	62020100
description	thermostat RANCO type K22L1020 probe \varnothing 9mm probe L 40mm capillary pipe 2000mm temperature range -20.5 up to -1.5°C		
For models:	ACM85		



GEV No.	390279	Ref. No.	62012900
description	thermostat RANCO type K22L3022 probe \varnothing 9mm probe L 35mm capillary pipe 1600mm		



GEV No.	390737	Ref. No.	62020101
description	thermostat RANCO type K22-L1074 probe \varnothing 9mm probe L 42mm capillary pipe 1450mm temperature range -19 up to -1°C		
For models:	Barline-50, Barline-65, Barline-90		

K50 series



GEV No.	390208	Ref. No.	620209.00
description	thermostat RANCO type K50L3006 probe \varnothing mm probe Lmm capillary pipe 2000mm temperature range +1.5 up to +4°C		



GEV No.	390277	Ref. No.	63003800
description	thermostat RANCO type K22L3020 probe \varnothing 9mm probe L 40mm capillary pipe 1600mm temperature range -26.5 up to -19.5°C		



GEV No.	390254	Ref. No.	62020900
description	thermostat RANCO type K50P1135 probe \varnothing mm probe Lmm capillary pipe 2500mm T cold 1.5°C		

1

GEV No.	390581	Ref. No.	19797026 62020900 63000500
description	thermostat RANCO type K50-S3595 probe ø 2mm probe Lmm capillary pipe 2000mm		
For models:	AC046, AC056, AC086, ACM35, ACM55, ACM85, AF10, Barline-20, Barline-21, Barline-30, Barline-31, Barline-40, Barline-50, Barline-65, Barline-90, ICE-ONE, ICE-THREE, ICE-TWO, MF82, SD18		



1

GEV No.	390284	Ref. No.	CM19797018
description	thermostat RANCO type K55L5082 capillary pipe 1500mm temperature range°C probe ø10x110mm		



1

GEV No.	390444	Ref. No.	62026300
description	thermostat RANCO type K50-L3074 probe ø 9mm probe L 40mm capillary pipe 560mm		
For models:	ACM25		

K61 series



1

GEV No.	390212	Ref. No.	620264.01 62026410
description	thermostat RANCO type K61L1500 probe ømm probe Lmm capillary pipe 750mm T war -11.5°C T cold 22°C		
For models:	ACM25, ACM35		

K55 series



1

GEV No.	390210	Ref. No.	62026302
description	thermostat RANCO type K55L1042 capillary pipe 1100mm temperature range +1.7 up to +9.5°C probe ø10x110mm		



1

GEV No.	390206	Ref. No.	620264.00
description	thermostat RANCO type K61L1501 probe ømm probe Lmm capillary pipe 1800mm		



1

GEV No.	390283	Ref. No.	CM19797017
description	thermostat RANCO type K55L5081 capillary pipe 1100mm temperature range°C probe ø10x110mm		



1

GEV No.	390586	Ref. No.	620264-11
description	thermostat RANCO type K61L1504 probe ø 2mm probe Lmm capillary pipe 1800mm T war 11.5°C T cold 22°C		
For models:	AC086, Barline-20, Barline-30, Barline-40, ICE-ONE, ICE-THREE, ICE-TWO		



			
GEV No.	379516	Ref. No.	62026402 62026416
description	thermostat RANCO type K61L1508 probe ø 2mm probe Lmm capillary pipe 1800mm		
For models:	AC046, AC056, ACM35, ACM55, Barline-20, Barline-21, Barline-31, ICE-ONE, ICE-TWO		

			
GEV No.	390591	Ref. No.	62026415
description	thermostat RANCO type K61L1509 probe ø 2mm probe Lmm capillary pipe 2250mm		
For models:	SD18		

miscellaneous producers

			
GEV No.	390485	Ref. No.	1100035323 11035323
description	thermostat		
For models:	AC30		

			
GEV No.	390659	Ref. No.	1100036600 11-0366-00
description	thermostat probe ø 2.5mm capillary pipe 90mm		

accessories

probe clips			
miscellaneous			
			
GEV No.	695858	Ref. No.	66033900
description	clamp L 24mm ø 15mm H 8mm mounting ø 6mm for hose		
For models:	ACM25		

switches and momentary switches

rocker/momentary rocker switches

25.5x25mm			
			
GEV No.	301245 ¹	Ref. No.	33400025 CM33400025
description	rocker switch mounting measurements 25.5x25mm white 2NO 250V 16A 0-I connection male faston 6.3mm protection IP40		

¹illuminated



30x11mm

			
GEV No.	301013	Ref. No.	62044201 62044202
description	rocker switch mounting measurements 30x11mm black 1CO 250V 16A connection male faston 6.3mm ambient temperature max. 85/125°C protection IP40		
For models:	AC046, AC056, AC086, Barline-20, Barline-21, Barline-30, Barline-31, Barline-40, Barline-50, Barline-65, Barline-90, ICE-ONE, ICE-THREE, ICE-TWO, SD18		



30x22mm

			
GEV No.	347074	Ref. No.	63011300
description	rocker switch mounting measurements 30x22mm black/orange 1NO/indicator light 250V 16A cold connection male faston 6.3mm ambient temperature max. 125/55°C protection IP65 with cover cap		
For models:	MAR125, MF82, MF83		



miscellaneous			
 <p>1</p>			
GEV No.	347064	Ref. No.	1105351 1200241101
description	rocker switch mounting measurements 40x18mm black 1CO 250V 10A		
accessories for	347064		
 <p>GEV No. 694188 Ref. No. 1200240201 4217037</p> <p>cable harness 3-pole L 170mm permanent temperature 105°C plug type Faston 6.3mm</p>			

push/momentary push switches

19x13mm			
 <p>1</p>			
GEV No.	346871 ¹	Ref. No.	62048702
description	push switch mounting measurements 19x13mm green 2NO 250V 16A illuminated connection male faston 4.8mm ambient temperature max. 105/55°C protection IP40		
For models:	AC046, AC056, AC086, AC106, AC126, AC176, AC226		
accessories for	346871		
 <p>GEV No. 346541 Ref. No. —</p> <p>protective cover for rocker switch external size 23.4x17.4mm internal size 19x13mm H 9.5mm mounting measurementsmm</p>			

¹illuminated

 <p>1</p>			
GEV No.	347079 ¹	Ref. No.	1105324 62048700
description	push switch mounting measurements 19x13mm green 2NO 250V 16A illuminated connection male faston 6.3mm ambient temperature max. 125°C protection IP65 with cover cap		
For models:	AC046, AC056, AC086, AC106, AC126, AC176, AC226, MC8		

¹illuminated

toggle switches

M12x0.75			
 <p>1</p>			
GEV No.	346526	Ref. No.	62003302
description	toggle switch thread M12x0.75 1CO 250V 15A ON-ON male faston 6.3mm		

 <p>1</p>			
GEV No.	346516	Ref. No.	62003300
description	toggle switch thread M12x0.75 1NO 250V 15A ON-OFF male faston 6.3mm		
For models:	ACM35, ACM55, ACM85, AF10, AF20, AF30		

 <p>1</p>			
GEV No.	346520	Ref. No.	33400019 CM33400019
description	toggle switch thread M12x0.75 2CO 250V 15A ON-OFF-ON male faston 6.3mm with neutral position t.max. 85/55°C		
For models:	MV18, MV25		

 <p>1</p>			
GEV No.	347068	Ref. No.	33400027 CM33400027
description	toggle switch thread M12x0.75 2NO 250V 16A ON-OFF-ON male faston 6.3mm with neutral position		
For models:	MV18, MV25, MV50		

microswitches

lever actuated			
 <p>1</p>			
GEV No.	347063	Ref. No.	25474581 CM25474581
description	microswitch 250V 15A 1CO connection male faston 6.3mm ambient temperature max. 105°C lever length 37mm		

 <p>1</p>			
GEV No.	345345	Ref. No.	CM19410207
description	microswitch with lever 250V 16A 1CO connection male faston 6.3mm L 78mm ambient temperature max. 85°C mounting distance 22mm type X662-88-J27 actuating force: 40g lever length 69mm		

 <p>1</p>			
GEV No.	345107	Ref. No.	62025700 T00204
description	microswitch with lever 250V 16A 1CO connection male faston 6.3mm L 98mm ambient temperature max. 125°C mounting distance 22mm actuating force: 30g lever length 90mm		



			
1			
GEV No.	345044	Ref. No.	620033.02
description	microswitch with lever 250V 16A 1CO connection male faston 6.3mm ambient temperature max. 85°C mounting distance 25mm type C99ZP3 actuating force: 25g lever length 71mm		

			
1			
GEV No.	346887	Ref. No.	1107144S&P 1200205901 12205901
description	microswitch with lever 250V 15A 1NC connection male faston 6.3mm ambient temperature max. 125°C lever length 60mm		
For models:	AF10, AF1D, AF20, AF30, AF300, AF325, AF430, AFE325AE-1A, AFE325AE-6A, AFE325AS-1A, AFE325AS-1B, AFE325AS-6A, AFE325AS-6B, AFE400, FD470, FD4D, FD5C, FDE470AE-1A, FDE470AE-6A, FDE-470AS-1A, FDE470AS-6A, FDE474AS-1A, FDE474AS-6A, MF400AE-1A, MF400AE-1B, MFE400, TDE470AE-1A, TDE470AE-6A, TDE470AS-1A, TDE470AS-6A		

			
1			
GEV No.	347077	Ref. No.	1200164100
description	microswitch with lever 250V 15A 2CO connection male faston 6.3mm ambient temperature max. 85°C lever length 62mm		

			
1			
GEV No.	345361	Ref. No.	CM19410205
description	microswitch with lever 250V 5A 1NO/1NC connection soldering connection ambient temperature max. 85°C type 83109004 lever length 43mm		

roller-lever actuated

microswitches

			
1			
GEV No.	345253	Ref. No.	CM19410209
description	microswitch with handle with a switch 250V 15A 1CO connection male faston 6.3mm L 28mm L1 37mm ambient temperature max. 125°C mounting distance 22mm type RL6-1-F-GE-P12-5-L actuating force: 80g grey lever length 28mm		

heavy duty version

			
1			
GEV No.	346874	Ref. No.	CM19410300
description	microswitch with handle with a switch 250V 16A 1CO connection screw L 29mm L1 49mm ambient temperature max. 85°C mounting distance 26mm type Z-15GW22-B actuating force: 120g lever length 25mm		

with mounting components

			
1			
GEV No.	346876	Ref. No.	CM19410208
description	microswitch with handle with a switch 250V 16A 1CO connection male faston L 35mm L1 28mm ambient temperature max. 125°C mounting distance 22mm type V-166-1CR5 actuating force: 86g		

roller actuated

roller 0°

			
1			
GEV No.	347080	Ref. No.	33400026 CM33400026
description	microswitch with roller plunger 10A 1CO connection screw ambient temperature max. 85°C thread M12x1		
For models:	RB400		

float switches

			
1			
GEV No.	345365	Ref. No.	814091790 CM81409179
description	float switch 250V 16A 1CO male faston 6.3mm L 150mm ambient temperature max. 125°C mounting distance 23mm type EF83161.5 actuating force: 5g black		
For models:	GP20, GP20W, GP30, GP30W, GP40, GP40W, GP50, GP50W, GP75, GP75W, GP90, GP90W		

			
1			
GEV No.	347088	Ref. No.	CM81449091
description	float switch with plunger 250V 16A 1CO male faston 6.3mm L 130mm ambient temperature max. 125°C mounting distance 23mm type EF83161.5 actuating force: 5g black		



floats



1

GEV No.	695036	Ref. No.	4114149S&P 66058500 783127.00
description	float for ice maker ø 75mm L 115mm H 40mm plastic		
For models:	AF10, AF100, AF20, AF200, AF30, AF80, MAR1, MAR10, MAR125, MAR2, MAR5, MF20, MF22, MF26, MF30, MF36, MF41, MF46, MF51, MF56, MF56ASR, MF61, MF62, MF66, MF66ASR		

accessories



1

GEV No.	695998	Ref. No.	0200338301 0200338321
description	bar for float switch ø 15mm L 180mm aperture 3.5x30mm plastic		



1

GEV No.	695649	Ref. No.	0200338302
description	bar for float switch ø 15mm L 180mm aperture 3.5x51mm plastic		

centrifugal switches



1

GEV No.	346986	Ref. No.	0A02749401
description	centrifugal switch		

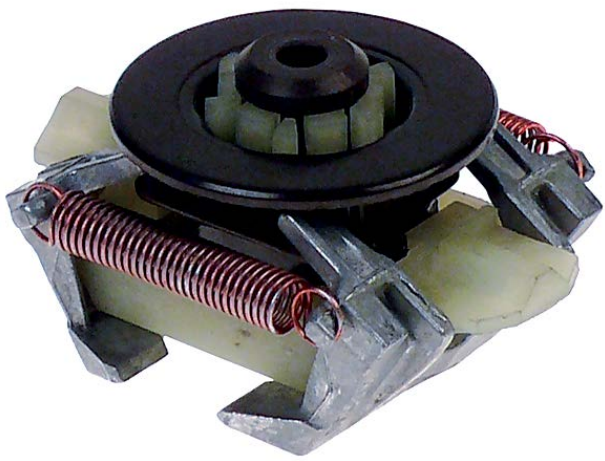

1

GEV No.	347062	Ref. No.	65039100
description	centrifugal switch		

touch sensitive light switches



1

GEV No.	402039	Ref. No.	78508600 78508602R
description	light barrier		
For models:	MF30, MF61		



1

GEV No.	402142	Ref. No.	0200362621
description	light barrier container sensor		



GEV No.	402018	Ref. No.	11054021
description	light barrier for ice thickness set		
For models:	CME1056, CME1056R, CME1356, CME1356R, CME1386, CME1656, CME1656R, CME1686, CME1856W, CME2086, CME256, CME306, CME456, CME456R, CME506, CME506R, CME656, CME656R, CME806, CME806R		



GEV No.	402043	Ref. No.	650674.01 65067402 78508602
description	light barrier L 180mm W 35mm H 46mm		
For models:	AF10, AF100, AF20, AF200, AF30, AF80, MF20, MF22, MF26, MF30, MF36, MF41, MF46, MF51, MF56, MF56ASR, MF61, MF62, MF66, MF66ASR		



GEV No.	402009	Ref. No.	1129015S&P 650674.07 65067400 783167.01
description	light barrier L 310mm W 35mm H 47mm		
For models:	AC045, AC055, AC085, AC105, AC125, AC125B, AC125C, AC175, AC225, AC226, ACM125, ACM175, ACM85, Barline-B40, Barline-B65, Barline-B90, Barline-BUL40, Barline-BUL65, Barline-BUL90, EC045, MC1210, MC15, MC16, MC45, MC46, MC8		

magnetic switches

36x13mm

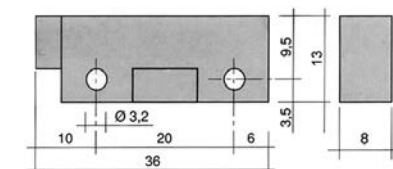
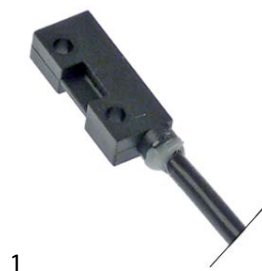

GEV No.	345118 ¹	Ref. No.	CM33210019
description	magnetic switch L 36mm W 13mm 1NO 250V 1A P max. 50W connection cable cable length 980mm		
For models:	MV12, MV18-21, MV25-32		
accessories for	345118		
	GEV No.	345399	Ref. No. 19355007 CM19355004
	magnet ø 3.3mm L 40mm H 8mm W 13mm hole distance 30mm M3		

¹with coded connector

accessories

magnets

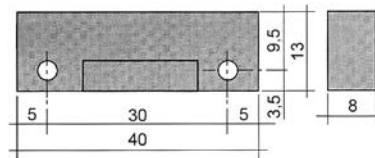

GEV No.	345399	Ref. No.	19355007 CM19355004
description	magnet ø 3.3mm L 40mm H 8mm W 13mm hole distance 30mm M3		
For models:	MV12, MV18-21, MV25-32, MV50		

miscellaneous



GEV No.	347066	Ref. No.	03289101 0A03289101
description	safety switch 250V ø 58mm H 40mm 15A		



lamps

indicator lights

indicator lights (complete)

ø10mm

with screw socket



1

GEV No. 359889 **Ref. No.** 63009108

description indicator light ø 10mm 230V red connection cable

For models: MF102

ø13mm

with plug-in socket



1

GEV No. 359142 **Ref. No.** 63009102

description indicator light ø 13mm green 230V connection male faston 6.3mm temp.-resist. 120°C Qty 1 pcs



1

GEV No. 359141 **Ref. No.** 63009111
63009114

description indicator light ø 13mm red 230V connection male faston 6.3mm temp.-resist. 120°C Qty 1 pcs

For models: AF10, AF20, AF30, MAR10, MAR125, MAR20, MAR30, MAR5, MF82

timers

programme timers



1

GEV No. 500762 **Ref. No.** 1200198002
1200231722
12-1980-02

description gear motor 50/60Hz 3W 230V H 32mm L 64mm W 49mm type CL082994 voltage AC 25rpm shaft ø 5/6mm

For models: CM1000R, CM1400, CM1400R, CM450E, CM650A, CM650C, CM650D, CM650RA, CM650RC, CM650RD, CM855, CM855R

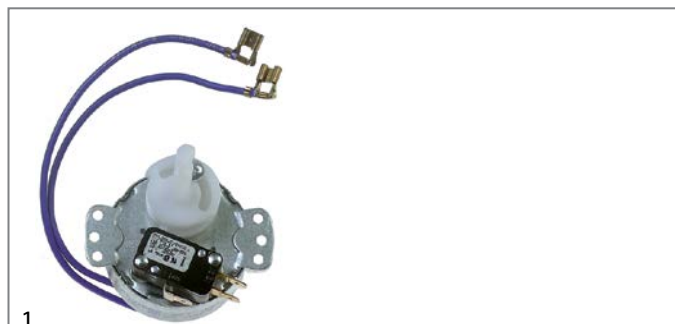

1

GEV No. 500743 **Ref. No.** 1200231726

description gear motor 50Hz 3W 230V H 32mm L 64mm W 49mm voltage AC 15rpm shaft ø 5/6mm



1

GEV No. 500749 **Ref. No.** 0A2592301
12001979 21

description gear motor SINGER 60Hz 3W 115V H 32mm L 64mm W 49mm type 3666131 voltage AC 15rpm shaft ø 4.5x6mm



1

GEV No. 360377 **Ref. No.** 62038705

description timer

For models: AC225, MC1210, MC15, MC45

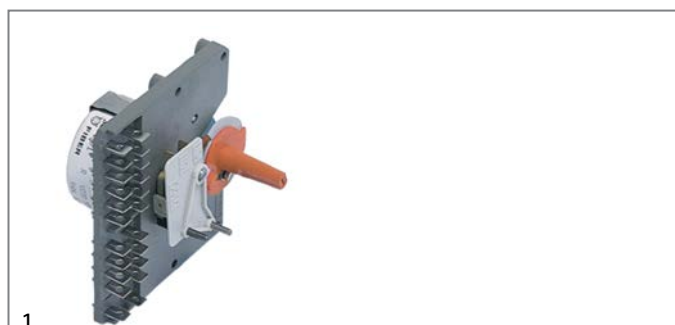

1

GEV No. 360079 **Ref. No.** 1112079S&P
62024413

description timer FIBER P23 engines 1 chambers 1 operation time 12min 230V shaft L 30mm manuf. no. P235JR1J505 motor type M51BJ0R6400

spare parts for 360079

GEV No. 360673 **Ref. No.** —
description motor kit pinion ø 6.8mm teeth 15 230V voltage AC 50/60Hz turn direction clockwise motor ø 48mm H 18.5mm motor type UDS-40NE1RNZ165 cable length 150mm with holder





1

GEV No.	360163	Ref. No.	620244.02
description	timer FIBER P23 engines 1 chambers 1 operation time 15min 230V shaft L 30mm manuf. no. P235JR1J706 motor type M51BJ0R6400		
spare parts for	360163		
	GEV No.	360673	Ref. No. —
	motor kit pinion \varnothing 6.8mm teeth 15 230V voltage AC 50/60Hz turn direction clockwise motor \varnothing 48mm H 18.5mm motor type UDS-40NE1RNZ165 cable length 150mm with holder		

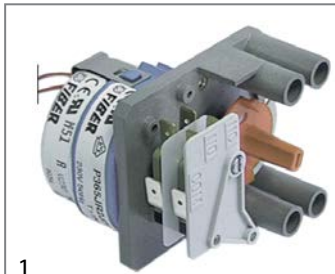

1

GEV No.	360051	Ref. No.	62043100 Z1EL003
description	timer FIBER P36 engines 1 chambers 2 operation time 15min 230V shaft \varnothing mm shaft Lmm manuf. no. P365JR2J717 motor type M51B-J0R6400		
spare parts for	360051		
	GEV No.	360673	Ref. No. —
	motor kit pinion \varnothing 6.8mm teeth 15 230V voltage AC 50/60Hz turn direction clockwise motor \varnothing 48mm H 18.5mm motor type UDS-40NE1RNZ165 cable length 150mm with holder		

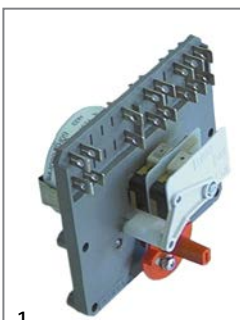

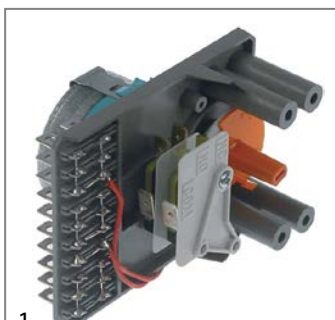

1

GEV No.	360162	Ref. No.	62024409
description	timer FIBER P23 engines 1 chambers 2 operation time 12min 230V manuf. no. P235JR2J501 motor type M51BJ0R6400		
For models:	ACM85		
spare parts for	360162		
	GEV No.	360673	Ref. No. —
	motor kit pinion \varnothing 6.8mm teeth 15 230V voltage AC 50/60Hz turn direction clockwise motor \varnothing 48mm H 18.5mm motor type UDS-40NE1RNZ165 cable length 150mm with holder		



1

GEV No.	360371	Ref. No.	62044102
description	timer FIBER P36 engines 1 chambers 2 operation time 8min 230V shaft \varnothing mm shaft Lmm manuf. no. P365JR2J236 motor type M51B-J0R6400		
For models:	Barline-65, Barline-90		
spare parts for	360371		
	GEV No.	360673	Ref. No. —
	motor kit pinion \varnothing 6.8mm teeth 15 230V voltage AC 50/60Hz turn direction clockwise motor \varnothing 48mm H 18.5mm motor type UDS-40NE1RNZ165 cable length 150mm with holder		



1

GEV No.	360052	Ref. No.	620244.04
description	timer FIBER P23 engines 1 chambers 2 operation time 15min 230V manuf. no. P235JR1J707 motor type M51BJ0R6400		
spare parts for	360052		
	GEV No.	360673	Ref. No. —
	motor kit pinion \varnothing 6.8mm teeth 15 230V voltage AC 50/60Hz turn direction clockwise motor \varnothing 48mm H 18.5mm motor type UDS-40NE1RNZ165 cable length 150mm with holder		

contactors

LOVATO

power contactors



1

GEV No.	380946	Ref. No.	63012405
description	contactor resistive load 25A 230VAC (AC3/400V) 12A/5.7kW main contacts 3NO auxiliary contacts 1NC connection screw connection type BF12012205060		
For models:	MAR10, MAR125, MAR5, MC1210, MC15, MC16, MC45, MC46, MF41, MF51, MF61, MF66, MF66ASR, MV1000, MV50		



			
1			
GEV No.	380087	Ref. No.	63011902
description	power contactor resistive load 16A 230VAC (AC3/400V) 5A/2.2kW main contacts 3NO auxiliary contacts 1NO connection screw connection type 11BG0610A230		
For models:	AC125, AC125B, AC125C, AC126, AC175, AC176, ACM125, ACM175, Barline-65, Barline-90, Barline-B65, Barline-B90, Barline-BUL65, Barline-BUL90		

			
1			
GEV No.	380888	Ref. No.	CM33730712
description	power contactor resistive load 20A 230VAC (AC3/400V) 12A/5.7kW main contacts 3NO auxiliary contacts 1NC connection screw connection type 11BG1201A230		
For models:	MV300, MV450, MV456, MV600, MV800		

			
1			
GEV No.	380704	Ref. No.	63011900
description	power contactor resistive load 20A 230VAC (AC3/400V) 9A/4kW main contacts 3NO auxiliary contacts 1NC connection screw connection type 11BG0901A230		
For models:	AC225, AC226, MF41, MF46, MF51, MV12, MV18, MV18-21, MV25, MV25-32		

			
1			
GEV No.	380574	Ref. No.	63012400
description	power contactor resistive load 25A 230VAC (AC3/400V) 12A/5.7kW main contacts 3NO auxiliary contacts 1NO connection screw connection type B12		
For models:	MF102		

miscellaneous

power contactors

			
1			
GEV No.	380578	Ref. No.	1200204802 1200246902
description	power contactor 208/240V resistive load 30A main contacts 2NO connection male faston 6.3mm		

relays

power relays

with bracket mounting

			
1			
GEV No.	380312	Ref. No.	1109039S&P 62023702 CM19620107
description	power relays FINDER 230VAC 10A 3CO connection male faston 4.8mm bracket mounting dimensions 52x32.2x36.5mm manuf. no. 60.63.8.230.0000		

			
1			
GEV No.	380185	Ref. No.	CM19620103
description	power relays Italiana Relè 230VAC 30A 1NO connection F6.3 bracket mounting dimensions 36.5x32.2x51.8mm manuf. no. A10-230AC-FA		



with male contacts

bullet connectors, 11 contacts



1			
GEV No.	380132	Ref. No.	1109066S&P 62007603
description	power relays Italiana Relè 230VAC 10A 3CO connection plug-in connection round 11-pole manif. no. C43-230AC ZVE11 250V 11-pole		
accessories for	380132		
	GEV No.	380136	Ref. No. —
	relay socket 11-pole connection plug-in connection round 11-pole dimensions 65x28x40mm 250V voltage AC 10A Italiana Relè manif. no. ZVE11		

time relays

time relays



1			
GEV No.	350129	Ref. No.	06052600 62037100
description	time relay FIBER R11B52307F0 time range 6s-30min 230VAC 2x6A 1NO/1CO connection male faston 6.3mm		
For models:	MAR1, MAR10, MAR2, MAR20, MAR3, MAR30, MAR5		



1			
GEV No.	380584	Ref. No.	62038703
description	time relay SYRELEC BAR.F time range 0-10min 220-240VAC 5A 1CO connection screw		
For models:	MF82		

miscellaneous



1			
GEV No.	380580	Ref. No.	CM33580057
description	relay connection with cable for pump		
For models:	MV50		

transformers

open transformers

with plug connection



1			
GEV No.	401827	Ref. No.	1200261721
description	transformer primary 230V secondary 24V 75VA 50/60Hz		

probes

producer-specific probes

probes



1			
GEV No.	403855	Ref. No.	620519 04
description	probe NTC 10kOhm cable PVC probe -40 up to +110°C cable -10 up to 100°C connection plug thread probe ø5x45mm cable length 1.7m		



1			
GEV No.	379628	Ref. No.	0200341021 02-3410-21
description	temperature probe 2x NTC 10K cable PVC probe -40 up to +110°C cable -10 up to 100°C connection coded plug thread probe ø6.5x45mm cable length 0.4/0.55m		
For models:	CME1056, CME1056R, CME256, CME506, CME506R, CME656, CME656R, CME806, CME806R		



GEV No.	402138	Ref. No.	1100054501 1100054521 11054501 11054521 1106291S&P
description	temperature probe 2x NTC 10K cable PVC probe -40 up to +110°C cable -10 up to 100°C connection coded plug thread probe ø6.5x45mm cable length 0.6m		
For models:	CME306, CME456, CME456R, CME686, CME810		

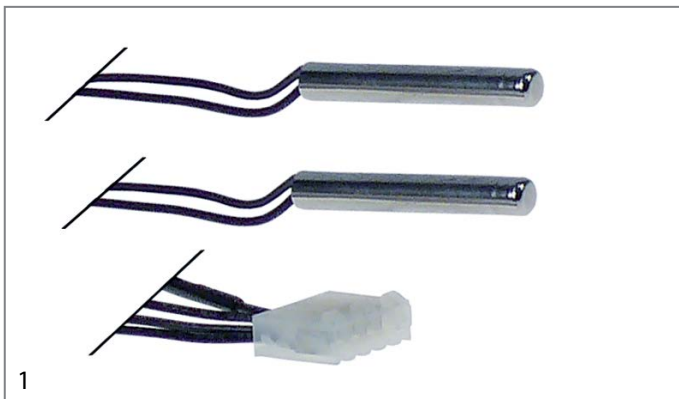

GEV No.	379564	Ref. No.	CM25702401
description	temperature probe 2x NTC 10K cable PVC probe -40 up to +110°C cable -10 up to 100°C connection coded plug thread probe ø6.5x45mm cable length 0.7/1.3m		

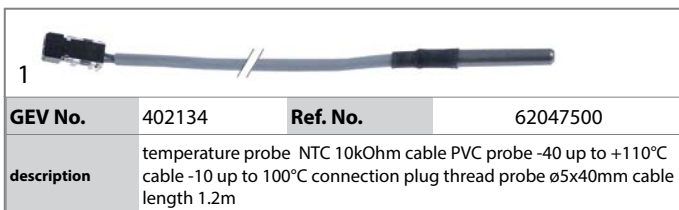

GEV No.	402134	Ref. No.	62047500
description	temperature probe NTC 10kOhm cable PVC probe -40 up to +110°C cable -10 up to 100°C connection plug thread probe ø5x40mm cable length 1.2m		

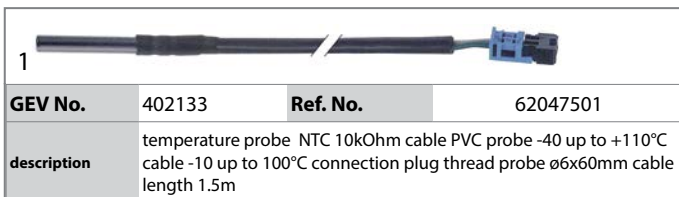

GEV No.	402133	Ref. No.	62047501
description	temperature probe NTC 10kOhm cable PVC probe -40 up to +110°C cable -10 up to 100°C connection plug thread probe ø6x60mm cable length 1.5m		

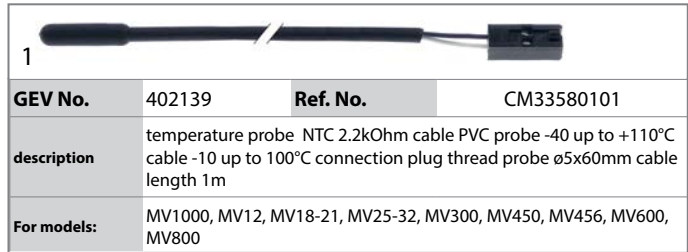

GEV No.	402139	Ref. No.	CM33580101
description	temperature probe NTC 2.2kOhm cable PVC probe -40 up to +110°C cable -10 up to 100°C connection plug thread probe ø5x60mm cable length 1m		
For models:	MV1000, MV12, MV18-21, MV25-32, MV300, MV450, MV456, MV600, MV800		

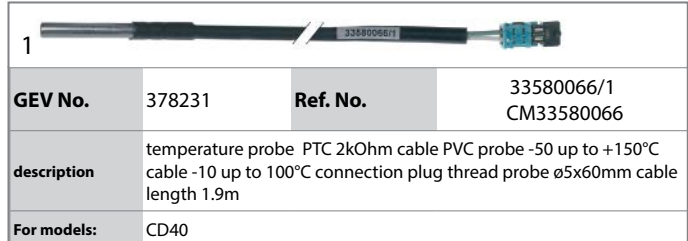

GEV No.	402006	Ref. No.	1129030S&P 62040406 CM33580065
description	temperature probe PTC 2kOhm cable PVC probe -50 up to +150°C cable -10 up to 100°C connection plug thread probe ø5x60mm cable length 1.5m		
For models:	AC045, AC055, ACM35, ACM45, ACM55, Barline-BUL20, Barline-BUL30, CD40		

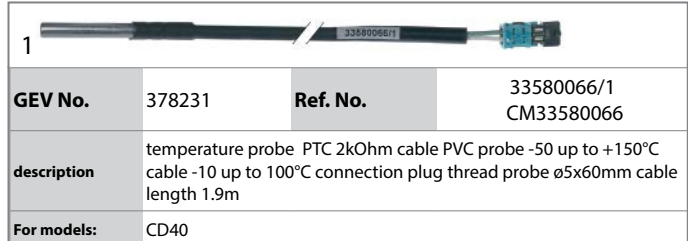

GEV No.	378231	Ref. No.	33580066/1 CM33580066
description	temperature probe PTC 2kOhm cable PVC probe -50 up to +150°C cable -10 up to 100°C connection plug thread probe ø5x60mm cable length 1.9m		
For models:	CD40		

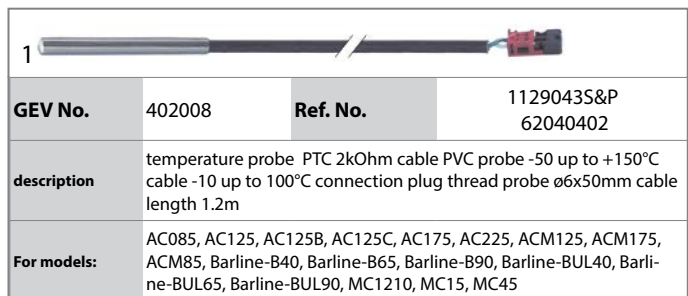

GEV No.	402008	Ref. No.	1129043S&P 62040402
description	temperature probe PTC 2kOhm cable PVC probe -50 up to +150°C cable -10 up to 100°C connection plug thread probe ø6x50mm cable length 1.2m		
For models:	AC085, AC125, AC125B, AC125C, AC175, AC225, ACM125, ACM175, ACM85, Barline-B40, Barline-B65, Barline-B90, Barline-BUL40, Barline-BUL65, Barline-BUL90, MC1210, MC15, MC45		

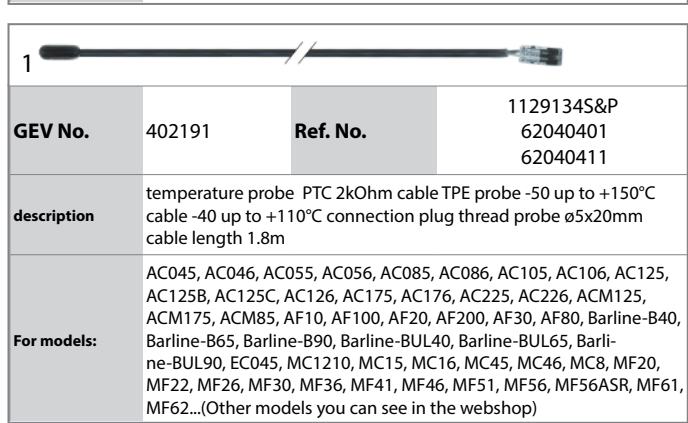

GEV No.	402191	Ref. No.	1129134S&P 62040401 62040411
description	temperature probe PTC 2kOhm cable TPE probe -50 up to +150°C cable -40 up to +110°C connection plug thread probe ø5x20mm cable length 1.8m		
For models:	AC045, AC046, AC055, AC056, AC085, AC086, AC105, AC106, AC125, AC125B, AC125C, AC126, AC175, AC176, AC225, AC226, ACM125, ACM175, ACM85, AF10, AF100, AF20, AF200, AF30, AF80, Barline-B40, Barline-B65, Barline-B90, Barline-BUL40, Barline-BUL65, Barline-BUL90, EC045, MC1210, MC15, MC16, MC45, MC46, MC8, MF20, MF22, MF26, MF30, MF36, MF41, MF46, MF51, MF56, MF56ASR, MF61, MF62...(Other models you can see in the webshop)		



1 

GEV No.	402005	Ref. No.	1129029S&P 620404.00 62040410
description	temperature probe PTC 2kOhm cable TPE probe -50 up to +150°C cable -40 up to +110°C connection plug thread probe ø6x50mm cable length 1.6m		
For models:	AC045, AC055, AC085, AC105, AC106, AC125, AC125B, AC125C, AC126, AC175, AC176, AC225, AC226, ACM125, ACM175, ACM35, ACM45, ACM55, ACM85, AF10, AF100, AF20, AF200, AF30, AF80, Barline-B40, Barline-B65, Barline-B90, Barline-BUL20, Barline-BUL30, Barline-BUL40, Barline-BUL65, Barline-BUL90, EC045, MC1210, MC15, MC16, MC45, MC46, MC8, MF20, MF22, MF26, MF30, MF36, MF41, MF46, MF51, MF56, MF56ASR...(Other models you can see in the webshop)		

Hall sensors

1 

GEV No.	402044	Ref. No.	62040403
description	Hall sensor L 29mm W 26mm H 26mm mounting distance 10mm cable length 1250mm		
For models:	AF10, AF100, AF20, AF200, AF30, AF80, MAR125, MF20, MF22, MF26, MF30, MF36, MF41, MF46, MF51, MF56, MF56ASR, MF61, MF62, MF66, MF66ASR		

accessories

miscellaneous

1 

GEV No.	402040	Ref. No.	1129159S&P 62040404 62040413
description	cable for level electrode cable length 1800mm		
For models:	AF10, AF100, AF20, AF200, AF30, AF80, EC045, MF20, MF22, MF26, MF30, MF36, MF41, MF46, MF51, MF56, MF56ASR, MF61, MF62, MF66, MF66ASR		

electronics

housing for PCBs

1 

GEV No.	694205	Ref. No.	66054800
description	housing PCB L 180mm W 110mm H 40mm		
For models:	AC125B, AC125C, AC175, AF10, AF20, AF30		
accessories for	694205		
	GEV No.	694206	Ref. No.
			19190397/0 66054700 660547.01 660547.02 CM19190403
	lid PCB L 180mm W 110mm H 9mm		

1 

GEV No.	695663	Ref. No.	29070021 2907002S&P 4114460 66054600 CM29070021
description	housing PCB L 230mm W 142mm H 57mm		
For models:	AC105, AC125B, AC125C, AC175, AC225, ACM125, ACM175, ACM35, ACM45, ACM55, ACM85, AF10, AF100, AF20, AF200, AF30, AF80, Barline-B40, Barline-B65, Barline-B90, Barline-BUL20, Barline-BUL30, Barline-BUL40, Barline-BUL65, Barline-BUL90, CD40, MC1210, MC15, MC45, MF30, MF61		



1



GEV No.	694206	Ref. No.	19190397/0 660547.01 660547.02 66054700 CM19190403
description	lid PCB L 180mm W 110mm H 9mm		
For models:	AC105, AC125B, AC125C, AC175, AC225, ACM125, ACM175, ACM35, ACM55, ACM85, AF10, AF100, AF20, AF200, AF30, AF80, Barline-B40, Barline-B65, Barline-B90, Barline-BUL20, Barline-BUL30, Barline-BUL40, Barline-BUL65, Barline-BUL90, CD40, MC1210, MC15, MC45, MF30, MF41, MF51, MF61		
accessories for	694206		
	GEV No.	694205	Ref. No. 66054800
	housing PCB L 180mm W 110mm H 40mm		

1



GEV No.	694796	Ref. No.	CM29015057
description	lid PCB L 205mm W 125mm H 14mm plastic		

PCBs

1



GEV No.	402145	Ref. No.	33580084 CM33580084
description	display PCB for ice maker cable length 1500mm with LED		
For models:	CD40		

1



GEV No.	402124	Ref. No.	62048303
description	display PCB ice cube maker		

1

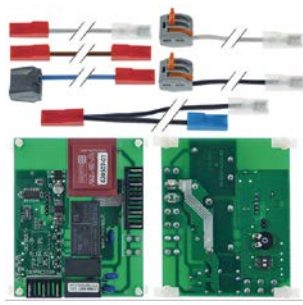

GEV No.	403687	Ref. No.	06076900 62044100
description	electronic timer for ice maker Simag mounting measurements 90x70mm 230		
For models:	Barline-50		

1



GEV No.	403486	Ref. No.	62050700
description	electronic timer L 73mm W 73mm suitable for Simag H 30mm timer		

1

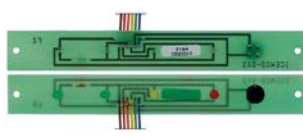

GEV No.	401801	Ref. No.	CM33580024
description	keypad PCB ice maker N200/N300/N500		
For models:	MV12, MV18, MV18-21, MV25, MV25-32, MV50		

1



GEV No.	401824	Ref. No.	33580123 CM33580123
description	PCB		



1

GEV No.	401825	Ref. No.	33580017 CM33580017
description	PCB		



1

GEV No.	401826	Ref. No.	1200237621
description	PCB		



1

GEV No.	402033	Ref. No.	62046218
description	PCB		



1

GEV No.	402034	Ref. No.	1114068S&P 62045602
description	PCB		



1

GEV No.	403499	Ref. No.	33580173 CM33580173
description	PCB 230V L 90mm W 60mm for ice maker		
For models:	MV1000, MV800		



1

GEV No.	402137	Ref. No.	02003707.21 11000539.21 1100053951 11-0539-51 1129170
description	PCB for float switch		
For models:	CME1056, CME1056R, CME1356, CME1356R, CME1386, CME1656, CME1656R, CME1686, CME1856W, CME2086, CME256, CME306, CME456, CME456R, CME506, CME506R, CME656, CME656R, CME686, CME806, CME806R, CME810		



1

GEV No.	401833	Ref. No.	1100053122
description	PCB for ice maker with holder 24V		



1

GEV No.	401828	Ref. No.	00102831
description	PCB for ice maker with housing		





1

GEV No.	401823	Ref. No.	CM33580056
description	PCB for ice-cube maker		
For models:	MV50		





 <p>1</p>			
GEV No.	402003	Ref. No.	1114010S&P 620403.05 620403.17 62040316
description	PCB ice maker AC045/055		
For models:	AC045, AC055, ACM35, ACM45, ACM55, Barline-BUL20, Barline-BUL30		

 <p>2</p>			
GEV No.	400055	Ref. No.	62047000
description	PCB ice maker ECO 45 230V		
For models:	EC045		

 <p>1</p>			
GEV No.	403478	Ref. No.	620507.01
description	PCB ice maker L 90mm W 72mm suitable for Simag H 30mm		

 <p>1</p>			
GEV No.	401799	Ref. No.	CM33580150
description	PCB ice maker N201/N301//N501 230V		
For models:	MV1000, MV300, MV450, MV600, MV800		
accessories for	401799		
	GEV No.	Ref. No.	701450
	connection cable L 1300mm 2-pole level sensor suitable for ice maker connection plug plug type coded plug		

 <p>1</p>			
GEV No.	402136	Ref. No.	81453901 CM81453901
description	PCB kit 230V		

 <p>1</p>			
GEV No.	402035	Ref. No.	62040301 62040312 62040320 62045600
description	PCB L 190mm W 110mm 230V		
For models:	AC105, AC125B, AC125C, AC175, AC225, ACM125, ACM85, MC1210, MC15, MC45		

 <p>1</p>			
GEV No.	403881	Ref. No.	620462 20 62046211
description	PCB L 200mm W 135mm		

 <p>1</p>			
GEV No.	403021	Ref. No.	1114285 CM33580064
description	PCB suitable for Scotsman type WSCM0252		
For models:	CD40		



central units



1			
GEV No.	402004	Ref. No.	06071110 1114466 62040303 62040309 62045602 62046202
description	control box		
For models:	AF10, AF100, AF20, AF200, AF30, AF80, MF20, MF22, MF26, MF30, MF36, MF41, MF46, MF51, MF56, MF56ASR		
accessories for	402004		
	GEV No.	Ref. No.	1129029S&P 620404.00 62040410
	temperature probe PTC 2kOhm cable TPE probe -50 up to +150°C cable -40 up to +110°C connection plug thread probe ø6x50mm cable length 1.6m		
	GEV No.	Ref. No.	6204043
	Hall sensor L 29mm W 26mm H 26mm mounting distance 10mm cable length 1250mm		
	GEV No.	Ref. No.	1129134S&P 62040401 62040411
	temperature probe PTC 2kOhm cable TPE probe -50 up to +150°C cable -40 up to +110°C connection plug thread probe ø5x20mm cable length 1.8m		



1			
GEV No.	403028	Ref. No.	62040318
description	control box		



1			
GEV No.	402135	Ref. No.	62047300
description	control box 230V		



1			
GEV No.	401841	Ref. No.	0A037703.21 12002543.21 12002543.24 12002838.21 12002838.22 12002838.24 1200283823 12283823 17002389.01
description	control box for ice-cube maker 24V 50-60Hz		
For models:	CME1056, CME1056R, CME1356, CME1356R, CME1386, CME1656, CME1656R, CME1686, CME1856W, CME2086, CME256, CME306, CME456, CME456R, CME506, CME506R, CME656, CME656R, CME686, CME806, CME806R, CME810		



1			
GEV No.	401842	Ref. No.	33580122 CM33580122
description	control box for ice-cube maker 24V 50-60Hz		



1			
GEV No.	403836	Ref. No.	CF62046213 CF62046215
description	control box ice maker suitable for ICEMATIC/SCOTSMAN/SIMAG		



1			
GEV No.	403837	Ref. No.	81400264/0 CM81400264/0
description	control box ice maker suitable for ICEMATIC/SCOTSMAN/SIMAG		



			
1			
GEV No.	402042	Ref. No.	001028.09 028640.98 06071100 62046200
description	control box suitable for SFT 012		
For models:	AC045, AC055, AC085, AC105, AC106, AC125, AC126, AC175, AC176, AC225, AC226, EC045, MC1210, MC15, MC16, MC45, MC46		

			
1			
GEV No.	401829	Ref. No.	62040409
description	control box with housing for ice maker		
For models:	MF61		

			
1			
GEV No.	401832	Ref. No.	060711.30 78510400R 78510402R
description	control box with housing for ice-cube maker 230V		
For models:	AC046, AC056, AC086, AC106, AC126, AC176, AC226		

keypads

front foils

			
1			
GEV No.	695867	Ref. No.	65075303
description	front foil for ice dispenser L 145mm W 90mm		

			
1			
GEV No.	694113	Ref. No.	65075305
description	front foil for ice dispenser L 150mm W 100mm		

			
1			
GEV No.	694117	Ref. No.	29020013
description	front foil for ice dispenser L 80mm W 70mm		

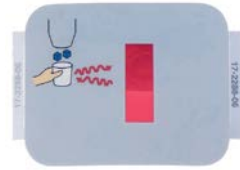
			
1			
GEV No.	694116	Ref. No.	1700228806
description	front foil for ice dispenser L 95mm W 76mm		

			
1			
GEV No.	695843	Ref. No.	19262733 CM19262733
description	front foil for ice maker L 265mm W 76mm		
For models:	MV1000, MV450, MV456, MV600, MV800		

			
1			
GEV No.	695842	Ref. No.	19262763 CM19262763
description	front foil for ice maker mounting pos. inner L 25mm W 140mm		
For models:	MV300, MV450, MV600		

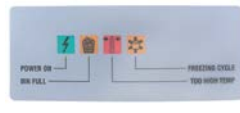
			
1			
GEV No.	694118	Ref. No.	4114695 65062408
description	front foil for ice-cube maker L 134mm W 52mm		
For models:	AC125, AC175, ACM125, ACM175		



solenoid valves

solenoid valves (water)

ELBI

straight



GEV No.	370529	Ref. No.	65010503
description	solenoid valve single straight 120VAC inlet 3/4" outlet 11.5mm DN10 t.max. 60°C ELBI		
For models:	AC125B, AC125C, AC175, AC225, ACM85		
spare parts for	370529		
	GEV No.	370467	Ref. No. —
solenoid valve filter suitable for ELBI			



GEV No.	373017	Ref. No.	65010500
description	solenoid valve single straight 230VAC inlet 3/4" outlet 11.5mm DN10 ELBI		
For models:	AC125B, AC125C, AC175, AC225, ACM125, ACM35, ACM45, ACM55, ACM85, MC15, MC45		
spare parts for	373017		
	GEV No.	370467	Ref. No. —
solenoid valve filter suitable for ELBI			



GEV No.	373000	Ref. No.	19865537 CM19865537
description	solenoid valve single straight 24V inlet 3/4" outlet 11.5mm DN10 t.max. 90°C ELBI plastic		
spare parts for	373000		
	GEV No.	370467	Ref. No. —
solenoid valve filter suitable for ELBI			

angled



GEV No.	370530	Ref. No.	1124346 62021301
description	solenoid valve single angled 120VAC inlet 3/4" outlet 11.5mm input 16l/min DN10 t.max. 60°C ELBI plastic		
spare parts for	370530		
	GEV No.	370467	Ref. No. —
solenoid valve filter suitable for ELBI			



GEV No.	373015	Ref. No.	62021300
description	solenoid valve single angled 230VAC inlet 3/4" outlet 11.5mm DN10 ELBI		
For models:	MC1210		
spare parts for	373015		
	GEV No.	370467	Ref. No. —
solenoid valve filter suitable for ELBI			





GEV No.	373001	Ref. No.	65010554
description	solenoid valve single straight 230VAC inlet 3/4" outlet 11.5mm input/min output 2l/min 50/60Hz DN10 t.max. 90°C duty cycle 100% ELBI plastic		
For models:	AC225, AC226, MC15, MC16, MC8, MV1000, MV300, MV450, MV456, MV600, MV800		





GEV No.	370431	Ref. No.	65010552 CM19865518 Z1D002
description	solenoid valve single straight 230VAC inlet 3/4" outlet 11.5mm input/min output 2l/min DN10 t.max. 90°C ELBI plastic		
For models:	AC105, AC125, AC126, AC175, AC176, ACM125, ACM175, Barline-65, Barline-90, Barline-B65, Barline-B90, Barline-BUL65, Barline-BUL90, CD40		



 <p>1</p>			
GEV No.	370414	Ref. No.	CM19865502 Z1D003
description	solenoid valve single straight 230VAC inlet 3/4" outlet 11.5mm output 2l/min 50/60Hz t.max. 90°C ELBI plastic flow regulating valve outlet white		

 <p>1</p>			
GEV No.	370499	Ref. No.	65010562
description	solenoid valve 2-fold, with reducer straight 230VAC inlet 3/4" outlet 11.5mm t.max. 60°C output A 2.5 orange/min output B 2 whitel/min		

 <p>1</p>			
GEV No.	370461	Ref. No.	CM19865509
description	solenoid valve double straight 230VAC inlet 3/4" outlet 11.5mm input/min output -/4,7l/min DN10 t.max. 90°C ELBI plastic output B 4.7l/min flow regulating valve outlet B grey output A w/t membrane (constantly open)		

 <p>1</p>			
GEV No.	370433	Ref. No.	65010551
description	solenoid valve double straight 230VAC inlet 3/4" outlet 11.5mm input/min output 2/2.5l/min DN10 t.max. 90°C ELBI plastic output A 2l/min output B 2.5l/min flow regulating valve outlet A white flow regulating valve outlet B orange		
For models:	AC045, AC055, AC085, AC105, ACM45, Barline-20, Barline-30, Barline-40, Barline-50, Barline-B40, Barline-BUL20, Barline-BUL30, Barline-BUL40, EC045, ICE-ONE, ICE-THREE, ICE-TWO, SD18		

 <p>1</p>			
GEV No.	370526	Ref. No.	65010553
description	solenoid valve double straight 230VAC inlet 3/4" outlet 11.5mm input/min output 2/2l/min DN10 t.max. 60°C ELBI output A 2 whitel/min output B 2 whitel/min		
For models:	MC1210, MC45, MC46		

ROBERTSHAW/INVENSYS

medium temperature: 90°C 90°C 60°C
 ambient temperature: 60°C 25°C 60°C
 duty cycle: 40% 100% 100%

various

 <p>1</p>			
GEV No.	371105	Ref. No.	1200164604
description	solenoid valve angled 240VAC inlet 3/8" outlet 3/8" EATON (INVENSYS) type K-63314-12		

 <p>1</p>			
GEV No.	371104	Ref. No.	1200143403
description	solenoid valve angled 240VAC inlet 3/8" outlet 3/8" SINGER		

 <p>1</p>			
GEV No.	371259	Ref. No.	198655,98 62040601 CM19865532
description	solenoid valve single angled 230VAC inlet 11.5 outlet 11.5mm DN7 plastic		
For models:	AC225, ACM125, ACM175, ACM45, CD40, MC45		

 <p>1</p>			
GEV No.	370494	Ref. No.	1200231302
description	solenoid valve single angled 240VAC outlet 14.5mm inlet 1/4"mm		



RPE

special outlet



1

GEV No.	370453	Ref. No.	060564.00 62046000 62046001
description	solenoid valve single angled 230VAC inlet 11.5mm outlet 11.5mm RPE		
For models:	AC045, AC055, AC085, AC105, AC125, AC126, AC175, AC176, AC225, AC226, ACM45, CD40, EC045, MC1210, MC15, MC16, MC45, MC46, MC8, MV300		

TP

solenoid valves with reducers



1

GEV No.	370416	Ref. No.	CM19865530
description	solenoid valve double straight 230VAC inlet 3/4" input/min output 1.2/1.2l/min DN10 t.max. 90°C TP plastic outlet 11.5mm output A 1.2l/min output B 1.2l/min flow regulating valve outlet A dark brown flow regulating valve outlet B dark brown		



1

GEV No.	370422	Ref. No.	65010570
description	solenoid valve double straight 230VAC inlet 3/4" t.max. 90°C TP plastic outlet 11.5mm output A 2.5l/min flow regulating valve outlet A yellow flow regulating valve outlet B brown		
For models:	AC086, AC106		



1

GEV No.	370527	Ref. No.	65010564
description	solenoid valve single straight 220-240VAC inlet 3/4" outlet 11.5mm output 0.8l/min TP plastic flow regulating valve outlet white 8VA		
For models:	AC046		

various



1

GEV No.	370491	Ref. No.	1200244626
description	solenoid valve single 240VAC inlet 3/4" outlet 11.5mm		



1

GEV No.	370830	Ref. No.	1100056402 CM19865540
description	solenoid valve single angled 220-240VAC inlet 17.3mm outlet 16mm DELTROL		
For models:	MV456		



1

GEV No.	370493	Ref. No.	1200254801 1200266601 12-2666-01
description	solenoid valve single angled 24V outlet 11.5mm EATON (INVENSYS) plastic inlet 5/8" UNFmm		
For models:	CME1056, CME1056R, CME1356, CME1356R, CME1386, CME1656, CME1656R, CME1686, CME1856W		





1

GEV No.	370496	Ref. No.	CM19865525
description	solenoid valve straight 220VAC outlet 14mm plastic inlet 14mm		
For models:	MV1000, MV12, MV18, MV18-21, MV25, MV25-32, MV450, MV50, MV600, MV800		





metal			
PARKER			
spare parts and accessories			
solenoid coils			
			
GEV No.	371098	Ref. No.	62030615 62030628 62030628.01 62030648
description	solenoid coil 220-230VAC 50/60Hz seat ø 14mm cable length 1000mm 14W		
For models:	AC045, AC046, AC055, AC056, AC085, AC086, AC105, AC106, AC125, AC125B, AC125C, AC126, AC175, AC176, AC225, AC226, ACM125, ACM175, ACM25, ACM35, ACM45, ACM55, ACM85, Barline-20, Barline-21, Barline-30, Barline-31, Barline-40, Barline-50, Barline-65, Barline-90, Barline-B40, Barline-B65, Barline-B90, Barline-BUL20, Barline-BUL30, Barline-BUL40, Barline-BUL65, Barline-BUL90, EC045, ICE-ONE, ICE-THREE, ICE-TWO, MC1210, MC15, MC16, MC45, MC46, MC8, MF62...(Other models you can see in the webshop)		

drain valves			
			
GEV No.	371106	Ref. No.	11000514.30 1100051401 1124246
description	drain solenoid valve 208/230V single inlet 17.5mm outlet 16mm EATON (INVENSYS) plastic		
For models:	MV450, MV600		

			
GEV No.	370691	Ref. No.	CM81454760
description	solenoid valve angled 220-240V kit inlet 17.5mm outlet 16mm		

			
GEV No.	370540	Ref. No.	1200143405
description	solenoid valve angled 240V 50/60Hz outlet 9/16" UNF plastic inlet 9/16" UNF		

solenoid valves (refrigeration)			
ALCO			
valves			
with pipe clamp			
			
GEV No.	370492	Ref. No.	00247122 1200247122
description	solenoid valve 24V		

			
GEV No.	370535	Ref. No.	1100049521
description	solenoid valve straight type 200RB5T4 230V p max 34.5bar connection 12.7mm soldering connection		

			
GEV No.	370534	Ref. No.	1200213502
description	solenoid valve type 200RB3T3 230V tube ø 9.5mm L 118mm hot gas		

CASTEL			
valves			
			
GEV No.	370489	Ref. No.	19865536 CM19865536
description	solenoid valve 24V 10 connection 12mm soldering connection CASTEL straight		







valve bodies

STANDARD series

suitable for refrigerants R22, R134a, R404A, R407C, R410A, R507



GEV No.	370382	Ref. No.	CM19863034
description	solenoid valve body NC type 1028/M10S p max 45bar connection 10mm soldering connection DN 3mm -35 up to +105°C L 125mm refrigeration straight CASTEL		
accessories for	370382		
	GEV No.	371084	Ref. No. —
	solenoid coil CASTEL 230VAC 8VA 50/60Hz connection cable 1000mm type CM2		
	GEV No.	371090	Ref. No. —
	power socket plug type DIN 43650A screw		
	GEV No.	371301	Ref. No. —
	solenoid coil CASTEL 110VAC 8VA 50/60Hz seat ø 11.5mm connection DIN 43650A type HF2		
	GEV No.	371314	Ref. No. —
	solenoid coil CASTEL 240VAC 8VA 50/60Hz seat ø 11.5mm		
	GEV No.	371321	Ref. No. —
	solenoid coil CASTEL 12/24VAC 50/60Hz seat ø 11.5mm connection DIN 43650A type HF2		

PARKER

valves



GEV No.	370415	Ref. No.	CM19863032 CM19863033
description	solenoid valve straight 230V pressure range 0-10bar DN2.5 connection 4mm soldering connection PARKER refrigeration		
For models:	CD40		
spare parts for	370415		
	GEV No.	371033	Ref. No. —
	solenoid coil PARKER 230VAC 9VA coil type YB09 with cable seat ø 14mm		



GEV No.	370490	Ref. No.	19870611 CM19870611
description	solenoid valve type VE-145 230V 8 refrigeration		

valve bodies



GEV No.	370536	Ref. No.	62030606
description	solenoid valve body p max 35bar connection 3/8" US PARKER for ice maker tube ø 10mm hot gas		
For models:	MC1210		
accessories for	370536		
	GEV No.	371098	Ref. No. 62030615 62030628 62030628.01 62030648
	solenoid coil 220-230VAC 50/60Hz seat ø 14mm cable length 1000mm 14W		



GEV No.	370539	Ref. No.	62030607
description	solenoid valve body straight p max 35bar pressure range 21bar connection 10mm soldering connection PARKER tube ø 10mm L 150mm hot gas		
For models:	MC1210, MC45, MF62		

various

valves

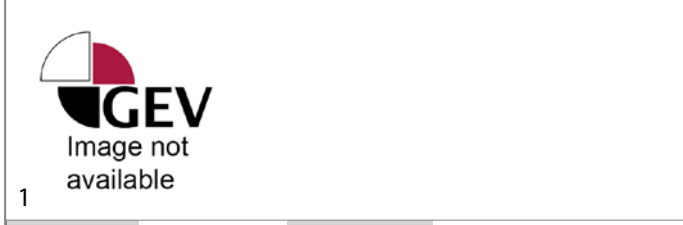

GEV No.	370455	Ref. No.	62030621
description	solenoid valve refrigeration		
For models:	ACM55, ACM85		



Image not available

1

GEV No.	370456	Ref. No.	62030626
description	solenoid valve refrigeration		
For models:	AC125B, AC125C, AC175, ACM125, ACM55, ACM85		



1

GEV No.	370458	Ref. No.	62030614
description	solenoid valve body connection 6mm soldering connection refrigeration angled 90°		
For models:	ACM25, SD18		

Image not available

2

GEV No.	370457	Ref. No.	62030631 62030632
description	solenoid valve refrigeration		
For models:	AC225, MC15, MC45		



1

GEV No.	370424	Ref. No.	62030622
description	solenoid valve body DN 1.9mm connection 6mm soldering connection refrigeration angled 90°		
For models:	AC045, AC046, ACM45, Barline-20, Barline-21, Barline-BUL20, EC045, ICE-ONE		

valve bodies



1

GEV No.	370429	Ref. No.	62030627
description	solenoid valve body angled DN 2.5mm connection 6mm soldering connection refrigeration		
For models:	AC055, AC056, AC085, AC086, AC105, AC106, AC125, AC126, ACM125, ACM175, Barline-30, Barline-31, Barline-40, Barline-50, Barline-65, Barline-B40, Barline-B65, Barline-BUL40, Barline-BUL65, ICE-THREE, ICE-TWO		
accessories for	370429		
	GEV No.	371098	Ref. No.
			62030615 62030628 62030628.01 62030648
	solenoid coil 220-230VAC 50/60Hz seat ø 14mm cable length 1000mm 14W		



1

GEV No.	370454	Ref. No.	62030646
description	solenoid valve body DN 3mm connection 6mm soldering connection refrigeration angled 90°		
For models:	AC175, AC176, AC225, AC226, Barline-90, Barline-B90, Barline-BUL90, MC15, MC16, MC45, MC46, MC8		
accessories for	370454		
	GEV No.	371033	Ref. No.
			—
	solenoid coil PARKER 230VAC 9VA coil type YB09 with cable seat ø 14mm		

Solenoid valve - accessories



1

GEV No.	370430	Ref. No.	62030613
description	solenoid valve body connection 6mm soldering connection refrigeration angled 90°		
For models:	ACM35, ACM45		

filters



1

GEV No.	371101	Ref. No.	65010400
description	solenoid valve filter ø 20mm H 17mm suitable for ELBI		
For models:	AF10, AF20, AF30, MAR1, MAR10, MAR2, MAR20, MAR3, MAR30, MAR5, MF102, MF82		



1

GEV No.	371108	Ref. No.	73318500
description	body for reducer H 10mm ø 15.7mm		
For models:	AC125B, AC125C, AC175, AC225, ACM125, ACM35, ACM45, ACM55, ACM85		



1

GEV No.	694217	Ref. No.	73312300
description	housing for reducer L 15mm ø 11mm		
For models:	MC1210, MC15, MC45		



1

GEV No.	371294	Ref. No.	64002206
description	reducer flow rate 0.34l/min		



1

GEV No.	371296	Ref. No.	64002200
description	reducer flow rate 1.8l/min		
For models:	AC125B, AC125C, AC175, AC225, ACM125, MC1210, MC15, MC45		



1

GEV No.	371087	Ref. No.	C11800503
description	solenoid coil cable length 1100mm seat ø 6.5mm		

pressure switches

for refrigeration

DANFOSS



1

GEV No.	694092	Ref. No.	19550618 CM19550618
description	pressure control DANFOSS type KP5 60-5133 pressure connection vertical refrigeration reset manual switching diff. 3bar pressure range 8-32bar connection 7/16" UNF (1/4" SAE)		
For models:	MV50		



1

GEV No.	542337	Ref. No.	1113148
description	pressure control DANFOSS type ACB-2UB126		



1

GEV No.	541824	Ref. No.	I62045100
description	pressure control pressure connection 6mm soldering connection type ACB-2UA426W 250V cable length 2000mm 6A -30 up to +85°C contacts 1NO		



1

GEV No.	541625	Ref. No.	1113061S&P
description	pressure control pressure connection 6mm soldering connection type ACB-2UA462W 250V cable length 1000mm 6A -30 up to +85°C contacts 1NO		



1

GEV No.	541626	Ref. No.	19550623 CM19550623
description	pressure control switching diff. 30bar reset manual pressure connection 6mm soldering connection 250V cable length 1500mm 1NC 6A		
For models:	MV12		



RANCO

G23 series



GEV No. 695930 **Ref. No.** 1100042521

description pressure control G23-5335-000 tube ø 6.4mm



GEV No. 541605 **Ref. No.** 1100042622
11042622

description pressure control type G23-1000-35

For models: CM500AE-1C, CM500AE-1D, CM500AE-1E



GEV No. 541614 **Ref. No.** 1100041022

description pressure control type G23-5334-000 pressure range 10bar

SAGI NO MIYA



GEV No. 539002 **Ref. No.** 620075.02

description pressure control switch pressure 16bar reset automatic type HTB-3UA12 connection 2.4mm

For models: ACM35, ACM45, ACM55, MAR125, MC1210, MF82, MF83

JOHNSON CONTROLS



GEV No. 541116 **Ref. No.** 1113111
62007500
62007505

description pressure control HD switch pressure 10bar reset automatic switching diff. 1.1bar pressure range 7-29bar p max 38bar refrigeration type P20EA-9950C connection soldering connection 6.35mm CO JOHNSON CONTROLS pressure connection soldering connection 6.35mm

For models: AC045, AC046, AC055, AC056, AC085, AC086, AC105, AC106, ACM45, ACM85, AF10, Barline-20, Barline-21, Barline-30, Barline-31, Barline-40, Barline-50, Barline-65, Barline-90, Barline-B40, Barline-BUL20, Barline-BUL30, Barline-BUL40, EC045, ICE-ONE, ICE-THREE, ICE-TWO, MAR5, SD18



GEV No. 541117 **Ref. No.** 1113038S&P
62023100
62023101

description pressure control HD switch pressure 24bar reset manual switching diff. 4.7bar pressure range 7-29bar p max 38bar refrigeration type P20GA-9950T connection male faston 6.3mm CO JOHNSON CONTROLS pressure connection soldering connection 6.35mm

For models: ACM35, ACM55, ACM85, AF20, AF30, MAR10, MAR125, MAR20, MAR30, MAR5, MF56ASR, MF66ASR, MF82



GEV No. 541606 **Ref. No.** 1100050821
11050821

description pressure control type P100AA-49 JOHNSON CONTROLS

For models: CME256, CME506, CME656



GEV No. 541604 **Ref. No.** 1100050121
11050121

description pressure control type P100CA-27 JOHNSON CONTROLS

For models: C0322, C0522, C1448, C1848, C2148, CME1056, CME1356, CME1656, CME256, CME306, CME456, CME506, CME656, CME806



ROBERTSHAW



1

GEV No.	541615	Ref. No.	1100044622
description	pressure control type MG21-2077 ROBERTSHAW		



1

GEV No.	541607	Ref. No.	1100048522 11048522
description	pressure control type MG21-2110 ROBERTSHAW		
For models:	CME1202, CME1202R, CME1402, CME1402R, MDT5N25A-1A, MDT5N25A-1B, MDT5N25A-6A, MDT5N25A-6B, MDT5N25W-1A, MDT5N25W-1B, MDT5N25W-6A, MDT5N25W-6B, MDT5N40A-1A, MDT5N40A-1B, MDT5N40A-6A, MDT5N40A-6B, MDT5N40W-1A, MDT5N40W-1B, MDT5N40W-6A, MDT5N40W-6B, NDE550AE-1A, NDE550AE-6A, NDE550WE-1A, NDE550WE-6A, NDE650AE-1A, NDE650AE-6A, NDE650WE-1A, NDE650WE-6A, TDE550AE-1A, TDE550AE-6A, TDE550WE-1A, TDE550WE-6A, TDE650AE-1A, TDE650AE-6A, TDE650WE-1A, TDE650WE-6A		



1

GEV No.	541616	Ref. No.	1100047921
description	pressure control type MG51-1108 ROBERTSHAW cable length 700mm		

miscellaneous



1

GEV No.	542135	Ref. No.	CM25474402
description	pressure control reset manual pressure connection 6mm soldering connection switching diff. 45bar 250V cable length 230mm 1NC 6A		
For models:	MV1000, MV450, MV456, MV600, MV800		

compressors

ACC/ZEL

R134A

HMBP monophase

High/Medium evaporation temperature above -20/-15 °C



1

GEV No.	605012	Ref. No.	670100.02 670105.07 CM19165497
description	compressor coolant R134a type GL45TB 220-240V 50Hz HMBP fully hermetic 8.4kg 1/6HP power input 342W cylinder capacity 4.5cm ³ CSIR H 175.5mmW 76W 101W 134W 175W 223W 278W 342W 413W test method ASHRAE ambient temperature max. 43°C		



1

GEV No.	605008	Ref. No.	1137015 67009708
description	compressor coolant R134a type GL80TB 220-240V 50Hz HMBP fully hermetic 9.5kg 1/5HP power input 554W cylinder capacity 7.6cm ³ CSIR H 175.5mm 165W 215W 290W 390W 500W 615W 727W 840W test method ASHRAE ambient temperature max. 43°C		
For models:	ACM25, Barline-20, Barline-21, Barline-BUL20		



1

GEV No.	605011	Ref. No.	67010001
description	compressor coolant R134a type GP14TB 220-240V 50Hz HMBP fully hermetic 11.5kg 3/8HP power input 566W cylinder capacity 14cm ³ CSIR H 203.6mm 191W 271W 373W 497W 643W 810W 999W 1209W test method ASHRAE ambient temperature max. 43°C		

R404a/R507
HMBP monophase
High/Medium evaporation temperature above -20/-15 °C



1

GEV No.	605072	Ref. No.	1137030 67009904
description	compressor coolant R404a/R507 type MX18TBa 220-240V 50Hz HMBP fully hermetic 17.2kg 7/8HP cylinder capacity 18.4cm ³ CSR H 213mmW 640W 839W 1076W 1350W 1663W 2013W 2400W 2826W test method ASHRAE ambient temperature max. 43°C		
For models:	AC225, AC226, MF41, MF46, MV450		
spare parts for	605072		
	GEV No.	365006	Ref. No. —
	operating capacitor capacity 16µF 400V tolerance 5% 50/60Hz ambient temperature max. -25 to +85°C ø 35mm L 121mm M8 aluminium connection cable 300mm MKP protection IP65		
	GEV No.	365128	Ref. No. —
	operating capacitor capacity 16µF 450V tolerance 5% 50-60Hz ambient temperature max. -25 to +85°C ø 40mm L 100mm M8 aluminium connection male faston 6.3mm 16.26.16 protection		

COPELAND

R404a/HP62



1

GEV No.	605097	Ref. No.	1800875027
description	compressor coolant R404a/HP62 type CS18K6E-PFJ-276 220-240V 50Hz fully hermetic		



1

GEV No.	605096	Ref. No.	1800872122
description	compressor coolant R404a/HP62 type RS55C1E-PAZ-213 220-240V 50Hz fully hermetic		

CUBIGEL

accessories



1

GEV No.	380576	Ref. No.	62005731
description	start relay		
For models:	AC045, AC055, AC056, ACM45, ACM85, AF10, AF100, AF20, AF80, Barline-30, Barline-31, Barline-BUL30, EC045, ICE-ONE, ICE-TWO, MF20		



1

GEV No.	380586	Ref. No.	62005732
description	start relay 120/240V voltage AC 8A 1NO		
For models:	ACM25, ACM35, ACM45, AF10		



1

GEV No.	380822	Ref. No.	1109184 62005734
description	start relay 120/240V voltage AC 8A 1NO		
For models:	ACM55		



1

GEV No.	380575	Ref. No.	62005749
description	start relay MTRP5631		
For models:	AC085, AC105, AF20, AF200, Barline-40, CD40, ICE-THREE		

L'UNITE HERMETIQUE / TECUMSEH

R134A

HBP monophase

High evaporation temperature above -15°C



1

GEV No.	605095	Ref. No.	67010102
description	compressor coolant R134a type AE4450Y-FZ 220-240V 50Hz HBP fully hermetic 11.5kg 3/8HP cylinder capacity 13.2cm ³ CSIR H 206mmWWW 526W 672W 843W 1042W 1273W 1540W test method EN 12900		
For models:	AC085, AC105, AF20, AF200, Barline-40, CD40, ICE-THREE		

HMBP monophase

High/Medium evaporation temperature above -20/-15 °C



1

GEV No.	605160	Ref. No.	67009902
description	compressor coolant R134a type CAJ4461Y 220-240V 50Hz HMBP 20kg 1/2HP power input 728W cylinder capacity 18.3cm ³ CSIR H 258mmWW 475W 642W 856W 1115W 1421WW		

R404A

LBP 3-phase

Lower evaporation temperature below -20°C



1

GEV No.	605187	Ref. No.	670099.15
description	compressor coolant R404A type TAJ2464Z 400V 50/60Hz LBP 22.5kg 1.5HP cylinder capacity 34.4cm ³ TRI H 282mm 1108W 1579W 1850W 2317W 2855WWWW test method EN 12900		

HMBP monophase

High/Medium evaporation temperature above -20/-15 °C



1

GEV No.	605065	Ref. No.	670099.05
description	compressor coolant R404A type CAJ4519Z 220-240V 50Hz HMBP 24kg 1.5HP cylinder capacity 34.4cm ³ CSR H 282mmWWW 1769W 2353W 3009W 3756W 4360W 5200W		
For models:	MF51, MF56, MF56ASR, MV600		



HMBP 3-phase

High/Medium evaporation temperature above -20/-15 °C





1	GEV No.	605037	Ref. No.	67009801
description compressor coolant R404A type FH4531Z 220-240V 50Hz HMBP 37kg 2 1/2HP cylinder capacity 56.65cm ³ CSR H 354mmWW 2619W 3491W 4469W 5574W 6826W 8245W 9853W test method EN 12900				

accessories

starting relays

klixons

1			
GEV No.	380582	Ref. No.	62005701
description start relay Klixon 131 15A series 9660B			
For models: ACM35, AF10			

1			
GEV No.	380583	Ref. No.	1105417 62005703
description start relay Klixon 145 series 9660B			
For models: AC045, AC055, AC056, ACM85, AF20, Barline-30, Barline-31, EC045, ICE-ONE, ICE-TWO			

1			
GEV No.	380856	Ref. No.	62016801
description start relay Klixon 170 15A series 9660A			
For models: AF30			

RBM

1			
GEV No.	380595	Ref. No.	1800190340
description start relay RBM 128306-1645PB			

1			
GEV No.	380594	Ref. No.	1800190329
description start relay RBM 128306-1653VB			

miscellaneous

1			
GEV No.	380587	Ref. No.	1109176 1800190356
description start relay 230V 1NC connection male faston 6.3mm			

1			
GEV No.	380581	Ref. No.	62005741
description start relay 230V 1NO/1NC connection male faston 6.3mm with strap dimensions 45x50x42mm			
For models: MC15, MC16			

heating elements

1			
GEV No.	695807	Ref. No.	62030500
description heating element 54W 240V cable length 750mm for compressor TUTCO CH 101			
For models: MAR5			



overload protector (klixon)



1

GEV No.	390654	Ref. No.	4114757 62005868
description	overload protector		
For models:	AC175, AF200, MF22, MF26		



1

GEV No.	390651	Ref. No.	62005846
description	overload protector for engine protective curcuit breaker MRA38031-3007 with cable t.max. 145°C reset automatic		
For models:	ACM55, ACM85, AF20		



1

GEV No.	390544	Ref. No.	62005855
description	overload protector for engine protective curcuit breaker T0168/22 with cable t.max. 150°C reset automatic		
For models:	ACM55		



1

GEV No.	390608	Ref. No.	62005880
description	overload protector for engine protective curcuit breaker T0418/A4		
For models:	AC085, AC105, AF20, AF200, Barline-40, CD40, ICE-THREE		



1

GEV No.	390640	Ref. No.	62005878
description	overload protector for engine protective curcuit breaker with cable reset automatic		
For models:	AC125, AC126, AC225, AC226, ACM125, ACM175, Barline-65, MF41, MF46		



1

GEV No.	390666	Ref. No.	1200230003 12230003
description	overload protector for engine protective curcuit breaker L140-20F 8926 cable length 90mm		
For models:	CM250A, CM250C, CM250D, CM250E, CM450E, CM500AE-1D, CM500AE-1E, CM500R, CM550, CM650A, CM650C, CM650D, CM650RA, CM650RC, CM650RD, CM650RE, CME250, CME500, CME500R, CME650, CME650R		

fans

refrigeration fans

refrigeration motors universal

ELCO

N series - multi fit



1

GEV No.	601427	Ref. No.	18562496 62000310 62000322 62041902 70413406 70413412 CM18562496
----------------	--------	-----------------	--

description	fan motor ELCO 10W 230V 50/60Hz bearing slide bearing L1 49mm L2 59mm L3 86.5mm W 83mm connection cable 500mm 1300/1550rpm 5 mounting options VNT10-20/028		
--------------------	--	--	--

For models:	AC045, AC046, AC055, AC056, AC085, AC086, AC105, AC106, AC125, AC125B, AC125C, AC126, AC175, ACM125, ACM175, ACM45, ACM55, ACM85, AF10, AF100, AF20, AF200, AF30, AF80, Barline-20, Barline-30, Barline-31, Barline-40, Barline-50, Barline-65, Barline-90, Barline-B40, Barline-B65, Barline-BUL20, Barline-BUL30, Barline-BUL40, Barline-BUL65, EC045, ICE-ONE, ICE-THREE, ICE-TWO, MF20, MF22, MF26, MF30, MF36, SD18		
--------------------	--	--	--





spare parts for	601427		
------------------------	--------	--	--

	GEV No.	560140	Ref. No.	—
hexagonal nut thread M4 H 4.8mm SS WS 7 Qty 20 pcs DIN/ISO DIN 985 self-locking				

	GEV No.	560332	Ref. No.	—
plain washer ID ø 4.3mm ED ø 9mm thickness 0.8mm SS Qty 1 pcs				

	GEV No.	560340	Ref. No.	—
hexagonal nut thread M4 H 3.2mm WS 7 SS DIN/ISO DIN 934 / ISO 4032/8673 Qty 1 pcs				

	GEV No.	601413	Ref. No.	—
fixing plate suitable for fanwheel ED ø 32mm shaft ø 7 mounting distance 26mm				

			
1			
GEV No.	601430	Ref. No.	62000313 62041900 CS1761101602
description	fan motor ELCO 5W 230V 50/60Hz bearing slide bearing L1 48mm L2 52mm L3 79.5mm W 83mm connection cable 500mm 1300/1550rpm 5 mounting options VNT5-13/027		
For models:	ACM25, ACM35, Barline-21, MV12, MV450, MV600, SCW14B, SCW14S, SW12		
spare parts for	601430		
	GEV No.	560140	Ref. No. —
	hexagonal nut thread M4 H 4.8mm SS WS 7 Qty 20 pcs DIN/ISO DIN 985 self-locking		
	GEV No.	560332	Ref. No. —
	plain washer ID ø 4.3mm ED ø 9mm thickness 0.8mm SS Qty 1 pcs		
	GEV No.	560340	Ref. No. —
	hexagonal nut thread M4 H 3.2mm WS 7 SS DIN/ISO DIN 934 / ISO 4032/8673 Qty 1 pcs		
	GEV No.	601413	Ref. No. —
	fixing plate suitable for fanwheel ED ø 32mm shaft ø 7 mounting distance 26mm		

N series - standard

			
1			
GEV No.	601527	Ref. No.	18562444 CM18562444
description	fan motor 16W 230V 50/60Hz W 84mm 1300rpm VN16-38		

IMPORT

multi fit fan motors

			
1			
GEV No.	601023	Ref. No.	62023300 62030006 62041300 62041904
description	fan motor 16W 230V 50-60Hz L1 45mm L2 61mm L3 92mm W 84mm cable length 500mm 1300rpm YZF16-25-18/26 5 mounting options bearing slide bearing		
For models:	AC175, AC176, AC225, AC226, ACM125, ACM175, ACM45, Barline-90, Barline-B90, Barline-BUL90, MC15, MC16, MC45, MC46, MC8, MF41, MF46		

miscellaneous

			
1			
GEV No.	601558	Ref. No.	1200212106 62023302
description	fan motor 16W 220V 60Hz W 84mm 1300rpm		
For models:	AC225, MC15		

			
1			
GEV No.	601431	Ref. No.	1103497S&P 60413.00 62041906 62041907
description	fan motor 35W 230V		
For models:	MF51, MF56		



1

GEV No.	601524	Ref. No.	CM1856524
description	fan motor 35W 230V 50/60Hz L3 153mm W 83mm cable length 1600mm 1300rpm with capacitor capacitor 2.5µF		

accessories

fan wheels

aluminium



1

GEV No.	601534	Ref. No.	62027401
description	fan wheel ø 410mm W 80mm shaft intake ø 13mm		
For models:	MAR10, MAR125, MAR30, MAR5, MF82, MF83		



1

GEV No.	601070	Ref. No.	62000705
description	fan wheel sucking ø 200mm fan wheel mounting 25.4mm blade angle 28° W 38mm aluminium		
For models:	ACM35		



1

GEV No.	601282	Ref. No.	62000707 62041932
description	fan wheel sucking ø 200mm fan wheel mounting 25.4mm blade angle 34° W 44mm aluminium		
For models:	AC045, AC046, AC055, AC056, AC125B, AC125C, AC175, ACM125, ACM45, ACM85, AF10, AF100, AF20, AF80, Barline-20, Barline-21, Barline-30, Barline-31, Barline-BUL20, Barline-BUL30, EC045, ICE-ONE, ICE-TWO, MF20, MF30, MV12, MV450, MV600, SD18		



1

GEV No.	601071	Ref. No.	62000703 620419.31
description	fan wheel sucking ø 230mm fan wheel mounting 25.4mm blade angle 25° W 37mm aluminium		
For models:	ACM45, ACM55, ACM85		



1

GEV No.	601283	Ref. No.	62041933
description	fan wheel sucking ø 230mm fan wheel mounting 25.4mm blade angle 28° W 41mm aluminium		
For models:	AC085, AC086, AC105, AC106, AC125, AC126, AC175, AC176, ACM125, ACM175, AF20, AF200, AF30, Barline-40, Barline-50, Barline-65, Barline-90, Barline-B40, Barline-B65, Barline-B90, Barline-BUL40, Barline-BUL65, Barline-BUL90, ICE-THREE, MF22, MF26, MF30, MF36		

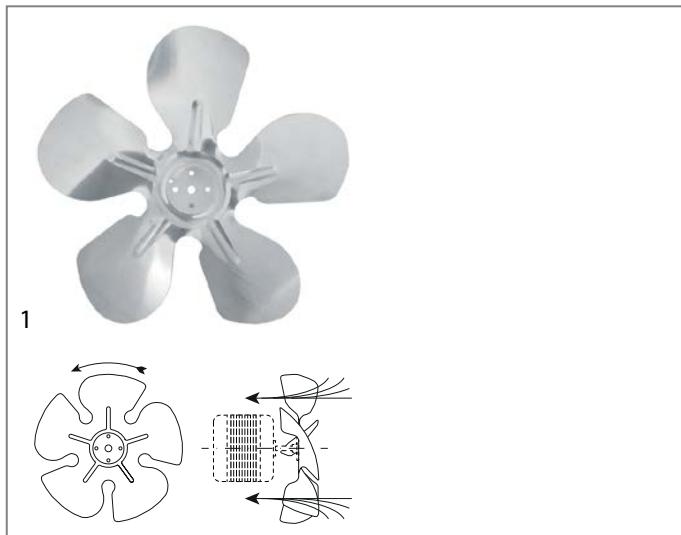

GEV No.	601387	Ref. No.	62000000 62003901 62041934
description	fan wheel sucking ø 254mm fan wheel mounting 25.4mm blade angle 34° W 50mm aluminium		
For models:	AC225, AC226, MC15, MC16, MC45, MC46, MC8, MF41, MF46		

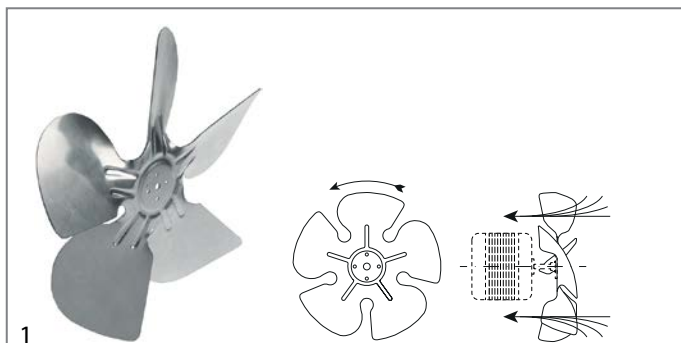

GEV No.	601555	Ref. No.	6200001
description	fan wheel sucking ø 300mm fan wheel mounting 25.4mm blade angle 25° W 45mm aluminium		

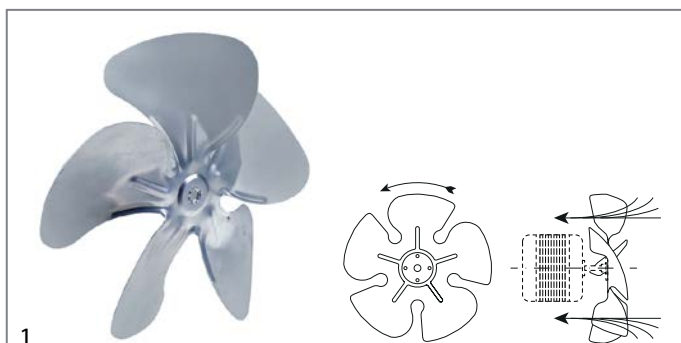

GEV No.	601542	Ref. No.	1800876501 1800887501
description	fan wheel sucking ø 350mm W 86mm aluminium		

aluminium

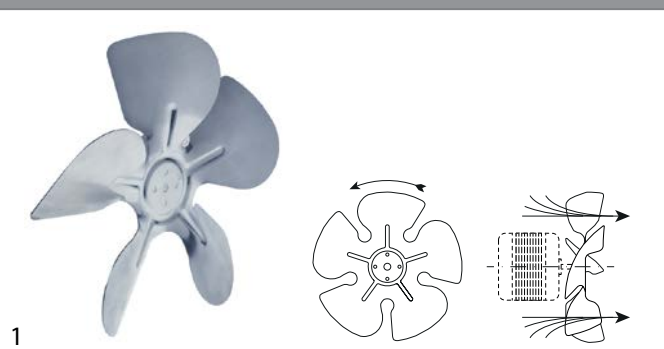

GEV No.	601556	Ref. No.	18740040 CM18740040
description	fan wheel blowing ø 254mm fan wheel mounting 25.4mm blade angle 31° W 46mm aluminium		
For models:	MV18-21, MV25-32		

cold air circulating fans (other)



GEV No.	601540	Ref. No.	1800550501
description	fan motor 115V 60Hz W 98mm H 97mm D 155mm shaft L 40mm shaft ø 10mm GARRETT cable length 100mm 1500rpm		



GEV No.	601554	Ref. No.	620273.00 620273.03 620490.00
description	fan motor 230V 50-60Hz 100W W 105mm H 105mm D 220mm shaft L 80mm shaft ø 12mm EURO MOTORS type 10111-40100 cable length 1500mm 1100rpm		



GEV No.	601533	Ref. No.	1800874002
description	fan motor 230V 50Hz W 95mm H 97mm D 165mm shaft L 40mm shaft ø 9mm GARRETT cable length 1250mm 1250rpm		



cross flow fans

COPREL

with standard coil



1			
GEV No.	601453	Ref. No.	91476111
description	cross flow fan TFR 180 roller ø 60mm roller length 180mm laminated core thickness 16mm motor position right 230V/50-60Hz 17W universal bearing silicone connection male faston 6.3mm airflow 100m ³ /h -30 up to +100°C 230V 50Hz		
accessories for	601453		
	GEV No.	415114	Ref. No.
	heater battery mounting distance 185mm W 40mm H 35mm 2000W 230V temperature restriction 105°C heating circuits 2 connection cable cable length 150mm L 192mm for cross flow fan		

with moulded coils



1			
GEV No.	601547	Ref. No.	91476110
description	cross flow fan COPREL FFR roller ø 60mm roller length 90mm laminated core thickness 15mm motor position right 230V/50Hz 18W refrigeration bearing rubber connection cable 1000mm coil type moulded -10 up to +60°C		

radial fans

miscellaneous



1			
GEV No.	601523	Ref. No.	CM18562443
description	radial fan 230V voltage AC 50Hz 50W H1 175mm L1 165mm D1 ø 83mm W1 160mm W2 73mm H2 60mm W3 82mm H3 96mm		

motors

gear motors

for ice-cube maker

for paddles



1			
GEV No.	501472	Ref. No.	IOM916103101
description	gear motor CROUZET type SP-1905-40 3W 230V 50-60Hz 2rpm shaft ø 5x4mm groove width 17mm shaft ø 4.7mm icemaker		



1			
GEV No.	500407	Ref. No.	CM19440059
description	gear motor LIP type 123MR 8W 220/240V voltage AC 50/60Hz 50rpm turn direction counterclockwise shaft ø 4mm shaft intake ø 6.2mm groove width 2.3mm shaft L 8mm shaft ø 4mm W 74mm		

for sumps



1			
GEV No.	500410	Ref. No.	CM19440065
description	float motor LIP 11W 230V 50Hz 0.7rpm shaft ø 7mm shaft length 20mm W 72mm H 110mm 010		





1

GEV No.	500786	Ref. No.	CM81404024
description	float motor LIP 11W 230V 50Hz 1rpm shaft ø 8mm W 100mm H 90mm for ice maker L 130mm		
spare parts for	500786		
	GEV No.	695670	Ref. No. CM252600000
disc for pan tilting ø 100mm shaft intake ø 7mm			



1

GEV No.	500409	Ref. No.	CM19440063
description	float motor LIP type 001 11W 220/240V voltage 50/60 0.7rpm shaft ø 7mm shaft length 20mm W 71mm H 62mm L 110mm		



1

GEV No.	500411	Ref. No.	CM19440057
description	gear motor BITRON type 97103 11W 230V 50Hz 0.7rpm shaft ø 7mm shaft length 30mm W 72mm H 60mm L 116mm		



1

GEV No.	500412	Ref. No.	CM19440073
description	gear motor LIP type 021B 11W 230V 50Hz 1rpm shaft ø 7mm shaft length 20mm W 74mm D 67mm H 110mm for sump		

miscellaneous



1

GEV No.	601539	Ref. No.	81401520 CM81401520
description	gear motor LIP type 049E 80W 230V 50Hz 13rpm shaft ø 18mm L 160mm W 74mm H 160mm for auger		
For models:	CD40		



1

GEV No.	500739	Ref. No.	02474305 0A02474305
description	gear motor MERKLE 6W 115V 50Hz 39rpm shaft ø 8mm L 140mm W 85mm H 85mm for ice maker		



1

GEV No.	601518	Ref. No.	1200161006
description	gear motor MERKLE type 3724UP-350 230V 50/60Hz shaft ø 9mm L 145mm W 75mm H 85mm		



1

GEV No.	500775	Ref. No.	02465606 0A02465606
description	gear motor MK 230V 50Hz shaft ø 9.1mm L 85mm W 85mm H 116mm for ice maker		



1

GEV No.	500773	Ref. No.	1200240726
description	gear motor type S5814A 230V shaft ø 5mm L 170mm W 75mm H 120mm		

motors
for ice-cube maker
complete



1

GEV No.	500745	Ref. No.	06027303
description			



1

GEV No.	500778	Ref. No.	1200064306
description	motor 180W 110/230V 50Hz 1 phase shaft ø 12.8mm 1425rpm type SKC37MG180FT GENERAL ELECTRIC 0.18kW		

rotors



1

GEV No.	500751	Ref. No.	4114490 79412303R
description	rotor ø 65mm shaft ø 13mm shaft length 180mm for flake ice maker		
For models:	AF10, AF100, AF20, AF200, AF30, AF80, MF20, MF22, MF26, MF30, MF36		



1

GEV No.	500774	Ref. No.	79421600R
description	rotor ø 79mm shaft ø 16mm shaft length 52mm for flake ice maker		
For models:	MF41, MF46, MF51, MF56, MF56ASR, MF61, MF62, MF66, MF66ASR		

stators



1

GEV No.	695826	Ref. No.	62029500
description	stator 230V 50/60Hz 1 phase ø 135mm ID ø 80mm H 45mm with housing		
For models:	MF41, MF46, MF51, MF56, MF56ASR, MF61, MF62, MF66, MF66ASR		



1

GEV No.	500747	Ref. No.	00140026 1200140026
description	stator 230V 50Hz 1 phase ø 101mm ID ø 59mm H 51mm		

universal



1

GEV No.	500744	Ref. No.	62048001
description	motor 550W 230/400V 50Hz 3 phase shaft ø 19mm flange ø 120mm 1400rpm type BN80A4 ø 150mm H 200mm L 240mm BONFIGLIOLI 0.55kW		
For models:	MF82, MF83		



1

GEV No.	500767	Ref. No.	62038302
description	motor 550W 230/400V 60Hz 3 phase shaft ø 19mm 900rpm type H80B6 ø 155mm H 160mm L 240mm fixing dimensions 100x125mm COEL 0.55kW		

pumps

pumps for ice machines



1

GEV No.	695417	Ref. No.	Z11D043
description	insulation for pump		



1

GEV No.	500760	Ref. No.	1200258621
description	pump BECKETT type U21 11W 115V 60Hz outlet ø 16mm L 120mm rotation direction right for ice maker		



1

GEV No.	500776	Ref. No.	1200258624
description	pump BECKETT type U21 11W 115V 60Hz outlet ø 19mm L 124mm rotation direction right for ice maker		



1

GEV No.	500734	Ref. No.	0A02982901
description	pump BECKETT type U62 230V 50/60Hz inlet ø 19mm outlet ø 19mm L 128mm rotation direction right for ice maker		



1

GEV No.	500753	Ref. No.	1200225622
description	pump BECKETT type U62 230V 50/60Hz inlet ø 25mm outlet ø 25mm L 130mm rotation direction right for ice-cube maker capacitor 4µF		



1

GEV No.	500758	Ref. No.	1200258221
description	pump BECKETT type U62 230V 50/60Hz outlet ø 25mm L 120mm rotation direction right for ice maker capacitor 4µF		



1

GEV No.	500764	Ref. No.	62023800 67000200
description	pump COEL type MH40F 35W 230V 50Hz inlet ø 19mm outlet ø 19mm L 125mm rotation direction right for ice maker		



1

GEV No.	500200	Ref. No.	Z11D005
description	pump GRE 100W 230V 50Hz inlet ø 24mm outlet ø 23mm L 145mm rotation direction right		



1

GEV No.	500759	Ref. No.	1103465 62043301
description	pump GRE 30W 230V 60Hz outlet ø 12.5mm L 137mm rotation direction right for ice maker		
For models:	AC045, AC046, AC055, AC056, AC085, AC086, AC105, ACM25, Barline-20, Barline-21, Barline-30, Barline-31, Barline-40, Barline-50, EC045, ICE-ONE, ICE-THREE, ICE-TWO, MV1000, MV300, MV450, MV600, MV800		



1

GEV No.	501470	Ref. No.	1103494 620423.00
description	pump GRE type 100W 230V 50Hz outlet ø 13mm L 137mm rotation direction left icemaker		



1

GEV No.	500752	Ref. No.	62043002
description	pump GRE 60W 230V 60Hz inlet ø 16mm outlet ø 21mm L 110mm rotation direction right for ice maker		
For models:	AC225, AC226, MC1210, MC15, MC16, MC45, MC46, MC8		





1

GEV No.	500777	Ref. No.	62047100
description	pump GRE type CL.F 100W 230V 50Hz inlet ø 20mm outlet ø 11mm L 140mm rotation direction right for ice-cube maker		
For models:	EC045		



1

GEV No.	500045	Ref. No.	06049103 62041500 Z1D009
description	pump GRE type 100W 230V 50Hz inlet ø 24mm outlet ø 21mm L 150mm rotation direction left for ice-cube maker total length 230mm		
spare parts for	500045		
	GEV No.	532082	Ref. No. —
	O-ring EPDM thickness 2.62mm ID ø 61.6mm Qty 10 pcs		
accessories for	500045		
	GEV No.	695417	Ref. No. Z1ID043
	insulation for pump		



1

GEV No.	500597	Ref. No.	62043003
description	pump GRE type MH50F 60W 230V 50Hz outlet ø 21mm L 110mm rotation direction right for ice maker		
For models:	AC125, AC175, Barline-65, Barline-90, Barline-B65, Barline-B90, Barline-BUL65, Barline-BUL90		



1

GEV No.	500772	Ref. No.	1200258625
description	pump HARTELL type U21B 230V 50/60Hz outlet ø 19mm L 120mm rotation direction right for ice-cube maker 1/30HP		





			
1			
GEV No.	500763	Ref. No.	1103544 1200258623
description	pump HARTELL type U21B 25W 230V 50/60Hz outlet ø 19mm L 120mm for ice maker 0.33HP capacitor 12.5µF		

			
1			
GEV No.	499005	Ref. No.	1103590 1200226022 12-2260-22
description	pump HARTELL type U21B 75W 240V 50/60Hz outlet ø 12mm L 120mm for ice maker		
For models:	CM450E		

			
1			
GEV No.	500750	Ref. No.	1200241962 12241962
description	pump MORRILL type MSP 230V 50/60Hz outlet ø 21/27mm L 115mm rotation direction right		
For models:	CM1000, CME1000A, CME1002R, CME1002W, CME855A, CME865R, CME865W, CMS1002R, CMS1002W, MCM1062R, MCM1062W, MC-M860R, MCM860W		

			
1			
GEV No.	500047	Ref. No.	1103066S&P 62028300 62028308 62043300 79311300
description	pump REBO type MH30F1 30W 230V 50Hz outlet ø 12.7mm L 135mm rotation direction left		
For models:	ACM55, ACM85, MV18, MV25		

			
1			
GEV No.	500761	Ref. No.	62043300 62043302 62043307 79311309
description	pump REBO type MH30F1 30W 230V 50Hz outlet ø 13mm L 135mm rotation direction right for ice maker		
For models:	AC045, AC046, AC055, AC056, AC085, AC086, AC105, AC106, ACM25, Barline-20, Barline-21, Barline-30, Barline-31, Barline-40, Barline-50, Barline-B40, Barline-BUL20, Barline-BUL30, Barline-BUL40, CD40, EC045, ICE-ONE, ICE-THREE, ICE-TWO, MAR125, MV1000, MV12, MV18, MV18-21, MV25, MV25-32, MV300, MV450, MV50, MV600, MV800, SD18		

			
1			
GEV No.	500769	Ref. No.	79311304 79311317R
description	pump REBO type MH50F 60W 115V 60Hz outlet ø 18mm L 135mm rotation direction right for ice maker		
For models:	AC125B, ACM125		

			
1			
GEV No.	501471	Ref. No.	79311324R
description	pump REBO type MH50F 60W 220-240V 50Hz outlet ø 18.5mm L 136mm rotation direction left icemaker		
For models:	MV50		

			
1			
GEV No.	500204	Ref. No.	1103068S&P 67000206
description	pump REBO type MH50F 60W 230V 50Hz inlet ø 19mm outlet ø 19mm L 125mm rotation direction right for ice-cube maker		





			
1			
GEV No.	500048	Ref. No.	1103064S&P 1103533S&P 7911303 7911303R 7931130
description	pump REBO type MH50F 60W 230V 50Hz outlet ø 18mm L 137mm rotation direction right for ice maker		

			
1			
GEV No.	501498	Ref. No.	79311312 79311312R
description	pump REBO type MH50F 60W 230V 50Hz outlet ø 18mm L 137mm rotation direction right for ice maker		

			
1			
GEV No.	500746	Ref. No.	1103499S&P 62043006
description	pump REBO type MH50F 60W 230V 50Hz outlet ø 20mm L 110mm rotation direction right for ice-cube maker		
For models:	AC125, AC126, AC175, AC176		

			
1			
GEV No.	500203	Ref. No.	1103067S&P 1103075 62043000 67000212 72312303 73154111 79314600
description	pump REBO type MH50F 60W 230V 50Hz outlet ø 21mm L 110mm rotation direction right for ice maker		
For models:	AC225, AC226, MC1210, MC15, MC16, MC45, MC46, MC8		

			
1			
GEV No.	501481	Ref. No.	81454637-0
description	pump REBO type NR40 40W 220/240V 50Hz outlet ø 12.7mm L 275mm rotation direction left		

			
1			
GEV No.	500046	Ref. No.	0A030625.02 1103065S&P 67003606
description	pump REBO type NR40 40W 230V 50Hz inlet ø 12mm outlet ø 12mm L 75mm rotation direction right for ice-cube maker		
For models:	ACM35		

			
1			
GEV No.	500771	Ref. No.	62023807
description	pump motor 115V 60Hz L 105mm W 78mm H 110mm shaft ø 7mm shaft length 110mm		

condensators & interference suppression filters

starting capacitors

starting capacitors

			
1			
GEV No.	365100	Ref. No.	62016717
description	starting capacitor 160V 60Hz FACON capacity 156µF		
For models:	AF20		





			
1			
GEV No.	365102	Ref. No.	19180567 CM19180567
description	starting capacitor 330V 50Hz with resistor duty cycle 3/1.7% capacity 88µF		
For models:	MV18, MV25		

			
1			
GEV No.	365094	Ref. No.	62016701 62016702
description	starting capacitor 330V capacity 64µF		
For models:	AC085, AC105, AC125, AC126, AC175, AC176, AC225, AC226, ACM125, ACM175, AF10, AF20, AF30, Barline-20, Barline-21, Barline-40, Barline-65, Barline-90, Barline-B40, Barline-B65, Barline-B90, Barline-BUL40, Barline-BUL65, Barline-BUL90, CD40, ICE-THREE, MF30, MF36, MV12, MV300, MV450		

			
1			
GEV No.	365101	Ref. No.	19180508 CM19180508
description	starting capacitor 330V duty cycle 1.7% capacity 125µF		

			
1			
GEV No.	365095	Ref. No.	62016729
description	starting capacitor 43µF 330V 50/60Hz duty cycle 3 60A1D-330043NXET ø 36mm L 80mm M8 plastic connection cable 350mm 04P.5523CM		
For models:	AC045, AC046, AC055, AC056, AC085, AC086, AC105, AC106, AC175, ACM45, ACM85, AF10, AF100, AF20, AF200, AF80, Barline-20, Barline-21, Barline-30, Barline-31, Barline-40, Barline-50, Barline-BUL20, Barline-BUL30, EC045, ICE-ONE, ICE-THREE, ICE-TWO, MC8, MF20, MF22, MF26, SD18		

			
1			
GEV No.	365096	Ref. No.	62016700
description	starting capacitor 88µF 330V		
For models:	AC175, AC176, AC225, AC226, Barline-90, MC15, MC16, MF30, MF36, MF41, MF46, MF51, MF56, MF56ASR, MV18-21, MV300, MV450, MV600		

starting capacitors electrolytic			
			
1			
GEV No.	365098	Ref. No.	62016707
description	starting capacitor 320V 50/60Hz electrolytic capacity 125µF		
For models:	MV25-32		

operating capacitors			
plastic			
			
1			
GEV No.	365018	Ref. No.	620167.24 620167.54
description	operating capacitor capacity 35µF 400V tolerance 5%Hz ambient temperature max. -25 to +85°C ø 45mm L 95mm M8 plastic connection male faston 6.3mm protection		

			
1			
GEV No.	365031	Ref. No.	62029204
description	operating capacitor capacity 4µF 450V tolerance 5% 50/60Hz ambient temperature max. -25 to +85°C ø 31mm L 58mm M8 plastic connection male faston 6.3mm protection		
For models:	AF10, AF100, AF20, AF200, AF30, AF80, MF20, MF22, MF26, MF30, MF36		

metal			
			
1			
GEV No.	365204	Ref. No.	1800190152
description	operating capacitor capacity 15µF 400V tolerance 10% 50-60Hz ambient temperature max. -40 up to +85°C ø 35mm L 135mm M8 aluminium connection cable 630mm		

			
1			
GEV No.	365099	Ref. No.	1800190230
description	operating capacitor capacity 15µF 440V with metal case		



electric accessories

cables

ribbon cables

group 2

1			
GEV No.	694124	Ref. No.	62047001
description	ribbon cable 4-pole L 800mm		
For models:	EC045		

group 7

1			
GEV No.	694212	Ref. No.	29015064 CM29015064
description	ribbon cable 3-pole L 150mm for test		

1			
GEV No.	401818	Ref. No.	62040407
description	ribbon cable 4-pole L 1000mm		
For models:	MF61		

cable harnesses

1			
GEV No.	695947	Ref. No.	1200261901
description	cable harness		

1			
GEV No.	694188	Ref. No.	1200240201 4217037
description	cable harness 3-pole L 170mm permanent temperature 105°C plug type Faston 6.3mm		
accessories for	694188		

	GEV No.	347064	Ref. No.	1105351 1200241101
rocker switch mounting measurements 40x18mm black 1CO 250V 10A				

1			
GEV No.	694097	Ref. No.	62040417
description	cable harness 4-pole L 500mm		

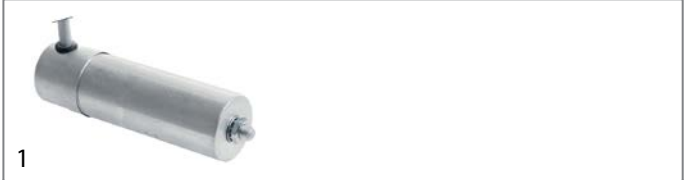

1			
GEV No.	365036	Ref. No.	62016725
description	operating capacitor capacity 20µF 450V tolerance 5% 50/60Hz ambient temperature max. -25 to +85°C ø 35mm L 120mm M8 aluminium connection cable 300mm MKP protection IP65		
For models:	MC15		



1			
GEV No.	365037	Ref. No.	1800190228 1800190253 62017101
description	operating capacitor capacity 30µF 450V tolerance 5% 50/60Hz ambient temperature max. -25 to +85°C ø 35mm L 120mm M8 aluminium connection cable		
For models:	MV25-32		

fuses

fine fuses

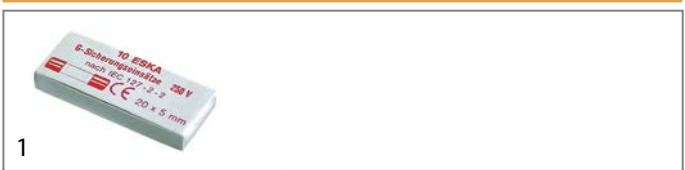

1			
GEV No.	358611	Ref. No.	63001510
description	fine fuse size ø5x20mm 16A fast-acting rated 250V Qty 10 pcs		
For models:	AC045, AC055, AC085, AC105, AC125, AC125B, AC125C, AC175, AC225, ACM125, ACM175, ACM35, ACM45, ACM55, ACM85, AF10, AF100, AF20, AF200, AF30, AF80, Barline-B40, Barline-B65, Barline-B90, Barline-BUL20, Barline-BUL30, Barline-BUL40, Barline-BUL65, Barline-BUL90, MC1210, MC15, MC45, MF20, MF30, MF61		



1			
GEV No.	358509	Ref. No.	63001511
description	fine fuse size ø5x20mm 0.05A slow-acting rated 250V Qty 1 pcs		
For models:	AC045, AC055, ACM35, ACM45, ACM55, Barline-BUL20, Barline-BUL30		

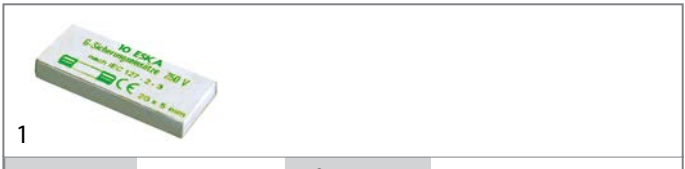

1			
GEV No.	358592	Ref. No.	63001509
description	fine fuse size ø5x20mm 0.1A slow-acting rated 250V Qty 10 pcs		
For models:	AC085, AC105, AC125, AC125B, AC125C, AC175, AC225, ACM125, ACM175, ACM85, AF10, AF100, AF20, AF200, AF30, AF80, Barline-B40, Barline-B65, Barline-B90, Barline-BUL40, Barline-BUL65, Barline-BUL90, MC1210, MC15, MC45, MF20, MF30, MF41, MF51, MF61		



connection cables

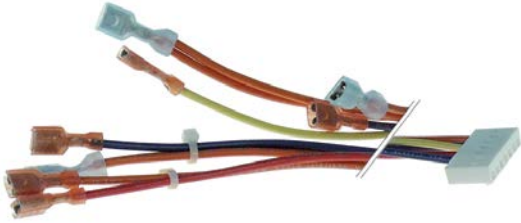

1

GEV No.	401796	Ref. No.	1200247521
description	connecting cable L 690mm connection male faston 6.3mm		



1

GEV No.	701450	Ref. No.	CM81455102
description	connection cable L 1300mm 2-pole level sensor suitable for ice maker connection plug plug type coded plug		

terminals and connectors

not insulated

protective coverings



1

GEV No.	358002	Ref. No.	63010500
description	protective covering size 6.3mm for male faston plastic		

terminals

connection terminals with faston connections



1

GEV No.	550989	Ref. No.	63011401
description	connection terminal 4-pole max. 25A max 450V connection F6.3/F6.3 temp.-resist. 90°C cross section 2.5/4mm ²		
For models:	AC046, AC056, AC086, ACM55, Barline-20, Barline-21, Barline-30, Barline-31, Barline-40, ICE-ONE, ICE-THREE, ICE-TWO, MAR30, MF82		



1

GEV No.	550785	Ref. No.	63007002
description	connection terminal 7-pole max. 20A max 450V connection F6.3/F6.3 temp.-resist. 90°C		

connection terminals with strain relief



1

GEV No.	550356	Ref. No.	63010700
description	power terminal block 2-pole max 450V max. 16A cable ø 15mm cross section 1.5mm ²		

electronic components

photo cells



1

GEV No.	541608	Ref. No.	33580091 62044803 CM33580091
description	photo cell left square connection black L 40mm W 25mm H 40mm for ice maker		
For models:	CD40		



1

GEV No.	541611	Ref. No.	62044802
description	photo cell right square connection blue L 40mm W 25mm H 40mm for ice maker		



1

GEV No.	541627	Ref. No.	33580092 CM33580092
description	photo cell square L 40mm W 25mm H 40mm for ice maker		
For models:	CD40		

equipment-specific units

for ice-cube maker

drain systems

drain fittings



1

GEV No.	696583	Ref. No.	CM25685311
description	drain fitting ø 50mm thread 3/4 hose ø 21mm L 55mm straight for ice-cube maker		
For models:	B190, B193, B390, B393		

filters



1

GEV No.	695769	Ref. No.	02002809.01 02-2809-01 66021101
description	drain filter thread 7/8" ø 32mm H 10mm		
For models:	AC045, AC046, AC055, AC056, AC085, AC086, AC105, AC106, AC125, AC125B, AC125C, AC126, AC175, AC176, AC225, AC226, ACM125, ACM175, ACM35, ACM45, ACM55, ACM85, AF10, AF20, AF30, B350, B550, Barline-21, Barline-31, Barline-40, Barline-50, Barline-65, Barline-90, Barline-B40, Barline-B65, Barline-B90, Barline-BUL40, Barline-BUL65, Barline-BUL90, EC045, ICE-ONE, ICE-THREE, ICE-TWO, MAR1, MAR10, MAR125, MAR2, MAR20, MAR3, MAR30...(Other models you can see in the webshop)		

overflow pipes



1

GEV No.	695748	Ref. No.	66038701
description	overflow pipe for ice maker ID ø 16mm ED ø 24mm L 87mm		
For models:	ACM45, ACM55, ACM85		



1

GEV No.	696609	Ref. No.	66060100
description	overflow pipe for ice maker tube ø 20mm pipe length 24mm ED ø 24.5mm L 109mm		
For models:	Barline-BUL40		



1

GEV No.	695047	Ref. No.	3124070S&P 660219.01
description	overflow pipe L 78mm straight		
For models:	AC045, AC046, AC055, AC056, AC085, AC105, AC125, AC125B, AC125C, AC175, ACM125, ACM175, ACM45, ACM55, ACM85, AF10, Barline-40, Barline-50, Barline-65, Barline-90, Barline-B40, Barline-B65, Barline-B90, Barline-BUL40, Barline-BUL65, Barline-BUL90, EC045, ICE-ONE, ICE-THREE, ICE-TWO, MAR10, MAR20, MAR30, MAR5, RB400, SD18		



1

GEV No.	695790	Ref. No.	66069802
description	overflow pipe tube ø 19mm pipe length 70mm		
For models:	AC105, AC125, AC175, Barline-50, Barline-65, Barline-90		

ice breakers



1

GEV No.	695658	Ref. No.	65076800
description	ice breaker ID ø 22mm ED ø 118mm H 110mm		



1

GEV No.	695962	Ref. No.	01467820 0A01467820
description	ice breaker ID ø 26mm ED ø 51mm H 58mm brass complete		
spare parts for	695962		



GEV No.	523511	Ref. No.	03289830 0A03289830 65105300
----------------	--------	-----------------	------------------------------------

deep-groove ball bearing type 6203-2RS shaft ø 17mm ED ø 40mm W 12mm with sealing discs deep-groove ball bearing DIN 625-1



GEV No.	532518	Ref. No.	1300061716
----------------	--------	-----------------	------------

O-ring Viton thickness 3.53mm ID ø 24.99mm Qty 1 pcs





1

GEV No.	695629	Ref. No.	75400102
description	ice breaker ID ø 26mm ED ø 51mm H 59mm brass		
For models:	AF10, AF100, AF20, AF200, AF30, MF20, MF22, MF26, MF30, MF36		



 <p>1</p>			
GEV No.	696436	Ref. No.	06072000 75400101
description	ice breaker ID ø 26mm ED ø 51mm H 59mm brass with ball bearing		
For models:	AF10, AF20, AF30, AF80, MF30		

 <p>1</p>			
GEV No.	695594	Ref. No.	75100501
description	ice breaker ID ø 36mm ED ø 140mm H 67mm mounting pos. upper		
For models:	MF41, MF46, MF51, MF56, MF56ASR, MF61, MF62, MF66, MF66ASR		

 <p>1</p>			
GEV No.	695625	Ref. No.	0A03257120
description	ice breaker ID ø 71mm ED ø 132mm H 47mm		

ice chutes

discharge chutes

 <p>1</p>			
GEV No.	695992	Ref. No.	66057304
description	discharge chute for ice maker L 110mm W 100mm H 605mm		
For models:	MF41, MF46		

 <p>1</p>			
GEV No.	694098	Ref. No.	66057307
description	discharge chute for ice maker L 110mm W 100mm H 790mm		
For models:	MF51, MF56, MF56ASR, MF61, MF62, MF66, MF66ASR		

 <p>1</p>			
GEV No.	694099	Ref. No.	66045501
description	discharge chute for ice maker L 110mm W 75mm H 470mm		



1

GEV No.	695987	Ref. No.	66047701
description	discharge chute for ice maker L 705mm W 205mm H 105mm		
For models:	MC1210, MC45, MC46		



1

GEV No.	694125	Ref. No.	06055000
description	discharge chute L 785mm W 90mm H 60mm kit		



1

GEV No.	695983	Ref. No.	78404300
description	discharge chute L 85mm W 50mm H 30mm		

ice chutes



1

GEV No.	695595	Ref. No.	CM25250099
description	ice chute for door L 345mm W 205mm white		



1

GEV No.	695891	Ref. No.	1121005 KSC 11
description	ice chute for ice maker L 225mm W 110mm H 210mm set		



1

GEV No.	695179	Ref. No.	25260459 CM25260459
description	ice chute for ice maker L 530mm W 200mm H 150mm		



1

GEV No.	694282	Ref. No.	25260473/0 CM 25260472
description	ice chute for ice-cube maker L 210mm W 365mm H 90mm white		

1

GEV No.	695665	Ref. No.	25260471/0
description	inner door for ice maker L 595mm W 210mm H 95mm white		
For models:	GP75, GP75W		

slide grates



1

GEV No.	695634	Ref. No.	0200333701
description	slide grate for ice maker L 415mm W 195mm H 110mm		



1

GEV No.	694145	Ref. No.	650705.00 Z1AC050
description	slide grate for ice-cube maker L 250mm W 170mm H 25mm		

ice scoops



1

GEV No.	694197	Ref. No.	65007100
description	ice scoop L 160mm W 80mm H 50mm		
For models:	SD18		



1

GEV No.	695244	Ref. No.	650146.00 650923.00
description	ice scoop L 220mm W 114mm H 55mm		

spare parts and accessories



1

GEV No.	695839	Ref. No.	65042802
description	clamp L 8mm hole ϕ 2.8mm dimensions 7x7mm plastic		
For models:	AF10, AF20, AF30		



1

GEV No.	695020	Ref. No.	CM25654016
description	disc for pan tilting		

probes



1

GEV No.	694555	Ref. No.	CM 25725450
description	bracket for probe L 60mm W 56mm H 18mm zinc-plated sheet steel thickness 1mm		
For models:	MV1000, MV12, MV18, MV18-21, MV25, MV25-32, MV300, MV450, MV50, MV600, MV800		



1

GEV No.	694715	Ref. No.	IOM101138078
description	level electrode for ice-cube maker 1-pole cable length 100mm		



1

GEV No.	401764	Ref. No.	1129010S&P CM81453007 CM81453114 CM81453434
description	probe for ice thickness		
For models:	MV1000, MV12, MV18-21, MV25-32, MV300, MV450, MV50, MV600, MV800		



1

GEV No.	694714	Ref. No.	1100054021
description	probe for water level 2-pole		



1

GEV No.	401793	Ref. No.	1129175S&P 81453590/0 CM81453590
description	probe for water level 2-pole cable length 60mm		
For models:	MV300, MV450, MV600		



1

GEV No.	401837	Ref. No.	81453796 CM81453796
description	probe for water level 2-pole cable length 85mm		
For models:	MV1000, MV800		

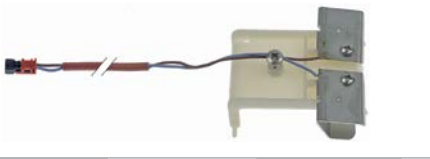

1

GEV No.	696613	Ref. No.	CM81455094
description	sensor for ice maker		
For models:	MV456		

spray systems

SCOTSMAN

spray arms



1

GEV No.	695631	Ref. No.	0200252701
description	spray arm L 200mm nozzles 6 for ice maker		



1

GEV No.	695418	Ref. No.	4114654 65066518
description	spray arm L 242mm nozzles 6 for ice maker		
For models:	SD18		



1

GEV No.	695463	Ref. No.	65066501
description	spray arm L 242mm nozzles 6 for ice maker		



1

GEV No.	695850	Ref. No.	69573900
description	spray arm L 367mm nozzles 4 for ice maker		



1

GEV No.	695420	Ref. No.	65056520
description	spray arm L 385mm nozzles 10 for ice maker		



1

GEV No.	695422	Ref. No.	65066504
description	spray arm L 385mm nozzles 10 for ice maker		



1

GEV No.	695419	Ref. No.	65066502
description	spray arm L 385mm nozzles 8 for ice maker		



1 

GEV No.	695421	Ref. No.	65066505
description	spray arm L 385mm nozzles 8 for ice maker		

1 

GEV No.	695477	Ref. No.	65066523
description	spray arm L 420mm nozzles 8 for ice maker		
For models:	AC105, Barline-50		

1 

GEV No.	695478	Ref. No.	65066524
description	spray arm L 420mm nozzles 8 for ice maker		
For models:	AC105, Barline-50		

1 

GEV No.	695065	Ref. No.	3101121S&P 793127.00
description	spray arm L 435mm nozzles 4 for ice maker		
For models:	AC225, AC226, MC1210, MC15, MC16, MC45, MC46, MC8		

1 

GEV No.	695742	Ref. No.	02548001 0A02548001
description	spray arm L 475mm nozzles 10 for ice maker		

1 

GEV No.	695968	Ref. No.	81453257 CM81453257
description	spray arm L 500mm nozzles 3.5 for ice maker		
For models:	MV50		

1 

GEV No.	695424	Ref. No.	65066506	
description	spray arm L 570mm nozzles 12 for ice maker			
accessories for	695424			
	GEV No.	695000	Ref. No.	66055800
	nozzle for ice-cube maker			

1 

GEV No.	695423	Ref. No.	65066508
description	spray arm L 570mm nozzles 15 for ice maker		

spray units

1 

GEV No.	695442	Ref. No.	4114553 79312905
description	spray system L 273mm W 147mm nozzles 6 complete for ice maker		
For models:	AC045, EC045, ICE-ONE		

1 

GEV No.	695443	Ref. No.	4114519 79312904	
description	spray system L 273mm W 180mm nozzles 6 complete for ice maker			
For models:	AC055, AC085, ICE-THREE, ICE-TWO			
spare parts for	695443			
	GEV No.	695063	Ref. No.	3102028S&P 660519.03
	nozzle cap set 3-piece L 111mm W 30mm H 12mm			

1 

GEV No.	695444	Ref. No.	4114084S&P 793117.00 79311701 79312901
description	spray system L 285mm W 210mm nozzles 6 complete for ice maker		
For models:	AC125, AC125B, AC125C, AC175, ACM125, ACM175, Barline-20, Barline-21, Barline-30, Barline-31, Barline-40, Barline-65, Barline-90, Barline-B40, Barline-B65, Barline-B90, Barline-BUL20, CD40		

1 

GEV No.	695635	Ref. No.	79312909
description	spray unit L 280mm W 205mm nozzles 6 complete for ice maker		
For models:	AC046, AC056		

accessories

1 

GEV No.	695068	Ref. No.	4114231 66055700
description	end cap for ice maker insertion size 13x13mm		
For models:	AC056, AC086, AC105, AC106, AC126, AC176, Barline-50, Barline-BUL30, Barline-BUL40, Barline-BUL65, Barline-BUL90, SD18		

			
1			
GEV No.	695062	Ref. No.	3102026S&P 660519.01 660519.02
description	nozzle		
For models:	AC125, AC125B, AC125C, AC175, ACM125, ACM175, ACM45, ACM85, Barline-20, Barline-30, Barline-40, Barline-65, Barline-90, Barline-B40, Barline-B65, Barline-B90, Barline-BUL20		

			
1			
GEV No.	695060	Ref. No.	3102037S&P 660155.03
description	nozzle for ice maker thread 3/8" ø 19.5mm H 13mm		
For models:	AC125B, AC125C, AC175, ACM35, ACM55, ACM85		

			
1			
GEV No.	695000	Ref. No.	66055800
description	nozzle for ice-cube maker		
For models:	AC056, AC086, AC105, AC106, AC126, AC176, Barline-50, Barline-65, Barline-90, Barline-B40, Barline-B65, Barline-B90, Barline-BUL30, Barline-BUL40, Barline-BUL65, Barline-BUL90, SD18		

			
1			
GEV No.	695063	Ref. No.	3102028S&P 660519.03
description	nozzle cap set 3-piece L 111mm W 30mm H 12mm		
For models:	AC045, AC055, AC085, ACM45, EC045, ICE-ONE, ICE-THREE, ICE-TWO		

			
1			
GEV No.	695115	Ref. No.	06052900 3102026S&P
description	nozzle cap set for ice maker 3-piece L 110mm W 30mm H 12mm		
For models:	Barline-21, Barline-31		

			
1			
GEV No.	695780	Ref. No.	06052901
description	nozzle cap set for ice maker 3-piece L 110mm W 30mm H 12mm grey		
For models:	AC046, AC056, AC086		

			
1			
GEV No.	695943	Ref. No.	02986801 0A02986801
description	pip kit		

			
1			
GEV No.	695066	Ref. No.	4114099S&P 660475.00
description	spray arm holder for ice maker H 150mm shaft ø 15mm		
For models:	AC225, AC226, MC1210, MC15, MC16, MC45, MC46, MC8		

			
1			
GEV No.	694129	Ref. No.	66032000
description	sump for spray system L 190mm W 118mm H 42mm plastic		
For models:	ACM25		

			
1			
GEV No.	695061	Ref. No.	3102038S&P 660296.02
description	swirl ice cube maker plastic ø 15mm Lmm Wmm H 3.4mm shaft ømm black		
For models:	AC125B, AC125C, AC175, ACM35, ACM55, ACM85		

doors

bushes

			
1			
GEV No.	695782	Ref. No.	66028600
description	bush for door ED ø 12.5mm ID ø 8.2mm L 10.8mm plastic		
For models:	AC045, AC046, AC055, AC056, AC085, AC086, AC105, AC106, AC125, AC125B, AC125C, AC126, AC175, AC176, AC225, AC226, ACM125, ACM175, ACM45, ACM55, ACM85, AF10, AF100, AF20, AF200, AF30, AF80, Barline-40, Barline-50, Barline-65, Barline-90, EC045, ICE-ONE, ICE-THREE, ICE-TWO		

			
1			
GEV No.	695761	Ref. No.	0200238001
description	bush for door hinge ED ø 9mm ID ø 7mm L 10mm plastic		
For models:	BH550		



hinges

 <p>1</p>			
GEV No.	695647	Ref. No.	19120085 CM19120085
description	door hinge mounting pos. left shaft ø 8mm L 50mm		
For models:	B190, B350, B390, B550		

 <p>1</p>			
GEV No.	695648	Ref. No.	19120084 CM19120084
description	door hinge mounting pos. right shaft ø 8mm L 50mm		
For models:	B190, B350, B390, B550		

 <p>1</p>			
GEV No.	694219	Ref. No.	81461110 CM81461110
description	hinge mounting pos. centre shaft ø 6.3mm L 42mm		
For models:	B120		

 <p>1</p>			
GEV No.	695948	Ref. No.	0200265803
description	hinge mounting pos. upper and bottom L 130mm type 2842-1009-1110		

 <p>1</p>			
GEV No.	695781	Ref. No.	0A03239601
description	hinge bearing L 40mm W 38mm H 40mm mounting pos. left thickness 3.5mm		
For models:	BH550		

 <p>1</p>			
GEV No.	695776	Ref. No.	0A03239602
description	hinge bearing L 40mm W 38mm H 40mm mounting pos. right thickness 3.5mm		
For models:	BH550		

doors

 <p>1</p>			
GEV No.	694126	Ref. No.	03393820 0A03393820
description	door for ice container W 765mm H 390mm thickness 5mm		
For models:	BH550		

 <p>1</p>			
GEV No.	695743	Ref. No.	CM81460184 CM81460326
description	door for ice maker W 1080mm H 275mm thickness 16mm		
For models:	B350, B550		

 <p>Image not available</p> <p>1</p>			
GEV No.	695906	Ref. No.	79200901 79200903
description	door for ice maker W 372mm H 210mm thickness 18mm hole ø 5mm		



1

GEV No.	696654	Ref. No.	81420528
description	door for ice maker W 680mm H 345mm thickness 20mm		



1

GEV No.	695915	Ref. No.	03264801 0A03264801
description	door for ice maker W 770mm H 290mm thickness 20mm		



1

GEV No.	695456	Ref. No.	78205500R
description	door for ice-cube maker W 340mm H 210mm thickness 19mm		



1

GEV No.	695458	Ref. No.	78207900R
description	door for ice-cube maker W 345mm H 195mm thickness 14mm		
For models:	Barline-20, Barline-21, Barline-BUL20		



1

GEV No.	695462	Ref. No.	4114157 66057200 66057201 79200905
description	door for ice-cube maker W 395mm H 215mm thickness 18mm		
For models:	AC045, AC055, AC085, ACM45, ACM55, ACM85, EC045, ICE-ONE, ICE-THREE, ICE-TWO		



1

GEV No.	695459	Ref. No.	4114204 782079.05R 782079.06 78207905
description	door for ice-cube maker W 420mm H 200mm thickness 18mm		
For models:	Barline-30, Barline-31, Barline-BUL30		



1

GEV No.	695457	Ref. No.	4114279 781503.00R 792011.01 79201102R
description	door for ice-cube maker W 505mm H 270mm thickness 21mm		
For models:	AC225, AF10, AF100, AF20, AF200, AF30		



1

GEV No.	695644	Ref. No.	81460338 CM81460338
description	door for ice-cube maker W 565mm H 295mm thickness 17mm		
For models:	B190		



1

GEV No.	694101	Ref. No.	66078601
description	door for ice-cube maker W 600mm H 260mm thickness 24mm		
For models:	AC126, AC176		

1

GEV No.	695461	Ref. No.	060517.05 06051704
description	door kit for ice-cube maker W 655mm H 260mm thickness 19mm		



1

GEV No.	696473	Ref. No.	4114166S&P 79200909R
description	door W 600mm H 260mm thickness 17mm		
For models:	AC125, AC175		



1

GEV No.	695460	Ref. No.	060517.01 06051700
description	door with door guide for ice-cube maker W 485mm H 260mm thickness 19mm		



1

GEV No.	695628	Ref. No.	78128400R
description	trapdoor for ice-cube maker W 322mm H 175mm thickness 18mm		

door guides



1

GEV No.	695448	Ref. No.	66052301
description	door guides mounting pos. left L 215/240mm W 14mm		
For models:	AC105, AC125, AC125B, AC125C, AC175, ACM125, ACM175, AF80		



1

GEV No.	696758	Ref. No.	660784 01
description	door guides mounting pos. left L 250mm W 210mm plastic		
For models:	AC086, AC106, AC126, AC176		



1

GEV No.	695447	Ref. No.	66052300
description	door guides mounting pos. right L 215/240mm W 14mm		
For models:	AC105, AC125, AC125B, AC125C, AC175, ACM125, ACM175, AF80		



1

GEV No.	696757	Ref. No.	660784 00
description	door guides mounting pos. right L 250mm W 210mm plastic		
For models:	AC086, AC106, AC126, AC176		

door frames



1

GEV No.	694160	Ref. No.	CM25165550
description	door frame W 565mm H 510mm thickness 60mm		
For models:	B193		



GEV No.	694149	Ref. No.	00102702
description	door frame W 675mm H 380mm thickness 24mm complete		
For models:	AC175		



GEV No.	695912	Ref. No.	78207801R
description	door frame W 675mm H 380mm thickness 24mm with door guide		
spare parts for	695912		



GEV No.	695447	Ref. No.	66052300
description	door guides mounting pos. right L 215/240mm W 14mm		



GEV No.	695448	Ref. No.	66052301
description	door guides mounting pos. left L 215/240mm W 14mm		



GEV No.	695918	Ref. No.	78207810R
description	door frame W 675mm H 380mm thickness 24mm with door guide		

door shafts



GEV No.	695789	Ref. No.	0200280601
description	door shaft ø 6.1mm L 19mm thread 3/16" stainless steel		
For models:	BH550		

curtains

with holder



GEV No.	695778	Ref. No.	06045400R
description	curtain for ice maker W 155mm H 80mm with holder shaft length 166mm shaft ø 6mm		



GEV No.	695953	Ref. No.	0200247901
description	curtain for ice maker W 210mm H 80mm holder length 230mm		



GEV No.	694185	Ref. No.	0200203801
description	curtain for ice-cube maker W 215mm H 88mm holder length 204mm		

without holder



GEV No.	695903	Ref. No.	78416903
description	curtain for ice maker W 165mm H 83mm shaft length 187mm shaft ø 6mm		
For models:	ACM25		



GEV No.	695726	Ref. No.	CM81401600
description	curtain for ice maker W 250mm H 70mm shaft length 270mm shaft ø 6mm		





GEV No.	695429	Ref. No.	4114368S&P 78317100R
description	curtain for ice maker W 250mm H 70mm shaft length 280mm shaft ø 6mm		
For models:	SD18		



GEV No.	695440	Ref. No.	4114555 78425002R
description	curtain for ice maker W 283mm H 115mm shaft length 305mm shaft ø 6mm		
For models:	Barline-20, Barline-30, Barline-50, Barline-BUL20, Barline-BUL30, CD40		



 <p>1</p>			
GEV No.	695076	Ref. No.	4114053S&P 784169,09 78416909R
description	curtain for ice maker W 284mm H 83mm		
For models:	AC045, AC055, AC085, ACM45, ACM55, ACM85, EC045, ICE-ONE, ICE-THREE, ICE-TWO		

 <p>1</p>			
GEV No.	695441	Ref. No.	4114645 78445702R
description	curtain for ice maker W 574mm H 115mm shaft length 610mm shaft ø 6mm		
For models:	Barline-65, Barline-90, Barline-B65, Barline-B90, Barline-BUL65, Barline-BUL90		

 <p>1</p>			
GEV No.	695438	Ref. No.	4114554 78445700R
description	curtain for ice maker W 293mm H 115mm shaft length 350mm shaft ø 6mm		
For models:	Barline-40, Barline-B40, Barline-BUL40		

 <p>1</p>			
GEV No.	695886	Ref. No.	78445703R
description	curtain for ice maker W 574mm H 84mm shaft length 620mm shaft ø 6mm		
For models:	AC125, AC175, ACM125, ACM175, Barline-65, Barline-90		

 <p>1</p>			
GEV No.	695632	Ref. No.	78416904
description	curtain for ice maker W 295mm H 115mm shaft length 350mm shaft ø 6mm		

 <p>1</p>			
GEV No.	696756	Ref. No.	4114669 78445709R
description	curtain for ice maker W 580mm H 115mm shaft length 595mm shaft ø 6mm		
For models:	AC126, AC176		

 <p>1</p>			
GEV No.	695075	Ref. No.	4114089S&P 784169,01 784169,01R
description	curtain for ice maker W 305mm H 115mm shaft length 323mm shaft ø 6mm		
For models:	ACM35		

 <p>1</p>			
GEV No.	699353	Ref. No.	78445706R
description	curtain W 295mm H 115mm shaft length 305mm shaft ø 7mm		

 <p>1</p>			
GEV No.	695439	Ref. No.	4114518 78445704R
description	curtain for ice maker W 407mm H 84mm shaft length 458mm shaft ø 6mm		
For models:	AC105, Barline-50		

 <p>1</p>			
GEV No.	695077	Ref. No.	4114155S&P 784250.03 784250.03R
description	curtain for ice maker W 570mm H 115mm shaft length 610mm shaft ø 6mm		
For models:	ACM125, ACM175		

accessories
holders

 <p>1</p>			
GEV No.	695078	Ref. No.	66046900 66046901 66046902
description	curtain holder for ice maker		
For models:	AC045, AC055, AC085, ACM45, ACM55, ACM85, EC045, ICE-ONE, ICE-THREE, ICE-TWO		



1

GEV No.	695080	Ref. No.	66038800
description	curtain holder for ice maker W 15mm H 80mm left		
For models:	AC086, AC106, AC125B, AC125C, AC126, AC175, AC176, ACM125, ACM175, Barline-20, Barline-21, Barline-30, Barline-31, Barline-40, Barline-50, Barline-65, Barline-90, Barline-B40, Barline-B65, Barline-B90, Barline-BUL20, Barline-BUL30, Barline-BUL40, Barline-BUL65, Barline-BUL90, CD40, SD18		



1

GEV No.	695079	Ref. No.	66038801
description	curtain holder for ice maker W 15mm H 80mm right		
For models:	AC086, AC106, AC125B, AC125C, AC126, AC175, AC176, ACM125, ACM175, Barline-20, Barline-21, Barline-30, Barline-31, Barline-40, Barline-50, Barline-65, Barline-90, Barline-B65, Barline-B90, Barline-BUL20, Barline-BUL30, Barline-BUL65, Barline-BUL90, CD40, SD18		

lamellas



1

GEV No.	695081	Ref. No.	660629.00
description	lamella for ice maker W 28mm H 71mm ø 6mm		

pan mechanics

sumps



1

GEV No.	695014	Ref. No.	814030050 CM81403005
description	sump complete for ice maker L 180mm W 125mm H 80mm shaft L 205mm N20 blue		
For models:	GP20, GP20W		



1

GEV No.	696414	Ref. No.	814016210 CM81401621
description	sump complete for ice maker L 180mm W 125mm H 80mm shaft L 210mm N25 blue		
For models:	GP20, GP20W		



1

GEV No.	695015	Ref. No.	814030070 CM81403007
description	sump complete for ice maker L 225mm W 165mm H 80mm shaft L 255mm for modell N30/N35 white		
For models:	GP30, GP30W		



1

GEV No.	695017	Ref. No.	41140135&P CM81413001
description	sump complete for ice maker L 275mm W 220mm H 75mm ICEMATIC white		



1

GEV No.	695016	Ref. No.	CM81414519 CM81423003
description	sump complete for ice maker L 275mm W 220mm white		



1

GEV No.	695019	Ref. No.	CM81442008
description	sump complete for ice maker L 690mm W 230mm H 65mm ICEMATIC		



1

GEV No.	695018	Ref. No.	CM81423002
description	sump complete L 455mm W 180mm H 60mm ICEMATIC		



1

GEV No.	696647	Ref. No.	CM25820130
description	sump for ice maker L 680mm W 240mm H 150mm white		
For models:	MV456		





			
1			
GEV No.	695911	Ref. No.	66048700
description	sump for spray system H 140mm ø 495mm		
For models:	AC225, AC226, MC1210, MC15, MC16, MC45, MC46, MC8		

			
Image not available			
1			
GEV No.	695803	Ref. No.	79311400R
description	water container for ice maker L 350mm W 225mm H 180mm		

			
1			
GEV No.	695662	Ref. No.	CM25820125
description	water container for ice maker L 697mm W 260mm H 148mm white		
For models:	MV1000, MV450, MV600, MV800		

			
1			
GEV No.	694100	Ref. No.	66071000
description	water container for ice-cube maker L 96mm W 96mm H 130mm inlet 20mm outlet 20mm		
For models:	EC045		

spare parts and accessories			
			
1			
GEV No.	695646	Ref. No.	25726279 25726478/0
description	bracket for inner door L 44mm W 20mm H 18mm shaft intake ø 6.3mm mounting distance 30mm		
For models:	GP20, GP20W, GP30, GP30W, GP75, GP75W, GP90, GP90W		

			
1			
GEV No.	695651	Ref. No.	CM25525419
description	bracket for pulser L 34mm W 15mm H 60mm		

			
1			
GEV No.	695415	Ref. No.	CM25726122
description	bracket for sump mounting pos. right ICEMATIC		

			
1			
GEV No.	695009	Ref. No.	CM25726115
description	bracket paddle L 50mm W 17mm H 23mm shaft intake ø 6.5mm mounting distance 30mm		

			
1			
GEV No.	695681	Ref. No.	CM25110914
description	bush for spindle ED ø 10mm ID ø 6.2mm L 20mm plastic ICEMATIC		

			
1			
GEV No.	695670	Ref. No.	CM252600000
description	disc for pan tilting ø 100mm shaft intake ø 7mm		

			
1			
GEV No.	695479	Ref. No.	CM81413043
description	disc for pan tilting ø 100mm shaft ø 7mm		

			
1			
GEV No.	695023	Ref. No.	CM25325953
description	guide for lever L 30mm W 12mm H 15mm		

			
1			
GEV No.	695025	Ref. No.	CM25440110 CM81403011
description	lever for sump L 143mm W 29mm H 37mm shaft intake ø 10mm plastic ICEMATIC		

 <p>1</p>			
GEV No.	696527	Ref. No.	CM25545520 CM25545521
description	paddle ø 145mm shaft intake ø 6mm shaft lengthmm 1		

 <p>1</p>			
GEV No.	695026	Ref. No.	CM25560256
description	pin for lever L 38mm ø 4.5mm metal		

 <p>1</p>			
GEV No.	695024	Ref. No.	CM25110911
description	roller for pan tilting ø 26.7mm shaft intake ø 8.1mm		

 <p>1</p>			
GEV No.	695035	Ref. No.	CM25725433 CM25725439
description	shaft intake for paddle motor L 30mm W 17mm H 60mm shaft intake ø 4mm mounting distance 17mm		

 <p>1</p>			
GEV No.	695004	Ref. No.	CM25030006
description	spindle for ice maker ø 6mm L 165mm SS		

 <p>1</p>			
GEV No.	695005	Ref. No.	CM25030007
description	spindle for ice maker ø 6mm L 206mm		

 <p>1</p>			
GEV No.	695006	Ref. No.	CM25030010 CM25030011
description	spindle for ice maker ø 6mm L 315mm SS		

 <p>1</p>			
GEV No.	695021	Ref. No.	CM25474600
description	torsion spring ø 20.8mm L1 23.2mm L2 37mm wire gauge ø 2.3mm for ice maker		

 <p>1</p>			
GEV No.	695022	Ref. No.	CM25474602
description	torsion spring ø 21.2mm L1 26mm L2 37mm wire gauge ø 2.6mm for ice maker		

gear wheels

 <p>1</p>			
GEV No.	691787	Ref. No.	65115700
description	gear wheel ø 27/101mm shaft intake ø 13mm teeth 15/94		
For models:	MF41, MF46, MF51, MF56, MF56ASR, MF61, MF62, MF66, MF66ASR		

suction system

intake filters

 <p>1</p>			
GEV No.	695416	Ref. No.	Z1AC012
description	intake filter ø 36mm H 25mm		

drive technology

gear wheels

 <p>1</p>			
GEV No.	694780	Ref. No.	651158.00
description	gear wheel ø 135mm shaft ø 25mm W 19mm teeth 83		
For models:	MF41, MF51, MF56, MF56ASR, MF61, MF62, MF66, MF66ASR		

 <p>1</p>			
GEV No.	695586	Ref. No.	65116000
description	gear wheel ø 21.3mm teeth 18-41 D1 ø 58mm shaft ø 8 shaft L 55mm		
For models:	AF10, AF100, AF20, AF200, AF30, AF80, MF20, MF22, MF26, MF30, MF36		



			
1			
GEV No.	697919	Ref. No.	65116100
description	gear wheel ø 62/20mm shaft ø 9.5mm teeth 56/10 for gearbox		
For models:	AF10, AF100, AF20, AF200, AF30, AF80, MF20, MF22, MF26, MF30, MF36		

			
1			
GEV No.	695582	Ref. No.	65115600
description	gear wheel teeth 65 tooth width 14.5mm ED ø 74mm H 72mm shaft ø 12.7mm		
For models:	MF41, MF46, MF51, MF56, MF56ASR, MF61, MF62, MF66, MF66ASR		

			
1			
GEV No.	695880	Ref. No.	64007609
description	flat gasket fibre ED ø 38mm ID ø 27mm thickness 1mm Qty 1 pcs		
For models:	MAR1, MAR10, MAR125, MAR2, MAR20, MAR3, MAR30, MAR5		

			
1			
GEV No.	510215	Ref. No.	4114312S&P 64006000
description	gasket ID ø 50mm thickness 3.5mm fibre hole distance 71mm 3 holes		
For models:	AF10, AF100, AF20, AF200, AF30, AF80, MF20, MF22, MF26, MF30, MF36		

gaskets

flat gaskets

			
1			
GEV No.	695623	Ref. No.	1300070400 13-0704-00 64000000
description	flat gasket ED ø 138mm ID ø 78mm thickness 1mm cork		
For models:	AF730, AN760, AutoSentry-Double-System-RL, Double-System-RL, FM1200, FM1200R, FM1202, FM1202R, FM1202RL, FM1202RL-C, FM1500, FM1500R, FM2400, FM2400R, FM2400RH, FM2402, FM2402R, FM2402RH, FM800, FM800R, FME1200, FME1200R, FME1202RL, FME1204, FME1204R, FME1204RL, FME1500, FME1500R, FME1500RL, FME1504, FME1504R, FME1504RL, FME2400, FME2400R, FME2400RH, FME2404, FME2404R, FME504AS-1A, FME504WS-1A, FME800AE-1A, FME800AE-6A, FME800AE-6B, FME800R, FME800WE-1A, FME800WE-6A, FME800WE-6B, FME804AS-1A, FME804AS-1B, FME804AS-6A, FME804AS-6B...(Other models you can see in the webshop)		

shaft gaskets

			
1			
GEV No.	694191	Ref. No.	1300070902 13070902
description	gasket for evaporator ED ø 48mm ID ø 23mm H 7mm rubber		
For models:	AF730, AN760, HQD550, HQD650, HQD750, MF41, MF46, MF51, MF56, MF56ASR, MF61, MF62, MF66, MF66ASR, MF6C, MF900RC, MH750, PO760		

			
1			
GEV No.	695836	Ref. No.	0300150500 64003000
description	flat gasket ED ø 87mm ID ø 48mm thickness 1mm cork		
For models:	AF10, AF20, AF30		

			
1			
GEV No.	695785	Ref. No.	64001000
description	gasket rubber ED ø 75mm ID ø 22mm thickness 1mm Qty 1 pcs		

			
1			
GEV No.	695784	Ref. No.	64003400
description	gasket rubber ED ø 95mm ID ø 23mm thickness 3.2mm Qty 1 pcs		

			
GEV No.	696651	Ref. No.	02001607 0200160701 02160701 CF02001607 CF02160701
description	shaft bearing for ice maker ED ø 33.5mm ID ø 25.7mm H 3mm for shaft bearing metal		
For models:	MF41, MF46, MF51, MF56, MF56ASR, MF61, MF62, MF66, MF66ASR, MF6C, MF900RC		

			
GEV No.	695589	Ref. No.	02001300.21 64004000
description	shaft sealing ED ø 48mm ID ø 25mm H 22mm suitable for augers		
For models:	AF10, AF100, AF20, AF200, AF30, AF80, MF20, MF22, MF26, MF30, MF36		

			
GEV No.	695936	Ref. No.	0200092901 0200092902 0200092923
description	shaft sealing ED ø 77mm ID ø 44mm H 31mm suitable for augers		

			
GEV No.	695428	Ref. No.	4114228S&P 65040200
description	shaft sealing for auger ED ø 45mm ID ø 30mm		
For models:	MF41, MF46, MF51, MF56, MF56ASR, MF61, MF62, MF66, MF66ASR		

			
GEV No.	695656	Ref. No.	65052500
description	shaft sealing for auger ED ø 65.5mm ID ø 48mm H 83mm		
For models:	MAR1, MAR10, MAR2, MAR20, MAR3, MAR30, MAR5, MF102, MF82, MF83		

			
GEV No.	694187	Ref. No.	00102803
description	shaft sealing for auger ED ø 65.5mm ID ø 48mm H 83mm set		
For models:	MAR1, MAR10, MAR2, MAR20, MAR3, MAR30, MAR5		

			
GEV No.	695774	Ref. No.	64001600
description	shaft sealing for motor ID ø 9mm ED ø 45mm thickness 8mm		

miscellaneous			
			
GEV No.	694111	Ref. No.	64013800
description	gasket for container L 98mm W 98mm thickness 2mm silicone		
For models:	EC045		

			
GEV No.	695961	Ref. No.	0200143700
description	gasket for ice maker L 94mm W 45mm thickness 4mm silicone		

			
GEV No.	695870	Ref. No.	1300068700
description	gasket ID ø 66mm ø 88mm thickness 8mm rubber		

			
GEV No.	695869	Ref. No.	1300067900
description	gasket L 80mm W 38mm thickness 3.8mm silicone		

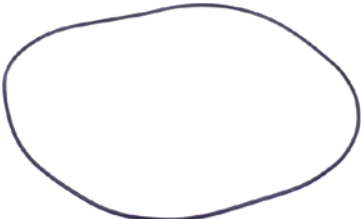



1

GEV No.	697879	Ref. No.	0A026103.01 13000617.38
description	O-ring NBR thickness 2.62mm ID ø 219mm Qty 1 pcs		
For models:	MF41, MF46, MF51, MF56, MF56ASR, MF61, MF62, MF66, MF66ASR		

housing and bezels

fascias



1

GEV No.	692219	Ref. No.	4114711 81453613 CM25725525 CM81453613
description	bezel W 180mm H 46mm D 48mm		
For models:	MV1000, MV300, MV450, MV600, MV800		

housings



1

GEV No.	696646	Ref. No.	25161143 CM25161143 CM25161164/0
description	housing for contol L 245mm W 245mm H 140mm		
For models:	MV1000, MV450, MV600, MV800		

insulation



1

GEV No.	695913	Ref. No.	0200292001
description	insulation		



1

GEV No.	694112	Ref. No.	06055101 66050902 66050903
description	insulation for discharge chute L 190mm W 200mm H 175mm		
For models:	MF41, MF46, MF51, MF56, MF56ASR, MF61, MF62, MF66, MF66ASR		

GEV No.	694112	Ref. No.	06055101 66050902 66050903
description	insulation for discharge chute L 190mm W 200mm H 175mm		
For models:	MF41, MF46, MF51, MF56, MF56ASR, MF61, MF62, MF66, MF66ASR		



1

GEV No.	695941	Ref. No.	06055105
description	insulation for freezing cylinder		
For models:	MF41, MF46, MF66, MF66ASR		

GEV No.	695941	Ref. No.	06055105
description	insulation for freezing cylinder		
For models:	MF41, MF46, MF66, MF66ASR		



1

GEV No.	694109	Ref. No.	06055102 4114525S&P
description	insulation for freezing cylinder H 110mm ø 124mm		



1

GEV No.	695988	Ref. No.	06055103
description	insulation for freezing cylinder H 160mm ø 117mm		
For models:	AF100, AF200, AF80, MF20, MF22, MF26		



1

GEV No.	695989	Ref. No.	06055104 66037600 66037601
description	insulation for ice maker H 230mm ø 117mm		
For models:	AF30, MF30, MF36		

refrigeration pipes



1

GEV No.	694137	Ref. No.	78429401R
description	refrigeration pipe with collector L 1000mm		



1

GEV No.	694130	Ref. No.	78446901
description	refrigeration pipe with collector L 1150mm		
For models:	AF10, AF100		



1

GEV No.	694134	Ref. No.	78444403
description	refrigeration pipe with collector L 1300mm		
For models:	AC055, ICE-TWO		

1

GEV No.	694133	Ref. No.	78420102R
description	refrigeration pipe with collector L 1500mm		



1

GEV No.	696645	Ref. No.	CM25550400
description	flap for ice maker W 473mm L 420mm for evaporator		

flaps



1

GEV No.	696644	Ref. No.	CM81453466
description	flap for ice maker W 365mm L 410mm for evaporator		
For models:	MV12, MV300		
spare parts for	696644		
	GEV No.	347059	Ref. No. —
	magnet L 40mm H 8mm W 13.2mm hole distance 30mm		





1

GEV No.	696392	Ref. No.	CM81453130
description	flap for ice maker W 493mm L 423mm for evaporator		



1

GEV No.	696642	Ref. No.	CM25820126
description	flap for ice maker W 493mm L 423mm for evaporator		
accessories for	696642		
	GEV No.	347059	Ref. No. —
	magnet L 40mm H 8mm W 13.2mm hole distance 30mm		



1

GEV No.	696641	Ref. No.	CM81453692
description	flap for ice maker W 365mm L 420mm for evaporator		
spare parts for	696641		
	GEV No.	347059	Ref. No. —
	magnet L 40mm H 8mm W 13.2mm hole distance 30mm		



1

GEV No.	695698	Ref. No.	CM81453262
description	flap for ice maker W 495mm H 560mm thickness 38mm		
For models:	MV50		



1

GEV No. 696643 **Ref. No.** CM81453651

description flap for ice maker W 525mm L 640mm for evaporator

For models: MV1000

spare parts for 696643



GEV No. 347059 **Ref. No.** —

magnet L 40mm H 8mm W 13.2mm hole distance 30mm



1

GEV No. 696610 **Ref. No.** CM81453131

description sump for ice maker W 500mm H 70mm L 540mm for evaporator

For models: MV25-32, MV50

mechanics for evaporators

screw conveyors



1

GEV No. 695626 **Ref. No.** 72405208

description screw conveyor ø 46mm L 206mm

For models: AF80



1

GEV No. 691788 **Ref. No.** 72405207

description screw conveyor ø 46mm L 260mm

For models: AF10, AF100, AF20, AF200, MF20, MF22, MF26



1

GEV No. 691789 **Ref. No.** 72405206

description screw conveyor ø 46mm L 330mm

For models: AF30, MF30, MF36



1

GEV No. 691790 **Ref. No.** 65072700

description screw conveyor ø 46mm L 350mm



1

GEV No. 695969 **Ref. No.** 02948001
0A02948001

description screw conveyor ø 47mm L 245mm



1

GEV No. 694162 **Ref. No.** 0200061700

description screw conveyor ø 75mm L 340mm



holders



1			
GEV No.	694105	Ref. No.	4114679 76400700
description	bracket for evaporator H 90mm aluminium ID ø 59mm ED ø 140mm		
For models:	MF41, MF46, MF51, MF56, MF56ASR, MF61, MF62, MF66, MF66ASR		



1			
GEV No.	694161	Ref. No.	0A02670801
description	bushing for evaporator complete H 42mm ID ø 30mm ED ø 76mm		

poly-V-belt pulleys



1			
GEV No.	695897	Ref. No.	73459741
description	V-belt pulley single disc ø 106mm shaft intake ø 18mm groove depth 14mm disc width 20mm groove width 4mm overall width 46mm aluminium		



1			
GEV No.	695898	Ref. No.	73459739
description	V-belt pulley single disc ø 133mm shaft intake ø 16mm groove depth 14mm disc width 20mm groove width 4mm overall width 41mm aluminium		
For models:	MAR30		

miscellaneous



1			
GEV No.	694135	Ref. No.	72503501
description	bracket L 230mm W 25mm H 55mm for evaporator		
For models:	MF41, MF46, MF51, MF56, MF56ASR, MF61, MF62, MF66, MF66ASR		



1			
GEV No.	694095	Ref. No.	02991502 0A02991502
description	coupling H 35mm ID ø 19mm ED ø 32mm for auger		



1			
GEV No.	695945	Ref. No.	0200291601 02-2916-01
description	cover H 30mm ID ø 83mm ED ø 128mm for evaporator		
For models:	AutoSentry-Double-System-RL, Double-System-RL, FM1200, FM1200R, FM1202, FM1202R, FM1202RL, FM1202RL-C, FM1500, FM1500R, FM2400, FM2400R, FM2400RH, FM2402, FM2402R, FM2402RH, FM800, FM800R, FME1200, FME1200R, FME1202RL, FME1204, FME1204R, FME1204RL, FME1500, FME1500R, FME1500RL, FME1504, FME1504R, FME1504RL, FME2400, FME2400R, FME2400RH, FME2404, FME2404R, FME504AS-1A, FME504WS-1A, FME800AE-1A, FME800AE-6A, FME800AE-6B, FME800R, FME800WE-1A, FME800WE-6A, FME800WE-6B, FME804AS-1A, FME804AS-1B, FME804AS-6A, FME804AS-6B, FME804R, FME804RL...(Other models you can see in the webshop)		





1			
GEV No.	694136	Ref. No.	72410101
description	lid L 79mm W 52mm H 40mm for microswitch		

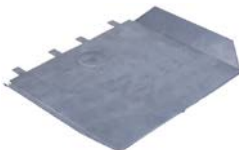

1			
GEV No.	694598	Ref. No.	65051505 CF78447601
description	magnet holder with magnet H 37mm ED ø 42mm plastic		
For models:	AF10, AF20, AF30, MF30, MF41, MF51, MF61		

			
GEV No.	560568	Ref. No.	0200167900 02001681 02167900 02168100
description	plain washer ID ø 25.6mm ED ø 39mm thickness 0.85mm SS Qty 1 pcs		
For models:	AF730, AN760, HQD550, HQD650, HQD750, MF41, MF46, MF51, MF56, MF56ASR, MF61, MF62, MF66, MF66ASR, MF6C, MF900RC, MH750, PO760, PR760		

			
GEV No.	694220	Ref. No.	72148200
description	pressure plate L 265mm W 220mm H 22mm		
For models:	MF82		

			
GEV No.	694192	Ref. No.	1300089802 13089802
description	protector L 66mm W 40mm H 12mm ID ø 10mm for evaporator rubber		
For models:	CME256, CME506, CME656, CME806		

			
GEV No.	694096	Ref. No.	66048900
description	support L 46mm W 13mm H 21mm ID ø 8mm for evaporator		
For models:	AC225, AC226, MC15, MC16, MC45, MC46, MC8		

gear motors

gearboxes

			
GEV No.	695607	Ref. No.	0A03123001 4114213
description	housing for gearbox		
For models:	MF41, MF46, MF51, MF56, MF56ASR, MF61, MF62, MF66, MF66ASR		

motors			
			
GEV No.	500745	Ref. No.	06027303
description			

			
GEV No.	500778	Ref. No.	1200064306
description	motor 180W 110/230V 50Hz 1 phase shaft ø 12.8mm 1425rpm type SKC37MG180FT GENERAL ELECTRIC 0.18kW		

			
GEV No.	500744	Ref. No.	62048001
description	motor 550W 230/400V 50Hz 3 phase shaft ø 19mm flange ø 120mm 1400rpm type BN80A4 ø 150mm H 200mm L 240mm BONFIGLIOLI 0.55kW		
For models:	MF82, MF83		

			
GEV No.	500767	Ref. No.	62038302
description	motor 550W 230/400V 60Hz 3 phase shaft ø 19mm 900rpm type H80B6 ø 155mm H 160mm L 240mm fixing dimensions 100x125mm COEL 0.55kW		



agitators

			
1			
GEV No.	695427	Ref. No.	65072500
description	stirrer ø 86mm H 51mm ID ø 11.6mm		

hoses

formed hoses

straight

miscellaneous

			
1			
GEV No.	695787	Ref. No.	61015904
description	hose straight L 750mm plastic thickness 2mm int. ø 1 14mm int. ø 2 18mm		
For models:	AC225, ICE-ONE, ICE-THREE, ICE-TWO, MF82, MF83		

form L

			
1			
GEV No.	695809	Ref. No.	61016600 61016601
description	formed hose L-shape for ice maker ID ø 11mm ED ø 15mm L 290mm W 130mm		
For models:	ACM55, ACM85, ICE-ONE, ICE-THREE, ICE-TWO		

			
1			
GEV No.	695089	Ref. No.	Z1CE016
description	formed hose L-shape for ice-cube maker ID ø 12.5/22mm ED ø 18.5/27mm L 300mm W 30mm		

			
1			
GEV No.	695092	Ref. No.	Z1CE016
description	formed hose L-shape for ice-cube maker ID ø 13/21mm ED ø 18/27mm L 345mm W 80mm		

			
1			
GEV No.	695091	Ref. No.	610189.01
description	formed hose L-shape for ice-cube maker ID ø 24mm ED ø 27mm L 130mm W 105mm		

			
1			
GEV No.	694131	Ref. No.	61014700
description	formed hose L-shape ID ø 11mm ED ø 15mm L 200mm W 65mm		
For models:	Barline-40, Barline-B40, Barline-BUL40		

			
1			
GEV No.	694132	Ref. No.	61014810
description	formed hose L-shape ID ø 19mm ED ø 23mm L 320mm W 90mm		
For models:	AC045, AC055, AC056, AC085, AC086, AC105, AC106, AC125, AC126, AC175, AC176, AC226, ACM45, ACM55, ACM85, Barline-20, Barline-30, Barline-40, Barline-50, Barline-65, Barline-90, Barline-B40, Barline-B65, Barline-B90, Barline-BUL20, Barline-BUL30, Barline-BUL40, Barline-BUL65, Barline-BUL90, EC045, ICE-ONE, ICE-THREE, ICE-TWO, MAR125, MC1210, MC15, MC16, MC45, MC46, MC8, RB400, SD18		

form S

			
1			
GEV No.	695810	Ref. No.	61016400
description	formed hose S-shape double ID ø 11mm ED ø 15mm L 300mm W 50mm		
For models:	ACM35		

			
1			
GEV No.	695090	Ref. No.	Z1D038
description	formed hose S-shape for ice-cube maker ID ø 16/20mm ED ø 21/25mm L 110mm W 75mm		

			
1			
GEV No.	695094	Ref. No.	3450075
description	formed hose S-shape for ice-cube maker ID ø 16/20mm ED ø 21/26mm L 130mm W 70mm		

			
1			
GEV No.	694093	Ref. No.	4114693 61016700
description	formed hose S-shape for ice-cube maker ID ø 18mm ED ø 22mm L 300mm W 100mm		
For models:	MC15, MC16, MC45, MC46		



1

GEV No.	695093	Ref. No.	Z1ID037
description	formed hose S-shape for ice-cube maker ID ø 20/23mm ED ø 26/29mm L 115mm W 90mm		

form U

group 1



1

GEV No.	695805	Ref. No.	61016300
description	formed hose U-shape ID ø 11mm ED ø 15mm L 105mm W 65mm		
For models:	ACM35		

miscellaneous



1

GEV No.	695813	Ref. No.	61013900
description	formed hose ID ø 11mm ED ø 15mm L 500mm W 110mm		
For models:	ACM25		



1

GEV No.	694104	Ref. No.	4114694 61018800
description	formed hose ID ø 16mm ED ø 20mm L 440mm W 210mm PVC		
For models:	AC225, AC226, MC1210, MC15, MC16, MC45, MC46, MC8		

hose connectors

with thread



1

GEV No.	695051	Ref. No.	Z1AC028
description	hose connector		



1

GEV No.	695045	Ref. No.	3118015S&P 660224.00
description	hose connector 3-way ID ø 15mm ED ø 21mm L 91mm		
For models:	AC045, AC046, AC055, AC056, AC085, AC086, AC105, AC106, AC125, AC125B, AC125C, AC126, AC175, AC176, AC225, AC226, ACM125, ACM175, ACM35, ACM45, ACM55, ACM85, AF10, AF100, AF20, AF200, AF30, AF80, Barline-20, Barline-21, Barline-30, Barline-31, Barline-40, Barline-50, Barline-65, Barline-90, Barline-B40, Barline-B65, Barline-B90, Barline-BUL20, Barline-BUL30, Barline-BUL40, Barline-BUL65, Barline-BUL90, EC045, ICE-ONE, ICE-THREE, ICE-TWO, MAR1, MAR10... (Other models you can see in the webshop)		



1

GEV No.	695048	Ref. No.	3124069S&P Z1ID025
description	hose connector for ice-cube maker		



1

GEV No.	695049	Ref. No.	Z1AD011
description	hose connector for ice-cube maker		



1

GEV No.	695096	Ref. No.	Z1AC030
description	hose connector for ice-cube maker		





1

GEV No.	695053	Ref. No.	66029100
description	hose connector for ice-cube maker straight grommet ø 11.5mm grommet length 16mm WS 27 thread L 15mm plastic T1: 3/4" T2: 5/8" UNF (3/8" SAE)		
For models:	AC045, AC055, AC085, AC105, AC106, AC125, AC125B, AC125C, AC126, AC175, AC176, AC225, AC226, ACM125, ACM175, ACM35, ACM45, ACM55, ACM85, AF20, AF30, Barline-20, Barline-30, Barline-40, Barline-50, EC045, ICE-ONE, ICE-THREE, ICE-TWO, MC45, MC8		





 <p>1</p>			
GEV No.	695875	Ref. No.	66053400
description	hose connector straight plastic D1 ø 12.5mm D2 ø 14mm		
For models:	AC125, AC125B, AC125C, AC175, ACM125, ACM175, ACM45, ACM55, ACM85		

 <p>1</p>			
GEV No.	695791	Ref. No.	0200212101
description	hose connector T plastic ø 19mm left		

 <p>1</p>			
GEV No.	361796	Ref. No.	73317400
description	hose connector thread 3/4" ET grommet ø 13.5mm ID ø 10mm grommet length 20mm WS 27 thread L 22mm		
For models:	AF20, AF200, AF30, AF80, MC1210, MC15, MC16, MC45, MC46, MF20, MF22, MF26, MF30, MF36, MF41, MF46, MF51, MF56, MF61, MF66, MF66ASR		

 <p>1</p>			
GEV No.	695845	Ref. No.	65062300
description	hose connector thread 3/8" hose ø 13.5mm curved 90° plastic		
For models:	MC15, MC45		

 <p>1</p>			
GEV No.	695760	Ref. No.	0002521360 CS0002521360
description	hose connector thread 3/8" hose ø 8mm straight plastic		

 <p>1</p>			
GEV No.	695846	Ref. No.	66021301
description	hose connector thread 7/8" UNF for hose ID 20mm curved 90° plastic		
For models:	AC225, AC226, ACM35, AF20, AF30, MAR125, MC8		

 <p>1</p>			
GEV No.	695095	Ref. No.	Z1AC029
description	hose connector thread M22 hose ø 16mm plastic for ice-cube maker ID ø 16mm ED ø 22mm L 45mm		

without thread			
 <p>1</p>			
GEV No.	695050	Ref. No.	256908060 CM25690806
description	hose connector straight plastic L 70mm ø 21mm		
For models:	CD40, GP20, GP20W, GP30, GP40, GP40W, GP50, GP50W, GP75, GP75W, GP90, GP90W, MV12, MV18-21, MV25-32, MV50		

miscellaneous			
 <p>1</p>			
GEV No.	694177	Ref. No.	0200397801
description	bush hose ø 14mm		

water dispersions			
 <p>1</p>			
GEV No.	694170	Ref. No.	61019402
description	hose for T-piece for ice maker L 137mm		

 <p>1</p>			
GEV No.	694171	Ref. No.	61019401
description	hose T-piece for ice maker L 580mm		

 <p>1</p>			
GEV No.	694168	Ref. No.	61019404
description	hose T-piece L 420mm		



1

GEV No.	694176	Ref. No.	61017601
description	hose T-piece L 470mm		
For models:	AC125, AC125B, AC125C, AC175, ACM125, ACM175, Barline-65, Barline-90, Barline-B65, Barline-B90, Barline-BUL65, Barline-BUL90		

miscellaneous



1

GEV No.	520447	Ref. No.	73320400
description	double nipple thread 3/8" - 3/4" L1 24mm L2 12mm		
For models:	AC125, AC125B, AC125C, AC126, AC175, AC176, AC225, AC226, ACM125, ACM175, ACM55, ACM85, AF20, AF200, AF30, AF80, MC1210, MC15, MC16, MC45, MC46, MC8, MF20, MF22, MF26, MF30, MF36, MF41, MF46, MF51, MF56, MF61, MF66		



1

GEV No.	530028	Ref. No.	61020900
description	formed hose for ice-cube maker ED ø 12mm L 60mm		



1

GEV No.	530046	Ref. No.	61017300
description	formed hose for ice-cube maker L 23mm		
For models:	AC045, AC055, AC085, AC125, AC125B, AC125C, AC175, ACM125, ACM175, ACM45, ACM55, ACM85, EC045, MC1210		



1

GEV No.	530050	Ref. No.	28190001
description	hose ID ø 10mm ED ø 16mm		
For models:	AC045, AC046, AC055, AC056, AC085, AC086, AC105, AC106, AC125, AC125B, AC125C, AC126, AC175, AC176, ACM125, ACM175, ACM35, ACM45, ACM55, ACM85, Barline-20, Barline-21, Barline-30, Barline-31, Barline-40, Barline-50, Barline-65, Barline-90, Barline-B40, Barline-B65, Barline-B90, Barline-BUL20, Barline-BUL30, Barline-BUL40, Barline-BUL65, Barline-BUL90, EC045, ICE-ONE, ICE-THREE, ICE-TWO, MC1210, SD18		



1

GEV No.	695999	Ref. No.	03091801 0A03091801
description	PVC hose ID ø 13mm ED ø 19mm L 11mm thickness 3mm transparent		

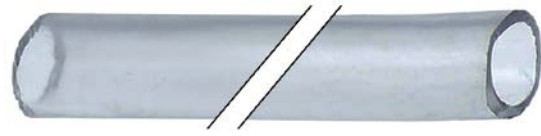

1

GEV No.	520448	Ref. No.	00028013 CS00028013
description	PVC hose ID ø 18mm ED ø 24mm L 800mm thickness 3mm transparent		



1

GEV No.	695896	Ref. No.	74300000
description	PVC hose ID ø 18mm ED ø 24mm L 88mm thickness 3mm		



1

GEV No.	520416	Ref. No.	CS0002801318
description	PVC hose ID ø 18mm ED ø 24mm thickness 3mm Qty supplied by meter		
For models:	SW12		

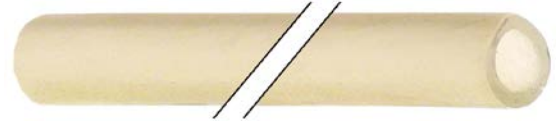

1

GEV No.	530769	Ref. No.	CM25790880
description	silicone hose for ice-cube maker ID ø 14mm ED ø 20mm L 650mm		
For models:	MV25, MV25-32		



floats

container lids



1

GEV No.	695038	Ref. No.	4114148S&P 660363.00
description	lid L 150mm W 102mm for float container		
For models:	AF10, AF100, AF20, AF200, AF30, AF80, MAR1, MAR10, MAR5, MF20, MF22, MF26, MF30, MF36, MF41, MF46, MF51, MF56, MF56ASR, MF61, MF62, MF66, MF66ASR		



1

GEV No.	694110	Ref. No.	66071100
description	lid L 98mm W 98mm thickness 3mm for float container		

float containers



1

GEV No.	694163	Ref. No.	03292920 0A03292920
description	float container for ice maker L 145mm W 95mm H 130mm complete plastic		



1

GEV No.	695037	Ref. No.	793126.01 793126.03
description	float container for ice maker plastic		
For models:	AF10, AF100, AF20, AF200, AF30, AF80, MF20, MF22, MF26, MF30, MF36, MF41, MF46, MF51, MF56, MF56ASR, MF61, MF62, MF66, MF66ASR		



1

GEV No.	695071	Ref. No.	0200221701
description	float container for ice-cube maker L 150mm W 65mm H 100mm plastic		

miscellaneous



1

GEV No.	695998	Ref. No.	0200338301 0200338321
description	bar for float switch ø 15mm L 180mm aperture 3.5x30mm plastic		



1

GEV No.	695649	Ref. No.	0200338302
description	bar for float switch ø 15mm L 180mm aperture 3.5x51mm plastic		



1

GEV No.	695997	Ref. No.	78315300R
description	nozzle for flake ice maker L 168mm ø 8mm for float		
For models:	AF100, AF200, MF20, MF22, MF26, MF30, MF36, MF41, MF46, MF51, MF56, MF56ASR, MF61, MF62, MF66, MF66ASR		



1

GEV No.	695995	Ref. No.	0200326603
description	pressure pin for float L 14mm with gasket stainless steel		

miscellaneous



1

GEV No.	695929	Ref. No.	02154400 0A02154400
description	bracket		



GEV No.	691665	Ref. No.	CM25726473
description	bracket for evaporator flap		



GEV No.	695446	Ref. No.	72307300
description	bracket for nozzle L 47mm W 16.5mm		
For models:	ACM55, ACM85		



GEV No.	695956	Ref. No.	4114732 81453139 CM81453139
description	bracket for pump L 130mm W 85mm H 135mm		
For models:	MV12, MV18-21, MV25-32		



GEV No.	695927	Ref. No.	33500026 CM33500026
description	bracket L 12mm ID ø 5mm ED ø 7mm		
For models:	MV12, MV18, MV18-21, MV25, MV25-32		



GEV No.	695762	Ref. No.	CS0002541928
description	break tank H 200mm ID ø 160mm		



GEV No.	696620	Ref. No.	25110913/0
description	bush for ice maker L 13mm W 8mm H 9mm ID ø 4mm ED ø 8mm plastic		
For models:	GP40, GP40W, GP75, GP75W, GP90, GP90W		



GEV No.	695765	Ref. No.	0200299801
description	bush H 13mm ID ø 22mm ED ø 28.5mm		



GEV No.	695942	Ref. No.	02768702 0A02768702
description	bush L 41mm ID ø 16mm ED ø 20mm left-hand thread		



GEV No.	695946	Ref. No.	0A02768701
description	bush with thread H 27mm ID ø 16mm WS 29 left		



GEV No.	695588	Ref. No.	06052700 4114227S&P
description	bushing complete H 31.5mm ID ø 30mm ED ø 89mm mounting pos. lower		
For models:	MF41, MF46, MF51, MF56, MF56ASR, MF61, MF62, MF66, MF66ASR		



GEV No.	695959	Ref. No.	00770100 0A00770100
description	cap for ice maker H 14mm ID ø 26mm ED ø 42mm		





GEV No.	695876	Ref. No.	66042700
description	cap for ice maker H 15mm ID ø 71mm ED ø 76mm		





GEV No.	695877	Ref. No.	66049201
description	cap for ice maker H 17mm ID ø 89mm ED ø 92mm		
For models:	MF102, MF82, MF83		





 <p>1</p>			
GEV No.	695733	Ref. No.	66050700
description	cap for ice maker H 18mm ID ø 56mm ED ø 61mm		
For models:	MF41, MF46, MF51, MF56, MF56ASR, MF61, MF62, MF66, MF66ASR		

 <p>1</p>			
GEV No.	694224	Ref. No.	66038600
description	clamp for probe L 20mm W 9mm H 14mm ID ø 7mm		
For models:	AC056, AC086, ACM25, ACM55, Barline-21, Barline-31, ICE-ONE, ICE-THREE, ICE-TWO		

 <p>1</p>			
GEV No.	695940	Ref. No.	0300152601
description	clamp L 12mm W 6mm H 4mm		

 <p>1</p>			
GEV No.	691799	Ref. No.	66030200
description	connection plate for ice maker L 220mm W 55mm		

 <p>1</p>			
GEV No.	695630	Ref. No.	06035900
description	coupling set ø 37mm		
For models:	AF10, AF100, AF20, AF200, AF30, AF80, MF20, MF22, MF26, MF30, MF36		

 <p>1</p>			
GEV No.	695855	Ref. No.	66033000
description	cover for ice maker W 49mm H 44mm thickness 2mm		
For models:	ACM25		

 <p>1</p>			
GEV No.	695436	Ref. No.	66072000
description	cover for light barrier mounting pos. left		
For models:	AC045, AC055, AC085, AC105, AC106, AC125, AC126, AC175, AC176, AC225, AC226, EC045, MF22, MF26, MF30, MF36, MF41, MF46, MF51, MF56, MF56ASR, MF62, MF66, MF66ASR		

 <p>1</p>			
GEV No.	695437	Ref. No.	66072001
description	cover for light barrier mounting pos. right		
For models:	AC045, AC055, AC085, AC105, AC106, AC125, AC126, AC175, AC176, AC225, AC226, EC045, MF22, MF26, MF30, MF36, MF41, MF46, MF51, MF56, MF56ASR, MF62, MF66, MF66ASR		

 <p>1</p>			
GEV No.	695841	Ref. No.	66034300
description	deflector for ice maker W 128mm H 120mm plastic		
For models:	ACM25		

 <p>1</p>			
GEV No.	695838	Ref. No.	64007615
description	disc for ice maker H 5mm ID ø 17mm ED ø 28mm PTFE		
For models:	MC15, MC45		

 <p>1</p>			
GEV No.	695864	Ref. No.	40003100
description	disc for ice-cube maker ID ø 16mm ED ø 31mm fibre thickness 1mm		
For models:	AC045, AC055, AC085, AC105, AC106, AC125, AC125B, AC125C, AC126, AC175, AC176, AC225, AC226, ACM125, ACM175, ACM35, ACM45, ACM55, ACM85, AF10, AF100, AF20, AF200, AF30, AF80, Barline-20, Barline-30, Barline-40, Barline-50, EC045, ICE-ONE, ICE-THREE, ICE-TWO, MAR1, MAR10, MAR125, MAR2, MAR20, MAR3, MAR30, MAR5, MC8, MF20, MF22, MF26, MF30, MF36, MF41, MF46, MF51... (Other models you can see in the webshop)		

 <p>1</p>			
GEV No.	695861	Ref. No.	40005200
description	disc for ice-cube maker ID ø 27mm ED ø 37mm fibre thickness 1mm		
For models:	AC125, AC125B, AC125C, AC126, AC175, AC176, ACM125, ACM175, AF20, AF30, AF80, Barline-65, Barline-90, Barline-B65, Barline-B90, Barline-BUL65, Barline-BUL90, MF102, MF62, MF82, MF83		

 <p>1</p>			
GEV No.	695934	Ref. No.	00769900 0A00769900
description	disc ID ø 11.5mm ED ø 24mm brass		



1

GEV No.	691797	Ref. No.	66047700
description	discharge chute for ice maker		
For models:	MC15, MC16		



1

GEV No.	695640	Ref. No.	66067601 66067603
description	discharge chute for ice maker		
For models:	AF100, AF200, MF20, MF22, MF26, MF30, MF36		



1

GEV No.	694103	Ref. No.	0200365701
description	drip rail for ice maker L 420mm W 55mm H 90mm		



1

GEV No.	695926	Ref. No.	0002781301 CS0002781301
description	end cap H 4mm ID ø 18mm ED ø 22mm chrome-plated		



1

GEV No.	696607	Ref. No.	4114266 66048300
description	flange icemaker H 20mm ED ø 60mm plastic		
For models:	AC225, AC226, MC1210, MC15, MC16, MC45, MC46, MC8		



1

GEV No.	695777	Ref. No.	66029702
description	frame for ejector L 172mm W 89mm H 195mm rubber		



1

GEV No.	695637	Ref. No.	0200353801
description	gutter for ice-cube maker L 420mm W 20mm plastic		



1

GEV No.	695583	Ref. No.	0200286801
description	gutter for ice-cube maker L 470mm W 45mm plastic		



1

GEV No.	520450	Ref. No.	73316600
description	hose connector L 28mm ID ø 7mm ED ø 11.4mm thread 3/8" UNF		



1

GEV No.	695964	Ref. No.	73310000
description	hose tail L 27mm ID ø 8mm ED ø 11.5mm		





1

GEV No.	695754	Ref. No.	0A03237920
description	housing for gearbox L 305mm W 180mm H 70mm		





			
1			
GEV No.	695660	Ref. No.	CM25300000
description	inlet spout for ice maker ICEMATIC		

			
1			
GEV No.	695417	Ref. No.	Z11D043
description	insulation for pump		

			
1			
GEV No.	695744	Ref. No.	06055100 4114366S&P 65088700 66013200 66013300
description	insulation L 150mm W 100mm H 140mm ID ø 55mm		
For models:	AF10, AF100, AF20, AF200, AF30, AF80, MF20, MF22, MF26, MF30, MF36		

			
1			
GEV No.	695650	Ref. No.	0200252001 0200252002
description	lid L 120mm W 83mm H 30mm plastic		

			
1			
GEV No.	695638	Ref. No.	0200340501
description	manifold 4-way for ice maker		

			
1			
GEV No.	695639	Ref. No.	02970301 0A02970301
description	manifold 4-way for ice maker		

			
1			
GEV No.	695834	Ref. No.	1300060600
description	membrane H 20mm ID ø 50mm ED ø 64mm		

			
1			
GEV No.	695757	Ref. No.	0200236902
description	mixer coupling for ice maker L 105mm W 59mm H 31.5mm		

			
1			
GEV No.	695954	Ref. No.	0300139401
description	nut for ice maker H 6mm thread 7/8" WS 32		

			
1			
GEV No.	695046	Ref. No.	4114180S&P 660535.00
description	nut H 5mm thread M24x1.5 plastic		
For models:	AC045, AC046, AC055, AC056, AC085, AC086, AC105, AC106, AC125, AC125B, AC125C, AC126, AC175, AC176, AC225, AC226, ACM125, ACM175, ACM35, ACM45, ACM55, ACM85, AF10, AF100, AF20, AF200, AF30, AF80, Barline-20, Barline-21, Barline-30, Barline-31, Barline-40, Barline-50, Barline-65, Barline-90, Barline-B40, Barline-B65, Barline-B90, Barline-BUL20, Barline-BUL30, Barline-BUL40, Barline-BUL65, Barline-BUL90, EC045, ICE-ONE, ICE-THREE, ICE-TWO, MAR125, MC1210...(Other models you can see in the webshop)		

			
1			
GEV No.	695832	Ref. No.	61000300
description	olive for ice maker L 6.5mm ID ø 6.2mm ED ø 8.5mm		

			
1			
GEV No.	691807	Ref. No.	CM25730503
description	outflow plug for water container L 12mm ø 12mm		
For models:	CD40, MV1000, MV12, MV18-21, MV25-32, MV300, MV450, MV456, MV50, MV600, MV800		

			
1			
GEV No.	694173	Ref. No.	0200387801
description	plate L 345mm W 360mm H 30mm		

			
1			
GEV No.	696614	Ref. No.	66074100
description	plug for ice maker H 40mm ID ø 83mm ED ø 88mm		

			
1			
GEV No.	695847	Ref. No.	1300084001
description	plug mounting ø 18mm ø 22mm H 16mm rubber		

			
1			
GEV No.	695857	Ref. No.	66009100
description	plug mounting ø 4mm ø 7mm H 13mm plastic Qty 1 pcs		
For models:	MAR10, MAR20, MAR30, MAR5		

			
1			
GEV No.	695848	Ref. No.	66034100
description	plug rectangular mounting measurements 14x16mm H 8mm ID ø 10mm rubber		
For models:	ACM25		

			
1			
GEV No.	695764	Ref. No.	72421506
description	probe L 100mm ED ø 4mm thread M3		
For models:	AF10, AF100, AF20, AF200, AF30, AF80, MF20, MF22, MF26, MF30, MF36, MF41, MF46, MF51, MF56, MF56ASR, MF61, MF62, MF66, MF66ASR		

			
1			
GEV No.	550780	Ref. No.	03226201 0A03226201
description	protective pipe for capillaries for ice maker		

			
1			
GEV No.	695770	Ref. No.	78445201R
description	refrigeration pipe with collector		
For models:	AC225		

			
1			
GEV No.	694127	Ref. No.	78425202R
description	refrigeration pipe with collector L 920mm		

			
1			
GEV No.	695587	Ref. No.	00102808
description	repair kit for ice maker		
For models:	MF41, MF46, MF51, MF56, MF56ASR, MF62, MF66, MF66ASR		
spare parts for	695587		
	GEV No.	695588	Ref. No. 06052700 4114227S&P
	description	bushing complete H 31.5mm ID ø 30mm ED ø 89mm mounting pos. lower	

			
1			
GEV No.	695856	Ref. No.	65041300
description	ring ID ø 26mm H 4.7mm D1 ø 29mm D2 ø 34mm for spring		
For models:	AF10, AF20, AF30		





			
1			
GEV No.	695627	Ref. No.	03476801 0A03476801
description	rotor for dispenser L 285mm W 205mm		

			
1			
GEV No.	695830	Ref. No.	64009500
description	rubber protection for ball bearing H 11.5mm ID ø 31.5mm ED ø 36mm		
For models:	AF10, AF100, AF20, AF200, AF30, AF80, MF20, MF22, MF26, MF30, MF36		

			
1			
GEV No.	695831	Ref. No.	64009501
description	rubber protection for ball bearing H 14mm ID ø 39.5mm ED ø 44.5mm		
For models:	MF41, MF46, MF51, MF56, MF56ASR, MF61, MF62, MF66, MF66ASR		

			
1			
GEV No.	695753	Ref. No.	66033800
description	rubber sleeve L 25mm W 18mm H 18mm ID ø 7mm ED ø 18mm		
For models:	ACM25		

			
1			
GEV No.	695766	Ref. No.	0200212201
description	screw thread 7/8" plastic WS 29 left thread L 16mm		

			
1			
GEV No.	695779	Ref. No.	0200303301
description	spindle for dispenser L 47mm ED ø 12.2mm WS 19 IT M6		

			
1			
GEV No.	691800	Ref. No.	0200394401 1103247S&P
description	spout for ice maker H 72mm ID ø 74mm ED ø 80mm		

			
1			
GEV No.	695584	Ref. No.	25474608 CM25474608
description	spring clip L 28mm W 10mm hole ø 4.5mm tube ø 31mm		
For models:	MV1000, MV12, MV18, MV18-21, MV25, MV25-32, MV300, MV450, MV50, MV600, MV800		

			
1			
GEV No.	695851	Ref. No.	1300021700
description	suppressor for ice maker rubber ø 100mm thickness 17.5mm		

			
1			
GEV No.	695585	Ref. No.	72418002
description	threaded rod thread M4 L1 130mm L2 22mm		
For models:	MF20, MF22, MF26, MF30, MF36, MF41, MF46, MF51, MF56, MF56ASR, MF61, MF62, MF66, MF66ASR		

			
1			
GEV No.	694438	Ref. No.	4114737 66047702
description	tray L 205mm W 100mm H 19mm		
For models:	MC1210, MC15, MC16, MC45, MC46		

			
1			
GEV No.	695730	Ref. No.	66033700
description	water level tube for ice maker L 20mm W 19mm H 130mm		

valves

intake valves

			
1			
GEV No.	695652	Ref. No.	81453201 CM81453201
description	intake valve complete thread 3/4" L 350mm hose ø 6mm		

			
1			
GEV No.	695749	Ref. No.	0200326621 0200337121
description	intake valve for ice maker thread 14 L 70mm plastic W 50mm thickness 20mm		

			
1			
GEV No.	696608	Ref. No.	1124262
description	intake valve icemaker thread 14 plastic hose ø 35mm W 76mm		

			
1			
GEV No.	695685	Ref. No.	0200221702 CM19864010
description	intake valve thread M11 L 130mm ø 37mm plastic		
For models:	MV18-21, MV25-32, MV50		

			
1			
GEV No.	694548	Ref. No.	02003612 01
description	intake valve with float		

valves

			
1			
GEV No.	694123	Ref. No.	65081100
description	backflow preventer L 72mm ø 18mm plastic connection 12mm		
For models:	EC045		

valve inserts

			
1			
GEV No.	695771	Ref. No.	65010900
description	valve bush thread 7/16" L 26mm ø 9.5mm brass WS 11		
For models:	AC045, AC046, AC055, AC056, AC085, AC086, AC105, AC106, AC125, AC125B, AC125C, AC126, AC175, AC176, AC225, AC226, ACM125, ACM175, ACM35, ACM45, ACM55, ACM85, AF10, AF100, AF20, AF200, AF30, AF80, Barline-20, Barline-21, Barline-30, Barline-31, Barline-40, Barline-50, Barline-65, Barline-90, Barline-B40, Barline-B65, Barline-B90, Barline-BUL20, Barline-BUL30, Barline-BUL40, Barline-BUL65, Barline-BUL90, EC045, ICE-ONE, ICE-THREE, ICE-TWO, MAR1, MAR10... (Other models you can see in the webshop)		

for ice containers

containers

			
1			
GEV No.	694204	Ref. No.	25135163 CM25135163
description	ice container L 350mm W 320mm H 260mm		
For models:	CD40		



1

GEV No.	694166	Ref. No.	78207019R
description	ice container L 455mm W 480mm H 470mm		



1

GEV No.	694157	Ref. No.	66068100
description	ice container L 680mm W 580mm H 840mm		

evaporation trays



1

GEV No.	694153	Ref. No.	CM25160509
description	evaporation tray for ice container L 760mm W 290mm H 32mm		
For models:	B390		

doors



1

GEV No.	696582	Ref. No.	CM81460355
description	door for model B390/B393 L 767mm W 28mm H 310mm		
For models:	B390, B393		

accessories for	696582			
	GEV No.	508418	Ref. No.	19350201
	foam rubber gasket W 15mm thickness 8mm self-adhesive Qty 1m			

for ice dispensers

transmission technology and ball bearings



1

GEV No.	694174	Ref. No.	0200375420
description	drive shaft L 180mm with bearing		

housing and bezels



1

GEV No.	695996	Ref. No.	66069900
description	front panel for ice dispenser L 116mm W 34mm H 112mm		



1

GEV No.	695994	Ref. No.	66070000
description	front panel for ice dispenser L 170mm W 32mm H 125mm		



1

GEV No.	694159	Ref. No.	06060001
description	housing for ice dispenser L 385mm W 190mm H 815mm with membrane keypad		



1

GEV No.	694172	Ref. No.	81409176 CM81409176
description	housing for ice dispenser L 350mm W 160mm H 430mm set		
For models:	CD40		



1

GEV No.	695642	Ref. No.	06060002
description	housing set for ice dispenser L 38.5mm W 210mm H 820mm 2-piece		



funnels



1

GEV No.	695986	Ref. No.	0200327001
description	funnel for ice ø 79mm L 115mm plastic for ice dispenser		



1

GEV No.	694094	Ref. No.	4114497 66067500
description	funnel for ice water ø 85.5mm L 84mm plastic for ice dispenser		



1

GEV No.	695985	Ref. No.	0200336501
description	funnel for water ø 82mm L 136mm plastic for ice dispenser		

water taps

water taps with pedal



1

GEV No.	695786	Ref. No.	0002781191 CS0002781191
description	cable control ø 1.6mm L 94mm for water dispenser		
For models:	SCW14B		

for espresso machines

level glasses

level glasses

balls



1

GEV No.	695872	Ref. No.	66045300
description	ball for float ø 10mm plastic		

for cup coffee machines

miscellaneous



1

GEV No.	695832	Ref. No.	61000300
description	olive for ice maker L 6.5mm ID ø 6.2mm ED ø 8.5mm		

for drink dispensers

drain systems

drain valves



1

GEV No.	695990	Ref. No.	0000090096 CS0000090096 CS0002781307
description	drain fitting L 56mm for drink dispenser funnel connection 19.5mm		
For models:	SW12		

drip grids



1

GEV No.	695991	Ref. No.	6507650 65076500
description	drip grid for drink dispenser L 253mm W 167mm H 45mm		

knobs

producer-specific knobs

SCOTSMAN



1			
GEV No.	111139	Ref. No.	1100042722
description	knob switch zero mark ø 26mm shaft ø 6x4.6mm shaft flat upper black		

handles and hand wheels

bracket handles



1			
GEV No.	700989	Ref. No.	CM28190005
description	pull handle L 325mm H 16mm mounting distance 254mm W 36.5mm chrome-plated		
accessories for	700989		
	GEV No.	Ref. No.	—
	692526		
	cover for handle plastic		

fasteners

locking screws



1			
GEV No.	697741	Ref. No.	0300072710
description	locking screw thread M6 handle ø 14.5mm stainless steel L 13mm		

locks

edgemount latches

handle latches

miscellaneous



1			
GEV No.	700829	Ref. No.	0200265801
description	door handle L 150mm mounting distance 117/133mm with bore for padlock type 2830		

hinges

piano hinges

producer-specific

CASTEL

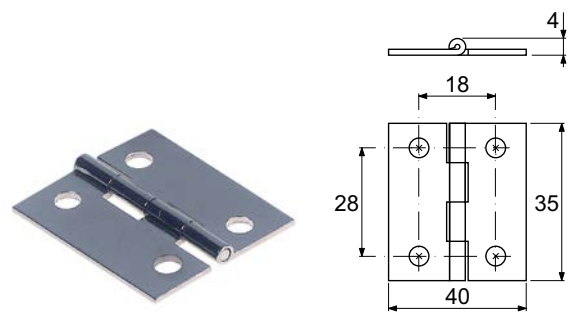

1			
GEV No.	701030	Ref. No.	CM 19120045
description	hinge controllable L 43mm W 37mm hole ø 4mm for ice container mounting distance 26/32mm plastic		
For models:	B193, B390, B393		

1			
GEV No.	691804	Ref. No.	CM19120050
description	hinge L 40mm W 35mm H 4mm mounting distance 28mm hole ø 5mm thickness 1.3mm brass ICEMATIC		



door bearing



1

GEV No.	695781	Ref. No.	0A03239601
description	hinge bearing L 40mm W 38mm H 40mm mounting pos. left thickness 3.5mm		
For models:	BH550		



1

GEV No.	695776	Ref. No.	0A03239602
description	hinge bearing L 40mm W 38mm H 40mm mounting pos. right thickness 3.5mm		
For models:	BH550		



1

GEV No.	690583	Ref. No.	CM19120054
description	hinge bearing without bolt		

fittings for catering equipment

drain taps

accessories



1

GEV No.	505517	Ref. No.	64004116
description	O-ring EPDM thickness 5.34mm ID ø 53.34mm Qty 1 pcs		
For models:	MF102, MF82, MF83		

filters

air filters



1

GEV No.	694183	Ref. No.	0200348501
description	air filter L 500mm W 500mm H 20mm		



1

GEV No.	694158	Ref. No.	0200297601
description	air filter L 640mm W 100mm H 410mm for condenser		

device filters



1

GEV No.	970877	Ref. No.	0200421201 3126318
description	air filter L 335mm W 238mm H 3mm plastic for ice maker		
For models:	MV456		

equipment feet and end caps

equipment feet

with screw mounting

components



1

GEV No.	701002	Ref. No.	66025700 66025800 66025801 66051600
description	equipment foot tube ø 34mm H 48mm plastic thread 1 1/4" UMF		



1

GEV No.	701093	Ref. No.	25570880 CM25570880
description	equipment foot tube ø 47mm H 68mm plastic thread 1¼" ET		
For models:	B190, B390		



1

GEV No.	701093	Ref. No.	25570880 CM25570880
description	equipment foot tube ø 47mm H 68mm plastic thread 1¼" ET		
For models:	B190, B390		



1

GEV No.	700103	Ref. No.	19490020 81502140 CM19490020 CM81502140
description	equipment foot tube ø 56mm plate size mm hole distance mm H 130mm SS size 2" Qty 1 pcs		
For models:	B193, B390, B393		



1

GEV No.	700103	Ref. No.	19490020 81502140 CM19490020 CM81502140
description	equipment foot tube ø 56mm plate size mm hole distance mm H 130mm SS size 2" Qty 1 pcs		
For models:	B193, B390, B393		

with fixing plate
components



1

GEV No.	701002	Ref. No.	66025700 66025800 66025801 66051600
description	equipment foot tube ø 34mm H 48mm plastic thread 1 1/4" UMF		



1

GEV No.	695917	Ref. No.	25460020 CM25460020
description	equipment foot tube ø 63mm plate size mm hole distance mm H 100mm plastic size 2 1/3" Qty 1 pcs		
For models:	B190, B390		

miscellaneous



1

GEV No.	701000	Ref. No.	65067000
description	equipment feet kit H 116-126mm plastic Qty 4 pcs thread 1" ET		
For models:	AC055, AC085, AC086, AC105, AC106, AC125, AC126, AC175, AC176, AC225, ACM125, ACM175, AF10, AF100, AF20, AF200, AF30, AF80, ICE-THREE, ICE-TWO		



screw-in feet

			
1			
GEV No.	695353	Ref. No.	65038201
description	equipment foot thread L 17mm ø 18mm H 40mm WS 24 Qty 1 pcs		
For models:	AC045, AC046, AC056, ACM45, Barline-20, Barline-21, Barline-30, Barline-31, Barline-BUL20, Barline-BUL30, ICE-ONE, SD18		

end caps and plugs

housing plugs

			
1			
GEV No.	695857	Ref. No.	66009100
description	plug mounting ø 4mm ø 7mm H 13mm plastic Qty 1 pcs		
For models:	MAR10, MAR20, MAR30, MARS		

for circular pipes

			
1			
GEV No.	695847	Ref. No.	1300084001
description	plug mounting ø 18mm ø 22mm H 16mm rubber		

for square pipes

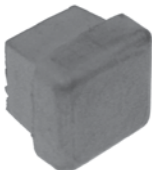
			
1			
GEV No.	695068	Ref. No.	4114231 66055700
description	end cap for ice maker insertion size 13x13mm		
For models:	AC056, AC086, AC105, AC106, AC126, AC176, Barline-50, Barline-BUL30, Barline-BUL40, Barline-BUL65, Barline-BUL90, SD18		

			
1			
GEV No.	695848	Ref. No.	66034100
description	plug rectangular mounting measurements 14x16mm H 8mm ID ø 10mm rubber		
For models:	ACM25		

miscellaneous

accessories

rollers

			
1			
GEV No.	700821	Ref. No.	PROM69500811
description	roller without housing ø 150mm wheel body plastic wheel width 40mm shaft intake ø 16.5mm		

bumper angles

			
1			
GEV No.	695950	Ref. No.	25550357 CM25550357
description	bumper angle outer length 82mm inner length 63mm W 19mm H 19mm mounting distance 28mm hole distance 20mm hole ø 4mm rubber grey		
For models:	RB400		

gaskets

refrigeration gaskets

plug-in gaskets

profile 9151

We offer custom-made gaskets for this profile

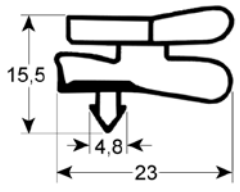
			
1			
GEV No.	900368	Ref. No.	CM28175017
description	refrigeration gasket profile 9151 W 715mm L 1580mm plug size L1 1570mm W1 705mm external size		

profile 9010

We offer custom-made gaskets for this profile

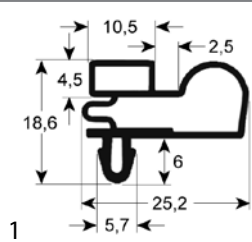

GEV No.	902251	Ref. No.	N/A
description	refrigeration gasket profile 9010 Wmm L 2500mm		

miscellaneous



GEV No.	900891	Ref. No.	501218 F501218
description	refrigeration gasket W 360mm L 770mm plug size		

O-rings

EPDM

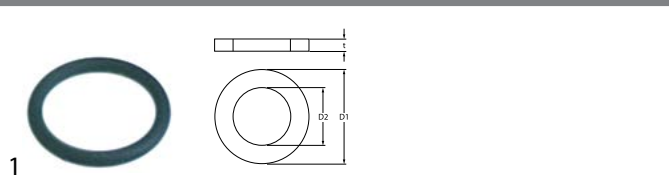

GEV No.	361304	Ref. No.	64011000
description	O-ring EPDM ID ϕ 11.11mm thickness 1.78mm Qty 1 pcs for type DIB3E/DIB5E		
For models:	AC125B, AC125C, AC175, AC225, ACM125, ACM35, ACM45, ACM55, ACM85		

GEV No.	540682	Ref. No.	1300061748
description	O-ring EPDM thickness 1.78mm ID ϕ 18.77mm Qty 1 pcs		

GEV No.	528485	Ref. No.	64010000
description	O-ring EPDM thickness 1.78mm ID ϕ 6.07mm Qty 1 pcs		
For models:	ACM35, AF10, AF100, AF20, AF200, AF30, AF80, MAR1, MAR10, MAR125, MAR2, MAR20, MAR3, MAR30, MAR5, MF102, MF20, MF22, MF26, MF30, MF36, MF41, MF46, MF51, MF56, MF56ASR, MF61, MF62, MF66, MF66ASR, MF82, MF83		

GEV No.	532030	Ref. No.	64004127
description	O-ring EPDM thickness 1.78mm ID ϕ 60.05mm Qty 10 pcs		

GEV No.	513275	Ref. No.	13000617
description	O-ring EPDM thickness 1.78mm ID ϕ 82.27mm Qty 1 pcs		

GEV No.	504574	Ref. No.	0T514561005
description	O-ring EPDM thickness 1.78mm ID ϕ 9.25mm Qty 1 pcs		

GEV No.	528110	Ref. No.	2101016S&P 64008000
description	O-ring EPDM thickness 2.62mm ID ϕ 12.37mm Qty 1 pcs		



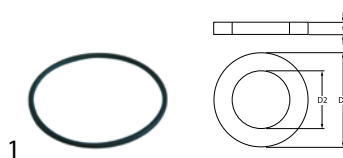

			
GEV No.	504618	Ref. No.	1300061730
description	O-ring EPDM thickness 2.62mm ID ø 15.54mm Qty 1 pcs		

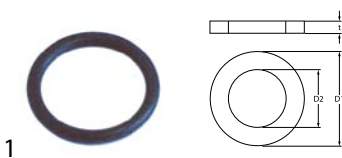
			
GEV No.	509002	Ref. No.	1300061732 1300061752 13-0617-52
description	O-ring EPDM thickness 2.62mm ID ø 82.22mm Qty 1 pcs		

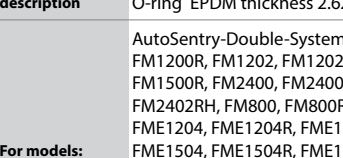
			
GEV No.	507309	Ref. No.	64008100 940081.00
description	O-ring EPDM thickness 2.62mm ID ø 17.13mm Qty 1 pcs		

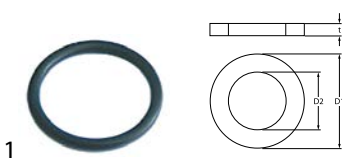
			
For models:	AutoSentry-Double-System-RL, Double-System-RL, FM1200, FM1200R, FM1202, FM1202R, FM1202RL, FM1202RL-C, FM1500, FM1500R, FM2400, FM2400R, FM2400RH, FM2402, FM2402R, FM2402RH, FM800, FM800R, FME1200, FME1200R, FME1202RL, FME1204, FME1204R, FME1204RL, FME1500, FME1500R, FME1500RL, FME1504, FME1504R, FME1504RL, FME2400, FME2400R, FME2400RH, FME2404, FME2404R, FME504AS-1A, FME504WS-1A, FME800AE-1A, FME800AE-6A, FME800AE-6B, FME800R, FME800WE-1A, FME800WE-6A, FME800WE-6B, FME804AS-1A, FME804AS-1B, FME804AS-6A, FME804AS-6B, FME804R, FME804RL...(Other models you can see in the webshop)		

			
GEV No.	512071	Ref. No.	64004125
description	O-ring EPDM thickness 2.62mm ID ø 22.22mm Qty 1 pcs		

			
GEV No.	528094	Ref. No.	64008400
description	O-ring EPDM thickness 2mm ID ø 171mm Qty 1 pcs		
For models:	AF10, AF100, AF20, AF200, AF30, AF80, MF20, MF22, MF26, MF30, MF36		

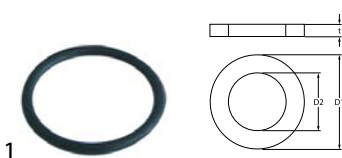
			
GEV No.	510769	Ref. No.	64004101
description	O-ring EPDM thickness 2.62mm ID ø 25.07mm Qty 1 pcs		
For models:	AF10, AF100, AF20, AF200, AF30, AF80, MF20, MF22, MF26, MF30, MF36		

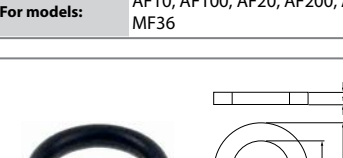
			
GEV No.	361085	Ref. No.	CM41020448
description	O-ring EPDM thickness 2mm ID ø 8mm Qty 1 pcs		
For models:	CD40, MV1000, MV18, MV18-21, MV25, MV25-32, MV450, MV456, MV50, MV600, MV800		

			
GEV No.	511395	Ref. No.	13000617.54 13-0617-54
description	O-ring EPDM thickness 2.62mm ID ø 71.12mm Qty 1 pcs		

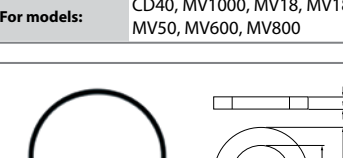
			
GEV No.	510009	Ref. No.	64009303
description	O-ring EPDM thickness 3.53mm ID ø 101.2mm Qty 1 pcs		
For models:	MF41, MF46, MF51, MF56, MF56ASR, MF61, MF62, MF66, MF66ASR		

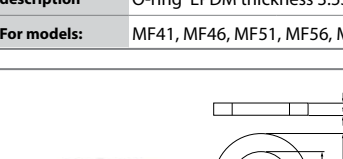
			
GEV No.	532537	Ref. No.	1300061718
description	O-ring EPDM thickness 3.53mm ID ø 113.9mm Qty 1 pcs		

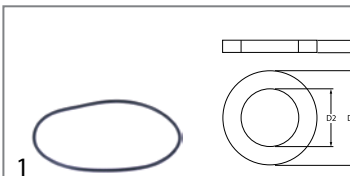

GEV No.	532538	Ref. No.	64004122
description	O-ring EPDM thickness 3.53mm ID ø 129.8mm Qty 1 pcs		
For models:	MF82		

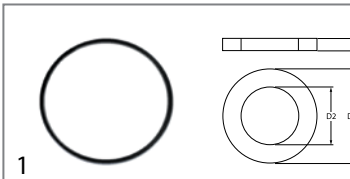

GEV No.	510896	Ref. No.	1300061717 2101144S&P
description	O-ring EPDM thickness 3.53mm ID ø 183.75mm Qty 1 pcs		

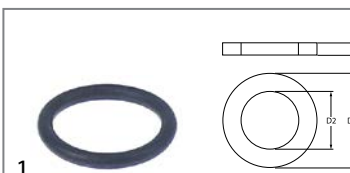

GEV No.	517087	Ref. No.	1300061711 2101126S&P
description	O-ring EPDM thickness 3.53mm ID ø 23.4mm Qty 1 pcs		



GEV No.	511518	Ref. No.	64013400
description	O-ring EPDM thickness 3.53mm ID ø 23.4mm Qty 10 pcs		
For models:	AC045, AC046, AC055, AC056, AC085, AC086, AC105, AC106, AC125, AC125B, AC125C, AC126, AC175, AC176, AC225, AC226, ACM125, ACM175, ACM35, ACM45, ACM55, ACM85, AF10, AF20, AF30, Barline-21, Barline-31, Barline-40, Barline-50, Barline-65, Barline-90, Barline-B40, Barline-B65, Barline-B90, Barline-BUL40, Barline-BUL65, Barline-BUL90, EC045, ICE-ONE, ICE-THREE, ICE-TWO, MAR1, MAR10, MAR125, MAR2, MAR20, MAR3, MAR30, MAR5, MC8...(Other models you can see in the webshop)		



GEV No.	511521	Ref. No.	1300061756
description	O-ring EPDM thickness 3.53mm ID ø 28.17mm Qty 10 pcs		



GEV No.	510895	Ref. No.	1300061731 64009302
description	O-ring EPDM thickness 3.53mm ID ø 34.52mm Qty 1 pcs		
For models:	MF41, MF46, MF51, MF56, MF56ASR, MF61, MF62, MF66, MF66ASR		

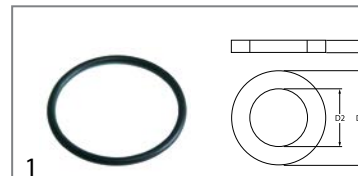

GEV No.	511531	Ref. No.	OT514568005
description	O-ring EPDM thickness 3.53mm ID ø 50.39mm Qty 10 pcs		

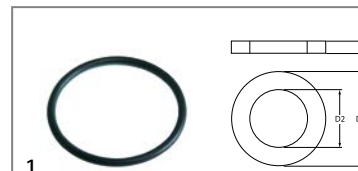

GEV No.	532114	Ref. No.	64004138
description	O-ring EPDM thickness 3.53mm ID ø 50.8mm Qty 10 pcs		

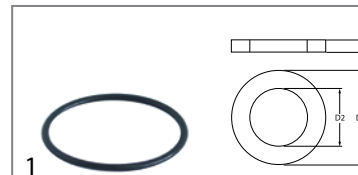

GEV No.	510973	Ref. No.	1300061720 2101108S&P
description	O-ring EPDM thickness 3.53mm ID ø 63.09mm Qty 1 pcs		

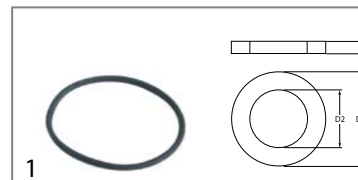

GEV No.	528902	Ref. No.	64004128
description	O-ring EPDM thickness 3.53mm ID ø 66.27mm Qty 1 pcs		

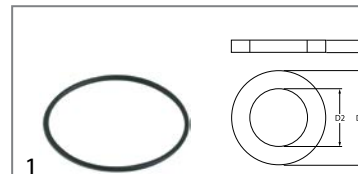

GEV No.	511711	Ref. No.	64004115
description	O-ring EPDM thickness 3.53mm ID ø 78.97mm Qty 1 pcs		

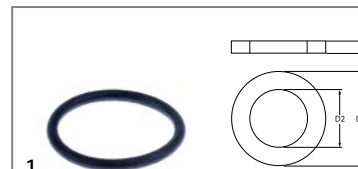

GEV No.	505517	Ref. No.	64004116
description	O-ring EPDM thickness 5.34mm ID ø 53.34mm Qty 1 pcs		
For models:	MF102, MF82, MF83		



silicone

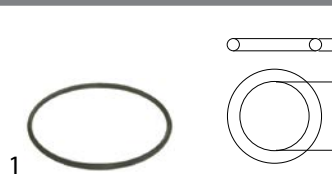

GEV No.	695064	Ref. No.	2101089S&P 64004120
description	O-ring silicone thickness 2mm ID ø 66.4mm Qty 1 pcs		
For models:	AC045, AC055, AC085, AC125, AC125B, AC125C, AC126, AC175, AC176, ACM125, ACM175, ACM45, ACM55, ACM85, Barline-20, Barline-21, Barline-30, Barline-31, Barline-40, Barline-65, Barline-90, Barline-B40, Barline-B65, Barline-B90, Barline-BUL20, EC045, ICE-ONE, ICE-THREE, ICE-TWO		

Viton



GEV No.	532518	Ref. No.	1300061716
description	O-ring Viton thickness 3.53mm ID ø 24.99mm Qty 1 pcs		

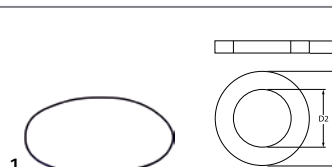

GEV No.	510218	Ref. No.	64004114
description	O-ring Viton thickness 3.53mm ID ø 291.69mm Qty 1 pcs		
For models:	MF102, MF82, MF83		

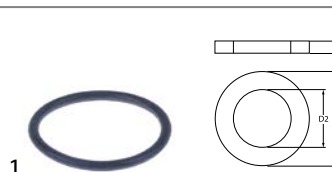

GEV No.	532539	Ref. No.	1300061715
description	O-ring Viton thickness 3.53mm ID ø 40.86mm Qty 1 pcs		

NBR

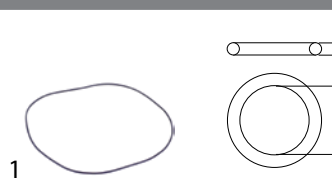

GEV No.	697879	Ref. No.	0A026103.01 13000617.38
description	O-ring NBR thickness 2.62mm ID ø 219mm Qty 1 pcs		
For models:	MF41, MF46, MF51, MF56, MF56ASR, MF61, MF62, MF66, MF66ASR		

sealing washers

fibre gaskets



GEV No.	695880	Ref. No.	64007609
description	flat gasket fibre ED ø 38mm ID ø 27mm thickness 1mm Qty 1 pcs		
For models:	MAR1, MAR10, MAR125, MAR2, MAR20, MAR3, MAR30, MAR5		

rubber gaskets



GEV No.	520054 ¹	Ref. No.	640076.13
description	flat gasket rubber ED ø 23.5mm ID ø 14mm thickness 2.3mm Qty 10 pcs		

¹Qty 10 pieces



GEV No.	695785	Ref. No.	64001000
description	gasket rubber ED ø 75mm ID ø 22mm thickness 1mm Qty 1 pcs		



GEV No.	695784	Ref. No.	64003400
description	gasket rubber ED ø 95mm ID ø 23mm thickness 3.2mm Qty 1 pcs		

foam rubber gaskets



GEV No.	508418	Ref. No.	19350201
description	foam rubber gasket W 15mm thickness 8mm self-adhesive Qty 1m		



GEV No.	695758	Ref. No.	1300059500 2103176
description	foam rubber gasket W 15mm thickness 8mm self-adhesive Qty 3m profile half-round		



GEV No.	901292	Ref. No.	13000595.00 2103176
description	foam rubber gasket W 15mm thickness 8mm self-adhesive Qty supplied by meter		
For models:	B120, B350, B550, BH550		

shaft gaskets

shaft gaskets



GEV No.	698239	Ref. No.	0200396901 64008300
description	shaft seal ID \varnothing 11.91mm ED \varnothing 18.24mm thickness 5mm		
For models:	AF10, AF100, AF20, AF200, AF30, AF80, MF20, MF22, MF26, MF30, MF36		



GEV No.	511532	Ref. No.	0200160600
description	shaft seal ID \varnothing 15mm ED \varnothing 25.5mm thickness 6.5mm for ice-cube maker		
For models:	MF41, MF46, MF51, MF56, MF56ASR, MF61, MF62, MF66, MF66ASR		



GEV No.	511544	Ref. No.	0200058024
description	shaft seal ID \varnothing 22.22mm ED \varnothing 38.07mm thickness 6.35mm type CR8700		



GEV No.	695862	Ref. No.	64009706
description	shaft seal ID \varnothing 220mm ED \varnothing 250mm thickness 15mm for ice maker		
For models:	MAR2, MAR20, MAR3, MAR30		



GEV No.	511534	Ref. No.	64001901
description	shaft seal ID \varnothing 22mm ED \varnothing 32mm thickness 5.5mm		
For models:	AF10, AF100, AF20, AF200, AF30, AF80, MF20, MF22, MF26, MF30, MF36		



GEV No.	511533	Ref. No.	0200285301 02285301 CF02285301
description	shaft seal ID \varnothing 25mm ED \varnothing 34mm thickness 5mm for ice maker		
For models:	AN760, HQD550, HQD650, HQD750, MF41, MF46, MF51, MF56, MF56ASR, MF61, MF62, MF66, MF66ASR, MH750, PO760, PR760		



GEV No.	694128	Ref. No.	0A03237928
description	shaft seal with metal case ID \varnothing 17mm ED \varnothing 27mm thickness 6.4mm		



GEV No.	694218	Ref. No.	0200150300
description	shaft seal with metal case ID \varnothing 22.22mm ED \varnothing 28.58mm thickness 3.18mm type CR8620		

miscellaneous



GEV No.	695774	Ref. No.	64001600
description	shaft sealing for motor ID \varnothing 9mm ED \varnothing 45mm thickness 8mm		



special gaskets

miscellaneous



1

GEV No.	510217	Ref. No.	1300086801 13-0868-01
description	gasket		
For models:	AutoSentry-Double-System-RL, Double-System-RL, FM1200, FM1200R, FM1202, FM1202R, FM1202RL, FM1202RL-C, FM1500, FM1500R, FM2400, FM2400R, FM2400RH, FM2402, FM2402R, FM2402RH, FM800, FM800R, FME1200, FME1200R, FME1202RL, FME1204, FME1204R, FME1204RL, FME1500, FME1500R, FME1500RL, FME1504, FME1504R, FME1504RL, FME2400, FME2400R, FME2400RH, FME2404, FME2404R, FME504AS-1A, FME504WS-1A, FME800AE-1A, FME800AE-6A, FME800AE-6B, FME800R, FME800WE-1A, FME800WE-6A, FME800WE-6B, FME804AS-1A, FME804AS-1B, FME804AS-6A, FME804AS-6B, FME804R, FME804RL...(Other models you can see in the webshop)		

refrigeration cycle components

cooling water regulators

JOHNSON CONTROLS



1

GEV No.	541483	Ref. No.	62011100 79305600 CM19865611 CM19870815
description	cooling water regulator 3/8" type V46AA-9950 connection 6mm soldering connection pressure range 5-18bar water pressure max. 10bar water temperature max. 90°C capillary pipe 750mm L 160mm 0.9kg		
For models:	AC125, AC125B, AC125C, AC126, AC175, AC176, AC225, AC226, ACM125, ACM175, ACM35, ACM55, ACM85, AF20, AF200, AF30, AF80, Barline-65, Barline-90, Barline-B65, Barline-B90, Barline-BUL65, Barline-BUL90, CD40, MAR10, MAR125, MAR5, MC1210, MC15, MC16, MC45, MC46, MC8, MF20, MF22, MF26, MF30, MF36, MF41, MF46, MF51, MF56, MF61, MF66, MV1000, MV18, MV18-21, MV25, MV25-32, MV300...(Other models you can see in the webshop)		

valves

expansion valves

DANFOSS

valves

type TS2/TES2











1

GEV No.	750178	Ref. No.	19870826 CM19870826
description	expansion valve DANFOSS type TS2 coolant R404a/R507 angled 90° inlet 3/8" SAE outlet 1/2" SAE p max 28bar -40 up to -5°C capillary pipe 1500mm		
For models:	MV25-32		



1

GEV No.	750014	Ref. No.	CM81453620	
description	expansion valve DANFOSS type TS2 coolant R404a/R507 angled 90° thermostatically controlled inlet 3/8" SAE outlet 1/2" SAE p max 34bar -40 up to +10°C capillary pipe 1500mm			
For models:	MV450, MV600			
accessories for	750014			
	GEV No.	750020	Ref. No.	—
	nozzle insert size 0X type 068-2002 T/TE 2 DANFOSS			
	GEV No.	750021	Ref. No.	—
	nozzle insert size 00 type 068-2003 T/TE 2 DANFOSS			
	GEV No.	750022	Ref. No.	—
	nozzle insert size 01 type 068-2010 T/TE 2 DANFOSS			
	GEV No.	750023	Ref. No.	—
	nozzle insert size 02 type 068-2015 T/TE 2 DANFOSS			
	GEV No.	750024	Ref. No.	—
	nozzle insert size 03 type 068-2006 T/TE 2 DANFOSS			
	GEV No.	750483	Ref. No.	—
	nozzle insert size 04 type 068-2007 T2/TE2 DANFOSS			
	GEV No.	750484	Ref. No.	—
	nozzle insert size 05 type 068-2008 T2/TE2 DANFOSS			
	GEV No.	750485	Ref. No.	—
	nozzle insert size 06 type 068-2009 T2/TE2 DANFOSS			

type TX2/TEX2



GEV No.	750169	Ref. No.	62048410R
description	expansion valve DANFOSS type TEX2 coolant R22 angled 90° inlet 1/2" SAE outlet 3/8" SAE 1/2" p max -40 up to +10bar capillary pipe 1500mm		
For models:	MF62		



GEV No.	750168	Ref. No.	19870844 CM19870844
description	expansion valve DANFOSS type TX2 coolant R404a/R507 straight inlet 6.5 outlet 9.5 13 capillary pipe 1500mm		

HONEYWELL

valves



GEV No.	750085	Ref. No.	1600088221 16088221
description	expansion valve		
For models:	CME1202, CME1202R, CME1402, CME1402R		



GEV No.	750445	Ref. No.	62042755
description	expansion valve HONEYWELL type AMVX coolant R404a/R507 nozzle ø 2.5mm inlet 5/8" UNF (3/8" SAE) outlet 3/4" UNF (1/2" SAE) 7/16" UNF (1/4" SAE) p max 3bar capillary pipe 1200mm		
For models:	MAR125		



GEV No.	750095	Ref. No.	62042757
description	expansion valve HONEYWELL type AMVX nozzle ø 4.5mm inlet 5/8" UNF (3/8" SAE) outlet 3/4" UNF (1/2" SAE) 7/16" UNF (1/4" SAE) p max 3bar capillary pipe 1200mm		
For models:	MF82, MF83		



GEV No.	750076	Ref. No.	19870607 CM19870607
description	expansion valve HONEYWELL type TMC coolant R12 thermostatically controlled -45 up to -5°C		



GEV No.	750080	Ref. No.	19870626 CM19870626
description	expansion valve HONEYWELL type TMC coolant R22 thermostatically controlled -45 up to -5°C		
For models:	MV25		



GEV No.	750425	Ref. No.	CM19870627
description	expansion valve HONEYWELL type TMV-00001 coolant R22 angled 90° thermostatically controlled inlet 5/8" UNF (3/8" SAE) outlet 3/4" UNF (1/2" SAE) -45 up to +15°C		
For models:	MV50		



GEV No.	750129	Ref. No.	62032610
description	expansion valve HONEYWELL type TMXC coolant R 502 inlet 5/8" UNF (3/8" SAE) outlet 3/4" UNF (1/2" SAE) 0°C capillary pipe 2800mm		
For models:	MC1210		



Schrader valves

valve inserts



1

GEV No.	750098	Ref. No.	67001200
description	Schrader valve CASTEL 8394/B R22		
For models:	AC045, AC046, AC055, AC056, AC085, AC086, AC105, AC106, AC106, AC125, AC125B, AC125C, AC126, AC175, AC176, AC225, AC226, ACM125, ACM175, ACM35, ACM45, ACM55, ACM85, AF10, AF100, AF20, AF200, AF30, AF80, Barline-20, Barline-21, Barline-30, Barline-31, Barline-40, Barline-50, Barline-65, Barline-90, Barline-B40, Barline-B65, Barline-B90, Barline-BUL20, Barline-BUL30, Barline-BUL40, Barline-BUL65, Barline-BUL90, EC045, ICE-ONE, ICE-THREE, ICE-TWO, MAR125, MC1210...(Other models you can see in the webshop)		

filter driers

GMC



1

GEV No.	750086	Ref. No.	CM19300357
description	dryer type SC032S connection ODF 1/4"-ODM 3/8" 50cm ³ p max 45bar -40 up to +80°C 261g total length 95mm ø 57.5mm		
For models:	MV12, MV300, MV450, MV456		

miscellaneous



1

GEV No.	750244	Ref. No.	63000305
description	dryer size 15g ø 19mm L 117mm connection 3,2/6,2mm		
For models:	AC045, AC046, AC055, AC085, AC086, AC105, AC106, ACM25, ACM45, AF10, AF100, AF20, AF200, AF80, Barline-20, Barline-30, Barline-40, Barline-50, Barline-B40, Barline-BUL20, Barline-BUL30, Barline-BUL40, EC045, ICE-ONE, ICE-THREE, ICE-TWO, MF20, MF22, MF26, SD18		



1

GEV No.	750068	Ref. No.	63000303
description	dryer size 25g ø 24mm L 140mm connection 3.5/7mm		
For models:	AC125B, AC125C, AC175, ACM125, AF20, AF30, MF30		

evaporators

for ice-cube maker

for ice cube maker

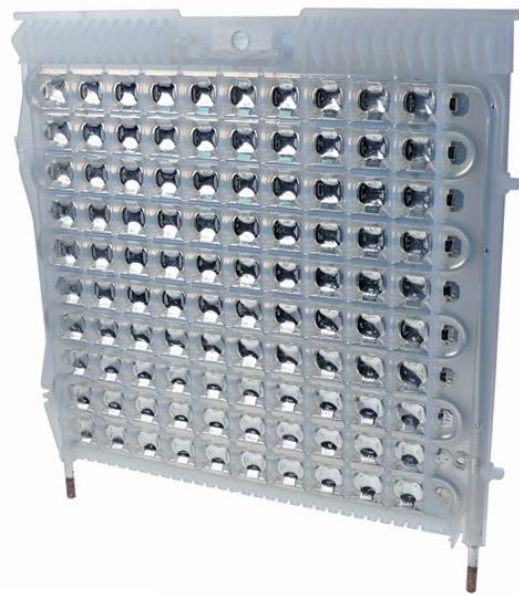

1

GEV No.	750175	Ref. No.	0A03029620
description	evaporator for ice maker L 450mm W 475mm H 35mm		



1

GEV No.	695755	Ref. No.	78429701
description	evaporator for ice-cube maker 24 cubes L 305mm W 205mm H 45mm		
For models:	AC055, AC085, ACM85, ICE-THREE, ICE-TWO		

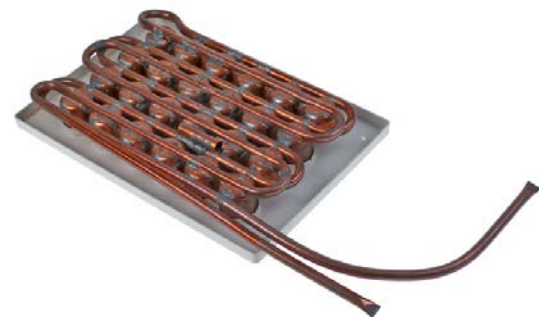

1

GEV No.	695925	Ref. No.	78425701
description	evaporator for ice-cube maker 24 cubes L 306mm W 204mm H 45mm		



1

GEV No.	750173	Ref. No.	78447702
description	evaporator for ice-cube maker 32 cubes L 445mm W 200mm H 45mm		
For models:	AC105, Barline-50		



1

GEV No.	695923	Ref. No.	78429801
description	evaporator for ice-cube maker 42 cubes L 310mm W 205mm H 35mm		
For models:	ICE-THREE, ICE-TWO		



1

GEV No.	694144	Ref. No.	78423400R
description	evaporator for ice-cube maker 8 cubes L 208mm W 110mm H 40mm		

for flake ice maker



1

GEV No.	691791	Ref. No.	78454101
description	evaporator for flake ice maker		



1

GEV No.	691793	Ref. No.	79429802R
description	evaporator for flake ice maker		
For models:	MF41, MF46		



1

GEV No.	691794	Ref. No.	79424600R 79424603R
description	evaporator for flake ice maker		



1

GEV No.	695893	Ref. No.	78448300
description	evaporator for flake ice maker H 173mm ø 47mm		
For models:	AF80		



1

GEV No.	695752	Ref. No.	79430200R 79430201R
description	evaporator for flake ice maker H 247mm ø 73mm		
For models:	AF80		

1

GEV No.	695745	Ref. No.	78445900
description	evaporator for flake ice maker H 287mm ø 115mm without auger		
For models:	MF41, MF46		



1

GEV No.	695751	Ref. No.	79423705R 79423706R
description	evaporator for flake ice maker Wmm H 375mm ø 73mm		
For models:	MF30, MF36		



1

GEV No.	695750	Ref. No.	784261/03
description	evaporator for flake ice maker H 293mm ø 73mm		
For models:	AF30		



1

GEV No.	694121	Ref. No.	78426004
description	evaporator H 223mm ø 74mm		
For models:	AF20		



1

GEV No.	695746	Ref. No.	79423608R
description	evaporator for flake ice maker H 300mm ø 73mm		
For models:	AF100, AF200		



1

GEV No.	694151	Ref. No.	0A02935020
description	freezing cylinder for ice maker H 295mm ø 82mm		

condensors

filters



1

GEV No.	695747	Ref. No.	79423610R
description	evaporator for flake ice maker H 300mm ø 73mm		



1

GEV No.	691798	Ref. No.	66080500
description	air filter for condenser L 410mm W 205mm		
For models:	AC046, AC056		



1

GEV No.	691792	Ref. No.	79423611R
description	evaporator for flake ice maker with auger complete		



1

GEV No.	691796	Ref. No.	3126207S&P 66080502
description	air filter for condenser L 495mm W 270mm		
For models:	AC126, AC176, AC226, MC8		

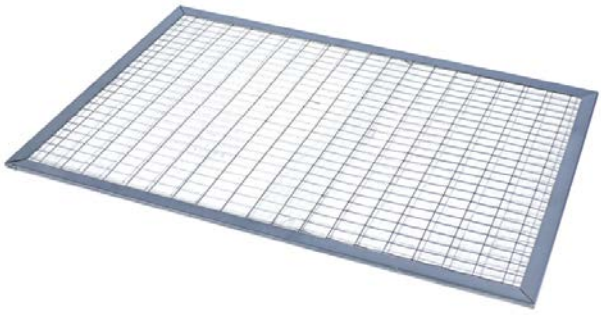

1

GEV No.	695795	Ref. No.	25339004 CM25339004
description	air filter W 340mm H 510mm with frame thickness 6mm		



1

GEV No.	695736	Ref. No.	CM25339006
description	filter for condenser L 510mm W 410mm H 6mm		
For models:	MV450, MV600		

condensers



1

GEV No.	750089	Ref. No.	62027602
description	condenser for ice maker W 280mm D 46mm H 230mm		
For models:	AC045, AC046, ACM35, ACM45, ACM55, ACM85, AF10, AF100, Barline-20, Barline-21, Barline-BUL20, EC045, ICE-ONE, MF20		



1

GEV No.	750091	Ref. No.	62044000
description	condenser for ice maker W 335mm D 120mm H 270mm		
For models:	AC175, AC176, ACM125, ACM175, Barline-90, Barline-B90, Barline-BUL90		



1

GEV No.	750451	Ref. No.	CM19177072
description	condenser for ice maker W 530mm D 80mm H 550mm		
For models:	MV600		



1

GEV No.	750087	Ref. No.	19177509/0
description	condenser W 190mm D 60mm H 200mm		
For models:	GP20		



1

GEV No.	750125	Ref. No.	1262043900
description	condenser W 290mm D 85mm H 260mm		
For models:	AC085, AF20, AF200, Barline-40, Barline-B40, Barline-BUL40, ICE-THREE, MF22, MF26		

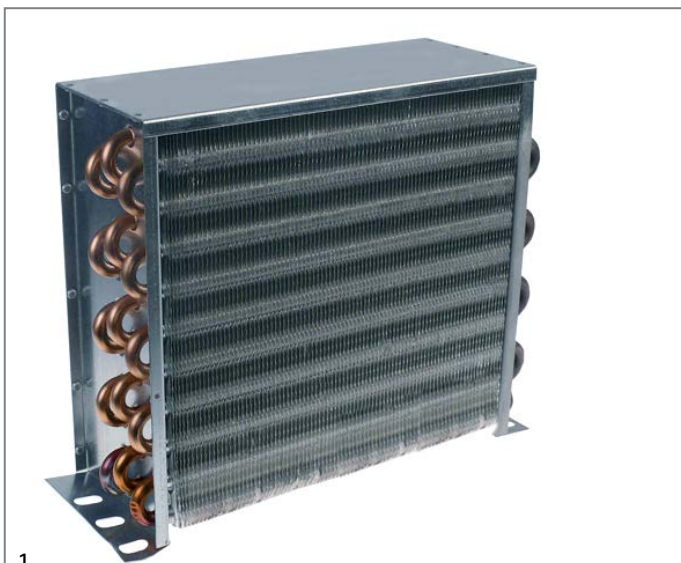

1

GEV No.	750122	Ref. No.	62040500
description	condenser W 290mm D 120mm H 270mm		
For models:	AC125, AC125B, AC125C, AC126, AC175, ACM125, AF30, Barline-65, Barline-B65, Barline-BUL65, MF30, MF36		



1

GEV No.	750171	Ref. No.	19177508 CM19177508
description	condenser W 730mm D 70mm H 605mm		
For models:	MV25-32		

condensers water-cooled



1

GEV No.	695827	Ref. No.	62033102
description	condenser tube \varnothing 25mm \varnothing 155mm H 300mm mounting distance 85mm water-cooled for ice maker connection 14mm		
For models:	MC1210, MC45, MC46		



1

GEV No.	695825	Ref. No.	62033101
description	condenser tube \varnothing 25mm \varnothing 156mm H 250mm mounting distance 85mm water-cooled for ice maker connection 14mm		
For models:	MAR5, MC15, MC16, MF51, MF56		

transmission technology and ball bearings

drive belts

high-performance V-belts, cogged



1

GEV No.	697743	Ref. No.	65042221
description	V-belt belt width 12.7mm L 750mm H 10mm CODE 732Lw profile SPA		

springs

torsion springs



1

GEV No.	695021	Ref. No.	CM25474600
description	torsion spring \varnothing 20.8mm L1 23.2mm L2 37mm wire gauge \varnothing 2.3mm for ice maker		



1

GEV No.	695022	Ref. No.	CM25474602
description	torsion spring \varnothing 21.2mm L1 26mm L2 37mm wire gauge \varnothing 2.6mm for ice maker		

compression springs



1

GEV No.	695844	Ref. No.	65041400
description	compression spring \varnothing 33.4mm L 20mm wire gauge \varnothing 2mm for coupling		
For models:	AF10, AF20, AF30		



tension springs



GEV No.	695951	Ref. No.	0200302201
description	tension spring ø 10mm total length 410mm wire gauge ø 1mm L1 60mm L2 300mm for flake ice maker		

accessories



GEV No.	695856	Ref. No.	65041300
description	ring ID ø 26mm H 4.7mm D1 ø 29mm D2 ø 34mm for spring		
For models:	AF10, AF20, AF30		

kitchen accessories

gastronorm

GN containers

polycarbonate



GEV No.	993015	Ref. No.	T02402
description	GN container polycarbonate size GN 1/3 D 150mm		
accessories for	993015		
	GEV No.	993096	Ref. No.
			—
	lid polycarbonate size GN 1/3		

dosing pumps

membrane dosing pumps

self-priming

SEKO

spare parts



GEV No.	361304	Ref. No.	64011000
description	O-ring EPDM ID ø 11.11mm thickness 1.78mm Qty 1 pcs for type DIB3E/DIB5E		
For models:	AC125B, AC125C, AC175, AC225, ACM125, ACM35, ACM45, ACM55, ACM85		

self-priming with supporting pressure

SEKO



GEV No.	361304	Ref. No.	64011000
description	O-ring EPDM ID ø 11.11mm thickness 1.78mm Qty 1 pcs for type DIB3E/DIB5E		
For models:	AC125B, AC125C, AC175, AC225, ACM125, ACM35, ACM45, ACM55, ACM85		

hoses

drain hoses

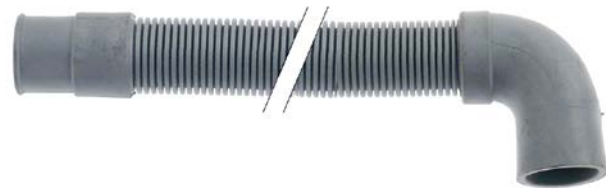

GEV No.	530473	Ref. No.	CM19810114
description	drain hose DN19 L 1900mm straight ø inside 19mm straight ext. ø 25mm elbow ø inside 23mm elbow ext. ø 27mm outer hose ø 24mm for ice maker		

industrial hoses

PE hoses



GEV No.	520738	Ref. No.	CS0002801363
description	hose LLDPE ID ø 6mm ED ø 8mm L 3000mm for beverage technology John Guest		

PVC hoses

for ice-cube maker

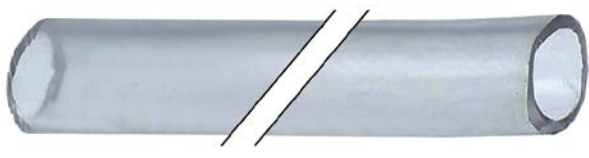

GEV No.	695999	Ref. No.	03091801 0A03091801
description	PVC hose ID ø 13mm ED ø 19mm L 11mm thickness 3mm transparent		

GEV No.	520448	Ref. No.	00028013 CS00028013
description	PVC hose ID ø 18mm ED ø 24mm L 800mm thickness 3mm transparent		

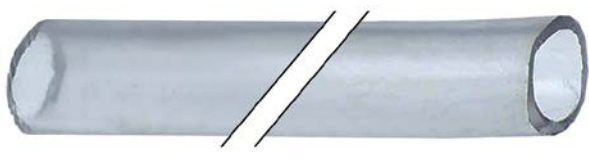

GEV No.	695896	Ref. No.	74300000
description	PVC hose ID ø 18mm ED ø 24mm L 88mm thickness 3mm		

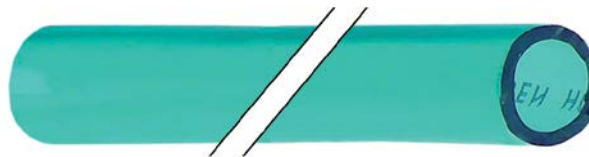

GEV No.	520416	Ref. No.	CS0002801318
description	PVC hose ID ø 18mm ED ø 24mm thickness 3mm Qty supplied by meter		
For models:	SW12		



GEV No.	520445	Ref. No.	0002801334 CS0002801334
description	PVC hose ID ø 22mm ED ø 30mm L 105mm thickness 4mm green		
For models:	SCW14B, SCW14S		

PVC braided hoses

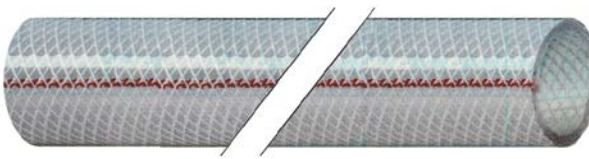

GEV No.	530565	Ref. No.	1300067409
description	PVC braided hose ID ø 13mm ED ø 19mm L 10m operating p. 10bar burst p. 30bar t.max. 60°C Qty 10m		

PVC hoses without fabric

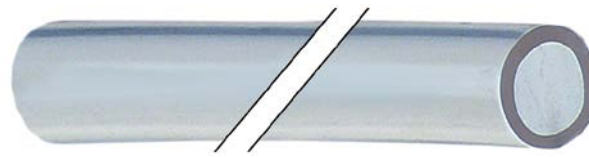

GEV No.	520440	Ref. No.	28183004
description	PVC hose ID ø 14mm ED ø 19mm transparent PVC Qty supplied by meter		
For models:	ACM35		

silicone hoses

without fabric

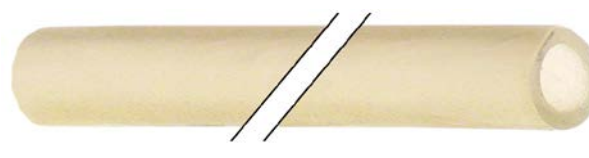

GEV No.	530769	Ref. No.	CM25790880
description	silicone hose for ice-cube maker ID ø 14mm ED ø 20mm L 650mm		
For models:	MV25, MV25-32		

fittings, hose and pipe connectors

hose connectors

without screw connection



GEV No.	695873	Ref. No.	1600067101
description	hose connector plastic hose ø 17-17mm angled		

fittings

double nipples



GEV No.	520447	Ref. No.	73320400
description	double nipple thread 3/8" - 3/4" L1 24mm L2 12mm		
For models:	AC125, AC125B, AC125C, AC126, AC175, AC176, AC225, AC226, ACM125, ACM175, ACM55, ACM85, AF20, AF200, AF30, AF80, MC1210, MC15, MC16, MC45, MC46, MC8, MF20, MF22, MF26, MF30, MF36, MF41, MF46, MF51, MF56, MF61, MF66		





reducers

			
1			
GEV No.	520188	Ref. No.	65057500
description	reducer thread 3/8" IT - 3/8" ET nickel-plated brass total length 24.5mm WS 22		
For models:	MC15, MC16, MC45, MC46		

hose connectors

producer-specific

			
1			
GEV No.	695053	Ref. No.	66029100
description	hose connector for ice-cube maker straight grommet ø 11.5mm grommet length 16mm WS 27 thread L 15mm plastic T1: 3/4" T2: 5/8" UNF (3/8" SAE)		
For models:	AC045, AC055, AC085, AC105, AC106, AC125, AC125B, AC125C, AC126, AC175, AC176, AC225, AC226, ACM125, ACM175, ACM35, ACM45, ACM55, ACM85, AF20, AF30, Barline-20, Barline-30, Barline-40, Barline-50, EC045, ICE-ONE, ICE-THREE, ICE-TWO, MC45, MC8		

			
1			
GEV No.	501339	Ref. No.	25600225 CM25600225
description	hose connector straight ID ø 1/2"mm ø 20mm		
For models:	RB400		

			
1			
GEV No.	695875	Ref. No.	66053400
description	hose connector straight plastic D1 ø 12.5mm D2 ø 14mm		
For models:	AC125, AC125B, AC125C, AC175, ACM125, ACM175, ACM45, ACM55, ACM85		

			
1			
GEV No.	695050	Ref. No.	256908060 CM25690806
description	hose connector straight plastic L 70mm ø 21mm		
For models:	CD40, GP20, GP20W, GP30, GP40, GP40W, GP50, GP50W, GP75, GP75W, GP90, GP90W, MV12, MV18-21, MV25-32, MV50		

			
1			
GEV No.	695791	Ref. No.	0200212101
description	hose connector T plastic ø 19mm left		

			
1			
GEV No.	361796	Ref. No.	73317400
description	hose connector thread 3/4" ET grommet ø 13.5mm ID ø 10mm grommet length 20mm WS 27 thread L 22mm		
For models:	AF20, AF200, AF30, AF80, MC1210, MC15, MC16, MC45, MC46, MF20, MF22, MF26, MF30, MF36, MF41, MF46, MF51, MF56, MF61, MF66, MF66ASR		

			
1			
GEV No.	695845	Ref. No.	65062300
description	hose connector thread 3/8" hose ø 13.5mm curved 90° plastic		
For models:	MC15, MC45		

			
1			
GEV No.	695760	Ref. No.	0002521360 CS0002521360
description	hose connector thread 3/8" hose ø 8mm straight plastic		

			
1			
GEV No.	695921	Ref. No.	0002521363 CS0002521363
description	hose connector thread 3/8" straight grommet ø 8mm grommet length 17mm WS 22 total length 32mm thread L 9mm plastic		



push-in fittings

JOHN GUEST



1

GEV No.	440582	Ref. No.	0002521364 CS0002521364
description	push-in fitting John Guest T-piece pipe connection \varnothing 8mm - \varnothing 8mm		



1

GEV No.	440561	Ref. No.	0002521375 CS0002521375
description	push-in fitting John Guest straight thread 1/8" BSP pipe connection \varnothing 8mm		

accessories for 440561

GEV No.	520972	Ref. No.	—
----------------	--------	-----------------	---

 hose John Guest thickness 1mm LLDPE blue ID \varnothing 6mm ED \varnothing 8mm

1

GEV No.	520452	Ref. No.	0002521366 CS0002521366
description	push-in fitting John Guest straight thread 7/16" UNS pipe connection 5/16" sealing conical		

valves and tank inlets

inlet taps



1

GEV No.	695655	Ref. No.	19680770 CM19680770
description	inlet spout connection 3/8" tube \varnothing 9mm overall height 82mm		

water filters

EVERPURE

kits



1

GEV No.	530049	Ref. No.	9188001
description	water filter set type 4H connection 3/8" vertical		



1

GEV No.	530048	Ref. No.	9188002
description	water filter set type MH connection 3/8" vertical		

filters



1

GEV No.	530047	Ref. No.	9188009
description	water filter EVERPURE type 9498-41 B24 \varnothing 80mm H 150mm for ice maker		

connection heads



1

GEV No.	530259	Ref. No.	9188003
description	filter head EVERPURE type QC71-MC connection 5/8" UNF		



ancillary products

clamps

hose clamps

DIN 3017 - W4



1

GEV No.	520444	Ref. No.	46003701
description	hose clamp SS W4 ø 11-19mm width 9mm Qty 1 pcs DIN 3017		
For models:	ACM35		

double wire clamps



1

GEV No.	520449	Ref. No.	0200153001 4114800
description	hose clamp ø 22mm wire gauge ø 3mm Qty 1 pcs		

locking clamps



1

GEV No.	520443	Ref. No.	4114734 65049901
description	hose clamp ø 14-18mm plastic Qty 1 pcs width 7mm for ice maker		
For models:	AC125, AC125B, AC125C, AC175, ACM125, ACM175, ACM35, ACM55, ACM85		



1

GEV No.	520441	Ref. No.	4122489 65049900
description	hose clamp ø 16-20mm plastic Qty 1 pcs width 7mm for ice maker		
For models:	MC1210, MC15, MC45, MF30, MF61, SD18		



1

GEV No.	520409	Ref. No.	65049902
description	hose clamp ø 20-25mm plastic Qty 1 pcs width 7mm for ice maker		
For models:	AC225		

fastening material

screws

sheet metal screws



1

GEV No.	560109	Ref. No.	47002600
description	sheet metal screws ø 4.2mm L 16mm SS Qty 20 pcs DIN 7981/ISO 7049 head ø 8.2mm oval head		
For models:	AC225, MAR1, MAR2, MAR3, MC1210, MC15, MC45		

flat-headed bolts



1

GEV No.	560178	Ref. No.	0300140377
description	flat-headed bolt thread M5 thread L 40mm steel Qty 1 pcs intake slotted head ø 9.2mm head thickness 2.7mm		
For models:	MF20, MF22, MF26, MF30, MF36, MF41, MF46, MF51, MF56, MF56ASR, MF61, MF62, MF66, MF66ASR		



1

GEV No.	560073	Ref. No.	0300140327 0300140527 03-1405-27
description	flat-headed bolt thread 10/32" UNF thread L 9mm SS Qty 1 pcs intake Phillips head ø 9mm		
For models:	Double-System-RL, FM1200, FM1200R, FM1202, FM1202R, FM1202RL, FM1202RL-C, FM2400, FM2400R, FM2400RH, FM2402, FM2402R, FM2402RH, FME1200, FME1200R, FME1202RL, FME1204, FME1204R, FME1204RL, FME1500RL, FME1504RL, FME2400, FME2400R, FME2400RH, FME2404, FME2404R, FME804RL, NME1850, NME1850R, NME1854, NME1854R, NME950, NME950R, NME954, NME954R		

hexagonal screws



1

GEV No.	560079	Ref. No.	42000026
description	hexagonal screw thread M6 thread L 12mm SS WS 10 Qty 20 pcs DIN 933 / ISO 4017		
For models:	AF10, AF100, AF20, AF200, AF30, AF80, MF20, MF22, MF26, MF30, MF36		

cylinder head bolts

DIN 912/ISO 4762



1

GEV No.	560032	Ref. No.	42028505
description	cylinder head bolt thread M6 thread L 14mm WS 5 SS Qty 20 pcs DIN 912/ISO 4762		

knurled screws



1

GEV No.	694115	Ref. No.	65080600
description	Thumb screw thread M5 thread L 10mm ø 12mm H 6mm brass		
For models:	AC046, AC056, AC086, AC106, AC126, AC176, AC226		



1

GEV No.	695767	Ref. No.	0300072709
description	Thumb screw L 10mm ø 10mm thread M4 stainless steel		

nuts

plate nuts



1

GEV No.	560410	Ref. No.	03001423 4114671
description	plate nut steel hole ø 3.2mm L 18mm W 10mm		



1

GEV No.	560188	Ref. No.	0300027100
description	plate nut hole ø 2.2mm L 12mm W 6mm for ice maker ømm		



1

GEV No.	560265	Ref. No.	65016000
description	plate nut hole ø 2.7mm L 42mm W 10mm for ice maker ømm		

wing nuts



1

GEV No.	560145	Ref. No.	43008300
description	wing nuts thread M4 SS DIN/ISO DIN 315 Qty 20 pcs		
For models:	MF20, MF22, MF26, MF30, MF36, MF41, MF46, MF51, MF56, MF56ASR, MF61, MF62, MF66, MF66ASR		

hexagonal nuts

DIN 934 / ISO 4032/8673



1

GEV No.	560132	Ref. No.	43003300
description	hexagonal nut thread M5 H 4mm WS 8 SS DIN/ISO DIN 934 / ISO 4032/8673 Qty 20 pcs		

DIN 985



1

GEV No.	560072	Ref. No.	PROM69500813
description	hexagonal nut thread M16 H 16mm SS WS 24 Qty 1 pcs self-locking		

hexagonal nuts metric (without norm)



1

GEV No.	521103	Ref. No.	0300140604
description	nut thread M4 H 3mm WS 7 brass Qty 20 pcs		



hexagonal nuts inch thread			
			
1			
GEV No.	695979	Ref. No.	40005300
description	nut thread 3/4" H 7mm chrome-plated brass WS 32 Qty 1 pcs		
For models:	AC125, AC125B, AC125C, AC126, AC175, AC176, AC225, AC226, ACM125, ACM175, AF20, AF30, Barline-65, Barline-90, Barline-B65, Barline-B90, Barline-BUL65, Barline-BUL90, MC8, MF102, MF62, MF82, MF83		

washers

spring washers

			
1			
GEV No.	695659	Ref. No.	46004100
description	spring washer ID ø 32mm ED ø 39mm Qty 1 pcs		
For models:	MF41, MF46, MF51, MF56, MF56ASR, MF61, MF62, MF66, MF66ASR		

washers

miscellaneous

			
1			
GEV No.	560093	Ref. No.	44180008
description	plain washer ID ø 10mm ED ø 19mm thickness 0.3mm steel Qty 1 pcs		
For models:	AF10, AF100, AF20, AF200, AF30, AF80, MF20, MF22, MF26, MF30, MF36		

			
1			
GEV No.	560092	Ref. No.	44180007
description	plain washer ID ø 10mm ED ø 19mm thickness 0.8mm steel Qty 1 pcs		
For models:	AF10, AF100, AF20, AF200, AF30, AF80, MF20, MF22, MF26, MF30, MF36		

			
1			
GEV No.	560167	Ref. No.	4114311 44180009
description	plain washer ID ø 12mm ED ø 16mm thickness 0.8mm steel Qty 1 pcs		
For models:	AF10, AF100, AF20, AF200, AF30, AF80, MF20, MF22, MF26, MF30, MF36		

			
1			
GEV No.	560144	Ref. No.	0300140824 03140824
description	plain washer ID ø 13mm ED ø 22mm thickness 0.8mm steel Qty 1 pcs		
For models:	AF430, AF730, AN760, HQD550, HQD650, HQD750, MF41, MF46, MF51, MF56, MF56ASR, MF61, MF62, MF66, MF66ASR, MF6C, MF900RC, MH750, PO760, PR760		

			
1			
GEV No.	560166	Ref. No.	2102337 44001306
description	plain washer ID ø 16.2mm ED ø 21mm thickness 0.8mm SS Qty 1 pcs		
For models:	AC225, AC226, MC1210, MC15, MC16, MC45, MC46, MC8		

			
1			
GEV No.	560094	Ref. No.	44180004
description	plain washer ID ø 17mm ED ø 24mm thickness 0.5mm steel Qty 1 pcs		
For models:	MF41, MF46, MF51, MF56, MF56ASR, MF61, MF62, MF66, MF66ASR		

			
1			
GEV No.	560152	Ref. No.	44180800
description	plain washer ID ø 23mm ED ø 29mm thickness 1.5mm steel Qty 1 pcs		
For models:	AF10, AF100, AF20, AF200, AF30, AF80, MF20, MF22, MF26, MF30, MF36		

			
1			
GEV No.	560568	Ref. No.	0200167900 02001681 02167900 02168100
description	plain washer ID ø 25.6mm ED ø 39mm thickness 0.85mm SS Qty 1 pcs		
For models:	AF730, AN760, HQD550, HQD650, HQD750, MF41, MF46, MF51, MF56, MF56ASR, MF61, MF62, MF66, MF66ASR, MF6C, MF900RC, MH750, PO760, PR760		

			
1			
GEV No.	560149	Ref. No.	0200168100
description	plain washer ID ø 25.6mm ED ø 39mm thickness 0.8mm steel Qty 1 pcs		
For models:	MF41, MF46, MF51, MF56, MF56ASR, MF61, MF62, MF66, MF66ASR		



1

GEV No.	560074	Ref. No.	44180005
description	plain washer ID ø 8.5mm ED ø 14mm thickness 0.3mm steel Qty 1 pcs		
For models:	AF10, AF100, AF20, AF200, AF30, AF80, MF20, MF22, MF26, MF30, MF36		



1

GEV No.	560091	Ref. No.	4114317 44180006
description	plain washer ID ø 8.5mm ED ø 14mm thickness 0.8mm steel Qty 1 pcs		
For models:	AF10, AF100, AF20, AF200, AF30, AF80, MF20, MF22, MF26, MF30, MF36		

fasteners

mounting clips



1

GEV No.	524387	Ref. No.	65020800
description	spring clip nominal-ø 7mm steel L 30mm W 16mm H 14mm mounting distance mm		

mounting spigots



1

GEV No.	524030	Ref. No.	1500041100 4114691
description	spigot nominal-ø 7mm thread M4x0.8 L 13mm		

cable ties

1

GEV No.	550253	Ref. No.	65027800
description	cable tie W 3.6mm L 290mm white Qty 100 pcs nylon		

slot nuts



1

GEV No.	560181	Ref. No.	74109200
description	slot nut W 6mm H 6mm L 40mm		
For models:	MAR2, MAR3		



1

GEV No.	694214	Ref. No.	0300163001
description	slot nut W 6.4mm H 7.6mm L 16mm special for ice maker		

pipe clips



1

GEV No.	695584	Ref. No.	25474608 CM25474608
description	spring clip L 28mm W 10mm hole ø 4.5mm tube ø 31mm		
For models:	MV1000, MV12, MV18, MV18-21, MV25, MV25-32, MV300, MV450, MV50, MV600, MV800		

clamps

hose clamps

DIN 3017 - W4



1

GEV No.	520444	Ref. No.	46003701
description	hose clamp SS W4 ø 11-19mm width 9mm Qty 1 pcs DIN 3017		
For models:	ACM35		

double wire clamps



1

GEV No.	520449	Ref. No.	0200153001 4114800
description	hose clamp ø 22mm wire gauge ø 3mm Qty 1 pcs		

locking clamps



1

GEV No.	520443	Ref. No.	4114734 65049901
description	hose clamp ø 14-18mm plastic Qty 1 pcs width 7mm for ice maker		
For models:	AC125, AC125B, AC125C, AC175, ACM125, ACM175, ACM35, ACM55, ACM85		





 <p>1</p>			
GEV No.	520441	Ref. No.	4122489 65049900
description	hose clamp ø 16-20mm plastic Qty 1 pcs width 7mm for ice maker		
For models:	MC1210, MC15, MC45, MF30, MF61, SD18		

 <p>1</p>			
GEV No.	520409	Ref. No.	65049902
description	hose clamp ø 20-25mm plastic Qty 1 pcs width 7mm for ice maker		
For models:	AC225		



retaining rings



DIN 472

 <p>1</p>			
GEV No.	695955	Ref. No.	0300155804
description	retaining ring bore ø 65mm thickness 2mm steel DIN 472		

 <p>1</p>			
GEV No.	695829	Ref. No.	46004400
description	retaining ring bore ø 85mm thickness 2.5mm stainless steel DIN 472 for ice maker		
For models:	MF102, MF82, MF83		

DIN 6799

  <p>1</p>			
GEV No.	523004	Ref. No.	0300153909
description	retaining ring E D1 ø 5mm D2 ø 13.5mm SS DIN 6799 thickness 0.7mm for shaft ø 6-8mm		

  <p>1</p>			
GEV No.	507015	Ref. No.	CF46003802
description	retaining ring E D1 ø 7mm D2 ø 14mm SS DIN 6799 thickness 0.9mm for shaft ø 8-11mm		

consumables

lubricants

machine lubricants

 <p>1</p>			
GEV No.	890003	Ref. No.	06029401
description	machine lubricant 1000g		
description			
For models:	AF10, AF100, AF20, AF200, AF30, AF80, MF20, MF22, MF26, MF30, MF36, MF41, MF46, MF51, MF56ASR, MF61, MF62, MF66, MF66ASR		

 <p>1</p>			
GEV No.	890029	Ref. No.	06029404
description	machine lubricant Mobilux EP004 can 500g for gearbox -25 up to +120°C		
description	<p>Mobilux EP004 - can 500g</p> <p>Suitable for lubricating enclosed gears and bearings in poorly sealed gear cases with the exception of electric motor bearings. Can also be used for many other industrial applications, e.g. gear cases and chains, in which conventional gear oils would escape due to leaks caused by worn or missing seals. Meets requirements of SEW 1008 hour gear test, DR.EM.2003 mod.</p> <p>Temperature resistance: -25°C to +120°C</p>		

 <p>1</p>			
GEV No.	890002	Ref. No.	26361200
description	machine lubricant White Food Grade food-safe -25 up to +150°C approval NSF 200g		
description			
For models:	AF10, AF100, AF20, AF200, AF30, AF80, MF20, MF22, MF26, MF30, MF36, MF41, MF46, MF51, MF56, MF56ASR, MF61, MF62, MF66, MF66ASR		

oils

gear oils



GEV No.	890004	Ref. No.	03237927 0A03237927 A32379-027
description	gear oil 450g		
For models:	AF325, AFE400, AutoSentry-Double-System-RL, Double-System-RL, FDE470AE-1A, FDE470AE-6A, FDE470AS-1A, FDE470AS-6A, FDE474AS-1A, FDE474AS-6A, FM1200, FM1200R, FM1202, FM1202R, FM1202RL, FM1202RL-C, FM1500, FM1500R, FM2400, FM2400R, FM2400RH, FM2402, FM2402R, FM2402RH, FM800, FM800R, FME1200, FME1200R, FME1202RL, FME1204, FME1204R, FME1204RL, FME1500, FME1500R, FME1500RL, FME1504, FME1504R, FME1504RL, FME2400, FME2400R, FME2400RH, FME2404, FME2404R, FME504AS-1A, FME504WS-1A, FME800AE-1A, FME800AE-6A, FME800AE-6B, FME800R, FME800WE-1A...(Other models you can see in the web-shop)		

cleaning agents

descalers



GEV No.	802164	Ref. No.	00100902 1143046
description	descaler 4.8l phosphoric acid for ice maker		

fuses

fine fuses



GEV No.	358611	Ref. No.	63001510
description	fine fuse size ø5x20mm 16A fast-acting rated 250V Qty 10 pcs		
For models:	AC045, AC055, AC085, AC105, AC125, AC125B, AC125C, AC175, AC225, ACM125, ACM175, ACM35, ACM45, ACM55, ACM85, AF10, AF100, AF20, AF200, AF30, AF80, Barline-B40, Barline-B65, Barline-B90, Barline-BUL20, Barline-BUL30, Barline-BUL40, Barline-BUL65, Barline-BUL90, MC1210, MC15, MC45, MF20, MF30, MF61		



GEV No.	358509	Ref. No.	63001511
description	fine fuse size ø5x20mm 0.05A slow-acting rated 250V Qty 1 pcs		
For models:	AC045, AC055, ACM35, ACM45, ACM55, Barline-BUL20, Barline-BUL30		

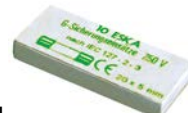

GEV No.	358592	Ref. No.	63001509
description	fine fuse size ø5x20mm 0.1A slow-acting rated 250V Qty 10 pcs		
For models:	AC085, AC105, AC125, AC125B, AC125C, AC175, AC225, ACM125, ACM175, ACM85, AF10, AF100, AF20, AF200, AF30, AF80, Barline-B40, Barline-B65, Barline-B90, Barline-BUL40, Barline-BUL65, Barline-BUL90, MC1210, MC15, MC45, MF20, MF30, MF41, MF51, MF61		

refrigeration cycle components	95
refrigeration fans	34
refrigeration gaskets	89
refrigeration motors universal	34
refrigeration thermostats	3
relays	13
retaining rings	111
ribbon cables	46
rocker/momentary rocker switches	6

S

Schrader valves	97
screws	107
sealing washers	93
shaft gaskets	94
sheet metal screws	107
silicone hoses	104
slot nuts	110
solenoid valves	22
spring washers	109
starting capacitors	44
switches and momentary switches	6

T

terminals	47
terminals and connectors	47
thermostats	3
time relays	14
timers	11
toggle switches	7
touch sensitive light switches	9
transformers	14

V

valves and tank inlets	106
------------------------	-----

W

washers	109
water filters	106
wing nuts	108