



**GAS COMPONENTS**



**ELECTRIC COMPONENTS**



**WATER TECHNOLOGY**



**MECHANICAL COMPONENTS**



**TOOLS**

Spare parts suitable for

**SIMAG**

Find the complete and up-to-date range of products in our GEV Webshop



# Manufacturer catalogue

The most important spare parts and accessories arranged clearly for every manufacturer

- ✓ Complete product range and all appliance data always up to date in the GEV Webshop
- ✓ Alphabetical Index at the end of the catalogue

## GEV Webshop

[www.gev-online.co.uk](http://www.gev-online.co.uk)

[www.gev-online.com](http://www.gev-online.com)



- 🔍 Add to Favourites
- 🔍 Sign In with email address and usual password
- 🔍 Easy-order – place several items in your basket at the same time
- 🔍 Quick Item search – no login needed



## thermostats

### control and safety thermostats

#### RANCO

##### safety thermostats



<b>GEV No.</b>	375832	<b>Ref. No.</b>	62044300 62044302
<b>description</b>	safety thermostat t.max. 70°C temperature range 0-70°C 1-pole 1NO 16A probe ø 8mm probe L 60mm capillary pipe 870mm capillary pipe isolatedmm gland nut shaft ømm shaft Lmm shaft position rotation° probe material copper switch-off temp. 70°C		
<b>For models:</b>	SD18, SD22, SD23, SD30, SDN25		

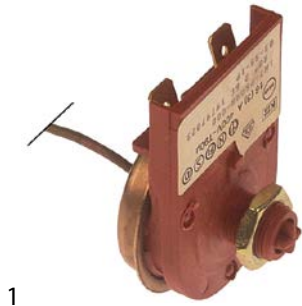

<b>GEV No.</b>	390583	<b>Ref. No.</b>	CM19797023
<b>description</b>	safety thermostat t.max. 80°C temperature range°C 1-pole 1NC 16A probe ø 9mm probe L 50mm capillary pipe 800mm capillary pipe isolatedmm gland nut shaft ømm shaft Lmm shaft position rotation° probe material copper with coiled probe screw connection M10x0.75 switch-off temp. 80°C		

### refrigeration thermostats

#### universal with housing



<b>GEV No.</b>	390536	<b>Ref. No.</b>	Z1EL042
<b>description</b>	thermostat temperature range -35 up to +35°C probe ø6x110mm capillary pipe 1500mm PRODIGY at 400V 16A 1CO type TR/711-N		

#### DANFOSS

##### service thermostats DANFOSS

All Danfoss thermostats are supplied with fastening material application:

- 390552 - \*\*fridges
- 390553 - \*\*Refrigerators with defrosting push button
- 390554 - \*\*/\*\*Refrigerators with automatic defrosting
- 390555 - absorption refrigerators
- 390557 - Deep cooler with active signal
- 390558 - Freezing with passive signal
- 390559 - bottle cooler 390559



<b>GEV No.</b>	390559	<b>Ref. No.</b>	CM19797007 CM19797012
<b>description</b>	thermostat type 077B7008 capillary pipe 2000mm temperature range -8.5 up to +11.5°C probe ømm probe Lmm		

#### RANCO

##### K22 series



<b>GEV No.</b>	390201	<b>Ref. No.</b>	Z1EL012
<b>description</b>	thermostat RANCO type K22L2021 probe ømm probe Lmm capillary pipe 2500mm temperature range -16°C		



<b>GEV No.</b>	390207	<b>Ref. No.</b>	1EL011 62026414 Z1EL011
<b>description</b>	thermostat RANCO type K22L2030 probe ø 2mm probe Lmm capillary pipe 2000mm temperature range -13 up to -4°C		
<b>For models:</b>	SD22, SD23, SD40		



**GEV No.** 390646      **Ref. No.** 620263.03

**description** thermostat RANCO type K22-L1075 capillary pipe 2900mm probe ø9.5x107mm



**GEV No.** 390209      **Ref. No.** 62020100

**description** thermostat RANCO type K22L1020 probe ø 9mm probe L 40mm capillary pipe 2000mm temperature range -20.5 up to -1.5°C

**For models:** SD22, SD23, SD30, SDN25



**GEV No.** 390737      **Ref. No.** 620201.01

**description** thermostat RANCO type K22-L1074 probe ø 9mm probe L 42mm capillary pipe 1450mm temperature range -19 up to -1°C



**GEV No.** 390277      **Ref. No.** 630038.00

**description** thermostat RANCO type K22L3020 probe ø 9mm probe L 40mm capillary pipe 1600mm temperature range -26.5 up to -19.5°C



**GEV No.** 390279      **Ref. No.** 62012900

**description** thermostat RANCO type K22L3022 probe ø 9mm probe L 35mm capillary pipe 1600mm

### K50 series



**GEV No.** 390254      **Ref. No.** 620209.00

**description** thermostat RANCO type K50P1135 probe ømm probe Lmm capillary pipe 2500mm T cold 1.5°C

**For models:** SD18, SD22, SD23, SD30



**GEV No.** 390581      **Ref. No.** CM19797026

**description** thermostat RANCO type K50-S3595 probe ø 2mm probe Lmm capillary pipe 2000mm

### K55 series



**GEV No.** 390210      **Ref. No.** 62026302 Z1EL010

**description** thermostat RANCO type K55L1042 capillary pipe 1100mm temperature range +1.7 up to +9.5°C probe ø10x110mm

**For models:** SD23



**GEV No.** 390283      **Ref. No.** CM19797017

**description** thermostat RANCO type K55L5081 capillary pipe 1100mm temperature range°C probe ø10x110mm



**RANCO**



1

<b>GEV No.</b>	390284	<b>Ref. No.</b>	CM19797018
<b>description</b>	thermostat RANCO type K55L5082 capillary pipe 1500mm temperature range°C probe ø10x110mm		

**RANCO**



1

<b>GEV No.</b>	379516	<b>Ref. No.</b>	620264.02 62026415 62026416
<b>description</b>	thermostat RANCO type K61L1508 probe ø 2mm probe Lmm capillary pipe 1800mm		

**K61 series**

**RANCO**



1

<b>GEV No.</b>	390212	<b>Ref. No.</b>	620264.01 620264.10
<b>description</b>	thermostat RANCO type K61L1500 probe ømm probe Lmm capillary pipe 750mm T war -11.5°C T cold 22°C		

**RANCO**



1

<b>GEV No.</b>	390591	<b>Ref. No.</b>	62026415
<b>description</b>	thermostat RANCO type K61L1509 probe ø 2mm probe Lmm capillary pipe 2250mm		
<b>For models:</b>	SD18		

**RANCO**



1

<b>GEV No.</b>	390206	<b>Ref. No.</b>	620264.00
<b>description</b>	thermostat RANCO type K61L1501 probe ømm probe Lmm capillary pipe 1800mm		

**switches and momentary switches**

**rocker/momentary rocker switches**

**30x11mm**



1

<b>GEV No.</b>	301013	<b>Ref. No.</b>	62044201 62044202
<b>description</b>	rocker switch mounting measurements 30x11mm black 1CO 250V 16A connection male faston 6.3mm ambient temperature max. 85/125°C protection IP40		
<b>For models:</b>	SD18, SD22, SD23, SD30, SDN25		

**RANCO**



1

<b>GEV No.</b>	390586	<b>Ref. No.</b>	620264.11
<b>description</b>	thermostat RANCO type K61L1504 probe ø 2mm probe Lmm capillary pipe 1800mm T war 11.5°C T cold 22°C		

**push/momentary push switches**

**19x13mm**



1

<b>GEV No.</b>	347079 <sup>1</sup>	<b>Ref. No.</b>	620487.00
<b>description</b>	push switch mounting measurements 19x13mm green 2NO 250V 16A illuminated connection male faston 6.3mm ambient temperature max. 125°C protection IP65 with cover cap		

<sup>1</sup>illuminated





toggle switches

M12x0.75



<b>GEV No.</b>	346526	<b>Ref. No.</b>	1200042601 620033 01 62003302 Z1EL031
<b>description</b>	toggle switch thread M12x0.75 1CO 250V 15A ON-ON male faston 6.3mm		

microswitches

lever actuated



<b>GEV No.</b>	345345	<b>Ref. No.</b>	CM19410207 CM25474578
<b>description</b>	microswitch with lever 250V 16A 1CO connection male faston 6.3mm L 78mm ambient temperature max. 85°C mounting distance 22mm type X662-88-J27 actuating force: 40g lever length 69mm		



<b>GEV No.</b>	345361	<b>Ref. No.</b>	CM19410205
<b>description</b>	microswitch with lever 250V 5A 1NO/1NC connection soldering connection ambient temperature max. 85°C type 83109004 lever length 43mm		

roller-lever actuated

microswitches



<b>GEV No.</b>	345253	<b>Ref. No.</b>	CM19410209
<b>description</b>	microswitch with handle with a switch 250V 15A 1CO connection male faston 6.3mm L 28mm L1 37mm ambient temperature max. 125°C mounting distance 22mm type RL6-1-F-GE-P12-5-L actuating force: 80g grey lever length 28mm		

heavy duty version



<b>GEV No.</b>	346874	<b>Ref. No.</b>	CM19410300
<b>description</b>	microswitch with handle with a switch 250V 16A 1CO connection screw L 29mm L1 49mm ambient temperature max. 85°C mounting distance 26mm type Z-15GW22-B actuating force: 120g lever length 25mm		

with mounting components



<b>GEV No.</b>	346876	<b>Ref. No.</b>	CM19410208
<b>description</b>	microswitch with handle with a switch 250V 16A 1CO connection male faston L 35mm L1 28mm ambient temperature max. 125°C mounting distance 22mm type V-166-1CR5 actuating force: 86g		

float switches



<b>GEV No.</b>	345365	<b>Ref. No.</b>	CM81409179
<b>description</b>	float switch 250V 16A 1CO male faston 6.3mm L 150mm ambient temperature max. 125°C mounting distance 23mm type EF83161.5 actuating force: 5g black		



<b>GEV No.</b>	347088	<b>Ref. No.</b>	CM81449091
<b>description</b>	float switch with plunger 250V 16A 1CO male faston 6.3mm L 130mm ambient temperature max. 125°C mounting distance 23mm type EF83161.5 actuating force: 5g black		

floats



<b>GEV No.</b>	695036	<b>Ref. No.</b>	66058500 783127.00
<b>description</b>	float for ice maker ø 75mm L 115mm H 40mm plastic		
<b>For models:</b>	SP405, SPR80		

touch sensitive light switches

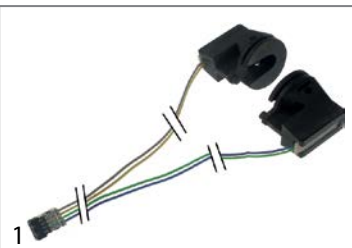

<b>GEV No.</b>	402039	<b>Ref. No.</b>	78508600 78508602R
<b>description</b>	light barrier		



1

<b>GEV No.</b>	402043	<b>Ref. No.</b>	650674.01 65067402 785086.00
<b>description</b>	light barrier L 180mm W 35mm H 46mm		
<b>For models:</b>	SP405, SPR80		



1

<b>GEV No.</b>	402009	<b>Ref. No.</b>	650674.00 650674.05 783167.01
<b>description</b>	light barrier L 310mm W 35mm H 47mm		

magnetic switches

36x13mm



1

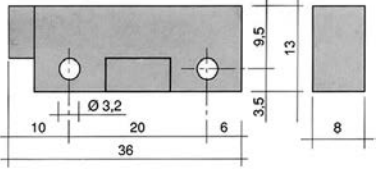

<b>GEV No.</b>	345118 <sup>1</sup>	<b>Ref. No.</b>	CM33210019
<b>description</b>	magnetic switch L 36mm W 13mm 1NO 250V 1A P max. 50W connection cable cable length 980mm		
<b>accessories for</b>	345118		
	<b>GEV No.</b>	<b>Ref. No.</b>	CM193550007 CM19355004
	magnet ø 3.3mm L 40mm H 8mm W 13mm hole distance 30mm M3		

<sup>1</sup>with coded connector

accessories

magnets



1

<b>GEV No.</b>	347059	<b>Ref. No.</b>	CM19355007
<b>description</b>	magnet L 40mm H 8mm W 13.2mm hole distance 30mm		



1

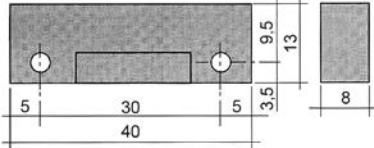

<b>GEV No.</b>	345399	<b>Ref. No.</b>	CM193550007 CM19355004
<b>description</b>	magnet ø 3.3mm L 40mm H 8mm W 13mm hole distance 30mm M3		

lamps

indicator lights

indicator lights (complete)

ø13mm

with plug-in socket



1

<b>GEV No.</b>	359141	<b>Ref. No.</b>	630091.11 630091.14
<b>description</b>	indicator light ø 13mm red 230V connection male faston 6.3mm temp.-resist. 120°C Qty 1 pcs		

timers

programme timers



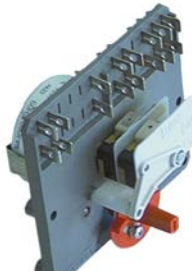

1

<b>GEV No.</b>	360163	<b>Ref. No.</b>	620244.02
<b>description</b>	timer FIBER P23 engines 1 chambers 1 operation time 15min 230V shaft L 30mm manuf. no. P235JR1J706 motor type M51BJ0R6400		
<b>spare parts for</b>	360163		
	<b>GEV No.</b>	<b>Ref. No.</b>	360673 —
	motor kit pinion ø 6.8mm teeth 15 230V voltage AC 50/60Hz turn direction clockwise motor ø 48mm H 18.5mm motor type UDS-40NE1RNZ165 cable length 150mm with holder		





1

<b>GEV No.</b>	360162	<b>Ref. No.</b>	620244.09
<b>description</b>	timer FIBER P23 engines 1 chambers 2 operation time 12min 230V manuf. no. P235JR2J501 motor type M51BJ0R6400		
<b>spare parts for</b>	360162		
	<b>GEV No.</b>	360673	<b>Ref. No.</b> —
	motor kit pinion $\varnothing$ 6.8mm teeth 15 230V voltage AC 50/60Hz turn direction clockwise motor $\varnothing$ 48mm H 18.5mm motor type UDS-40NE1RNZ165 cable length 150mm with holder		



1

<b>GEV No.</b>	360051	<b>Ref. No.</b>	62043100
<b>description</b>	timer FIBER P36 engines 1 chambers 2 operation time 15min 230V shaft $\varnothing$ mm shaft Lmm manuf. no. P365JR2J717 motor type M51B-J0R6400		
<b>spare parts for</b>	360051		
	<b>GEV No.</b>	360673	<b>Ref. No.</b> —
	motor kit pinion $\varnothing$ 6.8mm teeth 15 230V voltage AC 50/60Hz turn direction clockwise motor $\varnothing$ 48mm H 18.5mm motor type UDS-40NE1RNZ165 cable length 150mm with holder		



1

<b>GEV No.</b>	360371	<b>Ref. No.</b>	620441.02
<b>description</b>	timer FIBER P36 engines 1 chambers 2 operation time 8min 230V shaft $\varnothing$ mm shaft Lmm manuf. no. P365JR2J236 motor type M51B-J0R6400		
<b>For models:</b>	SD30		
<b>spare parts for</b>	360371		
	<b>GEV No.</b>	360673	<b>Ref. No.</b> —
	motor kit pinion $\varnothing$ 6.8mm teeth 15 230V voltage AC 50/60Hz turn direction clockwise motor $\varnothing$ 48mm H 18.5mm motor type UDS-40NE1RNZ165 cable length 150mm with holder		

## relays

### power relays

#### with bracket mounting



1

<b>GEV No.</b>	380312	<b>Ref. No.</b>	62023702 CM19620107 Z1EL004
<b>description</b>	power relays FINDER 230VAC 10A 3CO connection male faston 4.8mm bracket mounting dimensions 52x32.2x36.5mm manuf. no. 60.63.8.230.0000		



1

<b>GEV No.</b>	380185	<b>Ref. No.</b>	CM19620103
<b>description</b>	power relays Italiana Relè 230VAC 30A 1NO connection F6.3 bracket mounting dimensions 36.5x32.2x51.8mm manuf. no. A10-230AC-FA		

### time relays

#### time relays



1

<b>GEV No.</b>	360161	<b>Ref. No.</b>	Z1EL051
<b>description</b>	time relay FIBER R1655M607VO time range 0-6min 220VAC 6A/2A		





## probes

### producer-specific probes

#### probes



<b>GEV No.</b>	379628	<b>Ref. No.</b>	02003410.21
<b>description</b>	temperature probe 2x NTC 10K cable PVC probe -40 up to +110°C cable -10 up to 100°C connection coded plug thread probe ø6.5x45mm cable length 0.4/0.55m		



<b>GEV No.</b>	381337	<b>Ref. No.</b>	620519 01
<b>description</b>	temperature probe NTC 10kOhm cable PVC probe -40 up to +110°C cable -10 up to 100°C connection plug thread probe ø5x40mm cable length 1.5m		



<b>GEV No.</b>	402006	<b>Ref. No.</b>	620404.06 CM33580065
<b>description</b>	temperature probe PTC 2kOhm cable PVC probe -50 up to +150°C cable -10 up to 100°C connection plug thread probe ø5x60mm cable length 1.5m		



<b>GEV No.</b>	402007	<b>Ref. No.</b>	62040401
<b>description</b>	temperature probe PTC 2kOhm cable PVC probe -50 up to +150°C cable -10 up to 100°C connection plug thread probe ø5x60mm cable length 1.8m		



<b>GEV No.</b>	402008	<b>Ref. No.</b>	62040402
<b>description</b>	temperature probe PTC 2kOhm cable PVC probe -50 up to +150°C cable -10 up to 100°C connection plug thread probe ø6x50mm cable length 1.2m		



<b>GEV No.</b>	402191	<b>Ref. No.</b>	62040401 62040411 62040418
<b>description</b>	temperature probe PTC 2kOhm cable TPE probe -50 up to +150°C cable -40 up to +110°C connection plug thread probe ø5x20mm cable length 1.8m		
<b>For models:</b>	SP405, SPR80		



<b>GEV No.</b>	402005	<b>Ref. No.</b>	620404.00 62040410
<b>description</b>	temperature probe PTC 2kOhm cable TPE probe -50 up to +150°C cable -40 up to +110°C connection plug thread probe ø6x50mm cable length 1.6m		
<b>For models:</b>	SP405, SPR80		

## Hall sensors



<b>GEV No.</b>	402044	<b>Ref. No.</b>	62040403
<b>description</b>	Hall sensor L 29mm W 26mm H 26mm mounting distance 10mm cable length 1250mm		
<b>For models:</b>	SP405, SPR80		

## accessories

### miscellaneous



<b>GEV No.</b>	402040	<b>Ref. No.</b>	62040404 62040413
<b>description</b>	cable for level electrode cable length 1800mm		
<b>For models:</b>	SP405, SPR80		

## electronics

### housing for PCBs



<b>GEV No.</b>	695663	<b>Ref. No.</b>	660546.00 CM29070021
<b>description</b>	housing PCB L 230mm W 142mm H 57mm		
<b>For models:</b>	SP405		



<b>GEV No.</b>	694206	<b>Ref. No.</b>	660547.00 660547.01 660547.02 CM19190403
<b>description</b>	lid PCB L 180mm W 110mm H 9mm		
<b>For models:</b>	SP405		

<b>accessories for</b>	694206	<b>GEV No.</b>	694205	<b>Ref. No.</b>	—
					housing PCB L 180mm W 110mm H 40mm



1

<b>GEV No.</b>	694796	<b>Ref. No.</b>	CM29015057
<b>description</b>	lid PCB L 205mm W 125mm H 14mm plastic		

PCBs

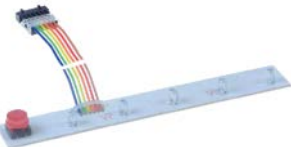

1

<b>GEV No.</b>	401805	<b>Ref. No.</b>	CM33580151
<b>description</b>	display PCB ice maker N201/N301//N501 L 170mm W 25mm		

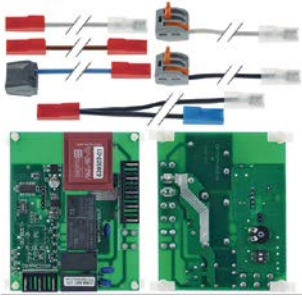

1

<b>GEV No.</b>	403687	<b>Ref. No.</b>	06076900 62044100
<b>description</b>	electronic timer for ice maker Simag mounting measurements 90x70mm 230		
<b>For models:</b>	SD22, SD23, SD30, SDN25		



1

<b>GEV No.</b>	403486	<b>Ref. No.</b>	62050700
<b>description</b>	electronic timer L 73mm W 73mm suitable for Simag H 30mm timer		

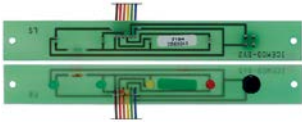

1

<b>GEV No.</b>	401801	<b>Ref. No.</b>	CM33580024
<b>description</b>	keypad PCB ice maker N200/N300/N500		



1

<b>GEV No.</b>	403499	<b>Ref. No.</b>	CM33580173
<b>description</b>	PCB 230V L 90mm W 60mm for ice maker		



1

<b>GEV No.</b>	402137	<b>Ref. No.</b>	02003707.21 11000539.21 11000539.51
<b>description</b>	PCB for float switch		



1

<b>GEV No.</b>	402003	<b>Ref. No.</b>	620403.05 620403.16 620403.17
<b>description</b>	PCB ice maker AC045/055		



1

<b>GEV No.</b>	403478	<b>Ref. No.</b>	620507-01
<b>description</b>	PCB ice maker L 90mm W 72mm suitable for Simag H 30mm		







1

<b>GEV No.</b>	401799	<b>Ref. No.</b>	CM33580150	
<b>description</b>	PCB ice maker N201/N301//N501 230V			
<b>accessories for</b>	401799			
	<b>GEV No.</b>	701450	<b>Ref. No.</b>	—
	connection cable L 1300mm 2-pole level sensor suitable for ice maker connection plug plug type coded plug			



			
1			
<b>GEV No.</b>	403881	<b>Ref. No.</b>	620462 11 620462 20
<b>description</b>	PCB L 200mm W 135mm		

central units

			
1			
<b>GEV No.</b>	402004	<b>Ref. No.</b>	06711.10 620403.09 62040303 620456.02 620462.02
<b>description</b>	control box		
<b>For models:</b>	SP405, SPR80		
<b>accessories for</b>	402004		
	<b>GEV No.</b>	402005	<b>Ref. No.</b> 620404.00 62040410
	temperature probe PTC 2kOhm cable TPE probe -50 up to +150°C cable -40 up to +110°C connection plug thread probe ø6x50mm cable length 1.6m		
	<b>GEV No.</b>	402044	<b>Ref. No.</b> 62040403
	Hall sensor L 29mm W 26mm H 26mm mounting distance 10mm cable length 1250mm		
	<b>GEV No.</b>	402191	<b>Ref. No.</b> 62040401 62040411 62040418
	temperature probe PTC 2kOhm cable TPE probe -50 up to +150°C cable -40 up to +110°C connection plug thread probe ø5x20mm cable length 1.8m		

			
1			
<b>GEV No.</b>	401841	<b>Ref. No.</b>	0A037703.21 12002543.21 12002543.24 12002838.21 12002838.22 12002838.23 12002838.24 17002389.01
<b>description</b>	control box for ice-cube maker 24V 50-60Hz		

			
1			
<b>GEV No.</b>	403836	<b>Ref. No.</b>	81414543/0 CM81414543/0
<b>description</b>	control box ice maker suitable for ICEMATIC/SCOTSMAN/SIMAG		

			
1			
<b>GEV No.</b>	403837	<b>Ref. No.</b>	81400264/0 CM81400264/0
<b>description</b>	control box ice maker suitable for ICEMATIC/SCOTSMAN/SIMAG		

			
1			
<b>GEV No.</b>	402042	<b>Ref. No.</b>	001028.09 001028.09R 028640.98 060711.00 620403.01 620403.18 620403.20 620456.00 620462.00 620462.06
<b>description</b>	control box suitable for SFT 012		

			
1			
<b>GEV No.</b>	401832	<b>Ref. No.</b>	060711.30 785104.02R
<b>description</b>	control box with housing for ice-cube maker 230V		



## solenoid valves

## solenoid valves (water)

## ELBI



1

<b>GEV No.</b>	370431	<b>Ref. No.</b>	CM19865518
<b>description</b>	solenoid valve single straight 230VAC inlet 3/4" outlet 11.5mm input/min output 2l/min DN10 t.max. 90°C ELBI plastic		



1

<b>GEV No.</b>	370414	<b>Ref. No.</b>	650105.54 CM19865502 Z11D003
<b>description</b>	solenoid valve single straight 230VAC inlet 3/4" outlet 11.5mm output 2l/min 50/60Hz t.max. 90°C ELBI plastic flow regulating valve outlet white		



1

<b>GEV No.</b>	370459	<b>Ref. No.</b>	Z11D003
<b>description</b>	solenoid valve single straight 230VAC inlet 3/4" outlet 11.5mm output 2l/min DN10 t.max. 90°C ELBI plastic flow regulating valve outlet white		



1

<b>GEV No.</b>	370421	<b>Ref. No.</b>	Z1CW030
<b>description</b>	solenoid valve double straight 230VAC inlet 3/4" outlet 11.5mm input 5.5l/min output 1/-l/min DN10 t.max. 90°C ELBI plastic flow regulating valve inlet yellow output A 2l/min flow regulating valve outlet A white		
<b>For models:</b>	SD23		



1

<b>GEV No.</b>	370461	<b>Ref. No.</b>	CM19865509
<b>description</b>	solenoid valve double straight 230VAC inlet 3/4" outlet 11.5mm input/min output -/4,7l/min DN10 t.max. 90°C ELBI plastic output B 4.7l/min flow regulating valve outlet B grey output A w/t membrane (constantly open)		



1

<b>GEV No.</b>	370433	<b>Ref. No.</b>	650105.62 650105.70 65010551
<b>description</b>	solenoid valve double straight 230VAC inlet 3/4" outlet 11.5mm input/min output 2/2.5l/min DN10 t.max. 90°C ELBI plastic output A 2l/min output B 2.5l/min flow regulating valve outlet A white flow regulating valve outlet B orange		
<b>For models:</b>	SD18, SD22, SD23, SD30, SDN25		

## spare parts and accessories

## reducers

## outlet side



1

<b>GEV No.</b>	371261	<b>Ref. No.</b>	650105.20
<b>description</b>	reducer ELBI type EATON (INVENSYS) flow rate 1.2l/min pressure range 0 up to 10bar tolerance ±15/25% clear		
<b>For models:</b>	SD23, SD30		





1

<b>GEV No.</b>	371061	<b>Ref. No.</b>	640022.02
<b>description</b>	reducer ELBI type EATON (INVENSYS) flow rate 1.4l/min ø 7.2mm pressure range 0 up to 10bar tolerance ±15/25% clear		





			
1			
<b>GEV No.</b>	371262	<b>Ref. No.</b>	650105.21
<b>description</b>	reducer ELBI type EATON (INVENSYS) flow rate 2.5l/min pressure range 0 up to 10bar tolerance ±15/25% orange		
<b>For models:</b>	SD23, SD30		

			
1			
<b>GEV No.</b>	371263	<b>Ref. No.</b>	650105.22
<b>description</b>	reducer ELBI type EATON (INVENSYS) flow rate 4.7l/min pressure range 0 up to 10bar tolerance ±15/25% grey		

			
1			
<b>GEV No.</b>	371295	<b>Ref. No.</b>	640022.01
<b>description</b>	reducer flow rate 0.8l/min ø 7.2mm pressure range 0 up to 10bar tolerance ±15/25% black		

			
1			
<b>GEV No.</b>	371062	<b>Ref. No.</b>	640022.00
<b>description</b>	reducer flow rate 1.8l/min		

			
1			
<b>GEV No.</b>	371063	<b>Ref. No.</b>	640022.03 640022.04
<b>description</b>	reducer flow rate 2.5l/min ø 7.2mm pressure range 0 up to 10bar tolerance ±15/25% clear		

			
1			
<b>GEV No.</b>	371057	<b>Ref. No.</b>	650105.23
<b>description</b>	reducer type EATON (INVENSYS) flow rate 2l/min pressure range 0 up to 10bar tolerance ±15/25% white		

**ROBERTSHAW/INVENSYS**

*medium temperature:* 90°C 90°C 60°C  
*ambient temperature:* 60°C 25°C 60°C  
*duty cycle:* 40% 100% 100%

various

			
1			
<b>GEV No.</b>	371259	<b>Ref. No.</b>	198655.98 640406.01 CM19865532
<b>description</b>	solenoid valve single angled 230VAC inlet 11.5 outlet 11.5mm DN7 plastic		

**RPE**

special outlet

			
1			
<b>GEV No.</b>	370453	<b>Ref. No.</b>	060564.00 620460.00 620460.01 CM19865598
<b>description</b>	solenoid valve single angled 230VAC inlet 11.5mm outlet 11.5mm RPE		

**TP**



			
1			
<b>GEV No.</b>	370015	<b>Ref. No.</b>	620213.00
<b>description</b>	solenoid valve single angled 230VAC inlet 3/4" outlet 11.5mm DN10 TP		
<b>accessories for</b>	370015		
	<b>GEV No.</b>	371220	<b>Ref. No.</b> —
	reducer TP flow rate 3l/min red tolerance ±15%		

Table continues overleaf





accessories for		370015		
	GEV No.	371221	Ref. No.	—
reducer TP flow rate 5.5l/min yellow tolerance ±15%				
	GEV No.	371222	Ref. No.	—
reducer TP flow rate 6l/min grey tolerance ±15%				
	GEV No.	371223	Ref. No.	—
reducer TP flow rate 10l/min white tolerance ±15%				
	GEV No.	371224	Ref. No.	—
reducer TP flow rate 12l/min bronze tolerance ±15%				
	GEV No.	371225	Ref. No.	—
reducer TP flow rate 16l/min light brown tolerance ±15%				
	GEV No.	371226	Ref. No.	—
reducer TP flow rate 20l/min red tolerance ±15%				
	GEV No.	371230	Ref. No.	—
reducer TP flow rate 0.25l/min red tolerance ±25%				
	GEV No.	371231	Ref. No.	—
reducer TP flow rate 0.35l/min violet tolerance ±25%				
	GEV No.	371232	Ref. No.	—
reducer TP flow rate 0.5l/min orange tolerance ±25%				
	GEV No.	371233	Ref. No.	—
reducer TP flow rate 0.8l/min white tolerance ±25%				
	GEV No.	371234	Ref. No.	—
reducer TP flow rate 1l/min light blue tolerance ±25%				
	GEV No.	371235	Ref. No.	—
reducer TP flow rate 1.2l/min brown tolerance ±25%				
	GEV No.	371236	Ref. No.	—
reducer TP flow rate 1.5l/min light brown tolerance ±25%				
	GEV No.	371237	Ref. No.	—
reducer TP flow rate 2.5l/min yellow tolerance ±25%				
	GEV No.	371238	Ref. No.	—
reducer TP flow rate 3.4l/min dark green tolerance ±25%				
	GEV No.	371239	Ref. No.	—
reducer TP flow rate 5l/min black tolerance ±25%				
	GEV No.	371240	Ref. No.	—
reducer TP flow rate 8l/min blue tolerance ±20%				

## solenoid valves with reducers



<b>GEV No.</b>	370452	<b>Ref. No.</b>	481928128177 481928128226
<b>description</b>	solenoid valve double angled 230VAC inlet 3/4" input 5.5l/min t.max. 90°C TP plastic flow regulating valve inlet yellow outlet 11.5mm output A 1.5l/min output B 1.5l/min flow regulating valve outlet A light brown flow regulating valve outlet B light brown		



<b>GEV No.</b>	370416	<b>Ref. No.</b>	CM19865530
<b>description</b>	solenoid valve double straight 230VAC inlet 3/4" input/min output 1.2/1.2l/min DN10 t.max. 90°C TP plastic outlet 11.5mm output A 1.2l/min output B 1.2l/min flow regulating valve outlet A dark brown flow regulating valve outlet B dark brown		



<b>GEV No.</b>	370422	<b>Ref. No.</b>	65010570
<b>description</b>	solenoid valve double straight 230VAC inlet 3/4" t.max. 90°C TP plastic outlet 11.5mm output A 2.5l/min flow regulating valve outlet A yellow flow regulating valve outlet B brown		





## various



<b>GEV No.</b>	370496	<b>Ref. No.</b>	CM19865525
<b>description</b>	solenoid valve straight 220VAC outlet 14mm plastic inlet 14mm		



metal			
PARKER			
spare parts and accessories			
solenoid coils			
			
<b>GEV No.</b>	371098	<b>Ref. No.</b>	62030628 62030648 63030628.01
<b>description</b>	solenoid coil 220-230VAC 50/60Hz seat ø 14mm cable length 1000mm 14W		
<b>For models:</b>	SD18, SD22, SD23, SD30, SDN25		

<b>accessories for</b>	370382		
	<b>GEV No.</b>	371090	<b>Ref. No.</b> —
	power socket plug type DIN 43650A screw		
	<b>GEV No.</b>	371301	<b>Ref. No.</b> —
	solenoid coil CASTEL 110VAC 8VA 50/60Hz seat ø 11.5mm connection DIN 43650A type HF2		
	<b>GEV No.</b>	371314	<b>Ref. No.</b> —
	solenoid coil CASTEL 240VAC 8VA 50/60Hz seat ø 11.5mm		
	<b>GEV No.</b>	371321	<b>Ref. No.</b> —
	solenoid coil CASTEL 12/24VAC 50/60Hz seat ø 11.5mm connection DIN 43650A type HF2		



**drain valves**

			
<b>GEV No.</b>	371106	<b>Ref. No.</b>	11000514.30 1100514.01
<b>description</b>	drain solenoid valve 208/230V single inlet 17.5mm outlet 16mm EATON (INVENSYS) plastic		



			
<b>GEV No.</b>	370691	<b>Ref. No.</b>	CM81454760
<b>description</b>	solenoid valve angled 220-240V kit inlet 17.5mm outlet 16mm		

**solenoid valves (refrigeration)**



CASTEL			
valve bodies			
STANDARD series			
<i>suitable for refrigerants R22, R134a, R404A, R407C, R410A, R507</i>			

			
<b>GEV No.</b>	370382	<b>Ref. No.</b>	CM19863034
<b>description</b>	solenoid valve body NC type 1028/M10S p max 45bar connection 10mm soldering connection DN 3mm -35 up to +105°C L 125mm refrigeration straight CASTEL		
<b>accessories for</b>	370382		
	<b>GEV No.</b>	371084	<b>Ref. No.</b> —
	solenoid coil CASTEL 230VAC 8VA 50/60Hz connection cable 1000mm type CM2		

**PARKER valves**

			
<b>GEV No.</b>	370415	<b>Ref. No.</b>	CM19863032 CM19863033
<b>description</b>	solenoid valve straight 230V pressure range 0-10bar DN2.5 connection 4mm soldering connection PARKER refrigeration		
<b>spare parts for</b>	370415		
	<b>GEV No.</b>	371033	<b>Ref. No.</b> —
	solenoid coil PARKER 230VAC 9VA coil type YB09 with cable seat ø 14mm		

**valve bodies**

			
<b>GEV No.</b>	370536	<b>Ref. No.</b>	620306.07
<b>description</b>	solenoid valve body p max 35bar connection 3/8" US PARKER for ice maker tube ø 10mm hot gas		
<b>accessories for</b>	370536		
	<b>GEV No.</b>	371098	<b>Ref. No.</b> 62030628 62030648 63030628.01
	solenoid coil 220-230VAC 50/60Hz seat ø 14mm cable length 1000mm 14W		

various

valves



<b>GEV No.</b>	370425	<b>Ref. No.</b>	Z1FR047
<b>description</b>	solenoid valve angled DN1.9 connection 6mm 230V		

valve bodies



<b>GEV No.</b>	370429	<b>Ref. No.</b>	62030627
<b>description</b>	solenoid valve body angled DN 2.5mm connection 6mm soldering connection refrigeration		
<b>accessories for</b>	370429		
	<b>GEV No.</b>	371098	<b>Ref. No.</b>
			62030628 62030648 63030628.01
	solenoid coil 220-230VAC 50/60Hz seat ø 14mm cable length 1000mm 14W		



<b>GEV No.</b>	370458	<b>Ref. No.</b>	62030614
<b>description</b>	solenoid valve body connection 6mm soldering connection refrigeration angled 90°		
<b>For models:</b>	SD22, SD23, SD30, SDN25		



<b>GEV No.</b>	370424	<b>Ref. No.</b>	62030622
<b>description</b>	solenoid valve body DN 1.9mm connection 6mm soldering connection refrigeration angled 90°		
<b>For models:</b>	SD23, SD30		



<b>GEV No.</b>	370454	<b>Ref. No.</b>	620306.46
<b>description</b>	solenoid valve body DN 3mm connection 6mm soldering connection refrigeration angled 90°		
<b>accessories for</b>	370454		
	<b>GEV No.</b>	371033	<b>Ref. No.</b>
			—
	solenoid coil PARKER 230VAC 9VA coil type YB09 with cable seat ø 14mm		

## pressure switches

### for refrigeration

#### SAGI NO MIYA



<b>GEV No.</b>	539002	<b>Ref. No.</b>	620075.02
<b>description</b>	pressure control switch pressure 16bar reset automatic type HTB-3UA12 connection 2.4mm		

#### JOHNSON CONTROLS



<b>GEV No.</b>	541116	<b>Ref. No.</b>	62007500 62007505 62049901 Z1EL005
<b>description</b>	pressure control HD switch pressure 10bar reset automatic switching diff. 1.1bar pressure range 7-29bar p max 38bar refrigeration type P20EA-9950C connection soldering connection 6.35mm CO JOHNSON CONTROLS pressure connection soldering connection 6.35mm		
<b>For models:</b>	SD18, SD22, SD23, SD30, SDN25		



<b>GEV No.</b>	541117	<b>Ref. No.</b>	620231.00 620231.01
<b>description</b>	pressure control HD switch pressure 24bar reset manual switching diff. 4.7bar pressure range 7-29bar p max 38bar refrigeration type P20GA-9950T connection male faston 6.3mm CO JOHNSON CONTROLS pressure connection soldering connection 6.35mm		



## compressors

ACC/ZEL

R134A

HMBP monophase

High/Medium evaporation temperature above -20/-15 °C



<b>GEV No.</b>	605012	<b>Ref. No.</b>	670100.02 670105.07 CM19165497
<b>description</b>	compressor coolant R134a type GL45TB 220-240V 50Hz HMBP fully hermetic 8.4kg 1/6HP power input 342W cylinder capacity 4.5cm <sup>3</sup> CSIR H 175.5mmW 76W 101W 134W 175W 223W 278W 342W 413W test method ASHRAE ambient temperature max. 43°C		
<b>For models:</b>	SD18		

L'UNITE HERMETIQUE / TECUMSEH

R404A

LBP 3-phase

Lower evaporation temperature below -20°C



<b>GEV No.</b>	605187	<b>Ref. No.</b>	670099.15
<b>description</b>	compressor coolant R404A type TAJ2464Z 400V 50/60Hz LBP 22.5kg 1.5HP cylinder capacity 34.4cm <sup>3</sup> TRI H 282mm 1108W 1579W 1850W 2317W 2855WWWW test method EN 12900		

HMBP monophase

High/Medium evaporation temperature above -20/-15 °C



<b>GEV No.</b>	605065	<b>Ref. No.</b>	670099.05
<b>description</b>	compressor coolant R404A type CAJ4519Z 220-240V 50Hz HMBP 24kg 1.5HP cylinder capacity 34.4cm <sup>3</sup> CSR H 282mmWWW 1769W 2353W 3009W 3756W 4360W 5200W		
<b>For models:</b>	SP405		

## fans

refrigeration fans





refrigeration motors universal

ELCO

N series - multi fit





<b>GEV No.</b>	601427	<b>Ref. No.</b>	62041902
<b>description</b>	fan motor ELCO 10W 230V 50/60Hz bearing slide bearing L1 49mm L2 59mm L3 86.5mm W 83mm connection cable 500mm 1300/1550rpm 5 mounting options VNT10-20/028		
<b>For models:</b>	SD18, SD22, SD23, SD30, SDN25, SPR80		

<b>spare parts for</b>	601427			
	<b>GEV No.</b>	560140	<b>Ref. No.</b>	—
	hexagonal nut thread M4 H 4.8mm SS WS 7 Qty 20 pcs DIN/ISO DIN 985 self-locking			
	<b>GEV No.</b>	560332	<b>Ref. No.</b>	—
	plain washer ID ø 4.3mm ED ø 9mm thickness 0.8mm SS Qty 1 pcs			
	<b>GEV No.</b>	560340	<b>Ref. No.</b>	—
	hexagonal nut thread M4 H 3.2mm WS 7 SS DIN/ISO DIN 934 / ISO 4032/8673 Qty 1 pcs			
	<b>GEV No.</b>	601413	<b>Ref. No.</b>	—
	fixing plate suitable for fanwheel ED ø 32mm shaft ø 7 mounting distance 26mm			

**1**

<b>GEV No.</b>	601430	<b>Ref. No.</b>	620419.00 CS1761101602
<b>description</b>	fan motor ELCO 5W 230V 50/60Hz bearing slide bearing L1 48mm L2 52mm L3 79.5mm W 83mm connection cable 500mm 1300/1550rpm 5 mounting options VNT5-13/027		
<b>spare parts for</b>	601430		
	GEV No.	560140	Ref. No. —
	hexagonal nut thread M4 H 4.8mm SS WS 7 Qty 20 pcs DIN/ISO DIN 985 self-locking		
	GEV No.	560332	Ref. No. —
	plain washer ID ø 4.3mm ED ø 9mm thickness 0.8mm SS Qty 1 pcs		
	GEV No.	560340	Ref. No. —
	hexagonal nut thread M4 H 3.2mm WS 7 SS DIN/ISO DIN 934 / ISO 4032/8673 Qty 1 pcs		
	GEV No.	601413	Ref. No. —
	fixing plate suitable for fanwheel ED ø 32mm shaft ø 7 mounting distance 26mm		

**IMPORT**  
multi fit fan motors



**1**

<b>GEV No.</b>	601023	<b>Ref. No.</b>	620233.00 620419.04
<b>description</b>	fan motor 16W 230V 50-60Hz L1 45mm L2 61mm L3 92mm W 84mm cable length 500mm 1300rpm YZF16-25-18/26 5 mounting options bearing slide bearing		
<b>For models:</b>	SP405		

miscellaneous



**1**

<b>GEV No.</b>	601431	<b>Ref. No.</b>	60413.00 620300.06 620419.06 620419.07
<b>description</b>	fan motor 35W 230V		
<b>For models:</b>	SP405		



**1**

<b>GEV No.</b>	601524	<b>Ref. No.</b>	CM18562524
<b>description</b>	fan motor 35W 230V 50/60Hz L3 153mm W 83mm cable length 1600mm 1300rpm with capacitor capacitor 2.5µF		

accessories

fan wheels

aluminium

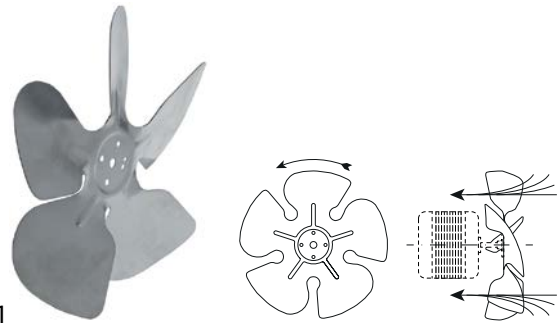

**1**

<b>GEV No.</b>	601070	<b>Ref. No.</b>	620007.05 620419.31
<b>description</b>	fan wheel sucking ø 200mm fan wheel mounting 25.4mm blade angle 28° W 38mm aluminium		



1

<b>GEV No.</b>	601282	<b>Ref. No.</b>	62041932
<b>description</b>	fan wheel sucking ø 200mm fan wheel mounting 25.4mm blade angle 34° W 44mm aluminium		
<b>For models:</b>	SD22, SD23, SD30, SDN25, SPR80		

1

<b>GEV No.</b>	601387	<b>Ref. No.</b>	620419.34
<b>description</b>	fan wheel sucking ø 254mm fan wheel mounting 25.4mm blade angle 34° W 50mm aluminium		
<b>For models:</b>	SP405		

1

<b>GEV No.</b>	601071	<b>Ref. No.</b>	62041931
<b>description</b>	fan wheel sucking ø 230mm fan wheel mounting 25.4mm blade angle 25° W 37mm aluminium		

1

<b>GEV No.</b>	601410	<b>Ref. No.</b>	6200000.03 620419.36
<b>description</b>	fan wheel sucking ø 300mm fan wheel mounting 25.4mm blade angle 28° W 45mm aluminium		

1

<b>GEV No.</b>	601283	<b>Ref. No.</b>	620419.33
<b>description</b>	fan wheel sucking ø 230mm fan wheel mounting 25.4mm blade angle 28° W 41mm aluminium		

cooling motors (complete)



1

<b>GEV No.</b>	500674	<b>Ref. No.</b>	Z1FR009
<b>description</b>	fan		
<b>For models:</b>	SD23		



cold air circulating fans (other)



1

<b>GEV No.</b>	601554	<b>Ref. No.</b>	620273.00 620273.03 620490.00
<b>description</b>	fan motor 230V 50-60Hz 100W W 105mm H 105mm D 220mm shaft L 80mm shaft ø 12mm EURO MOTORS type 10111-40100 cable length 1500mm 1100rpm		

for sumps



1

<b>GEV No.</b>	500410	<b>Ref. No.</b>	CM19440065
<b>description</b>	float motor LIP 11W 230V 50Hz 0.7rpm shaft ø 7mm shaft length 20mm W 72mm H 110mm 010		



1

<b>GEV No.</b>	500786	<b>Ref. No.</b>	CM81404024
<b>description</b>	float motor LIP 11W 230V 50Hz 1rpm shaft ø 8mm W 100mm H 90mm for ice maker L 130mm		
<b>spare parts for</b>	500786		
	<b>GEV No.</b>	695670	<b>Ref. No.</b> CM25260000
	disc for pan tilting ø 100mm shaft intake ø 7mm		



1

<b>GEV No.</b>	500409	<b>Ref. No.</b>	CM19440063
<b>description</b>	float motor LIP type 001 11W 220/240V voltage 50/60 0.7rpm shaft ø 7mm shaft length 20mm W 71mm H 62mm L 110mm		



1

<b>GEV No.</b>	500411	<b>Ref. No.</b>	CM19440057
<b>description</b>	gear motor BITRON type 97103 11W 230V 50Hz 0.7rpm shaft ø 7mm shaft length 30mm W 72mm H 60mm L 116mm		

motors

gear motors

for ice-cube maker

for paddles



1

<b>GEV No.</b>	501472	<b>Ref. No.</b>	IOM916103101
<b>description</b>	gear motor CROUZET type SP-1905-40 3W 230V 50-60Hz 2rpm shaft ø 5x4mm groove width 17mm shaft ø 4.7mm icemaker		



1

<b>GEV No.</b>	500407	<b>Ref. No.</b>	CM19440059
<b>description</b>	gear motor LIP type 123MR 8W 220/240V voltage AC 50/60Hz 50rpm turn direction counterclockwise shaft ø 4mm shaft intake ø 6.2mm groove width 2.3mm shaft L 8mm shaft ø 4mm W 74mm		

1

<b>GEV No.</b>	500412	<b>Ref. No.</b>	CM19440073
<b>description</b>	gear motor LIP type 021B 11W 230V 50Hz 1rpm shaft ø 7mm shaft length 20mm W 74mm D 67mm H 110mm for sump		



1

<b>GEV No.</b>	500752	<b>Ref. No.</b>	62043002
<b>description</b>	pump GRE 60W 230V 60Hz inlet ø 16mm outlet ø 21mm L 110mm rotation direction right for ice maker		

miscellaneous





1

<b>GEV No.</b>	499077	<b>Ref. No.</b>	79422513R
<b>description</b>	gear motor type 794225 220V voltage AC 50/60Hz shaft ø 22.2mm L 260mm W 150mm H 245mm for ice maker 120W		
<b>For models:</b>	SPR80		



1

<b>GEV No.</b>	500045	<b>Ref. No.</b>	060491.03 301001 62041500 Z11D009 Z11D039
<b>description</b>	pump GRE type 100W 230V 50Hz inlet ø 24mm outlet ø 21mm L 150mm rotation direction left for ice-cube maker total length 230mm		
<b>For models:</b>	SD23		
<b>spare parts for</b>	500045		
	<b>GEV No.</b>	<b>Ref. No.</b>	—
	 O-ring EPDM thickness 2.62mm ID ø 61.6mm Qty 10 pcs		
<b>accessories for</b>	500045		
	<b>GEV No.</b>	<b>Ref. No.</b>	Z11D043
	 insulation for pump		

## pumps

### pumps for ice machines



1

<b>GEV No.</b>	695417	<b>Ref. No.</b>	Z11D043
<b>description</b>	insulation for pump		
<b>For models:</b>	SD23		



1

<b>GEV No.</b>	501470	<b>Ref. No.</b>	620423.00
<b>description</b>	pump GRE type 100W 230V 50Hz outlet ø 13mm L 137mm rotation direction left icemaker		



1

<b>GEV No.</b>	500200	<b>Ref. No.</b>	Z11D005
<b>description</b>	pump GRE 100W 230V 50Hz inlet ø 24mm outlet ø 23mm L 145mm rotation direction right		



1

<b>GEV No.</b>	500597	<b>Ref. No.</b>	62043003
<b>description</b>	pump GRE type MH50F 60W 230V 50Hz outlet ø 21mm L 110mm rotation direction right for ice maker		



1

<b>GEV No.</b>	500772	<b>Ref. No.</b>	12002586.25
<b>description</b>	pump HARTELL type U21B 230V 50/60Hz outlet ø 19mm L 120mm rotation direction right for ice-cube maker 1/30HP		



1

<b>GEV No.</b>	500047	<b>Ref. No.</b>	62043300 793113.00 793113.27
<b>description</b>	pump REBO type MH30F1 30W 230V 50Hz outlet ø 12.7mm L 135mm rotation direction left		
<b>For models:</b>	SD18, SD22, SD23, SD30, SDN25		



1

<b>GEV No.</b>	500761	<b>Ref. No.</b>	620433.02 620433.07 793113.09
<b>description</b>	pump REBO type MH30F1 30W 230V 50Hz outlet ø 13mm L 135mm rotation direction right for ice maker		



1

<b>GEV No.</b>	501471	<b>Ref. No.</b>	793113.24R
<b>description</b>	pump REBO type MH50F 60W 220-240V 50Hz outlet ø 18.5mm L 136mm rotation direction left icemaker		



1

<b>GEV No.</b>	500204	<b>Ref. No.</b>	67000206
<b>description</b>	pump REBO type MH50F 60W 230V 50Hz inlet ø 19mm outlet ø 19mm L 125mm rotation direction right for ice-cube maker		



1

<b>GEV No.</b>	500048	<b>Ref. No.</b>	793113.03 793113.03R
<b>description</b>	pump REBO type MH50F 60W 230V 50Hz outlet ø 18mm L 137mm rotation direction right for ice maker		



1

<b>GEV No.</b>	500746	<b>Ref. No.</b>	620430.06
<b>description</b>	pump REBO type MH50F 60W 230V 50Hz outlet ø 20mm L 110mm rotation direction right for ice-cube maker		



1

<b>GEV No.</b>	500203	<b>Ref. No.</b>	060523.00 620430.00 670002.12 793146.00
<b>description</b>	pump REBO type MH50F 60W 230V 50Hz outlet ø 21mm L 110mm rotation direction right for ice maker		



			
1			
<b>GEV No.</b>	500046	<b>Ref. No.</b>	0A030625.02 670036.06
<b>description</b>	pump REBO type NR40 40W 230V 50Hz inlet ø 12mm outlet ø 12mm L 75mm rotation direction right for ice-cube maker		

## condensators & interference suppression filters

### operating capacitors

plastic			
			
1			
<b>GEV No.</b>	365018	<b>Ref. No.</b>	620167.24 620167.54
<b>description</b>	operating capacitor capacity 35µF 400V tolerance 5%Hz ambient temperature max. -25 to +85°C ø 45mm L 95mm M8 plastic connection male faston 6.3mm protection		
<b>For models:</b>	SP405		

			
1			
<b>GEV No.</b>	365031	<b>Ref. No.</b>	62029204
<b>description</b>	operating capacitor capacity 4µF 450V tolerance 5% 50/60Hz ambient temperature max. -25 to +85°C ø 31mm L 58mm M8 plastic connection male faston 6.3mm protection		
<b>For models:</b>	SPR80		

## equipment-specific units

### for ice-cube maker

drain systems			
drain fittings			
			
1			
<b>GEV No.</b>	696583	<b>Ref. No.</b>	CM 25685311
<b>description</b>	drain fitting ø 50mm thread 3/4 hose ø 21mm L 55mm straight for ice-cube maker		

filters			
			
1			
<b>GEV No.</b>	695769	<b>Ref. No.</b>	02002809.01 660211.01
<b>description</b>	drain filter thread 7/8" ø 32mm H 10mm		
<b>For models:</b>	SD18, SD23, SD30, SDN25, SPR80		

overflow pipes			
			
1			
<b>GEV No.</b>	696609	<b>Ref. No.</b>	66060100
<b>description</b>	overflow pipe for ice maker tube ø 20mm pipe length 24mm ED ø 24.5mm L 109mm		

			
1			
<b>GEV No.</b>	695047	<b>Ref. No.</b>	660219.01
<b>description</b>	overflow pipe L 78mm straight		
<b>For models:</b>	SD18, SD22, SD23, SD30, SPR80		

ice breakers			
			
1			
<b>GEV No.</b>	696436	<b>Ref. No.</b>	060293.02 060720.00 670041.00 754001.01 754001.02
<b>description</b>	ice breaker ID ø 26mm ED ø 51mm H 59mm brass with ball bearing		
<b>For models:</b>	SPR80		

ice chutes			
ice chutes			
			
1			
<b>GEV No.</b>	695595	<b>Ref. No.</b>	CM25250099
<b>description</b>	ice chute for door L 345mm W 205mm white		



## slide grates

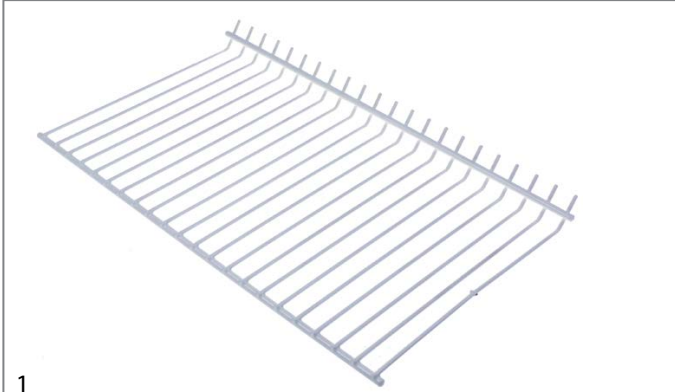

1

<b>GEV No.</b>	694273	<b>Ref. No.</b>	Z1AC003
<b>description</b>	slide grate for ice maker L 395mm W 235mm H 30mm		

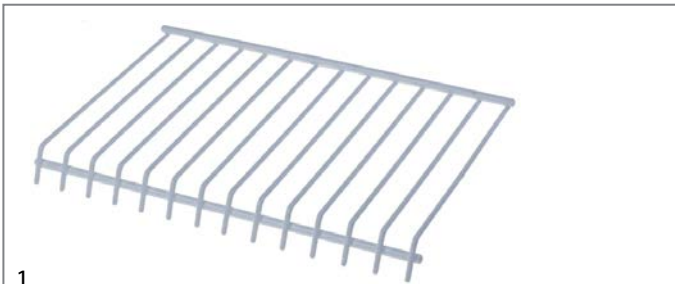

1

<b>GEV No.</b>	694145	<b>Ref. No.</b>	65070500 Z1AC050
<b>description</b>	slide grate for ice-cube maker L 250mm W 170mm H 25mm		
<b>For models:</b>	SD18, SD22, SD23, SDN25		

## ice scoops



1

<b>GEV No.</b>	695244	<b>Ref. No.</b>	650146.00 65092300
<b>description</b>	ice scoop L 220mm W 114mm H 55mm		

## spare parts and accessories



1

<b>GEV No.</b>	695020	<b>Ref. No.</b>	CM25654016
<b>description</b>	disc for pan tilting		

## probes



1

<b>GEV No.</b>	694715	<b>Ref. No.</b>	12002760.21 IOM1011380.78
<b>description</b>	level electrode for ice-cube maker 1-pole cable length 100mm		



1

<b>GEV No.</b>	401764	<b>Ref. No.</b>	CM81453007 CM81453114 CM81453434
<b>description</b>	probe for ice thickness		



1

<b>GEV No.</b>	694714	<b>Ref. No.</b>	02003409.21 0537728.21 11000540.21
<b>description</b>	probe for water level 2-pole		



1

<b>GEV No.</b>	401837	<b>Ref. No.</b>	CM81453590 CM81453796
<b>description</b>	probe for water level 2-pole cable length 85mm		

## spray systems

## SIMAG

## spray arms



1

<b>GEV No.</b>	695480	<b>Ref. No.</b>	65066503
<b>description</b>	spray arm for ice maker		



			
1			
<b>GEV No.</b>	695418	<b>Ref. No.</b>	4114654 65066518 Z1ZA043
<b>description</b>	spray arm L 242mm nozzles 6 for ice maker		
<b>For models:</b>	SD18, SD22, SD23		

			
1			
<b>GEV No.</b>	695463	<b>Ref. No.</b>	65066501
<b>description</b>	spray arm L 242mm nozzles 6 for ice maker		

			
1			
<b>GEV No.</b>	695850	<b>Ref. No.</b>	69573900
<b>description</b>	spray arm L 367mm nozzles 4 for ice maker		

			
1			
<b>GEV No.</b>	695420	<b>Ref. No.</b>	65056520 Z1ZA045
<b>description</b>	spray arm L 385mm nozzles 10 for ice maker		

			
1			
<b>GEV No.</b>	695422	<b>Ref. No.</b>	65066504 Z1ZA051
<b>description</b>	spray arm L 385mm nozzles 10 for ice maker		



			
1			
<b>GEV No.</b>	695419	<b>Ref. No.</b>	65066502 Z1A044
<b>description</b>	spray arm L 385mm nozzles 8 for ice maker		

			
1			
<b>GEV No.</b>	695421	<b>Ref. No.</b>	65066505 Z1ZA048
<b>description</b>	spray arm L 385mm nozzles 8 for ice maker		

			
1			
<b>GEV No.</b>	695477	<b>Ref. No.</b>	65066523
<b>description</b>	spray arm L 420mm nozzles 8 for ice maker		

			
1			
<b>GEV No.</b>	695478	<b>Ref. No.</b>	65066524
<b>description</b>	spray arm L 420mm nozzles 8 for ice maker		

			
1			
<b>GEV No.</b>	695065	<b>Ref. No.</b>	793127.00
<b>description</b>	spray arm L 435mm nozzles 4 for ice maker		

			
1			
<b>GEV No.</b>	695424	<b>Ref. No.</b>	65066506 Z1ZA049
<b>description</b>	spray arm L 570mm nozzles 12 for ice maker		
<b>accessories for</b>	695424		
	<b>GEV No.</b>	695000	<b>Ref. No.</b>
			660558.00 Z11D026
	nozzle for ice-cube maker		

			
1			
<b>GEV No.</b>	695423	<b>Ref. No.</b>	65066508 Z1ZA046
<b>description</b>	spray arm L 570mm nozzles 15 for ice maker		

spray units

			
1			
<b>GEV No.</b>	695442	<b>Ref. No.</b>	793129.05
<b>description</b>	spray system L 273mm W 147mm nozzles 6 complete for ice maker		

			
1			
<b>GEV No.</b>	695443	<b>Ref. No.</b>	793129.04
<b>description</b>	spray system L 273mm W 180mm nozzles 6 complete for ice maker		
<b>spare parts for</b>	695443		
	<b>GEV No.</b>	695063	<b>Ref. No.</b>
			—
	nozzle cap set 3-piece L 111mm W 30mm H 12mm		



1

<b>GEV No.</b>	695444	<b>Ref. No.</b>	793117.00 793129.01
<b>description</b>	spray system L 285mm W 210mm nozzles 6 complete for ice maker		

accessories



1

<b>GEV No.</b>	695068	<b>Ref. No.</b>	11D010 66055700
<b>description</b>	end cap for ice maker insertion size 13x13mm		
<b>For models:</b>	SD18, SD22, SD23, SD30, SD40, SDN25		



1

<b>GEV No.</b>	695060	<b>Ref. No.</b>	660155.03
<b>description</b>	nozzle for ice maker thread 3/8" ø 19.5mm H 13mm		



1

<b>GEV No.</b>	695000	<b>Ref. No.</b>	660558.00 Z11D026
<b>description</b>	nozzle for ice-cube maker		
<b>For models:</b>	SD18, SD22, SD23, SD30, SDN25		



1

<b>GEV No.</b>	695115	<b>Ref. No.</b>	060529.00 060529.01 660519.01 660519.02 660519.03
<b>description</b>	nozzle cap set for ice maker 3-piece L 110mm W 30mm H 12mm		



1

<b>GEV No.</b>	695066	<b>Ref. No.</b>	660475.00
<b>description</b>	spray arm holder for ice maker H 150mm shaft ø 15mm		



1

<b>GEV No.</b>	695061	<b>Ref. No.</b>	660296.02
<b>description</b>	swirl ice cube maker plastic ø 15mm Lmm Wmm H 3.4mm shaft ømm black		

doors

bushes



1

<b>GEV No.</b>	695782	<b>Ref. No.</b>	660286.00
<b>description</b>	bush for door ED ø 12.5mm ID ø 8.2mm L 10.8mm plastic		

doors



1

<b>GEV No.</b>	695743	<b>Ref. No.</b>	CM81460184 CM81460326
<b>description</b>	door for ice maker W 1080mm H 275mm thickness 16mm		



1

<b>GEV No.</b>	695458	<b>Ref. No.</b>	782078.00R
<b>description</b>	door for ice-cube maker W 345mm H 195mm thickness 14mm		



1

<b>GEV No.</b>	695459	<b>Ref. No.</b>	782079.05R 782079.06
<b>description</b>	door for ice-cube maker W 420mm H 200mm thickness 18mm		



1

<b>GEV No.</b>	695457	<b>Ref. No.</b>	781503.00R 792011.02R 79201101
<b>description</b>	door for ice-cube maker W 505mm H 270mm thickness 21mm		



1

<b>GEV No.</b>	695461	<b>Ref. No.</b>	060517.04 060517.05
<b>description</b>	door kit for ice-cube maker W 655mm H 260mm thickness 19mm		



1

<b>GEV No.</b>	696473	<b>Ref. No.</b>	782009.07 792009.09R
<b>description</b>	door W 600mm H 260mm thickness 17mm		



1

<b>GEV No.</b>	695460	<b>Ref. No.</b>	060517.00 060517.01
<b>description</b>	door with door guide for ice-cube maker W 485mm H 260mm thickness 19mm		

door guides



1

<b>GEV No.</b>	695448	<b>Ref. No.</b>	660523.01
<b>description</b>	door guides mounting pos. left L 215/240mm W 14mm		



1

<b>GEV No.</b>	695447	<b>Ref. No.</b>	660523.00
<b>description</b>	door guides mounting pos. right L 215/240mm W 14mm		

curtains

without holder



1

<b>GEV No.</b>	695726	<b>Ref. No.</b>	CM81401600
<b>description</b>	curtain for ice maker W 250mm H 70mm shaft length 270mm shaft ø 6mm		



1

<b>GEV No.</b>	695429	<b>Ref. No.</b>	78317100R
<b>description</b>	curtain for ice maker W 250mm H 70mm shaft length 280mm shaft ø 6mm		
<b>For models:</b>	SD18, SD22, SDN25		



1

<b>GEV No.</b>	695076	<b>Ref. No.</b>	784169.09 784169.09R
<b>description</b>	curtain for ice maker W 284mm H 83mm		



1

<b>GEV No.</b>	695438	<b>Ref. No.</b>	78445700R
<b>description</b>	curtain for ice maker W 293mm H 115mm shaft length 350mm shaft ø 6mm		



1

<b>GEV No.</b>	695075	<b>Ref. No.</b>	784169.01 784169.01R
<b>description</b>	curtain for ice maker W 305mm H 115mm shaft length 323mm shaft ø 6mm		

			
1			
<b>GEV No.</b>	695077	<b>Ref. No.</b>	784169.05 784250.03 784250.03R
<b>description</b>	curtain for ice maker W 570mm H 115mm shaft length 610mm shaft ø 6mm		

accessories

holders

			
1			
<b>GEV No.</b>	695080	<b>Ref. No.</b>	66038800
<b>description</b>	curtain holder for ice maker W 15mm H 80mm left		
<b>For models:</b>	SD18, SD22, SD23, SD30, SDN25		

			
1			
<b>GEV No.</b>	695079	<b>Ref. No.</b>	66038801
<b>description</b>	curtain holder for ice maker W 15mm H 80mm right		
<b>For models:</b>	SD18, SD22, SD23, SD30, SDN25		

lamellas

			
1			
<b>GEV No.</b>	695081	<b>Ref. No.</b>	66062900 Z1AC027
<b>description</b>	lamella for ice maker W 28mm H 71mm ø 6mm		
<b>For models:</b>	SD23		

pan mechanics

sumps

			
1			
<b>GEV No.</b>	695014	<b>Ref. No.</b>	CM81403005
<b>description</b>	sump complete for ice maker L 180mm W 125mm H 80mm shaft L 205mm N20 blue		

			
1			
<b>GEV No.</b>	696414	<b>Ref. No.</b>	CM81401621
<b>description</b>	sump complete for ice maker L 180mm W 125mm H 80mm shaft L 210mm N25 blue		

			
1			
<b>GEV No.</b>	695015	<b>Ref. No.</b>	CM81403007
<b>description</b>	sump complete for ice maker L 225mm W 165mm H 80mm shaft L 255mm for modell N30/N35 white		

			
1			
<b>GEV No.</b>	695017	<b>Ref. No.</b>	CM81413001
<b>description</b>	sump complete for ice maker L 275mm W 220mm H 75mm ICEMATIC white		

			
1			
<b>GEV No.</b>	695016	<b>Ref. No.</b>	CM81414519 CM81423003
<b>description</b>	sump complete for ice maker L 275mm W 220mm white		

			
1			
<b>GEV No.</b>	695019	<b>Ref. No.</b>	CM81442008
<b>description</b>	sump complete for ice maker L 690mm W 230mm H 65mm ICEMATIC		

			
1			
<b>GEV No.</b>	695018	<b>Ref. No.</b>	CM81423002
<b>description</b>	sump complete L 455mm W 180mm H 60mm ICEMATIC		







			
1			
<b>GEV No.</b>	695662	<b>Ref. No.</b>	CM25820125
<b>description</b>	water container for ice maker L 697mm W 260mm H 148mm white		

spare parts and accessories

			
1			
<b>GEV No.</b>	695646	<b>Ref. No.</b>	CM25726279
<b>description</b>	bracket for inner door L 44mm W 20mm H 18mm shaft intake ø 6.3mm mounting distance 30mm		

			
1			
<b>GEV No.</b>	695651	<b>Ref. No.</b>	CM25525419
<b>description</b>	bracket for pulser L 34mm W 15mm H 60mm		

			
1			
<b>GEV No.</b>	695415	<b>Ref. No.</b>	CM25726122
<b>description</b>	bracket for sump mounting pos. right ICEMATIC		

			
1			
<b>GEV No.</b>	695009	<b>Ref. No.</b>	CM25726115
<b>description</b>	bracket paddle L 50mm W 17mm H 23mm shaft intake ø 6.5mm mounting distance 30mm		

			
1			
<b>GEV No.</b>	695681	<b>Ref. No.</b>	CM25110914
<b>description</b>	bush for spindle ED ø 10mm ID ø 6.2mm L 20mm plastic ICEMATIC		

			
1			
<b>GEV No.</b>	695670	<b>Ref. No.</b>	CM25260000
<b>description</b>	disc for pan tilting ø 100mm shaft intake ø 7mm		

			
1			
<b>GEV No.</b>	695479	<b>Ref. No.</b>	CM81413043
<b>description</b>	disc for pan tilting ø 100mm shaft ø 7mm		

			
1			
<b>GEV No.</b>	695023	<b>Ref. No.</b>	CM25325953
<b>description</b>	guide for lever L 30mm W 12mm H 15mm		

			
1			
<b>GEV No.</b>	695025	<b>Ref. No.</b>	CM25440110 CM81403011
<b>description</b>	lever for sump L 143mm W 29mm H 37mm shaft intake ø 10mm plastic ICEMATIC		

			
1			
<b>GEV No.</b>	695027	<b>Ref. No.</b>	CM25545520
<b>description</b>	paddle ø 145mm shaft intake ø 6mm		

			
1			
<b>GEV No.</b>	696527	<b>Ref. No.</b>	CM25545521
<b>description</b>	paddle ø 145mm shaft intake ø 6mm shaft lengthmm 1		

			
1			
<b>GEV No.</b>	695026	<b>Ref. No.</b>	CM25560256
<b>description</b>	pin for lever L 38mm ø 4.5mm metal		

			
1			
<b>GEV No.</b>	695024	<b>Ref. No.</b>	CM25110911
<b>description</b>	roller for pan tilting ø 26.7mm shaft intake ø 8.1mm		

			
1			
<b>GEV No.</b>	695035	<b>Ref. No.</b>	CM25725433 CM25725439
<b>description</b>	shaft intake for paddle motor L 30mm W 17mm H 60mm shaft intake ø 4mm mounting distance 17mm		

1 

<b>GEV No.</b>	695004	<b>Ref. No.</b>	CM25030006
<b>description</b>	spindle for ice maker ø 6mm L 165mm SS		

1 

<b>GEV No.</b>	695005	<b>Ref. No.</b>	CM25030007
<b>description</b>	spindle for ice maker ø 6mm L 206mm		

1 

<b>GEV No.</b>	695006	<b>Ref. No.</b>	CM25030010
<b>description</b>	spindle for ice maker ø 6mm L 315mm SS		

1 

<b>GEV No.</b>	695007	<b>Ref. No.</b>	CM25030011
<b>description</b>	spindle for paddle L 495mm		

1 

<b>GEV No.</b>	695021	<b>Ref. No.</b>	cm25474600
<b>description</b>	torsion spring ø 20.8mm L1 23.2mm L2 37mm wire gauge ø 2.3mm for ice maker		

1 

<b>GEV No.</b>	695022	<b>Ref. No.</b>	CM25474602
<b>description</b>	torsion spring ø 21.2mm L1 26mm L2 37mm wire gauge ø 2.6mm for ice maker		

## gear wheels

1 

<b>GEV No.</b>	691787	<b>Ref. No.</b>	651157.00
<b>description</b>	gear wheel ø 27/101mm shaft intake ø 13mm teeth 15/94		
<b>For models:</b>	SP405		

## suction system

### intake filters



1

<b>GEV No.</b>	695416	<b>Ref. No.</b>	Z1AC012
<b>description</b>	intake filter ø 36mm H 25mm		
<b>For models:</b>	SD23		

## drive technology

### gear wheels



1

<b>GEV No.</b>	694780	<b>Ref. No.</b>	651158.00
<b>description</b>	gear wheel ø 135mm shaft ø 25mm W 19mm teeth 83		
<b>For models:</b>	SP405		



1

<b>GEV No.</b>	695582	<b>Ref. No.</b>	65115600
<b>description</b>	gear wheel teeth 65 tooth width 14.5mm ED ø 74mm H 72mm shaft ø 12.7mm		
<b>For models:</b>	SP405		

## gaskets

### shaft gaskets



1

<b>GEV No.</b>	695589	<b>Ref. No.</b>	0200130021 64004000
<b>description</b>	shaft sealing ED ø 48mm ID ø 25mm H 22mm suitable for augers		
<b>For models:</b>	SPR80		



1

<b>GEV No.</b>	695428	<b>Ref. No.</b>	650402.00
<b>description</b>	shaft sealing for auger ED ø 45mm ID ø 30mm		
<b>For models:</b>	SP405		

miscellaneous

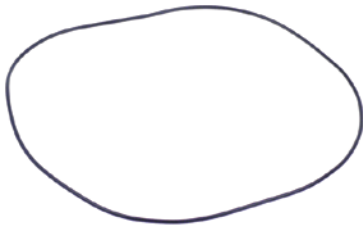

1

<b>GEV No.</b>	697879	<b>Ref. No.</b>	0a026103.01 13000617.38
<b>description</b>	O-ring NBR thickness 2.62mm ID ø 219mm Qty 1 pcs		
<b>For models:</b>	SP405		

insulation



1

<b>GEV No.</b>	694112	<b>Ref. No.</b>	060551.01 660509.02 660509.03
<b>description</b>	insulation for discharge chute L 190mm W 200mm H 175mm		

flaps



1

<b>GEV No.</b>	696392	<b>Ref. No.</b>	CM81453130
<b>description</b>	flap for ice maker W 493mm L 423mm for evaporator		



1

<b>GEV No.</b>	696610	<b>Ref. No.</b>	CM81453131
<b>description</b>	sump for ice maker W 500mm H 70mm L 540mm for evaporator		

mechanics for evaporators

holders



1

<b>GEV No.</b>	694437	<b>Ref. No.</b>	060527.00 060688.00 754008.01
<b>description</b>	bearing block for evaporator kit with holder mounting pos. lower		
<b>For models:</b>	SP405		

gear motors

gearboxes



1

<b>GEV No.</b>	695607	<b>Ref. No.</b>	3212002
<b>description</b>	housing for gearbox		

hoses

formed hoses

form L



1

<b>GEV No.</b>	695089	<b>Ref. No.</b>	Z1CE015
<b>description</b>	formed hose L-shape for ice-cube maker ID ø 12.5/22mm ED ø 18.5/27mm L 300mm W 30mm		



1

<b>GEV No.</b>	695092	<b>Ref. No.</b>	Z1CE016
<b>description</b>	formed hose L-shape for ice-cube maker ID ø 13/21mm ED ø 18/27mm L 345mm W 80mm		



1

<b>GEV No.</b>	695091	<b>Ref. No.</b>	61018901 Z1ID007
<b>description</b>	formed hose L-shape for ice-cube maker ID ø 24mm ED ø 27mm L 130mm W 105mm		

## form S



1

<b>GEV No.</b>	695090	<b>Ref. No.</b>	Z1ID038
<b>description</b>	formed hose S-shape for ice-cube maker ID ø 16/20mm ED ø 21/25mm L 110mm W 75mm		
<b>For models:</b>	SD23		



1

<b>GEV No.</b>	695094	<b>Ref. No.</b>	61021500 Z1ID006
<b>description</b>	formed hose S-shape for ice-cube maker ID ø 16/20mm ED ø 21/26mm L 130mm W 70mm		



1

<b>GEV No.</b>	695093	<b>Ref. No.</b>	Z1ID037
<b>description</b>	formed hose S-shape for ice-cube maker ID ø 20/23mm ED ø 26/29mm L 115mm W 90mm		
<b>For models:</b>	SD23		

## hose connectors

## with thread



1

<b>GEV No.</b>	695051	<b>Ref. No.</b>	Z1AC028
<b>description</b>	hose connector		



1

<b>GEV No.</b>	695045	<b>Ref. No.</b>	660224.00
<b>description</b>	hose connector 3-way ID ø 15mm ED ø 21mm L 91mm		
<b>For models:</b>	SD18, SD22, SD23, SD30, SP405, SPR80		



1

<b>GEV No.</b>	695048	<b>Ref. No.</b>	Z1ID025
<b>description</b>	hose connector for ice-cube maker		
<b>For models:</b>	SD23		



1

<b>GEV No.</b>	695049	<b>Ref. No.</b>	Z1AD011
<b>description</b>	hose connector for ice-cube maker		
<b>For models:</b>	SD23		



1

<b>GEV No.</b>	695109	<b>Ref. No.</b>	Z1AC030
<b>description</b>	hose connector for ice-cube maker		
<b>For models:</b>	SD23		



1

<b>GEV No.</b>	695112	<b>Ref. No.</b>	Z1AC029
<b>description</b>	hose connector for ice-cube maker		
<b>For models:</b>	SD23		



1

<b>GEV No.</b>	695053	<b>Ref. No.</b>	66029100
<b>description</b>	hose connector for ice-cube maker straight grommet ø 11.5mm grommet length 16mm WS 27 thread L 15mm plastic T1: 3/4" T2: 5/8" UNF (3/8" SAE)		



1

<b>GEV No.</b>	695095	<b>Ref. No.</b>	Z1AC029
<b>description</b>	hose connector thread M22 hose ø 16mm plastic for ice-cube maker ID ø 16mm ED ø 22mm L 45mm		

without thread



1

<b>GEV No.</b>	695050	<b>Ref. No.</b>	CM25690806
<b>description</b>	hose connector straight plastic L 70mm ø 21mm		

miscellaneous



1

<b>GEV No.</b>	520447	<b>Ref. No.</b>	733204.00
<b>description</b>	double nipple thread 3/8" - 3/4" L1 24mm L2 12mm		
<b>For models:</b>	SP405, SPR80		

floats

container lids



1

<b>GEV No.</b>	695038	<b>Ref. No.</b>	66036300
<b>description</b>	lid L 150mm W 102mm for float container		
<b>For models:</b>	SP405, SPR80		

float containers



1

<b>GEV No.</b>	695037	<b>Ref. No.</b>	793126.01 793126.03
<b>description</b>	float container for ice maker plastic		
<b>For models:</b>	SP405, SPR80		

miscellaneous



1

<b>GEV No.</b>	691665	<b>Ref. No.</b>	CM25726473
<b>description</b>	bracket for evaporator flap		



1

<b>GEV No.</b>	695630	<b>Ref. No.</b>	06035900 06035902 65041200
<b>description</b>	coupling set ø 37mm		



1

<b>GEV No.</b>	696607	<b>Ref. No.</b>	660483.00
<b>description</b>	flange icemaker H 20mm ED ø 60mm plastic		



1

<b>GEV No.</b>	695660	<b>Ref. No.</b>	CM25300000
<b>description</b>	inlet spout for ice maker ICEMATIC		



1

<b>GEV No.</b>	695417	<b>Ref. No.</b>	Z11D043
<b>description</b>	insulation for pump		
<b>For models:</b>	SD23		



1

<b>GEV No.</b>	695046	<b>Ref. No.</b>	66053500
<b>description</b>	nut H 5mm thread M24x1.5 plastic		
<b>For models:</b>	SD18, SD22, SD23, SD30, SP405, SPR80		



1

<b>GEV No.</b>	695113	<b>Ref. No.</b>	Z1AC014
<b>description</b>	plain washer for ice-cube maker plastic D1 ø 32mm D2 ø 25mm thickness 2mm		
<b>For models:</b>	SD23		





1

<b>GEV No.</b>	695110	<b>Ref. No.</b>	Z1AC013
<b>description</b>	plain washer for ice-cube maker plastic $\varnothing$ 19mm		
<b>For models:</b>	SD23		



1

<b>GEV No.</b>	695764	<b>Ref. No.</b>	72421506
<b>description</b>	probe L 100mm ED $\varnothing$ 4mm thread M3		
<b>For models:</b>	SP405, SPR80		

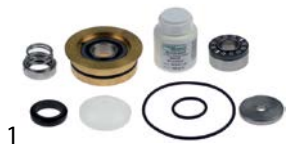

1

<b>GEV No.</b>	695587	<b>Ref. No.</b>	001028.08 060692.01
<b>description</b>	repair kit for ice maker		

**spare parts for** 695587



<b>GEV No.</b>	695588	<b>Ref. No.</b>	—
<b>description</b>	bushing complete H 31.5mm ID $\varnothing$ 30mm ED $\varnothing$ 89mm mounting pos. lower		

## valves

### intake valves



1

<b>GEV No.</b>	696608	<b>Ref. No.</b>	IOM9131111.01
<b>description</b>	intake valve icemaker thread 14 plastic hose $\varnothing$ 35mm W 76mm		



1

<b>GEV No.</b>	695685	<b>Ref. No.</b>	02002217.02 19864010
<b>description</b>	intake valve thread M11 L 130mm $\varnothing$ 37mm plastic		

## for dishwashers

### door mechanics

#### door shafts



1

<b>GEV No.</b>	695575	<b>Ref. No.</b>	Z1AM017
<b>description</b>	door shaft $\varnothing$ 10mm L 458mm icemaker		

## hinges

### piano hinges

#### producer-specific

##### CASTEL



1

<b>GEV No.</b>	701030	<b>Ref. No.</b>	CM19120045
<b>description</b>	hinge controllable L 43mm W 37mm hole $\varnothing$ 4mm for ice container mounting distance 26/32mm plastic		

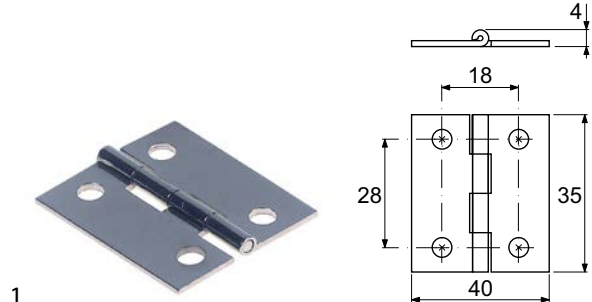

1

<b>GEV No.</b>	691804	<b>Ref. No.</b>	CM19120050
<b>description</b>	hinge L 40mm W 35mm H 4mm mounting distance 28mm hole $\varnothing$ 5mm thickness 1.3mm brass ICEMATIC		

## filters

### air filters



1

<b>GEV No.</b>	694183	<b>Ref. No.</b>	02003485.01
<b>description</b>	air filter L 500mm W 500mm H 20mm		



## equipment feet and end caps

### end caps and plugs

for square pipes

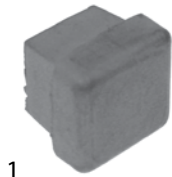

1

<b>GEV No.</b>	695068	<b>Ref. No.</b>	1ID010 66055700
<b>description</b>	end cap for ice maker insertion size 13x13mm		
<b>For models:</b>	SD18, SD22, SD23, SD30, SD40, SDN25		

## gaskets

### refrigeration gaskets

plug-in gaskets

profile 9151

We offer custom-made gaskets for this profile

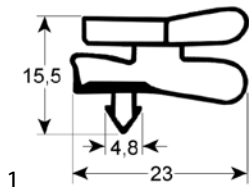

1

<b>GEV No.</b>	900368	<b>Ref. No.</b>	CM28175017
<b>description</b>	refrigeration gasket profile 9151 W 715mm L 1580mm plug size L1 1570mm W1 705mm external size		

## O-rings

EPDM



1

<b>GEV No.</b>	528485	<b>Ref. No.</b>	640100.00
<b>description</b>	O-ring EPDM thickness 1.78mm ID $\phi$ 6.07mm Qty 1 pcs		
<b>For models:</b>	SP405, SPR80		



1

<b>GEV No.</b>	507309	<b>Ref. No.</b>	640081.00 940081.00
<b>description</b>	O-ring EPDM thickness 2.62mm ID $\phi$ 17.13mm Qty 1 pcs		

1

<b>GEV No.</b>	510769	<b>Ref. No.</b>	640041.01
<b>description</b>	O-ring EPDM thickness 2.62mm ID $\phi$ 25.07mm Qty 1 pcs		
<b>For models:</b>	SPR80		

1

**GEV**  
Image not available

<b>GEV No.</b>	532486	<b>Ref. No.</b>	Z1ID042
<b>description</b>	O-ring EPDM thickness 2.62mm ID $\phi$ 61.6mm Qty 1 pcs		
<b>For models:</b>	SD23		

1

<b>GEV No.</b>	511395	<b>Ref. No.</b>	13000617.54
<b>description</b>	O-ring EPDM thickness 2.62mm ID $\phi$ 71.12mm Qty 1 pcs		

1

<b>GEV No.</b>	361085	<b>Ref. No.</b>	CM41020448
<b>description</b>	O-ring EPDM thickness 2mm ID $\phi$ 8mm Qty 1 pcs		

1

<b>GEV No.</b>	511518	<b>Ref. No.</b>	3186143
<b>description</b>	O-ring EPDM thickness 3.53mm ID $\phi$ 23.4mm Qty 10 pcs		

1

<b>GEV No.</b>	510895	<b>Ref. No.</b>	640093.02
<b>description</b>	O-ring EPDM thickness 3.53mm ID $\phi$ 34.52mm Qty 1 pcs		
<b>For models:</b>	SP405		

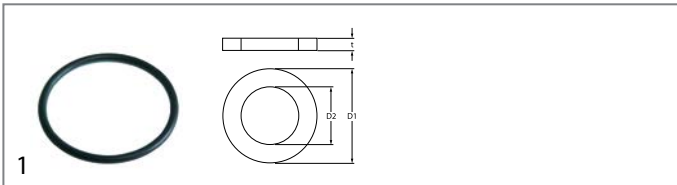

<b>GEV No.</b>	532114	<b>Ref. No.</b>	64004138
<b>description</b>	O-ring EPDM thickness 3.53mm ID ø 50.8mm Qty 10 pcs		

### silicone

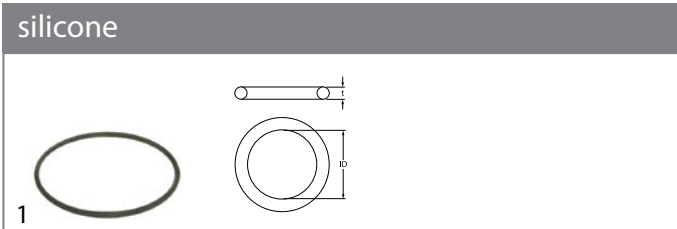

<b>GEV No.</b>	695064	<b>Ref. No.</b>	640041.20
<b>description</b>	O-ring silicone thickness 2mm ID ø 66.4mm Qty 1 pcs		

### NBR

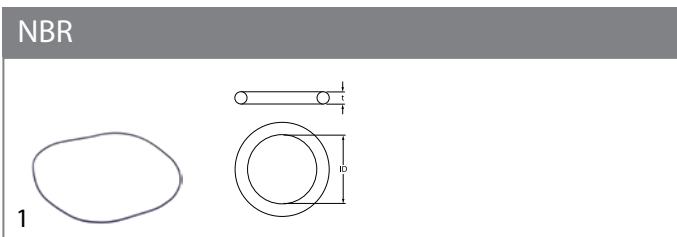

<b>GEV No.</b>	697879	<b>Ref. No.</b>	0a026103.01 13000617.38
<b>description</b>	O-ring NBR thickness 2.62mm ID ø 219mm Qty 1 pcs		
<b>For models:</b>	SP405		

## sealing washers

### rubber gaskets



<b>GEV No.</b>	520054 <sup>1</sup>	<b>Ref. No.</b>	640076.13
<b>description</b>	flat gasket rubber ED ø 23.5mm ID ø 14mm thickness 2.3mm Qty 10 pcs		
<b>For models:</b>	SD23		

<sup>1</sup>Qty 10 pieces

## foam rubber gaskets



<b>GEV No.</b>	508418	<b>Ref. No.</b>	CM19350201
<b>description</b>	foam rubber gasket W 15mm thickness 8mm self-adhesive Qty 1m		



<b>GEV No.</b>	901292	<b>Ref. No.</b>	13000595.00
<b>description</b>	foam rubber gasket W 15mm thickness 8mm self-adhesive Qty supplied by meter		

## shaft gaskets

### shaft gaskets



<b>GEV No.</b>	698239	<b>Ref. No.</b>	02003969.01 640083.00
<b>description</b>	shaft seal ID ø 11.91mm ED ø 18.24mm thickness 5mm		
<b>For models:</b>	SPR80		



<b>GEV No.</b>	511532	<b>Ref. No.</b>	02001606.00
<b>description</b>	shaft seal ID ø 15mm ED ø 25.5mm thickness 6.5mm for ice-cube maker		



<b>GEV No.</b>	511534	<b>Ref. No.</b>	64001901
<b>description</b>	shaft seal ID ø 22mm ED ø 32mm thickness 5.5mm		
<b>For models:</b>	SPR80		



<b>GEV No.</b>	511533	<b>Ref. No.</b>	02002853.01
<b>description</b>	shaft seal ID ø 25mm ED ø 34mm thickness 5mm for ice maker		



## refrigeration cycle components

### cooling water regulators

#### JOHNSON CONTROLS

			
1			
<b>GEV No.</b>	541483	<b>Ref. No.</b>	62011100 79305600R CM19865611 Z1CW018
<b>description</b>	cooling water regulator 3/8" type V46AA-9950 connection 6mm soldering connection pressure range 5-18bar water pressure max. 10bar water temperature max. 90°C capillary pipe 750mm L 160mm 0.9kg		
<b>For models:</b>	SP405, SPR80		





### valves

#### expansion valves

#### DANFOSS

#### valves

#### type TS2/TE2

				
1				
<b>GEV No.</b>	750014	<b>Ref. No.</b>	CM81453620	
<b>description</b>	expansion valve DANFOSS type TS2 coolant R404a/R507 angled 90° thermostatically controlled inlet 3/8" SAE outlet 1/2" SAE p max 34bar -40 up to +10°C capillary pipe 1500mm			
<b>accessories for</b>	750014			
	<b>GEV No.</b>	750020	<b>Ref. No.</b>	—
		nozzle insert size 0X type 068-2002 T/TE 2 DANFOSS		
	<b>GEV No.</b>	750021	<b>Ref. No.</b>	—
		nozzle insert size 00 type 068-2003 T/TE 2 DANFOSS		
	<b>GEV No.</b>	750022	<b>Ref. No.</b>	—
		nozzle insert size 01 type 068-2010 T/TE 2 DANFOSS		
	<b>GEV No.</b>	750023	<b>Ref. No.</b>	—
		nozzle insert size 02 type 068-2015 T/TE 2 DANFOSS		
	<b>GEV No.</b>	750024	<b>Ref. No.</b>	—
		nozzle insert size 03 type 068-2006 T/TE 2 DANFOSS		
	<b>GEV No.</b>	750483	<b>Ref. No.</b>	—
		nozzle insert size 04 type 068-2007 T2/TE2 DANFOSS		
	<b>GEV No.</b>	750484	<b>Ref. No.</b>	—
		nozzle insert size 05 type 068-2008 T2/TE2 DANFOSS		

<b>accessories for</b>	750014			
	<b>GEV No.</b>	750485	<b>Ref. No.</b>	—
	nozzle insert size 06 type 068-2009 T2/TE2 DANFOSS			

#### HONEYWELL

#### valves

			
1			
<b>GEV No.</b>	750445	<b>Ref. No.</b>	62042755
<b>description</b>	expansion valve HONEYWELL type AMVX coolant R404a/R507 nozzle ø 2.5mm inlet 5/8" UNF (3/8" SAE) outlet 3/4" UNF (1/2" SAE) 7/16" UNF (1/4" SAE) p max 3bar capillary pipe 1200mm		

## evaporators

### for ice-cube maker

#### for flake ice maker

			
1			
<b>GEV No.</b>	695752	<b>Ref. No.</b>	79430201R
<b>description</b>	evaporator for flake ice maker H 247mm ø 73mm		
<b>For models:</b>	SPR80		

### accessories

#### housings

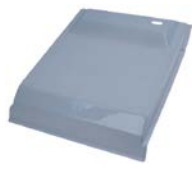
			
1			
<b>GEV No.</b>	696383	<b>Ref. No.</b>	CM25820123/0
<b>description</b>	lid for evaporator for ice maker for N120 L 422mm W 336mm H 60mm		

## condensers

### condensers



<b>GEV No.</b>	750527	<b>Ref. No.</b>	19177073
<b>description</b>	condenser for ice maker W 525mm D 62mm H 490mm		



<b>GEV No.</b>	750125	<b>Ref. No.</b>	62043900
<b>description</b>	condenser W 290mm D 85mm H 260mm		

## transmission technology and ball bearings

### ball bearings

#### ball bearings inch



<b>GEV No.</b>	523001	<b>Ref. No.</b>	02000417.00 02000417.20 02000417.21 670011.01
<b>description</b>	ball bearing type SR14-2RS shaft $\varnothing$ 7/8"mm ED $\varnothing$ 1 7/8"mm W 3/8"mm		
<b>For models:</b>	SPR80		

#### miscellaneous



<b>GEV No.</b>	523514	<b>Ref. No.</b>	651058.00
<b>description</b>	ball bearing type L/3350 shaft $\varnothing$ 25mm ED $\varnothing$ 52mm W 33mm stainless steel		
<b>For models:</b>	SP405		

## springs

### torsion springs



<b>GEV No.</b>	695021	<b>Ref. No.</b>	cm25474600
<b>description</b>	torsion spring $\varnothing$ 20.8mm L1 23.2mm L2 37mm wire gauge $\varnothing$ 2.3mm for ice maker		



<b>GEV No.</b>	695022	<b>Ref. No.</b>	CM25474602
<b>description</b>	torsion spring $\varnothing$ 21.2mm L1 26mm L2 37mm wire gauge $\varnothing$ 2.6mm for ice maker		





## hoses

### drain hoses

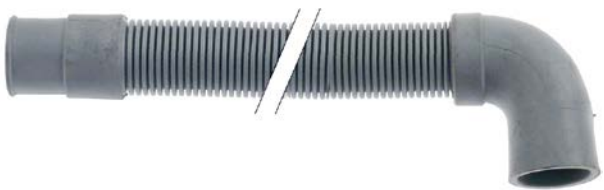

1

<b>GEV No.</b>	530473	<b>Ref. No.</b>	06051301 CM19810114
<b>description</b>	drain hose DN19 L 1900mm straight ø inside 19mm straight ext. ø 25mm elbow ø inside 23mm elbow ext. ø 27mm outer hose ø 24mm for ice maker		

## fittings, hose and pipe connectors

### fittings

#### double nipples



1

<b>GEV No.</b>	520447	<b>Ref. No.</b>	733204.00
<b>description</b>	double nipple thread 3/8" - 3/4" L1 24mm L2 12mm		
<b>For models:</b>	SP405, SPR80		

#### hose connectors

##### producer-specific



1

<b>GEV No.</b>	695053	<b>Ref. No.</b>	66029100
<b>description</b>	hose connector for ice-cube maker straight grommet ø 11.5mm grommet length 16mm WS 27 thread L 15mm plastic T1: 3/4" T2: 5/8" UNF (3/8" SAE)		



1



<b>GEV No.</b>	695050	<b>Ref. No.</b>	CM25690806
<b>description</b>	hose connector straight plastic L 70mm ø 21mm		

## push-in fittings

### JOHN GUEST



1

<b>GEV No.</b>	440652	<b>Ref. No.</b>	651224 04	
<b>description</b>	push-in fitting John Guest straight pipe connection 1/4" - 5/16"			
<b>accessories for</b>	440652			
	<b>GEV No.</b>	520976	<b>Ref. No.</b>	—
	hose 0,17" ext. ø 1/4" John Guest LLDPE blue			
	<b>GEV No.</b>	520977	<b>Ref. No.</b>	—
	hose ID ø 5mm ED ø 8mm John Guest thickness 1.5mm LLDPE blue			

## fastening material

### nuts

#### hexagonal nuts

##### hexagonal nuts metric (without norm)



1

<b>GEV No.</b>	695111	<b>Ref. No.</b>	Z1AC016
<b>description</b>	nut thread M18x1.5 H 7mm WS 27 brass Qty 1 pcs		
<b>For models:</b>	SD23		



1

<b>GEV No.</b>	695114	<b>Ref. No.</b>	Z1AC017
<b>description</b>	nut thread M24x1.5 H 7mm WS 30 brass Qty 1 pcs		
<b>For models:</b>	SD23		

### washers

#### washers

##### miscellaneous



1

<b>GEV No.</b>	695113	<b>Ref. No.</b>	Z1AC014
<b>description</b>	plain washer for ice-cube maker plastic D1 ø 32mm D2 ø 25mm thickness 2mm		
<b>For models:</b>	SD23		



1

<b>GEV No.</b>	695110	<b>Ref. No.</b>	Z1AC013
<b>description</b>	plain washer for ice-cube maker plastic ø 19mm		
<b>For models:</b>	SD23		

## consumables

### lubricants

#### machine lubricants



1

<b>GEV No.</b>	890029	<b>Ref. No.</b>	060294.01
<b>description</b>	machine lubricant Mobilux EP004 can 500g for gearbox -25 up to +120°C		
<b>description</b>	<p>Mobilux EP004 - can 500g</p> <p>Suitable for lubricating enclosed gears and bearings in poorly sealed gear cases with the exception of electric motor bearings. Can also be used for many other industrial applications, e.g. gear cases and chains, in which conventional gear oils would escape due to leaks caused by worn or missing seals. Meets requirements of SEW 1008 hour gear test, DR.EM.2003 mod.</p> <p>Temperature resistance: -25°C to +120°C</p>		
<b>For models:</b>	SP405		

### cleaning agents

#### descalers



1

<b>GEV No.</b>	802164	<b>Ref. No.</b>	100902
<b>description</b>	descaler 4.8l phosphoric acid for ice maker		

<b>C</b>			
cleaning agents	40		
compressors	17		
condensators & interference suppression filters	23		
consumables	40		
cooling water regulators	37		
<b>D</b>			
descalers	40		
double nipples	39		
drain hoses	39		
<b>E</b>			
end caps and plugs	35		
evaporators	37		
expansion valves	37		
<b>F</b>			
fans	17		
fastening material	39		
fittings	39		
float switches	6		
foam rubber gaskets	36		
<b>H</b>			
Hall sensors	9		
hexagonal nuts	39		
hose connectors	39		
hoses	39		
<b>I</b>			
indicator lights	7		
indicator lights (complete)	7		
<b>L</b>			
lamps	7		
lubricants	40		
<b>M</b>			
machine lubricants	40		
magnetic switches	7		
microswitches	6		
motors	20		
<b>N</b>			
nuts	39		
<b>O</b>			
operating capacitors	23		
O-rings	35		
<b>P</b>			
piano hinges	34		
plug-in gaskets	35		
pressure switches	16		
probes	9		
programme timers	7		
pumps	21		
pumps for ice machines	21		
push/momentary push switches	5		
push-in fittings	39		
<b>R</b>			
refrigeration cycle components	37		
refrigeration fans	17		
refrigeration gaskets	35		
refrigeration motors universal	17		
refrigeration thermostats	3		
relays	8		
rocker/momentary rocker switches	5		
<b>S</b>			
sealing washers	36		
shaft gaskets	36		
solenoid valves	12		
switches and momentary switches	5		
<b>T</b>			
thermostats	3		
time relays	8		
timers	7		
toggle switches	6		
touch sensitive light switches	6		
<b>W</b>			
washers	39		