



**GAS COMPONENTS**



**ELECTRIC COMPONENTS**



**WATER TECHNOLOGY**



**MECHANICAL COMPONENTS**



**TOOLS**

Spare parts suitable for

**SIRMAN**

Find the complete and up-to-date range of products in our GEV Webshop



# Manufacturer catalogue

The most important spare parts and accessories arranged clearly for every manufacturer

- ✓ Complete product range and all appliance data always up to date in the GEV Webshop
- ✓ Alphabetical Index at the end of the catalogue

## GEV Webshop

[www.gev-online.co.uk](http://www.gev-online.co.uk)

[www.gev-online.com](http://www.gev-online.com)



- 🔍 Add to Favourites
- 🔍 Sign In with email address and usual password
- 🔍 Easy-order – place several items in your basket at the same time
- 🔍 Quick Item search – no login needed



## heating elements

### heating elements for crepes makers

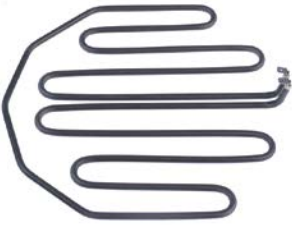

1

<b>GEV No.</b>	418646	<b>Ref. No.</b>	IGS703103
<b>description</b>	heating element 2000W 230V L 270mm W 235mm H 45mm tube ø 6.3mm W2 20mm connection male faston 6.3mm connection distance 229mm crepes maker		
<b>For models:</b>	CREPIERA TONDA		

### heating elements for griddles

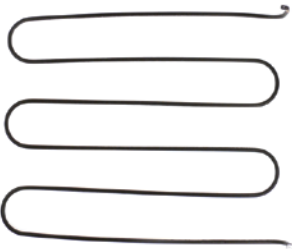

1

<b>GEV No.</b>	418644	<b>Ref. No.</b>	IV5253500
<b>description</b>	heating element 450W 230V heating circuits 1 L 440mm W 350mm H 45mm tube ø 6.3mm warming plate connection distance 344mm		

### heating elements for hot dog machines



1

<b>GEV No.</b>	416487	<b>Ref. No.</b>	ATHD071015
<b>description</b>	heating element 750W 230V L 183mm W 324mm Hmm tube ø 6.3mm L1 31mm L2 152mm W1 134mm W2 56mm connection male faston 6.3mm connection distance 51mm dry heating element heating circuits 1		

### heating elements for contact grills



1

<b>GEV No.</b>	416590	<b>Ref. No.</b>	IGS407C
<b>description</b>	heating element 1150W 230V L 192mm W 304mm H 18mm W1 98mm W2 108mm connection length 24mm tube ø 6.3mm windings 5 connection M4 mounting pos. lower dry heating element		



1

<b>GEV No.</b>	416593	<b>Ref. No.</b>	IGS402P
<b>description</b>	heating element 700W 240V L 180mm W 175mm H 15mm W1 50mm W2 75mm connection length 21mm tube ø 6.5mm windings 3 connection M4 mounting pos. lower dry heating element		



1

<b>GEV No.</b>	416592	<b>Ref. No.</b>	IGS103013 IGS407P
<b>description</b>	heating element 850W 240V L 180mm W 172mm H 16mm W1 45mm W2 71mm connection length 18mm tube ø 6.5mm windings 3 connection 18 cable length 120mm mounting pos. lower dry heating element		

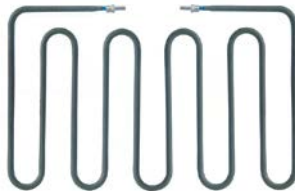

1

<b>GEV No.</b>	416591	<b>Ref. No.</b>	IGS402C
<b>description</b>	heating element 875W 230V heating circuits 1 L 190mm W 308mm H 18mm W1 108mm W2 92mm connection length 24mm tube ø 6.3mm windings 5 connection M4 mounting pos. upper dry heating element		



## heating elements for pizza ovens

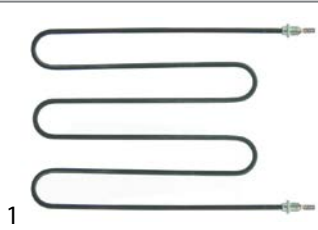

<b>GEV No.</b>	416488	<b>Ref. No.</b>	IB5256400
<b>description</b>	heating element 1000W 230V L 320mm W 240mm thread M12x1.5 mounting distance 233mm connection length 33mm connection male faston 6.3mm tube ø 6.3mm heating circuits 1 dry heating element 2 hole fixing		
<b>For models:</b>	VETRINETTA 38		

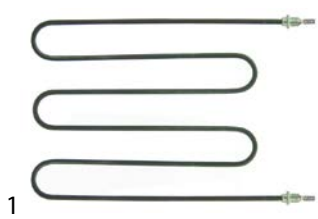

<b>GEV No.</b>	416489	<b>Ref. No.</b>	IB5256410
<b>description</b>	heating element 700W 230V L 316mm W 235mm thread M12x1.5 mounting distance 228mm connection length 34mm connection male faston 6.3mm tube ø 6.3mm heating circuits 1 dry heating element 2 hole fixing		





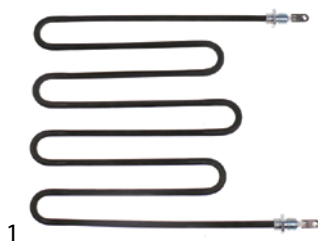

<b>GEV No.</b>	417666	<b>Ref. No.</b>	IGS803603
<b>description</b>	heating element 975W 240V L 700mm W 100mm thread 1/4" mounting distance 54.5mm connection length 49mm connection M4 tube ø 8.5mm heating circuits 1 2 hole fixing		

## heating elements for salamanders/toast-

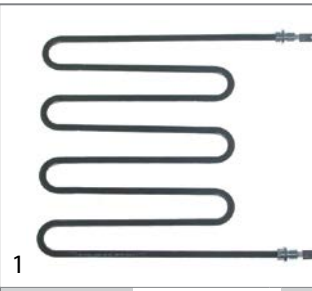

<b>GEV No.</b>	418645	<b>Ref. No.</b>	IB52565010
<b>description</b>	heating element 1700W 230V L 235mm W 211mm thread M12x1 mounting distance 205mm connection M4 tube ø 6.3mm heating circuits 1 dry heating element 2 hole fixing salamander grill H 6.3mm		
<b>For models:</b>	SALAMANDRA PRO 1/1G CE		



<b>GEV No.</b>	416594	<b>Ref. No.</b>	RCSG200	
<b>description</b>	heating element 1900W 230V L 230mm W 205mm thread M10x1 mounting distance 199mm connection length 23mm connection M4 tube ø 6.3mm heating circuits 1 dry heating element 2 hole fixing salamander grill H 6.3mm			
<b>accessories for</b>	416594			
	<b>GEV No.</b>	510416	<b>Ref. No.</b>	—
	flat gasket fibre ED ø 19mm ID ø 10.5mm thickness 1.5mm for thread M10 Qty 1 pcs			
	<b>GEV No.</b>	510893	<b>Ref. No.</b>	—
	O-ring EPDM thickness 2.62mm ID ø 9.92mm Qty 1 pcs			
	<b>GEV No.</b>	520231	<b>Ref. No.</b>	—
	nut thread M10x1 H 6mm WS 14 zinc-coated steel Qty 1 pcs			
	<b>GEV No.</b>	521129	<b>Ref. No.</b>	—
	nut thread M10 H 6mm SS WS 17 Qty 1 pcs DIN/ISO DIN 439			

## quartz heating elements



<b>GEV No.</b>	416564	<b>Ref. No.</b>	IB5206800
<b>description</b>	heating coil 400W 110V for quartz tube 320Ohm L1 345mm L2 310mm ø 6mm connection eye		
<b>For models:</b>	ROLLER		



<b>GEV No.</b>	417445	<b>Ref. No.</b>	IB5206900
<b>description</b>	heating coil 400W 110V for quartz tube L1 170mm L2 115mm ø 6.5mm connection eye		



<b>GEV No.</b>	416482	<b>Ref. No.</b>	IGS402T04
<b>description</b>	heating coil 400W 115V L1 280mm L2 220mm ø 6mm connection eye		
<b>For models:</b>	4Q		





<b>GEV No.</b>	417448	<b>Ref. No.</b>	IB5206810 IB5206910
<b>description</b>	heating coil 400W 230V 1350Ohm L1 300mm L2 210mm ø 6.3mm connection ø 5mm		







1 			
<b>GEV No.</b>	416484	<b>Ref. No.</b>	IGS402T06
<b>description</b>	heating coil 500W 115V for quartz tube L1 260mm L2 220mm ø 6mm connection eye		
<b>For models:</b>	12Q, 6Q		

1 			
<b>GEV No.</b>	416485	<b>Ref. No.</b>	IGS402T06/02
<b>description</b>	heating coil 600W 110V for quartz tube L1 390mm L2 340mm ø 6mm connection eye		
<b>For models:</b>	6Q		

1 				
<b>GEV No.</b>	416562	<b>Ref. No.</b>	IGS402SF	
<b>description</b>	heating coil 700W 110V for quartz tube L1 510mm L2 460mm ø 6mm connection eye			
<b>accessories for</b>	416562			
	<b>GEV No.</b>	416561	<b>Ref. No.</b>	IGS660SF
	quartz tube WV L 515mm tube ø 10mm			

1 			
<b>GEV No.</b>	693096	<b>Ref. No.</b>	IB5906800 IGS630SF
<b>description</b>	insulator complete ø 13mm bore ø 5.2mm		
<b>For models:</b>	ROLLER		

1 			
<b>GEV No.</b>	416481	<b>Ref. No.</b>	IGS660T04
<b>description</b>	quartz tube L 270mm ID ø 8.5mm ED ø 11.5mm		
<b>For models:</b>	4Q		

1 			
<b>GEV No.</b>	418583	<b>Ref. No.</b>	IB3506900
<b>description</b>	quartz tube WV L 255mm tube ø 11mm		

1 			
<b>GEV No.</b>	416486	<b>Ref. No.</b>	IB3506800
<b>description</b>	quartz tube WV L 337mm tube ø 11mm		
<b>For models:</b>	ROLLER		

1 			
<b>GEV No.</b>	416483	<b>Ref. No.</b>	IGS660T06
<b>description</b>	quartz tube WV L 390mm tube ø 11mm		
<b>For models:</b>	12Q, 6Q		

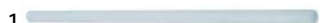
1 				
<b>GEV No.</b>	416561	<b>Ref. No.</b>	IGS660SF	
<b>description</b>	quartz tube WV L 515mm tube ø 10mm			
<b>accessories for</b>	416561			
	<b>GEV No.</b>	416562	<b>Ref. No.</b>	IGS402SF
	heating coil 700W 110V for quartz tube L1 510mm L2 460mm ø 6mm connection eye			

### heating elements for convection

1 				
<b>GEV No.</b>	418267	<b>Ref. No.</b>	FPRES30003	
<b>description</b>	heating element 2500W 230V heating circuits 1 ID ø 181mm ED ø 193mm L 208mm H 30mm L1 10mm W1 30mm H1 6mm H2 24mm flange length 70mm flange width 22mm hole distance 56mm connection male faston 6.3mm tube ø 6.3mm convection heating element hole ø 5mm rectangular flange			
<b>spare parts for</b>	418267			
	<b>GEV No.</b>	510368	<b>Ref. No.</b>	—
	gasket L 70mm W 23.5mm hole ø 5mm hole distance 56mm FIBER thickness 2mm for heating element			

### energy regulators

#### EGO

##### 1-circuit

1 			
<b>GEV No.</b>	380015	<b>Ref. No.</b>	ATHD073010 IGS445SF RCSG230
<b>description</b>	energy regulator 230V 13A single-circuit turn direction right shaft ø 6x4.6mm shaft L 23mm mounting thread M4 power release 6-100% no. 50.57021.010		

#### DIAMOND

1 			
<b>GEV No.</b>	380032	<b>Ref. No.</b>	IB5256500 IGS804403
<b>description</b>	energy regulator 230V 13.5A turn direction right shaft ø 6x4.6mm shaft L 23mm mounting thread M4 equiv. no. 45ER104C1		
<b>For models:</b>	SALAMANDRA PRO 1/1G CE		



## thermostats

### control and safety thermostats

IMIT / TEMPOMATIC / ARTHERMO

#### control thermostats



<b>GEV No.</b>	375399	<b>Ref. No.</b>	IB5866400
<b>description</b>	thermostat t.max. 300°C temperature range 50-300°C 1-pole 1CO 15A probe ø 4mm probe L 97mm capillary pipe 900mm capillary pipe isolatedmm gland nut shaft ø 6x4.6mm shaft L 19mm shaft position upper rotation 270°		



<b>GEV No.</b>	375847	<b>Ref. No.</b>	IV5863500
<b>description</b>	thermostat t.max. 90°C temperature range 0-90°C 1-pole 1CO 15A probe ø 6.5mm probe L 100mm capillary pipe 1500mm capillary pipe isolatedmm gland nut shaft ø 6x4.6mm shaft L 18mm shaft position +135° rotation 270° 250V		

#### control thermostats with operation switch

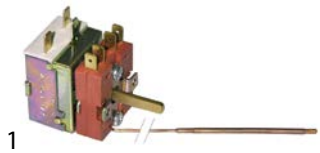

<b>GEV No.</b>	390139	<b>Ref. No.</b>	IGS460
<b>description</b>	thermostat t.max. 270°C temperature range 63-270°C 1-pole 1CO 15A probe ø 3.5mm probe L 195mm capillary pipe 1000mm capillary pipe isolatedmm gland nut shaft ø 6x4.6mm shaft L 17mm shaft position upper° rotation 270°		

## TECASA

### control thermostats

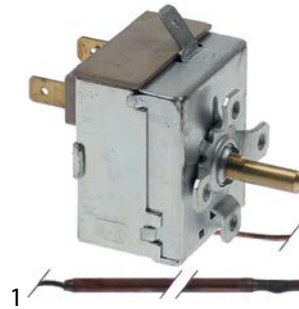

<b>GEV No.</b>	375986	<b>Ref. No.</b>	IGS104023 IGS704203
<b>description</b>	thermostat t.max. 310°C temperature range 50-310°C 1-pole 1NO 16A probe ø 3.5mm probe L 195mm capillary pipe 900mm capillary pipe isolated 20mm gland nut shaft ø 6x4.6mm shaft L 18mm shaft position upper rotation 270° 230V suitable for IMIT		
<b>For models:</b>	CREPIERA TONDA		

## various

### control thermostats

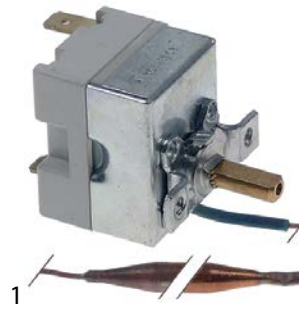

<b>GEV No.</b>	375904	<b>Ref. No.</b>	IB5866000
<b>description</b>	thermostat t.max. 90°C temperature range 0-90°C 1-pole 1NO 16A probe ø 6.5mm probe L 85mm capillary pipe 970mm capillary pipe isolatedmm gland nut shaft L 15mm shaft position upper° rotation 270° probe material copper ambient temperature max. 150°C		
<b>For models:</b>	VETRINETTA 38		

## switches and momentary switches

### rocker/momentary rocker switches

#### 28x13.5mm



<b>GEV No.</b>	346957	<b>Ref. No.</b>	KODK005
<b>description</b>	rocker switch mounting measurements 28x13.5mm green 1NO 250V 6A illuminated ON-OFF connection male faston 6.3mm ambient temperature max. 85°C protection IP40		



30x22mm



1

<b>GEV No.</b>	301002	<b>Ref. No.</b>	IB5806000
<b>description</b>	rocker switch mounting measurements 30x22mm orange 2NO 250V 16A illuminated 0-I connection male faston 6.3mm ambient temperature max. 85/125°C protection IP65		
<b>For models:</b>	VETRINETTA 38		
<b>accessories for</b>	301002		
	<b>GEV No.</b>	301036	<b>Ref. No.</b> —
	protective cover internal size 30x22mm for rocker switch mounting measurementsmm		



1

<b>GEV No.</b>	301009	<b>Ref. No.</b>	IV5806001
<b>description</b>	rocker switch mounting measurements 30x22mm white 2NO 250V 16A illuminated 0-I connection male faston 6.3mm ambient temperature max. 125/55°C protection IP65		
<b>accessories for</b>	301009		
	<b>GEV No.</b>	301036	<b>Ref. No.</b> —
	protective cover internal size 30x22mm for rocker switch mounting measurementsmm		



1

<b>GEV No.</b>	348090	<b>Ref. No.</b>	29410101
<b>description</b>	rocker switch mounting measurements 30x22mm white 2CO 250V 16A for mincer arrow connection male faston 6.3mm ambient temperature max. 100/55°C protection IP40		

labelled

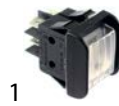

1

<b>GEV No.</b>	346868	<b>Ref. No.</b>	19410101 19410102
<b>description</b>	rocker switch mounting measurements 30x22mm white 2NO 250V 16A illuminated 0-I connection male faston 6.3mm ambient temperature max. 125/55°C protection IP65 with cover cap		
<b>For models:</b>	PERLA 220 CE DOM, PERLA 250 CE DOM		
<b>accessories for</b>	346868		
	<b>GEV No.</b>	301036	<b>Ref. No.</b> —
	protective cover internal size 30x22mm for rocker switch mounting measurementsmm		

push/momentary push switches

ø11mm



1

<b>GEV No.</b>	347060	<b>Ref. No.</b>	IV5820010
<b>description</b>	push button mounting ø M11x1mm black 1NO 250V 16A connection male faston 6.3mm ambient temperature max. 125°C with plunger actuating force: 200g type CM thread L 14mm		
<b>For models:</b>	TV-TM INOX, TV-TM INOX07		

ø19.2mm



1

<b>GEV No.</b>	346414	<b>Ref. No.</b>	LF1041001
<b>description</b>	momentary push switch mounting ø 19.2mm silver 1NC/1NO 250V 5A SS connection soldering connection ambient temperature max. 85°C protection IP40		



1

<b>GEV No.</b>	346415	<b>Ref. No.</b>	LF1041000
<b>description</b>	momentary push switch mounting ø 19.2mm silver 1NO 50V 0.05A with LED connection soldering connection ambient temperature max. 85°C protection IP40		



1



<b>GEV No.</b>	347650 <sup>1</sup>	<b>Ref. No.</b>	LF1041015
<b>description</b>	momentary push switch mounting ø 19.2mm SS 1NO 24V 0.05A with LED connection male faston 6.3mm ambient temperature max. 85°C protection IP40 SS cable length 800mm		

<sup>1</sup>illuminated by LED

ø22mm



1

<b>GEV No.</b>	401357	<b>Ref. No.</b>	MF2138
<b>description</b>	momentary push switch mounting measurements ø22mm 1NO/1NC/indicator light 400V 4A indicator lamp 24V 0-I connection screw ambient temperature max. 125/55°C protection IP40		
<b>For models:</b>	TC22E CE, TCG 22 E CE		
<b>spare parts for</b>	401357		
	<b>GEV No.</b>	346181	<b>Ref. No.</b> —
	push button mounting ø 21mm external size 30x55mm oval		
<b>accessories for</b>	401357		
	<b>GEV No.</b>	401709	<b>Ref. No.</b> —
	protective cover external size 57x32mm internal size 47x22mm matt finish rubber H 27.5mm		



## overload switches



1

<b>GEV No.</b>	347067	<b>Ref. No.</b>	19410152
<b>description</b>	push switch KJD17 mounting measurements 45x22mm black/white 2NO/A1 250V 10A I O connection male faston 4.8mm/6.3mm ambient temperature max. 85°C protection IP54 with cover cap		



1

<b>GEV No.</b>	348137	<b>Ref. No.</b>	19410152 CINPKJD17
<b>description</b>	push switch KLD-28A mounting measurements 45x22mm green/red 2NO/A1 250V 16A I O connection male faston 2.8mm/6.3mm ambient temperature max. 85°C protection IP55 with cover cap		

## miscellaneous



1

<b>GEV No.</b>	346955	<b>Ref. No.</b>	IB5804402	
<b>description</b>	momentary push switch mounting measurements 29x29mm black 1NO 250V 6A connection screw VORTEX			
<b>For models:</b>	VORTEX 43, VORTEX 55, VORTEX 75			
<b>accessories for</b>	346955			
	<b>GEV No.</b>	346960	<b>Ref. No.</b>	IB4104002
	protection cap for push-button L 45mm W 21mm			



1

<b>GEV No.</b>	346959	<b>Ref. No.</b>	IB5804403	
<b>description</b>	momentary push switch mounting measurements 29x29mm red 1NO 250V 6A connection screw CICLONE			
<b>For models:</b>	CICLONE 15VV CE, CICLONE 23 CE			
<b>accessories for</b>	346959			
	<b>GEV No.</b>	346958	<b>Ref. No.</b>	IB4104102
	protection cap L 45mm W 21mm			

## accessories

## frame



1

<b>GEV No.</b>	346252	<b>Ref. No.</b>	19563171
<b>description</b>	frame external size 36x65mm internal size 30x22mm black plastic mounting distance 54mm		
<b>For models:</b>	PERLA 220 CE DOM, PERLA 250 CE DOM		

## protective covers



1

<b>GEV No.</b>	346960	<b>Ref. No.</b>	IB4104002	
<b>description</b>	protection cap for push-button L 45mm W 21mm			
<b>For models:</b>	VORTEX 43, VORTEX 55, VORTEX 75			
<b>accessories for</b>	346960			
	<b>GEV No.</b>	346955	<b>Ref. No.</b>	IB5804402
	momentary push switch mounting measurements 29x29mm black 1NO 250V 6A connection screw VORTEX			



1

<b>GEV No.</b>	346958	<b>Ref. No.</b>	IB4104102	
<b>description</b>	protection cap L 45mm W 21mm			
<b>For models:</b>	CICLONE 15VV CE, CICLONE 23 CE			
<b>accessories for</b>	346958			
	<b>GEV No.</b>	346959	<b>Ref. No.</b>	IB5804403
	momentary push switch mounting measurements 29x29mm red 1NO 250V 6A connection screw CICLONE			

## microswitches

## universal



1

<b>GEV No.</b>	348046	<b>Ref. No.</b>	PANE61424L0AG PANE6142-F60
<b>description</b>	microswitch with plunger 250V 16A 1CO connection male faston 4.8mm Lmm L1 27.8mm ambient temperature max. 125°C mounting distance 22mm with lever set type MS1-16 actuating force: 100g white		



**CROUZET**



1

<b>GEV No.</b>	345042	<b>Ref. No.</b>	IB5820800
<b>description</b>	microswitch with plunger 250V 16A 1CO connection male faston 6.3mm L 28mm ambient temperature max. 125°C mounting distance 22mm type EF83161.3 actuating force: 75g blue/black		
<b>For models:</b>	DRAGONE CE		
<b>accessories for</b>	345042		
	GEV No.	345043	Ref. No.
			—
	lever set 5-piece		

pin-plunger actuated

**CROUZET**



1

<b>GEV No.</b>	345042	<b>Ref. No.</b>	IB5820800
<b>description</b>	microswitch with plunger 250V 16A 1CO connection male faston 6.3mm L 28mm ambient temperature max. 125°C mounting distance 22mm type EF83161.3 actuating force: 75g blue/black		
<b>For models:</b>	DRAGONE CE		
<b>accessories for</b>	345042		
	GEV No.	345043	Ref. No.
			—
	lever set 5-piece		



1

<b>GEV No.</b>	348043	<b>Ref. No.</b>	MSC04N262
<b>description</b>	microswitch with plunger 250V 16A 1CO connection male faston 6.3mm Lmm L1 27.8mm ambient temperature max. 125°C mounting distance 22mm with lever set type MS1-16 actuating force: 100g white		
<b>For models:</b>	C9VV CE		

M10



1

<b>GEV No.</b>	345678	<b>Ref. No.</b>	19410201
<b>description</b>	microswitch with plunger thread M10x0.75 thread L 16mm 250V 16A 1NO connection male faston 6.3mm stroke 2.5mm mounting distance 22mm ambient temperature max. 125°C actuating force: 290g		
<b>For models:</b>	PERLA 220 CE DOM, PERLA 250 CE DOM		
<b>accessories for</b>	345678		
	GEV No.	100779	Ref. No.
			—
	nut thread M10x0.75 H 3mm WS 14 SS Qty 2 pcs		

lever actuated



1

<b>GEV No.</b>	347010	<b>Ref. No.</b>	IB5820700
<b>description</b>	microswitch with lever 250V 16A 1CO connection male faston 4.8mm L 36mm ambient temperature max. 105°C mounting distance 22mm type D3V-16G443-1C25-K actuating force: 50g lever length 28mm		
<b>For models:</b>	APOLLO CE		



1

<b>GEV No.</b>	345032	<b>Ref. No.</b>	MSC04N276
<b>description</b>	microswitch with plunger thread M10x1 thread L 12mm 250V 16A 1CO connection male faston 6.3mm stroke 7mm mounting distance 22mm L 28mm ambient temperature max. 125°C type SP9603 actuating force: 180g		
<b>For models:</b>	C9VV CE		

roller-lever actuated  
microswitches



1

<b>GEV No.</b>	346893	<b>Ref. No.</b>	MSC04N292
<b>description</b>	microswitch with handle with a switch 250V 16A 1CO connection male faston 6.3mm ambient temperature max. 125°C mounting distance 22mm white		
<b>For models:</b>	C9VV CE		

accessories



1

<b>GEV No.</b>	698204	<b>Ref. No.</b>	MSC04N264
<b>description</b>	bracket for microswitch C4-C6		
<b>For models:</b>	C9VV CE		





			
1			
<b>GEV No.</b>	347061	<b>Ref. No.</b>	MSC04N274
<b>description</b>	spacer ring for microswitch ID ø 10mm ED ø 14mm thickness 4mm		
<b>For models:</b>	C9VV CE		

rotary switches

BREMAS

CQ016R series

			
1			
<b>GEV No.</b>	346592	<b>Ref. No.</b>	19410160
<b>description</b>	rotary switch 2 0-1 sets of contacts 2 400V 20A shaft ø 5x5mm shaft L 16mm shaft square with knob connection screw		

GIOVENZANA

rotary switches

			
1			
<b>GEV No.</b>	347733	<b>Ref. No.</b>	LF1033001
<b>description</b>	rotary switch 3 1-0-2 momentary sets of contacts 6 6909V 16A shaft ø 7x8mm shaft L 15mm shaft square connection screw		

TECNOMATIC

			
1			
<b>GEV No.</b>	348152	<b>Ref. No.</b>	MF2365
<b>description</b>	rotary switch 1-0-2 momentary 3 type HD1237R922 600V 12A shaft ø 5x5mm shaft L 22mm		

			
1			
<b>GEV No.</b>	345993	<b>Ref. No.</b>	IB5806805
<b>description</b>	rotary switch 2 0-1 sets of contacts 2 600V 25A shaft ø 5x5mm shaft square connection screw		
<b>For models:</b>	ROLLER		

			
1			
<b>GEV No.</b>	346239	<b>Ref. No.</b>	MF2365 old version
<b>description</b>	rotary switch 3 1-0-2 momentary sets of contacts 5 type HD1237R921-L5 600V 12A shaft ø 6mm shaft L 22mm shaft round connection male faston 6.3mm		

			
1			
<b>GEV No.</b>	346238	<b>Ref. No.</b>	MF2364
<b>description</b>	rotary switch 3 1-0-2 momentary sets of contacts 6 type HD1249R922 600V 12A shaft ø 5x5mm shaft L 23mm shaft square connection screw		

			
1			
<b>GEV No.</b>	345994	<b>Ref. No.</b>	IB5806800
<b>description</b>	rotary switch 5 0-1-2-3-4 sets of contacts 4 type HD16G014F112 600V 16A shaft ø 5x5mm shaft L 23mm shaft square connection screw		
<b>For models:</b>	ROLLER		

			
1			
<b>GEV No.</b>	347875	<b>Ref. No.</b>	IB5806820
<b>description</b>	rotary switch 5 0-1-2-3-4 sets of contacts 6 type HD16G014F112 600V 16A shaft ø 5x5mm shaft L 23mm shaft square connection screw ED ø 43mm L 80mm		





magnetic switches

36x13mm

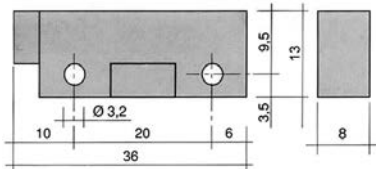

1



<b>GEV No.</b>	345335	<b>Ref. No.</b>	IV5820000 MF2362
<b>description</b>	magnetic switch L 36mm W 13mm 1NO 250V 0.04A P max. 10W connection cable cable length 960mm		
<b>For models:</b>	TCG 22 E CE, TV-TM INOX, TV-TM INOX07		
<b>accessories for</b>	345335		
	<b>GEV No.</b>	519049	<b>Ref. No.</b> —
	magnet ømm L 63mm H 10.7mm W 18.8mm hole distance 52mm M2 hole ø 2mm		

40x13mm



1

<b>GEV No.</b>	300273	<b>Ref. No.</b>	LF1010005
<b>description</b>	magnetic switch L 40mm W 13mm 1NO 250V 1A P max. 50W connection cable cable length 1180mm		

ø 6mm



1

<b>GEV No.</b>	345967	<b>Ref. No.</b>	RG04094
<b>description</b>	magnetic switch 250V 1A P max. 50W probe L 29mm 1NO connection cable cable length 3000mm		
<b>For models:</b>	PP EXPO 4 CE, PP EXPO 8 CE		

M8x0.75

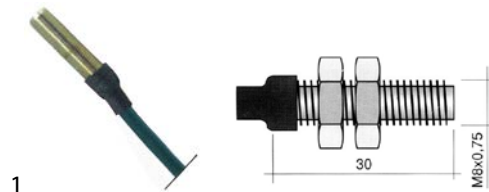

1

<b>GEV No.</b>	345631	<b>Ref. No.</b>	RG04224
<b>description</b>	magnetic switch thread M8x0.75 1NO 250V 1A P max. 50W connection cable cable length 2000mm		
<b>For models:</b>	PP EXPO 4 CE, PP EXPO 8 CE		

M10x0.75

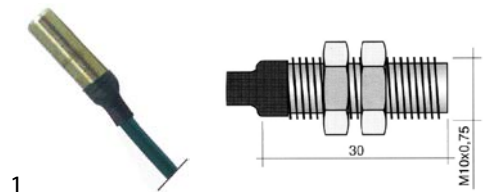

1

<b>GEV No.</b>	345632	<b>Ref. No.</b>	IV5820510
<b>description</b>	magnetic switch thread M10x0.75 1NO 250V 0.5A P max. 50W connection cable cable length 2000mm type 102		
<b>For models:</b>	TC 12 MAGNUM INGRANAGGI CE		
<b>accessories for</b>	345632		
	<b>GEV No.</b>	100779	<b>Ref. No.</b> —
	nut thread M10x0.75 H 3mm WS 14 SS Qty 2 pcs		

accessories

magnets

  
Image not available

1

<b>GEV No.</b>	346392	<b>Ref. No.</b>	MF0292
<b>description</b>	magnet		
<b>For models:</b>	GF, GP		

  
Image not available

1

<b>GEV No.</b>	346393	<b>Ref. No.</b>	MF0295
<b>description</b>	magnet		
<b>For models:</b>	GF, GP		

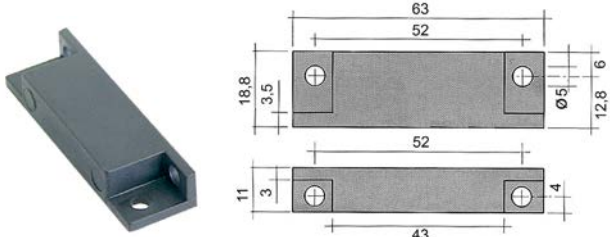

			
1			
<b>GEV No.</b>	691178	<b>Ref. No.</b>	IB5823050 IV5823050
<b>description</b>	magnet $\phi$ 22mm Lmm H 7mm Wmm ED $\phi$ 22mm M5		
<b>For models:</b>	PP EXPO 4 CE, PP EXPO 8 CE		

			
1			
<b>GEV No.</b>	345336	<b>Ref. No.</b>	IV5820050
<b>description</b>	magnet $\phi$ 4.8mm L 63mm H 11mm W 18.8mm hole distance 51mm M4		
<b>For models:</b>	TV-TM INOX, TV-TM INOX07		

			
1			
<b>GEV No.</b>	346891	<b>Ref. No.</b>	RG08054
<b>description</b>	magnet $\phi$ 6mm L 25mm		
<b>For models:</b>	PP EXPO 4 CE, PP EXPO 8 CE		

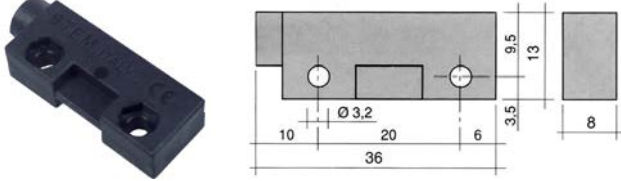

			
1			
<b>GEV No.</b>	345398	<b>Ref. No.</b>	RG04146
<b>description</b>	magnet $\phi$ 6mm L 36mm H 8mm W 13mm hole distance 20mm M3 hole $\phi$ 3mm		

## control equipment

### GIOVENZANA

#### switches (complete)

			
1			
<b>GEV No.</b>	346490	<b>Ref. No.</b>	LF1034002 RG04300 RG04300+RG04328
<b>description</b>	emergency stop switch mounting measurements $\phi$ 22mm red 1NC complete		
<b>For models:</b>	PP EXPO 4 CE, PP EXPO 8 CE		

				
1				
<b>GEV No.</b>	401357	<b>Ref. No.</b>	MF2138	
<b>description</b>	momentary push switch mounting measurements $\phi$ 22mm 1NO/1NC/indicator light 400V 4A indicator lamp 24V 0-1 connection screw ambient temperature max. 125/55°C protection IP40			
<b>For models:</b>	TC22E CE, TCG 22 E CE			
<b>spare parts for</b>	401357			
	<b>GEV No.</b>	346181	<b>Ref. No.</b>	—
	push button mounting $\phi$ 21mm external size 30x55mm oval			
<b>accessories for</b>	401357			
	<b>GEV No.</b>	401709	<b>Ref. No.</b>	—
	protective cover external size 57x32mm internal size 47x22mm matt finish rubber H 27.5mm			

			
1			
<b>GEV No.</b>	346545	<b>Ref. No.</b>	LF1034001 PPRN2CL RG04356
<b>description</b>	push button mounting measurements $\phi$ 22mm green 1NO complete with protecting cover		
<b>For models:</b>	PP EXPO 4 CE, PP EXPO 8 CE		

			
1			
<b>GEV No.</b>	346513	<b>Ref. No.</b>	LF1010705 RG04354
<b>description</b>	push button mounting measurements $\phi$ 22mm red 1NC complete with protecting cover		
<b>For models:</b>	PP EXPO 4 CE, PP EXPO 8 CE		

## encoders and potentiometers

			
1			
<b>GEV No.</b>	401953	<b>Ref. No.</b>	IB5944010
<b>description</b>	PCB hand blenders VORTEX with potentiometer 230V		
<b>For models:</b>	VORTEX 43, VORTEX 55, VORTEX 75		



			
1			
<b>GEV No.</b>	300362	<b>Ref. No.</b>	19414060N IB5940920
<b>description</b>	potentiometer 0.1KOhm rotation 270° shaft ø 6mm confectioned shaft L 42mm thread M10 cable length 28mm Orione		
<b>For models:</b>	C9VV CE, ORIONE CE		

			
1			
<b>GEV No.</b>	300227	<b>Ref. No.</b>	IB5940011
<b>description</b>	potentiometer 0.1KOhm rotation 270° shaft ø 6mm shaft L 42mm thread M10 cable length 600mm		

			
1			
<b>GEV No.</b>	300130	<b>Ref. No.</b>	IB5946815
<b>description</b>	potentiometer 4KOhm toaster		
<b>For models:</b>	ROLLER		

## lamps

### indicator lights

#### indicator lights (complete)

ø10mm

with screw socket

			
1			
<b>GEV No.</b>	357001	<b>Ref. No.</b>	IGS716033
<b>description</b>	indicator light ø 10mm 230V yellow/red temp.-resist. 120°C with protecting cover		
<b>For models:</b>	CREPIERA TONDA		

			
1			
<b>GEV No.</b>	359986	<b>Ref. No.</b>	IGS716023
<b>description</b>	indicator light ø 10mm 250V yellow connection male faston 6.3mm		
<b>For models:</b>	CREPIERA TONDA		

with plug-in socket

			
1			
<b>GEV No.</b>	359232	<b>Ref. No.</b>	IGS422T12
<b>description</b>	indicator light ø 10mm clear 230V connection male faston 2.8mm Qty 1 pcs		
<b>For models:</b>	12Q		

			
1			
<b>GEV No.</b>	359138	<b>Ref. No.</b>	MF2192
<b>description</b>	indicator light ø 10mm red 230V connection male faston 6.3mm Qty 1 pcs		
<b>For models:</b>	TC22E CE, TCG 22 E CE		

			
1			
<b>GEV No.</b>	359140	<b>Ref. No.</b>	IB5846400 RCSG236
<b>description</b>	indicator light ø 10mm yellow 230V connection male faston 6.3mm Qty 1 pcs		
<b>For models:</b>	SALAMANDRA PRO 1/1G CE, VETRINETTA 38		

ø12mm

with screw socket

			
1			
<b>GEV No.</b>	359027	<b>Ref. No.</b>	ATHD076005
<b>description</b>	indicator light ø 12mm 250V green connection male faston 6.3mm		

30x22mm

			
1			
<b>GEV No.</b>	359154	<b>Ref. No.</b>	IGS422
<b>description</b>	indicator light mounting measurements 30x22mm 230V white connection male faston 6.3mm temp.-resist. 125/55°C type RL2		

			
1			
<b>GEV No.</b>	301138	<b>Ref. No.</b>	IGS422SF
<b>description</b>	indicator light mounting measurements 30x22mm 230V red/green connection male faston 6.3mm temp.-resist. 125/55°C type RL2		

miscellaneous



<b>GEV No.</b>	359851	<b>Ref. No.</b>	KODK006
<b>description</b>	indicator light mounting measurements 32.5x8.5mm white 230V		

screw-on/push-on fit

light bulbs

for ovens





<b>GEV No.</b>	359610	<b>Ref. No.</b>	IB5946010
<b>description</b>	light bulb t.max. 300°C socket E14 15W 230V ø 22mm L 47mm lens L 20mm for oven lamp type Philips		
<b>For models:</b>	VETRINETTA 38		

oven lamps

universal oven lamps

mounting diameter 35.5mm



<b>GEV No.</b>	359718	<b>Ref. No.</b>	IB5846000	
<b>description</b>	oven lamp mounting ø 35.5mm 230V 15W socket E14 temp.-resist. 300°C connection male faston 6.3mm hard glas			
<b>For models:</b>	VETRINETTA 38			
<b>spare parts for</b>	359718			
	<b>GEV No.</b>	359701	<b>Ref. No.</b>	—
	lamp socket socket E14 220-230V mounting ø 35.5mm connection male faston 6.3mm 15W			
	<b>GEV No.</b>	359740	<b>Ref. No.</b>	—
	light bulb t.max. 300°C socket E14 15W 230V ø 22mm L 48mm lens L 20mm for oven lamp IMPORT			

lamps

light bulbs



<b>GEV No.</b>	359610	<b>Ref. No.</b>	IB5946010
<b>description</b>	light bulb t.max. 300°C socket E14 15W 230V ø 22mm L 47mm lens L 20mm for oven lamp type Philips		
<b>For models:</b>	VETRINETTA 38		

timers

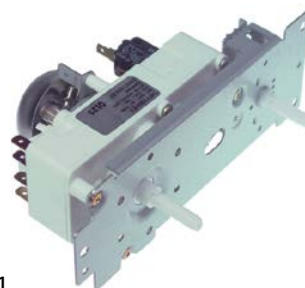

programme timers



<b>GEV No.</b>	360376	<b>Ref. No.</b>	E6001806BP
<b>description</b>	timer		

mechanical timers



<b>GEV No.</b>	350176	<b>Ref. No.</b>	RG04342	
<b>description</b>	timer C20 2-pole operation time 5min 2NO at 250V 16A permanent position no shaft ø 6x4.6mm shaft 6x4.6mm shaft L 20mm mounting distance 28mm			
<b>accessories for</b>	350176			
	<b>GEV No.</b>	110366	<b>Ref. No.</b>	IB4206400
	knob switch zero mark t.max. °C°C ø 44mm shaft ø 6x4.6mm shaft flat upper black			
	<b>GEV No.</b>	112138	<b>Ref. No.</b>	—
	dial plate graduation 5min permanent position no rotation 0-290° ø 60mm			







<b>GEV No.</b>	350128 <sup>1</sup>	<b>Ref. No.</b>	RG04342
<b>description</b>	timer C20 2-pole operation time 5min 2NO at 250V 16A shaft ø 6x4.6mm shaft L 20mm mounting distance 28mm		



<sup>1</sup>incl. knob







 <p>1</p>			
<b>GEV No.</b>	350179	<b>Ref. No.</b>	IV5966010
<b>description</b>	timer G 2-pole operation time 5min impulse mechanical 2NO at 250V 16A permanent position no shaft ø 3.5x3.5mm shaft 3.5 x 3.5mm shaft L 17mm mounting distance 28mm connection lateral		
<b>accessories for</b>	350179		
	<b>GEV No.</b>	110365	<b>Ref. No.</b> —
	knob switch zero mark t.max.°C ø 44mm shaft ø 3.5x3.5mm shaft flat black		
	<b>GEV No.</b>	112913	<b>Ref. No.</b> —
	dial plate graduation 5min permanent position no rotation 30-330° ø 60mm suitable for timers ø60mm		

 <p>1</p>			
<b>GEV No.</b>	350130	<b>Ref. No.</b>	FP6111300001
<b>description</b>	timer M11 with bell 1-pole operation time 120min impulse mechanical 1NO at 250V 16A permanent position yes shaft ø 6x4.6mm shaft L 23mm mounting distance 28mm mounting thread M4 connection male faston 6.3mm 4 hole fixing shaft flat upper		

 <p>1</p>			
<b>GEV No.</b>	350032	<b>Ref. No.</b>	IBSP66400 IGS440
<b>description</b>	timer M2 2-pole operation time 15min impulse mechanical 2NO at 250V 16A permanent position no shaft ø 6x4.6mm shaft 6x4.6mm shaft L 18mm mounting distance 28mm connection rear		
<b>For models:</b>	12Q, 4Q, 6Q		
<b>accessories for</b>	350032		
	<b>GEV No.</b>	110366	<b>Ref. No.</b> IB4206400
	knob switch zero mark t.max.°C ø 44mm shaft ø 6x4.6mm shaft flat upper black		
	<b>GEV No.</b>	110371	<b>Ref. No.</b> —
	dial plate graduation 15min permanent position no rotation 30-330° ø 60mm timers knob ø 45mm		

 <p>1</p>			
<b>GEV No.</b>	350192	<b>Ref. No.</b>	RGE04030
<b>description</b>	timer M2 3-pole operation time 4min impulse mechanical 3NO at 250V 16A permanent position no shaft ø 6x4.6mm shaft 6x4.6mm shaft L 22mm mounting distance 28mm mounting thread M4 connection male faston 6.3mm		

audible timers

 <p>1</p>			
<b>GEV No.</b>	350014	<b>Ref. No.</b>	IGS450
<b>description</b>	audible timer operation time 15min ø 56mm shaft ø 6x4.6mm shaft L 24mm mounting distance 28mm		

spare parts and accessories

knobs

 <p>1</p>			
<b>GEV No.</b>	110366	<b>Ref. No.</b>	IB4206400
<b>description</b>	knob switch zero mark t.max.°C ø 44mm shaft ø 6x4.6mm shaft flat upper black		

solid state relays

accessories

diodes

high voltage diodes

 <p>1</p>			
<b>GEV No.</b>	358161	<b>Ref. No.</b>	PA62024000AP
<b>description</b>	hv diode type 2X062+HVR-1X connection F6.3mm / lug M4 cable lengthmm for microwave		



## magnetrons

1 

<b>GEV No.</b>	402123	<b>Ref. No.</b>	P2M210-M1GL
<b>description</b>	Magnetron PANASONIC type 2M210M1 for microwaves		

1 

<b>GEV No.</b>	402845	<b>Ref. No.</b>	2M244-M1GL 2M244M23 P2M244-M1GL
<b>description</b>	Magnetron PANASONIC type 2M244-M23		

## probes

### universal probes

#### temperature probes

1 

<b>GEV No.</b>	379064	<b>Ref. No.</b>	OSC042657
<b>description</b>	temperature probe PTC 1kOhm cable silicone probe -50 up to +150°C cable -50 up to +180°C probe ø6x40mm cable length 3m without screw connection 2-wire		

## producer-specific probes

### core probes

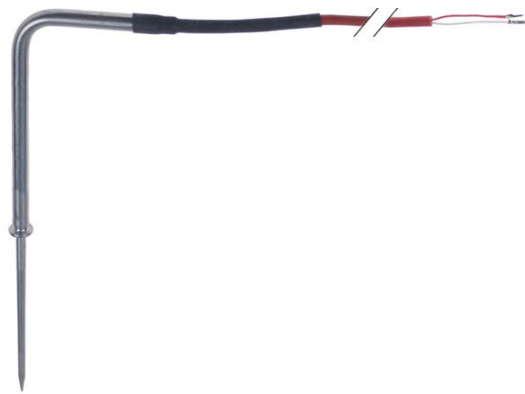
1 

<b>GEV No.</b>	379707	<b>Ref. No.</b>	AF74700998
<b>description</b>	core temperature probe cable silicone cable -50 up to +180°C connection 2-wire probe ø5x100mm thread cable length 3m handle ø8mm handle length 120mm		

1 

<b>GEV No.</b>	381445	<b>Ref. No.</b>	AF74700945
<b>description</b>	core temperature probe PTC cable silicone probe -50 to +120°C cable -50 up to +180°C connection 2-wire probe ø6x110mm thread cable length 2.5m handle ø9mm handle length 80mm		

## electronics

### PCBs

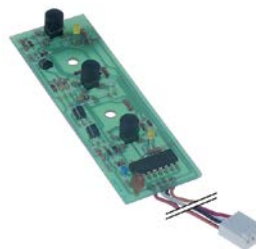
1 

<b>GEV No.</b>	401731	<b>Ref. No.</b>	IB5940915
<b>description</b>	control PCB drink mixer Orione 230V		
<b>For models:</b>	ORIONE CE		



1 

Image not available

<b>GEV No.</b>	401381	<b>Ref. No.</b>	19411005
<b>description</b>	keypad PCB		

1

<b>GEV No.</b>	697124	<b>Ref. No.</b>	MF2141
<b>description</b>	PCB 230/400V		
<b>For models:</b>	TC22E CE, TCG 22 E CE		



1

<b>GEV No.</b>	401730	<b>Ref. No.</b>	IB5940800
<b>description</b>	PCB drink mixer Dragone 50/60Hz 230V		
<b>For models:</b>	DRAGONE CE		



1

<b>GEV No.</b>	401733	<b>Ref. No.</b>	KOKD020
<b>description</b>	PCB 230V		



1

<b>GEV No.</b>	401732	<b>Ref. No.</b>	IB5940910
<b>description</b>	PCB drink mixer Orione 50Hz 230V		
<b>For models:</b>	ORIONE CE		



1

<b>GEV No.</b>	401734	<b>Ref. No.</b>	IB5940700
<b>description</b>	PCB 230V		



1

<b>GEV No.</b>	401729	<b>Ref. No.</b>	IB5940005
<b>description</b>	PCB drink mixer Sirio 50/60Hz 110-250V 1.5A		
<b>For models:</b>	SIRIO 1 GDO CE, SIRIO 2 GDO CE		



1

<b>GEV No.</b>	400957	<b>Ref. No.</b>	IB5946810
<b>description</b>	PCB conveyor toaster TOC		
<b>For models:</b>	ROLLER		



1

<b>GEV No.</b>	401728	<b>Ref. No.</b>	IB5940000
<b>description</b>	PCB drink mixer Sirio 50/60Hz 120/240V 1.6A		
<b>For models:</b>	SIRIO 1 GDO CE, SIRIO 2 GDO CE		



1

<b>GEV No.</b>	401727	<b>Ref. No.</b>	19413007
<b>description</b>	PCB cutter C4-C6 230V		
<b>For models:</b>	C9VV CE		



1

<b>GEV No.</b>	401384	<b>Ref. No.</b>	LF1033010
<b>description</b>	PCB for mincer 230/400V		





1

<b>GEV No.</b>	403515	<b>Ref. No.</b>	IB5940702
<b>description</b>	PCB fruit squeezer APOLLO L 111mm W 56mm 230V		
<b>For models:</b>	APOLLO CE		



1

<b>GEV No.</b>	300367	<b>Ref. No.</b>	IB5944014
<b>description</b>	PCB hand blenders CICLONE with potentiometer 230V		
<b>For models:</b>	CICLONE 15VV CE		
<b>accessories for</b>	300367		
	<b>GEV No.</b>	111235	<b>Ref. No.</b> IB4200705
	<b>GEV No.</b>	401954	<b>Ref. No.</b> —



1

<b>GEV No.</b>	401953	<b>Ref. No.</b>	IB5944010
<b>description</b>	PCB hand blenders VORTEX with potentiometer 230V		
<b>For models:</b>	VORTEX 43, VORTEX 55, VORTEX 75		



1

<b>GEV No.</b>	403439	<b>Ref. No.</b>	LF1033031
<b>description</b>	PCB meat mincer 12 230/400V		



1

<b>GEV No.</b>	401738	<b>Ref. No.</b>	IV5940505T
<b>description</b>	PCB meat mincer Mod.12 230/400V type TGM7-L		
<b>For models:</b>	TC 12 MAGNUM INGRANAGGI CE		



1

<b>GEV No.</b>	403890	<b>Ref. No.</b>	29411002+19702005
<b>description</b>	PCB meat mincer TGM7 230/400V		



1

<b>GEV No.</b>	401561	<b>Ref. No.</b>	IV5940500 MF2140
<b>description</b>	PCB meat mincer/cheese grater Mod.12-22 230V		



1

<b>GEV No.</b>	401359	<b>Ref. No.</b>	MF0160
<b>description</b>	PCB meat mincer/cheese grater T12 230V		

1

<b>GEV No.</b>	401385	<b>Ref. No.</b>	LF1033020
<b>description</b>	PCB Mod.12 230/400V type TGM7		
<b>For models:</b>	TC 12 MAGNUM INGRANAGGI CE		



1

<b>GEV No.</b>	403315	<b>Ref. No.</b>	19411000.06
<b>description</b>	PCB slicer CANOVA L 128mm W 42mm H 42mm		



1

<b>GEV No.</b>	401360	<b>Ref. No.</b>	MF0159
<b>description</b>	PCB Mod.12 400V		





1

<b>GEV No.</b>	403007	<b>Ref. No.</b>	19411000 19411000.12
<b>description</b>	PCB slicer GEMMA 300 400V		



1

<b>GEV No.</b>	400955	<b>Ref. No.</b>	19411008
<b>description</b>	PCB slicer 230/400V		
<b>For models:</b>	C9VV CE, CICLONE ASTA 35cm 0,15/0,23kW, TV-TM INOX, TV-TM INOX07		
<b>accessories for</b>	400955		
	<b>GEV No.</b>	401357	<b>Ref. No.</b> MF2138
	momentary push switch mounting measurements ø22mm 1NO/1NC/indicator light 400V 4A indicator lamp 24V 0-I connection screw ambient temperature max. 125/55°C protection IP40		
	<b>GEV No.</b>	401709	<b>Ref. No.</b> —
	protective cover external size 57x32mm internal size 47x22mm matt finish rubber H 27.5mm		



1

<b>GEV No.</b>	400954	<b>Ref. No.</b>	19411007
<b>description</b>	PCB slicer/cutter 50/60Hz 230V		
<b>For models:</b>	C9VV CE, CICLONE ASTA 35cm 0,15/0,23kW, TV-TM INOX, TV-TM INOX07		



1

<b>GEV No.</b>	401613	<b>Ref. No.</b>	RG04232
<b>description</b>	power PCB PP4-PP8-PP15 Expo 230/400V type TASF99		
<b>For models:</b>	PP EXPO 4 CE, PP EXPO 8 CE		



## keypads

### front foils

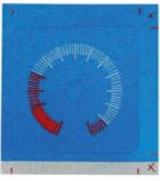

1

<b>GEV No.</b>	696452	<b>Ref. No.</b>	MSC04V238
<b>description</b>	front foil cutter C9VV CE blue L 60mm W 60mm		
<b>For models:</b>	C9VV CE		



1

<b>GEV No.</b>	401740	<b>Ref. No.</b>	MSC04V238old
<b>description</b>	front foil grey L 60mm W 60mm		



1

<b>GEV No.</b>	401741	<b>Ref. No.</b>	RG04348
<b>description</b>	front foil potato peeler PP4-PP8-PP15 Expo black L 139mm W 99mm		
<b>For models:</b>	PP EXPO 4 CE, PP EXPO 8 CE		



1

<b>GEV No.</b>	401376	<b>Ref. No.</b>	19420168
<b>description</b>	keypad foil		



1

<b>GEV No.</b>	401383	<b>Ref. No.</b>	19420165
<b>description</b>	keypad foil		



1

<b>GEV No.</b>	401379	<b>Ref. No.</b>	LF1039210
<b>description</b>	keypad foil L 170mm W 170mm buttons 3		



1

<b>GEV No.</b>	401739	<b>Ref. No.</b>	IB4100930
<b>description</b>	keypad foil Orione for mixer grey L 160mm W 34mm buttons 3		
<b>For models:</b>	ORIONE CE		

### keypad units



1

<b>GEV No.</b>	401374	<b>Ref. No.</b>	LF1033010A
<b>description</b>	keypad unit		



1

<b>GEV No.</b>	403001	<b>Ref. No.</b>	LF1007001 LF1010027
<b>description</b>	keypad unit bone saw SO1650/SO2020 L 120mm W 49mm with cable		



1



<b>GEV No.</b>	401737	<b>Ref. No.</b>	19702021
<b>description</b>	keypad unit buttons 2 blue L 130mm W 41mm		
<b>For models:</b>	C9VV CE, CICLEONE ASTA 35cm 0,15/0,23kW, TV-TM INOX, TV-TM INOX07		



			
1			
<b>GEV No.</b>	403005	<b>Ref. No.</b>	19702036
<b>description</b>	keypad unit buttons 2 L 130mm W 41mm		



			
1			
<b>GEV No.</b>	401736	<b>Ref. No.</b>	19702022
<b>description</b>	keypad unit buttons 2 white L 130mm W 41mm		
<b>For models:</b>	C9VV CE, CICLONE ASTA 35cm 0,15/0,23kW, TV-TM INOX, TV-TM INOX07		



			
1			
<b>GEV No.</b>	401377	<b>Ref. No.</b>	LF1033011
<b>description</b>	keypad unit L 130mm W 41mm		



			
1			
<b>GEV No.</b>	401735	<b>Ref. No.</b>	LF1033021
<b>description</b>	keypad unit meat mincer TC12 buttons 3 cable length 90mm L 130mm W 41mm cable colours brown/yellow/grey/green/pink/white		
<b>For models:</b>	TC 12 MAGNUM INGRANAGGI CE		
<b>accessories for</b>	401735		
	<b>GEV No.</b>	401373	<b>Ref. No.</b>
			19563034
	 gasket for keypad housing L 135mm W 50mm		

			
1			
<b>GEV No.</b>	401378	<b>Ref. No.</b>	IV5940515T
<b>description</b>	keypad unit meat mincer TC12 edition since year of construction 2005 L 130mm W 41mm complete		
<b>For models:</b>	TC 12 MAGNUM INGRANAGGI CE		

			
1			
<b>GEV No.</b>	403006	<b>Ref. No.</b>	19702034
<b>description</b>	keypad unit slicer BAYONNE/CANOVA buttons 2 L 130mm W 41mm		

			
1			
<b>GEV No.</b>	401694	<b>Ref. No.</b>	19702004
<b>description</b>	keypad unit slicer BAYONNE/CICLONE/SAN-DANIELE buttons 2 L 130mm W 41mm		
<b>For models:</b>	C9VV CE, CICLONE ASTA 35cm 0,15/0,23kW, TV-TM INOX, TV-TM INOX07		
<b>accessories for</b>	401694		
	<b>GEV No.</b>	401373	<b>Ref. No.</b>
			19563034
	 gasket for keypad housing L 135mm W 50mm		

			
1			
<b>GEV No.</b>	403002	<b>Ref. No.</b>	19702000
<b>description</b>	keypad unit slicer buttons 2 MIRRA/SAN-DANIELE/YORK L 120mm W 48mm		
<b>accessories for</b>	403002		
	<b>GEV No.</b>	403004	<b>Ref. No.</b>
			19563030
	 gasket for keypad housing L 122mm W 52mm		

			
1			
<b>GEV No.</b>	403003	<b>Ref. No.</b>	19702002
<b>description</b>	keypad unit slicer GEMMA 300/350 buttons 2 L 150mm W 55mm		
<b>accessories for</b>	403003		
	<b>GEV No.</b>	401380	<b>Ref. No.</b>
			19563032
	 gasket for keypad housing L 150mm W 60mm		

accessories

			
1			
<b>GEV No.</b>	403004	<b>Ref. No.</b>	19563030
<b>description</b>	gasket for keypad housing L 122mm W 52mm		

			
1			
<b>GEV No.</b>	401373	<b>Ref. No.</b>	19563034
<b>description</b>	gasket for keypad housing L 135mm W 50mm		
<b>For models:</b>	C9VV CE, CICLONE ASTA 35cm 0,15/0,23kW, TC 12 MAGNUM INGRANAGGI CE, TV-TM INOX, TV-TM INOX07		

			
1			
<b>GEV No.</b>	401380	<b>Ref. No.</b>	19563032
<b>description</b>	gasket for keypad housing L 150mm W 60mm		



<b>GEV No.</b>	401375	<b>Ref. No.</b>	19563118
<b>description</b>	keypad housing		



<b>GEV No.</b>	401382	<b>Ref. No.</b>	19563116
<b>description</b>	keypad housing		

refrigeration fans

cold air circulating fans (complete)



<b>GEV No.</b>	601964	<b>Ref. No.</b>	OSC649130
<b>description</b>	fan A2E250AM06-12 fan wheel ø 250mm blades 9 230V 50/60Hz 115/150W ø 250mm 2450rpm cable length 1400mm sucking suitable capacitor 3µF		
<b>spare parts for</b>	601964		
	<b>GEV No.</b>	365137	<b>Ref. No.</b> —
	capacitor capacity 3µF 450V tolerance 5% 50/60Hz ambient temperature max. -25 to +85°C ø 25mm L 56mm M8 plastic connection cable 250mm 416.17.77GF protection		

fans

axial fans

ebm-papst



<b>GEV No.</b>	601038 <sup>1</sup>	<b>Ref. No.</b>	IB5036830
<b>description</b>	axial fan L 80mm W 80mm H 38mm 230VAC 50/60Hz 12W bearing ball bearing manuf. no. 8556N metal connection cable 300mm ebm-papst fan wheel ø 75mm temp.-resist. 90°C airflow 50m³/h		
<b>For models:</b>	ROLLER		
<b>accessories for</b>	601038		
	<b>GEV No.</b>	691102	<b>Ref. No.</b> —
	guard ø 75mm mounting distance 71mm for axial fan 80mm		

<sup>1</sup>with ball bearings

motors

gear motors

miscellaneous



<b>GEV No.</b>	500488	<b>Ref. No.</b>	IB5036800
<b>description</b>			
<b>For models:</b>	ROLLER		



<b>GEV No.</b>	500730	<b>Ref. No.</b>	IB9865132
<b>description</b>	gear motor CIARAMELLA 150W 230V voltage DC 50/60Hz shaft ø 14mm L 205mm W 115mm H 80mm for citrus juicers		
<b>For models:</b>	APOLLO CE		



1

<b>GEV No.</b>	500932	<b>Ref. No.</b>	IB5036000
<b>description</b>	gear motor CROUZET 3.5W 230V 50Hz shaft $\varnothing$ 8mm L 80mm W 60mm H 40mm for pizza display		
<b>For models:</b>	VETRINETTA 38		



1

<b>GEV No.</b>	500489	<b>Ref. No.</b>	IB5036810
<b>description</b>	gear motor CROUZET type 80804011 24V 4.6rpm shaft $\varnothing$ 0.88mm L 92mm W 64mm H 97mm for toaster		
<b>For models:</b>	ROLLER		

motors

for slicers



1

<b>GEV No.</b>	501507	<b>Ref. No.</b>	19403042
<b>description</b>	motor 230V 1 phase 115W 50Hz 1440rpm shaft $\varnothing$ 15mm shaft length 24mm $\varnothing$ 125mm H 110mm mounting distance 71mm hole distance 155mm hole $\varnothing$ 6mm type M71-4M 220/250/275 CASTELLOTTI		

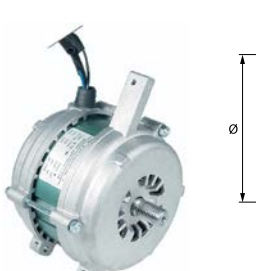

1

<b>GEV No.</b>	500898	<b>Ref. No.</b>	19400101
<b>description</b>	motor 230V 1 phase 147W 50Hz 1400rpm shaft $\varnothing$ 15mm shaft length 20mm $\varnothing$ 125mm H 100mm mounting distance 71mm hole distance 155mm hole $\varnothing$ 6mm type C71/40 220/250/275 CASTELLOTTI		



1

<b>GEV No.</b>	500717	<b>Ref. No.</b>	SM400108
<b>description</b>	motor 230V 1 phase 147W 50Hz 1400rpm shaft $\varnothing$ 15mm shaft length 21mm $\varnothing$ 135mm H 120mm mounting distance 63mm hole distance 155mm hole $\varnothing$ 8mm type C71/40 275-300 CASTELLOTTI		



1

<b>GEV No.</b>	501393	<b>Ref. No.</b>	AVA648A
<b>description</b>	motor 230V 50Hz 1400rpm shaft $\varnothing$ 15mm shaft length 18mm $\varnothing$ 134mm H 140mm mounting distance 83mm hole distance 156mm hole $\varnothing$ 6mm CASTELLOTTI		



1

<b>GEV No.</b>	500718	<b>Ref. No.</b>	SM402215
<b>description</b>	motor 400V 3 phase 210W 50Hz 1400rpm shaft $\varnothing$ 15mm shaft length 22mm $\varnothing$ 135mm H 120mm mounting distance 63mm hole distance 155mm hole $\varnothing$ 8mm 275-300 CASTELLOTTI		



1

<b>GEV No.</b>	500720	<b>Ref. No.</b>	19400408
<b>description</b>	motor 230/400V 3 phase 50/60Hz 890rpm shaft $\varnothing$ 16.5mm shaft length 32mm $\varnothing$ 130mm H 120mm mounting distance 87mm hole $\varnothing$ 8mm GEMMA 350		

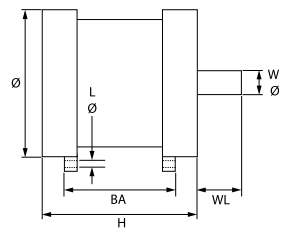

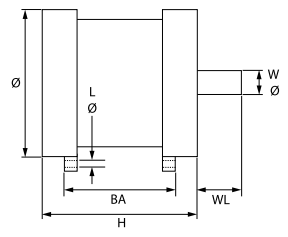

1

<b>GEV No.</b>	500721	<b>Ref. No.</b>	19400108
<b>description</b>	motor 230V 1 phase 50/60Hz 890rpm shaft $\varnothing$ 16.5mm shaft length 32mm $\varnothing$ 130mm H 140mm mounting distance 108mm hole $\varnothing$ 8mm GEMMA 350		

1

<b>GEV No.</b>	500715	<b>Ref. No.</b>	AMC648
<b>description</b>	motor 230V 1 phase 50Hz 1400rpm shaft $\varnothing$ 15mm shaft length 23mm $\varnothing$ 110mm H 98mm mounting distance 69mm hole $\varnothing$ 6mm 220		
<b>For models:</b>	PERLA 220 CE DOM, PERLA 250 CE DOM		
<b>spare parts for</b>	500715		
	<b>GEV No.</b>	365013	<b>Ref. No.</b> 19410301 19410303
	operating capacitor capacity 8 $\mu$ F 400V tolerance 5%Hz ambient temperature max. -25 to +85°C $\varnothing$ 31.5mm L 55mm M8 plastic connection male faston 6.3mm protection		

1

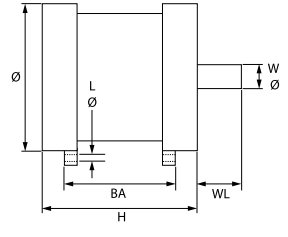
<b>GEV No.</b>	500901	<b>Ref. No.</b>	19400107
<b>description</b>	motor 230V 275W 1 phase 50Hz 1400rpm shaft $\varnothing$ 16.5mm shaft length 32mm $\varnothing$ 130mm H 140mm mounting distance 108mm hole $\varnothing$ 8mm 300-330-350		



1

<b>GEV No.</b>	501425	<b>Ref. No.</b>	SM401408
<b>description</b>	motor 230V 1 phase 50Hz 1400rpm shaft $\varnothing$ 14mm shaft length 63mm hole $\varnothing$ 9.5mm hole distance 110mm		

for bar blender



1

<b>GEV No.</b>	500728	<b>Ref. No.</b>	IB5000800
<b>description</b>	motor for bar blender 220V 450W 50Hz 18000rpm thread M6L shaft $\varnothing$ 8mm mounting distance 36mm H 60mm L 165mm W 80mm mounting thread M4 Dragone CIARAMELLA		
<b>For models:</b>	DRAGONE CE		



1

<b>GEV No.</b>	500729	<b>Ref. No.</b>	IB5000900
<b>description</b>	motor for bar blender 230V 750W 50Hz 14000/24000rpm thread M8L mounting distance 90mm Orione		
<b>For models:</b>	ORIONE CE		



1

<b>GEV No.</b>	500731	<b>Ref. No.</b>	IB9865200
<b>description</b>	motor for bar blender 230V 100W 50/60Hz 14000rpm shaft $\varnothing$ 10mm shaft length 143mm H 83mm L 260mm W 83mm Sirio CIARAMELLA		
<b>For models:</b>	SIRIO 1 GDO CE, SIRIO 2 GDO CE		



1

<b>GEV No.</b>	500732	<b>Ref. No.</b>	IB9865201
<b>description</b>	motor for bar blender 230V 100W 50/60Hz 14000rpm shaft $\varnothing$ 18mm shaft length 143mm H 83mm L 260mm W 83mm Sirio CIARAMELLA		
<b>For models:</b>	SIRIO 1 GDO CE, SIRIO 2 GDO CE		



for cutters



1	<b>GEV No.</b>	500897	<b>Ref. No.</b>	MSC04N136
	<b>description</b>	motor 230V 50Hz 1 phase shaft ø 20mm shaft length 25mm mounting distance 64mm ø 100mm H 140mm C4-C6-C9		
	<b>For models:</b>	C9VV CE		

for ice-cube maker

complete



1	<b>GEV No.</b>	500727	<b>Ref. No.</b>	IB5000801
	<b>description</b>	motor 350W 230V 50Hz 1 phase 12000rpm CIARAMELLA 0.35kW		
	<b>For models:</b>	TRITON CE		

for meat mincers

motors



1	<b>GEV No.</b>	500866	<b>Ref. No.</b>	LF1839701
	<b>description</b>	motor 3000W 230/400V 50Hz 3 phase shaft ø 19mm 1390rpm type M112 ø 175mm H 250mm CSM 3kW		



1	<b>GEV No.</b>	500833	<b>Ref. No.</b>	LF1831001
	<b>description</b>	motor 400V for mincer		



1	<b>GEV No.</b>	500832	<b>Ref. No.</b>	LF1831002
	<b>description</b>	motor for mincer 230V		



1	<b>GEV No.</b>	500834	<b>Ref. No.</b>	LF1832002
	<b>description</b>	motor for mincer 230V		



1	<b>GEV No.</b>	500854	<b>Ref. No.</b>	LF1833502
	<b>description</b>	motor for mincer 230V		



1	<b>GEV No.</b>	500856	<b>Ref. No.</b>	LF1834002
	<b>description</b>	motor for mincer 230V		



1	<b>GEV No.</b>	500861	<b>Ref. No.</b>	LF1838303
	<b>description</b>	motor for mincer 230V		



1	<b>GEV No.</b>	500863	<b>Ref. No.</b>	LF1838603
	<b>description</b>	motor for mincer 230V		



1	<b>GEV No.</b>	500865	<b>Ref. No.</b>	LF1839703
	<b>description</b>	motor for mincer 230V		



1

<b>GEV No.</b>	500835	<b>Ref. No.</b>	LF1832001
<b>description</b>	motor for mincer 400V		



1

<b>GEV No.</b>	500857	<b>Ref. No.</b>	LF1834001
<b>description</b>	motor for mincer 400V		



1

<b>GEV No.</b>	500862	<b>Ref. No.</b>	LF1838301
<b>description</b>	motor for mincer 400V		



1

<b>GEV No.</b>	500864	<b>Ref. No.</b>	LF1838601
<b>description</b>	motor for mincer 400V		



1

<b>GEV No.</b>	500860	<b>Ref. No.</b>	LF2037050
<b>description</b>	motor meat mincer/cheese grater 230V		



1

<b>GEV No.</b>	500858	<b>Ref. No.</b>	IV5050802
<b>description</b>	motor meat mincer/cheese grater 230V 1 phase		
<b>For models:</b>	TC 12 MAGNUM INGRANAGGI CE		



1

<b>GEV No.</b>	500859	<b>Ref. No.</b>	IV5050803
<b>description</b>	motor meat mincer/cheese grater 400V		
<b>For models:</b>	TC 12 MAGNUM INGRANAGGI CE		

rotors



1

<b>GEV No.</b>	500726	<b>Ref. No.</b>	MF2095A
<b>description</b>	rotor 230V ø 89.2mm shaft ø 25mm shaft length 357mm Mod.12 meat mincer/cheese grater		



1

<b>GEV No.</b>	500725	<b>Ref. No.</b>	MF2202
<b>description</b>	rotor 400V ø 89.2mm shaft ø 25mm shaft length 357mm Mod.22 meat mincer/cheese grater		
<b>For models:</b>	TC22E CE, TCG 22 E CE		

stators

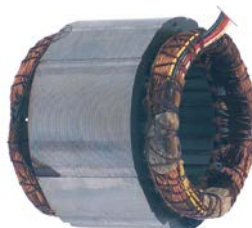

1

<b>GEV No.</b>	500825	<b>Ref. No.</b>	MF0004
<b>description</b>	stator 230V 50Hz 4-pole 1400rpm 1 phase ø 110mm ID ø 66mm H 60mm with temperature protection Mod.8		



1

<b>GEV No.</b>	500828	<b>Ref. No.</b>	MF0102 MF2096
<b>description</b>	stator 230V 50Hz 4-pole 1400rpm 1 phase ø 150mm ID ø 90mm H 70mm with temperature protection Mod.12		

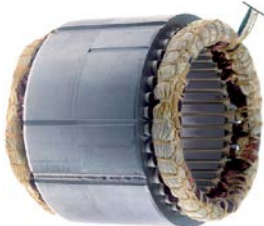
1

<b>GEV No.</b>	500830	<b>Ref. No.</b>	MF0170 MF2203
<b>description</b>	stator 230V 50Hz 6-pole 900rpm 1 phase ø 150mm ID ø 103mm H 90mm with temperature protection Mod.22		
<b>For models:</b>	TC22E CE, TCG 22 E CE		

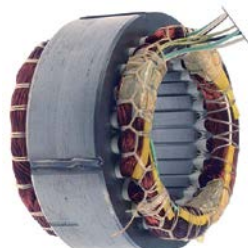

1

<b>GEV No.</b>	500829	<b>Ref. No.</b>	MF0103 MF2097
<b>description</b>	stator 400V 50Hz 4-pole 1400rpm 3 phase ø 150mm ID ø 83.6mm H 50mm with temperature protection Mod.12		



1

<b>GEV No.</b>	500831	<b>Ref. No.</b>	MF0171 MF2204
<b>description</b>	stator 400V 50Hz 6-pole 900rpm 3 phase ø 150mm ID ø 90mm H 70mm with temperature protection Mod.22		
<b>For models:</b>	TC22E CE, TCG 22 E CE		

for vegetable slicers



1

<b>GEV No.</b>	500719	<b>Ref. No.</b>	IV5050002
<b>description</b>	motor 230V 515W 50Hz 1 phase shaft ø 14mm shaft length 37mm mounting distance 154mm TM		
<b>For models:</b>	TV-TM INOX, TV-TM INOX07		

for potato peelers



1

<b>GEV No.</b>	500711	<b>Ref. No.</b>	RG04260A
<b>description</b>	motor 230V 50Hz 1 phase shaft ø 10mm shaft length 21mm 1400rpm ø 120mm H 170mm mounting distance 136mm PP4 Expo		



1

<b>GEV No.</b>	500713	<b>Ref. No.</b>	RG08260A
<b>description</b>	motor 230V 50Hz 1 phase shaft ø 12mm shaft length 23mm 1400rpm type RG08260A mounting distance 188mm PP8 Expo		
<b>For models:</b>	PP EXPO 4 CE, PP EXPO 8 CE		



1

<b>GEV No.</b>	500712	<b>Ref. No.</b>	RG04260B
<b>description</b>	motor 400V 50Hz 3 phase shaft ø 10mm shaft length 21mm 1400rpm ø 120mm H 170mm mounting distance 136mm PP4 Expo		



1

<b>GEV No.</b>	500714	<b>Ref. No.</b>	RG08260B
<b>description</b>	motor 400V 50Hz 3 phase shaft ø 12mm shaft length 23mm 1400rpm mounting distance 188mm PP8 Expo		
<b>For models:</b>	PP EXPO 4 CE, PP EXPO 8 CE		

for bone saws



1

<b>GEV No.</b>	601686	<b>Ref. No.</b>	LF1810502
<b>description</b>	motor 230V 750W 50Hz 1 phase shaft $\varnothing$ 18mm shaft length 33mm $\varnothing$ 180mm H 220mm mounting distance 44mm hole $\varnothing$ 7mm type MM90S6 SO2004 CSM		

for mozzarella slicers

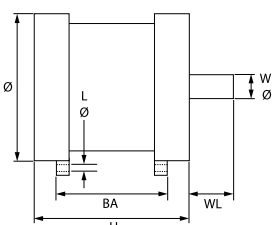
1

<b>GEV No.</b>	500723	<b>Ref. No.</b>	IB5053003
<b>description</b>	motor 230/400V 260W 50/60Hz 3 phase 1400rpm shaft $\varnothing$ 15mm shaft length 31mm $\varnothing$ 115mm H 155mm mounting distance 110mm hole $\varnothing$ 10mm type C71/70 Athos CASTELLOTTI		

1

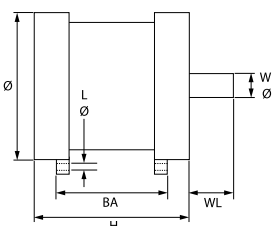
<b>GEV No.</b>	500722	<b>Ref. No.</b>	IB5053002
<b>description</b>	motor 230V 260W 50Hz 1 phase 1400rpm shaft $\varnothing$ 15mm shaft length 31mm $\varnothing$ 115mm H 155mm mounting distance 110mm hole $\varnothing$ 10mm type C71/70 Athos CASTELLOTTI		

1

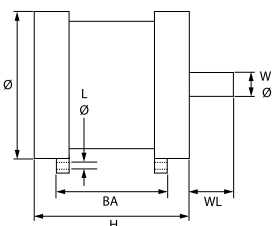
<b>GEV No.</b>	500716	<b>Ref. No.</b>	IB5053004
<b>description</b>	motor 240V 260W 50Hz 1 phase 1400rpm shaft $\varnothing$ 15mm shaft length 31mm $\varnothing$ 115mm H 155mm mounting distance 110mm hole $\varnothing$ 10mm Athos		

1

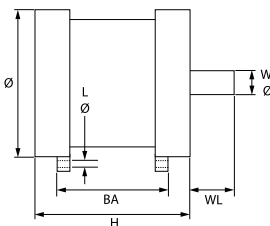
<b>GEV No.</b>	500867	<b>Ref. No.</b>	IB5053403
<b>description</b>	motor 400V 50Hz 3 phase shaft $\varnothing$ 19mm shaft length 30mm $\varnothing$ 115mm H 155mm mounting distance 110mm hole $\varnothing$ 10mm		

universal



1

<b>GEV No.</b>	501536	<b>Ref. No.</b>	29401502
<b>description</b>	motor 250W 230V 50Hz 1 phase shaft $\varnothing$ 11mm flange $\varnothing$ 90mm 2800rpm type 1-MP63 A2 $\varnothing$ 120mm H 130mm L 195mm fixing dimensions 80x100mm 0.25kW		



1

<b>GEV No.</b>	500916	<b>Ref. No.</b>	IB8000501
<b>description</b>	motor 230V 50Hz		



Image not available

1

<b>GEV No.</b>	500832	<b>Ref. No.</b>	LF1831002
<b>description</b>	motor for mincer 230V		







Image not available

1

<b>GEV No.</b>	500834	<b>Ref. No.</b>	LF1832002
<b>description</b>	motor for mincer 230V		

 Image not available 1			
<b>GEV No.</b>	500850	<b>Ref. No.</b>	LF1832502
<b>description</b>	motor for mincer 230V		

 Image not available 1			
<b>GEV No.</b>	500865	<b>Ref. No.</b>	LF1839703
<b>description</b>	motor for mincer 230V		

 Image not available 1			
<b>GEV No.</b>	500852	<b>Ref. No.</b>	LF1832602
<b>description</b>	motor for mincer 230V		

 Image not available 1			
<b>GEV No.</b>	500835	<b>Ref. No.</b>	LF1832001
<b>description</b>	motor for mincer 400V		

 Image not available 1			
<b>GEV No.</b>	500854	<b>Ref. No.</b>	LF1833502
<b>description</b>	motor for mincer 230V		

 Image not available 1			
<b>GEV No.</b>	500851	<b>Ref. No.</b>	LF1832501
<b>description</b>	motor for mincer 400V		

 Image not available 1			
<b>GEV No.</b>	500856	<b>Ref. No.</b>	LF1834002
<b>description</b>	motor for mincer 230V		

 Image not available 1			
<b>GEV No.</b>	500853	<b>Ref. No.</b>	LF1832601
<b>description</b>	motor for mincer 400V		

 Image not available 1			
<b>GEV No.</b>	500861	<b>Ref. No.</b>	LF1838303
<b>description</b>	motor for mincer 230V		

 Image not available 1			
<b>GEV No.</b>	500855	<b>Ref. No.</b>	LF1833501
<b>description</b>	motor for mincer 400V		

 Image not available 1			
<b>GEV No.</b>	500863	<b>Ref. No.</b>	LF1838603
<b>description</b>	motor for mincer 230V		

 Image not available 1			
<b>GEV No.</b>	500857	<b>Ref. No.</b>	LF1834001
<b>description</b>	motor for mincer 400V		





1

<b>GEV No.</b>	500862	<b>Ref. No.</b>	LF1838301
<b>description</b>	motor for mincer 400V		



1

<b>GEV No.</b>	500864	<b>Ref. No.</b>	LF1838601
<b>description</b>	motor for mincer 400V		



1

<b>GEV No.</b>	500860	<b>Ref. No.</b>	LF2037050
<b>description</b>	motor meat mincer/cheese grater 230V		



1

<b>GEV No.</b>	500858	<b>Ref. No.</b>	IV5050802
<b>description</b>	motor meat mincer/cheese grater 230V 1 phase		
<b>For models:</b>	TC 12 MAGNUM INGRANAGGI CE		



1

<b>GEV No.</b>	500859	<b>Ref. No.</b>	IV5050803
<b>description</b>	motor meat mincer/cheese grater 400V		
<b>For models:</b>	TC 12 MAGNUM INGRANAGGI CE		

## pumps

### booster pumps II

#### accessories



1

<b>GEV No.</b>	365015	<b>Ref. No.</b>	19410307
<b>description</b>	operating capacitor capacity 10µF 400V tolerance 5%Hz ambient temperature max. -25 to +85°C ø 35.5mm L 59mm M8 plastic connection male faston 6.3mm protection		



1

<b>GEV No.</b>	365012	<b>Ref. No.</b>	19410308
<b>description</b>	operating capacitor capacity 6.3µF 450V tolerance 5% 50Hz ambient temperature max. -25 to +85°C ø 30mm L 61mm M8 plastic connection male faston 6.3mm protection		

## condensators & interference suppression filters

### operating capacitors

#### plastic



1

<b>GEV No.</b>	365015	<b>Ref. No.</b>	19410307
<b>description</b>	operating capacitor capacity 10µF 400V tolerance 5%Hz ambient temperature max. -25 to +85°C ø 35.5mm L 59mm M8 plastic connection male faston 6.3mm protection		





1

<b>GEV No.</b>	365014	<b>Ref. No.</b>	MF0022 RG04290
<b>description</b>	operating capacitor capacity 12.5µF 450V tolerance 5%Hz ambient temperature max. -25 to +85°C ø 35mm L 70mm M8 plastic connection male faston 6.3mm 45S.C3DS.12.5 protection		



			
1			
<b>GEV No.</b>	365021	<b>Ref. No.</b>	MF0192 MF2144
<b>description</b>	operating capacitor capacity 16µF 425V tolerance 5% 50/60Hz ambient temperature max. -25 to +85°C ø 35mm L 73mm single M8 plastic connection male faston 6.3mm 416.10.99 protection		

			
1			
<b>GEV No.</b>	365019	<b>Ref. No.</b>	IV5820020 MF2223
<b>description</b>	operating capacitor capacity 20µF 400V tolerance 5% 50/60Hz ambient temperature max. -25 to +85°C ø 39.5mm L 70mm M8 plastic connection male faston 6.3mm 16.10.25. protection		
<b>For models:</b>	TC22E CE, TCG 22 E CE, TV-TM INOX, TV-TM INOX07		

			
1			
<b>GEV No.</b>	365109	<b>Ref. No.</b>	IV5820025
<b>description</b>	operating capacitor capacity 25µF 400V tolerance 5% 50/60Hz ambient temperature max. -25 to +85°C ø 44mm L 70mm M8 plastic connection male faston 6.3mm protection		
<b>For models:</b>	TC 12 MAGNUM INGRANAGGI CE		

			
1			
<b>GEV No.</b>	365092	<b>Ref. No.</b>	RG08290
<b>description</b>	operating capacitor capacity 25µF 450V tolerance 5% 50Hz ø 45mm L 75mm plastic		

			
1			
<b>GEV No.</b>	365012	<b>Ref. No.</b>	19410308
<b>description</b>	operating capacitor capacity 6.3µF 450V tolerance 5% 50Hz ambient temperature max. -25 to +85°C ø 30mm L 61mm M8 plastic connection male faston 6.3mm protection		

			
1			
<b>GEV No.</b>	365013	<b>Ref. No.</b>	19410301 19410303
<b>description</b>	operating capacitor capacity 8µF 400V tolerance 5% 50/60Hz ambient temperature max. -25 to +85°C ø 31.5mm L 55mm M8 plastic connection male faston 6.3mm protection		
<b>For models:</b>	PERLA 220 CE DOM, PERLA 250 CE DOM		

## fuses

### fine fuses

#### various

			
1			
<b>GEV No.</b>	358184	<b>Ref. No.</b>	PA62304210BP
<b>description</b>	fine fuse size ø6x30mm 10A slow-acting rated 250V Qty 1 pcs		

## electric accessories

### plugs - couplings - power sockets

#### appliance sockets/plugs

#### low temperature appliances 70°C

			
1			
<b>GEV No.</b>	550704	<b>Ref. No.</b>	IB5520000
<b>description</b>	low temperature appliance plug C14 male faston 6.3mm max 10A/250V T70 mounting distance 40mm hole ø 3.5mm thermoplastic		

			
1			
<b>GEV No.</b>	550962 <sup>1</sup>	<b>Ref. No.</b>	KODK008A
<b>description</b>	low temperature appliance plug C14 max 15A/250V T70 with cable		

<sup>1</sup>with cable



cables

power supply cables



1

<b>GEV No.</b>	550726	<b>Ref. No.</b>	KODK008B
<b>description</b>	low temperature appliance supply cable CEE7/7 - C15 3-pole contacts P+N+E 1mm <sup>2</sup> max. 10A max 250V 2.0m H05VVF T70 2-pole + earthing insulation PVC		



1

<b>GEV No.</b>	550927	<b>Ref. No.</b>	19410530
<b>description</b>	low temperature appliance supply cable CEE7/7 3-pole 1mm <sup>2</sup> 1.5m T70 with connector strip insulation PVC		
<b>For models:</b>	PERLA 220 CE DOM, PERLA 250 CE DOM, TV-TM INOX, TV-TM INOX07		



1

<b>GEV No.</b>	550553	<b>Ref. No.</b>	IB5503010
<b>description</b>	medium temperature appliance supply cable CEE7/7 - C15 3-pole contacts P+N+E 1mm <sup>2</sup> max. 10A max 250V 2.0m H05VVF T120 insulation PVC countries D/F/B/I black		
<b>For models:</b>	ORIONE CE, SIRIO 1 GDO CE, SIRIO 2 GDO CE		



1

<b>GEV No.</b>	550767	<b>Ref. No.</b>	19410536
<b>description</b>	plug CEE 4-pole 3-pole+Nmm <sup>2</sup> max. 16A max 415V 1.5m with cable		

accessories

cable glands

threaded cable glands

screw connections



1

<b>GEV No.</b>	550990 <sup>1</sup>	<b>Ref. No.</b>	RG04332 RG04334
<b>description</b>	cable gland thread PG7 cable ø 8mm mounting ø 15mm Qty 1 plastic WS 19		
<b>For models:</b>	PP EXPO 4 CE, PP EXPO 8 CE		

<sup>1</sup>incl. fastening nut

connection cables



1

<b>GEV No.</b>	550928	<b>Ref. No.</b>	19410718
<b>description</b>	connection cable L 300mm 2-pole		

terminals

terminal blocks



1

<b>GEV No.</b>	550232	<b>Ref. No.</b>	19410822
<b>description</b>	lustre terminal 12-pole cross section 2.5mm <sup>2</sup> max. 32A max 450V temp.-resist. 150°C		
<b>For models:</b>	APOLLO CE, SIRIO 1 GDO CE, SIRIO 2 GDO CE		

connection terminals with screw/faston connections



1

<b>GEV No.</b>	550961 <sup>1</sup>	<b>Ref. No.</b>	IB469 IGS469
<b>description</b>	power terminal block 4-pole max. 40A max 450V connection ø6mm <sup>2</sup> / F6.3 temp.-resist. 150°C cross section 6mm <sup>2</sup> with ground lug		
<b>For models:</b>	CREPIERA TONDA		

<sup>1</sup>with ground lug



connection terminals with strain relief



1

<b>GEV No.</b>	550356	<b>Ref. No.</b>	MSC04N202A
<b>description</b>	power terminal block 2-pole max 450V max. 16A cable ø 15mm cross section 1.5mm <sup>2</sup>		
<b>For models:</b>	C9VV CE		



1

<b>GEV No.</b>	550991	<b>Ref. No.</b>	IB5893000
<b>description</b>	power terminal block 3-pole max 400V max. 16A cable ømm cross section 2.5mm <sup>2</sup> connection with screw with cable run		



1

<b>GEV No.</b>	550764	<b>Ref. No.</b>	MSC04N202 RG04207
<b>description</b>	power terminal block 3-pole max 450V max. 16A cable ø 14.5mm cross section 1.5mm <sup>2</sup> connection male faston 6.3mm mounting ø 28mm with strain relief		
<b>For models:</b>	PP EXPO 4 CE, PP EXPO 8 CE		



1

<b>GEV No.</b>	550765	<b>Ref. No.</b>	RG04207 +2x 19410802
<b>description</b>	power terminal block 5-pole max 450V max. 16A cable ø 14.5mm cross section 1.5mm <sup>2</sup> connection male faston 6.3mm mounting ø 28mm with strain relief		

accessories

holders



1

<b>GEV No.</b>	550766	<b>Ref. No.</b>	19410820
<b>description</b>	bracket for connector strip cross section 2.5mm <sup>2</sup> 3-pole plastic L 51mm W 31mm		
<b>For models:</b>	APOLLO CE		

equipment-specific units  
for slicers

covers



1

<b>GEV No.</b>	694826	<b>Ref. No.</b>	19510235	
<b>description</b>	blade covering ø 255mm for knife ø 300mm mounting ø 17			
<b>accessories for</b>	694826			
	<b>GEV No.</b>	698242	<b>Ref. No.</b>	19530930.10 SM133417
	threaded bush L 18mm for slicer ET M12 IT M6			



1

<b>GEV No.</b>	693786	<b>Ref. No.</b>	SM500503
<b>description</b>	blade covering ø 255mm for knife ø 300mm mounting thread M10 mounting ø 17		



1

<b>GEV No.</b>	697457	<b>Ref. No.</b>	AMG006
<b>description</b>	blade covering for knife ø 250mm aluminium		
<b>For models:</b>	PERLA 250 CE DOM		



1

<b>GEV No.</b>	697522	<b>Ref. No.</b>	AMC006
<b>description</b>	blade covering ø 230mm for knife ø 220mm mounting thread M6 mounting ø 12 aluminium		
<b>For models:</b>	PERLA 220 CE DOM		



1

<b>GEV No.</b>	699484	<b>Ref. No.</b>	195102025
<b>description</b>	blade covering ø 263mm for knife ø 250mm mounting thread M6 aluminium		



1

<b>GEV No.</b>	698457	<b>Ref. No.</b>	195102026
<b>description</b>	blade covering ø 273mm for knife ø 250mm aluminium		

## bushes



1

<b>GEV No.</b>	698246	<b>Ref. No.</b>	SM133418
<b>description</b>	threaded bush ET M10x1 blade cover		



1

<b>GEV No.</b>	698242	<b>Ref. No.</b>	19530930.10 SM133417
<b>description</b>	threaded bush L 18mm for slicer ET M12 IT M6		

## handles



1

<b>GEV No.</b>	696266	<b>Ref. No.</b>	AMA008
<b>description</b>	cone handle thread M4 ø 9mm L 14mm aluminium slicer		
<b>For models:</b>	PERLA 220 CE DOM, PERLA 250 CE DOM		



1

<b>GEV No.</b>	696267	<b>Ref. No.</b>	19021110
<b>description</b>	mushroom cap handle thread M4 ø 16mm L 18.5mm aluminium slicer		

## miscellaneous



1

<b>GEV No.</b>	697523	<b>Ref. No.</b>	SM503404
<b>description</b>	protector for knife ø 350mm ø 360mm aluminium GEMMA 350		

## sliding plates



1

<b>GEV No.</b>	697524	<b>Ref. No.</b>	AMC040
<b>description</b>	sliding plate 220 mounting distance 70mm mounting thread M6		
<b>For models:</b>	PERLA 220 CE DOM		





1

<b>GEV No.</b>	697525	<b>Ref. No.</b>	AMG040
<b>description</b>	sliding plate 250 mounting distance 70mm mounting thread M8		
<b>For models:</b>	PERLA 250 CE DOM		







			
1			
<b>GEV No.</b>	697526	<b>Ref. No.</b>	SM504120
<b>description</b>	sliding plate 300 mounting distance 87mm		

holders			
			
1			
<b>GEV No.</b>	696239	<b>Ref. No.</b>	195107E07
<b>description</b>	bracket hole $\varnothing$ 19mm mounting distance 120mm L 160mm W 80mm 300-330		

			
1			
<b>GEV No.</b>	696240	<b>Ref. No.</b>	AMM058 AMR058
<b>description</b>	bracket hole $\varnothing$ 7.3mm mounting distance 70mm L 160mm W 20mm shaft $\varnothing$ 15mm shaft L 38mm 220-250		
<b>For models:</b>	PERLA 220 CE DOM		

			
1			
<b>GEV No.</b>	696238	<b>Ref. No.</b>	SM500318
<b>description</b>	bracket hole $\varnothing$ 8mm mounting distance 98mm L 140mm W 48mm shaft $\varnothing$ 15mm shaft L 46mm 300		

hand guard			
			
1			
<b>GEV No.</b>	696252	<b>Ref. No.</b>	19563002
<b>description</b>	protector $\varnothing$ 68mm ID $\varnothing$ 18mm thickness 10mm for sliding plate		

			
1			
<b>GEV No.</b>	696251	<b>Ref. No.</b>	AMA062
<b>description</b>	protector $\varnothing$ 68mm ID $\varnothing$ 25.8mm thickness 10mm for sliding plate		
<b>For models:</b>	PERLA 220 CE DOM, PERLA 250 CE DOM		

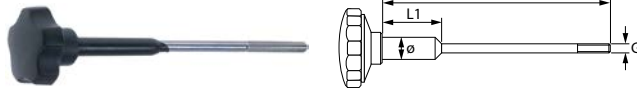
locking screws			
			
1			
<b>GEV No.</b>	697513	<b>Ref. No.</b>	AMC032 AMG032
<b>description</b>	locking screw thread M6 L 148mm $\varnothing$ 10mm L1 51mm handle $\varnothing$ 40mm		
<b>For models:</b>	PERLA 220 CE DOM, PERLA 250 CE DOM		

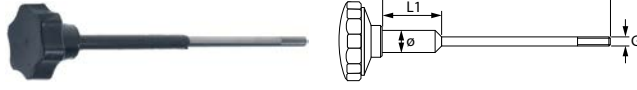
			
1			
<b>GEV No.</b>	697709	<b>Ref. No.</b>	AVA032
<b>description</b>	locking screw thread M6 L 170mm $\varnothing$ 8mm L1 80mm		

			
1			
<b>GEV No.</b>	698078	<b>Ref. No.</b>	SM212740
<b>description</b>	locking screw thread M6 L 200mm $\varnothing$ 10mm L1 80mm		

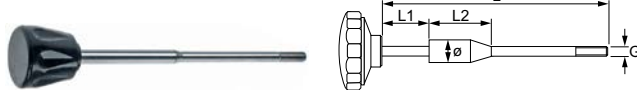
			
1			
<b>GEV No.</b>	697734	<b>Ref. No.</b>	AVG032
<b>description</b>	locking screw thread M8 L 198mm $\varnothing$ 10mm L2 24mm		

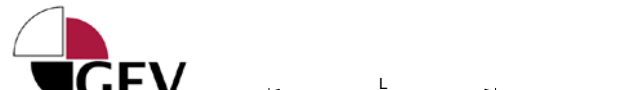
			
1			
<b>GEV No.</b>	697738	<b>Ref. No.</b>	SM592021
<b>description</b>	locking screw thread M8 L 200mm $\varnothing$ 10mm D1 $\varnothing$ 10mm L2 23mm L3 23mm without handle		

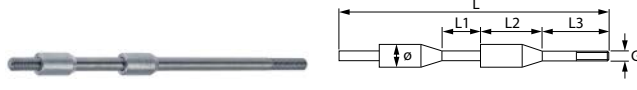
			
1			
<b>GEV No.</b>	697735	<b>Ref. No.</b>	19530501
<b>description</b>	locking screw thread M6 L 160mm $\varnothing$ 10mm D1 $\varnothing$ 10mm L2 18mm L3 18mm		







			
1			
<b>GEV No.</b>	697740	<b>Ref. No.</b>	19530532
<b>description</b>	locking screw thread M6 L 185mm $\varnothing$ 10mm D1 $\varnothing$ 10mm L2 18mm L3 18mm		
<b>accessories for</b>	697740		
	<b>GEV No.</b>	111054	<b>Ref. No.</b>
			19564016
	star handle thread M6 $\varnothing$ 40mm L 29mm blue		

Table continues overleaf

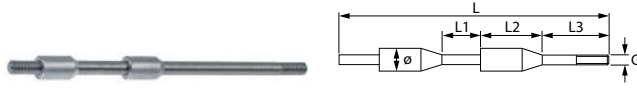
<b>accessories for</b>	697740		
	<b>GEV No.</b>	698200	<b>Ref. No.</b> 19562502
	star handle thread M6 $\phi$ 40mm L 29mm black		

	Image not available		
1			
<b>GEV No.</b>	697736	<b>Ref. No.</b>	19530554
<b>description</b>	locking screw thread M8 L 230mm $\phi$ 12mm D1 $\phi$ 12mm L2 25mm L3 25mm without handle		

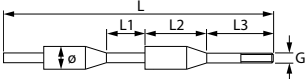
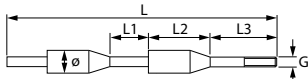
1			
<b>GEV No.</b>	696230	<b>Ref. No.</b>	19530507
<b>description</b>	locking screw thread M8 L 235mm $\phi$ 10mm D1 $\phi$ 10mm without handle		

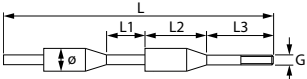
	Image not available		
1			
<b>GEV No.</b>	697737	<b>Ref. No.</b>	19530509
<b>description</b>	locking screw thread M8 L 240mm $\phi$ 12mm D1 $\phi$ 12mm L2 23mm L3 23mm without handle		

## handles

1			
<b>GEV No.</b>	698200	<b>Ref. No.</b>	19562502
<b>description</b>	star handle thread M6 $\phi$ 40mm L 29mm black		

1			
<b>GEV No.</b>	111054	<b>Ref. No.</b>	19564016
<b>description</b>	star handle thread M6 $\phi$ 40mm L 29mm blue		

1			
<b>GEV No.</b>	697443	<b>Ref. No.</b>	19562504 19564013
<b>description</b>	star handle thread M8 $\phi$ 50mm L 29mm black		
<b>For models:</b>	PERLA 220 CE DOM, PERLA 250 CE DOM		

## adjustment knobs

1			
<b>GEV No.</b>	697509	<b>Ref. No.</b>	AMC102
<b>description</b>	adjusting knob 0-12 $\phi$ 55mm shaft $\phi$ 12mm shaft L 35mm handle $\phi$ 42mm		
<b>For models:</b>	PERLA 220 CE DOM		

1			
<b>GEV No.</b>	697510	<b>Ref. No.</b>	19562402 19564020
<b>description</b>	adjusting knob 0-15 $\phi$ 60mm shaft $\phi$ 12mm shaft L 32mm		

1			
<b>GEV No.</b>	696693	<b>Ref. No.</b>	19562404
<b>description</b>	adjusting knob 0-15 $\phi$ 68mm shaft $\phi$ 18mm shaft L 47mm handle $\phi$ 53mm		

1			
<b>GEV No.</b>	697511	<b>Ref. No.</b>	19562404 old
<b>description</b>	adjusting knob 0-15 $\phi$ 68mm shaft $\phi$ 18mm shaft L 47mm handle $\phi$ 58mm		





 <p>1</p>			
<b>GEV No.</b>	696500	<b>Ref. No.</b>	19562404 (old version)
<b>description</b>	adjusting knob 0-24 ø 68mm shaft ø 18mm shaft L 37mm handle ø 56mm		

 <p>1</p>			
<b>GEV No.</b>	697512	<b>Ref. No.</b>	19562410
<b>description</b>	ring for handle ø 72mm ID ø 35mm thickness 10mm plastic black		

<p>eccentric disc for slice thickness</p>  <p>1</p>			
<b>GEV No.</b>	697507	<b>Ref. No.</b>	SM190100011
<b>description</b>	eccentrics for cutting thickness hole ø 12mm groove width 6.5mm ED ø 56mm thickness 21mm		

 <p>1</p>			
<b>GEV No.</b>	697756	<b>Ref. No.</b>	19563505LG
<b>description</b>	eccentrics for cutting thickness hole ø 12mm groove width 6mm ED ø 56mm thickness 10mm		

 <p>1</p>			
<b>GEV No.</b>	697506	<b>Ref. No.</b>	AMI092
<b>description</b>	eccentrics for cutting thickness hole ø 12mm groove width 6mm ED ø 56mm thickness 20mm		
<b>For models:</b>	PERLA 220 CE DOM, PERLA 250 CE DOM		

 <p>1</p>			
<b>GEV No.</b>	697508	<b>Ref. No.</b>	SM190100022
<b>description</b>	eccentrics for cutting thickness hole ø 18mm groove width 8mm ED ø 85mm thickness 24.5mm		

<p>springs</p>  <p>1</p>			
<b>GEV No.</b>	696211	<b>Ref. No.</b>	AMC672
<b>description</b>	compression spring ø 11.5mm L 46mm wire gauge ø 1.3mm slicer 220		
<b>For models:</b>	PERLA 220 CE DOM, PERLA 250 CE DOM		

 <p>1</p>			
<b>GEV No.</b>	696208	<b>Ref. No.</b>	SM370111
<b>description</b>	compression spring ø 13.5mm L 57mm wire gauge ø 1.4mm slicer 275-300		

 <p>1</p>			
<b>GEV No.</b>	696209	<b>Ref. No.</b>	19390205
<b>description</b>	compression spring ø 13.5mm L 92mm wire gauge ø 1.4mm slicer		

 <p>1</p>			
<b>GEV No.</b>	696210	<b>Ref. No.</b>	19390600
<b>description</b>	compression spring ø 14mm L 16mm wire gauge ø 1.2mm slicer 220-250		

 <p>1</p>			
<b>GEV No.</b>	696205	<b>Ref. No.</b>	SM370104
<b>description</b>	compression spring ø 22/28mm L 22mm wire gauge ø 2mm conical slicer D1 ø 22mm D2 ø 28mm 250-300		

 <p>1</p>			
<b>GEV No.</b>	696207	<b>Ref. No.</b>	AMC244
<b>description</b>	compression spring ø 23/25mm L 19mm wire gauge ø 1.5mm conical slicer D1 ø 23mm D2 ø 25mm 220-250		
<b>For models:</b>	PERLA 220 CE DOM, PERLA 250 CE DOM		

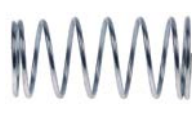
 <p>1</p>			
<b>GEV No.</b>	696206	<b>Ref. No.</b>	AMC254 AMG254
<b>description</b>	compression spring ø 23/25mm L 53mm wire gauge ø 1.5mm conical slicer D1 ø 23mm D2 ø 25mm 220-250		
<b>For models:</b>	PERLA 220 CE DOM, PERLA 250 CE DOM		



<b>GEV No.</b>	696212	<b>Ref. No.</b>	AMA814
<b>description</b>	compression spring $\varnothing$ 7.6mm L 22mm wire gauge $\varnothing$ 0.7mm slicer 195-220		
<b>For models:</b>	PERLA 220 CE DOM		



<b>GEV No.</b>	696213	<b>Ref. No.</b>	AME410
<b>description</b>	compression spring $\varnothing$ 7.6mm L 28mm wire gauge $\varnothing$ 0.7mm slicer PARKER		
<b>For models:</b>	PERLA 250 CE DOM		

## spring washers



<b>GEV No.</b>	696253	<b>Ref. No.</b>	19342005 AMA096
<b>description</b>	spring washer ID $\varnothing$ 12mm ED $\varnothing$ 25mm Qty 1 pcs		
<b>For models:</b>	PERLA 220 CE DOM, PERLA 250 CE DOM		



<b>GEV No.</b>	696254	<b>Ref. No.</b>	19342006
<b>description</b>	spring washer ID $\varnothing$ 19mm ED $\varnothing$ 32mm Qty 1 pcs		

## guiding pieces

### for sliding plates



<b>GEV No.</b>	696246	<b>Ref. No.</b>	19500107
<b>description</b>	guide L 112mm W 56mm hole $\varnothing$ 19mm shaft $\varnothing$ 19mm shaft L 56mm mounting thread M8 300-330 aluminium		



<b>GEV No.</b>	696247	<b>Ref. No.</b>	AMM064 AMR064
<b>description</b>	guide L 80mm W 54mm H 37mm hole $\varnothing$ 15mm shaft intake $\varnothing$ 12mm mounting thread M8 220-250		
<b>For models:</b>	PERLA 220 CE DOM, PERLA 250 CE DOM		



<b>GEV No.</b>	696245	<b>Ref. No.</b>	SM500218
<b>description</b>	guide L 87mm W 56mm H 38mm hole $\varnothing$ 15mm shaft intake $\varnothing$ 12mm mounting thread M6 275-300 aluminium		



<b>GEV No.</b>	696276	<b>Ref. No.</b>	AMA066
<b>description</b>	connection plate L 83mm W 12mm thickness 4mm hole $\varnothing$ 6.5mm hole distance 69mm		
<b>For models:</b>	PERLA 220 CE DOM, PERLA 250 CE DOM		

## for carriage



<b>GEV No.</b>	696244	<b>Ref. No.</b>	SM500618
<b>description</b>	guide L 120mm W 122mm H 66mm hole $\varnothing$ 18mm thread M22 220-250		



<b>GEV No.</b>	696243	<b>Ref. No.</b>	AMM212
<b>description</b>	guide L 122mm W 116mm H 59mm hole $\varnothing$ 20mm thread M8 220-250		
<b>For models:</b>	PERLA 220 CE DOM, PERLA 250 CE DOM		





<b>GEV No.</b>	696279	<b>Ref. No.</b>	SM190830
<b>description</b>	connection plate L 37mm W 33mm hole distance 18mm aperture 6x12mm thickness 2.5mm		





<b>GEV No.</b>	696270	<b>Ref. No.</b>	AMA220
<b>description</b>	grub screw slicer thread M8 L 27mm plastic		
<b>For models:</b>	PERLA 220 CE DOM, PERLA 250 CE DOM		





			
1			
<b>GEV No.</b>	696289	<b>Ref. No.</b>	19534029
<b>description</b>	knurled nut for carriage thread M22 ø 32mm chrome-plated 220-250 Qty 1 pcs WS H 7mm		

			
1			
<b>GEV No.</b>	696832	<b>Ref. No.</b>	19565001
<b>description</b>	pressure pin L 8mm ø 5mm Qty 5 pcs		

			
1			
<b>GEV No.</b>	696341	<b>Ref. No.</b>	SM561504
<b>description</b>	screw for carriage thread M8 L 16mm ø 32mm		

			
1			
<b>GEV No.</b>	696231	<b>Ref. No.</b>	19534034
<b>description</b>	spindle thread M8 L 32mm ø 10.5mm 220-250		

			
1			
<b>GEV No.</b>	696288	<b>Ref. No.</b>	19534024
<b>description</b>	threaded bush thread M22 L 20mm ID ø 11mm 220-250		

			
1			
<b>GEV No.</b>	696278	<b>Ref. No.</b>	19533200
<b>description</b>	threaded plate thread M6 L 36mm W 15mm hole distance 18mm thickness 4mm		

<b>bushes</b>			
			
1			
<b>GEV No.</b>	696709	<b>Ref. No.</b>	19324102
<b>description</b>	bush ED ø 14mm ID ø 12mm H 12mm bronze		

			
1			
<b>GEV No.</b>	696283	<b>Ref. No.</b>	19324108
<b>description</b>	bush for carriage ED ø 20mm ID ø 18mm H 20mm bronze		

			
1			
<b>GEV No.</b>	696282	<b>Ref. No.</b>	19324005
<b>description</b>	bush for carriage ED ø 22mm ID ø 19mm H 20mm bronze		

<b>spindles</b>			
			
1			
<b>GEV No.</b>	696229	<b>Ref. No.</b>	19530612
<b>description</b>	spindle for carriage ø 18mm L 445mm thread M8 250-275		

			
1			
<b>GEV No.</b>	696227	<b>Ref. No.</b>	AMC242
<b>description</b>	spindle for carriage ø 20mm L 385mm thread M8 220		
<b>For models:</b>	PERLA 220 CE DOM		

			
1			
<b>GEV No.</b>	696228	<b>Ref. No.</b>	AMG242
<b>description</b>	spindle for carriage ø 20mm L 420mm thread M8 250		
<b>For models:</b>	PERLA 250 CE DOM		

			
1			
<b>GEV No.</b>	696225	<b>Ref. No.</b>	AMI080
<b>description</b>	spindle for sliding plate ø 12mm L 120mm		
<b>For models:</b>	PERLA 220 CE DOM, PERLA 250 CE DOM		





			
1			
<b>GEV No.</b>	696224	<b>Ref. No.</b>	SM521218
<b>description</b>	spindle for sliding plate $\varnothing$ 12mm L 130mm 275-300		

			
1			
<b>GEV No.</b>	696226	<b>Ref. No.</b>	19530705
<b>description</b>	spindle for sliding plate $\varnothing$ 19mm L 120mm thread M8 250-370		

## accessories

			
1			
<b>GEV No.</b>	696269	<b>Ref. No.</b>	19335060+19346010 SM130201
<b>description</b>	countersunk screw thread M6 L 16mm stainless steel head $\varnothing$ 11mm set with plain washer slicer		

			
1			
<b>GEV No.</b>	698974	<b>Ref. No.</b>	19525060 19525060.10 19566060
<b>description</b>	guide L 32mm W 29mm ID $\varnothing$ 10mm mounting thread M5 aluminium		

			
1			
<b>GEV No.</b>	698968	<b>Ref. No.</b>	19526060
<b>description</b>	guide L 36mm W 32mm ID $\varnothing$ 12mm mounting thread M4 aluminium CANOVA		

			
1			
<b>GEV No.</b>	696268	<b>Ref. No.</b>	AMC246
<b>description</b>	oval head screw thread M8 stainless steel L 10mm slicer $\varnothing$ 22mm		
<b>For models:</b>	PERLA 220 CE DOM, PERLA 250 CE DOM		

## hand guard

			
1			
<b>GEV No.</b>	696287	<b>Ref. No.</b>	19562382
<b>description</b>	hand protection for sharpener units L 210mm W 105mm hole $\varnothing$ 5.3mm mounting distance 54mm 195		

			
1			
<b>GEV No.</b>	696284	<b>Ref. No.</b>	19562201
<b>description</b>	hand protection for knife $\varnothing$ 220mm H 80mm W 35mm hole $\varnothing$ 4.8mm mounting distance 47mm plastic		
<b>For models:</b>	PERLA 220 CE DOM		

			
1			
<b>GEV No.</b>	697298	<b>Ref. No.</b>	19562202
<b>description</b>	hand protection for knife $\varnothing$ 250mm		
<b>For models:</b>	PERLA 250 CE DOM		

			
1			
<b>GEV No.</b>	696285	<b>Ref. No.</b>	SM501203
<b>description</b>	hand protection for knife $\varnothing$ 300mm H 180mm W 95mm hole $\varnothing$ 5mm mounting distance 85mm aluminium		

			
1			
<b>GEV No.</b>	696286	<b>Ref. No.</b>	19521311
<b>description</b>	hand protection for knife $\varnothing$ 350mm H 200mm W 118mm hole $\varnothing$ 5mm mounting distance 85mm aluminium		

			
1			
<b>GEV No.</b>	698196	<b>Ref. No.</b>	19562324
<b>description</b>	hand protection for carriage 275-300 H 220mm W 150mm thickness 4mm hole $\varnothing$ 6mm mounting distance 88mm		





 <p>1</p>			
<b>GEV No.</b>	698311	<b>Ref. No.</b>	19562358
<b>description</b>	hand protection for carriage 275-300 H 244mm W 150mm thickness 4mm hole ø 6.3mm mounting distance 87.2mm		

 <p>1</p>			
<b>GEV No.</b>	698312	<b>Ref. No.</b>	19562336
<b>description</b>	hand protection for carriage 300-370 H 275mm W 297mm thickness 10mm mounting distance 248mm plexiglas		

 <p>1</p>			
<b>GEV No.</b>	697858	<b>Ref. No.</b>	AMA294A
<b>description</b>	hand protection for slicer		
<b>For models:</b>	PERLA 220 CE DOM, PERLA 250 CE DOM		

 <p>1</p>			
<b>GEV No.</b>	698574	<b>Ref. No.</b>	19562342
<b>description</b>	hand protection for slicer H 280mm W 150mm thickness 5mm hole ø 10mm mounting distance 95mm plastic		

 <p>1</p>			
<b>GEV No.</b>	698245	<b>Ref. No.</b>	195623206
<b>description</b>	hand protection H 210mm W 153mm mounting distance 93mm		

 <p>1</p>			
<b>GEV No.</b>	699625	<b>Ref. No.</b>	19562322
<b>description</b>	hand protection slicer H 165mm W 150mm thickness 4mm hole ø 6mm mounting distance 86mm		
<b>For models:</b>	PERLA 220 CE DOM, PERLA 250 CE DOM		

<p>accessories</p>			
 <p>1</p>			
<b>GEV No.</b>	696281	<b>Ref. No.</b>	19521603
<b>description</b>	spacer bush for hand guard thread M5 ø 16mm L 31mm		
<b>For models:</b>	PERLA 220 CE DOM, PERLA 250 CE DOM		

 <p>1</p>			
<b>GEV No.</b>	697467	<b>Ref. No.</b>	SM591519
<b>description</b>	blade pulley with spindle D1 ø 40mm D2 ø 63mm D3 ø 80mm shaft ø 15 L 42mm shaft length 194mm mounting thread M5 mounting ø 3-hole		

 <p>1</p>			
<b>GEV No.</b>	696234	<b>Ref. No.</b>	AMG022
<b>description</b>	blade pulley with spindle D1 ø 40mm D2 ø 65mm D3 ø 64mm shaft ø 15 L 43mm shaft length 152mm mounting thread M5 mounting ø 3-hole		
<b>For models:</b>	PERLA 250 CE DOM		

 <p>1</p>			
<b>GEV No.</b>	696233	<b>Ref. No.</b>	AMC022
<b>description</b>	blade pulley with spindle D1 ø 40mm D2 ø 69mm D3 ø 65mm shaft ø 15 L 30mm shaft length 147mm mounting thread M5 mounting ø 3-hole		
<b>For models:</b>	PERLA 220 CE DOM		



			
1			
<b>GEV No.</b>	696232	<b>Ref. No.</b>	19700307
<b>description</b>	blade pulley with spindle D1 ø 57mm D2 ø 78mm D3 ø 95mm shaft ø 20 L 65mm shaft length 220mm mounting thread M5 mounting ø 4 hole		

**food holders**

**handles**

			
1			
<b>GEV No.</b>	698195	<b>Ref. No.</b>	19562903 19562905
<b>description</b>	cone handle thread M10 ø 29mm L 82mm black		

			
1			
<b>GEV No.</b>	697431	<b>Ref. No.</b>	19562901 19564019
<b>description</b>	cone handle thread M6 ø 26mm plastic L 70mm black thread L 10mm		

			
1			
<b>GEV No.</b>	697432	<b>Ref. No.</b>	19562900
<b>description</b>	cone handle thread M6 ø 26mm plastic L 70mm thread L 6mm		

			
1			
<b>GEV No.</b>	698313	<b>Ref. No.</b>	AMA284
<b>description</b>	handle ø 18.5mm L 44mm plastic food holder		
<b>For models:</b>	PERLA 220 CE DOM, PERLA 250 CE DOM		
<b>accessories for</b>	698313		
	<b>GEV No.</b>	504788	<b>Ref. No.</b> AMA282
	 screw thread M5 L 50mm Qty 1 pcs		

			
1			
<b>GEV No.</b>	111123	<b>Ref. No.</b>	19562904 19564021
<b>description</b>	handle thread M10 IT ø 30mm L 110mm D1 ø 65mm		

**food holders**

			
1			
<b>GEV No.</b>	697530	<b>Ref. No.</b>	sehe Bemerkung!!!! SM11016007 SM11016007+19563206+19324102
<b>description</b>	food holder 275-300 L 270mm hole ø 12mm		

			
1			
<b>GEV No.</b>	698190	<b>Ref. No.</b>	19510922 19510922+2x19324102+19563206
<b>description</b>	food holder 300		

**accessories**

			
1			
<b>GEV No.</b>	698518	<b>Ref. No.</b>	19525062
<b>description</b>	guide food holder ø 10mm L 33mm thread M5 aluminium		

			
1			
<b>GEV No.</b>	698369	<b>Ref. No.</b>	19566062
<b>description</b>	guide food holder ø 10mm L 33mm thread M5 plastic		

			
1			
<b>GEV No.</b>	696220	<b>Ref. No.</b>	AMC270A
<b>description</b>	spindle food holder ø 10mm L 210mm		
<b>For models:</b>	PERLA 220 CE DOM, PERLA 250 CE DOM		

			
1			
<b>GEV No.</b>	696221	<b>Ref. No.</b>	AMP270
<b>description</b>	spindle food holder ø 12mm L 265mm 300		

			
1			
<b>GEV No.</b>	698193	<b>Ref. No.</b>	19541509
<b>description</b>	thread bolt for handle ø 14mm L 120mm thread M10 stainless steel		



blades

pullers



1

<b>GEV No.</b>	697531	<b>Ref. No.</b>	19702508
<b>description</b>	puller for knife ø 300mm hole distance 160mm thread M8		



1

<b>GEV No.</b>	697532	<b>Ref. No.</b>	19702512
<b>description</b>	puller for knife ø 357mm hole distance 160mm thread M8		

PTFE



1

<b>GEV No.</b>	697304	<b>Ref. No.</b>	18250403210TF
<b>description</b>	slicing machine blade ED ø 250mm seat ø 40mm 3-hole ID ø 210mm H 17.5mm PTFE 100Cr6		
<b>For models:</b>	VCO250		



1

<b>GEV No.</b>	697547	<b>Ref. No.</b>	18275403218TF
<b>description</b>	slicing machine blade ED ø 275mm seat ø 40mm 3-hole ID ø 218mm H 21.5mm PTFE 100Cr6		



1

<b>GEV No.</b>	697548	<b>Ref. No.</b>	18275404218TF
<b>description</b>	slicing machine blade ED ø 275mm seat ø 40mm 4 hole ID ø 218mm H 21.5mm PTFE 100Cr6		



1

<b>GEV No.</b>	696520	<b>Ref. No.</b>	1830040325422TF
<b>description</b>	slicing machine blade ED ø 300mm seat ø 40mm 3-hole PTFE ID ø 254mm H 22.5mm		
<b>For models:</b>	MIRRA 300 CE		



1

<b>GEV No.</b>	698210	<b>Ref. No.</b>	1830057425422TF
<b>description</b>	slicing machine blade ED ø 300mm seat ø 57mm 4 hole ID ø 254mm H 22.5mm PTFE 100Cr6		



1

<b>GEV No.</b>	697550	<b>Ref. No.</b>	18330574270TF
<b>description</b>	slicing machine blade ED ø 330mm seat ø 57mm 4 hole ID ø 270mm H 23mm PTFE 100Cr6		



1

<b>GEV No.</b>	697551	<b>Ref. No.</b>	18350574280TF
<b>description</b>	slicing machine blade ED ø 350mm seat ø 57mm 4 hole ID ø 280mm H 22.5mm PTFE 100Cr6		



1

<b>GEV No.</b>	697552	<b>Ref. No.</b>	18370574300TF
<b>description</b>	slicing machine blade ED ø 370mm seat ø 57mm 4 hole ID ø 300mm H 22.5mm PTFE 100Cr6		

special



1

<b>GEV No.</b>	697845	<b>Ref. No.</b>	N/A
<b>description</b>	slicing machine blade ED ø 330mm seat ø 270mm 4 hole ID ø 57mm Hmm 100Cr6		

standard



1

<b>GEV No.</b>	697546	<b>Ref. No.</b>	18195303155
<b>description</b>	slicing machine blade ED ø 195mm seat ø 30mm 3-hole ID ø 155mm H 12.8mm C45 standard		



1

<b>GEV No.</b>	697436	<b>Ref. No.</b>	18220403180F
<b>description</b>	slicing machine blade ED ø 220mm seat ø 40mm 3-hole ID ø 180mm H 15.5mm C45		



1

<b>GEV No.</b>	697365	<b>Ref. No.</b>	18250403210
<b>description</b>	slicing machine blade ED ø 250mm seat ø 40mm 3-hole ID ø 210mm H 17.5mm C45 standard		
<b>For models:</b>	PERLA 250 CE DOM		



1

<b>GEV No.</b>	697541	<b>Ref. No.</b>	1827540321815
<b>description</b>	slicing machine blade ED ø 275mm seat ø 40mm 3-hole ID ø 218mm H 15.5mm C45 standard		



1

<b>GEV No.</b>	697540	<b>Ref. No.</b>	18275403218
<b>description</b>	slicing machine blade ED ø 275mm seat ø 40mm 3-hole ID ø 218mm H 21.5mm C45 standard		



1

<b>GEV No.</b>	697539	<b>Ref. No.</b>	18275403220
<b>description</b>	slicing machine blade ED ø 275mm seat ø 40mm 3-hole ID ø 220mm H 15.5mm C45 standard		



1

<b>GEV No.</b>	697538	<b>Ref. No.</b>	18275404218
<b>description</b>	slicing machine blade ED ø 275mm seat ø 40mm 4 hole ID ø 218mm H 21.5mm C45 standard		



1

<b>GEV No.</b>	697385	<b>Ref. No.</b>	18300403250 1830040325020F
<b>description</b>	slicing machine blade ED ø 300mm seat ø 40mm 3-hole ID ø 250mm H 20mm C45 standard		



1

<b>GEV No.</b>	698214	<b>Ref. No.</b>	18300403254
<b>description</b>	slicing machine blade ED ø 300mm seat ø 40mm 3-hole ID ø 254mm H 22.5mm C45 standard		





<b>GEV No.</b>	698191	<b>Ref. No.</b>	18300574254
<b>description</b>	slicing machine blade ED ø 300mm seat ø 57mm 4 hole ID ø 254mm H 22.5mm C45 standard		



<b>GEV No.</b>	697375	<b>Ref. No.</b>	18330574270
<b>description</b>	slicing machine blade ED ø 330mm seat ø 57mm 4 hole ID ø 270mm H 23mm 100Cr6 standard		

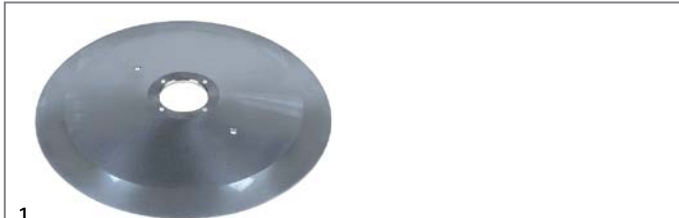

<b>GEV No.</b>	697463	<b>Ref. No.</b>	18350574280F
<b>description</b>	slicing machine blade ED ø 350mm seat ø 57mm 4 hole ID ø 280mm H 22.5mm 100Cr6 standard		



<b>GEV No.</b>	697399	<b>Ref. No.</b>	18350574280
<b>description</b>	slicing machine blade ED ø 350mm seat ø 57mm 4 hole ID ø 280mm H 22.5mm C45 standard		



<b>GEV No.</b>	697460	<b>Ref. No.</b>	18370574300
<b>description</b>	slicing machine blade ED ø 370mm seat ø 57mm 4 hole ID ø 300mm H 22.5mm 100Cr6 standard		



<b>GEV No.</b>	697458	<b>Ref. No.</b>	18385574315
<b>description</b>	slicing machine blade ED ø 385mm seat ø 57mm 4 hole ID ø 315mm H 22.5mm 100Cr6 standard		

sharpener units

lids





<b>GEV No.</b>	696261	<b>Ref. No.</b>	AME402
<b>description</b>	lid for sharpener units L 104mm W 80mm mounting distance 80mm 220/250/275		
<b>For models:</b>	PERLA 250 CE DOM		



<b>GEV No.</b>	696262	<b>Ref. No.</b>	SM501501
<b>description</b>	lid for sharpener units L 125mm W 103mm mounting distance 88mm 275-300		

accessories for 696262

	<b>GEV No.</b>	697445	<b>Ref. No.</b>	SM211413
	<b>description</b>	mushroom cap handle thread M6 handle ø 33mm L 26mm plastic black		

	<b>GEV No.</b>	697517	<b>Ref. No.</b>	IB4206451
	<b>description</b>	cone handle thread M10 ø 30mm L 66mm black		

push buttons

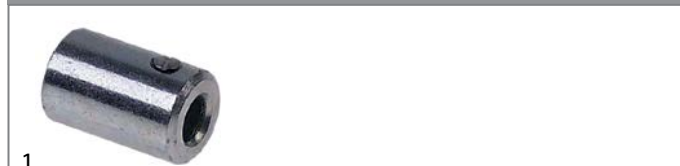

<b>GEV No.</b>	696260	<b>Ref. No.</b>	AMA810 AME426
<b>description</b>	push button for sharpener units ø 12mm L 19mm hole ø 5.2mm 195-220		
<b>For models:</b>	PERLA 220 CE DOM, PERLA 250 CE DOM		

			
1			
<b>GEV No.</b>	696259	<b>Ref. No.</b>	AME468
<b>description</b>	push button for sharpener units $\varnothing$ 12mm L 19mm hole $\varnothing$ 6mm 220-250		
<b>For models:</b>	PERLA 250 CE DOM		

			
1			
<b>GEV No.</b>	696255	<b>Ref. No.</b>	SM561101
<b>description</b>	push button for sharpener units $\varnothing$ 12mm L 22mm hole $\varnothing$ 6mm 275-300		

			
1			
<b>GEV No.</b>	696257	<b>Ref. No.</b>	SM561101+SM150401
<b>description</b>	push button for sharpener units $\varnothing$ 12mm L 22mm hole $\varnothing$ 6mm 275-300		

holders

			
1			
<b>GEV No.</b>	696263	<b>Ref. No.</b>	SM501401
<b>description</b>	body for sharpener units L 102mm W 46mm H 38mm hole $\varnothing$ 6mm mounting distance 88mm aluminium 275-300		

			
1			
<b>GEV No.</b>	696265	<b>Ref. No.</b>	AME456
<b>description</b>	body for sharpener units L 92mm W 35mm H 28mm hole $\varnothing$ 6mm mounting distance 80mm plastic 220-250		
<b>For models:</b>	PERLA 250 CE DOM		

			
1			
<b>GEV No.</b>	696264	<b>Ref. No.</b>	19562101
<b>description</b>	body for sharpener units L 99mm W 48mm H 28mm hole $\varnothing$ 6mm mounting thread M6 plastic 195-220		
<b>For models:</b>	PERLA 220 CE DOM		

			
1			
<b>GEV No.</b>	696242	<b>Ref. No.</b>	SM501303
<b>description</b>	bracket for sharpener units L 52mm W 30mm H 61mm hole $\varnothing$ 12mm mounting thread M8 aluminium		

			
1			
<b>GEV No.</b>	696241	<b>Ref. No.</b>	AME436
<b>description</b>	bracket for sharpener units L 57mm W 25mm H 54mm hole $\varnothing$ 12mm mounting thread M6 aluminium		
<b>For models:</b>	PERLA 250 CE DOM		

knobs

			
1			
<b>GEV No.</b>	697516	<b>Ref. No.</b>	19562700 19564018
<b>description</b>	locking screw thread M5 handle $\varnothing$ 25mm L 8mm		

			
1			
<b>GEV No.</b>	697384	<b>Ref. No.</b>	AME428
<b>description</b>	locking screw thread M6 handle $\varnothing$ 25mm black L 54mm		
<b>For models:</b>	PERLA 250 CE DOM		

			
1			
<b>GEV No.</b>	697514	<b>Ref. No.</b>	SM592400
<b>description</b>	locking screw thread M8 handle $\varnothing$ 30mm L 60mm		



			
1			
<b>GEV No.</b>	697445	<b>Ref. No.</b>	SM211413
<b>description</b>	mushroom cap handle thread M6 handle ø 33mm L 26mm plastic black		

spindles

			
1			
<b>GEV No.</b>	696215	<b>Ref. No.</b>	AME412
<b>description</b>	spindle grindstone D1 ø 5mm D2 ø 6mm L 65mm thread M6 IT M4 220-250		
<b>For models:</b>	PERLA 250 CE DOM		

			
1			
<b>GEV No.</b>	696216	<b>Ref. No.</b>	AME424
<b>description</b>	spindle grindstone D1 ø 6mm D2 ø 10mm L 63mm thread M6 220-250		
<b>For models:</b>	PERLA 250 CE DOM		

			
1			
<b>GEV No.</b>	696214	<b>Ref. No.</b>	AMA802 AMA804
<b>description</b>	spindle grindstone D1 ø 6mm D2 ø 10mm L 70mm thread M6 195-220		
<b>For models:</b>	PERLA 220 CE DOM		

			
1			
<b>GEV No.</b>	696217	<b>Ref. No.</b>	SM570201
<b>description</b>	spindle grindstone D1 ø 6mm D2 ø 12mm L 78mm thread M6 250-300		

			
1			
<b>GEV No.</b>	696222	<b>Ref. No.</b>	AME442
<b>description</b>	spindle for sharpener units ø 12mm L 67mm thread M8		
<b>For models:</b>	PERLA 250 CE DOM		

			
1			
<b>GEV No.</b>	696223	<b>Ref. No.</b>	SM540501
<b>description</b>	spindle for sharpener units ø 12mm L 98mm thread M8 250-300		

accessories

			
1			
<b>GEV No.</b>	696258	<b>Ref. No.</b>	AME464
<b>description</b>	ball for sharpener units ø 4.8mm metal		
<b>For models:</b>	PERLA 250 CE DOM		

			
1			
<b>GEV No.</b>	696256	<b>Ref. No.</b>	SM150401
<b>description</b>	oval head screw thread M3 L 3.2mm push button		

			
1			
<b>GEV No.</b>	696271	<b>Ref. No.</b>	AME427
<b>description</b>	oval head screw thread M3 L 4.2mm push button		
<b>For models:</b>	PERLA 250 CE DOM		

			
1			
<b>GEV No.</b>	696218	<b>Ref. No.</b>	AME450
<b>description</b>	thread bolt for sharpener units thread M5 ø 5mm L 30mm		
<b>For models:</b>	PERLA 250 CE DOM		

grindstones

			
1			
<b>GEV No.</b>	697565	<b>Ref. No.</b>	19300101
<b>description</b>	grindstone ø 40mm thickness 10mm bore ø 6mm grained fine with bevel, without hub		

			
1			
<b>GEV No.</b>	697492	<b>Ref. No.</b>	SM260101old
<b>description</b>	grindstone ø 40mm thickness 11mm bore ø 6mm grained coarse with bevel, without hub		

			
1			
<b>GEV No.</b>	697549	<b>Ref. No.</b>	19300201
<b>description</b>	grindstone ø 40mm thickness 7.8mm bore ø 6mm grained fine with bevel, without hub		

			
1			
<b>GEV No.</b>	697797	<b>Ref. No.</b>	19300107N SM260101
<b>description</b>	grindstone ø 43mm thickness 12mm bore ø 6mm grained coarse with bevel, with hub		

			
1			
<b>GEV No.</b>	697505	<b>Ref. No.</b>	SM260102
<b>description</b>	grindstone ø 43mm thickness 8mm bore ø 6mm grained fine with bevel, without hub		

			
1			
<b>GEV No.</b>	698197	<b>Ref. No.</b>	19300207
<b>description</b>	grindstone ø 45mm thickness 8mm bore ø 6mm grained fine with bevel, without hub		

			
1			
<b>GEV No.</b>	698198	<b>Ref. No.</b>	19300107C AVA416
<b>description</b>	grindstone ø 45mm thickness 9mm bore ø 6mm grained coarse with bevel, without hub		

			
1			
<b>GEV No.</b>	697393	<b>Ref. No.</b>	19300108C 19300108C.10
<b>description</b>	grindstone ø 48mm thickness 15mm bore ø 8mm grained coarse with bevel, without hub		

			
1			
<b>GEV No.</b>	697392	<b>Ref. No.</b>	19300209
<b>description</b>	grindstone ø 50mm thickness 8mm bore ø 8mm grained fine with bevel, without hub		

grindstones with hub

			
1			
<b>GEV No.</b>	697424	<b>Ref. No.</b>	19300301
<b>description</b>	grindstone ø 40mm thickness 8mm bore ø 6mm grained coarse with bevel, with hub		
<b>For models:</b>	PERLA 220 CE DOM, PERLA 250 CE DOM		

			
1			
<b>GEV No.</b>	697423	<b>Ref. No.</b>	19300401
<b>description</b>	grindstone ø 40mm thickness 8mm bore ø 6mm grained fine with bevel, with hub		
<b>For models:</b>	PERLA 220 CE DOM, PERLA 250 CE DOM		

			
1			
<b>GEV No.</b>	697421	<b>Ref. No.</b>	N/A
<b>description</b>	grindstone ø 45mm thickness 8mm bore ø 6mm grained coarse with bevel, with hub		

			
1			
<b>GEV No.</b>	697422	<b>Ref. No.</b>	N/A
<b>description</b>	grindstone ø 45mm thickness 8mm bore ø 6mm grained fine with bevel, with hub		

			
1			
<b>GEV No.</b>	698637	<b>Ref. No.</b>	N/A
<b>description</b>	grindstone ø 48mm thickness 8mm bore ø 8mm grained fine with bevel, with hub		



			
1			
<b>GEV No.</b>	697358	<b>Ref. No.</b>	AMP416
<b>description</b>	grindstone ø 50mm thickness 8mm bore ø 6mm grained fine with bevel, with hub		

			
1			
<b>GEV No.</b>	697593	<b>Ref. No.</b>	19300208
<b>description</b>	grindstone ø 50mm thickness 8mm bore ø 8mm grained coarse with bevel, with hub		

			
1			
<b>GEV No.</b>	697592	<b>Ref. No.</b>	N/A
<b>description</b>	grindstone ø 50mm thickness 8mm bore ø 8mm grained fine with bevel, with hub		

carriages

handles

			
1			
<b>GEV No.</b>	696830	<b>Ref. No.</b>	AVA256
<b>description</b>	adjusting knob thread M10 handle ø 66mm H 51mm black		

			
1			
<b>GEV No.</b>	697381	<b>Ref. No.</b>	19562803
<b>description</b>	handle thread M12 handle ø 66mm H 50mm black		

			
1			
<b>GEV No.</b>	697515	<b>Ref. No.</b>	SM19014009
<b>description</b>	locking screw thread M8 handle ø 50mm 275-300 L 14mm		

			
1			
<b>GEV No.</b>	691263	<b>Ref. No.</b>	IB4200910
<b>description</b>	pull handle L 160mm H 56mm mounting distance 133mm thread M8		
<b>For models:</b>	SALAMANDRA PRO 1/1G CE		

			
1			
<b>GEV No.</b>	697443	<b>Ref. No.</b>	19562504 19564013
<b>description</b>	star handle thread M8 ø 50mm L 29mm black		
<b>For models:</b>	PERLA 220 CE DOM, PERLA 250 CE DOM		

holders

			
1			
<b>GEV No.</b>	696237	<b>Ref. No.</b>	SM500818
<b>description</b>	bracket L 190mm W 100mm mounting distance 48mm suitable for carriage 275-300		

			
1			
<b>GEV No.</b>	696235	<b>Ref. No.</b>	AMC258
<b>description</b>	bracket L 195mm W 85mm mounting distance 33mm suitable for carriage 220		
<b>For models:</b>	PERLA 220 CE DOM		





			
1			
<b>GEV No.</b>	696236	<b>Ref. No.</b>	AMG258
<b>description</b>	bracket L 200mm W 85mm mounting distance 33mm suitable for carriage 250		
<b>For models:</b>	PERLA 250 CE DOM		

			
1			
<b>GEV No.</b>	696250	<b>Ref. No.</b>	AMA289
<b>description</b>	bracket thread M5 L 25mm ID ø 10mm thickness 20mm 220-250		
<b>For models:</b>	PERLA 220 CE DOM, PERLA 250 CE DOM		

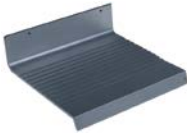
carriage plates

			
1			
<b>GEV No.</b>	697527	<b>Ref. No.</b>	AME264A
<b>description</b>	carriage L 20mm W 22mm mounting distance 33mm suitable for slicer 220 SIRMAN		
<b>For models:</b>	PERLA 220 CE DOM		

			
1			
<b>GEV No.</b>	696280	<b>Ref. No.</b>	19560101
<b>description</b>	spacer ring ø 22mm ID ø 10mm thickness 3mm PTFE 220-250		

			
1			
<b>GEV No.</b>	697528	<b>Ref. No.</b>	AMG264A
<b>description</b>	carriage L 24mm W 23mm mounting distance 33mm suitable for slicer 250 SIRMAN		
<b>For models:</b>	PERLA 250 CE DOM		

<p>miscellaneous</p> 			
1			
<b>GEV No.</b>	696248	<b>Ref. No.</b>	AMA028
<b>description</b>	bracket thread M10x0.75 ø 30mm for microswitch ID ø 15.2mm thickness 17mm mounting thread M6		
<b>For models:</b>	PERLA 220 CE DOM, PERLA 250 CE DOM		

			
1			
<b>GEV No.</b>	697529	<b>Ref. No.</b>	195104012
<b>description</b>	carriage L 250mm W 275mm mounting distance 33mm suitable for slicer 275-300 SIRMAN		

			
1			
<b>GEV No.</b>	696249	<b>Ref. No.</b>	19540905
<b>description</b>	bracket thread M10x0.75 ø 35mm for microswitch ID ø 20.2mm thickness 15mm mounting thread M8 250-300		

accessories

			
1			
<b>GEV No.</b>	696707	<b>Ref. No.</b>	19526062
<b>description</b>	bracket for bolt 300		

			
1			
<b>GEV No.</b>	696277	<b>Ref. No.</b>	AMC680
<b>description</b>	connection plate L 37mm W 25mm for motor thickness 4mm hole ø 6mm hole distance 15.5mm		
<b>For models:</b>	PERLA 220 CE DOM, PERLA 250 CE DOM		

			
1			
<b>GEV No.</b>	696219	<b>Ref. No.</b>	AMC670
<b>description</b>	thread bolt thread M6 ø 11mm L 74mm for motor hole ø 5mm		
<b>For models:</b>	PERLA 220 CE DOM, PERLA 250 CE DOM		





for bandsaws

wipers

1 

<b>GEV No.</b>	697772	<b>Ref. No.</b>	LF2001032
<b>description</b>	wiper L 45mm W 25mm thickness 3mm plastic SO1650/SO2020		

impellers

1 

<b>GEV No.</b>	699620	<b>Ref. No.</b>	LF2001037
<b>description</b>	impellor upper disc ø 210mm shaft intake ø 40mm disc width 16mm overall width 32mm for bandsaw		

saw blades

width 16mm

1 

<b>GEV No.</b>	699019	<b>Ref. No.</b>	28045136
<b>description</b>	saw blade L 1360mm W 16mm thickness 0.5mm tooth spacing 6mm		

1 

<b>GEV No.</b>	699025	<b>Ref. No.</b>	28045152
<b>description</b>	saw blade L 1520mm W 16mm thickness 0.5mm tooth spacing 6mm		

1 

<b>GEV No.</b>	699026	<b>Ref. No.</b>	28045155
<b>description</b>	saw blade L 1550mm W 16mm thickness 0.5mm tooth spacing 6mm		

1 

<b>GEV No.</b>	699033	<b>Ref. No.</b>	28041565
<b>description</b>	saw blade L 1650mm W 16mm thickness 0.5mm tooth spacing 6mm		

1 

<b>GEV No.</b>	699037	<b>Ref. No.</b>	28045180
<b>description</b>	saw blade L 1800mm W 16mm thickness 0.5mm tooth spacing 6mm		

1 

<b>GEV No.</b>	699040	<b>Ref. No.</b>	28045184
<b>description</b>	saw blade L 1840mm W 16mm thickness 0.5mm tooth spacing 6mm		

1 

<b>GEV No.</b>	699003	<b>Ref. No.</b>	28045202
<b>description</b>	saw blade L 2020mm W 16mm thickness 0.5mm tooth spacing 6mm		

1 

<b>GEV No.</b>	699049	<b>Ref. No.</b>	28045240
<b>description</b>	saw blade L 2400mm W 16mm thickness 0.5mm tooth spacing 6mm		

1 

<b>GEV No.</b>	699043	<b>Ref. No.</b>	28045294
<b>description</b>	saw blade L 2940mm W 16mm thickness 0.5mm tooth spacing 6mm Qty 1 pcs		

1 

<b>GEV No.</b>	699060	<b>Ref. No.</b>	28045310
<b>description</b>	saw blade L 3100mm W 16mm thickness 0.5mm tooth spacing 6mm		

width 20mm

1 

<b>GEV No.</b>	699171	<b>Ref. No.</b>	28044165 28046165
<b>description</b>	saw blade L 1650mm W 20mm thickness 0.5mm tooth spacing 6mm teeth diamant coating		

1 

<b>GEV No.</b>	699004	<b>Ref. No.</b>	28044202
<b>description</b>	saw blade L 2020mm W 20mm thickness 0.5mm tooth spacing 6mm		

## miscellaneous



1

<b>GEV No.</b>	699624	<b>Ref. No.</b>	LF1201001
<b>description</b>	cap cover for impellor $\varnothing$ 40mm H 7mm		



1

<b>GEV No.</b>	699623	<b>Ref. No.</b>	LF2001014
<b>description</b>	insert lower L 31mm W 15mm H 15mm		



1

<b>GEV No.</b>	699622	<b>Ref. No.</b>	LF2001028
<b>description</b>	plain washer chamfered $\varnothing$ 9-28mm H 5mm		



1

<b>GEV No.</b>	699626	<b>Ref. No.</b>	IX2472042
<b>description</b>	retaining ring for impellor metal $\varnothing$ 46mm H 1.7mm		



1

<b>GEV No.</b>	698965	<b>Ref. No.</b>	LF2010008
<b>description</b>	screw $\varnothing$ 30mm H 45mm		



1

<b>GEV No.</b>	696834	<b>Ref. No.</b>	LF1210002
<b>description</b>	shaft seal ID $\varnothing$ 25mm ED $\varnothing$ 40mm thickness H 5mm		

## for meat mincers

## gearboxes



1

<b>GEV No.</b>	696204	<b>Ref. No.</b>	29401800
<b>description</b>	gearbox motor shaft $\varnothing$ 11mm flange $\varnothing$ 90mm transmission 1/30 drive shaft $\varnothing$ 14mm type 30		



1

<b>GEV No.</b>	698164	<b>Ref. No.</b>	LF2043015
<b>description</b>	gearbox motor shaft $\varnothing$ 19mm flange $\varnothing$ 120mm transmission 1/49 drive shaft $\varnothing$ 25mm type FRS60		
<b>For models:</b>	IP30, MASTER30		

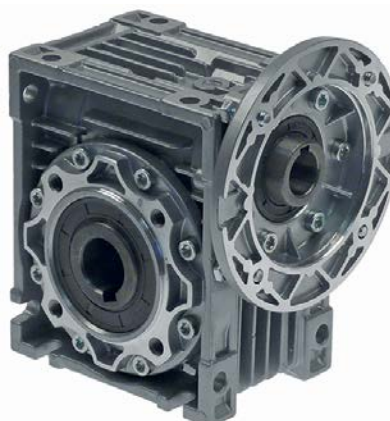

1

<b>GEV No.</b>	698162	<b>Ref. No.</b>	LF2039210
<b>description</b>	gearbox motor shaft $\varnothing$ 19mm flange $\varnothing$ 120mm transmission 1/7 drive shaft $\varnothing$ 25mm Mod.12-22		
<b>For models:</b>	TC12RIO, TC22FR, TC22LAPORTE, TC22RIO		





1	<b>GEV No.</b>	698163	<b>Ref. No.</b>	LF2039414
	<b>description</b>	gearbox motor shaft $\varnothing$ 19mm flange $\varnothing$ 120mm transmission 1/7 drive shaft $\varnothing$ 25mm type FRS60 Mod.32		
	<b>For models:</b>	MASTER30, TC32BU, TC32FR, TC32LAPORTE, TC32RIO		

gear wheels

1			
<b>GEV No.</b>	698148	<b>Ref. No.</b>	IV2320500
<b>description</b>	auger $\varnothing$ 35.5mm shaft intake $\varnothing$ 17mm W 45mm for mincer Mod.12		
<b>For models:</b>	TC 12 MAGNUM INGRANAGGI CE, TC12M, TCG12M		

1			
<b>GEV No.</b>	698028	<b>Ref. No.</b>	MF0110
<b>description</b>	gear wheel double $\varnothing$ 32/70mm shaft intake $\varnothing$ 15mm W 30mm teeth 18/41 splitting tooth width 14/11mm DIN/ISO Mod.12-22		
<b>For models:</b>	TCG12E, TCG22E		

1			
<b>GEV No.</b>	698027	<b>Ref. No.</b>	MF0111
<b>description</b>	gear wheel $\varnothing$ 25mm shaft intake $\varnothing$ 10mm teeth 13 splitting tooth width 20mm DIN/ISO Mod.12-22		
<b>For models:</b>	TCG12E, TCG22E		

1			
<b>GEV No.</b>	698149	<b>Ref. No.</b>	IV2330500
<b>description</b>	gear wheel $\varnothing$ 61mm shaft intake $\varnothing$ 17mm teeth 27 tooth width 20mm Mod.12		
<b>For models:</b>	TC 12 MAGNUM INGRANAGGI CE, TC12M, TCG12M		

1			
<b>GEV No.</b>	698029	<b>Ref. No.</b>	MF0112
<b>description</b>	gear wheel $\varnothing$ 64mm shaft intake $\varnothing$ 16mm teeth 39 splitting tooth width 13mm DIN/ISO Mod.12-22		
<b>For models:</b>	TCG12E, TCG22E		

1			
<b>GEV No.</b>	698101	<b>Ref. No.</b>	LF2032010
<b>description</b>	gear wheel set		
<b>For models:</b>	TC12F, TC22F		

1			
<b>GEV No.</b>	698130	<b>Ref. No.</b>	LF2032608
<b>description</b>	gear wheel set		
<b>For models:</b>	TC12CHICAGO, TC22PF, TC32CHICAGO, TC32PF		

1			
<b>GEV No.</b>	698139	<b>Ref. No.</b>	LF2034010
<b>description</b>	gear wheel set		
<b>For models:</b>	TC32IND, TC42IND		

drive shafts

for blades

1			
<b>GEV No.</b>	698038	<b>Ref. No.</b>	MF0127 MF2127
<b>description</b>	drive shaft ENTERPRISE model 12 $\varnothing$ 9.5mm L 53mm thread M12x1.75 D1 $\varnothing$ 20mm thread L 20mm		
<b>For models:</b>	TCG12E		

1			
<b>GEV No.</b>	698106	<b>Ref. No.</b>	LF2031004
<b>description</b>	drive shaft ENTERPRISE model 12 $\varnothing$ 9.6mm L 74mm thread M16x1.5 D1 $\varnothing$ 21.5mm thread L 24mm		
<b>For models:</b>	TC12CHICAGO, TC12F, TC12RIO		



1

<b>GEV No.</b>	698056	<b>Ref. No.</b>	MF0194
<b>description</b>	drive shaft ENTERPRISE model 22 $\varnothing$ 11mm L 53mm thread M12x1.75 D1 $\varnothing$ 22mm thread L 18mm		
<b>For models:</b>	TCG22E		



1

<b>GEV No.</b>	698110	<b>Ref. No.</b>	LF2032008
<b>description</b>	drive shaft ENTERPRISE model 22 $\varnothing$ 11mm L 76mm thread M16x1.5 D1 $\varnothing$ 21.5mm thread L 24mm		
<b>For models:</b>	TC22CHICAGO, TC22F, TC22FR, TC22LAPORTE, TC22PF, TC22RIO		



1

<b>GEV No.</b>	698135	<b>Ref. No.</b>	LF2033013
<b>description</b>	spindle ENTERPRISE model 32 $\varnothing$ 13mm L 87mm thread M20x1.5 D1 $\varnothing$ 29.5mm thread L 28mm		
<b>For models:</b>	MASTER30, TC32BU, TC32CHICAGO, TC32FR, TC32IND, TC32LAPORTE, TC32PF, TC32RIO		



1

<b>GEV No.</b>	698146	<b>Ref. No.</b>	LF2034004
<b>description</b>	spindle ENTERPRISE model 42 $\varnothing$ 20mm L 113mm thread M20x1.5 D1 $\varnothing$ 34.5mm thread L 35mm		
<b>For models:</b>	TC42IND		



1

<b>GEV No.</b>	698066	<b>Ref. No.</b>	MF0200
<b>description</b>	drive shaft Unger model 22 $\varnothing$ 12/15mm L 80mm stainless steel thread M12x1.75		

## for augers



1

<b>GEV No.</b>	698159	<b>Ref. No.</b>	LF2037012
<b>description</b>	drive shaft model 12 $\varnothing$ 16mm L 95mm D1 $\varnothing$ 25mm shaft diameter 17x17mm		
<b>For models:</b>	TCG12M		



1

<b>GEV No.</b>	698150	<b>Ref. No.</b>	IV2080500
<b>description</b>	drive shaft model 12 $\varnothing$ 17mm L 128mm D1 $\varnothing$ 25mm shaft diameter 17x17mm		
<b>For models:</b>	TC 12 MAGNUM INGRANAGGI CE, TC12M, TCG12M		



1

<b>GEV No.</b>	698031	<b>Ref. No.</b>	MF0115
<b>description</b>	drive shaft model 12-22 $\varnothing$ 17mm L 78mm D1 $\varnothing$ 25mm shaft diameter 10x23mm		
<b>For models:</b>	TCG12E, TCG22E		



1

<b>GEV No.</b>	698103	<b>Ref. No.</b>	LF2032019
<b>description</b>	drive shaft model 12-22 $\varnothing$ 20mm L 153mm D1 $\varnothing$ 45mm		
<b>For models:</b>	TC12F, TC22F		



1

<b>GEV No.</b>	698165	<b>Ref. No.</b>	LF2039212
<b>description</b>	drive shaft model 12-22 $\varnothing$ 25mm L 121mm D1 $\varnothing$ 35mm shaft diameter 15x35mm		
<b>For models:</b>	TC12RIO, TC22FR, TC22RIO		





			
1			
<b>GEV No.</b>	699621	<b>Ref. No.</b>	LF2032621
<b>description</b>	drive shaft model 12-22-32 $\phi$ 40/25/20mm L 97mm shaft diameter 15x40mm		

			
1			
<b>GEV No.</b>	698131	<b>Ref. No.</b>	LF2032604
<b>description</b>	drive shaft model 22-32		
<b>For models:</b>	TC12CHICAGO, TC22PF, TC32CHICAGO, TC32PF		

			
1			
<b>GEV No.</b>	698168	<b>Ref. No.</b>	LF2095010
<b>description</b>	drive shaft model 30 $\phi$ 25mm L 169mm D1 $\phi$ 30mm shaft diameter 10X30mm		
<b>For models:</b>	IP30, MASTER30		

			
1			
<b>GEV No.</b>	698167	<b>Ref. No.</b>	LF2039725
<b>description</b>	drive shaft model 30 $\phi$ 25mm L 205mm D1 $\phi$ 40mm shaft diameter 15x40mm		
<b>For models:</b>	MASTER30		

			
1			
<b>GEV No.</b>	698144	<b>Ref. No.</b>	LF2034006
<b>description</b>	drive shaft model 42		
<b>For models:</b>	TC42IND		

			
1			
<b>GEV No.</b>	698140	<b>Ref. No.</b>	LF2033505
<b>description</b>	drive shaft $\phi$ 53mm stainless steel L 120mm		
<b>For models:</b>	TC32IND		

			
1			
<b>GEV No.</b>	698166	<b>Ref. No.</b>	LF2039412
<b>description</b>	drive shaft type 32 $\phi$ 25mm L 170mm D1 $\phi$ 40mm shaft diameter 15x40mm		
<b>For models:</b>	TC32FR, TC32RIO		

			
1			
<b>GEV No.</b>	698102	<b>Ref. No.</b>	LF2032011
<b>description</b>	spindle D1 $\phi$ 25mm $\phi$ 16mm L 42mm Mod.12-22 thread M12x1.5 total length 71mm		
<b>For models:</b>	TC12F, TC22F		

			
1			
<b>GEV No.</b>	698030	<b>Ref. No.</b>	MF0108
<b>description</b>	spindle $\phi$ 15mm L 31mm Mod.12-22 thread M14x1.5 total length 46mm		
<b>For models:</b>	TCG12E, TCG22E		



locking screws

locking levers



1

<b>GEV No.</b>	698184	<b>Ref. No.</b>	LF2033016
<b>description</b>	locking lever model 32 thread M25 ø 25mm lever length 75mm thread L 22mm total length 105mm		



1

<b>GEV No.</b>	698093	<b>Ref. No.</b>	MF0352
<b>description</b>	locking lever thread M10 ø 28mm lever length 70mm thread L 30mm plastic total length 77mm		



1

<b>GEV No.</b>	698115	<b>Ref. No.</b>	LF2032015
<b>description</b>	locking lever thread M25 thread L 20mm ø 25mm lever length 65mm total length 86mm		

locking screws



1

<b>GEV No.</b>	698092	<b>Ref. No.</b>	MF0118 MF2115
<b>description</b>	locking screw thread M10 thread L 30mm handle ø 60mm plastic		
<b>For models:</b>	TC22E CE, TCG 22 E CE		



1

<b>GEV No.</b>	698296	<b>Ref. No.</b>	29561600
<b>description</b>	locking screw thread M8 thread L 26mm handle ø 47mm black plastic edition unitl 07/2014		



1

<b>GEV No.</b>	698183	<b>Ref. No.</b>	29561651 IV4200500
<b>description</b>	locking screw thread M8 L 26mm handle ø 40mm		
<b>For models:</b>	TC 12 MAGNUM INGRANAGGI CE		

lids



1

<b>GEV No.</b>	698017	<b>Ref. No.</b>	MF0367
<b>description</b>	lid model 12-22 ø 100mm plastic mounting distance 85mm		
<b>For models:</b>	GF, TCG12E, TCG22E		
<b>accessories for</b>	698017		



<b>GEV No.</b>	699592	<b>Ref. No.</b>	—
<b>description</b>	plug for lid ø 75mm plastic for meat mincer/cheese grater		



1

<b>GEV No.</b>	698010	<b>Ref. No.</b>	MF0002
<b>description</b>	lid model 8 ø 78mm plastic mounting distance 70mm		
<b>For models:</b>	GP		

gaskets



1

<b>GEV No.</b>	501593	<b>Ref. No.</b>	LF1232608
<b>description</b>	flat gasket rubber ED ø 76mm ID ø 58mm thickness 1mm Qty 1 pcs		



1

<b>GEV No.</b>	698305	<b>Ref. No.</b>	LF1232605
<b>description</b>	gasket for mincer thickness 0.9mm for gearbox		



funnel trays



1

<b>GEV No.</b>	698077	<b>Ref. No.</b>	MF0373 MF2113
<b>description</b>	hopper filling pipe central L 275mm W 200mm H 50mm tube ø 52mm		



1

<b>GEV No.</b>	698179	<b>Ref. No.</b>	IV2270500 LF2037041
<b>description</b>	hopper filling pipe central L 340mm W 250mm H 60mm tube ø 52mm		
<b>For models:</b>	TC 12 MAGNUM INGRANAGGI CE		



1

<b>GEV No.</b>	698113	<b>Ref. No.</b>	LF2032016
<b>description</b>	hopper filling pipe central L 340mm W 250mm H 60mm tube ø 56mm		



1

<b>GEV No.</b>	698076	<b>Ref. No.</b>	MF0181
<b>description</b>	hopper filling pipe central L 370mm W 250mm H 60mm tube ø 52mm		
<b>For models:</b>	TCG22E		



1

<b>GEV No.</b>	698175	<b>Ref. No.</b>	LF2032805
<b>description</b>	hopper filling pipe central L 410mm W 320mm H 60mm tube ø 52mm		



1

<b>GEV No.</b>	698174	<b>Ref. No.</b>	LF2033017
<b>description</b>	hopper filling pipe central L 500mm W 350mm H 70mm tube ø 76mm		



1

<b>GEV No.</b>	698176	<b>Ref. No.</b>	LF2033503
<b>description</b>	hopper filling pipe central L 810mm W 410mm H 80mm tube ø 76mm		



1

<b>GEV No.</b>	698177	<b>Ref. No.</b>	LF2034005
<b>description</b>	hopper filling pipe central L 850mm W 470mm H 80mm tube ø 108mm		



1

<b>GEV No.</b>	698180	<b>Ref. No.</b>	LF2039201B
<b>description</b>	hopper filling pipe left L 410mm W 310mm H 60mm tube ø 56mm		



1

<b>GEV No.</b>	698181	<b>Ref. No.</b>	LF2038607
<b>description</b>	hopper filling pipe left L 500mm W 350mm H 70mm tube ø 76mm		

funnels



1

<b>GEV No.</b>	698085	<b>Ref. No.</b>	MF0163
<b>description</b>	funnel model 12 ø 15mm		



1

<b>GEV No.</b>	698086	<b>Ref. No.</b>	MF0164
<b>description</b>	funnel model 12 ø 20mm ED ø 65mm L 135mm		



1

<b>GEV No.</b>	698087	<b>Ref. No.</b>	MF0165
<b>description</b>	funnel model 12 ø 25mm		



1

<b>GEV No.</b>	698088	<b>Ref. No.</b>	MF0166
<b>description</b>	funnel model 22 ø 15mm		



1

<b>GEV No.</b>	698089	<b>Ref. No.</b>	MF0167
<b>description</b>	funnel model 22 ø 20mm		



1

<b>GEV No.</b>	698090	<b>Ref. No.</b>	MF0168
<b>description</b>	funnel model 22 ø 25mm		

holders



1

<b>GEV No.</b>	698237	<b>Ref. No.</b>	29661200
<b>description</b>	bracket model 8 ID ø 51mm hole ø 7mm mounting distance 65mm plastic H 40mm for motor mounting distance 1 84mm		



1

<b>GEV No.</b>	698235	<b>Ref. No.</b>	29030501
<b>description</b>	bracket model 8 ø 57mm ID ø 42mm hole ø 7mm mounting distance 84mm aluminium		

grinder plates

ENTERPRISE

with 1 notch

with hub



1

<b>GEV No.</b>	696117	<b>Ref. No.</b>	2810 120 10X
<b>description</b>	grinder plate type ENTERPRISE size 12 hole ø 10mm with hub grooves 1 stainless steel ø 70mm		



1

<b>GEV No.</b>	696118	<b>Ref. No.</b>	2810 120 12X
<b>description</b>	grinder plate type ENTERPRISE size 12 hole ø 12mm with hub grooves 1 stainless steel ø 70mm		



1

<b>GEV No.</b>	696119	<b>Ref. No.</b>	2810 120 14X
<b>description</b>	grinder plate type ENTERPRISE size 12 hole ø 14mm with hub grooves 1 stainless steel ø 70mm		



1

<b>GEV No.</b>	696120	<b>Ref. No.</b>	2810 120 16X
<b>description</b>	grinder plate type ENTERPRISE size 12 hole ø 16mm with hub grooves 1 stainless steel ø 70mm		



1

<b>GEV No.</b>	696121	<b>Ref. No.</b>	2810 120 18X
<b>description</b>	grinder plate type ENTERPRISE size 12 hole ø 18mm with hub grooves 1 stainless steel ø 70mm		



1

<b>GEV No.</b>	696122	<b>Ref. No.</b>	2810 120 20X
<b>description</b>	grinder plate type ENTERPRISE size 12 hole ø 20mm with hub grooves 1 stainless steel ø 70mm		



1

<b>GEV No.</b>	696130	<b>Ref. No.</b>	2810 220 10X
<b>description</b>	grinder plate type ENTERPRISE size 22 hole ø 10mm with hub grooves 1 stainless steel ø 82mm		



1

<b>GEV No.</b>	696134	<b>Ref. No.</b>	2810 220 18X
<b>description</b>	grinder plate type ENTERPRISE size 22 hole ø 18mm with hub grooves 1 stainless steel ø 82mm		



1

<b>GEV No.</b>	696131	<b>Ref. No.</b>	2810 220 12X
<b>description</b>	grinder plate type ENTERPRISE size 22 hole ø 12mm with hub grooves 1 stainless steel ø 82mm		

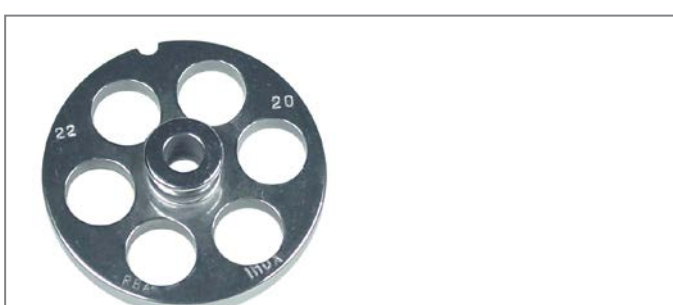

1

<b>GEV No.</b>	696135	<b>Ref. No.</b>	2810 220 20X
<b>description</b>	grinder plate type ENTERPRISE size 22 hole ø 20mm with hub grooves 1 stainless steel ø 82mm		



1

<b>GEV No.</b>	696132	<b>Ref. No.</b>	2810 220 14X
<b>description</b>	grinder plate type ENTERPRISE size 22 hole ø 14mm with hub grooves 1 stainless steel ø 82mm		



1

<b>GEV No.</b>	696144	<b>Ref. No.</b>	2810 320 10X
<b>description</b>	grinder plate type ENTERPRISE size 32 hole ø 10mm with hub grooves 1 stainless steel ø 98mm		



1

<b>GEV No.</b>	696133	<b>Ref. No.</b>	2810 220 16X
<b>description</b>	grinder plate type ENTERPRISE size 22 hole ø 16mm with hub grooves 1 stainless steel ø 82mm		



1

<b>GEV No.</b>	696145	<b>Ref. No.</b>	2810 320 12X
<b>description</b>	grinder plate type ENTERPRISE size 32 hole ø 12mm with hub grooves 1 stainless steel ø 98mm		





1

<b>GEV No.</b>	696146	<b>Ref. No.</b>	2810 320 14X
<b>description</b>	grinder plate type ENTERPRISE size 32 hole ø 14mm with hub grooves 1 stainless steel ø 98mm		



1

<b>GEV No.</b>	696147	<b>Ref. No.</b>	2810 320 16X
<b>description</b>	grinder plate type ENTERPRISE size 32 hole ø 16mm with hub grooves 1 stainless steel ø 98mm		



1

<b>GEV No.</b>	696148	<b>Ref. No.</b>	2810 320 18X
<b>description</b>	grinder plate type ENTERPRISE size 32 hole ø 18mm with hub grooves 1 stainless steel ø 98mm		



1

<b>GEV No.</b>	696149	<b>Ref. No.</b>	2810 320 20X
<b>description</b>	grinder plate type ENTERPRISE size 32 hole ø 20mm with hub grooves 1 stainless steel ø 98mm		



1

<b>GEV No.</b>	696155	<b>Ref. No.</b>	2810 420 10X
<b>description</b>	grinder plate type ENTERPRISE size 42 hole ø 10mm with hub grooves 1 stainless steel ø 130mm		



1

<b>GEV No.</b>	696156	<b>Ref. No.</b>	2810 420 12X
<b>description</b>	grinder plate type ENTERPRISE size 42 hole ø 12mm with hub grooves 1 stainless steel ø 130mm		



1

<b>GEV No.</b>	696157	<b>Ref. No.</b>	2810 420 14X
<b>description</b>	grinder plate type ENTERPRISE size 42 hole ø 14mm with hub grooves 1 stainless steel ø 130mm		



1

<b>GEV No.</b>	696158	<b>Ref. No.</b>	2810 420 16X
<b>description</b>	grinder plate type ENTERPRISE size 42 hole ø 16mm with hub grooves 1 stainless steel ø 130mm		

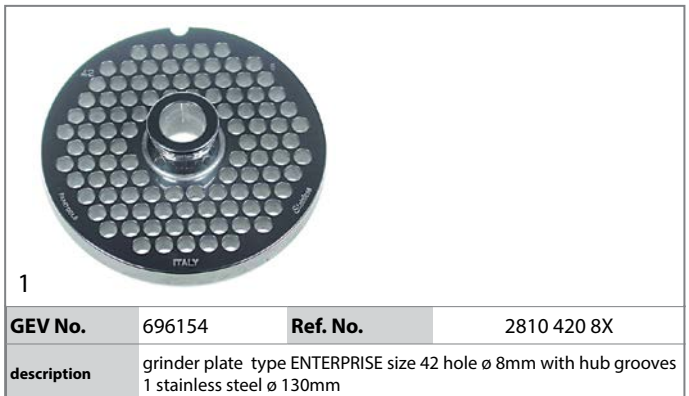
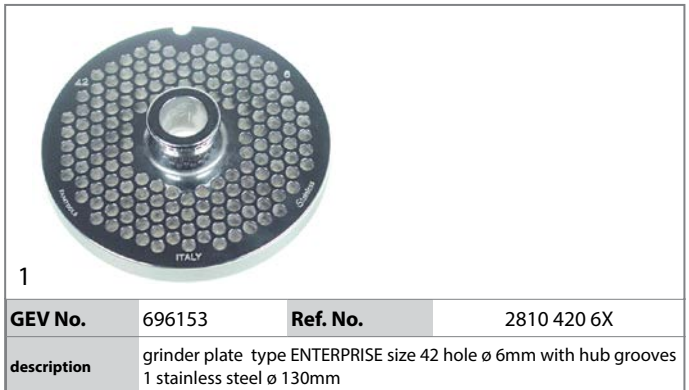





1

<b>GEV No.</b>	696113	<b>Ref. No.</b>	2810 120 35X
<b>description</b>	grinder plate type ENTERPRISE size 12 hole ø 3.5mm with hub grooves 2 stainless steel ø 70mm		



1

<b>GEV No.</b>	696116	<b>Ref. No.</b>	2810 120 8X
<b>description</b>	grinder plate type ENTERPRISE size 12 hole ø 8mm with hub grooves 2 stainless steel ø 70mm		



1

<b>GEV No.</b>	696112	<b>Ref. No.</b>	2810 120 3X
<b>description</b>	grinder plate type ENTERPRISE size 12 hole ø 3mm with hub grooves 2 stainless steel ø 70mm		



1

<b>GEV No.</b>	696124	<b>Ref. No.</b>	2810 220 2X
<b>description</b>	grinder plate type ENTERPRISE size 22 hole ø 2mm with hub grooves 2 stainless steel ø 82mm		



1

<b>GEV No.</b>	696114	<b>Ref. No.</b>	2810 120 45X
<b>description</b>	grinder plate type ENTERPRISE size 12 hole ø 4.5mm with hub grooves 2 stainless steel ø 70mm		



1

<b>GEV No.</b>	696126	<b>Ref. No.</b>	2810 220 35X
<b>description</b>	grinder plate type ENTERPRISE size 22 hole ø 3.5mm with hub grooves 2 stainless steel ø 82mm		



1

<b>GEV No.</b>	696115	<b>Ref. No.</b>	2810 120 6X
<b>description</b>	grinder plate type ENTERPRISE size 12 hole ø 6mm with hub grooves 2 stainless steel ø 70mm		



1

<b>GEV No.</b>	696125	<b>Ref. No.</b>	2810 220 3X
<b>description</b>	grinder plate type ENTERPRISE size 22 hole ø 3mm with hub grooves 2 stainless steel ø 82mm		



1

<b>GEV No.</b>	696127	<b>Ref. No.</b>	2810 220 45X
<b>description</b>	grinder plate type ENTERPRISE size 22 hole ø 4.5mm with hub grooves 2 stainless steel ø 82mm		



1

<b>GEV No.</b>	696137	<b>Ref. No.</b>	2810 320 2X
<b>description</b>	grinder plate type ENTERPRISE size 32 hole ø 2mm with hub grooves 2 stainless steel ø 100mm		



1

<b>GEV No.</b>	696128	<b>Ref. No.</b>	2810 220 6X
<b>description</b>	grinder plate type ENTERPRISE size 22 hole ø 5.8mm with hub grooves 2 stainless steel ø 82mm		



1

<b>GEV No.</b>	696139	<b>Ref. No.</b>	2810 320 35X
<b>description</b>	grinder plate type ENTERPRISE size 32 hole ø 3.5mm with hub grooves 2 stainless steel ø 100mm		



1

<b>GEV No.</b>	696129	<b>Ref. No.</b>	2810 220 8X
<b>description</b>	grinder plate type ENTERPRISE size 22 hole ø 8mm with hub grooves 2 stainless steel ø 82mm		



1

<b>GEV No.</b>	696140	<b>Ref. No.</b>	2810 320 45X
<b>description</b>	grinder plate type ENTERPRISE size 32 hole ø 4.5mm with hub grooves 2 stainless steel ø 100mm		



1

<b>GEV No.</b>	696138	<b>Ref. No.</b>	2810 320 3X
<b>description</b>	grinder plate type ENTERPRISE size 32 hole ø 2.8mm with hub grooves 2 stainless steel ø 100mm		



1

<b>GEV No.</b>	696141	<b>Ref. No.</b>	2810 320 6X
<b>description</b>	grinder plate type ENTERPRISE size 32 hole ø 6mm with hub grooves 2 stainless steel ø 100mm		

1

<b>GEV No.</b>	696143	<b>Ref. No.</b>	2810 320 8X
<b>description</b>	grinder plate type ENTERPRISE size 32 hole ø 8mm with hub grooves 2 stainless steel ø 100mm		



1

<b>GEV No.</b>	696101	<b>Ref. No.</b>	2810 0803X
<b>description</b>	grinder plate type ENTERPRISE size 8 hole ø 3mm with hub grooves 2 stainless steel ø 62mm		



1

<b>GEV No.</b>	696103	<b>Ref. No.</b>	2810 080 45X
<b>description</b>	grinder plate type ENTERPRISE size 8 hole ø 4.5mm with hub grooves 2 stainless steel ø 62mm		



1

<b>GEV No.</b>	696104	<b>Ref. No.</b>	2810 080 6X
<b>description</b>	grinder plate type ENTERPRISE size 8 hole ø 6mm with hub grooves 2 stainless steel ø 62mm		

UNGER



1

<b>GEV No.</b>	696299	<b>Ref. No.</b>	2812 120 10
<b>description</b>	grinder plate type Unger size 12 hole ø 10mm flat grooves 1 stainless steel ø 69.6mm		



1

<b>GEV No.</b>	696301	<b>Ref. No.</b>	2812 120 16
<b>description</b>	grinder plate type Unger size 12 hole ø 16mm flat grooves 1 stainless steel ø 69.6mm		



1

<b>GEV No.</b>	696017	<b>Ref. No.</b>	2812 120 3
<b>description</b>	grinder plate type Unger size 12 hole ø 3mm flat grooves 1 stainless steel ø 69.6mm		



1

<b>GEV No.</b>	696018	<b>Ref. No.</b>	2812 120 45
<b>description</b>	grinder plate type Unger size 12 hole ø 4.5mm flat grooves 1 stainless steel ø 69.6mm		



1

<b>GEV No.</b>	696297	<b>Ref. No.</b>	2812 120 6
<b>description</b>	grinder plate type Unger size 12 hole ø 6mm flat grooves 1 stainless steel ø 69.6mm		





1

<b>GEV No.</b>	696298	<b>Ref. No.</b>	2812 120 8
<b>description</b>	grinder plate type Unger size 12 hole ø 8mm flat grooves 1 stainless steel ø 69.6mm		



1

<b>GEV No.</b>	696306	<b>Ref. No.</b>	2812 220 10
<b>description</b>	grinder plate type Unger size 22 hole ø 10mm flat grooves 1 stainless steel ø 81.6mm		



1

<b>GEV No.</b>	696308	<b>Ref. No.</b>	2812 220 16
<b>description</b>	grinder plate type Unger size 22 hole ø 16mm flat grooves 1 stainless steel ø 81.6mm		



1

<b>GEV No.</b>	696302	<b>Ref. No.</b>	2812 220 3
<b>description</b>	grinder plate type Unger size 22 hole ø 3mm flat grooves 1 stainless steel ø 81.6mm		



1

<b>GEV No.</b>	696303	<b>Ref. No.</b>	2812 220 45
<b>description</b>	grinder plate type Unger size 22 hole ø 4.5mm flat grooves 1 stainless steel ø 81.6mm		



1

<b>GEV No.</b>	696304	<b>Ref. No.</b>	2812 220 6
<b>description</b>	grinder plate type Unger size 22 hole ø 6mm flat grooves 1 stainless steel ø 81.6mm		



1

<b>GEV No.</b>	696305	<b>Ref. No.</b>	2812 220 8
<b>description</b>	grinder plate type Unger size 22 hole ø 8mm flat grooves 1 stainless steel ø 81.6mm		



1

<b>GEV No.</b>	696313	<b>Ref. No.</b>	2812 320 10
<b>description</b>	grinder plate type Unger size 32 hole ø 10mm flat grooves 1 stainless steel ø 97.6mm		



1

<b>GEV No.</b>	696315	<b>Ref. No.</b>	2812 320 16
<b>description</b>	grinder plate type Unger size 32 hole ø 16mm flat grooves 1 stainless steel ø 97.6mm		



1

<b>GEV No.</b>	696309	<b>Ref. No.</b>	2812 320 3
<b>description</b>	grinder plate type Unger size 32 hole ø 3mm flat grooves 1 stainless steel ø 97.6mm		

1

<b>GEV No.</b>	696310	<b>Ref. No.</b>	2812 320 45
<b>description</b>	grinder plate type Unger size 32 hole ø 4.5mm flat grooves 1 stainless steel ø 97.6mm		



1

<b>GEV No.</b>	696316	<b>Ref. No.</b>	2812 420 3
<b>description</b>	grinder plate type Unger size 42 hole ø 3mm flat grooves 1 stainless steel ø 130mm		



1

<b>GEV No.</b>	696311	<b>Ref. No.</b>	2812 320 6
<b>description</b>	grinder plate type Unger size 32 hole ø 6mm flat grooves 1 stainless steel ø 97.6mm		



1

<b>GEV No.</b>	696317	<b>Ref. No.</b>	2812 420 45
<b>description</b>	grinder plate type Unger size 42 hole ø 4.5mm flat grooves 1 stainless steel ø 130mm		



1

<b>GEV No.</b>	696312	<b>Ref. No.</b>	2812 320 8
<b>description</b>	grinder plate type Unger size 32 hole ø 8mm flat grooves 1 stainless steel ø 97.6mm		



1

<b>GEV No.</b>	696318	<b>Ref. No.</b>	2812 420 6
<b>description</b>	grinder plate type Unger size 42 hole ø 6mm flat grooves 1 stainless steel ø 130mm		



1

<b>GEV No.</b>	696320	<b>Ref. No.</b>	2812 420 10
<b>description</b>	grinder plate type Unger size 42 hole ø 10mm flat grooves 1 stainless steel ø 130mm		



1

<b>GEV No.</b>	696319	<b>Ref. No.</b>	2812 420 8
<b>description</b>	grinder plate type Unger size 42 hole ø 8mm flat grooves 1 stainless steel ø 130mm		



1

<b>GEV No.</b>	696322	<b>Ref. No.</b>	2812 420 16
<b>description</b>	grinder plate type Unger size 42 hole ø 16mm flat grooves 1 stainless steel ø 130mm		



1

<b>GEV No.</b>	696161	<b>Ref. No.</b>	2812 12FX
<b>description</b>	grinder plate type Unger size 12 hole ø 6mm flat grooves 1 stainless steel ø 69.6mm		
<b>For models:</b>	TC12F, TCG12E		

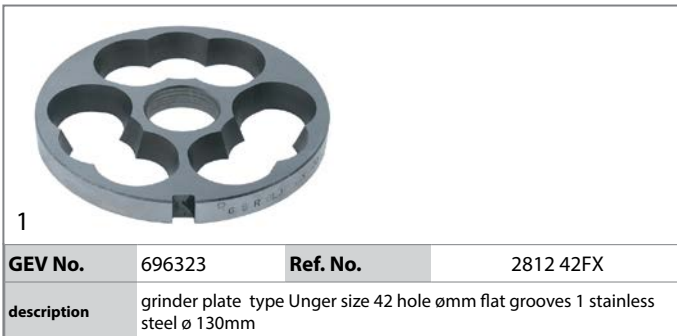
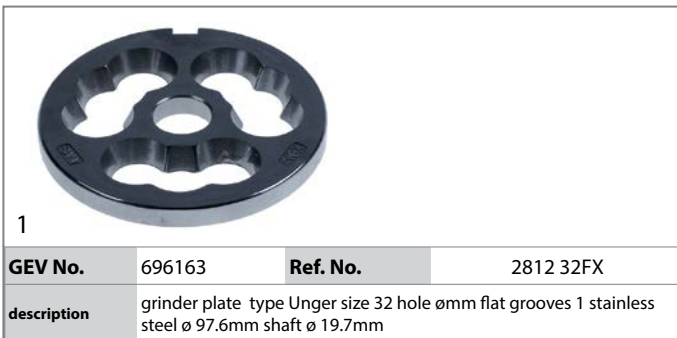
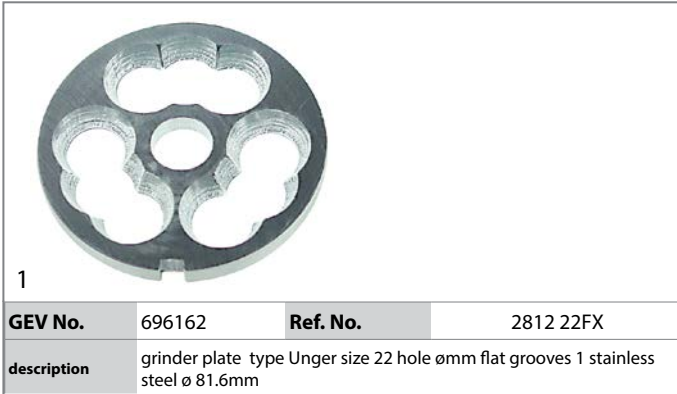

## blades

## ENTERPRISE

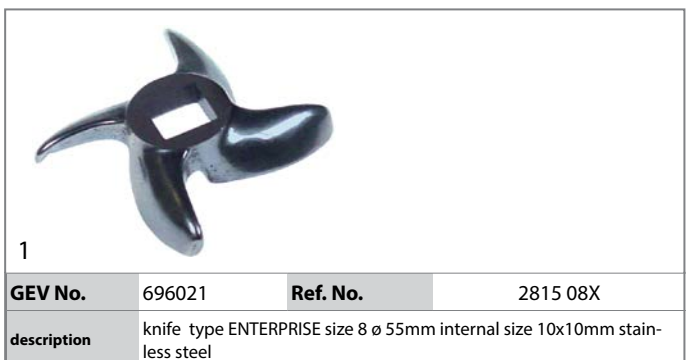
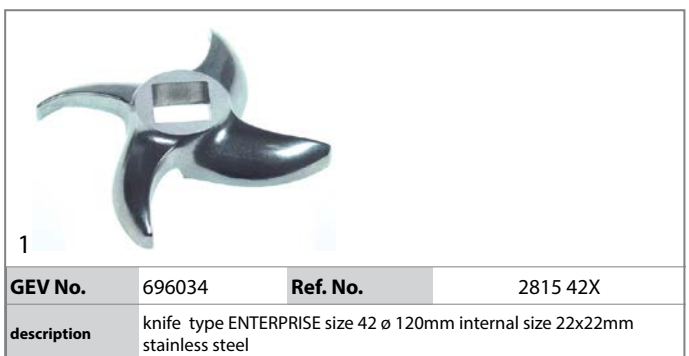
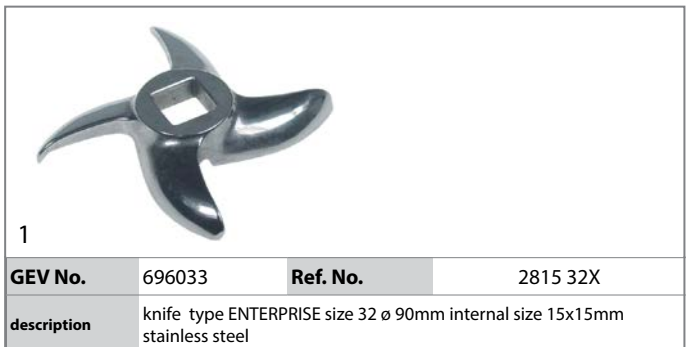
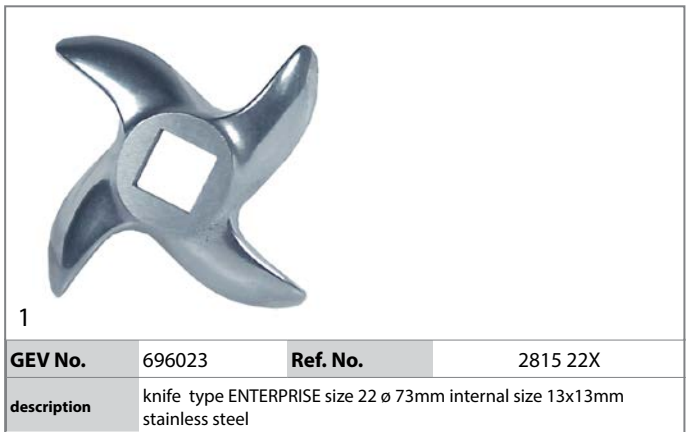



UNGER

with fixed blades



1

<b>GEV No.</b>	696032	<b>Ref. No.</b>	28030520 2815 32UX
<b>description</b>	knife type Unger size B-98 (32) ø 90mm stainless steel		



1

<b>GEV No.</b>	696031	<b>Ref. No.</b>	2815 22UX
<b>description</b>	knife type Unger size H-82 (22) ø 73mm stainless steel		



1

<b>GEV No.</b>	696030	<b>Ref. No.</b>	2815 12UX
<b>description</b>	knife type Unger size R-70 (12) ø 62mm stainless steel		

spacer rings



1

<b>GEV No.</b>	698068	<b>Ref. No.</b>	2803 055 2
<b>description</b>	spacer ring type Unger size H-82 (22) ø 81.5mm H 18mm		



1

<b>GEV No.</b>	698047	<b>Ref. No.</b>	LF311D DX
<b>description</b>	spacer ring type Unger size R-70 (12) ø 69.5mm H 15mm		

ring nuts



1

<b>GEV No.</b>	698049	<b>Ref. No.</b>	MF2134
<b>description</b>	ring nut Unger model 12 stainless steel		



1

<b>GEV No.</b>	698070	<b>Ref. No.</b>	MF2254
<b>description</b>	ring nut Unger model 22 stainless steel thread M94x2		



1

<b>GEV No.</b>	698147	<b>Ref. No.</b>	LF2034103
<b>description</b>	ring nut Unger model 42 stainless steel		
<b>For models:</b>	TC42IND		



1

<b>GEV No.</b>	698161	<b>Ref. No.</b>	IV2540505L LF2037074
<b>description</b>	ring nut ENTERPRISE model 12 ID ø 62mm stainless steel		
<b>For models:</b>	TC 12 MAGNUM INGRANAGGI CE, TC12M, TCG12M		



1

<b>GEV No.</b>	698231	<b>Ref. No.</b>	29030401
<b>description</b>	ring nut ENTERPRISE model 8 ID ø 68mm aluminium		



1

<b>GEV No.</b>	698136	<b>Ref. No.</b>	LF2032607
<b>description</b>	ring nut model 32 cast iron		
<b>For models:</b>	TC32PF		



1

<b>GEV No.</b>	698138	<b>Ref. No.</b>	LF2033103
<b>description</b>	ring nut model 32 ID ø 90mm stainless steel		
<b>For models:</b>	MASTER30, TC32BU, TC32CHICAGO, TC32FR, TC32IND, TC32LAPORTE, TC32RIO		



1

<b>GEV No.</b>	698107	<b>Ref. No.</b>	LF2031003
<b>description</b>	ring nut Unger model 12 ED ø 84mm thickness 26mm ID ø 62mm stainless steel thread M78x2		
<b>For models:</b>	TC12CHICAGO, TC12F, TC12RIO		



1

<b>GEV No.</b>	698040	<b>Ref. No.</b>	MF0133 MF2133
<b>description</b>	ring nut Unger model 12 ED ø 89mm thickness 27mm ID ø 64mm stainless steel thread M82x2		
<b>For models:</b>	TCG12E		



1

<b>GEV No.</b>	698039	<b>Ref. No.</b>	MF0132 MF2132
<b>description</b>	ring nut Unger model 12 ID ø 78mm aluminium		
<b>For models:</b>	TCG12E		



1

<b>GEV No.</b>	698111	<b>Ref. No.</b>	LF2032007
<b>description</b>	ring nut Unger model 22 ED ø 103mm thickness 28mm ID ø 74mm stainless steel thread M96x2		
<b>For models:</b>	TC22CHICAGO, TC22F, TC22FR, TC22LAPORTE, TC22RIO		
<b>accessories for</b>	698111		
	<b>GEV No.</b>	698108	<b>Ref. No.</b>
			LF2032005
	auger chamber ENTERPRISE model 22 stainless steel		



1

<b>GEV No.</b>	698057	<b>Ref. No.</b>	MF0187 MF2220
<b>description</b>	ring nut Unger model 22 ID ø 73mm aluminium		
<b>For models:</b>	TC22E CE, TCG 22 E CE, TCG22E		





			
1			
<b>GEV No.</b>	698133	<b>Ref. No.</b>	LF2032503
<b>description</b>	ring nut Unger model 22 ID ø 73mm cast iron		
<b>For models:</b>	TC22PF		

			
1			
<b>GEV No.</b>	698058	<b>Ref. No.</b>	MF0188 MF2221
<b>description</b>	ring nut Unger model 22 ID ø 74mm stainless steel thread M94x2		
<b>For models:</b>	TC22E CE, TCG 22 E CE, TCG22E		

**augers**  
**complete**

 Image not available			
1			
<b>GEV No.</b>	696008	<b>Ref. No.</b>	MF0143
<b>description</b>	auger aluminium		

 Image not available			
1			
<b>GEV No.</b>	696011	<b>Ref. No.</b>	MF0274
<b>description</b>	auger cast iron Unger		

			
1			
<b>GEV No.</b>	698975	<b>Ref. No.</b>	29030311
<b>description</b>	auger model 12 ø 52mm L 108mm aluminium with spindle ENTERPRISE		

			
1			
<b>GEV No.</b>	698037	<b>Ref. No.</b>	F2124PS MF0126 MF2124 MF2124+MF2127
<b>description</b>	auger model 12 ø 53mm L 135mm stainless steel with spindle ENTERPRISE		
<b>For models:</b>	TCG12E		

			
1			
<b>GEV No.</b>	698035	<b>Ref. No.</b>	MF2122 MF2122+MF2127
<b>description</b>	auger model 12 ø 53mm L 140mm aluminium with spindle ENTERPRISE		

			
1			
<b>GEV No.</b>	698043	<b>Ref. No.</b>	MF2125 MF2125+MF2128
<b>description</b>	auger model 12 ø 53mm L 145mm cast iron with spindle Unger		

			
1			
<b>GEV No.</b>	698044	<b>Ref. No.</b>	MF2126 MF2126+MF2129
<b>description</b>	auger model 12 ø 53mm L 145mm stainless steel with spindle Unger		

			
1			
<b>GEV No.</b>	698036	<b>Ref. No.</b>	MF0125 MF2123 MF2123+MF2127
<b>description</b>	auger model 12 ø 53mm L 150mm cast iron with spindle ENTERPRISE		
<b>For models:</b>	TCG12E		

			
1			
<b>GEV No.</b>	699185	<b>Ref. No.</b>	LF2031004+LF2038010
<b>description</b>	auger model 12 stainless steel with drive shaft ENTERPRISE		

			
1			
<b>GEV No.</b>	698053	<b>Ref. No.</b>	F2214PS MF0183 MF2214 MF2214+MF2217
<b>description</b>	auger model 22 ø 63mm L 150mm aluminium with spindle ENTERPRISE		
<b>For models:</b>	TC22E CE, TCG 22 E CE, TCG22E		

			
1			
<b>GEV No.</b>	698054	<b>Ref. No.</b>	MF0182 MF2215 MF2215+MF2217
<b>description</b>	auger model 22 ø 63mm L 150mm cast iron with spindle ENTERPRISE		
<b>For models:</b>	TC22E CE, TCG 22 E CE, TCG22E		

			
1			
<b>GEV No.</b>	698063	<b>Ref. No.</b>	F2242PU MF0356 MF2242 MF2242+MF2243 MF2242+MF2252
<b>description</b>	auger model 22 ø 63mm L 175mm cast iron with spindle Unger		

			
1			
<b>GEV No.</b>	698055	<b>Ref. No.</b>	MF0184 MF2216 MF2216+MF2217
<b>description</b>	auger model 22 ø 64mm L 150mm stainless steel with spindle ENTERPRISE		
<b>For models:</b>	TC22E CE, TCG 22 E CE, TCG22E		

			
1			
<b>GEV No.</b>	698062	<b>Ref. No.</b>	MF0199 MF0353 MF2251 MF2251+MF2252
<b>description</b>	auger model 22 ø 64mm L 175mm stainless steel with spindle Unger		

			
1			
<b>GEV No.</b>	698304	<b>Ref. No.</b>	LF2032912
<b>description</b>	auger model 32 ø 63mm L 200mm stainless steel conical complete		

			
1			
<b>GEV No.</b>	698228	<b>Ref. No.</b>	29030301
<b>description</b>	auger model 8 ø 45mm L 100mm aluminium with spindle ENTERPRISE		

			
1			
<b>GEV No.</b>	698160	<b>Ref. No.</b>	IV2520505L LF2037072
<b>description</b>	auger ø 53mm L 115mm stainless steel standard shaft diameter 17x17mm with spindle type Mod.12		
<b>For models:</b>	TC 12 MAGNUM INGRANAGGI CE, TC12M, TCG12M		

1  
Image not available

<b>GEV No.</b>	696010	<b>Ref. No.</b>	MF0196
<b>description</b>	auger stainless steel Unger		



1

<b>GEV No.</b>	698171	<b>Ref. No.</b>	LF2038310
<b>description</b>	auger model 22 ø 59mm L 125mm stainless steel		
<b>For models:</b>	TC22FR, TC22LAPORTE, TC22RIO		

without bolt



1

<b>GEV No.</b>	698105	<b>Ref. No.</b>	LF2031002
<b>description</b>	auger model 12 ø 45mm L 180mm stainless steel with spindle		
<b>For models:</b>	TC12CHICAGO, TC12F		



1

<b>GEV No.</b>	698109	<b>Ref. No.</b>	LF2032006
<b>description</b>	auger model 22 stainless steel		
<b>For models:</b>	TC22CHICAGO, TC22F		



1

<b>GEV No.</b>	698170	<b>Ref. No.</b>	LF2038010
<b>description</b>	auger model 12 stainless steel		
<b>For models:</b>	TC12RIO		



1

<b>GEV No.</b>	698134	<b>Ref. No.</b>	LF2032606
<b>description</b>	auger model 32 ø 70mm L 140mm cast iron		
<b>For models:</b>	TC32PF		



1

<b>GEV No.</b>	698132	<b>Ref. No.</b>	LF2032502
<b>description</b>	auger model 22 cast iron		
<b>For models:</b>	TC22PF		



1

<b>GEV No.</b>	698172	<b>Ref. No.</b>	LF2038610
<b>description</b>	auger model 32 ø 74mm L 165mm stainless steel		
<b>For models:</b>	TC32FR, TC32LAPORTE, TC32RIO		



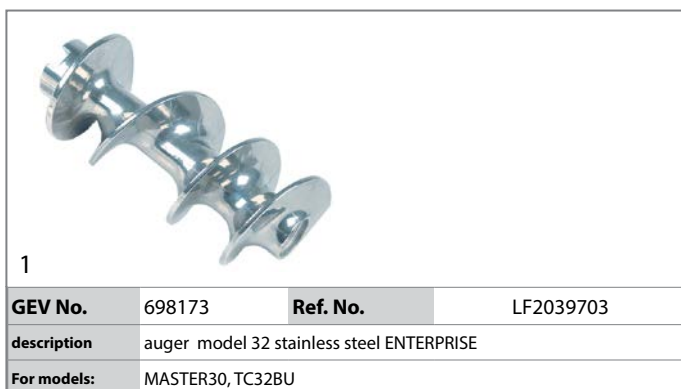
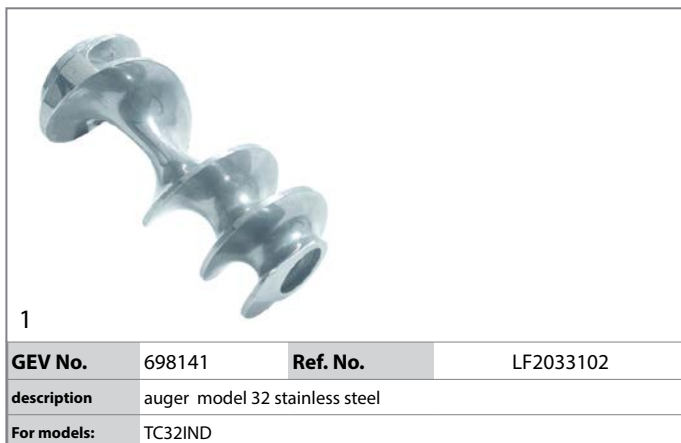

## augers chambers

## outer parts

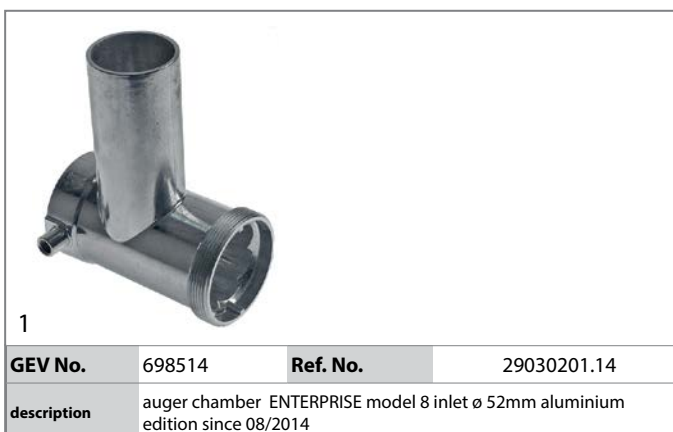



## inner parts





			
1			
<b>GEV No.</b>	698104	<b>Ref. No.</b>	LF2031001
<b>description</b>	auger chamber ENTERPRISE model 12 inlet ø 60mm stainless steel		
<b>For models:</b>	TC12F, TC12RIO		

			
1			
<b>GEV No.</b>	698034	<b>Ref. No.</b>	MF0123 MF2118
<b>description</b>	auger chamber ENTERPRISE model 12 inlet ø 61mm stainless steel		
<b>For models:</b>	TCG12E		

			
1			
<b>GEV No.</b>	698050	<b>Ref. No.</b>	MF0180 MF2212
<b>description</b>	auger chamber ENTERPRISE model 22 inlet ø 62mm aluminium		
<b>For models:</b>	TC22E CE, TCG 22 E CE, TCG22E		

			
1			
<b>GEV No.</b>	698051	<b>Ref. No.</b>	MF0179 MF2210
<b>description</b>	auger chamber ENTERPRISE model 22 inlet ø 62mm cast iron		
<b>For models:</b>	TC22E CE, TCG 22 E CE, TCG22E		

			
1			
<b>GEV No.</b>	698052	<b>Ref. No.</b>	MF2211
<b>description</b>	auger chamber ENTERPRISE model 22 inlet ø 62mm stainless steel thread M94x2		
<b>For models:</b>	TC22E CE, TCG 22 E CE		
<b>accessories for</b>	698052		
	<b>GEV No.</b>	690058	<b>Ref. No.</b> —
	counter support for off-set 19mm mounting distance 14.25mm W 28mm L 52mm H 50mm type 6000/6004 no. 6000-020701		

			
1			
<b>GEV No.</b>	698108	<b>Ref. No.</b>	LF2032005
<b>description</b>	auger chamber ENTERPRISE model 22 stainless steel		
<b>For models:</b>	TC22F, TC22FR, TC22LAPORTE, TC22RIO		
<b>accessories for</b>	698108		
	<b>GEV No.</b>	698111	<b>Ref. No.</b> LF2032007
	ring nut Unger model 22 ED ø 103mm thickness 28mm ID ø 74mm stainless steel thread M96x2		

			
1			
<b>GEV No.</b>	698169	<b>Ref. No.</b>	LF2033101
<b>description</b>	auger chamber ENTERPRISE model 32 inlet ø 77mm stainless steel		
<b>For models:</b>	TC32FR, TC32RIO		

 Image not available			
1			
<b>GEV No.</b>	696005	<b>Ref. No.</b>	MF0273
<b>description</b>	auger chamber Unger cast iron		

			
1			
<b>GEV No.</b>	698041	<b>Ref. No.</b>	MF2120
<b>description</b>	auger chamber Unger model 12 inlet ø 59mm cast iron		

			
1			
<b>GEV No.</b>	698042	<b>Ref. No.</b>	MF2121
<b>description</b>	auger chamber Unger model 12 stainless steel		

			
1			
<b>GEV No.</b>	698059	<b>Ref. No.</b>	MF0355 MF2240
<b>description</b>	auger chamber Unger model 22 inlet ø 62mm cast iron		
<b>For models:</b>	TCG22E		

			
1			
<b>GEV No.</b>	698061	<b>Ref. No.</b>	F2255 + F2213 MF0198 MF2255
<b>description</b>	auger chamber Unger model 22 inlet ø 62mm cast iron for double-bladed knife		

			
1			
<b>GEV No.</b>	698060	<b>Ref. No.</b>	MF0354 MF2250
<b>description</b>	auger chamber Unger model 22 stainless steel		

 Image not available			
1			
<b>GEV No.</b>	696004	<b>Ref. No.</b>	MF0195
<b>description</b>	auger chamber Unger stainless steel		

miscellaneous  Image not available			
1			
<b>GEV No.</b>	696013	<b>Ref. No.</b>	MF0197
<b>description</b>	bolt		

			
1			
<b>GEV No.</b>	698363	<b>Ref. No.</b>	LF2034008
<b>description</b>	casing cover for gearbox		

			
1			
<b>GEV No.</b>	698967	<b>Ref. No.</b>	LF1039710
<b>description</b>	magnet ø 32mm		

plungers

			
1			
<b>GEV No.</b>	698229	<b>Ref. No.</b>	29561800
<b>description</b>	plunger ø 41mm L 95mm total length 200mm		

			
1			
<b>GEV No.</b>	698080	<b>Ref. No.</b>	MF0139 MF0190 MF2114 MF2208
<b>description</b>	plunger ø 46mm L 120mm total length 240mm plastic hollow		
<b>For models:</b>	TC22E CE, TCG 22 E CE		

			
1			
<b>GEV No.</b>	698659	<b>Ref. No.</b>	LF2032017
<b>description</b>	plunger ø 48mm L 125mm total length 280mm plastic hollow		



1

<b>GEV No.</b>	698371	<b>Ref. No.</b>	LF2035861
<b>description</b>	plunger ø 48mm L 165mm total length 320mm		



1

<b>GEV No.</b>	698182	<b>Ref. No.</b>	LF1533004
<b>description</b>	plunger ø 50mm L 165mm total length 310mm		

for cutters

drive shafts



1

<b>GEV No.</b>	693940	<b>Ref. No.</b>	MSC04N104
<b>description</b>	drive shaft D1 ø 65mm ø 15mm L 170mm C4-C4VV		
<b>For models:</b>	C9VV CE		



1

<b>GEV No.</b>	694348	<b>Ref. No.</b>	MSC06N104	
<b>description</b>	drive shaft D1 ø 65mm ø 15mm L 233mm C6 CE/VT/VV			
<b>For models:</b>	C9VV CE			
<b>accessories for</b>	694348			
	<b>GEV No.</b>	698305	<b>Ref. No.</b>	LF1232605
	gasket for mincer thickness 0.9mm for gearbox			



1

<b>GEV No.</b>	694347	<b>Ref. No.</b>	MSC09V104
<b>description</b>	drive shaft D1 ø 85mm ø 20mm L 295mm C9VV CE		

containers



1

<b>GEV No.</b>	697290	<b>Ref. No.</b>	MSC09V076
<b>description</b>	container C9VV edition since 10/2003		



1

<b>GEV No.</b>	698976	<b>Ref. No.</b>	40750080
<b>description</b>	sump GN 1/3 H 200mm plastic		
<b>For models:</b>	TV-TM INOX, TV-TM INOX07		

lids



1

<b>GEV No.</b>	691247	<b>Ref. No.</b>	MSC04N052
<b>description</b>	lid for cutter ø 225mm ID ø 204mm plastic C4-C6 edition until 08/2003		

			
1			
<b>GEV No.</b>	691664	<b>Ref. No.</b>	MSC04V052A
<b>description</b>	lid for cutter ø 225mm ID ø 204mm plastic with gasket C4-C6 edition since 08/2003		
<b>For models:</b>	C9VV CE		









			
1			
<b>GEV No.</b>	693943	<b>Ref. No.</b>	MSC09V052A
<b>description</b>	lid for cutter ø 265mm ID ø 240mm plastic with gasket C9VV edition since 10/2003		



			
1			
<b>GEV No.</b>	693784	<b>Ref. No.</b>	MSC15N052
<b>description</b>	lid for cutter ø 300mm ID ø 280mm plastic C15		

## blades









## spacer rings







			
Image not available			
1			
<b>GEV No.</b>	696035	<b>Ref. No.</b>	MSC04N068P
<b>description</b>	spacer ring ED ø 60mm int. ø 1 30mm H 12mm mounting distance 46mm 4 hole hole ø 4.2mm plastic C4-C4VV		
<b>For models:</b>	C9VV CE		



				
1				
<b>GEV No.</b>	696020	<b>Ref. No.</b>	MSC04N068	
<b>description</b>	spacer ring ED ø 60mm int. ø 1 30mm H 14mm mounting distance 46mm 4 hole hole ø 4.2mm plastic C4-C4VV			
<b>For models:</b>	C9VV CE			
<b>accessories for</b>	696020			
	<b>GEV No.</b>	696037	<b>Ref. No.</b>	MSC04N062
	<b>GEV No.</b>	696174	<b>Ref. No.</b>	MSC04N064F
	<b>GEV No.</b>	696175	<b>Ref. No.</b>	MSC04N072F
	<b>GEV No.</b>	696176	<b>Ref. No.</b>	MSC04N064
	<b>GEV No.</b>	696177	<b>Ref. No.</b>	MSC04N072
	<b>GEV No.</b>	696178	<b>Ref. No.</b>	MSC04N064Z
	<b>GEV No.</b>	696179	<b>Ref. No.</b>	MSC04N072Z



				
1				
<b>GEV No.</b>	696042	<b>Ref. No.</b>	MSC06N068P	
<b>description</b>	spacer ring ED ø 60mm int. ø 1 30mm H 18mm mounting distance 46mm 4 hole hole ø 4.2mm plastic C6-C6VV			
<b>For models:</b>	C9VV CE			
<b>accessories for</b>	696042			
	<b>GEV No.</b>	696040	<b>Ref. No.</b>	MSC06N062P
	<b>GEV No.</b>	696180	<b>Ref. No.</b>	MSC04N064V



 <p>1</p>			
<b>GEV No.</b>	696041	<b>Ref. No.</b>	MSC06N068
<b>description</b>	spacer ring ED ø 60mm int. ø 1 30mm H 20mm mounting distance 46mm 4 hole hole ø 4.2mm plastic C6-C6VV		
<b>For models:</b>	C9VV CE		
<b>accessories for</b>	696041		
	<b>GEV No.</b>	696039	<b>Ref. No.</b> MSC06N062
	blade holder ED ø 60mm int. ø 1 15mm int. ø 2 30mm H 133mm mounting distance 46mm 4 hole hole ø 3mm plastic C6-C6VV		
	<b>GEV No.</b>	696174	<b>Ref. No.</b> MSC04N064F
	mixer mounting pos. upper L 98mm seat ø 33mm mounting distance 46mm 4 hole hole ø 4.4mm thickness 2mm model C4-C6		
	<b>GEV No.</b>	696175	<b>Ref. No.</b> MSC04N072F
	knife mounting pos. lower L 93mm seat ø 33mm mounting distance 46mm 4 hole hole ø 4.4mm thickness 2mm model C4-C6		
	<b>GEV No.</b>	696176	<b>Ref. No.</b> MSC04N064
	knife mounting pos. upper L 98mm seat ø 33mm mounting distance 46mm 4 hole hole ø 4.4mm thickness 2mm model C4-C6		
	<b>GEV No.</b>	696177	<b>Ref. No.</b> MSC04N072
	knife mounting pos. lower L 93mm seat ø 33mm mounting distance 46mm 4 hole hole ø 4.4mm thickness 2mm model C4-C6		
	<b>GEV No.</b>	696178	<b>Ref. No.</b> MSC04N064Z
	knife mounting pos. upper L 98mm seat ø 42mm mounting distance 46mm 4 hole hole ø 4.4mm thickness 2mm model C4-C6		
	<b>GEV No.</b>	696179	<b>Ref. No.</b> MSC04N072Z
	knife mounting pos. lower L 93mm seat ø 33mm mounting distance 46mm 4 hole hole ø 4.4mm thickness 2mm model C4-C6		

 <p>1</p>			
<b>GEV No.</b>	696000	<b>Ref. No.</b>	MSC09V068
<b>description</b>	spacer ring ED ø 72mm int. ø 1 38mm H 24mm mounting distance 58mm 4 hole hole ø 5mm plastic C9VV		
<b>accessories for</b>	696000		
	<b>GEV No.</b>	696036	<b>Ref. No.</b> MSC09V062
	blade holder ED ø 72mm int. ø 1 20mm int. ø 2 38mm H 165mm mounting distance 58mm 4 hole hole ø 3.5mm plastic C9VV		
	<b>GEV No.</b>	696182	<b>Ref. No.</b> MSC09V064F
	mixer mounting pos. upper L 119mm seat ø 42mm mounting distance 58mm 4 hole hole ø 4.4mm thickness 2.5mm model C9VV		
	<b>GEV No.</b>	696183	<b>Ref. No.</b> MSC09V072F
	mixer mounting pos. lower L 112mm seat ø 42mm mounting distance 58mm 4 hole hole ø 4.4mm thickness 2.5mm model C9VV		
	<b>GEV No.</b>	696184	<b>Ref. No.</b> MSC09V064
	knife mounting pos. upper L 119mm seat ø 42mm mounting distance 58mm 4 hole hole ø 4.4mm thickness 2.5mm model C9VV		
	<b>GEV No.</b>	696185	<b>Ref. No.</b> MSC09V072
	knife mounting pos. lower L 112mm seat ø 42mm mounting distance 58mm 4 hole hole ø 4.4mm thickness 2.5mm model C9VV		

<b>accessories for</b>	696000		
	<b>GEV No.</b>	696186	<b>Ref. No.</b> MSC09V064Z
	knife mounting pos. upper L 119mm seat ø 42mm mounting distance 58mm 4 hole hole ø 4.4mm thickness 2.5mm model C9VV		
	<b>GEV No.</b>	696187	<b>Ref. No.</b> MSC09V072Z
	knife mounting pos. lower L 112mm seat ø 42mm mounting distance 58mm 4 hole hole ø 4.4mm thickness 2.5mm model C9VV		

<b>holders</b>			
 <p>1</p>			
<b>GEV No.</b>	696040	<b>Ref. No.</b>	MSC06N062P
<b>description</b>	blade holder ED ø 60mm int. ø 1 15mm int. ø 2 30mm H 128mm mounting distance 46mm 4 hole hole ø 3mm plastic ø 60 C6-C6VV-mm		
<b>For models:</b>	C9VV CE		
<b>accessories for</b>	696040		
	<b>GEV No.</b>	696042	<b>Ref. No.</b> MSC06N068P
	spacer ring ED ø 60mm int. ø 1 30mm H 18mm mounting distance 46mm 4 hole hole ø 4.2mm plastic C6-C6VV		
	<b>GEV No.</b>	696180	<b>Ref. No.</b> MSC04N064V
	knife mounting pos. upper L 98mm seat ø 33mm mounting distance 46mm 4 hole hole ø 4.4mm thickness 2mm model C4-C6		











 <p>1</p>			
<b>GEV No.</b>	696039	<b>Ref. No.</b>	MSC06N062
<b>description</b>	blade holder ED ø 60mm int. ø 1 15mm int. ø 2 30mm H 133mm mounting distance 46mm 4 hole hole ø 3mm plastic C6-C6VV		
<b>For models:</b>	C9VV CE		
<b>accessories for</b>	696039		
	<b>GEV No.</b>	696041	<b>Ref. No.</b> MSC06N068
	spacer ring ED ø 60mm int. ø 1 30mm H 20mm mounting distance 46mm 4 hole hole ø 4.2mm plastic C6-C6VV		
	<b>GEV No.</b>	696174	<b>Ref. No.</b> MSC04N064F
	mixer mounting pos. upper L 98mm seat ø 33mm mounting distance 46mm 4 hole hole ø 4.4mm thickness 2mm model C4-C6		
	<b>GEV No.</b>	696175	<b>Ref. No.</b> MSC04N072F
	knife mounting pos. lower L 93mm seat ø 33mm mounting distance 46mm 4 hole hole ø 4.4mm thickness 2mm model C4-C6		

Table continues overleaf

accessories for		696039	
GEV No.	696176	Ref. No.	MSC04N064
			knife mounting pos. upper L 98mm seat ø 33mm mounting distance 46mm 4 hole hole ø 4.4mm thickness 2mm model C4-C6
			knife mounting pos. lower L 93mm seat ø 33mm mounting distance 46mm 4 hole hole ø 4.4mm thickness 2mm model C4-C6
			knife mounting pos. upper L 98mm seat ø 42mm mounting distance 46mm 4 hole hole ø 4.4mm thickness 2mm model C4-C6
			knife mounting pos. lower L 93mm seat ø 33mm mounting distance 46mm 4 hole hole ø 4.4mm thickness 2mm model C4-C6







1

GEV No.	696038	Ref. No.	MSC04N062P
<b>description</b>	blade holder ED ø 60mm int. ø 1 15mm int. ø 2 30mm H 72mm mounting distance 46mm 4 hole hole ø 3mm plastic C4-C4VV		
<b>For models:</b>	C9VV CE		
<b>accessories for</b>	696038		
			spacer ring ED ø 60mm int. ø 1 30mm H 12mm mounting distance 46mm 4 hole hole ø 4.2mm plastic C4-C4VV
			knife mounting pos. upper L 98mm seat ø 33mm mounting distance 46mm 4 hole hole ø 4.4mm thickness 2mm model C4-C6









1

GEV No.	696037	Ref. No.	MSC04N062
<b>description</b>	blade holder ED ø 60mm int. ø 1 15mm int. ø 2 30mm H 77mm mounting distance 46mm 4 hole hole ø 3mm plastic C4-C4VV		
<b>For models:</b>	C9VV CE		
<b>accessories for</b>	696037		
			spacer ring ED ø 60mm int. ø 1 30mm H 14mm mounting distance 46mm 4 hole hole ø 4.2mm plastic C4-C4VV
			mixer mounting pos. upper L 98mm seat ø 33mm mounting distance 46mm 4 hole hole ø 4.4mm thickness 2mm model C4-C6
			knife mounting pos. lower L 93mm seat ø 33mm mounting distance 46mm 4 hole hole ø 4.4mm thickness 2mm model C4-C6

accessories for		696037	
GEV No.	696176	Ref. No.	MSC04N064
			knife mounting pos. upper L 98mm seat ø 33mm mounting distance 46mm 4 hole hole ø 4.4mm thickness 2mm model C4-C6
			knife mounting pos. lower L 93mm seat ø 33mm mounting distance 46mm 4 hole hole ø 4.4mm thickness 2mm model C4-C6
			knife mounting pos. upper L 98mm seat ø 42mm mounting distance 46mm 4 hole hole ø 4.4mm thickness 2mm model C4-C6
			knife mounting pos. lower L 93mm seat ø 33mm mounting distance 46mm 4 hole hole ø 4.4mm thickness 2mm model C4-C6





1

GEV No.	696036	Ref. No.	MSC09V062
<b>description</b>	blade holder ED ø 72mm int. ø 1 20mm int. ø 2 38mm H 165mm mounting distance 58mm 4 hole hole ø 3.5mm plastic C9VV		
<b>accessories for</b>	696036		
			spacer ring ED ø 72mm int. ø 1 38mm H 24mm mounting distance 58mm 4 hole hole ø 5mm plastic C9VV
			mixer mounting pos. upper L 119mm seat ø 42mm mounting distance 58mm 4 hole hole ø 4.4mm thickness 2.5mm model C9VV
			mixer mounting pos. lower L 112mm seat ø 42mm mounting distance 58mm 4 hole hole ø 4.4mm thickness 2.5mm model C9VV
			knife mounting pos. upper L 119mm seat ø 42mm mounting distance 58mm 4 hole hole ø 4.4mm thickness 2.5mm model C9VV
			knife mounting pos. lower L 112mm seat ø 42mm mounting distance 58mm 4 hole hole ø 4.4mm thickness 2.5mm model C9VV
			knife mounting pos. upper L 119mm seat ø 42mm mounting distance 58mm 4 hole hole ø 4.4mm thickness 2.5mm model C9VV
			knife mounting pos. lower L 112mm seat ø 42mm mounting distance 58mm 4 hole hole ø 4.4mm thickness 2.5mm model C9VV





blades			
blades serrated			
			
1			
<b>GEV No.</b>	696187	<b>Ref. No.</b>	MSC09V072Z
<b>description</b>	knife mounting pos. lower L 112mm seat ø 42mm mounting distance 58mm 4 hole hole ø 4.4mm thickness 2.5mm model C9VV		

			
1			
<b>GEV No.</b>	696179	<b>Ref. No.</b>	MSC04N072Z
<b>description</b>	knife mounting pos. lower L 93mm seat ø 33mm mounting distance 46mm 4 hole hole ø 4.4mm thickness 2mm model C4-C6		
<b>For models:</b>	C9VV CE		

			
1			
<b>GEV No.</b>	696186	<b>Ref. No.</b>	MSC09V064Z
<b>description</b>	knife mounting pos. upper L 119mm seat ø 42mm mounting distance 58mm 4 hole hole ø 4.4mm thickness 2.5mm model C9VV		

			
1			
<b>GEV No.</b>	696178	<b>Ref. No.</b>	MSC04N064Z
<b>description</b>	knife mounting pos. upper L 98mm seat ø 42mm mounting distance 46mm 4 hole hole ø 4.4mm thickness 2mm model C4-C6		
<b>For models:</b>	C9VV CE		

blades smooth			
			
1			
<b>GEV No.</b>	696185	<b>Ref. No.</b>	MSC09V072
<b>description</b>	knife mounting pos. lower L 112mm seat ø 42mm mounting distance 58mm 4 hole hole ø 4.4mm thickness 2.5mm model C9VV		

			
1			
<b>GEV No.</b>	696166	<b>Ref. No.</b>	MSC15N072
<b>description</b>	knife mounting pos. lower L 128mm seat ø 48mm mounting distance 66mm 4 hole hole ø 5.5mm model C15		

			
1			
<b>GEV No.</b>	696177	<b>Ref. No.</b>	MSC04N072
<b>description</b>	knife mounting pos. lower L 93mm seat ø 33mm mounting distance 46mm 4 hole hole ø 4.4mm thickness 2mm model C4-C6		
<b>For models:</b>	C9VV CE		

			
1			
<b>GEV No.</b>	696184	<b>Ref. No.</b>	MSC09V064
<b>description</b>	knife mounting pos. upper L 119mm seat ø 42mm mounting distance 58mm 4 hole hole ø 4.4mm thickness 2.5mm model C9VV		

			
1			
<b>GEV No.</b>	696165	<b>Ref. No.</b>	MSC15N064
<b>description</b>	knife mounting pos. upper L 136mm seat ø 48mm mounting distance 66mm 4 hole hole ø 5.5mm model C15		

			
1			
<b>GEV No.</b>	696176	<b>Ref. No.</b>	MSC04N064
<b>description</b>	knife mounting pos. upper L 98mm seat ø 33mm mounting distance 46mm 4 hole hole ø 4.4mm thickness 2mm model C4-C6		
<b>For models:</b>	C9VV CE		

			
1			
<b>GEV No.</b>	696180	<b>Ref. No.</b>	MSC04N064V
<b>description</b>	knife mounting pos. upper L 98mm seat ø 33mm mounting distance 46mm 4 hole hole ø 4.4mm thickness 2mm model C4-C6		
<b>For models:</b>	C9VV CE		

			
1			
<b>GEV No.</b>	696181	<b>Ref. No.</b>	MSC04N064P
<b>description</b>	knife mounting pos. upper L 98mm seat ø 33mm mounting distance 46mm 4 hole hole ø 4.4mm thickness 2mm model C4-C6		
<b>For models:</b>	C9VV CE		

mixers



<b>GEV No.</b>	696183	<b>Ref. No.</b>	MSC09V072F
<b>description</b>	mixer mounting pos. lower L 112mm seat ø 42mm mounting distance 58mm 4 hole hole ø 4.4mm thickness 2.5mm model C9VV		



<b>GEV No.</b>	696182	<b>Ref. No.</b>	MSC09V064F
<b>description</b>	mixer mounting pos. upper L 119mm seat ø 42mm mounting distance 58mm 4 hole hole ø 4.4mm thickness 2.5mm model C9VV		



<b>GEV No.</b>	696174	<b>Ref. No.</b>	MSC04N064F
<b>description</b>	mixer mounting pos. upper L 98mm seat ø 33mm mounting distance 46mm 4 hole hole ø 4.4mm thickness 2mm model C4-C6		
<b>For models:</b>	C9VV CE		

blades with adaptor (complete)



<b>GEV No.</b>	696171	<b>Ref. No.</b>	MSC06AMON
<b>description</b>	knife complete ø 196mm H 157mm C6-C6VV		



<b>GEV No.</b>	696164	<b>Ref. No.</b>	MSC04AMON	
<b>description</b>	knife complete ø 196mm H 95mm C4-C4VV			
<b>spare parts for</b>	696164			
	<b>GEV No.</b>	696176	<b>Ref. No.</b>	MSC04N064
	<b>GEV No.</b>	696177	<b>Ref. No.</b>	MSC04N072



<b>GEV No.</b>	696169	<b>Ref. No.</b>	MSC09AMON
<b>description</b>	knife complete ø 238mm H 194mm C9VV		

protective coverings



<b>GEV No.</b>	696189	<b>Ref. No.</b>	MSC04N075
<b>description</b>	protective covering for cutter blade mounting pos. lower model C4-C6		
<b>For models:</b>	C9VV CE		



<b>GEV No.</b>	696188	<b>Ref. No.</b>	MSC04N073
<b>description</b>	protective covering for cutter blade mounting pos. upper model C4-C6		
<b>For models:</b>	C9VV CE		

miscellaneous



<b>GEV No.</b>	696190	<b>Ref. No.</b>	MSC04N174
<b>description</b>	grindstone for knife L 60mm W 25mm thickness 12mm with handle		
<b>For models:</b>	C9VV CE		



<b>GEV No.</b>	696378	<b>Ref. No.</b>	MSC04N028
<b>description</b>	guide for container plastic		
<b>For models:</b>	C9VV CE		





1

<b>GEV No.</b>	696191	<b>Ref. No.</b>	MSC04N200
<b>description</b>	scraper L 121mm W 82mm plastic		
<b>For models:</b>	C9VV CE		

for vegetable slicers

lids



1

<b>GEV No.</b>	696198	<b>Ref. No.</b>	IV2280010
<b>description</b>	lid for vegetable slicer stainless steel ø 220mm TM		
<b>For models:</b>	TV-TM INOX, TV-TM INOX07		

press levers



1

<b>GEV No.</b>	698186	<b>Ref. No.</b>	IV98407400
<b>description</b>	plunger ø 50mm H 140mm plastic TMA		
<b>For models:</b>	TV-TM INOX, TV-TM INOX07		



1

<b>GEV No.</b>	697900	<b>Ref. No.</b>	IV4010000
<b>description</b>	press lever L 180mm W 145mm H 140mm plastic TM		
<b>For models:</b>	TV-TM INOX, TV-TM INOX07		

holders



1

<b>GEV No.</b>	696100	<b>Ref. No.</b>	IV4010030
<b>description</b>	bracket for microswitch H 39mm L 65mm W 26mm TM		
<b>For models:</b>	TV-TM INOX, TV-TM INOX07		

ejector discs



1

<b>GEV No.</b>	697294	<b>Ref. No.</b>	40751DESP
<b>description</b>	ejector H 17mm seat ø 25mm hole distance 41mm TMA		
<b>For models:</b>	TV-TM INOX, TV-TM INOX07		

grating discs



1

<b>GEV No.</b>	697497	<b>Ref. No.</b>	40751DT02
<b>description</b>	grating disc type DT2 ø 205mm seat ø 19mm slicing thickness 2mm SS/aluminium		





1

<b>GEV No.</b>	697489	<b>Ref. No.</b>	40751DT03
<b>description</b>	grating disc type DT3 ø 205mm seat ø 19mm slicing thickness 3mm SS/aluminium		



			
1			
<b>GEV No.</b>	696167	<b>Ref. No.</b>	40751DT04
<b>description</b>	grating disc type DT4 ø 205mm seat ø 19mm slicing thickness 4mm SS/aluminium		

			
1			
<b>GEV No.</b>	697491	<b>Ref. No.</b>	40751DT07
<b>description</b>	grating disc type DT7 ø 205mm seat ø 19mm H 34.5mm slicing thickness 7mm SS/aluminium		

			
1			
<b>GEV No.</b>	697498	<b>Ref. No.</b>	40751DT09
<b>description</b>	grating disc type DT9 ø 205mm seat ø 19mm slicing thickness 9mm SS/aluminium		

			
1			
<b>GEV No.</b>	697496	<b>Ref. No.</b>	40751DTV
<b>description</b>	grating disc type DTV ø 205mm seat ø 19mm SS/aluminium		

## cutting discs

## blades smooth

## cutting discs

			
1			
<b>GEV No.</b>	697504	<b>Ref. No.</b>	40751DF01
<b>description</b>	slicing disk type DF1 ø 205mm seat ø 19mm slicing thickness 1mm aluminium		

			
1			
<b>GEV No.</b>	697502	<b>Ref. No.</b>	40751DF10
<b>description</b>	slicing disk type DF10 ø 205mm seat ø 19mm slicing thickness 10mm aluminium		

			
1			
<b>GEV No.</b>	697494	<b>Ref. No.</b>	40751DF14
<b>description</b>	slicing disk type DF14 ø 205mm seat ø 19mm slicing thickness 14mm aluminium		

			
1			
<b>GEV No.</b>	697302	<b>Ref. No.</b>	40751DF02
<b>description</b>	slicing disk type DF2 ø 205mm seat ø 19mm slicing thickness 2mm aluminium		

			
1			
<b>GEV No.</b>	697503	<b>Ref. No.</b>	40751DF03
<b>description</b>	slicing disk type DF3 ø 205mm seat ø 19mm slicing thickness 3mm aluminium		

			
1			
<b>GEV No.</b>	697485	<b>Ref. No.</b>	40751DF04
<b>description</b>	slicing disk type DF4 ø 205mm seat ø 19mm slicing thickness 4mm aluminium		

			
1			
<b>GEV No.</b>	697484	<b>Ref. No.</b>	40751DF08
<b>description</b>	slicing disk type DF8 ø 205mm seat ø 19mm slicing thickness 8mm aluminium		



## blades round



1

<b>GEV No.</b>	697303	<b>Ref. No.</b>	40751DF05
<b>description</b>	slicing disk type DF5 ø 205mm seat ø 19mm slicing thickness 5mm aluminium		

## stick slicing discs



1

<b>GEV No.</b>	697488	<b>Ref. No.</b>	40751DQ10
<b>description</b>	stick slicing disc type DQ10 ø 205mm seat ø 19mm slicing thickness 10mm aluminium		



1

<b>GEV No.</b>	697493	<b>Ref. No.</b>	40751DQ04
<b>description</b>	stick slicing disc type DQ4 ø 205mm seat ø 19mm slicing thickness 4mm aluminium		



1

<b>GEV No.</b>	697495	<b>Ref. No.</b>	40751DQ06
<b>description</b>	stick slicing disc type DQ6 ø 205mm seat ø 19mm slicing thickness 6mm aluminium		



1

<b>GEV No.</b>	697486	<b>Ref. No.</b>	40751DQ08
<b>description</b>	stick slicing disc type DQ8 ø 205mm seat ø 19mm slicing thickness 8mm aluminium		

## cubing grids



1

<b>GEV No.</b>	697490	<b>Ref. No.</b>	40751PS10
<b>description</b>	cubing grid type PS10 ø 210mm seat ø 38mm slicing thickness 10mm aluminium		



1

<b>GEV No.</b>	697499	<b>Ref. No.</b>	40751PS14
<b>description</b>	cubing grid type PS14 ø 210mm seat ø 38mm slicing thickness 14mm aluminium		



1

<b>GEV No.</b>	697501	<b>Ref. No.</b>	40751PS20
<b>description</b>	cubing grid type PS20 ø 210mm seat ø 38mm slicing thickness 20mm aluminium		



1

<b>GEV No.</b>	697487	<b>Ref. No.</b>	40751PS08
<b>description</b>	cubing grid type PS8 ø 210mm seat ø 38mm slicing thickness 8mm aluminium		

## spindles



1

<b>GEV No.</b>	696098	<b>Ref. No.</b>	IV2080050
<b>description</b>	spindle L1 18.5mm L2 10.5mm D1 ø 6mm D2 ø 5mm for microswitch total length 30.5mm TM		
<b>For models:</b>	TV-TM INOX, TV-TM INOX07		

## miscellaneous



1

<b>GEV No.</b>	696099	<b>Ref. No.</b>	IV75MTM
<b>description</b>	compression spring ø 7.2mm L 19mm wire gauge ø 0.7mm for micro-switch model TM		
<b>For models:</b>	TV-TM INOX, TV-TM INOX07		



1

<b>GEV No.</b>	110703	<b>Ref. No.</b>	IV4000800
<b>description</b>	cylindrical handle thread M10 ø 28mm L 87mm		
<b>For models:</b>	TCG12M		



1

<b>GEV No.</b>	696192	<b>Ref. No.</b>	IV7400010
<b>description</b>	latch mounting distance 15mm stainless steel TM		
<b>For models:</b>	TV-TM INOX, TV-TM INOX07		

## for cheese graters

### drive shafts



1

<b>GEV No.</b>	699621	<b>Ref. No.</b>	LF2032621
<b>description</b>	drive shaft model 12-22-32 ø 40/25/20mm L 97mm shaft diameter 15x40mm		



1

<b>GEV No.</b>	698124	<b>Ref. No.</b>	IB1903400
<b>description</b>	spindle ø 25mm L 350mm OLIMPO		
<b>For models:</b>	OLIMPO		

### lids



1

<b>GEV No.</b>	698017	<b>Ref. No.</b>	MF0367
<b>description</b>	lid model 12-22 ø 100mm plastic mounting distance 85mm		
<b>For models:</b>	GF, TCG12E, TCG22E		
<b>accessories for</b>	698017		



<b>GEV No.</b>	699592	<b>Ref. No.</b>	—
plug for lid ø 75mm plastic for meat mincer/cheese grater			



1

<b>GEV No.</b>	698010	<b>Ref. No.</b>	MF0002
<b>description</b>	lid model 8 ø 78mm plastic mounting distance 70mm		
<b>For models:</b>	GP		

### press levers



1

<b>GEV No.</b>	698012	<b>Ref. No.</b>	MF0140
<b>description</b>	press lever Mod.12		
<b>For models:</b>	GF, TCG12E, TCG22E		



1

<b>GEV No.</b>	698154	<b>Ref. No.</b>	IV1060405
<b>description</b>	press lever Mod.12		
<b>For models:</b>	TCG12M		



<b>GEV No.</b>	698236	<b>Ref. No.</b>	MF2162
<b>description</b>	press lever Mod.12-22		
<b>For models:</b>	TCG 22 E CE		



<b>GEV No.</b>	698127	<b>Ref. No.</b>	IB1263455
<b>description</b>	press lever OLIMPO		
<b>For models:</b>	OLIMPO		

rubbing cylinders

complete

<b>GEV No.</b>	698158	<b>Ref. No.</b>	IV2020520 LF2037035
<b>description</b>	grating cylinder ø 75mm L 140mm ID ø 14mm shaft ø 15mm stainless steel Mod.12		
<b>For models:</b>	TCG12M		

<b>GEV No.</b>	698014	<b>Ref. No.</b>	MF0150
<b>description</b>	grating cylinder ø 79mm L 155mm ID ø 25mm Mod.12-22		
<b>For models:</b>	GF, TCG12E, TCG22E		

<b>GEV No.</b>	698015	<b>Ref. No.</b>	MF0152 MF2158
<b>description</b>	grating cylinder ø 79mm L 155mm ID ø 25mm stainless steel Mod.12-22		
<b>For models:</b>	GF, TCG 22 E CE, TCG12E, TCG22E		

rubbing cylinders

<b>GEV No.</b>	698128	<b>Ref. No.</b>	IB2303460
<b>description</b>	grating cylinder ø 73mm L 137mm ID ø 69mm stainless steel OLIMPO		
<b>For models:</b>	OLIMPO		

<b>GEV No.</b>	698234	<b>Ref. No.</b>	MF2156
<b>description</b>	grating cylinder ø 79mm L 142.2mm ID ø 71mm Mod.12-22		
<b>For models:</b>	TCG 22 E CE		

side parts

<b>GEV No.</b>	698008	<b>Ref. No.</b>	MF0020
<b>description</b>	grating cylinder		
<b>For models:</b>	GP		

<b>GEV No.</b>	698009	<b>Ref. No.</b>	MF0061
<b>description</b>	grating cylinder		
<b>For models:</b>	GP		



1

<b>GEV No.</b>	698129	<b>Ref. No.</b>	IB1223460
<b>description</b>	side panel ID ø 25mm ED ø 69mm W 30mm aluminium OLIMPO		
<b>For models:</b>	OLIMPO		



1

<b>GEV No.</b>	698016	<b>Ref. No.</b>	MF0149 MF2155
<b>description</b>	side panel ID ø 25mm ED ø 71mm W 24mm aluminium Mod.12-22		
<b>For models:</b>	GF, TCG 22 E CE, TCG12E, TCG22E		

## grating cylinder housings



1

<b>GEV No.</b>	698013	<b>Ref. No.</b>	MF0147
<b>description</b>	housing aluminium Mod.12		
<b>For models:</b>	GF, TCG12E, TCG22E		

## pulleys



1

<b>GEV No.</b>	698125	<b>Ref. No.</b>	IB1023415
<b>description</b>	pulley disc ø 55mm disc width 40mm shaft intake ø 25mm overall width 55mm metal OLIMPO		
<b>For models:</b>	OLIMPO		

## gear wheels



1

<b>GEV No.</b>	698148	<b>Ref. No.</b>	IV2320500
<b>description</b>	auger ø 35.5mm shaft intake ø 17mm W 45mm for mincer Mod.12		
<b>For models:</b>	TC 12 MAGNUM INGRANAGGI CE, TC12M, TCG12M		



1

<b>GEV No.</b>	698028	<b>Ref. No.</b>	MF0110
<b>description</b>	gear wheel double ø 32/70mm shaft intake ø 15mm W 30mm teeth 18/41 splitting tooth width 14/11mm DIN/ISO Mod.12-22		
<b>For models:</b>	TCG12E, TCG22E		



1

<b>GEV No.</b>	698027	<b>Ref. No.</b>	MF0111
<b>description</b>	gear wheel ø 25mm shaft intake ø 10mm teeth 13 splitting tooth width 20mm DIN/ISO Mod.12-22		
<b>For models:</b>	TCG12E, TCG22E		



1

<b>GEV No.</b>	698149	<b>Ref. No.</b>	IV2330500
<b>description</b>	gear wheel ø 61mm shaft intake ø 17mm teeth 27 tooth width 20mm Mod.12		
<b>For models:</b>	TC 12 MAGNUM INGRANAGGI CE, TC12M, TCG12M		





1

<b>GEV No.</b>	698029	<b>Ref. No.</b>	MF0112
<b>description</b>	gear wheel ø 64mm shaft intake ø 16mm teeth 39 splitting tooth width 13mm DIN/ISO Mod.12-22		
<b>For models:</b>	TCG12E, TCG22E		



1

<b>GEV No.</b>	696097	<b>Ref. No.</b>	IB2183000
<b>description</b>	bracket L 94mm W 12mm mounting distance 50mm protection cap Athos		

miscellaneous



1

<b>GEV No.</b>	698011	<b>Ref. No.</b>	MF0293 MF2160
<b>description</b>	bolt for press lever ø 8mm L 60mm		
<b>For models:</b>	GP, TCG 22 E CE, TCG12E, TCG22E		



1

<b>GEV No.</b>	696193	<b>Ref. No.</b>	4IV9840530B IB4023000A
<b>description</b>	protection cap ø 188mm H 51mm mounting distance 95mm plastic white Athos		



1

<b>GEV No.</b>	110703	<b>Ref. No.</b>	IV4000800
<b>description</b>	cylindrical handle thread M10 ø 28mm L 87mm		
<b>For models:</b>	TCG12M		

for potato peelers

drive shafts



1

<b>GEV No.</b>	696829	<b>Ref. No.</b>	IV2080600	
<b>description</b>	drive shaft lower for potato peeler device ø 28/59/16mm L 177mm			
<b>accessories for</b>	696829			
	<b>GEV No.</b>	692006	<b>Ref. No.</b>	IV76C5X5X20
	slot nut W 5mm H 5mm L 20mm			

for mozzarella slicers

accessories



1

<b>GEV No.</b>	696197	<b>Ref. No.</b>	IB1263050
<b>description</b>	body for mozzarella cutter ø 180mm ID ø 42mm aluminium Athos		



1

<b>GEV No.</b>	696054	<b>Ref. No.</b>	RG04270
<b>description</b>	shaft set with gasket and ball bearing potato peeler PP4 Expo shaft 25x14mm		



1

<b>GEV No.</b>	696055	<b>Ref. No.</b>	RG08270
<b>description</b>	shaft set with gasket and ball bearing potato peeler PP8-PP15 Expo shaft 28x14mm		
<b>For models:</b>	PP EXPO 4 CE, PP EXPO 8 CE		



1

<b>GEV No.</b>	696708	<b>Ref. No.</b>	IV77C7X8X15
<b>description</b>	slot nut for drive shaft L 14mm PPJ/LCJ		

### lids



1

<b>GEV No.</b>	696199	<b>Ref. No.</b>	RG04002
<b>description</b>	lid potato peeler ø 310mm ID ø 280mm plastic mounting distance 59mm PP4-PP8-PP15 Expo		
<b>For models:</b>	PP EXPO 4 CE, PP EXPO 8 CE		

### abrasive side elements

#### inserts



1

<b>GEV No.</b>	696202	<b>Ref. No.</b>	RG04016
<b>description</b>	abrasive band potato peeler ø 300mm L 205mm mounting distance 120mm PP4 Expo		



1

<b>GEV No.</b>	696203	<b>Ref. No.</b>	RG08016
<b>description</b>	abrasive band potato peeler ø 300mm L 270mm mounting distance 160mm PP8 Expo		
<b>For models:</b>	PP EXPO 4 CE, PP EXPO 8 CE		



1

<b>GEV No.</b>	696828	<b>Ref. No.</b>	IV2426695 IV2466695
<b>description</b>	abrasive band potato peeler ø 330mm L 280mm mounting distance 230mm PPJ 20		

### grinding discs



1

<b>GEV No.</b>	696201	<b>Ref. No.</b>	RG04025 RG04026
<b>description</b>	grating disc ø 280mm potato peeler PP4-PP8 Expo		
<b>For models:</b>	PP EXPO 4 CE, PP EXPO 8 CE		



1

<b>GEV No.</b>	696377	<b>Ref. No.</b>	RG15025
<b>description</b>	grating disc ø 350mm for potato peeler device		

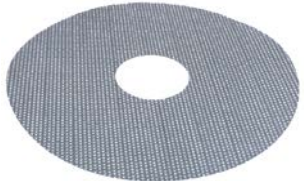

1

<b>GEV No.</b>	696346	<b>Ref. No.</b>	IV2426600
<b>description</b>	grating disc ø 390mm for potato peeler device		



1

<b>GEV No.</b>	696376	<b>Ref. No.</b>	RGE04110
<b>description</b>	grinding disc ø 280mm for potato peeler device PP4 ECO shaft 28x14		

pulleys



1

<b>GEV No.</b>	696047	<b>Ref. No.</b>	RG08268
<b>description</b>	pulley disc ø 116mm disc width 33mm shaft intake ø 16mm overall width 33mm type flat metal for potato peeler device		
<b>For models:</b>	PP EXPO 4 CE, PP EXPO 8 CE		

miscellaneous



1

<b>GEV No.</b>	696760	<b>Ref. No.</b>	RG04246
<b>description</b>	plate for motor stainless steel		



1

<b>GEV No.</b>	696046	<b>Ref. No.</b>	RG04268
<b>description</b>	pulley disc ø 116mm disc width 25mm shaft intake ø 16mm overall width 25mm type flat metal for potato peeler device		



1

<b>GEV No.</b>	696044	<b>Ref. No.</b>	RG04250
<b>description</b>	V-ripped belt pulley grooves 8 disc ø 25mm shaft intake ø 10mm disc width 28mm groove depth 2mm groove width 2mm overall width 28mm type TB2.34		

door mechanics

door seals

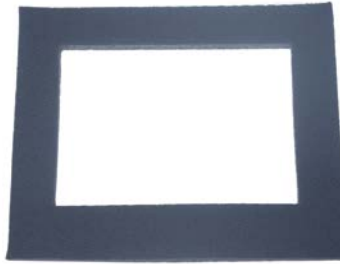

1

<b>GEV No.</b>	696168	<b>Ref. No.</b>	RG04154
<b>description</b>	door seal L 143mm W 120mm thickness 4mm internal size 104x75mm PP4 Expo		



1

<b>GEV No.</b>	696051	<b>Ref. No.</b>	RG08052 RG15052
<b>description</b>	door seal L 170mm W 135mm thickness 8mm internal size 90x115mm PP8 Expo		
<b>For models:</b>	PP EXPO 4 CE, PP EXPO 8 CE		

doors



1

<b>GEV No.</b>	696052	<b>Ref. No.</b>	RG04136
<b>description</b>	door W 135mm H 115mm with gasket PP4 Expo		



1

<b>GEV No.</b>	696049	<b>Ref. No.</b>	RG08050 RG08050+RG08052
<b>description</b>	door W 164mm H 150mm with gasket PP8-PP15 Expo		
<b>For models:</b>	PP EXPO 4 CE, PP EXPO 8 CE		

## miscellaneous



1

<b>GEV No.</b>	696045	<b>Ref. No.</b>	RG08038
<b>description</b>	bolt L 59mm SS $\varnothing$ 7mm		
<b>For models:</b>	PP EXPO 4 CE, PP EXPO 8 CE		



1

<b>GEV No.</b>	696048	<b>Ref. No.</b>	RG08040
<b>description</b>	handle L 180mm W 118mm H 50mm aluminium PP8-PP15 Expo		
<b>For models:</b>	PP EXPO 4 CE, PP EXPO 8 CE		



1

<b>GEV No.</b>	696053	<b>Ref. No.</b>	RG04138
<b>description</b>	handle L 180mm W 20mm thickness 6mm SS PP4 Expo		



1

<b>GEV No.</b>	696292	<b>Ref. No.</b>	RG08046	
<b>description</b>	joint L 42mm W 16mm H 16mm IT M8 hole $\varnothing$ 8mm U-shape for door PP8-PP15 Expo			
<b>For models:</b>	PP EXPO 4 CE, PP EXPO 8 CE			
<b>accessories for</b>	696292			
	<b>GEV No.</b>	696293	<b>Ref. No.</b>	RG08048
	joint L 70mm W 20mm thickness 8mm thread M8 thread L 20mm hole $\varnothing$ 8.3mm plate for door PP8-PP15 Expo			



1

<b>GEV No.</b>	696293	<b>Ref. No.</b>	RG08048
<b>description</b>	joint L 70mm W 20mm thickness 8mm thread M8 thread L 20mm hole $\varnothing$ 8.3mm plate for door PP8-PP15 Expo		
<b>For models:</b>	PP EXPO 4 CE, PP EXPO 8 CE		

**accessories for** 696293

	<b>GEV No.</b>	696292	<b>Ref. No.</b>	RG08046
	joint L 42mm W 16mm H 16mm IT M8 hole $\varnothing$ 8mm U-shape for door PP8-PP15 Expo			

1

<b>GEV No.</b>	346891	<b>Ref. No.</b>	RG08054
<b>description</b>	magnet $\varnothing$ 6mm L 25mm		
<b>For models:</b>	PP EXPO 4 CE, PP EXPO 8 CE		

## for dough mixers

## agitators



1

<b>GEV No.</b>	698573	<b>Ref. No.</b>	CINP7-11-03 CINP7-40102800
<b>description</b>	whisk $\varnothing$ 125mm L 190mm hole $\varnothing$ 12mm		

## for bar blender

## blenders

## jar components

## jars



1

<b>GEV No.</b>	696081	<b>Ref. No.</b>	IB4050800
<b>description</b>	blender jar plastic 1500ml for mixer Dragone		
<b>For models:</b>	DRAGONE CE		



1

<b>GEV No.</b>	696082	<b>Ref. No.</b>	IB4050900
<b>description</b>	blender jar plastic 2000ml for mixer Orione		
<b>For models:</b>	ORIONE CE		



1

<b>GEV No.</b>	696083	<b>Ref. No.</b>	IB2260900A
<b>description</b>	blender jar stainless steel 2000ml for mixer Orione		
<b>For models:</b>	ORIONE CE		

complete



1

<b>GEV No.</b>	696084	<b>Ref. No.</b>	IB9865520
<b>description</b>	blender jar plastic 1500ml complete for mixer Dragone		
<b>For models:</b>	DRAGONE CE		



1

<b>GEV No.</b>	696085	<b>Ref. No.</b>	IB9865521
<b>description</b>	blender jar plastic 1500ml for mixing complete for mixer Dragone		
<b>For models:</b>	DRAGONE CE		





1

<b>GEV No.</b>	696087	<b>Ref. No.</b>	IB9865320.04 IB9865341.05
<b>description</b>	blender jar plastic 2000ml complete for mixer Orione		
<b>For models:</b>	ORIONE CE		



1

<b>GEV No.</b>	696089	<b>Ref. No.</b>	IB9865323.06
<b>description</b>	blender jar stainless steel 2000ml complete for mixer Orione		
<b>For models:</b>	ORIONE CE		



1

<b>GEV No.</b>	696086	<b>Ref. No.</b>	IB9865321.05
<b>description</b>	blender jar plastic 2000ml for mixing complete for mixer Orione		
<b>For models:</b>	ORIONE CE		



1

<b>GEV No.</b>	696088	<b>Ref. No.</b>	IB9865324.04
<b>description</b>	blender jar stainless steel 2000ml for mixing complete for mixer Orione		
<b>For models:</b>	ORIONE CE		

lids



1

<b>GEV No.</b>	696072	<b>Ref. No.</b>	IB4000820
<b>description</b>	lid ø 148mm plastic nominal-ø 120mm hole ø 48mm Dragone		
<b>For models:</b>	DRAGONE CE		



1

<b>GEV No.</b>	696073	<b>Ref. No.</b>	IB4100920
<b>description</b>	lid ø 156mm rubber nominal-ø 136mm hole ø 48mm Orione		
<b>For models:</b>	ORIONE CE		



1

<b>GEV No.</b>	696070	<b>Ref. No.</b>	IB4050905
<b>description</b>	lid lock ø 48mm H 50mm plastic		
<b>For models:</b>	DRAGONE CE, ORIONE CE		

**gaskets**



1

<b>GEV No.</b>	696076	<b>Ref. No.</b>	IB4100915
<b>description</b>	gasket silicone ED ø 68mm ID ø 48mm thickness 2mm Qty 1 pcs		
<b>For models:</b>	ORIONE CE		



1

<b>GEV No.</b>	696071	<b>Ref. No.</b>	IB4104040
<b>description</b>	O-ring EPDM thickness 3.53mm ID ø 52.39mm Qty 1 pcs		
<b>For models:</b>	ORIONE CE		



1

<b>GEV No.</b>	696075	<b>Ref. No.</b>	IB4104031
<b>description</b>	V-ring ID ø 8mm thickness 5mm		
<b>For models:</b>	DRAGONE CE		

**holders**



1

<b>GEV No.</b>	696080	<b>Ref. No.</b>	IB4010910
<b>description</b>	bracket for jar ø 121mm nominal-ø 100mm hole ø 49mm plastic Orione		
<b>For models:</b>	ORIONE CE		

**blades**

**spare blades**



1

<b>GEV No.</b>	696065	<b>Ref. No.</b>	IB2680900 IB2680901
<b>description</b>	knife W 73mm H 47mm hole ø 6x8mm Orione		
<b>For models:</b>	ORIONE CE		

**couplings**



1

<b>GEV No.</b>	696061	<b>Ref. No.</b>	IB2000801
<b>description</b>	coupling ø 20mm H 10mm stainless steel Dragone		
<b>For models:</b>	DRAGONE CE		



1

<b>GEV No.</b>	696062	<b>Ref. No.</b>	IB2000901
<b>description</b>	coupling ø 25mm H 17mm IT M5L stainless steel Orione		
<b>For models:</b>	ORIONE CE		



1

<b>GEV No.</b>	696063	<b>Ref. No.</b>	IB2000903
<b>description</b>	coupling ø 28mm H 17mm IT M5L stainless steel Orione		
<b>For models:</b>	ORIONE CE		

blades with adaptor (complete)



1

<b>GEV No.</b>	696074	<b>Ref. No.</b>	IB9865335.05
<b>description</b>	slicing unit plastic jar stainless steel Orione		
<b>For models:</b>	ORIONE CE		



1

<b>GEV No.</b>	696077	<b>Ref. No.</b>	IB9865336.06
<b>description</b>	slicing unit stainless steel jar ø 70mm stainless steel Orione		
<b>For models:</b>	ORIONE CE		

mixer discs



1

<b>GEV No.</b>	696060	<b>Ref. No.</b>	IB2100933
<b>description</b>	mixer disc ø 50mm hole ø 10mm H 6.5mm aluminium Orione		
<b>For models:</b>	ORIONE CE		



1

<b>GEV No.</b>	696290	<b>Ref. No.</b>	IB2100932
<b>description</b>	mixer disc ø 50mm hole ø 27mm H 8mm aluminium Orione		
<b>For models:</b>	ORIONE CE		

mixer discs (complete)



1

<b>GEV No.</b>	696057	<b>Ref. No.</b>	IB9865322.05
<b>description</b>	mixer disc complete plastic jar ø 70mm stainless steel Orione		
<b>For models:</b>	ORIONE CE		



1

<b>GEV No.</b>	696056	<b>Ref. No.</b>	IB98653220.04
<b>description</b>	mixer disc complete stainless steel jar ø 70mm stainless steel Orione		
<b>For models:</b>	ORIONE CE		

spindles



1

<b>GEV No.</b>	696291	<b>Ref. No.</b>	IB2100931
<b>description</b>	spindle ø 10mm L 60mm IT M5L Orione		
<b>For models:</b>	ORIONE CE		





1

<b>GEV No.</b>	696058	<b>Ref. No.</b>	IB2000902
<b>description</b>	spindle ø 10mm L 76.5mm D1 ø 23.5mm ID ø 21.5mm IT M5L aluminium Orione		
<b>For models:</b>	ORIONE CE		

			
1			
<b>GEV No.</b>	695169	<b>Ref. No.</b>	IB2000806
<b>description</b>	spindle ø 8mm L 53mm T1: M5L T2: M6L steel Dragone		
<b>For models:</b>	DRAGONE CE		

miscellaneous

			
1			
<b>GEV No.</b>	695119	<b>Ref. No.</b>	IB2000910
<b>description</b>	cap nuts thread M5L WS 10 SS Qty 1 pcs		
<b>For models:</b>	DRAGONE CE, ORIONE CE		

			
1			
<b>GEV No.</b>	696064	<b>Ref. No.</b>	IB2000915
<b>description</b>	screw ø 10mm L 13.6mm thread M4		
<b>For models:</b>	ORIONE CE		

			
1			
<b>GEV No.</b>	696059	<b>Ref. No.</b>	IB2000926
<b>description</b>	union nut ø 70mm ID ø 46.8mm H 10.5mm stainless steel		
<b>For models:</b>	ORIONE CE		

holders

			
1			
<b>GEV No.</b>	696079	<b>Ref. No.</b>	IB4000810
<b>description</b>	bracket for jar ø 116mm int. ø 1 24mm int. ø 2 79mm Dragone		
<b>For models:</b>	DRAGONE CE		

			
1			
<b>GEV No.</b>	696078	<b>Ref. No.</b>	IB4010900
<b>description</b>	bracket for jar ø 129mm int. ø 1 16mm int. ø 2 100mm Orione		
<b>For models:</b>	ORIONE CE		

actuators

group 1

			
1			
<b>GEV No.</b>	698203	<b>Ref. No.</b>	IB4100905
<b>description</b>	mixer coupling for jar ø 36mm H 14mm IT M6L teeth 6 rubber Dragone		
<b>For models:</b>	DRAGONE CE, ORIONE CE		

			
1			
<b>GEV No.</b>	698202	<b>Ref. No.</b>	IB4000815
<b>description</b>	mixer coupling for motor ø 36mm H 14mm IT M6L teeth 6 plastic Dragone		
<b>For models:</b>	DRAGONE CE		

			
1			
<b>GEV No.</b>	696069	<b>Ref. No.</b>	IB4100900
<b>description</b>	mixer coupling motor ø 36mm H 14mm IT M8L teeth 6 plastic Orione		
<b>For models:</b>	ORIONE CE		

group 2

			
1			
<b>GEV No.</b>	651061	<b>Ref. No.</b>	IB4000816
<b>description</b>	mixer coupling ø 26mm H 10mm teeth 4 rubber		

## mixers

## jars



1

<b>GEV No.</b>	698318	<b>Ref. No.</b>	IB4050100
<b>description</b>	blender jar plastic ø 105mm H 150mm		
<b>For models:</b>	SIRIO 1 GDO CE, SIRIO 2 GDO CE		



1

<b>GEV No.</b>	698564	<b>Ref. No.</b>	65010100
<b>description</b>	blender jar SS ø 104mm H 150mm DMB / DMB20		
<b>For models:</b>	SIRIO 1 GDO CE, SIRIO 2 GDO CE		

## holders



1

<b>GEV No.</b>	650100	<b>Ref. No.</b>	IB4000130 IB9866020
<b>description</b>	bracket with microswitch for jar W 62mm H 60mm		
<b>For models:</b>	SIRIO 1 GDO CE, SIRIO 2 GDO CE		

## mixer discs



1

<b>GEV No.</b>	696091	<b>Ref. No.</b>	IB2100110
<b>description</b>	knife drink mixer ø 26mm IT M5 H 19mm Sirio		
<b>For models:</b>	SIRIO 1 GDO CE, SIRIO 2 GDO CE		



1

<b>GEV No.</b>	696066	<b>Ref. No.</b>	IB2200100
<b>description</b>	mixer disc drink mixer ø 25mm ID ø 5mm Sirio		
<b>For models:</b>	SIRIO 1 GDO CE, SIRIO 2 GDO CE		

## accessories



1

<b>GEV No.</b>	696093	<b>Ref. No.</b>	IB2100100
<b>description</b>	spacer bush ø 8mm ID ø 5.3mm H 14mm Sirio		
<b>For models:</b>	SIRIO 1 GDO CE, SIRIO 2 GDO CE		

## for hand blenders

## drive shafts



1

<b>GEV No.</b>	523074	<b>Ref. No.</b>	CINP01-24 CINP7-09-02 CINP7-40101200
<b>description</b>	gear wheel teeth 18 shaft intake ø 12mm ø 30mm tooth width 2.75mm hub ø 4mm plastic W 11mm		





spare parts and accessories



1

<b>GEV No.</b>	696706	<b>Ref. No.</b>	IB4080110
<b>description</b>	cover ø 110mm H 135mm Sirio		

couplings



1

<b>GEV No.</b>	651031	<b>Ref. No.</b>	IB4004046
<b>description</b>	coupling D1 ø 12mm D2 ø 23mm int. ø 1 8mm thread M6L L 45mm teeth 4 CICLONE		
<b>For models:</b>	CICLONE ASTA 25cm 0,15/0,23kW, CICLONE ASTA 35cm 0,15/0,23kW		



1

<b>GEV No.</b>	651030	<b>Ref. No.</b>	IB4004045
<b>description</b>	coupling D1 ø 12mm D2 ø 24mm thread M8L L 35mm teeth 8 VORTEX edition until year of construction 09/2004		
<b>For models:</b>	VORTEX 43, VORTEX 55, VORTEX 75, VORTEX ASTA 30cm 0,43/0,55/0,75kW, VORTEX ASTA 40cm 0,43/0,55/0,75kW		



1

<b>GEV No.</b>	651027	<b>Ref. No.</b>	IB4004043.04
<b>description</b>	coupling D1 ø 18mm D2 ø 21mm int. ø 1 12mm thread M8L L 36mm teeth 8 VORTEX edition since year of construction 10/2004		
<b>For models:</b>	VORTEX 43, VORTEX 55, VORTEX 75		



1

<b>GEV No.</b>	651032	<b>Ref. No.</b>	IB4004048
<b>description</b>	coupling D1 ø 18mm D2 ø 21mm int. ø 1 8mm thread M6L L 36mm teeth 4 CICLONE		
<b>For models:</b>	CICLONE 15VV CE, CICLONE 23 CE		



1

<b>GEV No.</b>	651022	<b>Ref. No.</b>	IB4004045.04
<b>description</b>	coupling tooth 8 ø 24mm H 45mm VORTEX edition since year of construction 10/2004		
<b>For models:</b>	VORTEX 43, VORTEX 55, VORTEX 75, VORTEX ASTA 30cm 0,43/0,55/0,75kW, VORTEX ASTA 40cm 0,43/0,55/0,75kW		

blender sticks

bushes



1

<b>GEV No.</b>	651021	<b>Ref. No.</b>	IB2104020
<b>description</b>	bush ø 11mm ID ø 8mm L 10.3mm		
<b>For models:</b>	VORTEX 43, VORTEX 55, VORTEX 75, VORTEX ASTA 30cm 0,43/0,55/0,75kW, VORTEX ASTA 40cm 0,43/0,55/0,75kW		

gaskets



1

<b>GEV No.</b>	651023	<b>Ref. No.</b>	IB4104005
<b>description</b>	gasket mixer bowl ED ø 46mm ID ø 32mm CICLONE/VORTEX		
<b>For models:</b>	CICLONE ASTA 25cm 0,15/0,23kW, CICLONE ASTA 35cm 0,15/0,23kW, VORTEX 43, VORTEX 55, VORTEX 75, VORTEX ASTA 30cm 0,43/0,55/0,75kW, VORTEX ASTA 40cm 0,43/0,55/0,75kW		



1

<b>GEV No.</b>	651056	<b>Ref. No.</b>	IB4104015
<b>description</b>	sealing ring ED ø 16mm ID ø 8mm CICLONE		

bearing blocks



1

<b>GEV No.</b>	651024	<b>Ref. No.</b>	IB9866003
<b>description</b>	bearing block with gasket and ball bearing mounting pos. lower ø 49.5mm ID ø 24mm H 31.5mm VORTEX		
<b>For models:</b>	VORTEX 43, VORTEX 55, VORTEX 75, VORTEX ASTA 30cm 0,43/0,55/0,75kW, VORTEX ASTA 40cm 0,43/0,55/0,75kW		

## blades

## spare blades



1

<b>GEV No.</b>	651034	<b>Ref. No.</b>	IB2680401
<b>description</b>	knife hole $\varnothing$ 6x5mm CICLEONE		
<b>For models:</b>	CICLEONE ASTA 25cm 0,15/0,23kW, CICLEONE ASTA 35cm 0,15/0,23kW		



1

<b>GEV No.</b>	651033	<b>Ref. No.</b>	IB2680400
<b>description</b>	knife hole $\varnothing$ 6x8mm VORTEX		
<b>For models:</b>	VORTEX 43, VORTEX 55, VORTEX 75, VORTEX ASTA 30cm 0,43/0,55/0,75kW, VORTEX ASTA 40cm 0,43/0,55/0,75kW		

## blades with adaptor (complete)



1

<b>GEV No.</b>	651025	<b>Ref. No.</b>	IB9866004
<b>description</b>	knife with spindle $\varnothing$ 60mm hole $\varnothing$ 8mm H 40mm VORTEX		
<b>For models:</b>	VORTEX 43, VORTEX 55, VORTEX 75, VORTEX ASTA 30cm 0,43/0,55/0,75kW, VORTEX ASTA 40cm 0,43/0,55/0,75kW		
<b>spare parts for</b>	651025		
	<b>GEV No.</b>	651033	<b>Ref. No.</b> IB2680400
	knife hole $\varnothing$ 6x8mm VORTEX		

## accessories



1

<b>GEV No.</b>	651035	<b>Ref. No.</b>	IB1980406
<b>description</b>	blade holder CICLEONE		
<b>For models:</b>	CICLEONE ASTA 25cm 0,15/0,23kW, CICLEONE ASTA 35cm 0,15/0,23kW		



1

<b>GEV No.</b>	651036	<b>Ref. No.</b>	IB1980407
<b>description</b>	screw for knife thread M4L CICLEONE		
<b>For models:</b>	CICLEONE ASTA 25cm 0,15/0,23kW, CICLEONE ASTA 35cm 0,15/0,23kW		

## blender sticks



1

<b>GEV No.</b>	698238	<b>Ref. No.</b>	66204500
<b>description</b>	blender stick L 450mm complete		

## spindles



1

<b>GEV No.</b>	698364	<b>Ref. No.</b>	IB2104004
<b>description</b>	drive shaft for hand blender D1 $\varnothing$ 18mm D2 $\varnothing$ 8mm L 430mm		
<b>For models:</b>	VORTEX 43, VORTEX 55, VORTEX 75, VORTEX ASTA 30cm 0,43/0,55/0,75kW, VORTEX ASTA 40cm 0,43/0,55/0,75kW		

## beaters

## beaters



1

<b>GEV No.</b>	698573	<b>Ref. No.</b>	CINP7-11-03 CINP7-40102800
<b>description</b>	whisk $\varnothing$ 125mm L 190mm hole $\varnothing$ 12mm		

## miscellaneous



1

<b>GEV No.</b>	550963	<b>Ref. No.</b>	IB5894000
<b>description</b>	bend relief ID $\varnothing$ 7mm		
<b>For models:</b>	CICLEONE 15VV CE, CICLEONE 23 CE, VORTEX 43, VORTEX 55, VORTEX 75		



1

<b>GEV No.</b>	346961	<b>Ref. No.</b>	IB4004042
<b>description</b>	push button $\varnothing$ 10mm L 62mm VORTEX		
<b>For models:</b>	VORTEX 43, VORTEX 55, VORTEX 75		



1

<b>GEV No.</b>	346954	<b>Ref. No.</b>	IB4004047
<b>description</b>	push button ø 10mm L 72mm CICLONE		
<b>For models:</b>	CICLONE 15VV CE, CICLONE 23 CE		



1

<b>GEV No.</b>	651026	<b>Ref. No.</b>	IB9866010
<b>description</b>	tool kit		

juicer insert



1

<b>GEV No.</b>	960107	<b>Ref. No.</b>	IB4000720
<b>description</b>	juicer insert		
<b>For models:</b>	APOLLO CE		



1

<b>GEV No.</b>	650261	<b>Ref. No.</b>	IB4000730
<b>description</b>	juicer insert H 60mm plastic		

for citrus juicers

spillage trays



1

<b>GEV No.</b>	696092	<b>Ref. No.</b>	IB2260700
<b>description</b>	tray ø 170mm hole ø 31mm H 74mm stainless steel model APOLLO		
<b>For models:</b>	APOLLO CE		

gaskets



1

<b>GEV No.</b>	696067	<b>Ref. No.</b>	IB4180700
<b>description</b>	gasket ø 26mm ID ø 11mm H 12mm for citrus juicers		
<b>For models:</b>	APOLLO CE		



1

<b>GEV No.</b>	696068	<b>Ref. No.</b>	IB4100110
<b>description</b>	gasket ø 85mm H 18mm drink mixer hole distance 55x75mm model Sirio		
<b>For models:</b>	SIRIO 1 GDO CE, SIRIO 2 GDO CE		

spindles



1

<b>GEV No.</b>	696090	<b>Ref. No.</b>	IB2080700
<b>description</b>	spindle L 66.5mm model APOLLO WS 14 IT M8L		
<b>For models:</b>	APOLLO CE		



1

<b>GEV No.</b>	696095	<b>Ref. No.</b>	IB2080710
<b>description</b>	spindle ø 8mm L 85mm motor model Sirio suitable for flange		
<b>For models:</b>	APOLLO CE		

miscellaneous



1

<b>GEV No.</b>	523000	<b>Ref. No.</b>	IB7300700
<b>description</b>	thrust ball bearing shaft ø 12mm ED ø 26mm W 9mm type 51101 DIN 711		
<b>For models:</b>	APOLLO CE		

for ice crusher

handles



1

<b>GEV No.</b>	696096	<b>Ref. No.</b>	IB2080712
<b>description</b>	handle rod L 160mm ø 10mm T1: M8 T2: M10		
<b>For models:</b>	TRITON CE		

## V-belts



1

<b>GEV No.</b>	698222	<b>Ref. No.</b>	IB7003012
<b>description</b>	poly-v belt grooves 6 W 12mm L 526mm profile TB2		
<b>For models:</b>	TRITON CE		

## bodies



1

<b>GEV No.</b>	696196	<b>Ref. No.</b>	IB1273460
<b>description</b>	body ice crusher ID ø 98.5mm L 210mm aluminium		
<b>For models:</b>	TRITON CE		

## for cup coffee machines

## lids



1

<b>GEV No.</b>	696193	<b>Ref. No.</b>	4IV9840530B IB4023000A
<b>description</b>	protection cap ø 188mm H 51mm mounting distance 95mm plastic white Athos		

## miscellaneous



1

<b>GEV No.</b>	697300	<b>Ref. No.</b>	IB77DG12
<b>description</b>	wing nuts thread M12 SS Qty 1 pcs		

## for crepes makers

## cast plates



1

<b>GEV No.</b>	691259	<b>Ref. No.</b>	IGS701213
<b>description</b>	cast plate ø 350mm		
<b>For models:</b>	CREPIERA TONDA		



1

<b>GEV No.</b>	691260	<b>Ref. No.</b>	IGS701233
<b>description</b>	cast plate ø 350mm		
<b>For models:</b>	CREPIERA TONDA		

## for hot dog machines

## lids



1

<b>GEV No.</b>	693098	<b>Ref. No.</b>	ATHD058502
<b>description</b>	lid		

## glass cylinders



1



<b>GEV No.</b>	693845	<b>Ref. No.</b>	BICCHIERE HOT DOG Y06 GM3556300
<b>description</b>	glass cylinder for hot dog machine ø 170mm H 270mm 5l Y06		

			
1			
<b>GEV No.</b>	693002	<b>Ref. No.</b>	ATHD066006
<b>description</b>	glass cylinder ø 200mm Pyrex glass H 240mm		

skewers			
			
1			
<b>GEV No.</b>	693094	<b>Ref. No.</b>	ATHD055804
<b>description</b>	bun spikes		

for tilting bratt pans			
miscellaneous			
			
1			
<b>GEV No.</b>	523510	<b>Ref. No.</b>	19320201 MF0005
<b>description</b>	deep-groove ball bearing type 6202-2RS shaft ø 15mm ED ø 35mm W 11mm with sealing discs deep-groove ball bearing DIN 625-1		
<b>For models:</b>	GP, TCG12M		

for panini grill			
cast plates			
			
1			
<b>GEV No.</b>	693933	<b>Ref. No.</b>	IGS200PL
<b>description</b>	cast plate smooth mounting pos. lower		

for microwaves			
housings			
inner parts			
			
1			
<b>GEV No.</b>	691046	<b>Ref. No.</b>	PA20113030GP
<b>description</b>	roof liner L 483mm W 248mm for microwave		
<b>accessories for</b>	691046		
		<b>GEV No.</b>	692572
		<b>Ref. No.</b>	PANE9082930AP
	mounting clip ø 8mm suitable for microwave		

miscellaneous			
			
1			
<b>GEV No.</b>	692572	<b>Ref. No.</b>	PANE9082930AP
<b>description</b>	mounting clip ø 8mm suitable for microwave		

for ovens			
housing and bezels			
			
1			
<b>GEV No.</b>	651029	<b>Ref. No.</b>	IGS600PU
<b>description</b>	insulation L 200mm W 185mm thickness 4mm		

for pizza ovens			
springs			
			
1			
<b>GEV No.</b>	694861	<b>Ref. No.</b>	IGS809053
<b>description</b>	torsion spring ø 20mm L2 11mm wire gauge ø 3mm L1 30mm L3 40mm Qty 1 pcs		

for sterilisers			
			
1			
<b>GEV No.</b>	694563	<b>Ref. No.</b>	IV4236016
<b>description</b>	blade holder for steriliser L 348mm W 116mm H 36mm transparent plexiglas		



## for toasters

pliers

pliers



1

<b>GEV No.</b>	690010	<b>Ref. No.</b>	IGS184
<b>description</b>	plier for toaster H 180mm total length 100mm		
<b>For models:</b>	12Q, 4Q, 6Q		

## for vacuum packers

PTFE tapes



1

<b>GEV No.</b>	692674	<b>Ref. No.</b>	IW1471250030
<b>description</b>	PTFE tape W 80mm thickness 0.5mm Qty 1		

## sealing bars



1

<b>GEV No.</b>	698069	<b>Ref. No.</b>	KODK012
<b>description</b>	sealing bar L 460mm W 25mm H 70mm		

## heating wires



1

<b>GEV No.</b>	418506	<b>Ref. No.</b>	KODK001
<b>description</b>	heating wire L 454mm Qty 1		

## for heated display cases

glass panels



1

<b>GEV No.</b>	700899	<b>Ref. No.</b>	PA31463030GP
<b>description</b>	glass panel L 488mm W 202mm thickness 3.5mm mounting pos. outer		

## miscellaneous



1

<b>GEV No.</b>	691105	<b>Ref. No.</b>	IB1926000
<b>description</b>	coupling for pizza display		
<b>For models:</b>	VETRINETTA 38		



1

<b>GEV No.</b>	691106	<b>Ref. No.</b>	IB7506000
<b>description</b>	door hinge kit for glass door mounting pos. upper/lower		
<b>For models:</b>	VETRINETTA 38		



for sausage fillers

funnels



1

<b>GEV No.</b>	698366	<b>Ref. No.</b>	LF2011015A
<b>description</b>	funnel ø 10mm L 190mm polyethylene		



1

<b>GEV No.</b>	698367	<b>Ref. No.</b>	LF2011015B
<b>description</b>	funnel ø 18mm L 190mm polyethylene		



1

<b>GEV No.</b>	698368	<b>Ref. No.</b>	LF2011015C
<b>description</b>	funnel ø 25mm L 180mm polyethylene		



1

<b>GEV No.</b>	698365	<b>Ref. No.</b>	LF2011015 LF2011015 A/B/C
<b>description</b>	funnel set ø 10/18/25mm L 190mm polyethylene seat ø 58mm		

pistons

accessories



1

<b>GEV No.</b>	696579	<b>Ref. No.</b>	LF2011012
<b>description</b>	aerator and air bleeder ø 31mm H 40mm Qty 1		

knobs

producer-specific knobs

SIRMAN

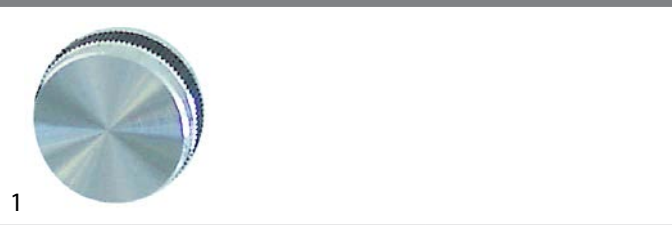

1

<b>GEV No.</b>	110929	<b>Ref. No.</b>	IB4200700 IB4200701
<b>description</b>	knob potentiometer t.max.°C temperature range°C ø 23mm shaft ø 6mm silver		
<b>For models:</b>	APOLLO CE, DRAGONE CE, ORIONE CE, ROLLER		

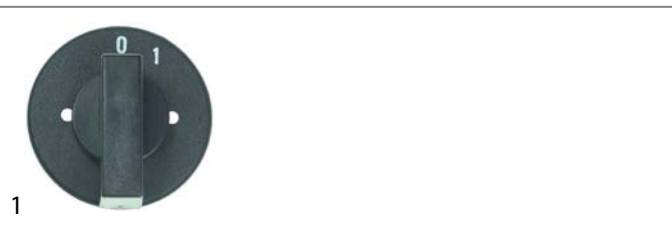

1

<b>GEV No.</b>	112907	<b>Ref. No.</b>	IB4206440
<b>description</b>	knob switch 0-1 t.max.°C temperature range°C ø 50mm shaft ø 5x5mm black		

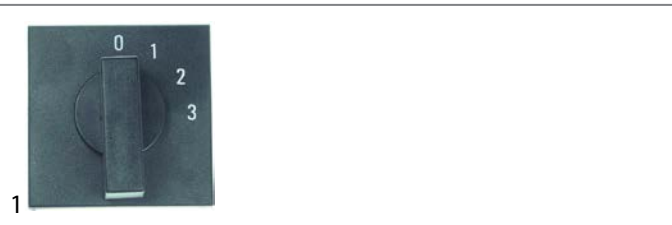

1

<b>GEV No.</b>	112906	<b>Ref. No.</b>	IB4206450
<b>description</b>	knob switch 0-1-2-3 ø 52x52mm shaft ø 5x5mm square external size 52x52mm		



1

<b>GEV No.</b>	110277	<b>Ref. No.</b>	ATHD061001
<b>description</b>	knob switch zero mark ø 42mm shaft ø 8 x 5.5mm shaft flat upper black		



1

<b>GEV No.</b>	696294	<b>Ref. No.</b>	RG04352
<b>description</b>	knob switch zero mark ø 44mm shaft ø 6x4.6/3.5x3.5mm shaft flat upper black 2-piece		



1

<b>GEV No.</b>	110931	<b>Ref. No.</b>	IB4206400 (old version)
<b>description</b>	knob switch zero mark ø 45mm shaft ø 5x6mm shaft flat upper black		



1

<b>GEV No.</b>	112280	<b>Ref. No.</b>	IB4200100
<b>description</b>	knob switch zero mark t.max.°C temperature range°C ø 16mm shaft ø 6mm black/grey		
<b>For models:</b>	SIRIO 1 GDO CE, SIRIO 2 GDO CE		



1

<b>GEV No.</b>	112916	<b>Ref. No.</b>	KODK003
<b>description</b>	knob switch zero mark t.max.°C temperature range°C ø 18mm shaft ø 5,5mm		



1

<b>GEV No.</b>	111235	<b>Ref. No.</b>	IB4200705
<b>description</b>	knob switch zero mark t.max.°C temperature range°C ø 23mm shaft ø 5.5mm black		
<b>For models:</b>	CICLONE 15VV CE		



1

<b>GEV No.</b>	112283	<b>Ref. No.</b>	MSC04V236
<b>description</b>	knob switch zero mark t.max.°C temperature range°C ø 23mm shaft ø 6mm black		
<b>For models:</b>	C9VV CE		



1

<b>GEV No.</b>	110275	<b>Ref. No.</b>	IGS336
<b>description</b>	knob switch zero mark t.max.°C temperature range°C ø 45mm shaft ø 6x5mm shaft flat rectangular black		
<b>For models:</b>	12Q, 4Q, 6Q		



1

<b>GEV No.</b>	110276	<b>Ref. No.</b>	IB4206412 IGS385SF
<b>description</b>	knob switch zero mark t.max.°C temperature range°C ø 49mm shaft ø 6x4.6mm shaft flat upper black		
<b>For models:</b>	SALAMANDRA PRO 1/1G CE		



1

<b>GEV No.</b>	110366	<b>Ref. No.</b>	IB4206400
<b>description</b>	knob switch zero mark t.max.°C temperature range°C ø 44mm shaft ø 6x4.6mm shaft flat upper black		

			
1			
<b>GEV No.</b>	112914	<b>Ref. No.</b>	IB4206010
<b>description</b>	knob thermostat t.max. 90°C temperature range 30-90°C ø 42mm shaft ø 6x4.6mm shaft flat upper		
<b>For models:</b>	VETRINETTA 38		

## handles and hand wheels

### cylindrical handles

fixed

			
1			
<b>GEV No.</b>	110703	<b>Ref. No.</b>	IV4000800
<b>description</b>	cylindrical handle thread M10 ø 28mm L 87mm		
<b>For models:</b>	TCG12M		

			
1			
<b>GEV No.</b>	112917	<b>Ref. No.</b>	IB4206430
<b>description</b>	cylindrical handle thread M8 ø 23mm L 55mm		
<b>For models:</b>	SALAMANDRA PRO 1/1G CE		

			
1			
<b>GEV No.</b>	691314	<b>Ref. No.</b>	MF2359
<b>description</b>	cylindrical handle thread M8 ø 28mm L 86mm		
<b>For models:</b>	TCG 22 E CE		

### cone handles

			
1			
<b>GEV No.</b>	698195	<b>Ref. No.</b>	19562903 19562905
<b>description</b>	cone handle thread M10 ø 29mm L 82mm black		

			
1			
<b>GEV No.</b>	697517	<b>Ref. No.</b>	IB4206451
<b>description</b>	cone handle thread M10 ø 30mm L 66mm black		
<b>For models:</b>	TRITON CE		

			
1			
<b>GEV No.</b>	697431	<b>Ref. No.</b>	19562901 19564019
<b>description</b>	cone handle thread M6 ø 26mm plastic L 70mm black thread L 10mm		

			
1			
<b>GEV No.</b>	697432	<b>Ref. No.</b>	19562900
<b>description</b>	cone handle thread M6 ø 26mm plastic L 70mm thread L 6mm		

			
1			
<b>GEV No.</b>	696266	<b>Ref. No.</b>	AMA008
<b>description</b>	cone handle thread M4 ø 9mm L 14mm aluminium slicer		
<b>For models:</b>	PERLA 220 CE DOM, PERLA 250 CE DOM		

### mushroom cap handles

			
1			
<b>GEV No.</b>	696267	<b>Ref. No.</b>	19021110
<b>description</b>	mushroom cap handle thread M4 ø 16mm L 18.5mm aluminium slicer		



1

<b>GEV No.</b>	697445	<b>Ref. No.</b>	SM211413
<b>description</b>	mushroom cap handle thread M6 handle ø 33mm L 26mm plastic black		

## ball handles



1

<b>GEV No.</b>	112694	<b>Ref. No.</b>	MSC04N018
<b>description</b>	ball handle thread M6 ø 20mm with metal bush black plastic		
<b>For models:</b>	C9VV CE		

## star handles



1

<b>GEV No.</b>	698183	<b>Ref. No.</b>	29561651 IV4200500
<b>description</b>	locking screw thread M8 L 26mm handle ø 40mm		
<b>For models:</b>	TC 12 MAGNUM INGRANAGGI CE		



1

<b>GEV No.</b>	698200	<b>Ref. No.</b>	19562502
<b>description</b>	star handle thread M6 ø 40mm L 29mm black		



1

<b>GEV No.</b>	111054	<b>Ref. No.</b>	19564016
<b>description</b>	star handle thread M6 ø 40mm L 29mm blue		



1

<b>GEV No.</b>	697443	<b>Ref. No.</b>	19562504 19564013
<b>description</b>	star handle thread M8 ø 50mm L 29mm black		
<b>For models:</b>	PERLA 220 CE DOM, PERLA 250 CE DOM		



1

<b>GEV No.</b>	111404	<b>Ref. No.</b>	LF1510702
<b>description</b>	star handle thread M8x1.25 ø 31mm L 23.5mm black		

## bracket handles



1

<b>GEV No.</b>	691263	<b>Ref. No.</b>	IB4200910
<b>description</b>	pull handle L 160mm H 56mm mounting distance 133mm thread M8		
<b>For models:</b>	SALAMANDRA PRO 1/1G CE		

## fasteners

### locking screws



1

<b>GEV No.</b>	698515	<b>Ref. No.</b>	29561600.14
<b>description</b>	locking screw thread M10x1.5 thread L 30mm handle ø 50mm black plastic/SS edition since 08/2014		



1

<b>GEV No.</b>	697516	<b>Ref. No.</b>	19562700 19564018
<b>description</b>	locking screw thread M5 handle ø 25mm L 8mm		





accessories

extensions

			
1			
<b>GEV No.</b>	696096	<b>Ref. No.</b>	IB2080712
<b>description</b>	handle rod L 160mm ø 10mm T1: M8 T2: M10		
<b>For models:</b>	TRITON CE		

hinges

miscellaneous

			
1			
<b>GEV No.</b>	691106	<b>Ref. No.</b>	IB7506000
<b>description</b>	door hinge kit for glass door mounting pos. upper/lower		
<b>For models:</b>	VETRINETTA 38		

pullouts

rollers

rollers

accessories

			
1			
<b>GEV No.</b>	560133	<b>Ref. No.</b>	IX2934006
<b>description</b>	hexagonal nut thread M6 H 5mm WS 10 SS DIN/ISO DIN 934 / ISO 4032/8673 Qty 20 pcs		

equipment feet and end caps

screw-in feet

			
1			
<b>GEV No.</b>	696094	<b>Ref. No.</b>	IB4356015
<b>description</b>	equipment foot thread M4 thread L 10mm ø 15mm H 10mm Qty 1 pcs		
<b>For models:</b>	ORIONE CE		

			
1			
<b>GEV No.</b>	693791	<b>Ref. No.</b>	19560201
<b>description</b>	equipment foot thread M5 thread L 10mm ø 36mm H 27mm Qty 1 pcs		
<b>For models:</b>	PERLA 220 CE DOM, PERLA 250 CE DOM		

			
1			
<b>GEV No.</b>	696043	<b>Ref. No.</b>	MSC04N114K MSC04N114K + MSC04N115K
<b>description</b>	equipment foot thread M5 thread L 8mm ø 28mm H 24mm Qty 1 pcs C4-C6-C9		
<b>For models:</b>	C9VV CE		

			
1			
<b>GEV No.</b>	691264	<b>Ref. No.</b>	IB4356000
<b>description</b>	equipment foot thread M6 thread L 16mm ø 25mm H 6mm Qty 1 pcs		
<b>For models:</b>	VETRINETTA 38		

			
1			
<b>GEV No.</b>	697770	<b>Ref. No.</b>	19560202
<b>description</b>	equipment foot thread M8 thread L 12mm ø 47mm H 35mm Qty 1 pcs		

			
1			
<b>GEV No.</b>	695612	<b>Ref. No.</b>	IV4083500
<b>description</b>	equipment foot thread M8 thread L 20mm ø 29mm H 11mm Qty 1 pcs		

			
1			
<b>GEV No.</b>	513284	<b>Ref. No.</b>	IB4356005
<b>description</b>	equipment foot thread M8 thread L 20mm ø 30mm H 12mm Qty 1 pcs		
<b>For models:</b>	SALAMANDRA PRO 1/1G CE		

## gaskets

### O-rings

#### EPDM

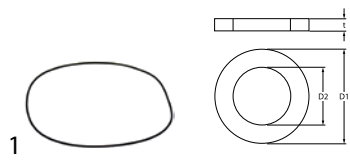

1

<b>GEV No.</b>	698025	<b>Ref. No.</b>	MF2351
<b>description</b>	O-ring EPDM thickness 2mm ID ø 164.5mm Qty 1 pcs		



1

<b>GEV No.</b>	532614	<b>Ref. No.</b>	19560103 SM211108
<b>description</b>	O-ring EPDM thickness 3.53mm ID ø 12.29mm Qty 1 pcs		



1

<b>GEV No.</b>	696071	<b>Ref. No.</b>	IB4104040
<b>description</b>	O-ring EPDM thickness 3.53mm ID ø 52.39mm Qty 1 pcs		
<b>For models:</b>	ORIONE CE		



1

<b>GEV No.</b>	532629	<b>Ref. No.</b>	IV7200600
<b>description</b>	O-ring EPDM thickness 3.53mm ID ø 74.61mm Qty 1 pcs		

#### miscellaneous

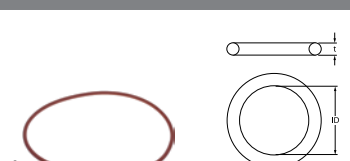

1

<b>GEV No.</b>	532600	<b>Ref. No.</b>	LF1211302
<b>description</b>	O-ring SILOPREN thickness 7mm ID ø 240.67mm Qty 1 pcs OR 08950		



1

<b>GEV No.</b>	532608	<b>Ref. No.</b>	LF1212202
<b>description</b>	O-ring SILOPREN thickness 7mm ID ø 354.9mm Qty 1 pcs OR 081400		

## sealing washers

### rubber gaskets



1

<b>GEV No.</b>	510649	<b>Ref. No.</b>	LF1212201
<b>description</b>	boot Qty 1 pcs		



1

<b>GEV No.</b>	501593	<b>Ref. No.</b>	LF1232608
<b>description</b>	flat gasket rubber ED ø 76mm ID ø 58mm thickness 1mm Qty 1 pcs		

### silicone gaskets



1

<b>GEV No.</b>	696076	<b>Ref. No.</b>	IB4100915
<b>description</b>	gasket silicone ED ø 68mm ID ø 48mm thickness 2mm Qty 1 pcs		
<b>For models:</b>	ORIONE CE		

## shaft gaskets

### v-rings



1

<b>GEV No.</b>	696075	<b>Ref. No.</b>	IB4104031
<b>description</b>	V-ring ID ø 8mm thickness 5mm		
<b>For models:</b>	DRAGONE CE		

### shaft gaskets





1

<b>GEV No.</b>	698118	<b>Ref. No.</b>	LF1234001
<b>description</b>	shaft seal		
<b>For models:</b>	TC32IND, TC42IND		





			
1			
<b>GEV No.</b>	698119	<b>Ref. No.</b>	LF1234002
<b>description</b>	shaft seal		
<b>For models:</b>	TC32IND, TC42IND		

			
1			
<b>GEV No.</b>	698211	<b>Ref. No.</b>	IB4104010
<b>description</b>	shaft seal ID ø 15mm ED ø 24mm thickness 5mm		
<b>For models:</b>	CICLONE ASTA 25cm 0,15/0,23kW, CICLONE ASTA 35cm 0,15/0,23kW, VORTEX 43, VORTEX 55, VORTEX 75, VORTEX ASTA 30cm 0,43/0,55/0,75kW, VORTEX ASTA 40cm 0,43/0,55/0,75kW		

			
1			
<b>GEV No.</b>	698116	<b>Ref. No.</b>	LF1260001
<b>description</b>	shaft seal ID ø 15mm ED ø 30mm thickness 7mm		
<b>For models:</b>	TC22PF, TC32PF		

			
1			
<b>GEV No.</b>	696834	<b>Ref. No.</b>	LF1210002
<b>description</b>	shaft seal ID ø 25mm ED ø 40mm thickness 5mm		

			
1			
<b>GEV No.</b>	698002	<b>Ref. No.</b>	IV72AT 40x25x8mm MF0106 MF2101
<b>description</b>	shaft seal ID ø 25mm ED ø 40mm thickness 7mm		
<b>For models:</b>	TC12M, TC22E CE, TCG 22 E CE, TCG12E, TCG12M, TCG22E		

			
1			
<b>GEV No.</b>	698117	<b>Ref. No.</b>	LF1233002
<b>description</b>	shaft seal ID ø 25mm ED ø 47mm thickness 7mm		
<b>For models:</b>	TC22PF, TC32PF		

			
Image not available			
1			
<b>GEV No.</b>	698123	<b>Ref. No.</b>	LF1243001
<b>description</b>	shaft seal ID ø 30mm ED ø 62mm thickness 7mm		
<b>For models:</b>	IP30, MASTER30		

			
1			
<b>GEV No.</b>	698121	<b>Ref. No.</b>	LF1239203
<b>description</b>	shaft seal ID ø 35mm ED ø 50mm thickness 5mm		
<b>For models:</b>	TC12RIO, TC22FR, TC22LAPORTE, TC22RIO		

			
1			
<b>GEV No.</b>	696379	<b>Ref. No.</b>	LF1232611
<b>description</b>	shaft seal ID ø 40mm ED ø 50mm thickness 7mm		

			
1			
<b>GEV No.</b>	698122	<b>Ref. No.</b>	LF1239401
<b>description</b>	shaft seal ID ø 40mm ED ø 62mm thickness 7mm		
<b>For models:</b>	MASTER30, TC32FR, TC32LAPORTE, TC32RIO		

			
1			
<b>GEV No.</b>	698306	<b>Ref. No.</b>	MSC04N094
<b>description</b>	shaft sealing ID ø 15mm ED ø 20mm thickness 6mm		
<b>For models:</b>	C9VV CE		

special gaskets

for vacuum packers

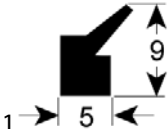
			
1			
<b>GEV No.</b>	902524	<b>Ref. No.</b>	IW1471240010
<b>description</b>	lid gasket silicone Qty 1 for vacuum packing machine L 1870mm		

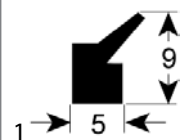

<b>GEV No.</b>	902525	<b>Ref. No.</b>	IW1471250010
<b>description</b>	lid gasket silicone Qty 1 for vacuum packing machine L 2130mm		

miscellaneous



<b>GEV No.</b>	698305	<b>Ref. No.</b>	LF1232605
<b>description</b>	gasket for mincer thickness 0.9mm for gearbox		

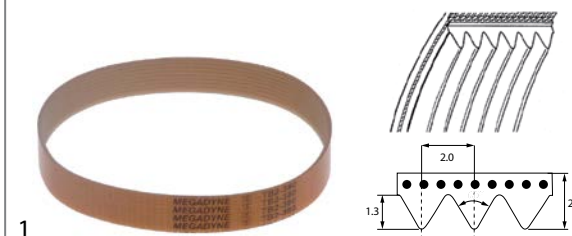

<b>GEV No.</b>	698221	<b>Ref. No.</b>	19310209
<b>description</b>	poly-v belt grooves 11 W 22mm L 480mm profile TB2		

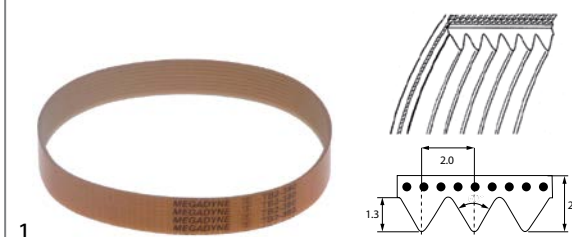

<b>GEV No.</b>	698157	<b>Ref. No.</b>	LF2037056
<b>description</b>	poly-v belt grooves 12 W 24mm L 725mm profile TB2		
<b>For models:</b>	TCG12M		

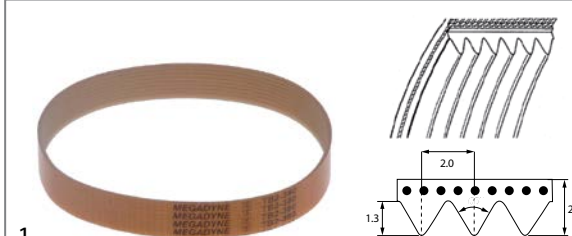

<b>GEV No.</b>	698156	<b>Ref. No.</b>	LF2037058
<b>description</b>	poly-v belt grooves 14 W 28mm L 430mm profile TB2		
<b>For models:</b>	TCG12M		

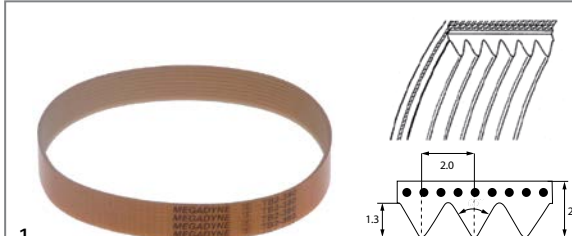

<b>GEV No.</b>	698222	<b>Ref. No.</b>	IB7003012
<b>description</b>	poly-v belt grooves 6 W 12mm L 526mm profile TB2		
<b>For models:</b>	TRITON CE		

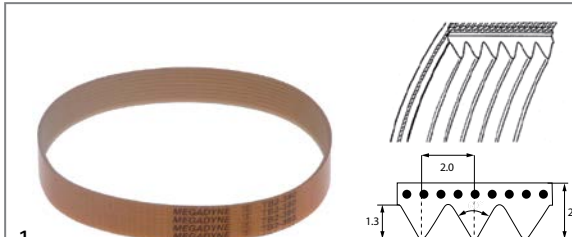

<b>GEV No.</b>	693939	<b>Ref. No.</b>	MSC04N112 MSC04N112 bis 1999
<b>description</b>	poly-v belt grooves 6 W 12mm L 630mm profile TB2		

transmission technology and ball bearings

drive belts

poly-v belts

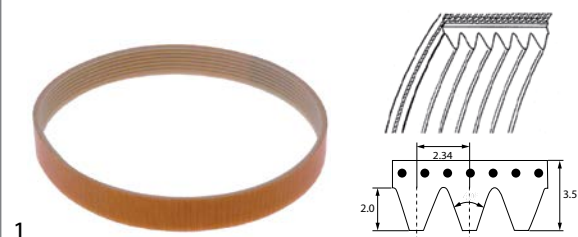

<b>GEV No.</b>	698227	<b>Ref. No.</b>	IV7000010
<b>description</b>	poly-v belt grooves 8 W 18mm L 483mm profile J		
<b>For models:</b>	TV-TM INOX, TV-TM INOX07		

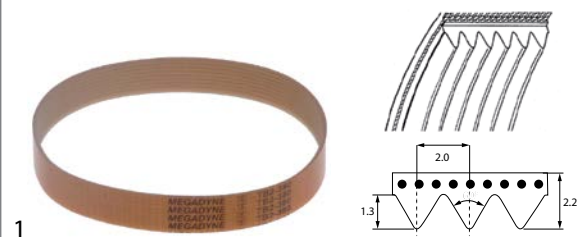

<b>GEV No.</b>	698220	<b>Ref. No.</b>	19310207
<b>description</b>	poly-v belt grooves 10 W 20mm L 380mm profile TB2		

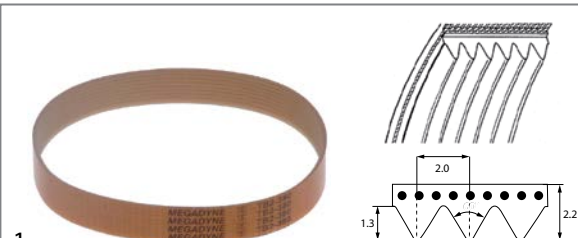

<b>GEV No.</b>	698126	<b>Ref. No.</b>	IB7003412
<b>description</b>	poly-v belt grooves 10 W 20mm L 430mm profile TB2		
<b>For models:</b>	OLIMPO		



1

<b>GEV No.</b>	698223	<b>Ref. No.</b>	MSC04N112A MSC04N112A ab 1999
<b>description</b>	poly-v belt grooves 6 W 12mm L 660mm profile TB2		
<b>For models:</b>	C9VV CE		

1

<b>GEV No.</b>	697367	<b>Ref. No.</b>	19310203
<b>description</b>	poly-v belt grooves 8 W 16mm L 330mm profile TB2		

1

<b>GEV No.</b>	698224	<b>Ref. No.</b>	MSC09V112
<b>description</b>	poly-v belt grooves 7 W 14mm L 1186mm profile TB2		

1

<b>GEV No.</b>	697616	<b>Ref. No.</b>	19310201
<b>description</b>	poly-v belt grooves 8 W 16mm L 345mm profile TB2		

1

<b>GEV No.</b>	697612	<b>Ref. No.</b>	AMA024
<b>description</b>	poly-v belt grooves 8 W 16mm L 266mm profile TB2		

1

<b>GEV No.</b>	698219	<b>Ref. No.</b>	19310206
<b>description</b>	poly-v belt grooves 8 W 16mm L 360mm profile TB2		

1

<b>GEV No.</b>	697613	<b>Ref. No.</b>	AMC024
<b>description</b>	poly-v belt grooves 8 W 16mm L 295mm profile TB2		
<b>For models:</b>	PERLA 220 CE DOM		

1

<b>GEV No.</b>	697619	<b>Ref. No.</b>	19310212
<b>description</b>	poly-v belt grooves 8 W 16mm L 430mm profile TB2		

1

<b>GEV No.</b>	697280	<b>Ref. No.</b>	AMG024
<b>description</b>	poly-v belt grooves 8 W 16mm L 310mm profile TB2		
<b>For models:</b>	PERLA 250 CE DOM		

1

<b>GEV No.</b>	698226	<b>Ref. No.</b>	RG08248
<b>description</b>	poly-v belt grooves 10 W 23mm L 432mm profile TB2.34		
<b>For models:</b>	PP EXPO 4 CE, PP EXPO 8 CE		



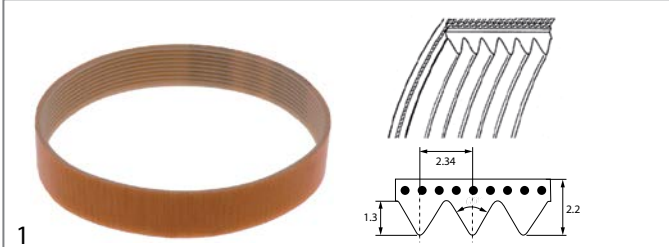

1

<b>GEV No.</b>	697639	<b>Ref. No.</b>	RG15248
<b>description</b>	poly-v belt grooves 10 W 23mm L 711mm profile TB2.34		

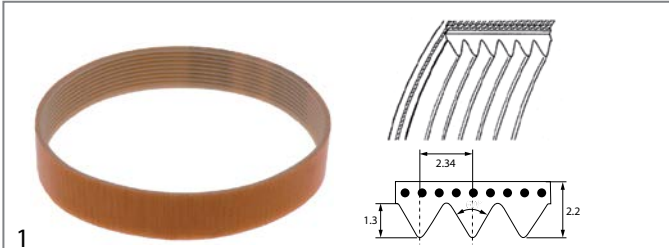

1

<b>GEV No.</b>	698225	<b>Ref. No.</b>	RG04248
<b>description</b>	poly-v belt grooves 6 W 14mm L 432mm profile TB2.34		

## springs

### torsion springs



1

<b>GEV No.</b>	690169	<b>Ref. No.</b>	IGS543C
<b>description</b>	torsion spring $\varnothing$ 20.1mm L2 40mm wire gauge $\varnothing$ 3.6mm mounting pos. left L1 16mm L3 16mm		
<b>accessories for</b>	690169		
	<b>GEV No.</b>	<b>Ref. No.</b>	<b>IGS540C</b>
	690159		
<b>description</b>	torsion spring $\varnothing$ 20.2mm L2 40mm wire gauge $\varnothing$ 3.7mm mounting pos. right L1 16mm L3 16mm		





1

<b>GEV No.</b>	690194	<b>Ref. No.</b>	IGS543
<b>description</b>	torsion spring $\varnothing$ 20.1mm L2 40mm wire gauge $\varnothing$ 3.8mm mounting pos. left L1 16mm L3 16mm		



1

<b>GEV No.</b>	690159	<b>Ref. No.</b>	IGS540C
<b>description</b>	torsion spring $\varnothing$ 20.2mm L2 40mm wire gauge $\varnothing$ 3.7mm mounting pos. right L1 16mm L3 16mm		
<b>accessories for</b>	690159		
	<b>GEV No.</b>	<b>Ref. No.</b>	<b>IGS543C</b>
	690169		
<b>description</b>	torsion spring $\varnothing$ 20.1mm L2 40mm wire gauge $\varnothing$ 3.6mm mounting pos. left L1 16mm L3 16mm		



1

<b>GEV No.</b>	690193	<b>Ref. No.</b>	IGS540
<b>description</b>	torsion spring $\varnothing$ 20.2mm L2 40mm wire gauge $\varnothing$ 3.7mm mounting pos. right L1 16mm L3 16mm		



1

<b>GEV No.</b>	694861	<b>Ref. No.</b>	IGS809053
<b>description</b>	torsion spring $\varnothing$ 20mm L2 11mm wire gauge $\varnothing$ 3mm L1 30mm L3 40mm Qty 1 pcs		



1

<b>GEV No.</b>	692895	<b>Ref. No.</b>	IGS309253
<b>description</b>	torsion spring $\varnothing$ 20mm L2 38mm wire gauge $\varnothing$ 3.2mm mounting pos. left L1 14mm L3 8mm		





1

<b>GEV No.</b>	692894	<b>Ref. No.</b>	IGS309243
<b>description</b>	torsion spring $\varnothing$ 20mm L2 38mm wire gauge $\varnothing$ 3.2mm mounting pos. right L1 14mm L3 8mm		

			
<b>GEV No.</b>	690198	<b>Ref. No.</b>	IGS109013 IGS540/99
<b>description</b>	torsion spring ø 21.2mm L2 40mm wire gauge ø 3.5mm mounting pos. right L1 26mm L3 10mm edition build from 1999		
<b>accessories for</b>	690198		
			
<b>GEV No.</b>	690199	<b>Ref. No.</b>	IGS543/99 IGSIGS109023
<b>description</b>	torsion spring ø 21.2mm L2 42mm wire gauge ø 3.3mm mounting pos. left L1 40mm L3 28mm edition build from 1999		

			
<b>GEV No.</b>	690199	<b>Ref. No.</b>	IGS543/99 IGSIGS109023
<b>description</b>	torsion spring ø 21.2mm L2 42mm wire gauge ø 3.3mm mounting pos. left L1 40mm L3 28mm edition build from 1999		
<b>accessories for</b>	690199		
			
<b>GEV No.</b>	690198	<b>Ref. No.</b>	IGS109013 IGS540/99
<b>description</b>	torsion spring ø 21.2mm L2 40mm wire gauge ø 3.5mm mounting pos. right L1 26mm L3 10mm edition build from 1999		

			
<b>GEV No.</b>	690185	<b>Ref. No.</b>	IGS109033 IGS540C/99
<b>description</b>	torsion spring ø 22.6mm L2 40mm wire gauge ø 3.8mm mounting pos. right L1 25mm L3 9mm		
<b>accessories for</b>	690185		
			
<b>GEV No.</b>	690192	<b>Ref. No.</b>	IGS109043 IGS543C/99
<b>description</b>	torsion spring ø 22mm L2 40mm wire gauge ø 3.7mm mounting pos. left L1 26mm L3 10mm		

			
<b>GEV No.</b>	690192	<b>Ref. No.</b>	IGS109043 IGS543C/99
<b>description</b>	torsion spring ø 22mm L2 40mm wire gauge ø 3.7mm mounting pos. left L1 26mm L3 10mm		

compression springs

			
<b>GEV No.</b>	696211	<b>Ref. No.</b>	AMC672
<b>description</b>	compression spring ø 11.5mm L 46mm wire gauge ø 1.3mm slicer 220		
<b>For models:</b>	PERLA 220 CE DOM, PERLA 250 CE DOM		

			
<b>GEV No.</b>	696208	<b>Ref. No.</b>	SM370111
<b>description</b>	compression spring ø 13.5mm L 57mm wire gauge ø 1.4mm slicer 275-300		

			
<b>GEV No.</b>	696209	<b>Ref. No.</b>	19390205
<b>description</b>	compression spring ø 13.5mm L 92mm wire gauge ø 1.4mm slicer		

			
<b>GEV No.</b>	696210	<b>Ref. No.</b>	19390600
<b>description</b>	compression spring ø 14mm L 16mm wire gauge ø 1.2mm slicer 220-250		

			
<b>GEV No.</b>	696205	<b>Ref. No.</b>	SM370104
<b>description</b>	compression spring ø 22/28mm L 22mm wire gauge ø 2mm conical slicer D1 ø 22mm D2 ø 28mm 250-300		

			
<b>GEV No.</b>	696207	<b>Ref. No.</b>	AMC244
<b>description</b>	compression spring ø 23/25mm L 19mm wire gauge ø 1.5mm conical slicer D1 ø 23mm D2 ø 25mm 220-250		
<b>For models:</b>	PERLA 220 CE DOM, PERLA 250 CE DOM		

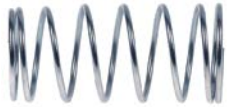

<b>GEV No.</b>	696206	<b>Ref. No.</b>	AMC254 AMG254
<b>description</b>	compression spring $\varnothing$ 23/25mm L 53mm wire gauge $\varnothing$ 1.5mm conical slicer D1 $\varnothing$ 23mm D2 $\varnothing$ 25mm 220-250		
<b>For models:</b>	PERLA 220 CE DOM, PERLA 250 CE DOM		



<b>GEV No.</b>	528977	<b>Ref. No.</b>	IB76M4005
<b>description</b>	compression spring $\varnothing$ 5.5mm L 15mm wire gauge $\varnothing$ 0.4mm CICLEONE		
<b>For models:</b>	CICLEONE 15VV CE, CICLEONE 23 CE		



<b>GEV No.</b>	691262	<b>Ref. No.</b>	IB76M4000
<b>description</b>	compression spring $\varnothing$ 6mm L 13mm wire gauge $\varnothing$ 0.8mm		
<b>For models:</b>	VORTEX 43, VORTEX 55, VORTEX 75		



<b>GEV No.</b>	696099	<b>Ref. No.</b>	IV75MTM
<b>description</b>	compression spring $\varnothing$ 7.2mm L 19mm wire gauge $\varnothing$ 0.7mm for micro-switch model TM		
<b>For models:</b>	TV-TM INOX, TV-TM INOX07		



<b>GEV No.</b>	696212	<b>Ref. No.</b>	AMA814
<b>description</b>	compression spring $\varnothing$ 7.6mm L 22mm wire gauge $\varnothing$ 0.7mm slicer 195-220		
<b>For models:</b>	PERLA 220 CE DOM		



<b>GEV No.</b>	696213	<b>Ref. No.</b>	AME410
<b>description</b>	compression spring $\varnothing$ 7.6mm L 28mm wire gauge $\varnothing$ 0.7mm slicer PARKER		
<b>For models:</b>	PERLA 250 CE DOM		

## kitchen accessories

### spillage trays



<b>GEV No.</b>	698112	<b>Ref. No.</b>	LF1532001 MF0134
<b>description</b>	meat collecting tray L 255mm W 195mm H 50mm		



<b>GEV No.</b>	698074	<b>Ref. No.</b>	MF0189
<b>description</b>	meat collecting tray L 310mm W 240mm H 50mm		



<b>GEV No.</b>	698071	<b>Ref. No.</b>	MF0028
<b>description</b>	meat collecting tray $\varnothing$ 160mm Lmm Wmm H 60mm		



<b>GEV No.</b>	698073	<b>Ref. No.</b>	MF0157
<b>description</b>	meat collecting tray $\varnothing$ 220mm Lmm Wmm H 90mm		

## fastening material

### rivets/rievt nuts

#### plastic rivets





<b>GEV No.</b>	692572	<b>Ref. No.</b>	PANE9082930AP
<b>description</b>	mounting clip $\varnothing$ 8mm suitable for microwave		



screws

countersunk screws

			
1			
<b>GEV No.</b>	560201	<b>Ref. No.</b>	RG08060
<b>description</b>	countersunk screw thread M6 L 14mm WS 4 SS DIN 7991/ISO 10642 Qty 1 pcs intake hexagonal		
<b>For models:</b>	PP EXPO 4 CE, PP EXPO 8 CE		

			
1			
<b>GEV No.</b>	560661	<b>Ref. No.</b>	IX27991008020
<b>description</b>	countersunk screw thread M8 L 20mm DIN 7991 Qty 10 pcs intake hexagonal 5mm head ø 16mm		

			
1			
<b>GEV No.</b>	560383	<b>Ref. No.</b>	40000000 C9VV Pos.98
<b>description</b>	countersunk screw thread M5 L 16mm SS DIN 965/ISO 7046 Qty 1 pcs head ø 9mm oval head		

flat-headed bolts

			
1			
<b>GEV No.</b>	560062	<b>Ref. No.</b>	60000000
<b>description</b>	flat-headed bolt thread M4 thread L 10mm SS DIN 7985/ISO 7045 Qty 20 pcs intake Phillips head ø 8mm head thickness 2mm		

oval head screws

			
1			
<b>GEV No.</b>	560319	<b>Ref. No.</b>	RG04062
<b>description</b>	oval head screw thread M6 thread L 14mm intake hexagonal 4mm		
<b>For models:</b>	PP EXPO 4 CE, PP EXPO 8 CE		

hexagonal screws

			
1			
<b>GEV No.</b>	560090	<b>Ref. No.</b>	IX2933006030
<b>description</b>	hexagonal screw thread M6 thread L 30mm SS WS 10 Qty 20 pcs DIN 933 / ISO 4017		

cylinder head bolts

DIN 912/ISO 4762

			
1			
<b>GEV No.</b>	560591	<b>Ref. No.</b>	IX2912005016
<b>description</b>	cylinder head bolt thread M5 thread L 16mm WS 4 SS Qty 1 pcs intake internal hexagon DIN 912/ISO 4762		

grub screws

DIN 916/ISO 4029

			
1			
<b>GEV No.</b>	696273	<b>Ref. No.</b>	AMA085 AMI072
<b>description</b>	grub screw thread M5 L 10mm DIN 916/ISO 4029 intake internal hexagon WS 2.5 Qty 1 pcs		
<b>For models:</b>	PERLA 220 CE DOM, PERLA 250 CE DOM		

			
1			
<b>GEV No.</b>	696274	<b>Ref. No.</b>	AMA026
<b>description</b>	grub screw thread M5 L 6/10mm DIN 916/ISO 4029 WS 2.5 set Qty 1 pcs L1 6mm L2 10mm		

			
1			
<b>GEV No.</b>	696272	<b>Ref. No.</b>	AMA266
<b>description</b>	grub screw thread M5 L 6mm DIN 916/ISO 4029 intake internal hexagon WS 2.5 Qty 1 pcs		
<b>For models:</b>	PERLA 220 CE DOM, PERLA 250 CE DOM		

			
1			
<b>GEV No.</b>	510906	<b>Ref. No.</b>	AMA030
<b>description</b>	grub screw thread M6 L 8mm stainless steel DIN 914/ISO 4027 WS 3 Qty 1 pcs		
<b>For models:</b>	PERLA 220 CE DOM, PERLA 250 CE DOM		



1

<b>GEV No.</b>	560207	<b>Ref. No.</b>	AMA086
<b>description</b>	grub screw thread M8 L 10mm steel DIN 916/ISO 4029 intake internal hexagon WS 4 Qty 1 pcs		
<b>For models:</b>	PERLA 220 CE DOM, PERLA 250 CE DOM		

## miscellaneous



1

<b>GEV No.</b>	504788	<b>Ref. No.</b>	AMA282
<b>description</b>	screw thread M5 L 50mm Qty 1 pcs		
<b>For models:</b>	PERLA 220 CE DOM, PERLA 250 CE DOM		

## miscellaneous



1

<b>GEV No.</b>	696006	<b>Ref. No.</b>	MF0124
<b>description</b>	screw		

## nuts

## wing nuts



1

<b>GEV No.</b>	697300	<b>Ref. No.</b>	IB77DG12
<b>description</b>	wing nuts thread M12 SS Qty 1 pcs		



1

<b>GEV No.</b>	560147	<b>Ref. No.</b>	AMC678
<b>description</b>	wing nuts thread M6 SS DIN/ISO DIN 315 Qty 20 pcs		
<b>For models:</b>	PERLA 220 CE DOM, PERLA 250 CE DOM		

## cap nuts



1

<b>GEV No.</b>	695119	<b>Ref. No.</b>	IB2000910
<b>description</b>	cap nuts thread M5L WS 10 SS Qty 1 pcs		
<b>For models:</b>	DRAGONE CE, ORIONE CE		

## hexagonal nuts

## DIN 934 / ISO 4032/8673



1

<b>GEV No.</b>	560133	<b>Ref. No.</b>	IX2934006
<b>description</b>	hexagonal nut thread M6 H 5mm WS 10 SS DIN/ISO DIN 934 / ISO 4032/8673 Qty 20 pcs		

## washers

## spring rings



1

<b>GEV No.</b>	560123	<b>Ref. No.</b>	IX21751006
<b>description</b>	lock washer ID ø 6.3mm ED ø 11mm SS DIN127 Qty 20 pcs for thread M6		

## spring washers



1

<b>GEV No.</b>	696253	<b>Ref. No.</b>	19342005 AMA096
<b>description</b>	spring washer ID ø 12mm ED ø 25mm Qty 1 pcs		
<b>For models:</b>	PERLA 220 CE DOM, PERLA 250 CE DOM		





1

<b>GEV No.</b>	696254	<b>Ref. No.</b>	19342006
<b>description</b>	spring washer ID ø 19mm ED ø 32mm Qty 1 pcs		







washers			
DIN 125A			
 1			
<b>GEV No.</b>	560113	<b>Ref. No.</b>	AMA238 RG04064
<b>description</b>	plain washer ID ø 6.4mm ED ø 12mm thickness 1.6mm SS Qty 20 pcs DIN 125A for thread M6		
<b>For models:</b>	PERLA 220 CE DOM, PERLA 250 CE DOM, PP EXPO 4 CE, PP EXPO 8 CE		

DIN 9021			
 1			
<b>GEV No.</b>	560117	<b>Ref. No.</b>	IV77R06X18 IV77R06X20
<b>description</b>	plain washer ID ø 6.4mm ED ø 18mm thickness 1.5mm SS Qty 20 pcs DIN 9021 for thread M6		

## fasteners

slot nuts			
 1			
<b>GEV No.</b>	560659	<b>Ref. No.</b>	IX26885A050512
<b>description</b>	slot nut W 5mm H 5mm L 12mm		

 1			
<b>GEV No.</b>	692006	<b>Ref. No.</b>	IV76C5X5X20
<b>description</b>	slot nut W 5mm H 5mm L 20mm		

 1			
<b>GEV No.</b>	560456	<b>Ref. No.</b>	19365010
<b>description</b>	slot nut W 5mm H 5mm L 45mm		

## retaining rings

DIN 471			
 1			
<b>GEV No.</b>	693061	<b>Ref. No.</b>	IB77SE25
<b>description</b>	retaining ring shaft ø 25mm thickness 1.2mm steel DIN 471		
<b>For models:</b>	OLIMPO		

1			
**GEV No.**	523104	**Ref. No.**	LF1513006
**description**	retaining ring thickness 1.6mm stainless steel DIN 471 bore ø 30mm		
**For models:**	IP30, MASTER30		

DIN 472			
 1			
<b>GEV No.</b>	698004	<b>Ref. No.</b>	MF0114
<b>description</b>	retaining ring bore ø 40mm thickness 1.9mm steel DIN 472		
<b>For models:</b>	TCG12E, TCG22E		

1			
**GEV No.**	523102	**Ref. No.**	IB77SI47
**description**	retaining ring bore ø 47mm thickness 1.8mm steel DIN 472		
**For models:**	OLIMPO		

## consumables

### lubricants

#### oils

#### gear oils

1			
**GEV No.**	890285	**Ref. No.**	N/A
**description**	gear oil 680 EP for mincer Qty 1l		

### fuses

#### fine fuses

1			
**GEV No.**	358184	**Ref. No.**	PA62304210BP
**description**	fine fuse size ø6x30mmmm 10A slow-acting rated 250V Qty 1 pcs		



<b>A</b>		<b>L</b>	
appliance sockets/plugs	31	lamps	13
audible timers	15	light bulbs	14
axial fans	22	lubricants	119
<b>B</b>		<b>M</b>	
booster pumps II	30	magnetic switches	11
<b>C</b>		magnetrons	16
cable glands	32	mechanical timers	14
cables	32	microswitches	8
cap nuts	118	motors	22
cold air circulating fans (complete)	22	<b>N</b>	
condensators & interference suppression filters	30	nuts	118
connection cables	32	<b>O</b>	
consumables	119	oils	119
control equipment	12	operating capacitors	30
control thermostats	6	O-rings	110
countersunk screws	117	oval head screws	117
cylinder head bolts	117	oven lamps	14
<b>E</b>		<b>P</b>	
electric accessories	31	plugs - couplings - power sockets	31
energy regulators	5	power supply cables	32
<b>F</b>		probes	16
fans	22	programme timers	14
fasteners	119	pumps	30
fastening material	116	push/momentary push switches	7
fine fuses	119	<b>Q</b>	
flat-headed bolts	117	quartz heating elements	4
funnel trays	57	<b>R</b>	
fuses	31, 119	refrigeration fans	22
<b>G</b>		retaining rings	119
grub screws	117	rivets/rivet nuts	116
<b>H</b>		rocker/momentary rocker switches	6
heating elements	3	rotary switches	10
heating elements for contact grills	3	<b>S</b>	
heating elements for convection	5	screws	117
heating elements for griddles	3	sealing washers	110
heating elements for pizza ovens	4	shaft gaskets	110
heating elements for salamanders/toasters	4	slot nuts	119
hexagonal nuts	118	solid state relays	15
hexagonal screws	117	spillage trays	116
<b>I</b>		spring rings	118
indicator lights	13	spring washers	118
indicator lights (complete)	13	switches and momentary switches	6

**T**

temperature probes	16
terminals	32
thermostats	6
threaded cable glands	32
timers	14

**U**

universal probes	16
------------------	----

**W**

washers	119
wing nuts	118