



GAS COMPONENTS



ELECTRIC COMPONENTS



WATER TECHNOLOGY



MECHANICAL COMPONENTS



TOOLS

Spare parts suitable for

SOGECO

Find the complete and up-to-date range of products in our GEV Webshop



Manufacturer catalogue

The most important spare parts and accessories arranged clearly for every manufacturer

- ✓ Complete product range and all appliance data always up to date in the GEV Webshop
- ✓ Alphabetical Index at the end of the catalogue

GEV Webshop

www.gev-online.co.uk

www.gev-online.com



- 🔍 Add to Favourites
- 🔍 Sign In with email address and usual password
- 🔍 Easy-order – place several items in your basket at the same time
- 🔍 Quick Item search – no login needed



heating elements

heating elements for convection

			
1			
GEV No.	418487	Ref. No.	03-RST-3C15
description	heating element 3150W 230V heating circuits 3 ID ø 201mm ED ø 218mm L 275mm H 41mm L1 54mm W1 63mm H1 3mm H2 38mm flange length 93mm flange width 22mm hole distance 78mm connection male faston 6.3mm connection length 65mm tube ø 8.5mm convection heating element hole ø 5mm rectangular flange		

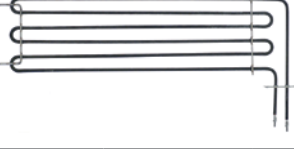
			
1			
GEV No.	419235	Ref. No.	03-RST-3B50 RES202.12011
description	heating element 3500W 230V heating circuits 1 L 560mm W 175mm L1 30mm L2 530mm W2 145mm flange length 70mm flange width 22.5mm hole distance 56mm connection M4 tube ø 6.3mm W1 33mm convection heating element combi-steamer windings 3		

thermostats

bi-metal thermostats

			
1			
GEV No.	375927	Ref. No.	03-TRS-050
description	bi-metal thermostat hole distance 23.5mm switch-off temp. 50°C 1NO 10A connection F6.3		

control and safety thermostats

EGO

control thermostats

55.10/19_ series



			
1			
GEV No.	375860	Ref. No.	03-THR-270
description	thermostat t.max. 289°C temperature range 57-289°C 1-pole 1NO 16A probe ø 3.1mm probe L 226mm capillary pipe 1780mm capillary pipe isolated 1770mm gland nut shaft ø 6x4.6mm shaft L 23mm shaft position upper rotation 270° probe material SS		

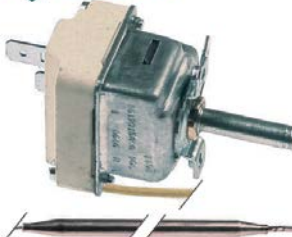

			
1			
GEV No.	375809	Ref. No.	03-THR-090
description	thermostat t.max. 90°C temperature range 30-90°C 1-pole 1NO 16A probe ø 6mm probe L 130mm capillary pipe 1800mm capillary pipe isolated 1800mm gland nut shaft ø 6x4.6mm shaft L 23mm shaft position upper rotation 270°		

CAEM

safety thermostats

			
1			
GEV No.	375456	Ref. No.	03-TRS-350
description	safety thermostat switch-off temp. 335°C 2-pole 20A probe ø 3mm probe L 200mm capillary pipe 1050mm capillary pipe isolated 650mm gland nut probe SS at 250V 20A at 400V 10A		

switches and momentary switches

push/momentary push switches

19x13mm



GEV No.	346542 ¹	Ref. No.	03-INT-B01 Interruttore 001
description	push switch mounting measurements 19x13mm yellow 2NO 250V 16A illuminated connection male faston 4.8mm ambient temperature max. 85°C protection IP40		
accessories for	346542		
	GEV No.	346541	Ref. No. —
	protective cover for rocker switch external size 23.4x17.4mm internal size 19x13mm H 9.5mm mounting measurementsmm		

¹illuminated



ø16mm



GEV No.	346287 ¹	Ref. No.	03-IPLS-001
description	momentary push switch mounting ø 16mm red 1NO 250V 3A illuminated connection male faston 2.8mm ambient temperature max. 125/55°C protection IP65 with cover cap		

¹illuminated



GEV No.	346315	Ref. No.	03-PLS-001 PULSANTE001
description	momentary push switch mounting ø 16mm red 1NO/indicator light 250V 3A connection male faston 2.8mm ambient temperature max. 85°C protection IP40		
accessories for	346315		
	GEV No.	346343	Ref. No. —
	protective cover		
	GEV No.	346344	Ref. No. —
	ring for protecting cover		

ø25mm



GEV No.	345162 ¹	Ref. No.	03-INT-B03
description	push switch mounting ø 25mm yellow 2NO 250V 16A illuminated connection male faston 6.3mm ambient temperature max. 85°C protection IP40		

¹illuminated

microswitches

pin-plunger actuated

M10



GEV No.	345156	Ref. No.	MICROSWITCH001
description	microswitch with plunger thread M10x1 thread L 13mm 250V 16A 1CO connection male faston 6.3mm stroke 6mm mounting distance 25mm L 46mm L1 13mm ambient temperature max. 85°C type C4A-ZN3 actuating force: 340g		

cam switches

2 operating positions

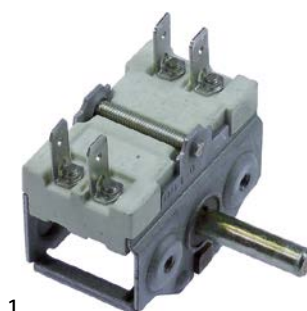

GEV No.	300216	Ref. No.	03-CMM-001
description	cam switch 2 operating positions 2NO sequence 1-2 10A shaft ø 6x4.6mm shaft L 23mm connection male faston 6.3mm ceramic		

control equipment

ERSCE

rotary switches



GEV No.	346691	Ref. No.	SELETTORE001
description	rotary selector mounting measurements ø22mm black complete 1 latching / 2 momentary sequence 1-0-2 2NO/1NO 10(4)A max 400V		



lamps

indicator lights

indicator lights (complete)

ø13mm

with plug-in socket



1

GEV No.	359143	Ref. No.	SPIA001
description	indicator light ø 13mm yellow 230V connection male faston 6.3mm temp.-resist. 120°C Qty 1 pcs		

timers

programme timers



1

GEV No.	360394	Ref. No.	03-CCL-001 alt Ciclico 001 alt
description	timer CDC 6004F engines 1 chambers 4 operation time 240s 230V		



1

GEV No.	360511	Ref. No.	03-CCL-001 CICALICO001
description	timer FIBER P19 engines 1 chambers 4 operation time 270s 230V shaft ømm shaft Lmm manuf. no. P195JV4H700 motor type M51B-J0R6400		
For models:	MX2011E-S, MX2011G-S, MX20E-S, MX20G-S, MX40E-S, MX40G-S, MX56E-S, MX56G-S, MX6E-S, MX6G-S, MX810E-S, MX810G-S, PMX2011E-S, PMX2011G-S, PMX20E-S, PMX20G-S, PMX40E-S, PMX40G-S, PMX56E-S, PMX56G-S, PMX6E-S, PMX6G-S, PMX810E-S, PMX810G-S		

electric timers





1

GEV No.	350197	Ref. No.	TIMER006#
description	timer M11 operation time 120min time spreadmin 1CO/1NO at 250V 16A permanent position yes impulse electric shaft ø 6x4.6mm shaft L 23mm mounting distance 28mm connection lateral 2-pole		

mechanical timers



1

GEV No.	350030	Ref. No.	03-TMR-002 TIMER002	
description	timer M2 2-pole operation time 120min impulse mechanical 2NO at 250V 16A permanent position no shaft ø 6x4.6mm shaft L 23mm mounting distance 28mm connection lateral			
accessories for	350030			
	GEV No.	110366	Ref. No.	—
	knob switch zero mark t.max.°C ø 44mm shaft ø 6x4.6mm shaft flat upper black			
	GEV No.	111199	Ref. No.	—
	dial plate graduation 120min permanent position no rotation 0-330° ø 60mm timers knob ø 45mm			

alarm devices

buzzer boards



1

GEV No.	350106	Ref. No.	TIMER003
description	buzzer board 230VAC L 53mm W 31mm connection male faston 4.8mm		



contactors

GENERAL ELECTRIC (AEG)

power contactors



1



GEV No.	380239	Ref. No.	03-CNT-25230
description	power contactor resistive load 20A 230VAC (AC3/400V) 8.4A/4kW main contacts 3NO auxiliary contacts 1NC connection screw connection type LS05 01A type AEG LS05 01A type GE MC1A 301A		

relays

plug-in/print relays



1

GEV No.	380847	Ref. No.	03-REL-001 Rele 001
description	relay 230VAC at 250V 8A with socket		
spare parts for	380847		
	GEV No.	380333	Ref. No. —
	print relay 230VAC 2CO at 250V 8A connection pins raster size 5mm FINDER manuf. no. 40.52.8.230.0000 95.65/95.75		
	GEV No.	380505	Ref. No. —
	relay socket 2CO 40.52 dimensions 81.9x15.5x75mm 250V voltage AC 10A FINDER manuf. no. 95.95.3		

electronic controllers

EVCO - EVERY CONTROL

universal controllers

built-in version



1

GEV No.	378170	Ref. No.	03-THR-001
description	electronic controller EVERY CONTROL EV7402 mounting measurements 66.5x66.5mm built-in depth 90mm 24/230V voltage AC NTC/PTC/Pt100/TC(J,K)/mA relay outputs 2 CO-8A(3) CO-8A(3) NTC/PTC/Pt100/TC(J,K)/mA yes protection IP54 dependend on probe°C display 4 digits		





1

GEV No.	378151	Ref. No.	03-THR-101 03-THR-102 03-THR-104
description	electronic controller EVERY CONTROL EVK412 mounting measurements 71x29mm built-in depth 59mm 12/24V voltage AC/DC NTC/PTC/Pt100/Pt1000/TC(J,K)/mV/mA relay outputs 2 CO-16A(8) CO-8A(3) NTC/PTC/Pt100/Pt1000/TC(J,K)/mV/mA yes protection IP54 dependend on probe°C display 4 digits		



1

GEV No.	379538	Ref. No.	THERMOREC.002A THERMOREC.002C THERMOREC.003
description	electronic controller EVERY CONTROL mounting measurements 71x29mm 12V voltage AC Pt100 protection IP54 -50 up to +600°C for oven type FK401A front measurements 33x75mm		
accessories for	379538		
	GEV No.	379050	Ref. No. —
	temperature probe Pt100 cable Vetrotex probe -200 up to +600°C cable -50 up to +350°C probe ø6x100mm cable length 2.7m without screw connection 3-wire		

1

GEV No.	379537	Ref. No.	TIMER004
description	electronic timer EVERY CONTROL mounting measurements 71x29mm 12V voltage AC/DC type FK700A		

probes

producer-specific probes

probes



1

GEV No.	378011	Ref. No.	03-SNC-1H SONDA021
description	core temperature probe Pt100 cable silicone probe -40 up to +120°C cable -50 up to +180°C connection 2-wire thread probe ø3x150mm cable length 2m		

core probes



1

GEV No.	378010	Ref. No.	03-SNS-1HA SONDA001
description	core temperature probe Pt100 cable SS corrugated hose probe -50 up to +400°C cable -40 up to +250°C connection 3-wire probe ø4x100mm thread 1/8" cable length 1.4m handle ø 10mm handle length 90mm		

pressure switches

for steam control



1

GEV No.	541074	Ref. No.	PRE202.15006 Pressostato001
description	pressure control ø 45mm triggering pressure 0.5bar reset pressure 0.35bar pressure connection vertical steam control pressure range 0.35/0.51bar connection 1/8" pressure connection 1/8"		
For models:	MX2011E-S, MX2011G-S, MX20E-S, MX20G-S, MX40E-S, MX40G-S, MX56E-S, MX56G-S, MX6E-S, MX6G-S, MX810E-S, MX810G-S, PMX2011E-S, PMX2011G-S, PMX20E-S, PMX20G-S, PMX40E-S, PMX40G-S, PMX56E-S, PMX56G-S, PMX6E-S, PMX6G-S, PMX810E-S, PMX810G-S		

fans

axial fans

import





1

GEV No.	601131 ¹	Ref. No.	03-VNR-120.25	
description	axial fan L 119mm W 119mm H 25mm 230VAC 50/60Hz 19/18W bearing ball bearing connection male faston 2.8mm metal ADDA fan wheel ø 110mm temp.-resist. 70°C			
accessories for	601131			
	GEV No.	550898	Ref. No.	—
	connecting cable cable length 2000mm connection F 2.8 connection distance 7.9mm for axial flow fan			

¹with ball bearings



1

GEV No.	601080 ¹	Ref. No.	03-VNR-120.38	
description	axial fan L 119mm W 119mm H 38mm 230VAC 50/60Hz 23/20W bearing ball bearing connection male faston 2.8mm metal ADDA fan wheel ø 110mm temp.-resist. 70°C			
accessories for	601080			
	GEV No.	550898	Ref. No.	—
	connecting cable cable length 2000mm connection F 2.8 connection distance 7.9mm for axial flow fan			
	GEV No.	692519	Ref. No.	—
	guard L 120mm W 120mm plastic			

¹with ball bearings



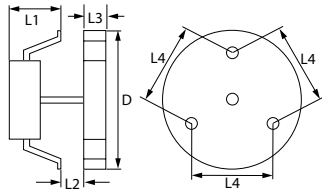

hot air fans

miscellaneous





1	GEV No.	601273	Ref. No.	MOTOVENTILATORE
description	hot air fan 220-240V 32W 50/60Hz L1 60mm L2 10mm L3 25mm L4 87mm fan wheel ø 155mm FIME type C20X0E01/15CLH			



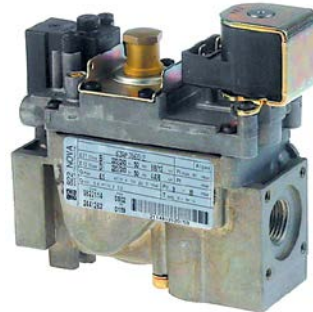



accessories for	101127			
	GEV No.	101303	Ref. No.	—
	gas connection straight thread 3/4" ELETROSIT			
	GEV No.	101309	Ref. No.	—
	extension			

NOVASIT



1	GEV No.	101914	Ref. No.	02-VLV-822
description	gas valve SIT series Novasit 822 230V 50Hz gas inlet 1/2" gas outlet 1/2" thermocouple connection pilot connection closed ignition pressure range 3-30mbar pressure regulator connection blind equiv. no. 0.822.144			

spare parts for	101914			
	GEV No.	101313	Ref. No.	—
	solenoid coil 230V 50Hz			
	GEV No.	101542	Ref. No.	—
	solenoid coil 50Hz NOVA 822/826/827 suitable for NOVASIT 230V			

accessories for	101914			
	GEV No.	101305	Ref. No.	—
	gas connection straight 1/2" flange 45x45mm ELETROSIT/V4400/4600/4605 suitable for SIT/HONEYWELL hole distance 36x36mm			
	GEV No.	101306	Ref. No.	—
	gas connection angled flange 45x45mm hole distance 36x36mm 1/2" ELETROSIT/V4400/4600/4605 screw with O-ring suitable for SIT/HONEYWELL			
	GEV No.	101307	Ref. No.	—
	gas connection straight flange 45x45mm hole distance 36x36mm 3/4" ELETROSIT/V4400/4600/4605 screw with O-ring suitable for SIT/HONEYWELL			
	GEV No.	101308	Ref. No.	—
	gas connection angled flange 45x45mm hole distance 36x36mm 3/4" ELETROSIT/V4400/4600/4605 screw with O-ring suitable for SIT/HONEYWELL			
	GEV No.	101503	Ref. No.	—
	O-ring EPDM thickness 2mm ID ø 32mm Qty 1 pcs			
	GEV No.	101924	Ref. No.	—
	plug with cable L 1090mm suitable for NOVA 822/826/827			

gas valves and ignition boxes

gas control valves

SIT

ELETROSIT



1	GEV No.	101127	Ref. No.	VALVOLA002
description	gas valve SIT type ELETROSIT 230V gas inlet 3/4" gas outlet 3/4" thermocouple connection M9x1 pilot connection M10x1 lateral equiv. no. 0.810.175			

spare parts for	101127			
	GEV No.	101312	Ref. No.	—
	microswitch			
	GEV No.	101352	Ref. No.	—
	solenoid coil 230V 50Hz suitable for ELETROSIT			
accessories for	101127			
	GEV No.	100006	Ref. No.	—
	piezoelectric igniter suitable for ELETROSIT body plastic blowing connection ø2.4mm ø 14mm			
	GEV No.	100904	Ref. No.	—
	locking screw M10x1 for pipe ø 4mm Qty 1 pcs			
	GEV No.	100905	Ref. No.	—
	locking screw M10x1 for pipe ø 6mm Qty 1 pcs			
	GEV No.	101301	Ref. No.	—
	gas connection thread 1/2" straight ELETROSIT screw with O-ring			



ignition boxes

BRAHMA



1			
GEV No.	107471	Ref. No.	02-CNT-001 CONTROLO 001
description	ignition box BRAHMA type CM11 electrodes 2 waiting time 1.5s safety time 10s 230V 7VA 50-60Hz		

ignition parts

pilot burners

producer-specific pilot burners

SOGECO

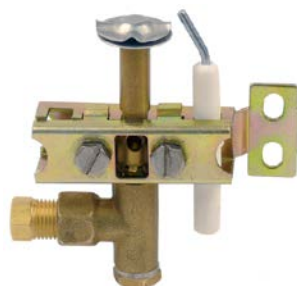

1			
GEV No.	107527	Ref. No.	11-008 FUORIMAGAZZINO
description	pilot burner 3 flames nozzle ø 0.2mm gas connection 6mm		

gas burners

bar burners

bar burners



1			
GEV No.	103153	Ref. No.	02-BRU-2264 Bruciatore 007
description	bar burner ø 50mm Wmm Hmm L 465mm		

equipment-specific units

for convection ovens/combi-steamers

glass panels



1			
GEV No.	694847	Ref. No.	00-TVP-002
description	glass panel L 673mm W 510mm H 5mm		

locks

handle latches

universal

outside fixing

locks







1				
GEV No.	694065	Ref. No.	N/A	
description	door handle for headed units L 145mm W 40mm H 62mm spring length 33mm outer black			
spare parts for	694065			
	GEV No.	514390	Ref. No.	—
	spring for door handle ø 6mm L 54mm W 27.5mm			
	GEV No.	694734	Ref. No.	—
	door handle L 165mm W 40mm H 25mm black			
	GEV No.	694735	Ref. No.	—
	cap ø 32mm black			
accessories for	694065			
	GEV No.	694066	Ref. No.	—
	door catch with spigot 2-stage L 28mm W 14mm H 15mm H1 16mm total length 51mm thread M8 thread L 23mm stainless steel			
	GEV No.	694067	Ref. No.	—
	door catch with spigot 1-stage L 26mm total length 51mm thread M8			

producer-specific

SOGECO





GEV No.	694065	Ref. No.	N/A
description	door handle for headed units L 145mm W 40mm H 62mm spring length 33mm outer black		
spare parts for	694065		
	GEV No.	514390	Ref. No. —
	spring for door handle ϕ 6mm L 54mm W 27.5mm		
	GEV No.	694734	Ref. No. —
	door handle L 165mm W 40mm H 25mm black		
	GEV No.	694735	Ref. No. —
	cap ϕ 32mm black		
accessories for	694065		
	GEV No.	694066	Ref. No. —
	door catch with spigot 2-stage L 28mm W 14mm H 15mm H1 16mm total length 51mm thread M8 thread L 23mm stainless steel		
	GEV No.	694067	Ref. No. —
	door catch with spigot 1-stage L 26mm total length 51mm thread M8		



edgmount latches

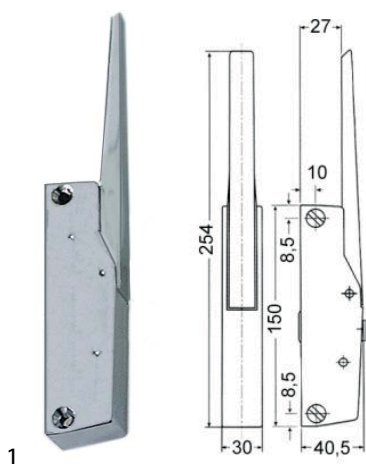

handle latches

CAFF/FERMOD

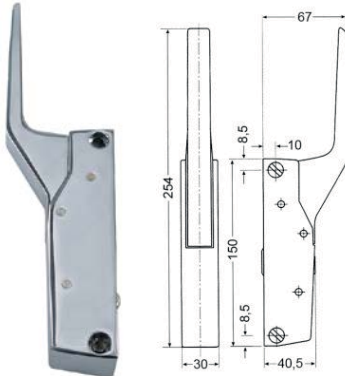

GEV No.	690412	Ref. No.	AGGANCIO001+ CHIUSURA002+
description	handle latch L 150mm mounting distance 133mm non lockable G 790 total length 254mm handle length 105mm		
accessories for	690412		
	GEV No.	690418	Ref. No. —
	door catch L 36mm W 19mm H 29mm mounting distance 12mm zinc-coated steel for refrigeration units		

accessories for	690412		
	GEV No.	690419	Ref. No. —
	door catch L 52mm W 20mm H 30mm mounting distance 26-37mm zamak for refrigeration units		
	GEV No.	700061	Ref. No. AGGANCIO001
	door catch L 58mm W 20mm H 35mm mounting distance 42mm chrome-plated brass for headed units		
	GEV No.	700435	Ref. No. —
	door catch L 58mm W 20mm H 35mm mounting distance 42mm zamak for refrigeration units		

1			
GEV No.	700060	Ref. No.	CHIUSURA002
description	handle latch L 150mm mounting distance 133mm non lockable heated units G 791		
accessories for	700060		
	GEV No.	700061	Ref. No. AGGANCIO001
	door catch L 58mm W 20mm H 35mm mounting distance 42mm chrome-plated brass for headed units		
	GEV No.	700062	Ref. No. —
	handle protection heated units		

door catches



GEV No.	700061	Ref. No.	AGGANCIO001
description	door catch L 58mm W 20mm H 35mm mounting distance 42mm chrome-plated brass for headed units		
accessories for	700061		
	GEV No.	690414	Ref. No. —
	handle latch L 150mm mounting distance 133mm non lockable refrigeration units G 791		

gaskets

gaskets for heated units

window seals

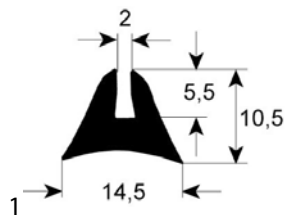

GEV No.	900601	Ref. No.	04-GRN-002 GUARNIZIONE002
description	window gasket profile 1660 Qty supplied by meter		

door seals

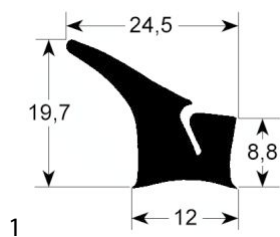

GEV No.	900602	Ref. No.	GUARNIZIONE001
description	door seal profile 2430 Qty supplied by meter		

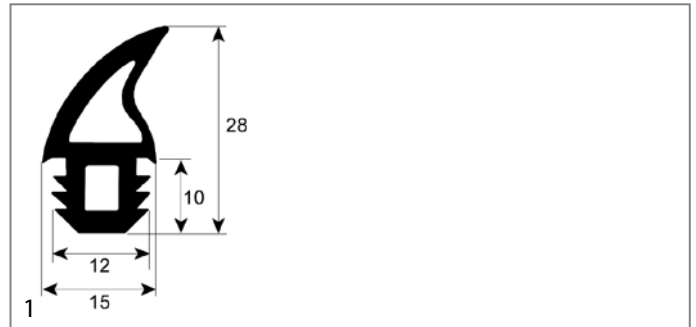

GEV No.	901331	Ref. No.	04-GRN-003
description	door seal profile 2756 Qty supplied by meter		

gaskets for tray rack trolleys

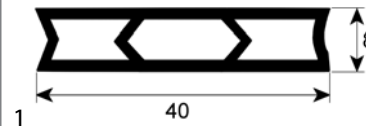

GEV No.	901330	Ref. No.	04-GRN-005
description	tray rack trolley gasket profile 4065 silicone Qty supplied by meter		

A			
alarm devices	5	pressure switches	7
axial fans	7	probes	7
B		programme timers	5
bar burners	9	push/momentary push switches	4
bi-metal thermostats	3, 3	R	
C		relays	6
cam switches	4	S	
contactors	6	switches and momentary switches	4
control equipment	4	T	
control thermostats	3	thermostats	3
D		timers	5
door catches	10	W	
door seals	11	window seals	11
E			
edgemount latches	10		
electric timers	5		
electronic controllers	6		
F			
fans	7		
G			
gas burners	9		
gas control valves	8		
gaskets for heated units	11		
gaskets for tray rack trolleys	11		
H			
handle latches	10		
heating elements	3		
heating elements for convection	3		
hot air fans	8		
I			
ignition boxes	9		
indicator lights	5		
indicator lights (complete)	5		
L			
lamps	5		
M			
mechanical timers	5		
microswitches	4		
P			
pilot burners	9		