



GAS COMPONENTS



ELECTRIC COMPONENTS



WATER TECHNOLOGY



MECHANICAL COMPONENTS



TOOLS

Spare parts suitable for

SOLYMAC

Find the complete and up-to-date range of products in our GEV Webshop



Manufacturer catalogue

The most important spare parts and accessories arranged clearly for every manufacturer

- ✓ Complete product range and all appliance data always up to date in the GEV Webshop
- ✓ Alphabetical Index at the end of the catalogue

GEV Webshop

www.gev-online.co.uk

www.gev-online.com









- 🔍 Add to Favourites
- 🔍 Sign In with email address and usual password
- 🔍 Easy-order – place several items in your basket at the same time
- 🔍 Quick Item search – no login needed



heating elements

heating elements for bain maries

			
GEV No.	418448	Ref. No.	P31
description	heating element 900W 230V heating circuits 1 L 367mm W 122mm connection M4 tube ø 8.5mm 2 hole fixing thread M14x1 dry heating element bain marie mounting distance 113mm		
spare parts for	418448		
	GEV No.	510417	Ref. No. —
	flat gasket fibre ED ø 20mm ID ø 14mm thickness 2mm Qty 1 pcs		
	GEV No.	550261	Ref. No. —
	nut thread M14x1 H 4mm WS 19 SS Qty 1 pcs		
accessories for	418448		
	GEV No.	520228	Ref. No. —
	tooth lock washer ID ø 15.3mm ED ø 24mm steel Qty 1 pcs for thread M14		
	GEV No.	550262	Ref. No. —
	flat gasket copper ED ø 20mm ID ø 14mm thickness 2mm		

			
GEV No.	420186	Ref. No.	P40
description	heating element 7000W 230V heating circuits 3 L 393mm W 245mm H 210mm L1 78mm L2 315mm W1 78mm W2 84mm special fixing tube ø 8mm fryer heaters		

heating elements for griddles

			
GEV No.	418451	Ref. No.	P37
description	heating element 1666W 230V heating circuits 1 L 435mm W 60mm H 74mm tube ø 8.5mm 2 hole fixing connection M4 thread M14x1.5 mounting distance 52mm connection length 72mm for griddle dry heating element		

heating elements for fryers



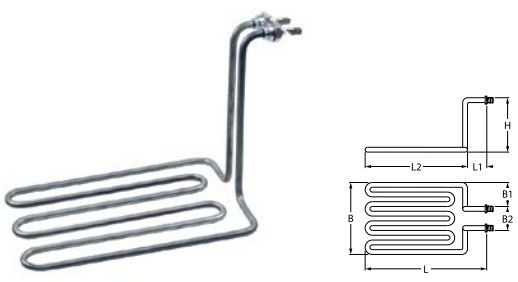



2 hole fixing

			
GEV No.	420184	Ref. No.	P59
description	heating element 3500W 230V heating circuits 1 L 294mm W 170mm H 208mm 2 hole fixing connection male faston 6.3mm fryer heaters L1 27mm L2 267mm W1 67mm W2 36mm tube ø 8mm thread M14x1.5 mounting distance 28mm windings 3 suitable for SOLYMAC		

heating elements for pasta cookers

			
GEV No.	420187	Ref. No.	P34B
description	heating element 2000W 230V heating circuits 1 L 405mm W 46mm H 5mm 2 hole fixing connection M4 thread M12x1.25 tube ø 8.3mm		

heating elements for pizza ovens

			
GEV No.	418450	Ref. No.	P48B
description	heating element 1200W 230V L 656mm W 110mm thread M14x1.5 mounting distance 102mm connection length 90mm connection M4 tube ø 8.5mm heating circuits 1 dry heating element 2 hole fixing		
accessories for	418450		
	GEV No.	510417	Ref. No. —
	flat gasket fibre ED ø 20mm ID ø 14mm thickness 2mm Qty 1 pcs		
	GEV No.	520228	Ref. No. —
	tooth lock washer ID ø 15.3mm ED ø 24mm steel Qty 1 pcs for thread M14		
	GEV No.	520230	Ref. No. —
	nut thread M14x1.5 H 5mm WS 19 zinc-coated steel Qty 1 pcs		
	GEV No.	521101	Ref. No. —
	nut thread M14x1.5 H 5mm WS 19 SS Qty 1 pcs		
	GEV No.	550262	Ref. No. —
	flat gasket copper ED ø 20mm ID ø 14mm thickness 2mm		





group 11

			
GEV No.	420185	Ref. No.	P41
description	heating element 12000W 230V heating circuits 3 L 415mm W 237mm H 213mm L1 85mm L2 330mm W1 80mm W2 77mm special fixing tube ø 8mm fryer heaters		

GEV No.	420183	Ref. No.	P33
description	heating element 1200W 230V L 785mm W 120mm thread M14x1.5 mounting distance 111.5mm connection M4 tube ø 8.5mm heating circuits 1 dry heating element 2 hole fixing for pizza oven		



GEV No.	418449	Ref. No.	P48A
description	heating element 800W 230V L 682mm W 102mm thread M14x1.5 mounting distance 94mm connection length 82mm connection M4 tube ø 8.5mm heating circuits 1 dry heating element 2 hole fixing		
accessories for	418449		
	GEV No.	510417	Ref. No. —
	flat gasket fibre ED ø 20mm ID ø 14mm thickness 2mm Qty 1 pcs		
	GEV No.	520228	Ref. No. —
	tooth lock washer ID ø 15.3mm ED ø 24mm steel Qty 1 pcs for thread M14		
	GEV No.	520230	Ref. No. —
	nut thread M14x1.5 H 5mm WS 19 zinc-coated steel Qty 1 pcs		
	GEV No.	521101	Ref. No. —
	nut thread M14x1.5 H 5mm WS 19 SS Qty 1 pcs		
	GEV No.	550262	Ref. No. —
	flat gasket copper ED ø 20mm ID ø 14mm thickness 2mm		



GEV No.	418447	Ref. No.	P30
description	heating element 900W 230V L 538mm W 88mm thread M14x1.5 mounting distance 80mm connection length 40mm connection M4 heating circuits 1 dry heating element 2 hole fixing		

heating elements for salamanders/toast-





GEV No.	418452	Ref. No.	P35
description	heating element 1165W 230V L 392mm W 66mm 2 hole fixing thread M12x1.5 mounting distance 60mm connection M4 dry heating element tube ø 6.3mm salamander grill		

ceramic heaters

245x60mm



GEV No.	415104	Ref. No.	P1169
description	ceramic emitter 1000W 230V cable beaded cord L 245mm W 60mm H 35mm		
spare parts for	415104		
	GEV No.	415109	Ref. No. —
	spring clip		
accessories for	415104		
	GEV No.	415110	Ref. No. —
	reflector L 245mm W 95mm H 31mm thickness 0.75mm hole ø 15x40mm		

immersion heating elements

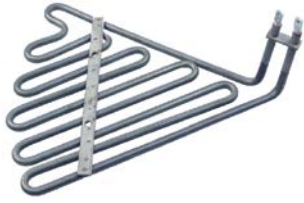

GEV No.	420188	Ref. No.	P47
description	heating element 3000W 230V heating circuits 1 L 350mm W 300mm connection M4 tube ø 10mm immersion heater for bain marie H 100mm connection distance 25mm		



GEV No.	418446	Ref. No.	P34
description	heating element 900W 230V heating circuits 1 L 420mm W 45mm thread M12x1 mounting distance 36mm tube ø 8.5mm 2 hole fixing immersion heater		



radiation heaters

square



1	GEV No.	490008	Ref. No.	P55
description	radiation heater L 300mm W 300mm 4000W 400V heating circuits 2 connections 3 square connection type male faston 6.3mm without pan detection EGO			
spare parts for	490008			
	GEV No.	499157	Ref. No.	—
	protection pipe for temperature probe ceramic L 297mm ED ø 7mm ID ø 5mm			

accessories



1	GEV No.	514493	Ref. No.	P604B+P604C+P604D
description	buffer suitable for heating element hole ø 11mm ø 315mm			

hot plates

round

with radiused edge

for domestic and commercial kitchens



1	GEV No.	490020	Ref. No.	P49B
description	hot plate ø 220mm 2600W 230V connection 4 screw clamps with 8mm spill ring			
accessories for	490020			
	GEV No.	550796	Ref. No.	—
	fixing plate for hot plate ø220mm			



1	GEV No.	490021	Ref. No.	P49A
description	hot plate ø 220mm 2600W 400V connection 4 screw clamps with 8mm spill ring			

energy regulators

EGO

1-circuit



1	GEV No.	380015	Ref. No.	P82
description	energy regulator 230V 13A single-circuit turn direction right shaft ø 6x4.6mm shaft L 23mm mounting thread M4 power release 6-100% no. 50.57021.010			

DIAMOND



1	GEV No.	380037	Ref. No.	P82
description	energy regulator 240V 13.5A turn direction right shaft ø 6x4.6mm shaft L 13mm mounting thread 3/8"-24UNF equiv. no. 35ERE101230V			



1	GEV No.	380038	Ref. No.	160210
description	energy regulator 24V 13.5A turn direction right shaft ø 6x4.6mm mounting thread 3/8"-24UNF equiv. no. 35ERE105024V voltage AC			

accessories

knobs



1	GEV No.	110075	Ref. No.	P82A
description	knob energy regulator 1-3 t.max.°C ø 50mm shaft ø 6x4.6mm shaft flat upper black			
accessories for	110075			
	GEV No.	110135	Ref. No.	—
	rosette knob up to ø 52mm			



thermostats

control and safety thermostats

EGO

control thermostats

55.10/19_series



GEV No.	375468	Ref. No.	P77
----------------	--------	-----------------	-----

description	thermostat t.max. 180°C temperature range 80-180°C 1-pole 1NO 16A probe ø 6mm probe L 135mm capillary pipe 900mm capillary pipe isolatedmm gland nut M9x1 shaft ø 6x4.6mm shaft L 23mm shaft position upper rotation 270°
--------------------	---

55.34_series



GEV No.	375143	Ref. No.	P76
----------------	--------	-----------------	-----

description	thermostat t.max. 110°C temperature range 32-110°C 3-pole 3NO 16A probe ø 6mm probe L 138mm capillary pipe 1480mm capillary pipe isolated 1100mm gland nut M9x1 shaft ø 6x4.6mm shaft L 23mm shaft position upper rotation 270°
--------------------	---



GEV No.	375417	Ref. No.	P77A
----------------	--------	-----------------	------

description	thermostat t.max. 200°C temperature range 65-200°C 3-pole 3NO 16A probe ø 6mm probe L 79mm capillary pipe 840mm capillary pipe isolatedmm gland nut M9x1 shaft ø 6x4.6mm shaft L 23mm rotation 270°
--------------------	---



GEV No.	375038	Ref. No.	P79
----------------	--------	-----------------	-----

description	thermostat t.max. 300°C temperature range 50-300°C 3-pole 3NO 16A probe ø 6mm probe L 79mm capillary pipe 1740mm capillary pipe isolated 800mm gland nut shaft ø 6x4.6mm shaft L 23mm shaft position upper rotation 270°
--------------------	--

accessories for	375038
------------------------	--------



GEV No.	110123	Ref. No.	—
description	knob thermostat t.max. 300°C ø 50mm shaft ø 6x4.6mm shaft flat upper black temperature range 50-300°C rotation 270°		



GEV No.	375026	Ref. No.	P80
----------------	--------	-----------------	-----

description	thermostat t.max. 350°C temperature range 100-350°C 3-pole 3NO 16A probe ø 6mm probe L 77mm capillary pipe 2430mm capillary pipe isolated 1100mm gland nut shaft ø 6x4.6mm shaft L 23mm shaft position upper rotation 270°
--------------------	--



GEV No.	390038	Ref. No.	P76ET
----------------	--------	-----------------	-------

description	thermostat t.max. 90°C temperature range 30-90°C 3-pole 3CO 16A probe ø 6mm probe L 215mm capillary pipe 900mm capillary pipe isolatedmm gland nut shaft Lmm
--------------------	--



safety thermostats

56_ series



GEV No.	375432	Ref. No.	P78
----------------	--------	-----------------	-----

description safety thermostat switch-off temp. 230°C 1-pole 1NC 16A probe ø 6mm probe L 77mm capillary pipe 1160mm capillary pipe isolated 210mm gland nut M9x1 starting temperature 218°C probe

accessories for 375432

GEV No.	101860	Ref. No.	—
----------------	--------	-----------------	---



nut thread M10x1 H 4mm WS 14 chrome-plated brass Qty 1 pcs

control thermostats with operation switch

55.34_ series

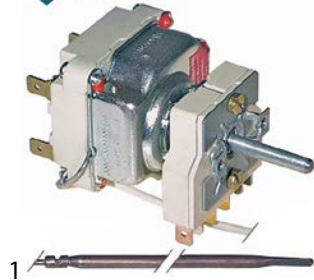

GEV No.	375246	Ref. No.	P709
----------------	--------	-----------------	------

description thermostat t.max. 645°C temperature range 100-615/645°C 2-pole 2NO 16A probe ø 4mm probe L 230mm capillary pipe 1100mm capillary pipe isolated 600mm gland nut shaft ø 6x4.6mm shaft L 25mm shaft position lower rotation 270° outer switch 2NO probe material copper

CAEM

safety thermostats



GEV No.	390877	Ref. No.	P1006
----------------	--------	-----------------	-------

description safety thermostat switch-off temp. 225°C 1-pole NC 16A probe ø 5mm probe L 80mm capillary pipe 900mm capillary pipe isolated 400mm gland nut M10x1 probe SS connection male faston 6.3mm

switches and momentary switches

rocker/momentary rocker switches

30x22mm



GEV No.	301135	Ref. No.	P67E
description	momentary rocker switch mounting measurements 30x22mm orange 2NO 24V 16A illuminated connection male faston 6.3mm ambient temperature max. 100/55°C protection IP40		

cam switches

4-position



GEV No.	300103	Ref. No.	P86C
description	cam switch 4 operating positions 1NO/2CO sequence 0-1-2-3 32A shaft ø 6x4.6mm shaft L 23mm connection screw ceramic		

7-position



GEV No.	300025	Ref. No.	P87
description	cam switch 7 operating positions 1NO/2CO sequence 0-1-2-3-4-5-6 16A shaft ø 6x4.6mm shaft L 23mm connection screw 7-position ceramic		

accessories for 300025



GEV No.	112172	Ref. No.	—
description	knob universal ø 70mm black without adaptor/dial plate		
GEV No.	112213	Ref. No.	—
description	knob dial plate silver switch 7-position t.max.°C ED ø 63mm ID ø 45.5mm		
GEV No.	112311	Ref. No.	—
description	knob adapter shaft ø 6x4.6mm L 0mm with spring		

control equipment

lamps





1

GEV No.	359606	Ref. No.	P91A
description	neon light bulb socket Ba9s 220V 2W clear ø 10mm L 28mm		
accessories for	359606		
	GEV No.	359832	Ref. No. —
	GEV No.	359853	Ref. No. —



1

GEV No.	359607	Ref. No.	P91
description	neon light bulb socket Ba9s 380V 2W clear ø 10mm L 28mm		
accessories for	359607		
	GEV No.	359060	Ref. No. —
	GEV No.	359063	Ref. No. —
	GEV No.	359064	Ref. No. —
	GEV No.	359685	Ref. No. —
	GEV No.	359832	Ref. No. —
	GEV No.	359853	Ref. No. —
	GEV No.	359988	Ref. No. —

lamps

indicator lights



indicator lights 3-piece (housing, lens and bulb)

lamps

neon light bulbs









1

GEV No.	359606	Ref. No.	P91A
description	neon light bulb socket Ba9s 220V 2W clear ø 10mm L 28mm		
accessories for	359606		
	GEV No.	359832	Ref. No. —
	GEV No.	359853	Ref. No. —



1

GEV No.	359607	Ref. No.	P91
description	neon light bulb socket Ba9s 380V 2W clear ø 10mm L 28mm		
accessories for	359607		
	GEV No.	359060	Ref. No. —
	GEV No.	359063	Ref. No. —
	GEV No.	359064	Ref. No. —
	GEV No.	359685	Ref. No. —
	GEV No.	359832	Ref. No. —
	GEV No.	359853	Ref. No. —
	GEV No.	359988	Ref. No. —



screw-on/push-on fit

neon light bulbs



1

GEV No.	359606	Ref. No.	P91A
description	neon light bulb socket Ba9s 220V 2W clear ø 10mm L 28mm		
accessories for	359606		
	GEV No.	359832	Ref. No. —
	lamp socket mounting measurements ø16.2mm socket Ba9s connection male faston 6.3mm		
	GEV No.	359853	Ref. No. —
	lamp socket mounting measurements ø18.2mm socket Ba9s connection male faston 6.3mm		



1

GEV No.	359607	Ref. No.	P91
description	neon light bulb socket Ba9s 380V 2W clear ø 10mm L 28mm		
accessories for	359607		
	GEV No.	359060	Ref. No. —
	lamp socket mounting measurements ø16.2mm socket E10 connection screw		
	GEV No.	359063	Ref. No. —
	lamp socket mounting measurements ø19.2mm socket E14 connection screw		
	GEV No.	359064	Ref. No. —
	lamp socket mounting measurements ø22.3mm socket E14 connection screw 250/380V ambient temperature at 1W 100°C ambient temperature at 2W 85°C		
	GEV No.	359685	Ref. No. —
	lamp socket mounting measurements ø16.2mm socket E10		
	GEV No.	359832	Ref. No. —
	lamp socket mounting measurements ø16.2mm socket Ba9s connection male faston 6.3mm		
	GEV No.	359853	Ref. No. —
	lamp socket mounting measurements ø18.2mm socket Ba9s connection male faston 6.3mm		
	GEV No.	359988	Ref. No. —
	lamp socket mounting measurements ø30.5mm 250V connection F6.3 temp.-resist. 55°C E14		

light bulbs

for ovens



1

GEV No.	359612	Ref. No.	AMPF
description	light bulb t.max. 300°C socket E14 25W 230V ø 25mm L 56mm lens L 30mm for oven lamp type Philips		

oven lamps

lamps

light bulbs



1

GEV No.	359612	Ref. No.	AMPF
description	light bulb t.max. 300°C socket E14 25W 230V ø 25mm L 56mm lens L 30mm for oven lamp type Philips		

electronic controllers

HONEYWELL

universal controllers

built-in version



1

GEV No.	379877	Ref. No.	P81A
description	electronic controller HONEYWELL type DC10N-400 mounting measurements 92x92mm 24/230V voltage AC TC (J) relay outputs 1 CO-10A(6) TC (J) universal built-in depth 55mm protection IP54 accuracy 1% built-in version defr. funct. no 0 up to +400°C display 3 digits		
accessories for	379877		
	GEV No.	379051	Ref. No. FS10
	temperature probe thermocouple J (Fe-CuNi) cable Vetrotex probe -50 up to +750°C cable -50 up to +350°C probe ø6x100mm cable length 3m without screw connection cable colours red/blue 2-wire		



probes

universal probes

temperature probes



GEV No.	375051	Ref. No.	N/A
description	temperature probe thermocouple J (Fe-CuNi) cable Vetrotex probe -50 up to +750°C cable -50 up to +350°C probe ø4x150mm cable length 1.5m 2-wire		



GEV No.	379051	Ref. No.	FS10
description	temperature probe thermocouple J (Fe-CuNi) cable Vetrotex probe -50 up to +750°C cable -50 up to +350°C probe ø6x100mm cable length 3m without screw connection cable colours red/blue 2-wire		

accessories for	379051		
	GEV No.	379877	Ref. No. P81A
	electronic controller HONEYWELL type DC10N-400 mounting measurements 92x92mm 24/230V voltage AC TC (J) relay outputs 1 CO-10A(6) TC (J) universal built-in depth 55mm protection IP54 accuracy 1% built-in version defr. funct. no 0 up to +400°C display 3 digits		

keypads

front foils



GEV No.	403015	Ref. No.	CFRPC10X
description	keypad foil L 167mm W 99mm		

solenoïd valves

solenoïd valves (water)

metal

PARKER

3-way

VE-128 series





GEV No.	370057	Ref. No.	P74A
description	solenoïd valve 3-ways 230VAC body outer cone DN 1.2mm slide-on receptacle DIN -20° up to 140°C PARKER type series VE-128 coil type ZB09 membranes ruby p max 10bar brass flange 32x32mm		

spare parts for	370057		
	GEV No.	370062	Ref. No. —
	solenoïd valve body PARKER 3-ways outer cone		

	GEV No.	371029	Ref. No. —
	solenoïd coil PARKER 230VAC 9VA coil type ZB09 seat ø 14mm H 33mm W 34mm D 43mm		

accessories for	370057		
	GEV No.	371090	Ref. No. —
	power socket plug type DIN 43650A screw		

	GEV No.	371095	Ref. No. —
	O-ring Viton thickness 1.78mm ID ø 6.07mm Qty 1 pcs		

	GEV No.	371100	Ref. No. —
	O-ring silicone thickness 1.78mm ID ø 6.07mm Qty 1 pcs		



fans

hot air fans

miscellaneous



1

GEV No.	601125	Ref. No.	EMMVR150
description	hot air fan 220-240V 45W 50/60Hz L1 70mm L2 11mm L3 25mm L4 87mm fan wheel ø 150mm FIME type C30R0479CLF		
accessories for	601125		
	GEV No.	550879	Ref. No. —
	insulation ø 130mm thickness 3mm hole ø 20mm for hot air fan		

condensators & interference suppression filters

operating capacitors

metal



1

GEV No.	365002	Ref. No.	FS16
description	operating capacitor capacity 4µF 400V tolerance 5% 50/60Hz ambient temperature max. -25 to +85°C ø 30mm L 75mm with cable M8 aluminium connection cable 300mm MKP protection IP65		

gas taps

PEL

20N series



1

GEV No.	101398	Ref. No.	P66D
description	gas tap PEL type 20N gas inlet M16x1.5 (tube ø 10mm) bypass nozzle ø 0.35mm gas outlet M16x1.5 (tube ø 10/8mm) thermocouple connection pilot connection M10x1 shaft ø 8x6.5mm shaft L 22/15mm shaft flat upper		
spare parts for	101398		
	GEV No.	100408	Ref. No. —
	bypass nozzle type PEL20/21 bore ø 0.35mm thread M5x0.5		
	GEV No.	101205	Ref. No. —
	gas tap front part shaft ø 8x6.5mm shaft L 22/15mm shaft flat upper/lower suitable for PEL20		
accessories for	101398		
	GEV No.	101278	Ref. No. —
	olive for pipe ø 10mm Qty 1 pcs		
	GEV No.	101300	Ref. No. —
	union nut thread M16x1.5 tube ø 10mm		
	GEV No.	101450	Ref. No. —
	olive for pipe ø 8mm L 12.7mm Qty 1 pcs ED ø 10mm		
	GEV No.	101451	Ref. No. —
	union nut thread M16x1.5 tube ø 8mm		
	GEV No.	110081	Ref. No. —
	knob ø 70mm shaft ø 8x6.5mm shaft flat universal		
	GEV No.	110083	Ref. No. —
	knob dial plate gas tap without ignition flame silver		

20S series



1









GEV No.	101491	Ref. No.	P67E
description	gas tap PEL type 20S gas inlet M16x1.5 (tube ø 10mm) bypass nozzle ø 0.35mm gas outlet M16x1.5 (tube ø 10/8mm) thermocouple connection M9x1 pilot connection shaft ø 8x6.5mm shaft L 22/15mm shaft flat lower		
spare parts for	101491		
	GEV No.	100408	Ref. No. —
	bypass nozzle type PEL20/21 bore ø 0.35mm thread M5x0.5		

Table continues overleaf

spare parts for		101491		
	GEV No.	101060	Ref. No.	—
magnet unit standard L 39mm D1 ø 15.4mm D2 ø 11mm suitable for PEL20-21/JUNKERS/EGA				
	GEV No.	101205	Ref. No.	—
gas tap front part shaft ø 8x6.5mm shaft L 22/15mm shaft flat upper/lower suitable for PEL20				
	GEV No.	101231	Ref. No.	—
thermocouple nut T1: M9x1 T2: M18x1				
accessories for		101491		
	GEV No.	101287	Ref. No.	—
olive for pipe ø 6mm Qty 1 pcs				
	GEV No.	101300	Ref. No.	—
union nut thread M16x1.5 tube ø 10mm				
	GEV No.	101450	Ref. No.	—
olive for pipe ø 8mm L 12.7mm Qty 1 pcs ED ø 10mm				
	GEV No.	101451	Ref. No.	—
union nut thread M16x1.5 tube ø 8mm				
	GEV No.	110081	Ref. No.	—
knob ø 70mm shaft ø 8x6.5mm shaft flat universal				
	GEV No.	110083	Ref. No.	—
knob dial plate gas tap without ignition flame silver				

21S series

 <p>1</p>				
GEV No.	101397	Ref. No.	P67C	
description	gas tap PEL type 21S gas inlet M16x1.5 (tube ø 10mm) bypass nozzle ø 0.35mm gas outlet M16x1.5 (tube ø 10/8mm) thermocouple connection M9x1 pilot connection M10x1 shaft ø 8x6.5mm shaft L 22/15mm shaft flat lower			
spare parts for		101397		
	GEV No.	100408	Ref. No.	—
bypass nozzle type PEL20/21 bore ø 0.35mm thread M5x0.5				
	GEV No.	101060	Ref. No.	—
magnet unit standard L 39mm D1 ø 15.4mm D2 ø 11mm suitable for PEL20-21/JUNKERS/EGA				
	GEV No.	101206	Ref. No.	—
gas tap front part shaft ø 8x6.5mm shaft L 22/15mm shaft flat upper/lower suitable for PEL21				
	GEV No.	101231	Ref. No.	—
thermocouple nut T1: M9x1 T2: M18x1				
accessories for		101397		
	GEV No.	100908	Ref. No.	—
union screw thread M10x1 for pipe ø 4mm Qty 1 pcs				

accessories for		101397		
	GEV No.	100909	Ref. No.	—
union screw thread M10x1 for pipe ø 6mm Qty 1 pcs				
	GEV No.	101246	Ref. No.	—
olive for pipe ø 4mm Qty 1 pcs				
	GEV No.	101278	Ref. No.	—
olive for pipe ø 10mm Qty 1 pcs				
	GEV No.	101286	Ref. No.	—
olive ID ø 6mm Qty 1 pcs				
	GEV No.	101300	Ref. No.	—
union nut thread M16x1.5 tube ø 10mm				
	GEV No.	101450	Ref. No.	—
olive for pipe ø 8mm L 12.7mm Qty 1 pcs ED ø 10mm				
	GEV No.	101451	Ref. No.	—
union nut thread M16x1.5 tube ø 8mm				
	GEV No.	110081	Ref. No.	—
knob ø 70mm shaft ø 8x6.5mm shaft flat universal				
	GEV No.	112206	Ref. No.	—
knob dial plate silver gas tap PEL21/22/23 t.max.°C ED ø 63mm ID ø 45.5mm				

22N/O series

















 <p>1</p>				
GEV No.	101443	Ref. No.	P66C	
description	gas tap PEL type 22N/O gas inlet M20x1.5 (tube ø 12mm) bypass nozzle ø 0.35mm gas outlet M20x1.5 (tube ø 12/10mm) thermocouple connection pilot connection M10x1 shaft ø 10x8mm shaft L 25/17mm shaft flat lower			
spare parts for		101443		
	GEV No.	100259	Ref. No.	—
bypass nozzle type PEL22 bore ø 0.35mm thread M6x0.5				
	GEV No.	101201	Ref. No.	—
gas tap front part shaft ø 10x8mm shaft L 25/17mm shaft flat upper/lower suitable for PEL22				
	GEV No.	101240	Ref. No.	—
gas connection thread M20x1.5 tube ø 12/10mm for PEL gas taps with gasket and screws horizontal				
	GEV No.	101460	Ref. No.	—
O-ring ø 12.37mm D1 ø 2.62mm suitable for PEL22				
	GEV No.	101461	Ref. No.	—
screw kit suitable for PEL22 Qty 4 pcs				

Table continues overleaf











accessories for		101443		
	GEV No.	100908	Ref. No.	—
union screw thread M10x1 for pipe ø 4mm Qty 1 pcs				
	GEV No.	100909	Ref. No.	—
union screw thread M10x1 for pipe ø 6mm Qty 1 pcs				
	GEV No.	101246	Ref. No.	—
olive for pipe ø 4mm Qty 1 pcs				
	GEV No.	101248	Ref. No.	—
olive for pipe ø 12mm Qty 1 pcs suitable for PEL				
	GEV No.	101249	Ref. No.	—
olive for pipe ø 10mm Qty 1 pcs				
	GEV No.	101250	Ref. No.	—
union nut thread M20x1.5 for pipe ø 10mm				
	GEV No.	101251	Ref. No.	—
union nut thread M20x1.5 for pipe ø 12mm				
	GEV No.	101286	Ref. No.	—
olive ID ø 6mm Qty 1 pcs				

accessories for		101086		
	GEV No.	100908	Ref. No.	—
union screw thread M10x1 for pipe ø 4mm Qty 1 pcs				
	GEV No.	100909	Ref. No.	—
union screw thread M10x1 for pipe ø 6mm Qty 1 pcs				
	GEV No.	101241	Ref. No.	—
gas connection thread M20x1.5 tube ø 12/10mm for PEL gas taps vertical				
	GEV No.	101246	Ref. No.	—
olive for pipe ø 4mm Qty 1 pcs				
	GEV No.	101248	Ref. No.	—
olive for pipe ø 12mm Qty 1 pcs suitable for PEL				
	GEV No.	101249	Ref. No.	—
olive for pipe ø 10mm Qty 1 pcs				
	GEV No.	101250	Ref. No.	—
union nut thread M20x1.5 for pipe ø 10mm				
	GEV No.	101251	Ref. No.	—
union nut thread M20x1.5 for pipe ø 12mm				
	GEV No.	101286	Ref. No.	—
olive ID ø 6mm Qty 1 pcs				
	GEV No.	110080	Ref. No.	—
knob ø 70mm shaft ø 10x8mm shaft flat universal				
	GEV No.	112206	Ref. No.	—
knob dial plate silver gas tap PEL21/22/23 t.max.°C ED ø 63mm ID ø 45.5mm				

22S/O series



1				
GEV No.	101086	Ref. No.	P67	
description	gas tap PEL type 22S/O gas inlet M20x1.5 (tube ø 12mm) bypass nozzle ø 0.35mm gas outlet M20x1.5 (tube ø 12/10mm) thermocouple connection M9x1 pilot connection M10x1 shaft ø 10x8mm shaft L 25/17mm shaft flat lower			
spare parts for	101086			
	GEV No.	100259	Ref. No.	—
bypass nozzle type PEL22 bore ø 0.35mm thread M6x0.5				
	GEV No.	101058	Ref. No.	—
magnet unit L 39mm D1 ø 15.4mm D2 ø 13.5mm suitable for PEL22/EGA24197 standard				
	GEV No.	101201	Ref. No.	—
gas tap front part shaft ø 10x8mm shaft L 25/17mm shaft flat upper/lower suitable for PEL22				
	GEV No.	101231	Ref. No.	—
thermocouple nut T1: M9x1 T2: M18x1				
	GEV No.	101240	Ref. No.	—
gas connection thread M20x1.5 tube ø 12/10mm for PEL gas taps with gasket and screws horizontal				
	GEV No.	101460	Ref. No.	—
O-ring ø 12.37mm D1 ø 2.62mm suitable for PEL22				
	GEV No.	101461	Ref. No.	—
screw kit suitable for PEL22 Qty 4 pcs				





1				
GEV No.	106384	Ref. No.	P67B	
description	gas tap PEL type 22S/O gas inlet M20x1.5 (tube ø 12mm) bypass nozzle ø 0mm gas outlet M20x1.5 (tube ø 12/10mm) thermocouple connection M9x1 pilot connection M10x1 shaft ø 10x8mm shaft L 25/17mm shaft flat lower			
spare parts for	106384			
	GEV No.	101058	Ref. No.	—
magnet unit L 39mm D1 ø 15.4mm D2 ø 13.5mm suitable for PEL22/EGA24197 standard				
	GEV No.	101231	Ref. No.	—
thermocouple nut T1: M9x1 T2: M18x1				
	GEV No.	106191	Ref. No.	—
bypass nozzle type PEL22 bore ø 0mm thread M6x0.5				

Table continues overleaf

accessories for		106384		
GEV No.	101248	Ref. No.	—	
	olive for pipe ø 12mm Qty 1 pcs suitable for PEL			
GEV No.	101249	Ref. No.	—	
	olive for pipe ø 10mm Qty 1 pcs			
GEV No.	101250	Ref. No.	—	
	union nut thread M20x1.5 for pipe ø 10mm			
GEV No.	101251	Ref. No.	—	
	union nut thread M20x1.5 for pipe ø 12mm			

accessories for		109510		
GEV No.	101249	Ref. No.	—	
	olive for pipe ø 10mm Qty 1 pcs			
GEV No.	101250	Ref. No.	—	
	union nut thread M20x1.5 for pipe ø 10mm			
GEV No.	101251	Ref. No.	—	
	union nut thread M20x1.5 for pipe ø 12mm			
GEV No.	101286	Ref. No.	—	
	olive ID ø 6mm Qty 1 pcs			

1				
GEV No.	109510	Ref. No.	P67	
description	gas tap PEL type 225/O gas inlet M20x1.5 (tube ø 12mm) bypass nozzle ø 1.3mm gas outlet M20x1.5 (tube ø 12/10mm) thermocouple connection M8x1 pilot connection M10x1 shaft ø 10x8mm shaft L 25/17mm shaft flat right			
spare parts for	109510			
	GEV No.	100438	Ref. No.	—
	bypass nozzle type PEL22 bore ø 1.2mm thread M6x0.5			
	GEV No.	101058	Ref. No.	—
	magnet unit L 39mm D1 ø 15.4mm D2 ø 13.5mm suitable for PEL22/EGA24197 standard			
	GEV No.	101202	Ref. No.	—
	gas tap front part shaft ø 8x10mm shaft L 25/17mm shaft flat right/left suitable for PEL22			
	GEV No.	101230	Ref. No.	—
	thermocouple nut T1: M8x1 T2: M18x1 aluminium			
	GEV No.	101240	Ref. No.	—
	gas connection thread M20x1.5 tube ø 12/10mm for PEL gas taps with gasket and screws horizontal			
	GEV No.	101460	Ref. No.	—
	O-ring ø 12.37mm D1 ø 2.62mm suitable for PEL22			
	GEV No.	101461	Ref. No.	—
	screw kit suitable for PEL22 Qty 4 pcs			
accessories for		109510		
	GEV No.	100908	Ref. No.	—
	union screw thread M10x1 for pipe ø 4mm Qty 1 pcs			
	GEV No.	100909	Ref. No.	—
	union screw thread M10x1 for pipe ø 6mm Qty 1 pcs			
	GEV No.	101241	Ref. No.	—
	gas connection thread M20x1.5 tube ø 12/10mm for PEL gas taps vertical			
	GEV No.	101246	Ref. No.	—
	olive for pipe ø 4mm Qty 1 pcs			
	GEV No.	101248	Ref. No.	—
	olive for pipe ø 12mm Qty 1 pcs suitable for PEL			

STN3R

1				
GEV No.	106178	Ref. No.	P66A	
description	gas tap STN3R gas inlet 3/8" (tube ø 10mm) bypass nozzle ø 0mm gas outlet 3/8" (tube ø 12mm) thermocouple connection pilot connection closed shaft ø 10x8mm shaft L 22/18mm shaft flat lower suitable for SOLYMAC			

1				
GEV No.	106179	Ref. No.	P66B	
description	gas tap STN3R gas inlet 3/8" (tube ø 8mm) gas outlet 3/8" (tube ø 8mm) shaft ø 8x10mm shaft L 60mm shaft flat lower suitable for SOLYMAC pilot connection M10x1 closed			





gas thermostats





SIT

710 Minisit series

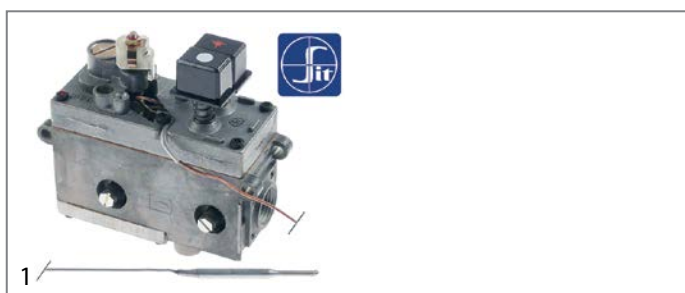

GEV No.	106931	Ref. No.	P68A
description	gas thermostat SIT type MINISIT 710 t.max. 310°C 70-310°C gas inlet 1/2" gas outlet 3/8" thermocouple connection M9x1 pilot connection M10x1 probe ø 4mm probe L 72mm capillary pipe 1300mm pressure controller no pressure regulator mbar gland nut 0710647 ignition gas 6mm probe material stainless steel		
accessories for	106931		
	GEV No.	101137	Ref. No. —
	cover cap without piezoelectric igniter		
	GEV No.	110068	Ref. No. P72E
	knob suitable for Minisit ø 37mm		



GEV No.	101132	Ref. No.	P68A
description	gas thermostat SIT type MINISIT 710 t.max. 340°C 100-340°C gas inlet 1/2" gas outlet 3/8" thermocouple connection M9x1 pilot connection M10x1 probe ø 5mm probe L 68mm capillary pipe 1050mm probe type type B1 pressure controller no pressure regulator mbar gland nut ignition gas no		
spare parts for	101132		
	GEV No.	101053	Ref. No. —
	magnet unit T1: M9x1 T2: M24x1 L 45mm ø 17mm suitable for Minisit		
	GEV No.	102102	Ref. No. —
	probe 100-340°C probe ø 5mm probe L 68mm capillary pipe 1750mm t.max. 340°C oven/grill probe type type B1 suitable for MINISIT 710		
accessories for	101132		
	GEV No.	100809	Ref. No. —
	O-ring EPDM thickness 2mm ID ø 21mm Qty 1 pcs		
	GEV No.	100904	Ref. No. —
	locking screw M10x1 for pipe ø 4mm Qty 1 pcs		
	GEV No.	100905	Ref. No. —
	locking screw M10x1 for pipe ø 6mm Qty 1 pcs		

accessories for	101132		
	GEV No.	101054	Ref. No. —
	magnet unit T1: M10x1 T2: M24x1 L 45mm ø 17mm suitable for Minisit		
	GEV No.	101136	Ref. No. —
	piezoelectric igniter suitable for Minisit with cover cap ømm connection F6.3x0.8		
	GEV No.	101137	Ref. No. —
	cover cap without piezoelectric igniter		
	GEV No.	101267	Ref. No. —
	reducer IT 3/8" ET 1/2" L 21mm		
	GEV No.	101268	Ref. No. —
	gas connection thread 3/8" angled with O-ring MINISIT 710		
	GEV No.	101269	Ref. No. —
	gas connection thread 1/2" angled with O-ring MINISIT 710		
	GEV No.	101270	Ref. No. —
	screw connection IT 3/8" ET 3/8" L 28mm		
	GEV No.	101272	Ref. No. —
	screw connection IT 1/2" ET 3/8" L 57mm		
	GEV No.	101273	Ref. No. —
	olive for pipe ø 12mm L 9.5mm brass Qty 1 pcs suitable for universal		
	GEV No.	101274	Ref. No. —
	olive for pipe ø 16mm Qty 1 pcs		
	GEV No.	101275	Ref. No. —
	union screw thread 1/2" for pipe ø 16mm Qty 1 pcs		
	GEV No.	101276	Ref. No. —
	union screw thread 3/8" tube ø 12mm Qty 1 pcs		
	GEV No.	110068	Ref. No. P72E
	knob suitable for Minisit ø 37mm		



GEV No.	102873	Ref. No.	P70/P300
description	gas thermostat SIT type MINISIT 710 t.max. 340°C 140-340°C gas inlet 1/2" gas outlet 3/8" thermocouple connection M9x1 probe ø 4mm probe L 72mm capillary pipe 1050mm probe type type C2 pressure controller no		
spare parts for	102873		
	GEV No.	100068	Ref. No. —
	pilot burner 2 flames gas connection 6mm		



Table continues overleaf



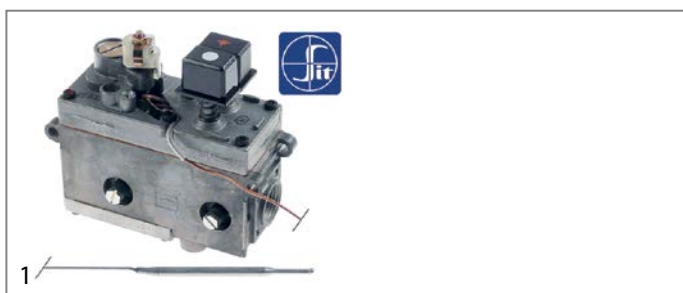

1 gas components

spare parts for		102873		
GEV No.	100809	Ref. No.	—	
	O-ring EPDM thickness 2mm ID ø 21mm Qty 1 pcs			
	GEV No.	101053	Ref. No.	—
magnet unit T1: M9x1 T2: M24x1 L 45mm ø 17mm suitable for Minisit				
	GEV No.	101137	Ref. No.	—
cover cap without piezoelectric igniter				
	GEV No.	101504	Ref. No.	—
gas connection thread 1/2" angled without O-ring MINISIT 710				
	GEV No.	101505	Ref. No.	—
gas connection thread 3/8" angled without O-ring MINISIT 710				
	GEV No.	101516	Ref. No.	—
flat-headed bolt thread M4 thread L 16mm SS DIN 7985/ISO 7045 Qty 1 pcs				
	GEV No.	101517	Ref. No.	—
flat-headed bolt thread M4 thread L 23mm				
	GEV No.	106226	Ref. No.	—
probe 140-380°C probe ø 4mm probe L 72mm capillary pipe 1050mm t.max. 380°C oven/grill probe type type C2 suitable for MINISIT 710				



GEV No.	101131	Ref. No.	P69	
description	gas thermostat without cap, button and angle SIT type MINISIT 710 t.max. 190°C 50-190°C gas inlet 1/2" gas outlet 3/8" thermocouple connection M9x1 pilot connection M10x1 probe ø 5mm probe L 98mm capillary pipe 1200mm probe type type A2 pressure controller no pressure regulator mbar gland nut			

spare parts for		101131		
GEV No.	101053	Ref. No.	—	
	magnet unit T1: M9x1 T2: M24x1 L 45mm ø 17mm suitable for Minisit			
	GEV No.	102103	Ref. No.	—
probe 60-200°C probe ø 5mm probe L 98mm capillary pipe 1050mm t.max. 200°C fryer probe type type A2 suitable for MINISIT 710				

accessories for		101131		
GEV No.	100809	Ref. No.	—	
	O-ring EPDM thickness 2mm ID ø 21mm Qty 1 pcs			
	GEV No.	100820	Ref. No.	—
gland duct ET M14x1.5 IT M10x0.75 probe ø max. 6.5mm WS 22				
	GEV No.	100904	Ref. No.	—
locking screw M10x1 for pipe ø 4mm Qty 1 pcs				
	GEV No.	100905	Ref. No.	—
locking screw M10x1 for pipe ø 6mm Qty 1 pcs				

accessories for		101131		
GEV No.	101054	Ref. No.	—	
	magnet unit T1: M10x1 T2: M24x1 L 45mm ø 17mm suitable for Minisit			
	GEV No.	101136	Ref. No.	—
piezoelectric igniter suitable for Minisit with cover cap ømm connection F6.3x0.8				
	GEV No.	101137	Ref. No.	—
cover cap without piezoelectric igniter				
	GEV No.	101267	Ref. No.	—
reducer IT 3/8" ET 1/2" L 21mm				
	GEV No.	101268	Ref. No.	—
gas connection thread 3/8" angled with O-ring MINISIT 710				
	GEV No.	101269	Ref. No.	—
gas connection thread 1/2" angled with O-ring MINISIT 710				
	GEV No.	101270	Ref. No.	—
screw connection IT 3/8" ET 3/8" L 28mm				
	GEV No.	101272	Ref. No.	—
screw connection IT 1/2" ET 3/8" L 57mm				
	GEV No.	101273	Ref. No.	—
olive for pipe ø 12mm L 9.5mm brass Qty 1 pcs suitable for universal				
	GEV No.	101274	Ref. No.	—
olive for pipe ø 16mm Qty 1 pcs				
	GEV No.	101275	Ref. No.	—
union screw thread 1/2" for pipe ø 16mm Qty 1 pcs				
	GEV No.	101276	Ref. No.	—
union screw thread 3/8" tube ø 12mm Qty 1 pcs				
	GEV No.	110068	Ref. No.	P72E
knob suitable for Minisit ø 37mm				

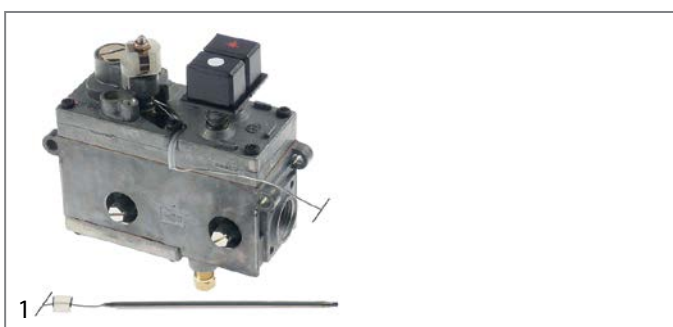





GEV No.	107237	Ref. No.	P69	
description	gas thermostat without cap, button and angle SIT type MINISIT 710 t.max. 210°C 70-210°C gas inlet 1/2" gas outlet 3/8" thermocouple connection M9x1 pilot connection M10x1 probe ø 4mm probe L 122mm capillary pipe 1300mm probe type pressure controller no pressure regulator mbar gland nut			
accessories for		107237		
	GEV No.	101137	Ref. No.	—
cover cap without piezoelectric igniter				

Table continues overleaf









accessories for		107237	
	GEV No.	101267	Ref. No. —
reducer IT 3/8" ET 1/2" L 21mm			
	GEV No.	101268	Ref. No. —
gas connection thread 3/8" angled with O-ring MINISIT 710			
	GEV No.	110068	Ref. No. P72E
knob suitable for Minisit ø 37mm			

PEL

24STS series



GEV No.	106382	Ref. No.	P70C
description	gas thermostat PEL type 24STS 110-310°C gas inlet flange bypass nozzle ø 0mm gas outlet flange thermocouple connection M9x1 pilot connection M10x1 capillary pipe 1200mm probe ø 6mm probe L 100mm shaft ø 10x8mm shaft L 27/17mm shaft flat upper		
spare parts for	106382		
	GEV No.	101058	Ref. No. —
magnet unit L 39mm D1 ø 15.4mm D2 ø 13.5mm suitable for PEL22/ EGA24197 standard			
	GEV No.	106200	Ref. No. —
nut thread M9x1 suitable for PEL 24/255			
	GEV No.	106201	Ref. No. —
bypass nozzle type PEL23/24 bore ø 0mm thread M8x0.5			
accessories for	106382		
	GEV No.	100908	Ref. No. —
union screw thread M10x1 for pipe ø 4mm Qty 1 pcs			
	GEV No.	100909	Ref. No. —
union screw thread M10x1 for pipe ø 6mm Qty 1 pcs			
	GEV No.	101235	Ref. No. —
gas connection thread M20x1.5 tube ø 12/10mm for PEL gas taps horizontal			
	GEV No.	101240	Ref. No. —
gas connection thread M20x1.5 tube ø 12/10mm for PEL gas taps with gasket and screws horizontal			
	GEV No.	101241	Ref. No. —
gas connection thread M20x1.5 tube ø 12/10mm for PEL gas taps vertical			
	GEV No.	101246	Ref. No. —
olive for pipe ø 4mm Qty 1 pcs			
	GEV No.	101248	Ref. No. —
olive for pipe ø 12mm Qty 1 pcs suitable for PEL			
	GEV No.	101249	Ref. No. —
olive for pipe ø 10mm Qty 1 pcs			

accessories for		106382	
	GEV No.	101250	Ref. No. —
union nut thread M20x1.5 for pipe ø 10mm			
	GEV No.	101251	Ref. No. —
union nut thread M20x1.5 for pipe ø 12mm			
	GEV No.	101286	Ref. No. —
olive ID ø 6mm Qty 1 pcs			
	GEV No.	101460	Ref. No. —
O-ring ø 12.37mm D1 ø 2.62mm suitable for PEL22			
	GEV No.	101461	Ref. No. —
screw kit suitable for PEL22 Qty 4 pcs			

accessories for		106392	
	GEV No.	106392	Ref. No. P70B
description	gas thermostat PEL type 24STS bypass nozzle ø 0/1.5/2.75mm thermocouple connection M9x1 capillary pipe 1200mm probe ø 6mm probe L 100mm shaft ø 10x8mm shaft L 27/17mm t.max. 350°C pipe input ø 14mm pipe output ø 14mm		
spare parts for	106392		
	GEV No.	100679	Ref. No. —
bypass nozzle type PEL23/24 bore ø 1.5mm thread M8x0.5			
	GEV No.	100909	Ref. No. —
union screw thread M10x1 for pipe ø 6mm Qty 1 pcs			
	GEV No.	101286	Ref. No. —
olive ID ø 6mm Qty 1 pcs			
	GEV No.	101365	Ref. No. —
gas connection thread M20x1.5 tube ø 12mm for PEL gas taps horizontal			
	GEV No.	101427	Ref. No. —
union nut thread M20x1.5 for pipe ø 14mm			
	GEV No.	101428	Ref. No. —
olive for pipe ø 14mm L 9mm Qty 1 pcs ED ø 16mm			
	GEV No.	101460	Ref. No. —
O-ring ø 12.37mm D1 ø 2.62mm suitable for PEL22			
	GEV No.	101461	Ref. No. —
screw kit suitable for PEL22 Qty 4 pcs			
	GEV No.	106393	Ref. No. —
bypass nozzle type PEL23/24 bore ø 2.75mm thread M8x0.5			





25ST series



GEV No.	101991	Ref. No.	P70D
description	gas thermostat PEL type 25ST 100-300°C gas inlet M16x1.5 (tube ø 10mm) bypass nozzle ø 0mm gas outlet M16x1.5 (tube ø 10/8mm) thermocouple connection M9x1 pilot connection M10x1 capillary pipe 1200mm probe ø 6mm probe L 100mm shaft ø 8x6.5mm shaft L 21/15mm shaft flat upper		
spare parts for	101991		
	GEV No.	101060	Ref. No. —
	magnet unit standard L 39mm D1 ø 15.4mm D2 ø 11mm suitable for PEL20-21/JUNKERS/EGA		
	GEV No.	106191	Ref. No. —
	bypass nozzle type PEL22 bore ø 0mm thread M6x0.5		
	GEV No.	106200	Ref. No. —
	nut thread M9x1 suitable for PEL 24/255		
accessories for	101991		
	GEV No.	100908	Ref. No. —
	union screw thread M10x1 for pipe ø 4mm Qty 1 pcs		
	GEV No.	100909	Ref. No. —
	union screw thread M10x1 for pipe ø 6mm Qty 1 pcs		
	GEV No.	101246	Ref. No. —
	olive for pipe ø 4mm Qty 1 pcs		
	GEV No.	101278	Ref. No. —
	olive for pipe ø 10mm Qty 1 pcs		
	GEV No.	101286	Ref. No. —
	olive ID ø 6mm Qty 1 pcs		
	GEV No.	101300	Ref. No. —
	union nut thread M16x1.5 tube ø 10mm		
	GEV No.	101450	Ref. No. —
	olive for pipe ø 8mm L 12.7mm Qty 1 pcs ED ø 10mm		
	GEV No.	101451	Ref. No. —
	union nut thread M16x1.5 tube ø 8mm		
	GEV No.	110079	Ref. No. —
	knob dial plate gas thermostat 1-8 silver		
	GEV No.	110081	Ref. No. —
	knob ø 70mm shaft ø 8x6.5mm shaft flat universal		

STN3R



GEV No.	106210	Ref. No.	P300 P70A
description	gas thermostat t.max. 450°C gas inlet 1/2" gas outlet 1/2" probe ø 6.5mm probe L 250mm capillary pipe 1200mm STN3R		
spare parts for	106210		
	GEV No.	106211	Ref. No. P72J
	knob suitable for STN3R		
	GEV No.	106212	Ref. No. P72D
	knob suitable for STN3R		

gas valves and ignition boxes
gas control valves

SIT
ELETTROSIT











GEV No.	101123	Ref. No.	P71
description	gas valve SIT type ELETTROSIT 230V gas inlet 3/4" gas outlet 3/4" thermocouple connection M9x1 pilot connection M10x1 bottom equiv. no. 0.810.138		
spare parts for	101123		
	GEV No.	101312	Ref. No. —
	microswitch		
	GEV No.	101352	Ref. No. —
	solenoid coil 230V 50Hz suitable for ELETTROSIT		
accessories for	101123		
	GEV No.	100006	Ref. No. —
	piezoelectric igniter suitable for ELETTROSIT body plastic blowing connection ø2.4mm ø 14mm		
	GEV No.	100904	Ref. No. —
	locking screw M10x1 for pipe ø 4mm Qty 1 pcs		
	GEV No.	100905	Ref. No. —
	locking screw M10x1 for pipe ø 6mm Qty 1 pcs		











Table continues overleaf



















accessories for	101123		
	GEV No.	101301	Ref. No. —
	gas connection thread 1/2" straight ELETTROSIT screw with O-ring		
	GEV No.	101303	Ref. No. —
	gas connection straight thread 3/4" ELETTROSIT		
	GEV No.	101309	Ref. No. —
	extension		

















ignition parts

pilot burners

SIT			
100 series			
	1		
GEV No.	106901	Ref. No.	P74 P74A
description	pilot burner SIT type 100 series 1 flame nozzle ø 0.2mm gas connection 6mm		
spare parts for	106901		
	GEV No.	100854	Ref. No. —
	pilot burner bracket double		
	GEV No.	100916	Ref. No. —
	compression spring for pilot burner Qty 1 pcs		
	GEV No.	100917	Ref. No. —
	gasket for pilot burner Qty 1 pcs aluminium		
	GEV No.	100918	Ref. No. —
	screw for pilot burner		
accessories for	106901		
	GEV No.	100904	Ref. No. —
	locking screw M10x1 for pipe ø 4mm Qty 1 pcs		
	GEV No.	100905	Ref. No. —
	locking screw M10x1 for pipe ø 6mm Qty 1 pcs		
	GEV No.	102110	Ref. No. —
	pilot tube copper pipe ø 4mm thickness 1mm L 3000mm		
	GEV No.	102111	Ref. No. —
	pilot tube copper pipe ø 6mm thickness 1mm L 3000mm		
	GEV No.	102742	Ref. No. —
	pilot burner nozzle LPG code 25 bore ø 0.25mm Qty 1 pcs		

	1		
GEV No.	106902	Ref. No.	P74A
description	pilot burner SIT type 100 series 2 flames nozzle ø 0.2mm gas connection 6mm		
spare parts for	106902		
	GEV No.	100245	Ref. No. P75C
	pilot burner nozzle LPG code 20 bore ø 0.2mm Qty 1 pcs thread M8x0.75		
	GEV No.	100842	Ref. No. —
	pilot burner cap 2 flames Qty 1 pcs		
	GEV No.	100885	Ref. No. —
	air mixing sleeve for pilot burner Qty 1 pcs		
	GEV No.	100916	Ref. No. —
	compression spring for pilot burner Qty 1 pcs		
	GEV No.	100917	Ref. No. —
	gasket for pilot burner Qty 1 pcs aluminium		
	GEV No.	100918	Ref. No. —
	screw for pilot burner		
	GEV No.	107161	Ref. No. —
	pilot burner cap SIT 2 flames Hmm Lmm Qty 1 pcs		
	GEV No.	107701	Ref. No. —
	pilot burner bottom part SIT 100 series nozzle ø 0.2mm		
accessories for	106902		
	GEV No.	100246	Ref. No. INJ3006 P75B
	pilot burner nozzle natural gas bore ø 0.35mm Qty 1 pcs thread M8x0.75		
	GEV No.	100904	Ref. No. —
	locking screw M10x1 for pipe ø 4mm Qty 1 pcs		
	GEV No.	100905	Ref. No. —
	locking screw M10x1 for pipe ø 6mm Qty 1 pcs		
	GEV No.	102110	Ref. No. —
	pilot tube copper pipe ø 4mm thickness 1mm L 3000mm		
	GEV No.	102111	Ref. No. —
	pilot tube copper pipe ø 6mm thickness 1mm L 3000mm		
	GEV No.	107171	Ref. No. —
	pilot burner nozzle SIT natural/liquid gas bore ø 0.25mm Qty 1 pcs		
	GEV No.	107700	Ref. No. —
	pilot burner bottom part SIT 100 series nozzle ø 0.25mm		
	GEV No.	107702	Ref. No. —
	pilot burner bottom part SIT 100 series nozzle ø 0.35mm		



			
1			
GEV No.	106906	Ref. No.	P74B
description	pilot burner SIT type 100 series 3 flames nozzle \varnothing 0.2mm gas connection 6mm		
spare parts for	106906		
	GEV No.	100245	Ref. No. P75C
	pilot burner nozzle LPG code 20 bore \varnothing 0.2mm Qty 1 pcs thread M8x0.75		
	GEV No.	100855	Ref. No. —
	pilot burner bracket triple		
	GEV No.	100885	Ref. No. —
	air mixing sleeve for pilot burner Qty 1 pcs		
	GEV No.	100916	Ref. No. —
	compression spring for pilot burner Qty 1 pcs		
	GEV No.	100917	Ref. No. —
	gasket for pilot burner Qty 1 pcs aluminium		
	GEV No.	100918	Ref. No. —
	screw for pilot burner		
	GEV No.	107162	Ref. No. —
	pilot burner cap SIT 3 flames Hmm Lmm Qty 1 pcs		
	GEV No.	107701	Ref. No. —
	pilot burner bottom part SIT 100 series nozzle \varnothing 0.2mm		
accessories for	106906		
	GEV No.	100245	Ref. No. P75C
	pilot burner nozzle LPG code 20 bore \varnothing 0.2mm Qty 1 pcs thread M8x0.75		
	GEV No.	100246	Ref. No. INJ3006 P75B
	pilot burner nozzle natural gas bore \varnothing 0.35mm Qty 1 pcs thread M8x0.75		
	GEV No.	100904	Ref. No. —
	locking screw M10x1 for pipe \varnothing 4mm Qty 1 pcs		
	GEV No.	100905	Ref. No. —
	locking screw M10x1 for pipe \varnothing 6mm Qty 1 pcs		
	GEV No.	102110	Ref. No. —
	pilot tube copper pipe \varnothing 4mm thickness 1mm L 3000mm		
	GEV No.	102111	Ref. No. —
	pilot tube copper pipe \varnothing 6mm thickness 1mm L 3000mm		
	GEV No.	107171	Ref. No. —
	pilot burner nozzle SIT natural/liquid gas bore \varnothing 0.25mm Qty 1 pcs		
	GEV No.	107700	Ref. No. —
	pilot burner bottom part SIT 100 series nozzle \varnothing 0.25mm		

accessories for	106906		
	GEV No.	107702	Ref. No. —
	pilot burner bottom part SIT 100 series nozzle \varnothing 0.35mm		

















			
1			
GEV No.	106907	Ref. No.	P74B
description	pilot burner SIT type 100 series 3 flames nozzle \varnothing 0.35mm gas connection 6mm		
spare parts for	106907		
	GEV No.	100246	Ref. No. INJ3006 P75B
	pilot burner nozzle natural gas bore \varnothing 0.35mm Qty 1 pcs thread M8x0.75		
	GEV No.	100855	Ref. No. —
	pilot burner bracket triple		
	GEV No.	100885	Ref. No. —
	air mixing sleeve for pilot burner Qty 1 pcs		
	GEV No.	100916	Ref. No. —
	compression spring for pilot burner Qty 1 pcs		
	GEV No.	100917	Ref. No. —
	gasket for pilot burner Qty 1 pcs aluminium		
	GEV No.	100918	Ref. No. —
	screw for pilot burner		
	GEV No.	107162	Ref. No. —
	pilot burner cap SIT 3 flames Hmm Lmm Qty 1 pcs		
	GEV No.	107702	Ref. No. —
	pilot burner bottom part SIT 100 series nozzle \varnothing 0.35mm		
accessories for	106907		
	GEV No.	100245	Ref. No. P75C
	pilot burner nozzle LPG code 20 bore \varnothing 0.2mm Qty 1 pcs thread M8x0.75		
	GEV No.	100904	Ref. No. —
	locking screw M10x1 for pipe \varnothing 4mm Qty 1 pcs		
	GEV No.	100905	Ref. No. —
	locking screw M10x1 for pipe \varnothing 6mm Qty 1 pcs		
	GEV No.	102110	Ref. No. —
	pilot tube copper pipe \varnothing 4mm thickness 1mm L 3000mm		
	GEV No.	102111	Ref. No. —
	pilot tube copper pipe \varnothing 6mm thickness 1mm L 3000mm		
	GEV No.	107171	Ref. No. —
	pilot burner nozzle SIT natural/liquid gas bore \varnothing 0.25mm Qty 1 pcs		

Table continues overleaf







accessories for 106907	
	GEV No. 107700 Ref. No. —
pilot burner bottom part SIT 100 series nozzle ø 0.25mm	
	GEV No. 107701 Ref. No. —
pilot burner bottom part SIT 100 series nozzle ø 0.2mm	

accessories for 106388	
	GEV No. 100907 Ref. No. —
screw connection thread M10x1 Qty 1 pcs type SEF 1 ømm for thermocouple	
	GEV No. 101602 Ref. No. —
locking screw thread M10x1 for pipe ø 1/4" Qty 1 pcs	



accessories	
pilot burner nozzles	
	
GEV No.	100245 Ref. No. P75C
description	pilot burner nozzle LPG code 20 bore ø 0.2mm Qty 1 pcs thread M8x0.75

	
GEV No.	100246 Ref. No. INJ3006 P75B
description	pilot burner nozzle natural gas bore ø 0.35mm Qty 1 pcs thread M8x0.75

ignition electrodes	
	
GEV No.	100707 Ref. No. P641
description	ignition electrode D1 ø 7mm D2 ø 9mm connection ø 2.4mm L1 14mm L2 6mm BL1 18mm BL2 3mm BL3 23mm to clip Qty 1 pcs

Oxipilot 9000 series	
pilot burners	
	
GEV No.	106388 Ref. No. P74DB
description	pilot burner type Oxipilot 9000 series 2 flames natural gas nozzle no. 33 nozzle ø 0.33mm gas connection 6mm without ignition electrode bore ø 0.33mm
accessories for 106388	
	GEV No. 100904 Ref. No. —
locking screw M10x1 for pipe ø 4mm Qty 1 pcs	
	GEV No. 100905 Ref. No. —
locking screw M10x1 for pipe ø 6mm Qty 1 pcs	

JUNKERS	
CB 505 series	
pilot burners	
	
GEV No.	106390 Ref. No. P74B800
description	pilot burner type CB 5051_ natural/liquid gas code 42/64 gas connection 6mm

producer-specific pilot burners	
SOLYMAC	
	
GEV No.	106387 Ref. No. P1171A
description	pilot burner 1 flame gas connection 6mm without nozzle
accessories for 106387	
	GEV No. 106385 Ref. No. P1171C
pilot burner nozzle LPG code 22 bore ø 0.22mm thread M5x0.75 Qty 1 pcs brass	
	GEV No. 106386 Ref. No. P1171B
pilot burner nozzle natural gas code 40 bore ø 0.4mm thread M5x0.75 Qty 1 pcs brass	

	
GEV No.	106385 Ref. No. P1171C
description	pilot burner nozzle LPG code 22 bore ø 0.22mm thread M5x0.75 Qty 1 pcs brass

	
GEV No.	106386 Ref. No. P1171B
description	pilot burner nozzle natural gas code 40 bore ø 0.4mm thread M5x0.75 Qty 1 pcs brass

electrodes

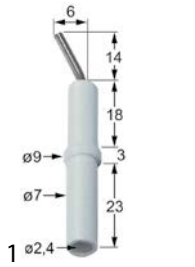

GEV No.	100707	Ref. No.	P641
description	ignition electrode D1 ø 7mm D2 ø 9mm connection ø 2.4mm L1 14mm L2 6mm BL1 18mm BL2 3mm BL3 23mm to clip Qty 1 pcs		

thermocouples

plug-in thermocouples

plug-in thermocouples standard

with barrel socket ø5mm - type Junkers with aluminised tip



GEV No.	102251	Ref. No.	P73 800/B
description	thermocouple M9x1 L 750mm plug connection ø5.0mm		

with barrel socket ø6(6.5)mm

thermocouples SIT

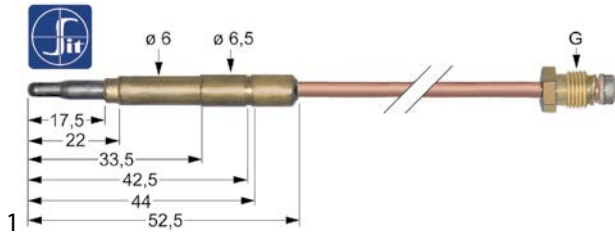

GEV No.	107614	Ref. No.	P73B
description	thermocouple SIT M9x1 L 1500mm plug connection ø6.0(6.5)mm		

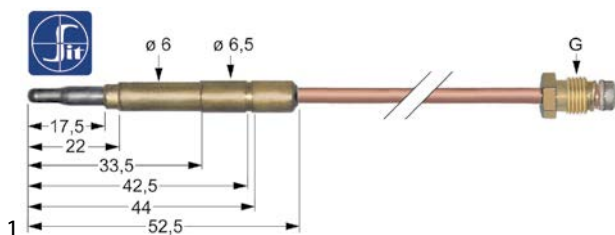

GEV No.	107606	Ref. No.	P73D
description	thermocouple SIT M9x1 L 320mm plug connection ø6.0(6.5)mm		

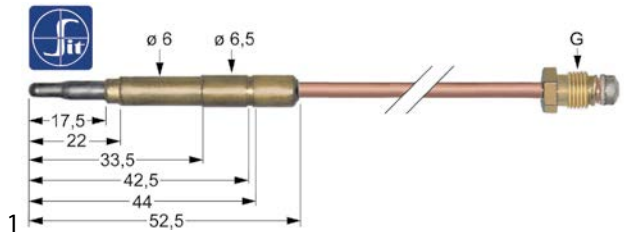

GEV No.	107608	Ref. No.	P73
description	thermocouple SIT M9x1 L 500mm plug connection ø6.0(6.5)mm		

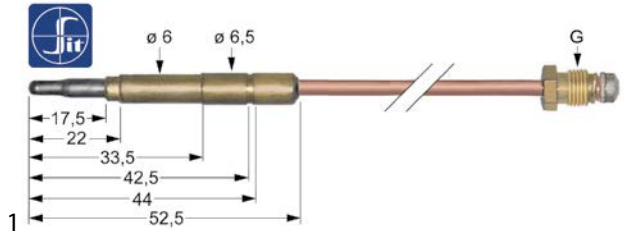

GEV No.	107611	Ref. No.	P73C
description	thermocouple SIT M9x1 L 850mm plug connection ø6.0(6.5)mm		

gas burners

hob burners

producer-specific hob burners

SOLYMAC

854 series



GEV No.	107107	Ref. No.	P957
description	burner type 854 ø 80mm L 120mm complete		

spare parts for	107107		
------------------------	--------	--	--



burner cap ø 78mm 5kW mounting ø 72mm





GEV No.	108004	Ref. No.	N/A
description	burner cap ø 78mm 5kW mounting ø 72mm		

accessories for	108004		
------------------------	--------	--	--



burner head for burner cap ø 78mm seat ø 35mm ID ø 30mm ED ø 83mm





			
1			
GEV No.	108003	Ref. No.	N/A
description	burner head for burner cap ø 78mm seat ø 35mm ID ø 30mm ED ø 83mm		
accessories for	108003		
	GEV No.	108004	Ref. No. N/A
	burner cap ø 78mm 5kW mounting ø 72mm		



			
1			
GEV No.	108078	Ref. No.	P2
description	burner cap ø 98mm mounting ø 97mm		

			
1			
GEV No.	108014	Ref. No.	N/A
description	burner head ø 100mm seat ø 97mm		

861 series

			
1			
GEV No.	107009	Ref. No.	N/A
description	burner type 861 ø 80mm L 185mm complete		

			
1			
GEV No.	108010	Ref. No.	P1
description	burner cap ø 78mm		
accessories for	108010		
	GEV No.	108003	Ref. No. N/A
	burner head for burner cap ø 78mm seat ø 35mm ID ø 30mm ED ø 83mm		

			
1			
GEV No.	108003	Ref. No.	N/A
description	burner head for burner cap ø 78mm seat ø 35mm ID ø 30mm ED ø 83mm		
accessories for	108003		
	GEV No.	108004	Ref. No. N/A
	burner cap ø 78mm 5kW mounting ø 72mm		

862 series

			
1			
GEV No.	107119	Ref. No.	N/A
description	burner type 862 ø 100mm L 185mm complete		

pan supports

			
1			
GEV No.	210025	Ref. No.	P161
description	pan support W 320mm L 320mm		

			
1			
GEV No.	210033	Ref. No.	P161832
description	pan support W 320mm L 320mm		

accessories

<p>pan supports</p> 			
1			
GEV No.	210025	Ref. No.	P161
description	pan support W 320mm L 320mm		

			
1			
GEV No.	210033	Ref. No.	P161832
description	pan support W 320mm L 320mm		



bar burners

bar burners



1	GEV No.	104469	Ref. No.	P22
description bar burner 3 row L 435mm W 250mm ømm H 64mm chargrill				



1	GEV No.	104473	Ref. No.	P13
description bar burner 3 row L 485mm W 200mm ømm H 150mm grill				



1	GEV No.	104471	Ref. No.	P14
description bar burner 3 row L 580mm W 250mm ømm H 63mm chargrill				



1	GEV No.	104474	Ref. No.	P11
description bar burner 4 row L 430mm W 370mm ømm H 190mm grill				



1	GEV No.	104472	Ref. No.	P10
description bar burner 4 row L 525mm W 280mm ømm H 124mm griddle				



1	GEV No.	106534	Ref. No.	P75D120
description gas injector thread 3/8" WS 17 bore ø 1.2mm				



1	GEV No.	106535	Ref. No.	P75D130
description gas injector thread 3/8" WS 17 bore ø 1.3mm				



1	GEV No.	106537	Ref. No.	P75D150
description gas injector thread 3/8" WS 17 bore ø 1.5mm				



1	GEV No.	106540	Ref. No.	P75D180
description gas injector thread 3/8" WS 17 bore ø 1.8mm				



1	GEV No.	106531	Ref. No.	P75D100
description gas injector thread 3/8" WS 17 bore ø 1mm				



1	GEV No.	106543	Ref. No.	P75D210
description gas injector thread 3/8" WS 17 bore ø 2.1mm				



1	GEV No.	106544	Ref. No.	P75D220
description gas injector thread 3/8" WS 17 bore ø 2.2mm				

gas nozzles

main nozzles

gas nozzles 3/8"



1	GEV No.	106530	Ref. No.	P75D09
description gas injector thread 3/8" WS 17 bore ø 0.95mm				



GEV No.	106545	Ref. No.	P75D230
description	gas injector thread 3/8" WS 17 bore ø 2.3mm		



GEV No.	106547	Ref. No.	P75D250
description	gas injector thread 3/8" WS 17 bore ø 2.5mm		



GEV No.	106542	Ref. No.	P75D200
description	gas injector thread 3/8" WS 17 bore ø 2mm		



GEV No.	106556	Ref. No.	P75D330
description	gas injector thread 3/8" WS 17 bore ø 3.3mm		



GEV No.	106553	Ref. No.	P75D300
description	gas injector thread 3/8" WS 17 bore ø 3mm		

pilot burner nozzles

pilot burner nozzles AEM



GEV No.	106385	Ref. No.	P1171C
description	pilot burner nozzle LPG code 22 bore ø 0.22mm thread M5x0.75 Qty 1 pcs brass		

pilot burner nozzles SIT

100 series

GEV No.	100245	Ref. No.	P75C
description	pilot burner nozzle LPG code 20 bore ø 0.2mm Qty 1 pcs thread M8x0.75		

GEV No.	100246	Ref. No.	INJ3006 P75B
description	pilot burner nozzle natural gas bore ø 0.35mm Qty 1 pcs thread M8x0.75		

pilot burner nozzles (other)

SOLYMAC/CAPIC

GEV No.	106385	Ref. No.	P1171C
description	pilot burner nozzle LPG code 22 bore ø 0.22mm thread M5x0.75 Qty 1 pcs brass		

GEV No.	106386	Ref. No.	P1171B
description	pilot burner nozzle natural gas code 40 bore ø 0.4mm thread M5x0.75 Qty 1 pcs brass		

auxiliary gas parts

gas ball valves

miscellaneous



GEV No.	520586	Ref. No.	P1004
description	ball valve IT 1/2" L 55mm with safety handle angled W 28mm H 73mm handle ø 23mm wing handle EN 331		

equipment-specific units

for espresso machines

aerators and air bleeders



1

GEV No.	529303	Ref. No.	P67E
description	aerator and air bleeder connection 1/4" only steam		
spare parts for	529303		
	GEV No.	528687	Ref. No. —
O-ring Viton thickness 1.78mm ID ø 3.69mm Qty 1 pcs			

for convection ovens/combi-steamers

spare parts and accessories



1

GEV No.	541859	Ref. No.	NU34
description	bush ID ø 14.5mm ext. ø 18/22 thickness 5.5mm		

knobs

universal knobs



1

GEV No.	110075	Ref. No.	P82A
description	knob energy regulator 1-3 t.max.°C ø 50mm shaft ø 6x4.6mm shaft flat upper black		
accessories for	110075		
	GEV No.	110135	Ref. No. —
rosette knob up to ø 52mm			

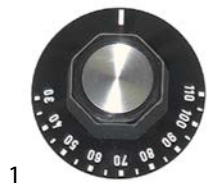

1

GEV No.	110119	Ref. No.	P76B
description	knob thermostat t.max. 110°C ø 50mm shaft ø 6x4.6mm shaft flat upper black temperature range 30-110°C rotation 270°		
accessories for	110119		
	GEV No.	110135	Ref. No. —
rosette knob up to ø 52mm			



1

GEV No.	110121	Ref. No.	P80A
description	knob thermostat t.max. 200°C ø 50mm shaft ø 6x4.6mm shaft flat upper black temperature range 60-200°C rotation 270°		
accessories for	110121		
	GEV No.	110135	Ref. No. —
rosette knob up to ø 52mm			

producer-specific knobs

SOLYMAC



1

GEV No.	110075	Ref. No.	P82A
description	knob energy regulator 1-3 t.max.°C ø 50mm shaft ø 6x4.6mm shaft flat upper black		
accessories for	110075		
	GEV No.	110135	Ref. No. —
rosette knob up to ø 52mm			



1

GEV No.	112559	Ref. No.	P72B
description	knob switch zero mark t.max.°C temperature range°C ø 81mm shaft ø 10x8mm shaft flat lower black		



1

GEV No.	110119	Ref. No.	P76B
description	knob thermostat t.max. 110°C ø 50mm shaft ø 6x4.6mm shaft flat upper black temperature range 30-110°C rotation 270°		
accessories for	110119		
	GEV No.	110135	Ref. No. —
rosette knob up to ø 52mm			

1			
GEV No.	110121	Ref. No.	P80A
description	knob thermostat t.max. 200°C ø 50mm shaft ø 6x4,6mm shaft flat upper black temperature range 60-200°C rotation 270°		
accessories for	110121		
		GEV No. 110135	Ref. No. —
	rosette knob up to ø 52mm		

locks

edgmount latches

handle latches

CAFF/FERMOD

1			
GEV No.	700060	Ref. No.	FS13
description	handle latch L 150mm mounting distance 133mm non lockable heated units G 791		
accessories for	700060		
		GEV No. 700061	Ref. No. —
	door catch L 58mm W 20mm H 35mm mounting distance 42mm chrome-plated brass for headed units		
		GEV No. 700062	Ref. No. —
	handle protection heated units		

hinges

edgmount hinges

CAFF/FERMOD

1			
GEV No.	700562	Ref. No.	FS14
description	edgmount hinge L 140mm W 31/24mm mounting distance 30/35mm hinging left/right without lift L1 37mm L2 36mm L3 45.5mm series G 361		
1			
GEV No.	700564	Ref. No.	FS14A
description	edgmount hinge L 96mm W 15mm mounting distance 64/32mm hinging left/right without lift series G 401		
1			
GEV No.	692669	Ref. No.	FS14A
description	edgmount hinge L 96mm W 15/17mm mounting distance 64/32mm hinging left/right without lift centre of rotation 14/23mm		



mechanical components, equipment accessories

oven hinges

GEV No.	690037	Ref. No.	P1157
description	oven hinge mounting distance 205mm mounting distance 2mm lug mountingmm lever length 119mm groove distance 13mm spring thickness 4.3mm mounting ear position spring length 103mm L 214mm		

accessories for	540276		
	GEV No.	514251	Ref. No. —
	gasket fibre ED ø 46mm ID ø 38mm thickness 2mm Qty 1 pcs		

shelves and shelf rails

chargrill grids

GEV No.	210038	Ref. No.	P164
description	chargrill grid L 333mm W 317mm H 50mm cast iron		

fittings for catering equipment

drain taps

brass

drain taps

GEV No.	548001	Ref. No.	P61
description	drain tap 1 1/2" IT O-ring seal kettle connection with union nut A 80mm B1 68mm B2 132mm		
spare parts for	548001		
	GEV No.	505092	Ref. No. —
	O-ring EPDM thickness 5.34mm ID ø 43.82mm Qty 1 pcs		
	GEV No.	540213	Ref. No. —
	handle ID ø 5mm L 117mm		

gaskets

gaskets for heated units

window seals

GEV No.	900782	Ref. No.	MCGV0002
description	window gasket profile 1889 Qty supplied by meter		

door seals

GEV No.	901507 ¹	Ref. No.	FS12
description	door seal profile 2290 W 641mm L 782mm external size Qty 1 suitable for BOURGEOIS 3-sided (short side open)		

¹3-sided (short side open)

GEV No.	901169	Ref. No.	MCGP0002
description	door seal profile 2948 Qty supplied by meter		

GEV No.	540276	Ref. No.	P61
description	drain tap connection with union nut thread 1 1/2"		
spare parts for	540276		
	GEV No.	532374	Ref. No. —
	O-ring silicone thickness 5.34mm ID ø 43.82mm Qty 10 pcs		

sealing cords

round

1



GEV No.	693737	Ref. No.	P95 P95A
description	sealing cord round ø 25mm braided L 5m Qty 1		

springs

torsion springs

1



GEV No.	514505	Ref. No.	P93G
description	torsion spring ø 30mm wire gauge ø 4.5mm L1 14mm L2 180mm L3 14mm mounting pos. left Qty 1 pcs		

1



GEV No.	514504	Ref. No.	P93D
description	torsion spring ø 30mm wire gauge ø 4.5mm L1 16mm L2 185mm L3 13mm mounting pos. right		

dosing pumps





membrane dosing pumps

self-priming with supporting pressure

OMNIWASH

1



GEV No.	361054	Ref. No.	P70C	
description	dosing pump rinse aid pressure connection ø 6mm suction connection ø 6mm auxiliary pressure connection 10mm			
spare parts for	361054			
	GEV No.	361308	Ref. No.	—
	membrane rinse aid pressure connection ømm suction connection ømm auxiliary pressure connectionmm			
	GEV No.	361348	Ref. No.	—
	lip valve rinse aid pressure connection ømm suction connection ømm auxiliary pressure connectionmm			
accessories for	361054			
	GEV No.	520252	Ref. No.	—
	nylon hose ID ø 6mm ED ø 8mm L 5m thickness 1mm operating p. 10bar burst p. 50bar t.max. 100°C white			
	GEV No.	520278	Ref. No.	—
	PVC hose ID ø 6mm ED ø 8mm L 2m thickness 1mm t.max. 60°C transparent			

B		
bar burners	24	
C		
cam switches	7	
ceramic heaters	4	
condensators & interference suppression filters	11	
control equipment	8	
control thermostats	6	
D		
door seals	28	
dosing pumps	29	
E		
edgemount hinges	27	
edgemount latches	27	
electronic controllers	9	
energy regulators	5	
F		
fans	11	
G		
gas ball valves	25	
gas burners	22	
gas control valves	18	
gas nozzles	24	
gas taps	11	
gas thermostats	15	
gaskets for heated units	28	
H		
handle latches	27	
heating elements	3	
heating elements for bain maries	3	
heating elements for fryers	3	
heating elements for griddles	3	
heating elements for pasta cookers	3	
heating elements for pizza ovens	3	
heating elements for salamanders/toasters	4	
hob burners	22	
hot air fans	11	
hot plates	5	
I		
immersion heating elements	4	
indicator lights	8	
L		
lamps	8	
light bulbs	9	
N		
neon light bulbs	8,9	
O		
operating capacitors	11	
oven hinges	28	
oven lamps	9	
P		
pilot burners	19	
probes	10	
R		
radiation heaters	5	
rocker/momentary rocker switches	7	
S		
safety thermostats	7	
sealing cords	29	
shelves and shelf rails	28	
solenoid valves	10	
switches and momentary switches	7	
T		
temperature probes	10	
thermocouples	22	
thermostats	6	
U		
universal probes	10	
W		
window seals	28	