



GAS COMPONENTS



ELECTRIC COMPONENTS



WATER TECHNOLOGY



MECHANICAL COMPONENTS



TOOLS

Spare parts suitable for

STAFF ICE SYSTEM

Find the complete and up-to-date range of products in our GEV Webshop



Manufacturer catalogue

The most important spare parts and accessories arranged clearly for every manufacturer

- ✓ Complete product range and all appliance data always up to date in the GEV Webshop
- ✓ Alphabetical Index at the end of the catalogue

GEV Webshop

www.gev-online.co.uk

www.gev-online.com



- 🔍 Add to Favourites
- 🔍 Sign In with email address and usual password
- 🔍 Easy-order – place several items in your basket at the same time
- 🔍 Quick Item search – no login needed



heating elements

accessories

sealing washers

O-rings

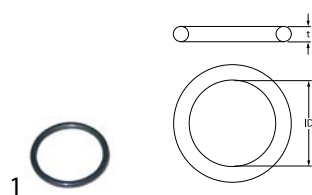

GEV No.	510072	Ref. No.	RICG20141
description	O-ring EPDM thickness 3.53mm ID ø 32.93mm Qty 1 pcs		

thermostats

refrigeration thermostats

RANCO

K50 series



GEV No.	390849	Ref. No.	SL300350467 SL37AAL3231
description	thermostat RANCO type K50-L3231/002 probe ø 1.9mm probe Lmm capillary pipe 1200mm		

K61 series



GEV No.	390206	Ref. No.	4007015000
description	thermostat RANCO type K61L1501 probe ømm probe Lmm capillary pipe 1800mm		

switches and momentary switches

microswitches

lever actuated



GEV No.	347674	Ref. No.	3010314000 3010319000 3010320000 3010321000
description	microswitch 250V 3A 1CO connection male faston 6.3mm L 58mm ambient temperature max. 85°C mounting distance 22mm type D42X actuating force: 6g lever length 44mm		



GEV No.	345368	Ref. No.	90/82010000
description	microswitch with lever 250V 10A 1CO connection male faston ambient temperature max. 85°C		

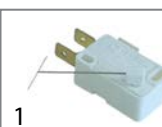

GEV No.	345367	Ref. No.	30/10320000
description	microswitch with lever 250V 6A 1CO connection male faston 6.3mm L 113mm ambient temperature max. 85°C mounting distance 22mm actuating force: 40g		

float switches



GEV No.	379653	Ref. No.	3010024000 3010024500 9090611000
description	float switch 1CO L 90mm mounting ømm 250V 3A male faston 6.3mm cable lengthmm type D42X ambient temperature max. 85°C with float for MP		





1

GEV No.	347248	Ref. No.	90/90611000
description	microswitch 1CO 250V 3A connection male faston 6.3mm with float type D42X ambient temperature max. 85°C lever length 90mm for MP		



1

GEV No.	348026	Ref. No.	3010024500 (alt) 90/90612000
description	float switch kit 1CO ø 25mm L 73mm mounting ø 12mm 250V 10A male faston 6.3mm cable length 1380mm		
spare parts for	348026		
	GEV No.	380812	Ref. No. —
	power relays FINDER 230VAC 30A 2CO connection F6.3 bracket mounting manuf. no. 66.82.8.230.0000		

floats



1

GEV No.	348191	Ref. No.	4063018500
description	float without magnet ø 56mm L 135mm W 56mm H 95mm		



1

GEV No.	348025	Ref. No.	90/20364000
description	float without magnet ømm L 84mm W 30mm H 25mm PVC		

relays



power relays

with male contacts

female contact 2.0mm



1

GEV No.	380494	Ref. No.	—
description	power relays FINDER 230VAC 7A 4CO connection F2 plug-in connection manuf. no. 55.34.8.230.0054 94.74/ZMD4 250V connection 2mm		
accessories for	380494		
	GEV No.	380341	Ref. No. —
	relay socket 4-pole contacts 12 300V voltage AC 6A Italiana Relè manuf. no. ZMD4		
	GEV No.	380399	Ref. No. —
	relay socket 4-pole dimensions 76.2x27x86.1mm 250V voltage AC 1A FINDER manuf. no. 94.94.3		

electronics

PCBs



1

GEV No.	403468	Ref. No.	30/50048000
description	control PCB ice maker MG14 L 49mm W 25mm suitable for STAFF ICE cable length 1400mm Qty 1 pcs		

solenoïd valves

solenoïd valves (water)

ELBI

spare parts and accessories

reducers

outlet side













1

GEV No.	371262	Ref. No.	4012008000
description	reducer ELBI type EATON (INVENSYS) flow rate 2.5l/min pressure range 0 up to 10bar tolerance ±15/25% orange		



			
1			
GEV No.	371260	Ref. No.	40/12005000
description	reducer type ELBI flow rate 0.5l/min pressure range 0 up to 10bar tolerance ±15/25% red		

RPE			
			
1			
GEV No.	374021	Ref. No.	4012022000
description	solenoid valve double straight 230VAC inlet 3/4" outlet 10mm DN10 RPE		

TP			
			
1			
GEV No.	370017	Ref. No.	4012012000
description	solenoid valve single straight 230VAC inlet 3/4" outlet 11.5mm DN10 TP p max 10bar		
spare parts for	370017		
			
GEV No.	371013	Ref. No.	—
description	solenoid coil TP 230VAC 50/60Hz		
accessories for	370017		
			
GEV No.	371220	Ref. No.	—
description	reducer TP flow rate 3l/min red tolerance ±15%		
			
GEV No.	371221	Ref. No.	—
description	reducer TP flow rate 5.5l/min yellow tolerance ±15%		
			
GEV No.	371222	Ref. No.	—
description	reducer TP flow rate 6l/min grey tolerance ±15%		
			
GEV No.	371223	Ref. No.	—
description	reducer TP flow rate 10l/min white tolerance ±15%		
			
GEV No.	371224	Ref. No.	—
description	reducer TP flow rate 12l/min bronze tolerance ±15%		
			
GEV No.	371225	Ref. No.	—
description	reducer TP flow rate 16l/min light brown tolerance ±15%		
			
GEV No.	371226	Ref. No.	—
description	reducer TP flow rate 20l/min red tolerance ±15%		

accessories for	370017		
			
GEV No.	371230	Ref. No.	—
description	reducer TP flow rate 0.25l/min red tolerance ±25%		
			
GEV No.	371231	Ref. No.	—
description	reducer TP flow rate 0.35l/min violet tolerance ±25%		
			
GEV No.	371232	Ref. No.	—
description	reducer TP flow rate 0.5l/min orange tolerance ±25%		
			
GEV No.	371233	Ref. No.	—
description	reducer TP flow rate 0.8l/min white tolerance ±25%		
			
GEV No.	371234	Ref. No.	—
description	reducer TP flow rate 1l/min light blue tolerance ±25%		
			
GEV No.	371235	Ref. No.	4012006000
description	reducer TP flow rate 1.2l/min brown tolerance ±25%		
			
GEV No.	371236	Ref. No.	—
description	reducer TP flow rate 1.5l/min light brown tolerance ±25%		
			
GEV No.	371237	Ref. No.	—
description	reducer TP flow rate 2.5l/min yellow tolerance ±25%		
			
GEV No.	371238	Ref. No.	—
description	reducer TP flow rate 3.4l/min dark green tolerance ±25%		
			
GEV No.	371239	Ref. No.	—
description	reducer TP flow rate 5l/min black tolerance ±25%		
			
GEV No.	371240	Ref. No.	—
description	reducer TP flow rate 8l/min blue tolerance ±20%		

spare parts and accessories			
reducers			
outlet side			
			
1			
GEV No.	371235	Ref. No.	4012006000
description	reducer TP flow rate 1.2l/min brown tolerance ±25%		



metal

CEME

accessories



1

GEV No.	371154	Ref. No.	951342 SL300951342
description	solenoid coil connection male faston 6.3mm CEME 50Hz 230V H 30mm seat ø 10mm voltage AC		

solenoid valves (refrigeration)

various

valve bodies



1

GEV No.	381437	Ref. No.	4011020000
description	solenoid valve body single type CLS 2.5 p maxbar pressure rangebar connection 6mm		

pressure switches

for refrigeration

SAGI NO MIYA



1

GEV No.	541479	Ref. No.	4006013000
description	pressure control HD reset automatic refrigeration type HTB-X114 connection 2.4mm		

fans

refrigeration fans

refrigeration motors universal

accessories

fan wheels

aluminium



1

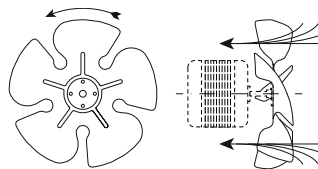

GEV No.	601387	Ref. No.	000233
description	fan wheel sucking ø 254mm fan wheel mounting 25.4mm blade angle 34° W 50mm aluminium		

motors

gear motors

for ice-cube maker

for paddles

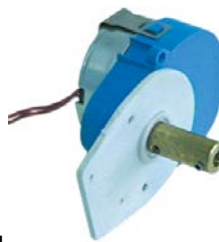

1

GEV No.	500416	Ref. No.	90/82013000
description	gear motor		

1

GEV No.	500415	Ref. No.	90/82014000
description	gear motor FIBER type G0251AMAKOO 12V 50/60Hz 30rpm shaft ø 12mm L 76mm W 52mm H 37mm motor type M51B10R0000		





1

GEV No.	501549	Ref. No.	9082010500
description	gear motor MECHTEX type GB5F 15 230V 50Hz 40rpm shaft ø 12mm rotation direction clockwise		





1

GEV No.	500991	Ref. No.	3004010000
description	gear motor FIBER type GE15JAMAD00 3.9W 230V 50/60Hz 50rpm shaft ø 12mm for ice-cube maker motor type M51BJ0R0000		
accessories for	500991		
	GEV No.	Ref. No.	
	500418	90/20372000	
	bracket for gear motor		



1

GEV No.	501451	Ref. No.	90/82011000 908201100
description	motor FIBER type G025JAMAF00 3.9W 230V 50/60Hz 40rpm shaft ø 12mm for ice-cube maker motor type M51BJ0R0000		
accessories for	501451		
	GEV No.	Ref. No.	
	500418	90/20372000	
	bracket for gear motor		



1

GEV No.	500420	Ref. No.	90/82012000
description	gear motor FIBER type W0100ALAD00 230V 50Hz 5rpm shaft ø 12mm L 52mm W 76mm H 52mm motor type M353		

for sumps



1

GEV No.	500402	Ref. No.	90/82020000
description	gear motor KENTA type IC9113065 69W 230V 50Hz 2rpm shaft ø 14mm W 60mm H 150mm L 150mm		



1

GEV No.	501550	Ref. No.	9082013500
description	gear motor MECHTEX type GB5F 12X 3.9W 230V 50Hz 50rpm shaft ø 12mm for ice-cube maker		

miscellaneous



1

GEV No.	500403	Ref. No.	90/82016000
description	gear motor AUTOM 230V 50Hz shaft ø 8mm L 240mm W 130mm H 60mm		



for drink dispensers



1

GEV No.	499305	Ref. No.	950212 SL300950212
description	gear motor ELCO 70/60W 230V voltage AC 50/60Hz 32/38rpm shaft ø 6x12mm L 225mm W 75mm H 100mm for drink dispenser		

doors



1

GEV No.	694708	Ref. No.	90/90852700
description	door for ice maker W 275mm H 223mm thickness 29mm black		

pumps

pumps for ice machines



1

GEV No.	501465	Ref. No.	30/02021000 9082101000
description	pump FIR type 4262/48 110W 230V 50/60Hz inlet ø 17mm outlet ø 17mm L 210mm capacitor 5µF		

pan mechanics

spare parts and accessories



1

GEV No.	694707	Ref. No.	90/20317000
description	lever for sump L 235mm W 40mm H 74mm suitable for STAFF ICE		

equipment-specific units

for ice-cube maker

gearboxes

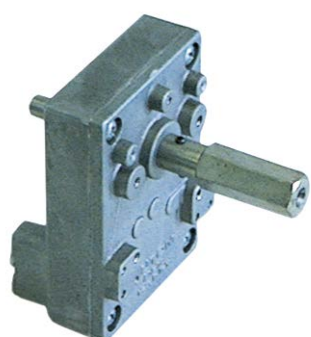

1

GEV No.	500404	Ref. No.	30/05900000
description	gearbox		



1

GEV No.	695001	Ref. No.	90/70331500
description	paddle with spindle		



1

GEV No.	695002	Ref. No.	90/70331700
description	paddle with spindle		





1

GEV No.	695003	Ref. No.	70331800
description	paddle with spindle		





mechanics for evaporators			
miscellaneous			
			
1			
GEV No.	696722	Ref. No.	951752 SL300951752
description	bush for evaporator		

hoses			
hose connectors			
with thread			
			
1			
GEV No.	695052	Ref. No.	40/41319000
description	hose connector		
spare parts for	695052		
	GEV No.	516026	Ref. No. —
O-ring EPDM thickness 2.62mm ID ø 17.86mm Qty 1 pcs			
	GEV No.	516109	Ref. No. —
drain fitting ID ø 23mm			
	GEV No.	516110	Ref. No. —
hose connector hose ø 23mm			

floats			
float containers			
			
1			
GEV No.	695073	Ref. No.	90/87016000
description	float container		
spare parts for	695073		
	GEV No.	346872	Ref. No. —
microswitch with lever 250V 0.1A 1CO connection male faston 6.3mm L 50mm ambient temperature max. 85°C mounting distance 22mm type D41X actuating force: 6g lever length 36mm			

miscellaneous			
			
1			
GEV No.	694709	Ref. No.	90/20352000
description	bracket for ice maker W 18mm H 27mm hole ø 8mm		

			
1			
GEV No.	695043	Ref. No.	90/20319000 90/78054000
description	lever		

for drink dispensers			
bushes			
			
1			
GEV No.	650245	Ref. No.	SL340001653
description	bush for evaporator H 30mm ø 35.5mm D2 ø 21mm		

gaskets			
			
1			
GEV No.	650220	Ref. No.	SL300951857 SL320001630
description	gasket for auger D1 ø 34.5mm D2 ø 26mm ID ø 20mm H 19mm rubber		

			
1			
GEV No.	650164	Ref. No.	950070 SL3GS36007B
description	gasket for evaporator D1 ø 170mm ID ø 160mm H 13mm silicone		

			
1			
GEV No.	650163	Ref. No.	SL300950258 SL3GS12044A SL3GS24044A
description	gasket for outlet tap D1 ø 25mm D2 ø 16mm H 21mm silicone		

for dishwashers

door mechanics

locks



GEV No.	507011	Ref. No.	20/62150000
description	door catch complete door locking catch		

hinges

door bearing



GEV No.	701167	Ref. No.	9016047900
description	bearing block L 67mm W 22mm H 8.5mm mounting pos. bottom right thickness 1mm		

gaskets

O-rings

EPDM

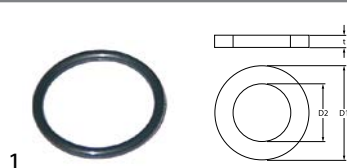

GEV No.	510072	Ref. No.	RICG20141
description	O-ring EPDM thickness 3.53mm ID ø 32.93mm Qty 1 pcs		

silicone

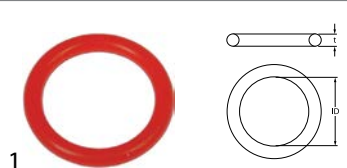

GEV No.	532250	Ref. No.	950194 SL300950194
description	O-ring silicone thickness 2.62mm ID ø 17.13mm Qty 10 pcs		

transmission technology and ball bearings

ball bearings

miscellaneous



GEV No.	691226	Ref. No.	20/08105000
description	ball bearing		



GEV No.	691227	Ref. No.	20/08110000
description	ball bearing		

drive belts

V-belts

profile Z/10



GEV No.	697686	Ref. No.	20/05010000
description	V-belt belt width 10mm L 520mm H 6mm CODE Z20 1/2 profile Z/10		



GEV No.	691224	Ref. No.	20/05011000
description	V-belt belt width 10mm L 635mm H 6mm CODE Z25 profile Z/10		



GEV No.	691225	Ref. No.	20/05012000
description	V-belt belt width 10mm L 710mm H 6mm CODE Z28 profile Z/10		



fastening material

fasteners			
retaining rings			
DIN 471			
			
1			
GEV No.	523107	Ref. No.	SL300950254
description	retaining ring shaft ø 11mm thickness 1mm SS DIN 471		

F

fans	6
fasteners	11
fastening material	11
float switches	3

H

heating elements	3
------------------	---

M

microswitches	3
motors	6

O

O-rings	10
---------	----

P

pressure switches	6
pumps	8
pumps for ice machines	8

R

refrigeration fans	6
refrigeration motors universal	6
refrigeration thermostats	3
relays	4
retaining rings	11

S

solenoid valves	4
switches and momentary switches	3

T

thermostats	3
-------------	---