



GAS COMPONENTS



ELECTRIC COMPONENTS



WATER TECHNOLOGY



MECHANICAL COMPONENTS



TOOLS

Spare parts suitable for

STAR10

Find the complete and up-to-date range of products in our GEV Webshop



Manufacturer catalogue

The most important spare parts and accessories arranged clearly for every manufacturer

- ✓ Complete product range and all appliance data always up to date in the GEV Webshop
- ✓ Alphabetical Index at the end of the catalogue

GEV Webshop

www.gev-online.co.uk

www.gev-online.com



- 🔍 Add to Favourites
- 🔍 Sign In with email address and usual password
- 🔍 Easy-order – place several items in your basket at the same time
- 🔍 Quick Item search – no login needed



heating elements

heating elements for ovens

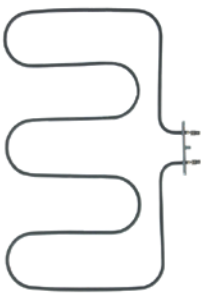

1

GEV No.	416042	Ref. No.	X68203
description	heating element 1500W 230V heating circuits 1 L 365mm W 500mm L1 45mm L2 315mm W1 240mm W2 30mm flange length 100mm flange width 22mm hole distance 86mm hole ø 5mm tube ø 6.3mm connection male faston 6.3mm mounting pos. lower rectangular flange dry heating element oven		
For models:	ACA2006, ACA2010, ACA2011		

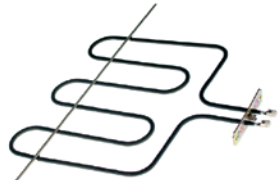

1

GEV No.	418266	Ref. No.	071065
description	heating element 1800W 230V heating circuits 1 L 320mm W 290mm L1 78mm L2 242mm W1 130mm W2 30mm flange length 100mm flange width 22mm hole distance 86mm bridge length 480mm hole ø 5mm tube ø 6.3mm connection male faston 6.3mm windings 3 rectangular flange oven heating element		
For models:	BSC4FC, BSC4FE, BS-C4FE-4563, BSC4FG, BSC6FG		

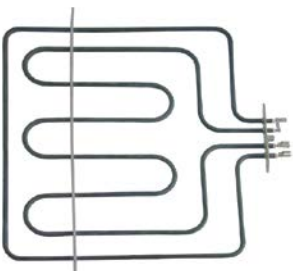

1

GEV No.	416041	Ref. No.	X68202
description	heating element 2600W 230V heating circuits 2 L 350mm W 355mm L1 36mm L2 314mm W1 147mm W2 60mm flange length 100mm flange width 22mm hole distance 80mm bridge length 480mm hole ø 5mm tube ø 6.3mm connection male faston 6.3mm mounting pos. upper rectangular flange dry heating element oven		
For models:	ACA2006, ACA2010, ACA2011		

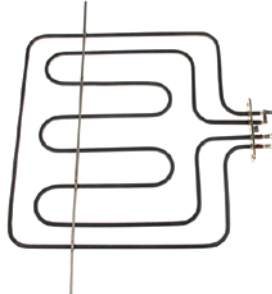

1

GEV No.	418227	Ref. No.	071084
description	heating element 2600W 230V heating circuits 2 L 355mm W 358mm L1 37mm L2 318mm W1 149mm W2 60mm flange length 100mm flange width 22mm hole distance 86mm bridge length 485mm hole ø 5mm tube ø 6.3mm connection male faston 6.3mm mounting pos. upper rectangular flange dry heating element oven		

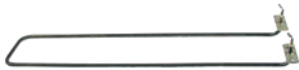

1

GEV No.	416043	Ref. No.	X47000
description	heating element 990W 230V L 475mm W 106mm H 24mm lug length 55mm lug width 18mm hole distance 138mm hole ø 5mm tube ø 6.3mm connection M4 heating circuits 1 bracket mounting oven		
For models:	ACA1004, ACA1005, ACA1006, ACA2007, ADA1004, ADA1005, ADA1006, ADA2005, ADA2008, ADA2010, C89E, K4FFE		

heating elements for bain maries



1



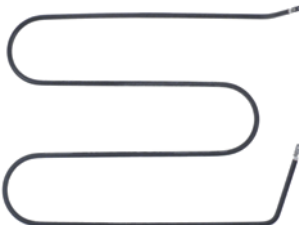



GEV No.	416161	Ref. No.	071007 071027
description	heating element 1000W 230V heating circuits 1 L 430mm W 95mm connection male faston 6.3mm connection distance 40mm connection length 10mm tube ø 6.3mm dry heating element W2 39mm H 36mm		
For models:	BM1, BM1375, BM140, BM1-40-4304, BM1BSI, BM260, BM260BSI, BM3GNI, BM47, BM4GNI, BM67, BME150ZAV, BMZ, BMZ200, BMZ2R, BMZ2R200, BMZ-4030, BMZR, BMZR200, BMZR-4035, CP1BSI, CR32000C, FT140, FT1BSI, FT1C40, FT1CBSI, FT1R40, FT1RBSI, FT2CBSI, FT2LBSI, FT2LRBSI, FT67C, TOPFTC, TOPFTR		





1

GEV No.	419022	Ref. No.	071110
description	heating element 1200W 230V heating circuits 1 L 346mm W 260mm connection distance 170mm tube ø 6.3mm for bain marie H 30mm suitable for immersion heater		

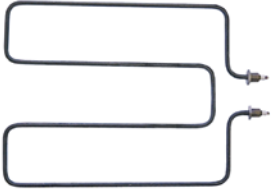

			
GEV No.	415130	Ref. No.	X45800
description	heating element 1500W 230V heating circuits 1 L 412mm W 50mm connection M3 tube \varnothing 8.5mm 2 hole fixing thread 3/8" immersion heater mounting distance 42mm		
For models:	ACB0002, ACB0004, ACB0005		
accessories for	415130		
	GEV No.	361183	Ref. No. —
	nut thread 3/8" H 6mm nickel-plated brass WS 20 Qty 1 pcs		
	GEV No.	521137	Ref. No. —
	flat gasket fibre ED \varnothing 20mm ID \varnothing 18mm thickness 1.5mm for thread 3/8" Qty 1 pcs		
	GEV No.	527169	Ref. No. —
	hexagonal nut thread M3 H 2.8mm WS 5.5 brass Qty 1 pcs		
	GEV No.	560110	Ref. No. —
	plain washer ID \varnothing 3.2mm ED \varnothing 7mm thickness 0.5mm SS Qty 20 pcs DIN 125A for thread M3		
	GEV No.	560130	Ref. No. —
	hexagonal nut thread M3 H 2.4mm WS 5.5 SS DIN/ISO DIN 934 / ISO 4032/8673 Qty 20 pcs		

			
GEV No.	415844	Ref. No.	X45900
description	heating element 2600W 230V heating circuits 1 L 410mm W 300mm connection length 10mm connection M4 tube \varnothing 8.5mm 2 hole fixing thread 3/8" immersion heater L1 27mm L2 383mm W1 120mm W2 60mm mounting distance 50mm		
For models:	ACB0003		
spare parts for	415844		
	GEV No.	521137	Ref. No. —
	flat gasket fibre ED \varnothing 20mm ID \varnothing 18mm thickness 1.5mm for thread 3/8" Qty 1 pcs		
accessories for	415844		
	GEV No.	361183	Ref. No. —
	nut thread 3/8" H 6mm nickel-plated brass WS 20 Qty 1 pcs		

heating elements for crepes makers

			
GEV No.	416157	Ref. No.	071066
description	heating element 2400W 230V L 305mm W 250mm H 60mm tube \varnothing 8.5mm connection M4 connection length 16mm connection distance 225mm dry heating element heating circuits 1 crepes maker		
For models:	CREP1E, CREP1E400, CREP2E		

heating elements for chip scuttles

			
GEV No.	416082	Ref. No.	X48400
description	heating element 350W 230V heating circuits 8.5 L 172mm W 74mm flange length 110mm flange width 22mm hole distance 94mm connection length 20mm connection male faston 6.3mm tube \varnothing 8.5mm rectangular flange hole \varnothing 6mm dry heating element		
For models:	ABD0001, ADC0001, ADC0002, SKP40E		

heating elements for fryers

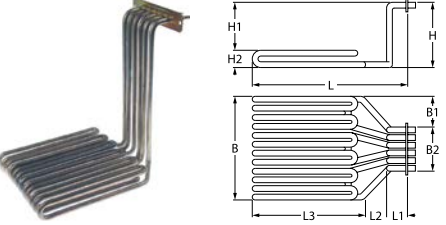
			
GEV No.	417338	Ref. No.	071069
description	heating element 6000W 230/400V heating circuits 3 L 270mm W 188mm H 265mm L1 28mm L2 245mm W1 53mm W2 82mm H1 230mm H2 35mm windings 12 flange length 130mm flange width 28mm hole distance 120mm hole \varnothing 5.5mm connection M5 connection length 31mm tube \varnothing 8.5mm rectangular flange immersion heater		
For models:	F101R, F102R, F18RBSI, F28RBSI, F4710, F6710		

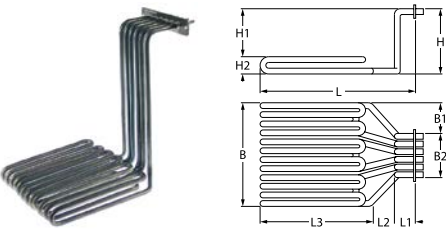
			
GEV No.	418269	Ref. No.	071028
description	heating element 7500W 230/400V heating circuits 3 L 310mm W 180mm H 260mm L1 70mm L2 240mm W2 75mm H1 225mm H2 35mm windings 12 flange length 130mm flange width 30mm hole distance 120mm hole \varnothing 5.5mm connection M5 connection length 35mm rectangular flange immersion heater		



2 hole fixing

1

GEV No.	416169	Ref. No.	071052
description	heating element 3000W 230V heating circuits 1 L 290mm W 160mm H 185mm L1 18mm L2 272mm thread 1/4" mounting distance 144mm tube ø 8.5mm windings 4 2 hole fixing connection M5 fryer heaters		
For models:	F10, F1010, F10-1170, F88M, F88T, F8M, F8T, FE8, FE88, FM8, FM8+8-1241, FM8-1240, FM88		

1

GEV No.	419100	Ref. No.	071109
description	heating element 3000W 230V heating circuits 1 L 355mm W 110mm H 225mm thread 1/4" mounting distance 100mm tube ø 8.5mm windings 3 2 hole fixing connection M5 fryer		
For models:	F25, F40M		

1

GEV No.	416168	Ref. No.	071077	
description	heating element 2500W 230V heating circuits 1 L 222mm W 154mm H 175mm 2 hole fixing connection male faston 6.3mm immersion heater L1 25mm L2 197mm W1 31mm W2 76mm tube ø 8.5mm thread 1/4" mounting distance 60mm connection length 22mm windings 4			
For models:	F6, F6-1120, F66, FC6, FE6, FE66, FE8			
accessories for	416168			
	GEV No.	361182	Ref. No.	—
	nut thread 1/4" H 5mm nickel-plated brass WS 17 Qty 1 pcs			
	GEV No.	510417	Ref. No.	—
	flat gasket fibre ED ø 20mm ID ø 14mm thickness 2mm Qty 1 pcs			
	GEV No.	520228	Ref. No.	—
	tooth lock washer ID ø 15.3mm ED ø 24mm steel Qty 1 pcs for thread M14			
	GEV No.	550262	Ref. No.	—
	flat gasket copper ED ø 20mm ID ø 14mm thickness 2mm			



1

GEV No.	416167	Ref. No.	071055.1	
description	heating element 2500W 230V heating circuits 1 L 275mm W 157mm H 185mm 2 hole fixing connection male faston 6.3mm immersion heater L1 17mm L2 260mm W1 34mm W2 90mm tube ø 9mm thread 1/4" mounting distance 53mm connection length 24mm windings 3			
accessories for	416167			
	GEV No.	361182	Ref. No.	—
	nut thread 1/4" H 5mm nickel-plated brass WS 17 Qty 1 pcs			
	GEV No.	510417	Ref. No.	—
	flat gasket fibre ED ø 20mm ID ø 14mm thickness 2mm Qty 1 pcs			
	GEV No.	520228	Ref. No.	—
	tooth lock washer ID ø 15.3mm ED ø 24mm steel Qty 1 pcs for thread M14			
	GEV No.	550262	Ref. No.	—
	flat gasket copper ED ø 20mm ID ø 14mm thickness 2mm			

1

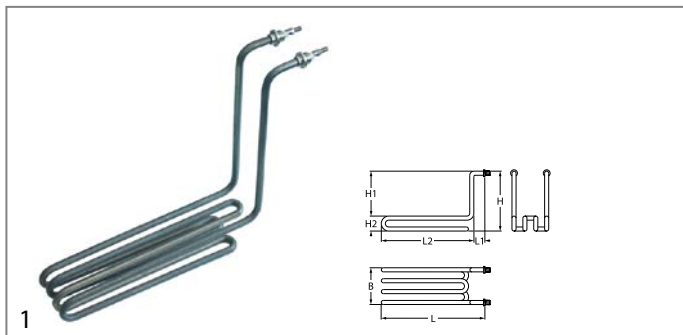
GEV No.	417567	Ref. No.	071001
description	heating element 3000W 230V heating circuits 1 L 290mm W 205mm H 195mm VNR/D1 connection screw immersion heater L1 35mm L2 270mm W1 60mm W2 75mm tube ø 8mm thread M12 windings 3		
For models:	F10, F1010, F10-1170, F88T, F8T		





GEV No.	416172	Ref. No.	071005
description	heating element 3000W 230V heating circuits 1 L 300mm W 80mm H 255mm L1 43mm L2 257mm H1 215mm H2 40mm thread 1/4" mounting distance 67mm tube ø 8.5mm 2 hole fixing connection M5 connection length 12mm immersion heater windings 4		
For models:	F101, F102, F121, F12140, F121-4328, F121-4332, F121-4528, F121M, F121M-4345, F122, F122M, FRY101, FRY102, FRY121M-1171, FRY122, FRY122M-1172		
spare parts for	416172		
	GEV No.	510417	Ref. No. —
	flat gasket fibre ED ø 20mm ID ø 14mm thickness 2mm Qty 1 pcs		
accessories for	416172		
	GEV No.	361182	Ref. No. —
	nut thread 1/4" H 5mm nickel-plated brass WS 17 Qty 1 pcs		
	GEV No.	520228	Ref. No. —
	tooth lock washer ID ø 15.3mm ED ø 24mm steel Qty 1 pcs for thread M14		
	GEV No.	550262	Ref. No. —
	flat gasket copper ED ø 20mm ID ø 14mm thickness 2mm		
	GEV No.	560112	Ref. No. —
	plain washer ID ø 5.3mm ED ø 10mm thickness 1mm SS Qty 20 pcs DIN 125A for thread M5		
	GEV No.	560132	Ref. No. —
	hexagonal nut thread M5 H 4mm WS 8 SS DIN/ISO DIN 934 / ISO 4032/8673 Qty 20 pcs		

heating elements for griddles

	GEV No.	415703	Ref. No.	071044
description	heating element 1000W 230V heating circuits 1 L 333mm W 80mm H 64mm tube ø 6.3mm W1 20mm W2 51mm connection male faston 6.3mm connection length 19mm dry heating element			
For models:	CP67EM-7560			

	GEV No.	416161	Ref. No.	071007 071027
description	heating element 1000W 230V heating circuits 1 L 430mm W 95mm connection male faston 6.3mm connection distance 40mm connection length 10mm tube ø 6.3mm dry heating element W2 39mm H 36mm			
For models:	BM1, BM1375, BM140, BM1-40-4304, BM1BSI, BM260, BM260BSI, BM3GNI, BM47, BM4GNI, BM67, BME150ZAV, BMZ, BMZ200, BMZ2R, BMZ2R200, BMZ-4030, BMZR, BMZR200, BMZR-4035, CP1BSI, CR32000C, FT140, FT1BSI, FT1C40, FT1CBSI, FT1R40, FT1RBSI, FT2CBSI, FT2LBSI, FT2LRBSI, FT67C, TOPFTC, TOPFTR			

	GEV No.	415651	Ref. No.	X45700
description	heating element 1500W 230V heating circuits 1 L 425mm W 72mm H 53mm tube ø 8.5mm L1 22mm connection male faston 6.3mm connection distance 52mm dry heating element			
For models:	ABH3001, ABH3002, ABH3003, ABH3004, ABH3005, ABH3006, ABH3007, ABH3008, ABH3009, ACH3001, ACH3002, ACH3003, ACH3004, ACH3005, ACH3006, ACH3007, ACH3018, ACH3019, ACH3020, SKT40E, SKT40EC, SKT40ER			



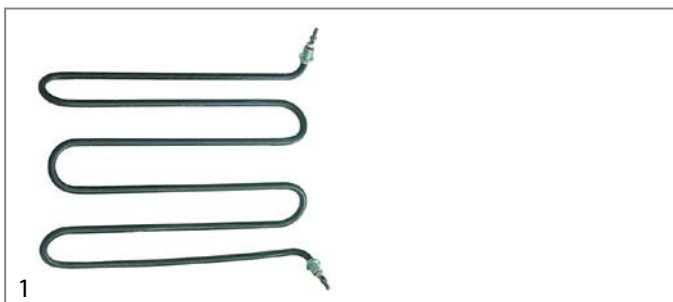

	GEV No.	416046	Ref. No.	Y10400
description	heating element 2350/2560W 220/240V heating circuits 1 L 590mm W 77mm H 80mm tube ø 8.5mm dry heating element			
For models:	ADH3001, ADH3002, ADH3003, ADH3004, ADH3005, ADH3006, AEH3001, AEH3002, AEH3003, AEH3004, AEH3005, AEH3006			

heating elements for gyros grills

	GEV No.	416164	Ref. No.	071085
description	heating element 1500W 230V L 343mm W 74mm H 53mm connection male faston 6.3mm L1 125mm L2 110mm L3 108mm tube ø 6.3mm bracket mounting thread dry heating element			
For models:	GY100E, GY40E, GY60E, GY60E-9830, GY80E, GY80E-9831			



GEV No.	416163	Ref. No.	071067.1 071067/A
description	heating element 2800W 230V L 327mm W 230mm H 68mm connection M6 thread 1/4" tube ø 8.5mm connection length 28mm 2 hole fixing dry heating element mounting distance 295mm		
For models:	GYINO10E, GY-INO10E-9841		

accessories for	416163		
	GEV No.	361182	Ref. No. —
	nut thread 1/4" H 5mm nickel-plated brass WS 17 Qty 1 pcs		
	GEV No.	510417	Ref. No. —
	flat gasket fibre ED ø 20mm ID ø 14mm thickness 2mm Qty 1 pcs		
	GEV No.	520228	Ref. No. —
	tooth lock washer ID ø 15.3mm ED ø 24mm steel Qty 1 pcs for thread M14		
	GEV No.	550262	Ref. No. —
	flat gasket copper ED ø 20mm ID ø 14mm thickness 2mm		



heating elements for hot dog machines



1

GEV No.	416159	Ref. No.	071015
description	heating element 750W 230V L 180mm W 327mm H 6.5mm tube ø 6.3mm W1 137mm W2 50mm connection male faston 6.3mm connection length 19mm dry heating element heating circuits 1		

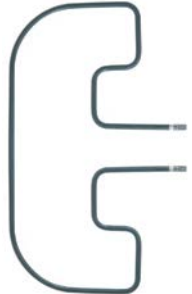

1

GEV No.	416487	Ref. No.	71015
description	heating element 750W 230V L 183mm W 324mm H mm tube ø 6.3mm L1 31mm L2 152mm W1 134mm W2 56mm connection male faston 6.3mm connection distance 51mm dry heating element heating circuits 1		

heating elements for refrigeration

condensing trays heated



1

GEV No.	695271	Ref. No.	Q32-0196
description	condensing tray heated L 410mm W 300mm H 80mm 230V 230W		
For models:	HE140A, HE70A		

heating elements for tilting bratt pan



1

GEV No.	415077	Ref. No.	Y00100
description	heating element stock pot 1300W 230V L 280mm W 150mm H 40mm connection male faston 6.3mm tilting bratt pan heating circuits 1 tube ø 8.5mm bracket mounting hole distance 142mm hole ø 5mm lug length 25mm lug width 15mm		
For models:	ABK1001		



1

GEV No.	416045	Ref. No.	X48100
description	heating element tilting bratt pan 3400W 230V L 313mm W 195mm H 82mm connection M5 dry heating element heating circuits 1 tube ø 10mm W1 67mm W2 61mm		
For models:	ACK2003, BRE70		

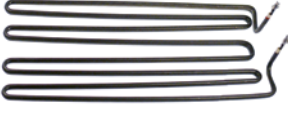

1

GEV No.	417344	Ref. No.	Y10500
description	heating element tilting bratt pan 4700W 230V L 540mm W 210mm H 60mm heating circuits 1 tube ø 8.5mm W1 70mm W2 70mm		
For models:	ADK2001, ADK2002, ADK2003, ADK2004, AEK2001, AEK2002, AEK2003, AEK2004		

heating elements for contact grills



1

GEV No.	416722	Ref. No.	RG.D02140
description	heating element 750W 230V L 175mm W 212mm H 22mm tube ø 6.5mm W1 90mm W2 33mm connection cable cable length 75mm mounting pos. upper dry heating element heating circuits 1		
For models:	WAFFLE1, WAFFLE2		

heating elements for pasta cookers



1









GEV No.	415902	Ref. No.	X47100	
description	heating element 2510W 230V L 295mm W 115mm H mm 2 hole fixing connection male faston 6.3mm thread M14x1 tube ø 8.5mm			
For models:	ACE0003, ACE0004			
accessories for	415902			
	GEV No.	510417	Ref. No.	—
	flat gasket fibre ED ø 20mm ID ø 14mm thickness 2mm Qty 1 pcs			
	GEV No.	520228	Ref. No.	—
	tooth lock washer ID ø 15.3mm ED ø 24mm steel Qty 1 pcs for thread M14			
	GEV No.	521133	Ref. No.	—
	nut thread M14x1.5 H 6mm WS 19 zinc-coated steel Qty 1 pcs			

Table continues overleaf

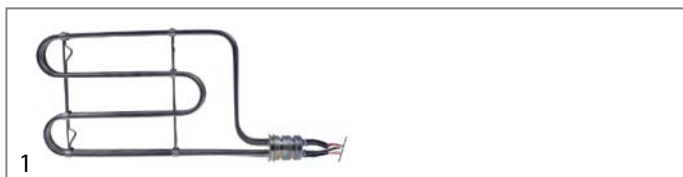

accessories for	415902		
	GEV No.	550261	Ref. No. —
	nut thread M14x1 H 4mm WS 19 SS Qty 1 pcs		
	GEV No.	550262	Ref. No. —
	flat gasket copper ED ø 20mm ID ø 14mm thickness 2mm		



GEV No.	416989	Ref. No.	Y00900
description	heating element 4500W 230/400V heating circuits 3 L 357mm W 200mm H 25mm rotation flange tube ø 6.3mm L1 45mm L2 312mm W1 30mm W2 170mm cable length 570mm connection length 40mm flange length 1 9.6mm flange length 2 35.5mm flange length 45mm flange ø1 44.5mm flange ø2 39.5mm mounting pos. left fryer		
For models:	ACE0008		
accessories for	416989		
	GEV No.	510899	Ref. No. X05400
	O-ring EPDM thickness 3.53mm ID ø 37.69mm Qty 1 pcs		
	GEV No.	528155	Ref. No. X05300
	O-ring Viton thickness 3.53mm ID ø 32.93mm Qty 1 pcs		
	GEV No.	532545	Ref. No. X05000
	O-ring Viton thickness 3.53mm ID ø 49.21mm Qty 1 pcs		
	GEV No.	691621	Ref. No. M29600
	retaining ring shaft ø 40mm thickness 1.8mm steel DIN 471		

heating elements for pizza ovens

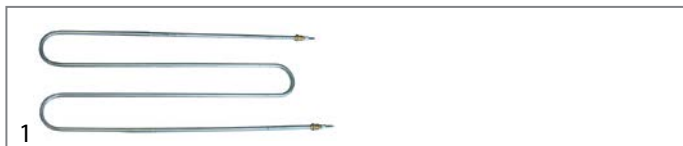

GEV No.	416162	Ref. No.	071083 071083, 076018
description	heating element 1000W 230V L 582mm W 242mm thread 1/4" mounting distance 233.5mm connection length 42mm connection M4 tube ø 8.5mm heating circuits 1 dry heating element 2 hole fixing pizza oven		

heating elements for chargrills







GEV No.	418231	Ref. No.	071025
description	heating element 2300W 230V heating circuits 1 L 457mm W 183mm H 111mm rectangular flange hole distance 76mm hole ø 5mm L1 27mm L2 430mm W1 62mm W2 60mm connection cable cable length 900mm flange length 90mm flange width 40mm tube ø 17x6mm windings 6 dry heating element		
For models:	RG100, RG105, RG80		



GEV No.	418232	Ref. No.	071034
description	heating element 3100W 230V heating circuits 1 L 440mm W 280mm H 105mm rectangular flange hole distance 76mm hole ø 5.5mm L1 30mm L2 410mm W1 93mm W2 62mm connection cable cable length 900mm flange length 90mm flange width 40mm tube ø 17x6mm windings 8 dry heating element		
For models:	RG100, RG70, TOPRG1, TOPRG2		



GEV No.	416000	Ref. No.	Y00200
description	heating element 1500W 230V L 438mm W 80mm H 62mm thread 1/4" mounting distance 19mm tube ø 8.5mm connection male faston 6.3mm windings 2 heating circuits 1 connection length 23mm 2 hole fixing dry heating element		
For models:	ABK3001, ABK3002, ACK3001, ACK3002, ACK3003, ACK3004		
spare parts for	416000		
	GEV No.	510417	Ref. No. —
	flat gasket fibre ED ø 20mm ID ø 14mm thickness 2mm Qty 1 pcs		
accessories for	416000		
	GEV No.	361182	Ref. No. —
	nut thread 1/4" H 5mm nickel-plated brass WS 17 Qty 1 pcs		
	GEV No.	520228	Ref. No. —
	tooth lock washer ID ø 15.3mm ED ø 24mm steel Qty 1 pcs for thread M14		
	GEV No.	550262	Ref. No. —
	flat gasket copper ED ø 20mm ID ø 14mm thickness 2mm		

heating elements for salamanders/toast-

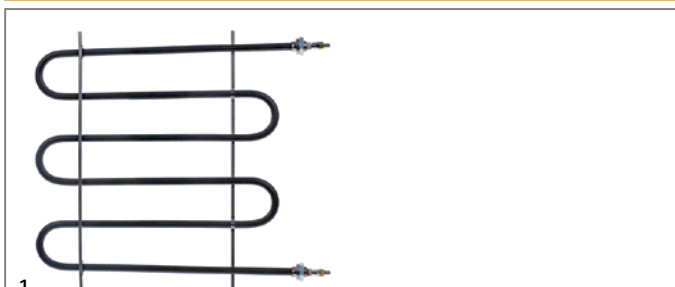







GEV No.	416155	Ref. No.	071019
description	heating element 2000W 230V L 197mm W 263mm 2 hole fixing thread 1/4" mounting distance 255mm connection screw dry heating element tube ø 8.5mm heating circuits 1 connection length 34mm H 8.5mm		
For models:	ST650		
accessories for	416155		
	GEV No.	361182	Ref. No. —
	nut thread 1/4" H 5mm nickel-plated brass WS 17 Qty 1 pcs		
	GEV No.	510417	Ref. No. —
	flat gasket fibre ED ø 20mm ID ø 14mm thickness 2mm Qty 1 pcs		

Table continues overleaf

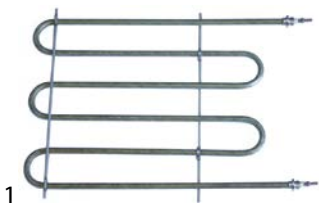

accessories for 416155	
	GEV No. 520228 Ref. No. — tooth lock washer ID ø 15.3mm ED ø 24mm steel Qty 1 pcs for thread M14
	GEV No. 550262 Ref. No. — flat gasket copper ED ø 20mm ID ø 14mm thickness 2mm

	
GEV No.	416154 Ref. No. 071018
description	heating element 2500W 230V L 368mm W 255mm thread 1/4" mounting distance 246mm connection M5 dry heating element tube ø 8.5mm heating circuits 1 connection length 36mm H 8.5mm connection distance 247mm
For models:	S110E-GIGA, ST400

	
GEV No.	416156 Ref. No. 071036
description	heating element 3000W 230V L 600mm W 265mm flange with thread thread 1/4" mounting distance 260mm connection M5 dry heating element tube ø 8.5mm connection length 34mm
For models:	C127E, C2EF, C3EF, C5FE, C87E, S300E-GIGA, ST650B



heating cables

miscellaneous

	
GEV No.	418499 Ref. No. R35-0002
description	heating cable L 7000mm door frame heating 2050hm/m
For models:	HE140A

ceramic heaters

245x60mm

	
GEV No.	415103 Ref. No. 071053 X48000
description	ceramic emitter 650W 230V cable beaded cord L 245mm W 60mm H 35mm
For models:	ABD0001, FWI, SF140, SF1BSI, SF47, SFE, SFE23, SFE23-4088, SKP40E
spare parts for 415103	
	GEV No. 415109 Ref. No. — spring clip

accessories for 415103	
	GEV No. 415110 Ref. No. — reflector L 245mm W 95mm H 31mm thickness 0.75mm hole ø 15x40mm

quartz heating elements

	
GEV No.	416414 Ref. No. 071014
description	quartz heating element 500W 115V L 385mm ø 10mm connection male faston 6.3mm



	
GEV No.	416152 Ref. No. 071014.1
description	quartz heating element 500W 230V L 390mm ø 12mm connection male faston 6.3mm
For models:	CP140, CP1-4330, CP1BSI, CP67EM-7560, SR 11, T23GN, T3, T3-2046, T3-2050, T6, T6-2048, T6-2052, T6CB, TE3, TE3-2072, TE3G-2072G, TE6, TE6G-2073G, TGRILL

	
GEV No.	418834 Ref. No. 071051
description	quartz heating element 600W 230V L 525mm ø 10mm connection male faston 6.3mm
For models:	SAM650, SAM650-2158, T92, T9-2051, WBC

	
GEV No.	416153 Ref. No. 071051.1
description	quartz heating element 600W 230V L 530mm ø 12mm connection male faston 6.3mm
For models:	S9KER, SA650, SA650-2155, SAM650, SAM650-2158, STA650KER, T11GN, T9, T92, T9-2051, T92GN, WBC, WBS

immersion heating elements

3 hole flange ø47.5mm

	
GEV No.	418439 Ref. No. E11500
description	heating element 8000W 230V mounting ø 47.5mm heating circuits 3 L 315mm W 37mm H 35mm number of thermostat sleeves 1 thermostat sleeves ø 8.5mm length thermostat sleeves 215mm thermostat sleeve clinging tube ø 8.5mm hole distance 62mm hole ø 8mm connection M4 3 hole flange immersion heater
For models:	ADL0001, ADL0003, ADL0016, AEL0001
accessories for 418439	
	GEV No. 510408 Ref. No. — O-ring EPDM thickness 5.34mm ID ø 47mm Qty 1 pcs
	GEV No. 510562 Ref. No. — O-ring silicone thickness 5.34mm ID ø 47mm Qty 1 pcs



3 hole flange ø57.5mm

1

GEV No.	416232	Ref. No.	X60500
description	heating element 6000W 230V mounting ø 57.5mm heating circuits 3 L 293mm W 40mm H 36mm number of thermostat sleeves 1 thermostat sleeves ø 7mm length thermostat sleeves 280mm thermostat sleeve eccentric, non clinging tube ø 8.5mm hole distance 74mm hole ø 8x10mm connection M5 3 hole flange immersion heater		
For models:	ABC0004, ACC0004, SKF2E4		
spare parts for	416232		
	GEV No.	510409	Ref. No. —
	O-ring EPDM thickness 5.34mm ID ø 56.52mm Qty 1 pcs		

heating elements for convection

1

GEV No.	418267	Ref. No.	071041
description	heating element 2500W 230V heating circuits 1 ID ø 181mm ED ø 193mm L 208mm H 30mm L1 10mm W1 30mm H1 6mm H2 24mm flange length 70mm flange width 22mm hole distance 56mm connection male faston 6.3mm tube ø 6.3mm convection heating element hole ø 5mm rectangular flange		
For models:	BSC4FC, BSC4FE, BS-C4FE-4563, BSC4FG, BSC4FV, BSC6FG, C127FE, C127FV, C87FE		
spare parts for	418267		
	GEV No.	510368	Ref. No. —
	gasket L 70mm W 23.5mm hole ø 5mm hole distance 56mm FIBER thickness 2mm for heating element		

radiation heaters

1

GEV No.	416165	Ref. No.	071097
description	radiation heater rectangular 1500W 230V L 180mm W 170mm heating circuits 1 connections 2 for gyro grill		

1

GEV No.	416166	Ref. No.	071098
description	radiation heater rectangular 3300W 230V L 380mm W 175mm heating circuits 3 connections 3x 2		
For models:	F4715, F471R, F8715, F871R, FR871R, FRY471R-1164, FT80CBSI, FT87LC, FT87LR, GY30EIR, GY80EIR		

1

GEV No.	418230	Ref. No.	071096
description	radiation heater rectangular 4000W 230V L 425mm W 265mm heating circuits 3 connections 3x 2 IRCA griddle		
For models:	CP1, CP1-4330, CP11, CP47M, CP67EM-7260, CP67EM-7560, CP67M, FT1, FT1-4356, FT1BSI, FT1C, FT1CBSI, FT1CI, FT1R, FT1R-4357, FT1RBSI, FT2CBSI, FT2CI, FT2L, FT2LBSI, FT2LC, FT2LR, FT2LRBSI, FT47C, FT47L, FT47R, FT67C, FT67L, FT67LC, FT67LR, FT80CBSI, FT87LC, FT87LR, FTAL, FTAR, PC127FTE, TOP60FT, TOP60FTC, TOP60FTC-4262, TOP60FTLR, TOP80FTC, TOPFT, TOPFTC, TOPFTR		

1-circuit

1

GEV No.	490045	Ref. No.	071011
description	radiation heater ø 165mm 1200W 230V heating circuits 1 7-position control with temperature signalization connections 4+2 connection type male faston 6.3mm EGO		
For models:	PC1V40, PC1VBISI, PC2V, PC2VBISI, TOP2V		

1

GEV No.	490024	Ref. No.	071011.1
description	radiation heater ø 165mm 1200W 230V heating circuits 1 energy regulation with temperature signalization with heating coil connections 2+2 connection type male faston 6.3mm EGO		
For models:	BM1-40-4304, BM11, BM3I, BM4I, BSC4FV, C127FV, C87FV, PC127V, PC1V40, PC1VBISI, PC2V, PC2VBISI, PC2VI, PC47V, PC4V, PC4VI, PC87V, TOP2V, TOPV		



1

GEV No.	490116	Ref. No.	Y12208
description	radiation heater ø 165mm 1200W 230V heating circuits 1 H 33mm 7-position control with temperature signalization with ribbon heater connections 2+2 connection type male faston 6.3mm CERAMASPEED		
For models:	ABJ0005, ABJ0006		



1

GEV No.	490113	Ref. No.	Y12207
description	radiation heater ø 200mm 1800W 230V heating circuits 1 energy regulation with temperature signalization with ribbon heater connections 2+2 connection type male faston 6.3mm CERAMASPEED		
For models:	ABJ0005, ABJ0006		



1

GEV No.	490047	Ref. No.	071010
description	radiation heater ø 230mm 2100W 230V heating circuits 1 7-position control with temperature signalization connections 4+2 connection type male faston 6.3mm EGO		
For models:	PC1V40, PC1VBSI, PC2V, PC2VBSI, TOP2V		



1

GEV No.	490026	Ref. No.	071010.1
description	radiation heater ø 230mm 2100W 230V heating circuits 1 H 31mm energy regulation with temperature signalization with heating coil connections 2+2 connection type male faston 6.3mm EGO		
For models:	BM2I, BM3I, BM4I, BM60I, BSC4FV, C127FV, C87FV, HP1V, PC127V, PC1V40, PC1VBSI, PC2V, PC2VBSI, PC2VI, PC47V, PC4V, PC4VI, PC87V, TOP2V, TOPV		



1

GEV No.	490050	Ref. No.	Y12408
description	radiation heater ø 250mm 2500W 230V heating circuits 1 with ribbon heater		
For models:	ACA1003, ACA1010, ACJ0006		

2-circuit



1

GEV No.	490114	Ref. No.	Y12409
description	radiation heater ø 230mm 2200W 230V heating circuits 2 energy regulation with temperature signalization partial power 750W with ribbon heater connections 2+2 connection type male faston 6.3mm CERAMASPEED		
For models:	ACA1003, ACA1006, ACA1010, ACJ0006		

hot plates

square & rectangular

with radiused edge



1

GEV No.	490066 ¹	Ref. No.	X45500
description	hot plate dimensions 220x220mm 2600W 230V with spill ring connection 4 screw clamps protector yes square		
For models:	ACA1001, ACA1002, ACA1004, ACA1005		

¹incl. protector



1

GEV No.	490071 ¹	Ref. No.	Y12100
description	hot plate dimensions 300x300mm 4000W 230V with spill ring connection 4 screw clamps protector yes square		
For models:	ADA1001, ADA1003, ADA1004, ADA1006, AEA1001, AEA1003, AEA1005, C89E, K2P, K4FFE, K4P, PC49E, PC89E		

¹incl. protector



round

with radiused edge

for domestic and commercial kitchens

E-G-O



1

GEV No.	490012	Ref. No.	071008 071075
description	hot plate ø 145mm 1500W 230V connection 4 screw clamps with 8mm spill ring		
For models:	BSC4FC, BSC4FE, BS-C4FE-4563, C5FE, PC1E, PC1E-4520, PC1EBSI, PC2E, PC2EBSI, PC4E, TOP2E, TOP4E, TOPE		



1

GEV No.	490018	Ref. No.	071009 071076
description	hot plate ø 220mm 2000W 230V connection 4 screw clamps with 8mm spill ring		
For models:	BSC4FC, BSC4FE, BS-C4FE-4563, C127E, C5FE, HP1, HP1E, HP2E, PC127E, PC1E, PC1E-4520, PC1EBSI, PC2E, PC2EBSI, PC4E, PC87E, TOP2E, TOP4E, TOPE		



1

GEV No.	490020	Ref. No.	X45300
description	hot plate ø 220mm 2600W 230V connection 4 screw clamps with 8mm spill ring		
For models:	ABJ0003, ABJ0004, ACJ0005, ACJ0007, ACJ0008		
accessories for	490020		
	GEV No.	550796	Ref. No. —
fixing plate for hot plate ø220mm			

energy regulators

EGO

1-circuit

E-G-O



1

GEV No.	380015	Ref. No.	073010 Y12206
description	energy regulator 230V 13A single-circuit turn direction right shaft ø 6x4.6mm shaft L 23mm mounting thread M4 power release 6-100% no. 50.57021.010		

2-circuit

E-G-O



1

GEV No.	380027	Ref. No.	Y12406 Y12407
description	energy regulator EGO 230V 13A dual circuit turn direction right shaft ø 6x4.6mm shaft L 23mm mounting thread M4 power release 6-70% no. 50.55021.100		
For models:	ACA1003, ACA1006, ACA1010, ACJ0006		

thermostats

bi-metal thermostats

bi-metal thermostats



1

GEV No.	390158	Ref. No.	072011
description	bi-metal thermostat switch-off temp. 140°C connection M4		

control and safety thermostats

EGO

control thermostats

55.10/19_ series

E-G-O



1

GEV No.	375055	Ref. No.	X43100
description	thermostat t.max. 110°C temperature range 30-110°C 1-pole 1CO 16A probe ø 6mm probe L 130mm capillary pipe 1500mm capillary pipe isolatedmm gland nut shaft L 23mm shaft position upper rotation 318° 250V		
For models:	ACB0002, ACB0003, ACB0004, ACB0005		



GEV No.	375718	Ref. No.	072001 072001.1
description	thermostat t.max. 180°C temperature range 70-180°C 1-pole 1NO 16A probe ø 6mm probe L 87mm capillary pipe 1500mm capillary pipe isolatedmm gland nut shaft ø 6x4.6mm shaft L 23mm shaft position upper rotation 270°		
For models:	BM2I, F101R, F102R, F18RBSI, F25, F28RBSI, F4710, F4715, F47GM, F47IR, F6710, F8715, F87IR, FR87IR, FRY121G, FRY121G-1190, FRY47IR-1164		



GEV No.	375719	Ref. No.	072032 072032, 072024
description	thermostat t.max. 250°C temperature range 48-250°C 1-pole 1NO 16A probe ø 3.03mm probe L 160mm capillary pipe 1270mm capillary pipe isolatedmm gland nut shaft ø 6x4.6mm shaft L 23mm shaft position upper rotation 270°		
For models:	BSC4FE, BSC4FE80, BSC6FG, C127FE, C127FV, C87FE, C87FV, C87VFE, CO1, CO323, CO511, FT1C40, STARROLLY5, STARROLLY8, TOP60FTC, TOP60FTC-4262, TOPFTC		



GEV No.	375720	Ref. No.	072020.1 072051
description	thermostat t.max. 184°C temperature range 80-184°C 1-pole 1NO 16A probe ø 6mm probe L 87mm capillary pipe 570mm capillary pipe isolatedmm gland nut shaft ø 6x4.6mm shaft L 23mm shaft position upper rotation 270°		
For models:	F10, F101, F1010, F10-1170, F102, F121, F12140, F121-4328, F121-4332, F121-4528, F121GM, F121M, F121M-4345, F122, F122GTM, F122M, F25, F4, F40M, F44, F4715, F47GM, F6, F6-1120, F66, F8715, F87GM, F88M, F88T, F8M, F8T, FC4, FC6, FE4, FE44, FE6, FE66, FE8, FE88, FM4, FM4+4-1206, FM4-1205, FM8, FM8+8-1241, FM8-1240, FM88, FRIT0001, FRY101, FRY102, FRY121GM...(Other models you can see in the webshop)		



GEV No.	390068	Ref. No.	X43600
description	thermostat t.max. 269°C temperature range 55-269°C 1-pole 1CO 16A probe ø 3.1mm probe L 219mm capillary pipe 1280mm capillary pipe isolated 1270mm gland nut shaft ø 6x4.6mm shaft L 23mm shaft position upper* rotation 318°		
For models:	ADK2001, ADK2002, ADK2003, ADK2004, ADK2007, ADK2008, ADK2009, ADK2010, AEK2001, AEK2002, AEK2003, AEK2004, AEK2005, AEK2006, AEK2007, AEK2008		



GEV No.	375237	Ref. No.	Y16000
description	thermostat t.max. 190°C temperature range 100-190°C 1-pole 1NO 16A probe ø 6mm probe L 130mm capillary pipe 1800mm capillary pipe isolated 1200mm gland nut M9x1 shaft L 23mm shaft position upper rotation 270°		
For models:	ABC0004, ACC0004, ACC0005, AEC0003, AEC0004, AEC0005, AEC0006, SKF2E4		



GEV No.	375270	Ref. No.	X49800
description	thermostat t.max. 295°C temperature range 45-295°C 1-pole 1NO 16A probe ø 4mm probe L 100mm capillary pipe 900mm capillary pipe isolated 350mm gland nut shaft L 23mm shaft position upper rotation 270°		
For models:	ACK2003, BRE70		



GEV No.	375327	Ref. No.	072005 072005.1
description	thermostat t.max. 297°C temperature range 58-297°C 1-pole 1NO 16A probe ø 3.03mm probe L 219mm capillary pipe 870mm capillary pipe isolatedmm gland nut shaft L 23mm shaft position upper rotation 270°		
For models:	CREP1E, CREP1E400, CREP2E, DOPPIAVTC, FT1, FT140, FT1-4356, FT1B5I, FT1R, FT1R40, FT1R-4357, FT1RBSI, FT2L, FT2LBSI, FT2LR, FT2LRBSI, FT47L, FT47R, FT67L, FT67LR, FT87LR, MEDIAVTC, PANINI1C, PANINI2C, PANINIMC, PANINIMC-2004, PC127FTE, TOP60FTLR, TOPFT, TOPFT60GL, TOPFTGL, TOPFTGLC, TOPFTR		



GEV No.	375330	Ref. No.	072039
description	thermostat t.max. 415°C temperature range 65-415°C 1-pole 1NO 16A probe ø 3.9mm probe L 228mm capillary pipe 870mm capillary pipe isolated 660mm gland nut shaft L 23mm shaft position upper rotation 270°		
For models:	PIZZA41, PIZZA41S, PIZZA42, PIZZA42S, PIZZA61S, PIZZA62, PIZZA62S		

55.13_ series



GEV No.	375723	Ref. No.	10013023740 16001142401
description	thermostat t.max. 320°C temperature range 50-320°C 1-pole 1NO 16A probe ø 3mm probe L 219mm capillary pipe 900mm capillary pipe isolated 700mm gland nut shaft ø 6x4.6mm shaft L 23mm shaft position upper rotation 270°		



GEV No.	375505	Ref. No.	RG.A06042
description	thermostat t.max. 320°C temperature range 50-320°C 1-pole 1NO 16A probe ø 3mm probe L 160mm capillary pipe 870mm capillary pipe isolatedmm gland nut shaft ø 6x4.6mm shaft L 23mm shaft position upper rotation 270°		
For models:	WAFFLE1, WAFFLE2		

55.34_ series



GEV No.	375002	Ref. No.	X68205
description	thermostat t.max. 320°C temperature range 55-320°C 1-pole 1NO 16A probe ø 3.1mm probe L 226mm capillary pipe 870mm capillary pipe isolated 850mm gland nut shaft L 23mm shaft position upper rotation 270°		
For models:	ACA2006, ACA2010, ACA2011		



GEV No.	375097	Ref. No.	X43800
description	thermostat t.max. 195°C temperature range 95-195°C 3-pole 3NO 16A probe ø 6mm probe L 117mm capillary pipe 1780mm capillary pipe isolated 1400mm gland nut M9x1 shaft ø 6x4.6mm shaft L 23mm shaft position upper rotation 270°		
For models:	ABC0003, ABC0005, ACC0003, ACC0008, ACC0009, ACC0010, AEC0001, AEC0002, SKF4E, SKF6E		



GEV No.	375453	Ref. No.	X43200 X43900
description	thermostat t.max. 308°C temperature range 100-300°C 3-pole 3NO 16A probe ø 6mm probe L 75mm capillary pipe 1150mm capillary pipe isolated gland nut shaft ø 6x4.6mm shaft L 23mm rotation 270° probe material SS		
For models:	ABH3001, ABH3002, ABH3003, ABH3004, ABH3005, ABH3006, ABH3007, ABH3008, ABH3009, ABK1001, ACA1004, ACA1005, ACA1006, ACA2007, ACH3001, ACH3002, ACH3003, ACH3004, ACH3005, ACH3006, ACH3007, ACH3018, ACH3019, ACH3020, ADA1004, ADA1005, ADA1006, ADA2005, ADA2008, ADA2010, ADH3001, ADH3002, ADH3003, ADH3004, ADH3005, ADH3006, AEH3001, AEH3002, AEH3003, AEH3004, AEH3005, AEH3006, C89E, K4FFE, SKT40E, SKT40EC, SKT40ER		



GEV No.	390062	Ref. No.	Y16300
description	safety thermostat switch-off temp. 235°C 1-pole 0.5A probe ø 6mm probe L 130mm capillary pipe 1800mm capillary pipe isolated 1500mm gland nut M9x1 probe SS		
For models:	ACC0005, AEC0001, AEC0002, AEC0003, AEC0004, AEC0005, AEC0006		
accessories for	390062		
	GEV No.	551083	Ref. No. —
	cap for safety thermostat thread M8x1		

safety thermostats

55.10/19_ series



GEV No.	375282	Ref. No.	0000X43400
description	safety thermostat switch-off temp. 230°C 1-pole 16A probe ø 11mm probe L 28mm capillary pipe 850mm capillary pipe isolated 830mm gland nut probe screw-in probe probe thread M14x1		
For models:	ACC0001, ACC0002, ACC0006, ACC0007, ADC0001, ADC0002, AEC0007, AEC0008		
accessories for	375282		
	GEV No.	507313	Ref. No. —
	O-ring EPDM thickness 2.62mm ID ø 13.95mm Qty 1 pcs		
	GEV No.	510420	Ref. No. —
	gasket copper ED ø 19.9mm ID ø 14.3mm thickness 2mm Qty 1 pcs		
	GEV No.	521133	Ref. No. —
	nut thread M14x1.5 H 6mm WS 19 zinc-coated steel Qty 1 pcs		



GEV No.	375352	Ref. No.	X49500
description	safety thermostat switch-off temp. 245°C 1-pole 1NC 16A probe ø 6mm probe L 130mm capillary pipe 1200mm capillary pipe isolated 1200mm gland nut probe		
For models:	ABC0003, ABC0004, ABC0005, ACC0003, ACC0004, ACC0008, ACC0009, ACC0010, SKF2E4, SKF4E, SKF6E		

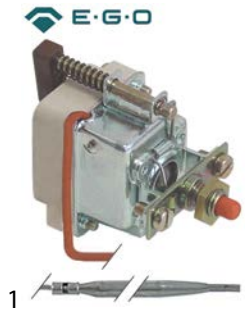

GEV No.	375353	Ref. No.	Y16500
description	safety thermostat switch-off temp. 355°C 1-pole 0.5A probe ø 4mm probe L 120mm capillary pipe 870mm capillary pipe isolated 870mm gland nut probe SS		
For models:	ADH3007, ADH3008, ADH3010, ADH3011, ADK2001, ADK2002, ADK2003, ADK2004, ADK2007, ADK2008, ADK2009, ADK2010, ADL0011, ADL0012, AEH3007, AEH3008, AEH3009, AEH3010, AEH3011, AEH3012, AEK2001, AEK2002, AEK2003, AEK2004, AEK2005, AEK2006, AEK2007, AEK2008, GFT49L, GFT49LC, GFT49R, GFT89L, GFT89LC, GFT89LR, KFT8GLR		

55.32_ series



GEV No.	375290	Ref. No.	072027
description	safety thermostat switch-off temp. 240°C 3-pole 20A probe ø 6mm probe L 87mm capillary pipe 2000mm capillary pipe isolated 1800mm gland nut probe SS		
For models:	F10, F101, F1010, F10-1170, F101R, F102, F102R, F121, F12140, F121-4328, F121-4332, F121-4528, F121M, F121M-4345, F122, F122M, F18RBSI, F25, F25M, F28RBSI, F40M, F4710, F4715, F47GM, F47IR, F6710, F8715, F87IR, F88T, F8T, FR87IR, FRY101, FRY102, FRY121M-1171, FRY122, FRY122M-1172, FRY47IR-1164, FRY47IRG		



GEV No.	375252	Ref. No.	X44800
description	safety thermostat switch-off temp. 350°C 3-pole 20A probe ø 6mm probe L 89mm capillary pipe 3000mm capillary pipe isolated 960mm gland nut probe		
For models:	ABH3001, ABH3002, ABH3003, ABH3004, ABH3005, ABH3006, ABH3007, ABH3008, ABH3009, ACH3001, ACH3002, ACH3003, ACH3004, ACH3005, ACH3006, ACH3007, ACH3018, ACH3019, ACH3020, ADA1004, ADA1005, ADA1006, ADA2005, ADA2008, ADA2010, ADH3001, ADH3002, ADH3003, ADH3004, ADH3005, ADH3006, AEH3001, AEH3002, AEH3003, AEH3004, AEH3005, AEH3006, C89E, K4FFE, SKT40E, SKT40EC, SKT40ER		

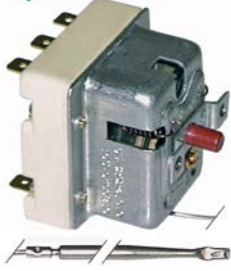

GEV No.	375350	Ref. No.	X49900
description	safety thermostat switch-off temp. 360°C 3-pole 20A probe ø 4mm probe L 120mm capillary pipe 1800mm capillary pipe isolated 1800mm gland nut probe SS		
For models:	ACK2003, BRE70		

56_ series



GEV No.	375263	Ref. No.	072028
description	safety thermostat switch-off temp. 232°C 1-pole 16A probe ø 4mm probe L 91mm capillary pipe 510mm capillary pipe isolated 350mm gland nut		
For models:	F4, F44, F88M, F88T, F8M, FE4, FE44, FE6, FE66, FE8, FE88, FM4, FM8, FM8+8-1241, FM8-1240, FM88		



GEV No.	390610	Ref. No.	072028.1
description	safety thermostat switch-off temp. 235°C 1-pole 16A probe ø 3mm probe L 190mm capillary pipe 1000mm capillary pipe isolated 640mm gland nut probe SS		
For models:	F10, F101, F1010, F10-1170, F121, F121-4528, F121GM, F6, F6-1120, F66, F88T, F8T, FC4, FC6, FE6, FE8, FM4+4-1206, FM4-1205, FRY121G-1190, FRY121GTM-1191, FRY47IRGT-1162		

IMIT / TEMPOMATIC / ARTHERMO

control thermostats

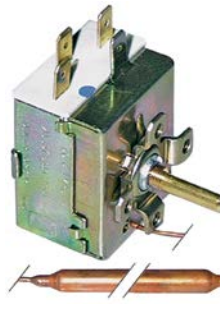

GEV No.	390006	Ref. No.	072029
description	thermostat t.max. 86°C temperature range 0-86°C 1-pole 1CO 16A probe ø 6.5mm probe L 95mm capillary pipe 1500mm capillary pipe isolatedmm gland nut shaft ø 6x4.6mm shaft L 19mm rotation 270°		
For models:	BM1, BM1375, BM140, BM1-40-4304, BM1BSI, BM260, BM260BSI, BM-3GNI, BM3I, BM47, BM4GNI, BMZ200, BMZ2R, BMZ2R200, BMZ-4030, BMZR, BMZR200, BMZR-4035, CR32000C, CR3BMAB, LB350A, LB400, LB400EX, LBP500EX, LP1000, LP1300, LP500E, LP500EX, SVELTINA, TARC12, TARC16, TARC20		
accessories for	390006		



GEV No.	110100	Ref. No.	—
description	knob thermostat t.max. 90°C 0-90°C ø 42mm shaft ø 6x4.6mm shaft flat -135° black		

Table continues overleaf



accessories for	390006			
	GEV No.	110105	Ref. No.	—
	rosette knob ø 42mm ø 56mm zero mark			

accessories

probe clips

spring clips

for thermostat

	1		
GEV No.	550041	Ref. No.	063001
description	probe clip for pipe ø 7mm for probe ø 6mm		
For models:	F10, F101, F1010, F10-1170, F101R, F102, F102R, F121, F12140, F121-4328, F121-4332, F121-4528, F121M, F121M-4345, F122, F122M, F18RBSI, F25, F25M, F28RBSI, F4, F40M, F44, F4710, F6, F6-1120, F66, F6710, F88M, F88T, F8M, F8T, FC4, FC6, FE4, FE44, FE6, FE66, FE8, FE88, FM4, FM4+4-1206, FM4-1205, FM8, FM8+8-1241, FM8-1240, FM88, FRY101, FRY102, FRY121M-1171...(Other models you can see in the webshop)		

	1		
GEV No.	550258	Ref. No.	M86500
description	probe clip for pipe ø 8mm for probe ø 6mm		
For models:	ABC0003, ABC0004, ABC0005, ACC0003, ACC0004, ACC0008, ACC0009, ACC0010, AEC0001, AEC0002, SKF2E4, SKF4E, SKF6E		

capillary tube clips

	1		
GEV No.	550138	Ref. No.	063002
description	capillary tube clip for pipe ø 8.5mm for circular tube heating elements		
For models:	F10, F101, F1010, F10-1170, F101R, F102, F102R, F121, F12140, F121-4328, F121-4332, F121-4528, F121M, F121M-4345, F122, F122M, F18RBSI, F25, F25M, F28RBSI, F4, F40M, F44, F4710, F6, F6-1120, F66, F6710, F88M, F88T, F8M, F8T, FC4, FC6, FE4, FE44, FE6, FE66, FE8, FE88, FM4, FM4+4-1206, FM4-1205, FM8, FM8+8-1241, FM8-1240, FM88, FRY101, FRY102, FRY121M-1171...(Other models you can see in the webshop)		



connecting bows

	1		
GEV No.	550060	Ref. No.	063016
description	connecting bow long for thermostat Qty 1 pcs		
For models:	BSC4FC, BS-C4FE-4563, BSC4FG, BSC4FV, C5FE, FE6, FE8, FR87IR, FT1, FT140, FT1-4356, FT1C, FT1C40, FT1R, FT1R40, FT1R-4357, FT2CI, FT2L, FT2LC, FT2LR, FT47C, FT47L, FT47R, GY30EIR, GY80EIR, PIZZA41, PIZZA41S, PIZZA42, PIZZA42S, PIZZA61S, PIZZA62, PIZZA62S, SP40Y-5008, TOP60FTC, TOP60FTLR		



switches and momentary switches

rocker/momentary rocker switches

30x11mm

	1			
GEV No.	301010	Ref. No.	009973.05	
description	rocker switch mounting measurements 30x11mm red 1NO/indicator light 250V 16A 0-I connection male faston 6.3mm ambient temperature max. 85/125°C protection IP40			
accessories for	301010			
	GEV No.	301035	Ref. No.	—
	protective cover mounting measurements 30x11mm			



30x22mm



	1			
GEV No.	301002	Ref. No.	073013	
description	rocker switch mounting measurements 30x22mm orange 2NO 250V 16A illuminated 0-I connection male faston 6.3mm ambient temperature max. 85/125°C protection IP65			
For models:	BM4I, RG100, RG105, RG70, RG80			
accessories for	301002			
	GEV No.	301036	Ref. No.	—
	protective cover internal size 30x22mm for rocker switch mounting measurementsmm			

	1		
GEV No.	301016	Ref. No.	073025
description	rocker switch mounting measurements 30x22mm orange 2CO 250V 16A illuminated connection male faston 6.3mm ambient temperature max. 125/55°C protection IP40		
For models:	BSC4FC, BSC4FE, BS-C4FE-4563, BSC4FG, BSC4FV, BSC6FG, C5FE		



	1		
GEV No.	301060	Ref. No.	073004
description	rocker switch mounting measurements 30x22mm red 2NO 250V 16A illuminated connection male faston 6.3mm ambient temperature max. 125/55°C protection IP40		
For models:	BMC, BMCR, BMCR-4042, BME100, BME100C, BME23100, BME23150, BMZ, BMZ200, BMZ2R, BMZ2R200, BMZ-4030, BMZR, BMZR200, BMZR-4035, COMP2GN, COMP2GN-9805, COMP3E, COMP3E-9746, COMP3GN, COMP3GN-9806, CP67EM-7260, CP67EM-7560, CP67M, CSP80-A-5001, DIAM1, DIAM150, DIAM150-9770, DIAM2, DIAM-2GCSS, DIAM2PG, DIAM2PG-9795, DIAM3, DIAM3PG, DIAM3PG-9796, DIAM4, DIAM40-9755, DIAM40BT-9748, DIAM60, DIAM75, DIAM75-2P-9798, DIAM75-9765, DIAM75BT-9815, DIAMV120, DIAM-V120-9853, DIAMV165, DIAM-V165-9785, DIAMV220, DIAM-V220-9786, F4...(Other models you can see in the webshop)		



labelled			
			
1			
GEV No.	300125	Ref. No.	R25-0010 X50800
description	rocker switch mounting measurements 30x22mm green 2NO 230V 16A 0-I connection male faston 6.3mm ambient temperature max. 125/55°C protection IP65 with cover cap		
For models:	ABD0001, ACB0002, ACB0003, ACB0004, ACB0005, ADC0001, ADC0002, HD140A, HD70A, HE140A, HE70A, SKP40E		
accessories for	300125		
	GEV No.	301036	Ref. No. —
	protective cover internal size 30x22mm for rocker switch mounting measurementsmm		



			
1			
GEV No.	345747	Ref. No.	073009 073018
description	rocker switch mounting measurements 30x22mm red/red 1NO/NO 250V 16A with LED 0-I/0-II connection male faston 6.3mm ambient temperature max. 125/55°C protection IP40		
For models:	T3, T3-2046, T3-2050, T6, T6-2048, T6-2052, TE3-2072, TE3G-2072G, TE6, TE6G-2073G		
accessories for	345747		
	GEV No.	301036	Ref. No. —
	protective cover internal size 30x22mm for rocker switch mounting measurementsmm		

push/momentary push switches

ø22mm			
			
1			
GEV No.	401357	Ref. No.	AM.F2138
description	momentary push switch mounting measurements ø22mm 1NO/1NC/indicator light 400V 4A indicator lamp 24V 0-I connection screw ambient temperature max. 125/55°C protection IP40		
For models:	FGS106, TG12, TG12R, TS12, TS22		
spare parts for	401357		
	GEV No.	346181	Ref. No. —
	push button mounting ø 21mm external size 30x55mm oval		
accessories for	401357		
	GEV No.	401709	Ref. No. —
	protective cover external size 57x32mm internal size 47x22mm matt finish rubber H 27.5mm		



microswitches

pin-plunger actuated

M10			
			
1			
GEV No.	345678	Ref. No.	073003 073017
description	microswitch with plunger thread M10x0.75 thread L 16mm 250V 16A 1NO connection male faston 6.3mm stroke 2.5mm mounting distance 22mm ambient temperature max. 125°C actuating force: 290g		
For models:	BSC6FG, CO511, CO511Y, F10, F101, F1010, F10-1170, F101R, F102, F102R, F121, F12140, F121-4328, F121-4332, F121-4528, F121M, F121M-4345, F122, F122M, F18RBSI, F25, F25M, F28RBSI, F4, F40M, F44, F4710, F6, F6-1120, F66, F6710, F8715, F88M, F88T, F8M, F8T, FC4, FC6, FE4, FE44, FE6, FE66, FE8, FE88, FM4, FM4+4-1206, FM4-1205, FM8, FM8+8-1241, FM8-1240...(Other models you can see in the webshop)		
accessories for	345678		
	GEV No.	100779	Ref. No. —
	nut thread M10x0.75 H 3mm WS 14 SS Qty 2 pcs		

			
1			
GEV No.	345032	Ref. No.	FX.1519
description	microswitch with plunger thread M10x1 thread L 12mm 250V 16A 1CO connection male faston 6.3mm stroke 7mm mounting distance 22mm L 28mm ambient temperature max. 125°C type SP9603 actuating force: 180g		
For models:	ABR511		

M12

			
1			
GEV No.	345350	Ref. No.	R31600
description	microswitch with plunger mounting distance 22mm thread M12x0.75 thread L 16mm 250V 16A 1CO connection male faston 6.3mm stroke 4mm ambient temperature max. 125°C type EF83161.3 actuating force: 66g		
For models:	ABK3001, ABK3002, ACK3001, ACK3002, ACK3003, ACK3004		
accessories for	345350		
	GEV No.	345351	Ref. No. —
	nut thread M12x0.75 H 1.6mm WS 14 chrome-plated brass Qty 1 pcs		



with push button

switches with snap-fit



GEV No.	346772	Ref. No.	R25-0086
description	microswitch with push button 250V 5A 1CO connection male faston 4.8mm L 24x27mm ambient temperature max. 85°C actuating force: 160g		
For models:	HD140A, HD70A, HE140A, HE70A		

cam switches

on/off



GEV No.	301115	Ref. No.	073015.46
description	cam switch 2 operating positions 2NO sequence 0-1 16A shaft ø 6x4.6mm shaft L 23mm connection male faston 6.3mm		
For models:	F6, F6-1120, F66, FC4, FC6, FE4, FE44, FE6, FE66, FE8, FE88, FM4, FM4+4-1206, FM4-1205, FM8, FM8+8-1241, FM8-1240, FM88, PANINI1C, PANINIMC, PANINIMC-2004		



GEV No.	300129	Ref. No.	073016
description	cam switch 2 operating positions 2NO sequence 0-1 16A shaft ø 6x4.6mm shaft L 23mm connection male faston 6.3mm ceramic		
For models:	BM1, BM1375, BM140, BM1-40-4304, BM11, BM260, BM3GNI, BM3I, BM47, BM4GNI, BM4I, BM60I, BM67, BME23100, CO323, CO511, CO60C, CP1, CP1-4330, CP1I, CP67GM, CREP1E, CREP1E400, DOPPI-AVTC, F10, F101, F1010, F10-1170, F101R, F102, F102R, F121, F12140, F121-4328, F121-4332, F121-4528, F121M, F121M-4345, F122, F122GTM, F122M, F18RBSI, F28RBSI, F47GM, F47IR, F88M, F88T, F8M, F8T, FRY101...(Other models you can see in the webshop)		

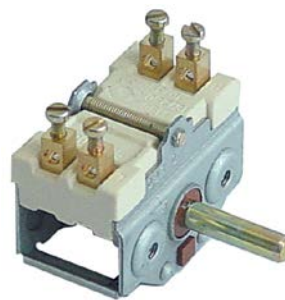

GEV No.	300151	Ref. No.	X51300
description	cam switch 2 operating positions 2NO sequence 0-1 16A shaft ø 6x4.6mm shaft L 23mm connection screw ceramic		
For models:	ADK2001, ADK2002, ADK2003, ADK2004, ADK2007, ADK2008, ADK2009, ADK2010, AEK2001, AEK2002, AEK2003, AEK2004, AEK2005, AEK2006, AEK2007, AEK2008		



GEV No.	300176	Ref. No.	073005
description	cam switch 2 operating positions 4NO sequence 0-1 16A shaft ø 6x4.6mm shaft L 23mm connection screw		
For models:	CP1-4330, CP47M, CP67EM-7260, CP67EM-7560, CP67M, CREP2E, F101R, F102R, F18RBSI, F25, F25M, F28RBSI, F40M, F4710, F4715, F47IR, F6710, F8715, F87IR, FT67L, FT67LC, FT67LR, FT87LC, FT87LR, RG100, RG105, RG70, RG80		

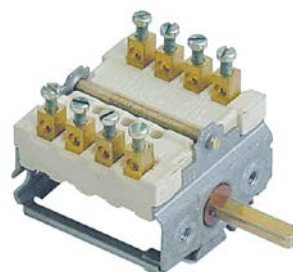

GEV No.	345665	Ref. No.	X40700
description	cam switch 2 operating positions 4NO sequence 0-1 16A shaft ø 6x4.6mm shaft L 23mm connection screw		
For models:	ABK3001, ACK3001, ACK3004		

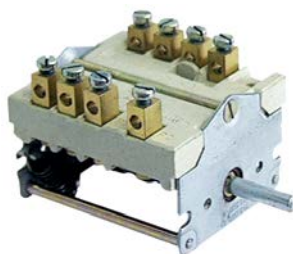

GEV No.	300095	Ref. No.	X40600
description	cam switch ON-OFF connection screw clamp		
For models:	ABK3002, ACK3002, ACK3003		

4-position



GEV No.	300007	Ref. No.	X44000
description	cam switch 4 operating positions 1NO/2CO sequence 0-1-2-3 16A shaft \varnothing 6x4.6mm shaft L 23mm connection male faston 6.3mm 4-position ceramic		
For models:	ACE0003, ACE0004, ACE0008, ADE0003, ADE0004, AEE0001, AEE0002		



GEV No.	300023	Ref. No.	073055
description	cam switch 4 operating positions 1NO/2CO sequence 0-1-2-3 16A shaft \varnothing 6x4.6mm shaft L 23mm connection screw 4-position ceramic		



7-position



GEV No.	300004	Ref. No.	X54100
description	cam switch 7 operating positions 1NO/2CO sequence 0-1-2-3-4-5-6 16A shaft \varnothing 6x4.6mm shaft L 23mm connection male faston 6.3mm 7-position ceramic		
For models:	ABJ0003, ABJ0004, ACA1001, ACA1002, ACA1004, ACA1005, ACJ0005, ACJ0007, ACJ0008, ADA1001, ADA1003, ADA1004, ADA1006, AEA1001, AEA1003, AEA1005, C89E, K2P, K4FFE, K4P, PC49E, PC89E		



GEV No.	300025	Ref. No.	073007
description	cam switch 7 operating positions 1NO/2CO sequence 0-1-2-3-4-5-6 16A shaft \varnothing 6x4.6mm shaft L 23mm connection screw 7-position ceramic		
For models:	BSC4FC, BSC4FE, BS-C4FE-4563, C127E, C1E, C2E, C2EF, C3E, C3EF, C5FE, C87E, HP1, HP1E, HP2E, PC127E, PC1E, PC1E-4520, PC1EBSI, PC1V40, PC1VBSI, PC2E, PC2EBSI, PC2V, PC2VBSI, PC47E, PC4E, PC87E, TOP2E, TOP2V, TOP4E, TOPE, TOPV, WBC		
accessories for	300025		
	GEV No.	112172	Ref. No. —
	knob universal \varnothing 70mm black without adaptor/dial plate		

accessories for	300025		
	GEV No.	112213	Ref. No. —
	knob dial plate silver switch 7-position t.max.°C° ED 63mm ID 45.5mm		
	GEV No.	112311	Ref. No. —
	knob adapter shaft \varnothing 6x4.6mm L 0mm with spring		

4 operating positions



GEV No.	300081	Ref. No.	X44100
description	cam switch 4 operating positions 3NO/2CO sequence 0-1-2-3 16A shaft \varnothing 6x4.6mm shaft L 23mm connection screw		
For models:	ACA1004, ACA1005, ACA1006, ACA2007, ADA1004, ADA1005, ADA1006, ADA2005, ADA2008, ADA2010, C89E, K4FFE		

10 operating positions



GEV No.	345666	Ref. No.	073034 X68204
description	cam switch 10 operating positions 6NO/1CO sequence 0-1-2-3-4-5-6-7-8-9 8A shaft \varnothing 6x4.6mm shaft L 23mm connection male faston 6.3mm plastic		
For models:	ACA2006, ACA2010, ACA2011, BSC4FE80, C127FE, C127FV, C87FE, C87FV, C87VFE		

operation switches



GEV No.	300002	Ref. No.	X40900
description	cam switch 2 operating positions 4NO 16A sequence 0-1 shaft \varnothing 6x4.6mm shaft L 23mm connection male faston 6.3mm ceramic		
For models:	ABH3001, ABH3002, ABH3003, ABH3004, ABH3005, ABH3006, ABH3007, ABH3008, ABH3009, ABK1001, ACH3001, ACH3002, ACH3003, ACH3004, ACH3005, ACH3006, ACH3007, ACH3018, ACH3019, ACH3020, ACK2003, BRE70, SKT40E, SKT40EC, SKT40ER		

1

GEV No.	300080	Ref. No.	X49700
description	cam switch 2 operating positions 4NO 16A sequence 0-1 shaft \varnothing 6x4.6mm shaft L 23mm connection screw operation switch ceramic ambient temperature max. 150°C		
For models:	ACA1004, ACA1005, ACA1006, ACA2007, ADA1004, ADA1005, ADA1006, ADA2005, ADA2008, ADA2010, ADH3001, ADH3002, ADH3003, ADH3004, ADH3005, ADH3006, AEH3001, AEH3002, AEH3003, AEH3004, AEH3005, AEH3006, C89E, K4FFE		
accessories for	300080		
		GEV No.	551456 Ref. No. —
	gasket for switch ED \varnothing 14mm ID \varnothing 2.5mm thickness 3.5mm white		



1

GEV No.	300200	Ref. No.	073015
description	operation switch 2 operating positions 2NO 16A sequence 0-1 shaft \varnothing 6x4.6mm shaft L 23mm connection male faston 6.3mm operation switch ceramic		
For models:	BSC4FC, BSC4FE, BS-C4FE-4563, BSC4FG, BSC4FV, BSC6FG, C5FE, CG312E, CO1, CP67EM-7560, F49E, F89E, FE6, FE8, FR87IR, FT1, FT140, FT1-4356, FT1BSI, FT1C, FT1C40, FT1CBSI, FT1R, FT1R40, FT1R-4357, FT1RBSI, FT2CBSI, FT2CI, FT2L, FT2LBSI, FT2LC, FT2LR, FT2LRB-SI, FT47C, FT47L, FT47R, GY80EIR, PIZZA41, PIZZA41S, PIZZA42, PIZZA42S, PIZZA61S, PIZZA62, PIZZA62S, SP40Y, SP40Y-5008, SP80Y, TOP60FT, TOP60FTC, TOP60FTC-4262...(Other models you can see in the webshop)		



1

GEV No.	300091	Ref. No.	Y16200
description	operation switch EGO 2 operating positions 2NO 16A sequence 0-1 shaft \varnothing 6x4.6mm shaft L 23mm connection screw ceramic		

control equipment

GENERAL ELECTRIC (AEG)



1



GEV No.	345779	Ref. No.	079003
description	contact block GENERAL ELECTRIC P9B10VN 1NO max 400V 10A brown		
For models:	SAM650, SAM650-2158, SAM650G, SAM650G-2623		

GIOVENZANA

switches (complete)



1

GEV No.	401357	Ref. No.	AM.F2138
description	momentary push switch mounting measurements \varnothing 22mm 1NO/1NC/indicator light 400V 4A indicator lamp 24V 0-1 connection screw ambient temperature max. 125/55°C protection IP40		
For models:	FGS106, TG12, TG12R, TS12, TS22		
spare parts for	401357		
		GEV No.	346181 Ref. No. —
	push button mounting \varnothing 21mm external size 30x55mm oval		
accessories for	401357		
		GEV No.	401709 Ref. No. —
	protective cover external size 57x32mm internal size 47x22mm matt finish rubber H 27.5mm		

lamps

indicator lights

indicator lights (complete)

\varnothing 9mm





1

GEV No.	359136	Ref. No.	076025
description	indicator light \varnothing 9mm 230V green connection male faston 6.3mm temp.-resist. 120°C		
For models:	BM1, CO323, CO60FU, CO80FU, DOPPIAVTC, F101R, F102R, F121-4328, F121-4332, F121GM, F121M-4345, F25, F88T, FE6, FRIT0001, FRY121M-1171, FRY122M-1172, FT140, FT1C40, FT1R40, GEM646X, GY-INO10E-9841, LB350A, LB400, LB400EX, LBP500EX, LP1000, LP1000X, LP1300, LP500E, LP500EX, MEDIAVTC, RAP1500, RAP400, RAP450, RAP600, RG100, RG80, SA650-2155, SVELTINA, TOPFTC, TOPFTR		

			
1			
GEV No.	359137	Ref. No.	076026
description	indicator light ø 9mm 230V yellow connection male faston 6.3mm temp.-resist. 120°C with lens		
For models:	BM1, BMZ2R200, BMZR200, CO60FU, CO80FU, CP140, DOPPIAVTC, F101R, F102R, F121-4328, F121-4332, F121GM, F121M-4345, F25, F88T, FRIT0001, FRY121M-1171, FRY122M-1172, FT140, FT1C40, FT1R40, GY-INO10E-9841, LB350A, LB400, LP1000, LP1000X, LP1300, LP500E, LP500EX, MEDIAVTC, PC1E, PC1V40, PC2E, PC2V, RAP1500, RAP400, RAP450, RAP600, RG100, RG80, SA650-2155, STARROLLY5, STARROLLY8, SVELTINA, TOP2E, TOP2V, TOPFTC, TOPFTR		

ø12mm
with screw socket

			
1			
GEV No.	359026	Ref. No.	076004
description	indicator light ø 12mm 230V red connection male faston 6.3mm model CM/5		
For models:	CP47GM, CP67GM, F121GM, F122GTM, F47GM, F87GM, FRY121G, FRY121G-1190, FRY121GM, FRY47IRG, TOPFTGL, TOPFTGLC		

			
1			
GEV No.	359048	Ref. No.	076006
description	indicator light ø 12mm 230V yellow connection male faston 6.3mm		
For models:	BM1, BM1375, BM140, BM1-40-4304, BM1BSI, BM11, BM260, BM260BSI, BM21, BM3GNI, BM31, BM47, BM4GNI, BM41, BM60I, BM67, BMCR-4042, BME150ZAV, BME23100, BMZ, BMZ200, BMZ2R, BMZ-4030, BMZR, BMZR200, BMZR-4035, BSC4FC, BSC4FE, BS-C4FE-4563, BSC4FE80, BSC4FG, BSC4FV, C127E, C127FE, C127FV, C1E, C2E, C2EF, C3EF, C5FE, C87E, C87FE, C87FV, C87VFE, CG312E, CO60C, CP1, CP140, CP1-4330, CP1BSI...(Other models you can see in the webshop)		

			
1			
GEV No.	359027	Ref. No.	076005
description	indicator light ø 12mm 250V green connection male faston 6.3mm		
For models:	BM1, BM1375, BM140, BM1-40-4304, BM1BSI, BM11, BM260, BM260BSI, BM21, BM3GNI, BM31, BM47, BM4GNI, BM41, BM60I, BM67, BSC4FC, BSC4FE, BS-C4FE-4563, BSC4FE80, BSC4FG, BSC4FV, C127E, C127FE, C1E, C2EF, C3EF, C5FE, C87E, C87FE, C87FV, C87VFE, CG312E, CO60C, CP1, CP140, CP1-4330, CP1BSI, CP11, CP47GM, CP47M, CP67EM-7260, CP67EM-7560, CP67GM, CP67M, CR32000C, CREP1E, CREP1E400, CREP2E, F10...(Other models you can see in the webshop)		

with plug-in socket			
			
1			
GEV No.	359041	Ref. No.	RG.A08009 X50900
description	indicator light ø 12mm green 230V connection male faston 6.3mm temp.-resist. 120°C Qty 1 pcs		
For models:	ABC0003, ABC0004, ABC0005, ABH3001, ABH3002, ABH3003, ABH3004, ABH3005, ABH3006, ABH3007, ABH3008, ABH3009, ABJ0003, ABJ0004, ABJ0005, ABJ0006, ABK1001, ABK3001, ABK3002, ACA1001, ACA1002, ACA1003, ACA1004, ACA1005, ACA1006, ACA1010, ACA2006, ACA2007, ACA2010, ACA2011, ACC0003, ACC0004, ACC0005, ACC0008, ACC0009, ACC0010, ACE0003, ACE0004, ACE0008, ACH3001, ACH3002, ACH3003, ACH3004, ACH3005, ACH3006, ACH3007, ACH3018, ACH3019, ACH3020, ACJ0005...(Other models you can see in the webshop)		

			
1			
GEV No.	359043	Ref. No.	RG.A08008
description	indicator light ø 12mm red 230V connection male faston 6.3mm temp.-resist. 120°C Qty 1 pcs		
For models:	WAFFLE1, WAFFLE2		

			
1			
GEV No.	359042	Ref. No.	X41200
description	indicator light ø 12mm yellow 230V connection male faston 6.3mm temp.-resist. 120°C Qty 1 pcs		
For models:	ABC0003, ABC0004, ABC0005, ABH3001, ABH3002, ABH3003, ABH3004, ABH3005, ABH3006, ABH3007, ABH3008, ABH3009, ABK1001, ABK3001, ABK3002, ACA1004, ACA1005, ACA1006, ACA2006, ACA2007, ACA2010, ACA2011, ACB0002, ACB0003, ACB0004, ACB0005, ACC0003, ACC0004, ACC0005, ACC0008, ACC0009, ACC0010, ACH3001, ACH3002, ACH3003, ACH3004, ACH3005, ACH3006, ACH3007, ACH3018, ACH3019, ACH3020, ACK2003, ACK3001, ACK3002, ACK3003, ACK3004, ADA1004, ADA1005, ADA1006...(Other models you can see in the webshop)		

screw-on/push-on fit

light bulbs
for ovens

			
1			
GEV No.	359610	Ref. No.	076007
description	light bulb t.max. 300°C socket E14 15W 230V ø 22mm L 47mm lens L 20mm for oven lamp type Philips		
For models:	BSC4FE, BSC6FG, CO60C, CO60FU, CO80FU		



linear lamps

halogen lamps



1			
GEV No.	359305	Ref. No.	076018
description	halogen lamp socket R7s L 78.3mm 230V 60W IMPORT		
For models:	PIZZA41, PIZZA41S, PIZZA42, PIZZA42S, PIZZA61S, PIZZA62, PIZZA62S		

fluorescent lamps

fluorescent lamps

G23



1			
GEV No.	359933	Ref. No.	009973.03
description	fluorescent lamp socket G23 L 237mm 11W 230V		

oven lamps

universal oven lamps

mounting diameter 35.5mm



1			
GEV No.	359718	Ref. No.	076008
description	oven lamp mounting ø 35.5mm 230V 15W socket E14 temp.-resist. 300°C connection male faston 6.3mm hard glas		
For models:	BSC4FE, BSC6FG		
spare parts for	359718		
	GEV No.	359701	Ref. No.
			—
	lamp socket socket E14 220-230V mounting ø 35.5mm connection male faston 6.3mm 15W		
	GEV No.	359740	Ref. No.
			—
	light bulb t.max. 300°C socket E14 15W 230V ø 22mm L 48mm lens L 20mm for oven lamp IMPORT		

lamps

light bulbs



1			
GEV No.	359610	Ref. No.	076007
description	light bulb t.max. 300°C socket E14 15W 230V ø 22mm L 47mm lens L 20mm for oven lamp type Philips		
For models:	BSC4FE, BSC6FG, CO60C, CO60FU, CO80FU		

residual heat indicators



1			
GEV No.	359326	Ref. No.	Y12506
description	residual heat indicator 4-fold		
For models:	ACA1006, ACA1010		



1			
GEV No.	359096	Ref. No.	Y12209 Y12410
description	residual heat indicator single		
For models:	ABJ0005, ABJ0006, ACA1003, ACJ0006		

timers

mechanical timers



1			
GEV No.	350032	Ref. No.	073008
description	timer M2 2-pole operation time 15min impulse mechanical 2NO at 250V 16A permanent position no shaft ø 6x4.6mm shaft 6x4.6mm shaft L 18mm mounting distance 28mm connection rear		
For models:	S9KER, ST450A, T11GN, T23GN, T3, T3-2046, T3-2050, T6, T6-2048, T6-2052, T6CB, T9, T92, T9-2051, T92GN, TE3, TE3-2072, TE3G-2072G, TE6, TE6G-2073G		
accessories for	350032		
	GEV No.	110366	Ref. No.
			—
	knob switch zero mark t.max. °C ø 44mm shaft ø 6x4.6mm shaft flat upper black		
	GEV No.	110371	Ref. No.
			—
	dial plate graduation 15min permanent position no rotation 30-330° ø 60mm timers knob ø 45mm		



contactors

GENERAL ELECTRIC (AEG)

power contactors



1

GEV No.	380244	Ref. No.	Y10000
description	power contactor resistive load 25A 230VAC (AC3/400V) 9A/4kW main contacts 3NO auxiliary contacts 1NO connection screw connection type AEG LS4K 10A type GE CL00A 310		
For models:	ACC0005, ADK2001, ADK2002, ADK2003, ADK2004, AEC0003, AEC0004, AEC0005, AEC0006, AEK2001, AEK2002, AEK2003, AEK2004		



1

GEV No.	380262	Ref. No.	Y11100
description	power contactor resistive load 32A 230VAC (AC3/400V) 17A/7.5kW main contacts 3NO auxiliary contacts 1NC connection screw connection type AEG LS7K01A type GE CL02A 301 H 85mm		
For models:	ACC0005, ADK2001, ADK2002, ADK2003, ADK2004, AEC0003, AEC0004, AEC0005, AEC0006, AEK2001, AEK2002, AEK2003, AEK2004		



1

GEV No.	380261	Ref. No.	X55300
description	power contactor resistive load 32A 230VAC (AC3/400V) 17A/7.5kW main contacts 3NO auxiliary contacts 1NO connection screw connection type AEG LS7K 10A type GE CL02A 310		
For models:	ACK2003, BRE70		

ISKRA (FANAL)

power contactors



1

GEV No.	380213	Ref. No.	073050
description	power contactor resistive load 20A 230VAC (AC3/400V) 8.5A/5.5kW main contacts 3NO auxiliary contacts 1NO connection screw connection type Fanal DSL7 10 type ISKRA K07M 10		
For models:	BM3I, BM4I, BME150ZAV, CO511Y, CP1, CP140, CP1-4330, CP1I, CP47M, CP67EM-7260, CP67EM-7560, CP67M, F10, F101, F1010, F10-1170, F101R, F102, F102R, F121, F12140, F121-4328, F121-4332, F121-4528, F121M, F121M-4345, F122, F122M, F18RBSI, F25, F25M, F28RBSI, F40M, F4710, F4715, F47GM, F47IR, F6710, F8715, F87IR, F88T, F8T, FR87IR, FRY101, FRY102, FRY121M-1171, FRY122, FRY122M-1172, FRY47IR-1164, FRY47IRG...(Other models you can see in the webshop)		

relays

power relays

with bracket mounting



1

GEV No.	380687	Ref. No.	R35-0253
description	power relays FINDER 230VAC 30A 2NO connection F6.3 bracket mounting manuf. no. 66.82.8.230.0300		
For models:	HD140A, HD70A, HE140A		



electronic controllers

ELIWELL

refrigeration controllers

built-in version



1

GEV No.	378022	Ref. No.	R35-0156
description	electronic controller ELIWELL type ID974 mounting measurements 71x29mm 230V voltage AC NTC/PTC front measurements 33x75mm protection IP65 -50 up to +150°C display 3½ digits		
For models:	HD140A, HD70A, HE140A, HE70A		

EVCO - EVERY CONTROL

refrigeration controllers

built-in version



1

GEV No.	378126	Ref. No.	072061
description	electronic controller EVERY CONTROL type EVK201N7 mounting measurements 71x29mm 230V voltage AC NTC/PTC relay outputs 1 CO-16A(5) NTC/PTC front measurements 33x75mm built-in depth 59mm protection IP65 -40 up to +105°C display 3½ digits		
For models:	COMP2GN, COMP2GN-9805, COMP3E, COMP3E-9746, COMP3GN, COMP3GN-9806, DIAM1, DIAM150, DIAM150-9770, DIAM2, DIAM-2GCS, DIAM2PG, DIAM2PG-9795, DIAM3, DIAM3PG, DIAM3PG-9796, DIAM4, DIAM40-9755, DIAM60, DIAM75, DIAM75-2P-9798, DIAM75-9765, DIAMV120, DIAM-V120-9853, DIAMV165, DIAM-V165-9785, DIAMV220, DIAM-V220-9786, SALAD108, SALAD95		
accessories for	378126		
	GEV No.	Ref. No.	—
	379053		
	temperature probe PTC 1kOhm cable PVC probe -50 up to +150°C cable -10 up to 100°C probe ø6x30mm cable length 3m without screw connection 2-wire		
	GEV No.	Ref. No.	—
	379064		
	temperature probe PTC 1kOhm cable silicone probe -50 up to +150°C cable -50 up to +180°C probe ø6x40mm cable length 3m without screw connection 2-wire		
	GEV No.	Ref. No.	R35-0227
	379161		
	temperature probe NTC 10kOhm cable thermoplastic probe -40 up to +110°C cable -40 up to +110°C probe ø6x14mm cable length 3m without screw connection 2-wire		
	GEV No.	Ref. No.	—
	379782		
	temperature probe PTC 1kOhm cable thermoplastic probe -50 up to +150°C cable -40 up to +110°C probe ø6x14mm cable length 3m 2-wire resistor 1kOhm		

probes

universal probes

temperature probes



GEV No.	379161	Ref. No.	R35-0227
description	temperature probe NTC 10kOhm cable thermoplastic probe -40 up to +110°C cable -40 up to +110°C probe ø6x14mm cable length 3m without screw connection 2-wire		
For models:	HD140A, HD70A, HE140A		

producer-specific probes

probes



GEV No.	402191	Ref. No.	FR.62040411
description	temperature probe PTC 2kOhm cable TPE probe -50 up to +150°C cable -40 up to +110°C connection plug thread probe ø5x20mm cable length 1.8m		
For models:	FL8025		



GEV No.	402005	Ref. No.	FR.62040410
description	temperature probe PTC 2kOhm cable TPE probe -50 up to +150°C cable -40 up to +110°C connection plug thread probe ø6x50mm cable length 1.6m		
For models:	FL8025		

Hall sensors



1

GEV No.	402044	Ref. No.	FR.62040403
description	Hall sensor L 29mm W 26mm H 26mm mounting distance 10mm cable length 1250mm		
For models:	FL8025		



electronics

housing for PCBs



1

GEV No.	694356	Ref. No.	009973.09
description	housing for PCB L 144mm W 130mm H 75mm plastic		

PCBs



1

GEV No.	692027	Ref. No.	009451.42
description	PCB dough rolling machine STP30/40 new edition 230V		
For models:	STP30, STP40		



1

GEV No.	401359	Ref. No.	AM.F2140
description	PCB meat mincer/cheese grater T12 230V		
For models:	FGS106, TG12, TG12R, TS12, TS22		



1

GEV No.	401360	Ref. No.	AM.F2141
description	PCB Mod.12 400V		
For models:	TS12		



1

GEV No.	401358	Ref. No.	AM.F2027
description	PCB Mod.8 230V		
For models:	TS8		

central units



1

GEV No.	402004	Ref. No.	FR.62046202	
description	control box			
For models:	FL8025			
accessories for	402004			
	GEV No.	402005	Ref. No.	FR.62040410
	temperature probe PTC 2kOhm cable TPE probe -50 up to +150°C cable -40 up to +110°C connection plug thread probe ø6x50mm cable length 1.6m			
	GEV No.	402044	Ref. No.	FR.62040403
	Hall sensor L 29mm W 26mm H 26mm mounting distance 10mm cable length 1250mm			
	GEV No.	402191	Ref. No.	FR.62040411
	temperature probe PTC 2kOhm cable TPE probe -50 up to +150°C cable -40 up to +110°C connection plug thread probe ø5x20mm cable length 1.8m			



1

GEV No.	402942	Ref. No.	074154
description	control box for vegetable slicer 230V for Star 10		



keypads

front foils



1

GEV No.	401587	Ref. No.	009451.41
description	keypad foil dough rolling machine STP 30/40 P30/40/45/35 Start/Stop L 100mm W 80mm		
For models:	STP30, STP40		

membrane keypads



1

GEV No.	401356	Ref. No.	AM.F2033
description	membrane keypad		
For models:	TS8		

keypad units



1

GEV No.	401356	Ref. No.	AM.F2033
description	membrane keypad		
For models:	TS8		

solenoïd valves

solenoïd valves (refrigeration)

CEME

valves

with pipe clamp



1

GEV No.	370380	Ref. No.	R30-0031
description	solenoid valve straight CEME type 6806 230V p max 25bar connection 6mm soldering connection -45 up to +125°C refrigeration 50Hz		
For models:	HD140A, HD70A		

compressors

ACC/ZEL

R404a/R507

HMBP monophase

High/Medium evaporation temperature above -20/-15 °C



1

GEV No.	605014	Ref. No.	Q32-0434
description	compressor coolant R404a/R507 type ML80TB 220-240V 50Hz HMBP fully hermetic 11.4kg 3/8HP cylinder capacity 7.57cm ³ CSIR H 175.5mmW 261W 346W 446W 561W 691W 835W 993W 1167W test method ASHRAE ambient temperature max. 43°C		
For models:	HD140A		

CUBIGEL

R404a/R507

HMBP monophase

High/Medium evaporation temperature above -20/-15 °C



1

GEV No.	605013	Ref. No.	Q32-0438
description	compressor coolant R404a/R507 type ML60TB 220-240V 50Hz HMBP fully hermetic 10.1kg 1/4HP power input 647W cylinder capacity 5.68cm ³ CSIR H 175.5mmW 244W 319W 407W 511W 628W 760W 906W 1067W test method ASHRAE		
For models:	HD70A		



evaporation and condensing trays

condensing trays heated

producer-specific



1

GEV No.	695271	Ref. No.	Q32-0196
description	condensing tray heated L 410mm W 300mm H 80mm 230V 230W		
For models:	HE140A, HE70A		

fans



hot air fans

miscellaneous

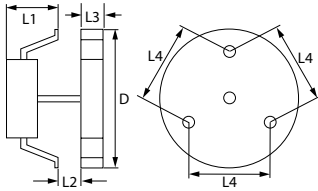

1



GEV No.	601054	Ref. No.	X68003
description	hot air fan 220-240V 32W 50/60Hz L1 60mm L2 10mm L3 25mm L4 87mm fan wheel ø 150mm FIME type C20X0E01/46		
For models:	ACA2006, ACA2010, ACA2011		
spare parts for	601054		
	GEV No.	601441	Ref. No. —
	fan wheel ø 150mm W 25mm shaft intake ø 6x5mm stainless steel blades 7		
accessories for	601054		
	GEV No.	550879	Ref. No. —
	insulation ø 130mm thickness 3mm hole ø 20mm for hot air fan		



1

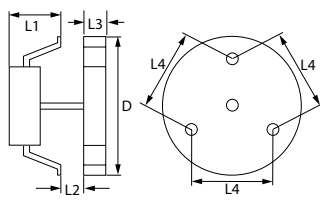

GEV No.	601123	Ref. No.	079510 079529
description	hot air fan 220-240V 47W 50/60Hz L1 80mm L2 12mm L3 20mm L4 87mm fan wheel ø 150mm FIME type C30R6086		
For models:	BSC4FC, BSC4FE, BS-C4FE-4563, BSC4FG, BSC4FV, BSC6FG, C127FE, CO60C		
spare parts for	601123		
	GEV No.	550879	Ref. No. —
	insulation ø 130mm thickness 3mm hole ø 20mm for hot air fan		

motors

gear motors

for grills



1

GEV No.	500498	Ref. No.	079501
description	gear motor shaft ø 24mm L 180mm W 105mm H 95mm		



for gyros grills



1			
GEV No.	500868	Ref. No.	079515
description	gear motor BITRON type 323 4W 230V 50/60Hz 2.4rpm shaft ø 9mm shaft diameter 6x6mm L 81mm W 57mm H 31mm		
For models:	GY20EIR, GY30EIR, GYINO10E, GY-INO10E-9841, GYINO10G, GYINO30G, GYROS-10G-9842, GYROS-20G-9843, TTC		



1			
GEV No.	500869	Ref. No.	079513
description	gear motor KENTA type K9113077 21W 230V 50Hz 0.5rpm shaft ø 8.5mm L 152mm W 60mm H 110mm for gyro grill		
For models:	GY100E, GY100G, GY40E, GY40G, GY60E, GY60E-9830, GY60G, GY70G, GY80E, GY80E-9831, GY80EIR, GY80G, GY90EIR, GY90G, GYROS-100G-9828, GYROS-40G-9825, GYROS-60G-9826, GYROS-80G-9827		

motors

for kebab knife



1			
GEV No.	401864	Ref. No.	079523
description	motor for kebab knife shaft ø 20mm flange ø 50mm type 314101 L 103mm MAXON		

pumps

pumps for ice machines



1			
GEV No.	500047	Ref. No.	FR.62043300
description	pump REBO type MH30F1 30W 230V 50Hz outlet ø 12.7mm L 135mm rotation direction left		
For models:	FI186, FI238, FI3013, FI4016, FI5018, FI9030		

electric accessories

terminals

connection terminals with screw/faston connections



1			
GEV No.	550278	Ref. No.	X52400
description	power terminal block 3-pole max. 40A max 400V connection ø6mm² / F6.3 temp.-resist. 150°C cross section 6mm²		
For models:	ABD0001, ACA2006, ACA2010, ACA2011, ACB0002, ACB0003, ACB0004, ACB0005, ADC0001, ADC0002, SKP40E		



1			
GEV No.	550411	Ref. No.	X52300 X59000
description	power terminal block 6-pole max. 40A max 450V connection ø6mm² / F6.3 temp.-resist. 150°C cross section 6mm²		
For models:	ABC0004, ABH3001, ABH3002, ABH3003, ABH3004, ABH3005, ABH3006, ABH3007, ABH3008, ABH3009, ABJ0003, ABJ0004, ABJ0005, ABJ0006, ABK1001, ABK3001, ABK3002, ACA1001, ACA1002, ACA1003, ACA1010, ACC0004, ACE0003, ACE0004, ACE0008, ACH3001, ACH3002, ACH3003, ACH3004, ACH3005, ACH3006, ACH3007, ACH3018, ACH3019, ACH3020, ACJ0005, ACJ0006, ACJ0007, ACJ0008, ACK3001, ACK3002, ACK3003, ACK3004, ADA1001, ADA1002, ADA1003, ADA1004, ADA1005, ADA1006, ADA2005...(Other models you can see in the webshop)		

connection terminals with screw connection



1			
GEV No.	550495	Ref. No.	077014
description	connection terminal 4-pole max. 15A max 500V connection screw temp.-resist. 150°C		
For models:	HP1		



1			
GEV No.	550507	Ref. No.	X59100
description	power terminal block 4-pole max. 40A max 400V connection M6/M6 temp.-resist. 150°C		
For models:	AEC0001, AEC0002, AEC0003, AEC0004, AEC0005, AEC0006		



rail-mounted terminals

rail-mounted terminal blocks



1			
GEV No.	550407	Ref. No.	0000X53900
description	rail-mounted terminal block 5-pole cross section 16mm ² max 600V		
For models:	ABC0003, ABC0005, ACA1006, ACC0003, ACC0005, ACC0008, ACC0009, ACC0010, ADK2001, ADK2002, ADK2003, ADK2004, AEC0001, AEC0002, AEC0003, AEC0004, AEC0005, AEC0006, AEK2001, AEK2002, AEK2003, AEK2004, SKF4E, SKF6E		

various



1			
GEV No.	550408	Ref. No.	X52500
description	power terminal block		
For models:	ABC0003, ABC0005, ACC0003, ACC0005, ACC0008, ACC0009, ACC0010, SKF4E, SKF6E		

gas taps

PEL

20S series



1			
GEV No.	101491	Ref. No.	0000X10100 0000X10400 1000X10100 2000X10100
description	gas tap PEL type 20S gas inlet M16x1.5 (tube ø 10mm) bypass nozzle ø 0.35mm gas outlet M16x1.5 (tube ø 10/8mm) thermocouple connection M9x1 pilot connection shaft ø 8x6.5mm shaft L 22/15mm shaft flat lower		
For models:	ABJ0001, ABJ0002, ACA2004, ACA2006, ACA2008, ACA2010, ACA2011		
spare parts for	101491		
	GEV No.	100408	Ref. No.
	bypass nozzle type PEL20/21 bore ø 0.35mm thread M5x0.5		
	GEV No.	101060	Ref. No.
	magnet unit standard L 39mm D1 ø 15.4mm D2 ø 11mm suitable for PEL20-21/JUNKERS/EGA		
	GEV No.	101205	Ref. No.
	gas tap front part shaft ø 8x6.5mm shaft L 22/15mm shaft flat upper/lower suitable for PEL20		
	GEV No.	101231	Ref. No.
	thermocouple nut T1: M9x1 T2: M18x1		

accessories for	101491		
	GEV No.	101287	Ref. No.
	olive for pipe ø 6mm Qty 1 pcs		
	GEV No.	101300	Ref. No.
	union nut thread M16x1.5 tube ø 10mm		
	GEV No.	101450	Ref. No.
	olive for pipe ø 8mm L 12.7mm Qty 1 pcs ED ø 10mm		
	GEV No.	101451	Ref. No.
	union nut thread M16x1.5 tube ø 8mm		
	GEV No.	110081	Ref. No.
	knob ø 70mm shaft ø 8x6.5mm shaft flat universal		
	GEV No.	110083	Ref. No.
	knob dial plate gas tap without ignition flame silver		









21S series



1			
GEV No.	101397	Ref. No.	0000X10500 0000X10800 062116 2000X10500 3000X10500 X08100
description	gas tap PEL type 21S gas inlet M16x1.5 (tube ø 10mm) bypass nozzle ø 0.35mm gas outlet M16x1.5 (tube ø 10/8mm) thermocouple connection M9x1 pilot connection M10x1 shaft ø 8x6.5mm shaft L 22/15mm shaft flat lower		
For models:	ABH1001, ABH1002, ABH3010, ABH3011, ABH3012, ABH3014, ABH3015, ABH3016, ABH3017, ABH3018, ACA2001, ACA2002, ACA2003, ACA2012, ACH1001, ACH1002, ACH1003, ACH1004, ACH3008, ACH3010, ACH3011, ACH3013, ACH3014, ACH3015, ACH3017, ACJ0001, ACJ0003, ADA2001, ADA2002, ADA2003, ADA2004, ADA2005, ADA2006, ADA2007, ADA2008, ADA2009, ADA2010, ADA2017, ADH1001, ADH1002, AEA2001, AEA2002, AEA2003, AEA2004, AEA2005, AEH1001, AEH1002, C129FG, C89FG, GFTL11070...(Other models you can see in the webshop)		
spare parts for	101397		
	GEV No.	100408	Ref. No.
	bypass nozzle type PEL20/21 bore ø 0.35mm thread M5x0.5		
	GEV No.	101060	Ref. No.
	magnet unit standard L 39mm D1 ø 15.4mm D2 ø 11mm suitable for PEL20-21/JUNKERS/EGA		
	GEV No.	101206	Ref. No.
	gas tap front part shaft ø 8x6.5mm shaft L 22/15mm shaft flat upper/lower suitable for PEL21		
	GEV No.	101231	Ref. No.
	thermocouple nut T1: M9x1 T2: M18x1		
accessories for	101397		
	GEV No.	100908	Ref. No.
	union screw thread M10x1 for pipe ø 4mm Qty 1 pcs		

Table continues overleaf









accessories for		101397	
	GEV No.	100909	Ref. No. —
union screw thread M10x1 for pipe ø 6mm Qty 1 pcs			
	GEV No.	101246	Ref. No. —
olive for pipe ø 4mm Qty 1 pcs			
	GEV No.	101278	Ref. No. —
olive for pipe ø 10mm Qty 1 pcs			
	GEV No.	101286	Ref. No. —
olive ID ø 6mm Qty 1 pcs			
	GEV No.	101300	Ref. No. —
union nut thread M16x1.5 tube ø 10mm			
	GEV No.	101450	Ref. No. —
olive for pipe ø 8mm L 12.7mm Qty 1 pcs ED ø 10mm			
	GEV No.	101451	Ref. No. —
union nut thread M16x1.5 tube ø 8mm			
	GEV No.	110081	Ref. No. —
knob ø 70mm shaft ø 8x6.5mm shaft flat universal			
	GEV No.	112206	Ref. No. —
knob dial plate silver gas tap PEL21/22/23 t.max.°C ED ø 63mm ID ø 45.5mm			

22S/O series



1

GEV No.	101086	Ref. No.	0000Y21400 0000Y21500
description	gas tap PEL type 22S/O gas inlet M20x1.5 (tube ø 12mm) bypass nozzle ø 0.35mm gas outlet M20x1.5 (tube ø 12/10mm) thermocouple connection M9x1 pilot connection M10x1 shaft ø 10x8mm shaft L 25/17mm shaft flat lower		
For models:	ACE0001, ADE0001, CP49G, CP89G		
spare parts for		101086	
	GEV No.	100259	Ref. No. —
bypass nozzle type PEL22 bore ø 0.35mm thread M6x0.5			
	GEV No.	101058	Ref. No. —
magnet unit L 39mm D1 ø 15.4mm D2 ø 13.5mm suitable for PEL22/EGA24197 standard			
	GEV No.	101201	Ref. No. —
gas tap front part shaft ø 10x8mm shaft L 25/17mm shaft flat upper/lower suitable for PEL22			
	GEV No.	101231	Ref. No. —
thermocouple nut T1: M9x1 T2: M18x1			
	GEV No.	101240	Ref. No. —
gas connection thread M20x1.5 tube ø 12/10mm for PEL gas taps with gasket and screws horizontal			
	GEV No.	101460	Ref. No. —
O-ring ø 12.37mm D1 ø 2.62mm suitable for PEL22			

spare parts for		101086	
	GEV No.	101461	Ref. No. —
screw kit suitable for PEL22 Qty 4 pcs			
accessories for		101086	
	GEV No.	100908	Ref. No. —
union screw thread M10x1 for pipe ø 4mm Qty 1 pcs			
	GEV No.	100909	Ref. No. —
union screw thread M10x1 for pipe ø 6mm Qty 1 pcs			
	GEV No.	101241	Ref. No. —
gas connection thread M20x1.5 tube ø 12/10mm for PEL gas taps vertical			
	GEV No.	101246	Ref. No. —
olive for pipe ø 4mm Qty 1 pcs			
	GEV No.	101248	Ref. No. —
olive for pipe ø 12mm Qty 1 pcs suitable for PEL			
	GEV No.	101249	Ref. No. —
olive for pipe ø 10mm Qty 1 pcs			
	GEV No.	101250	Ref. No. —
union nut thread M20x1.5 for pipe ø 10mm			
	GEV No.	101251	Ref. No. —
union nut thread M20x1.5 for pipe ø 12mm			
	GEV No.	101286	Ref. No. —
olive ID ø 6mm Qty 1 pcs			
	GEV No.	110080	Ref. No. —
knob ø 70mm shaft ø 10x8mm shaft flat universal			
	GEV No.	112206	Ref. No. —
knob dial plate silver gas tap PEL21/22/23 t.max.°C ED ø 63mm ID ø 45.5mm			

23S/V series



1





GEV No.	101093	Ref. No.	0000Y21300
description	gas tap PEL type 23S/V gas inlet M28x1.5 (tube ø 20mm) bypass nozzle ø 0.35mm thermocouple connection M10x1 pilot connection M10x1 shaft ø 10x8mm shaft L 25/17mm shaft flat lower		
For models:	ADL0006, ADL0007, ADL0013, AEL0004, AEL0005		
spare parts for		101093	
	GEV No.	100455	Ref. No. —
bypass nozzle type PEL23/24 bore ø 0.35mm thread M8x0.5			
	GEV No.	101059	Ref. No. —
magnet unit T1: M10x1 T2: M22x1 L 46mm ø 18mm suitable for PEL23S M10x1			

Table continues overleaf

spare parts for		101093	
	GEV No.	101204	Ref. No. —
gas tap front part shaft ø 10x8mm shaft L 25/17mm shaft flat upper/lower suitable for PEL235			
	GEV No.	101245	Ref. No. —
gas connection thread M24x1.5 tube ø 12/16mm vertical for PEL gas taps			
	GEV No.	101463	Ref. No. —
screw suitable for PEL235 Qty 4 pcs			
	GEV No.	528455	Ref. No. —
O-ring Viton thickness 2.62mm ID ø 18.72mm Qty 1 pcs			
accessories for		101093	
	GEV No.	100908	Ref. No. —
union screw thread M10x1 for pipe ø 4mm Qty 1 pcs			
	GEV No.	100909	Ref. No. —
union screw thread M10x1 for pipe ø 6mm Qty 1 pcs			
	GEV No.	101246	Ref. No. —
olive for pipe ø 4mm Qty 1 pcs			
	GEV No.	101252	Ref. No. —
union nut thread M24x1.5 for pipe ø 12mm			
	GEV No.	101253	Ref. No. —
union nut thread M24x1.5 PEL for pipe ø 16mm			
	GEV No.	101254	Ref. No. —
union nut thread M28x1.5 tube ø 20mm			
	GEV No.	101255	Ref. No. —
olive for pipe ø 12mm Qty 1 pcs			
	GEV No.	101256	Ref. No. —
olive for pipe ø 16mm Qty 1 pcs			
	GEV No.	101257	Ref. No. —
olive for pipe ø 20mm Qty 1 pcs			
	GEV No.	101286	Ref. No. —
olive ID ø 6mm Qty 1 pcs			
	GEV No.	110080	Ref. No. —
knob ø 70mm shaft ø 10x8mm shaft flat universal			
	GEV No.	112206	Ref. No. —
knob dial plate silver gas tap PEL21/22/23 t.max.°C ED ø 63mm ID ø 45.5mm			

SIRAL



1		GEV No.	101699	Ref. No.	062140
description					
gas tap SIRAL gas inlet pipe flange ø16mm bypass nozzle ø 0.85mm gas outlet 1/4" (tube ø 8mm) front fixing thermocouple connection M8x1 shaft ø 8x6.5mm shaft L 23/12mm shaft flat upper					
For models:					
GY100G, GY40G, GY60G, GY80G, GYINO10G, GYROS-100G-9828, GYROS-10G-9842, GYROS-20G-9843, GYROS-40G-9825, GYROS-60G-9826, GYROS-80G-9827					
spare parts for		101699			
	GEV No.	101051	Ref. No.	—	
magnet unit L 27mm D1 ø 12.5mm D2 ø 8.5mm suitable for JUNKERS/EGA/MADEC/SABAF standard					
accessories for		101699			
	GEV No.	101277	Ref. No.	—	
olive ID ø 8mm Qty 1 pcs					
	GEV No.	101351	Ref. No.	—	
mounting strap for gas tap					
	GEV No.	520656	Ref. No.	—	
union nut thread 1/4" tube ø 6/8mm					

gas thermostats

SIT

630 Eurosit series

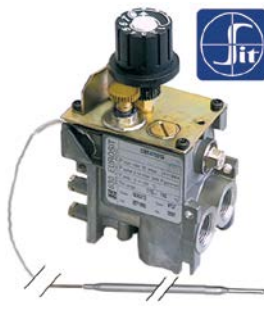

1		GEV No.	101188	Ref. No.	068165 X12900
description					
gas thermostat type 630 Eurosit series t.max. 190°C 110-190°C gas inlet 3/8" gas outlet 3/8" thermocouple connection M9x1 pilot connection M10x1 probe ø 4mm probe L 202mm capillary pipe 1050mm SIT					
For models:					
ACC0001, ACC0002, ACC0006, ACC0007, ADC0001, ADC0002, AEC0007, AEC0008, CP1G, CP1GM, F121GT, F121GTM, F122GT, F47GTM, F47IRGT, F87GTM, F87IRGT, FRY121GTM-1191, FRY47IRGT-1162					
accessories for		101188			
	GEV No.	100904	Ref. No.	—	
locking screw M10x1 for pipe ø 4mm Qty 1 pcs					

Table continues overleaf



accessories for		101188		
GEV No.		100905	Ref. No.	—
	locking screw M10x1 for pipe ø 6mm Qty 1 pcs			
	olive for pipe ø 12mm L 9.5mm brass Qty 1 pcs suitable for universal			
	union screw thread 3/8" tube ø 12mm Qty 1 pcs			
	plug thread 3/8" with O-ring			

accessories for		101132		
GEV No.		101269	Ref. No.	—
	gas connection thread 1/2" angled with O-ring MINISIT 710			
	screw connection IT 3/8" ET 3/8" L 28mm			
	screw connection IT 1/2" ET 3/8" L 57mm			
	olive for pipe ø 12mm L 9.5mm brass Qty 1 pcs suitable for universal			
	olive for pipe ø 16mm Qty 1 pcs			
	union screw thread 1/2" for pipe ø 16mm Qty 1 pcs			
	union screw thread 3/8" tube ø 12mm Qty 1 pcs			
	knob suitable for Minisit ø 37mm			

710 Minisit series

GEV No.	101132	Ref. No.	X17400	
description	gas thermostat SIT type MINISIT 710 t.max. 340°C 100-340°C gas inlet 1/2" gas outlet 3/8" thermocouple connection M9x1 pilot connection M10x1 probe ø 5mm probe L 68mm capillary pipe 1050mm probe type type B1 pressure controller no pressure regulator or bar gland nut ignition gas no			
spare parts for	101132			
	GEV No.	101053	Ref. No.	—
	magnet unit T1: M9x1 T2: M24x1 L 45mm ø 17mm suitable for Minisit			
	GEV No.	102102	Ref. No.	—
	probe 100-340°C probe ø 5mm probe L 68mm capillary pipe 1750mm t.max. 340°C oven/grill probe type type B1 suitable for MINISIT 710			
accessories for	101132			
	GEV No.	100809	Ref. No.	—
	O-ring EPDM thickness 2mm ID ø 21mm Qty 1 pcs			
	GEV No.	100904	Ref. No.	—
	locking screw M10x1 for pipe ø 4mm Qty 1 pcs			
	GEV No.	100905	Ref. No.	—
	locking screw M10x1 for pipe ø 6mm Qty 1 pcs			
	GEV No.	101054	Ref. No.	—
	magnet unit T1: M10x1 T2: M24x1 L 45mm ø 17mm suitable for Minisit			
	GEV No.	101136	Ref. No.	—
	piezoelectric igniter suitable for Minisit with cover cap ø mm connection F6.3x0.8			
	GEV No.	101137	Ref. No.	—
	cover cap without piezoelectric igniter			
	GEV No.	101267	Ref. No.	—
	reducer IT 3/8" ET 1/2" L 21mm			
	GEV No.	101268	Ref. No.	—
	gas connection thread 3/8" angled with O-ring MINISIT 710			

PEL

24ST series

GEV No.	101076	Ref. No.	0000X11200	
description	gas thermostat PEL type 24ST 120-320°C gas inlet M20x1.5 (tube ø 12mm) bypass nozzle ø 0.35mm gas outlet M20x1.5 (tube ø 12/10mm) thermocouple connection M9x1 pilot connection M10x1 capillary pipe 1200mm probe ø 6mm probe L 100mm shaft ø 10x8mm shaft L 27/17mm shaft flat upper			
For models:	ACA2005, ACA2009, ACH3009, ACH3012			
spare parts for	101076			
	GEV No.	100455	Ref. No.	—
	bypass nozzle type PEL23/24 bore ø 0.35mm thread M8x0.5			
	GEV No.	101058	Ref. No.	—
	magnet unit L 39mm D1 ø 15.4mm D2 ø 13.5mm suitable for PEL22/ EGA24197 standard			
	GEV No.	106200	Ref. No.	—
	nut thread M9x1 suitable for PEL 24/255			
accessories for	101076			
	GEV No.	100908	Ref. No.	—
	union screw thread M10x1 for pipe ø 4mm Qty 1 pcs			
	GEV No.	100909	Ref. No.	—
	union screw thread M10x1 for pipe ø 6mm Qty 1 pcs			

Table continues overleaf

accessories for		101076	
	GEV No.	101246	Ref. No. —
olive for pipe ø 4mm Qty 1 pcs			
	GEV No.	101248	Ref. No. —
olive for pipe ø 12mm Qty 1 pcs suitable for PEL			
	GEV No.	101249	Ref. No. —
olive for pipe ø 10mm Qty 1 pcs			
	GEV No.	101250	Ref. No. —
union nut thread M20x1.5 for pipe ø 10mm			
	GEV No.	101251	Ref. No. —
union nut thread M20x1.5 for pipe ø 12mm			
	GEV No.	101286	Ref. No. —
olive ID ø 6mm Qty 1 pcs			
	GEV No.	110079	Ref. No. —
knob dial plate gas thermostat 1-8 silver			
	GEV No.	110080	Ref. No. —
knob ø 70mm shaft ø 10x8mm shaft flat universal			

SABAF

GEV No.		101886	
Ref. No.		068074	
description gas thermostat SABAF t.max. 300°C gas inlet pipe flange ø16mm bypass nozzle ø 0.37mm gas outlet M13x1 IT (tube ø 8mm) gas outlet 2 thermocouple connection M8x1 pilot connection capillary pipe 850mm probe ø 4mm probe L 140mm shaft ø 8x6.5mm shaft L 17/12mm shaft flat upper			
spare parts for 101886			
	GEV No.	101060	Ref. No. —
magnet unit standard L 39mm D1 ø 15.4mm D2 ø 11mm suitable for PEL20-21/JUNKERS/EGA			
	GEV No.	101376	Ref. No. —
gasket ID ø 8mm ED ø 12mm H 3/5mm			
accessories for 101886			
	GEV No.	101277	Ref. No. —
olive ID ø 8mm Qty 1 pcs			
	GEV No.	101477	Ref. No. —
union screw thread M13x1 tube ø 8mm Qty 1 pcs			
	GEV No.	101751	Ref. No. —
bracket			

GEV No.		101181	
Ref. No.		X68053	
description gas thermostat SABAF t.max. 300°C gas inlet pipe flange ø16mm bypass nozzle ø 0.46mm gas outlet M13x1 IT (tube ø 8mm) gas outlet 2 thermocouple connection M8x1 pilot connection capillary pipe 850mm probe ø 4mm probe L 150mm shaft ø 6x4.6mm shaft L 45/27mm shaft flat upper			
For models: ACA2004, ACA2008			
spare parts for 101181			
	GEV No.	101060	Ref. No. —
magnet unit standard L 39mm D1 ø 15.4mm D2 ø 11mm suitable for PEL20-21/JUNKERS/EGA			
accessories for 101181			
	GEV No.	101277	Ref. No. —
olive ID ø 8mm Qty 1 pcs			
	GEV No.	101376	Ref. No. —
gasket ID ø 8mm ED ø 12mm H 3/5mm			
	GEV No.	101477	Ref. No. —
union screw thread M13x1 tube ø 8mm Qty 1 pcs			
	GEV No.	101751	Ref. No. —
bracket			
	GEV No.	110360	Ref. No. —
knob without symbol ø 65mm shaft ø 6x4.6mm shaft flat upper black			
	GEV No.	110603	Ref. No. —
knob dial plate gas thermostat t.max. 300°C 90-300°C			



gas valves and ignition boxes

gas control valves

SIT

TANDEM



1

GEV No.	101189	Ref. No.	068182
description	gas valve 230V 50Hz gas inlet 1/2" gas outlet 1/2" pilot connection M10x1 level slow ignition ignition times pressure range 3-50mbar power supply for modulator equiv. no. 0.830.040 suitable for Tandem		
For models:	CP67GM, F121GM, F122GTM, F47GM, F47IRG, F87GM, F87IRG, FRIT0001, FRY121G, FRY121G-1190, FRY121GM, FRY47IRG		
accessories for	101189		
	GEV No.	100904	Ref. No. —
	locking screw M10x1 for pipe ø 4mm Qty 1 pcs		
	GEV No.	100905	Ref. No. —
	locking screw M10x1 for pipe ø 6mm Qty 1 pcs		
	GEV No.	101274	Ref. No. —
	olive for pipe ø 16mm Qty 1 pcs		
	GEV No.	101275	Ref. No. —
	union screw thread 1/2" for pipe ø 16mm Qty 1 pcs		
	GEV No.	101925	Ref. No. —
	plug with O-ring thread M10x1 for pilot burner suitable for NOVASIT		
	GEV No.	102845	Ref. No. —
	gas connection angled 1/2" flange 32x32mm hole distance 24x24mm Tandem		
	GEV No.	102846	Ref. No. —
	gas connection straight 1/2" flange 32x32mm hole distance 24x24mm suitable for Tandem		
	GEV No.	102847	Ref. No. —
	O-ring		



1

GEV No.	106017	Ref. No.	068147
description	gas valve Tandem		
For models:	FRIT0001, FRY121G-1190		
spare parts for	106017		
	GEV No.	101379	Ref. No. —
	solenoid coil 230V 50Hz suitable for Tandem		
accessories for	106017		
	GEV No.	101274	Ref. No. —
	olive for pipe ø 16mm Qty 1 pcs		
	GEV No.	101275	Ref. No. —
	union screw thread 1/2" for pipe ø 16mm Qty 1 pcs		
	GEV No.	101936	Ref. No. —
	gasket with screw Tandem		
	GEV No.	102845	Ref. No. —
	gas connection angled 1/2" flange 32x32mm hole distance 24x24mm Tandem		
	GEV No.	102846	Ref. No. —
	gas connection straight 1/2" flange 32x32mm hole distance 24x24mm suitable for Tandem		

ignition boxes

miscellaneous



1

GEV No.	102373	Ref. No.	074031 074032
description	ignition box IMIT type AC02EC electrodes 2 waiting time 2s safety time 10s 230V 50Hz		
For models:	CP47GM, CP67GM, F122GTM, F47GM, F47IRG, F87GM, F87IRG, FRIT0001, FRY121G, FRY121G-1190, FRY121GM, FRY47IRG, TOPFTGL, TOPFTGLC		



safety valves







SIT

400 series



1

GEV No.	101470	Ref. No.	Y21800
description	safety valve front fixing M12x1 pressure range 50mbar gas inlet 1/8" IT gas outlet 1/8" - M6x0.75 thermocouple connection M8x1 equiv. no. 0.400.088 suitable for SIT		
For models:	ADK2009, ADK2010, AEK2007, AEK2008		
spare parts for	101470		
	GEV No.	101052	Ref. No. —
	magnet unit L 43.5mm D1 ø 15.3mm D2 ø 10.5mm suitable for SIT M1		
accessories for	101470		
	GEV No.	101299	Ref. No. —
	nut thread M12x1		
	GEV No.	101499	Ref. No. —
	protection cap for safety valve thread M12x0.75 ID ø 18mm L 24mm aluminium		

spare parts for	106906		
	GEV No.	100885	Ref. No. —
	air mixing sleeve for pilot burner Qty 1 pcs		
	GEV No.	100916	Ref. No. —
	compression spring for pilot burner Qty 1 pcs		
	GEV No.	100917	Ref. No. —
	gasket for pilot burner Qty 1 pcs aluminium		
	GEV No.	100918	Ref. No. —
	screw for pilot burner		
	GEV No.	107162	Ref. No. —
	pilot burner cap SIT 3 flames Hmm Lmm Qty 1 pcs		
	GEV No.	107701	Ref. No. X19900
	pilot burner bottom part SIT 100 series nozzle ø 0.2mm		

accessories for	106906		
	GEV No.	100245	Ref. No. X19906
	pilot burner nozzle LPG code 20 bore ø 0.2mm Qty 1 pcs thread M8x0.75		
	GEV No.	100246	Ref. No. X19907
	pilot burner nozzle natural gas bore ø 0.35mm Qty 1 pcs thread M8x0.75		
	GEV No.	100904	Ref. No. —
	locking screw M10x1 for pipe ø 4mm Qty 1 pcs		
	GEV No.	100905	Ref. No. —
	locking screw M10x1 for pipe ø 6mm Qty 1 pcs		
	GEV No.	102110	Ref. No. —
	pilot tube copper pipe ø 4mm thickness 1mm L 3000mm		
	GEV No.	102111	Ref. No. —
	pilot tube copper pipe ø 6mm thickness 1mm L 3000mm		
	GEV No.	107171	Ref. No. —
	pilot burner nozzle SIT natural/liquid gas bore ø 0.25mm Qty 1 pcs		
	GEV No.	107700	Ref. No. —
	pilot burner bottom part SIT 100 series nozzle ø 0.25mm		
	GEV No.	107702	Ref. No. —
	pilot burner bottom part SIT 100 series nozzle ø 0.35mm		

ignition parts



pilot burners

SIT

100 series



1

GEV No.	106906	Ref. No.	068043 X13500
description	pilot burner SIT type 100 series 3 flames nozzle ø 0.2mm gas connection 6mm		
For models:	ABH1001, ABH1002, ACA2012, ACB0001, ACE0001, ACH1001, ACH1002, ACH1003, ACH1004, ADB0001, ADE0001, ADH1001, ADH1002, ADL0006, ADL0007, ADL0013, AEB0003, AEH1001, AEH1002, AEL0004, AEL0005, BM48G, CP1G, CP1GM, CP49G, CP89G, F121GT, F121GTM, F122GT, F47GTM, F47IRGT, F87GTM, F87IRGT, FRY121GTM-1191, FRY47IRGT-1162, FT87GC, FT87GLR, GFTL11070, GFTL4070, GFTL7570, GFTR11070, GFTR4070, GFTR7570, GLP11070, GLP4070, GLP7570, GMV11070, GMV4070, GMV7570, PC127GP... (Other models you can see in the webshop)		
spare parts for	106906		
	GEV No.	100245	Ref. No. X19906
	pilot burner nozzle LPG code 20 bore ø 0.2mm Qty 1 pcs thread M8x0.75		
	GEV No.	100855	Ref. No. —
	pilot burner bracket triple		



accessories

pilot burner bottom parts



GEV No.	107701	Ref. No.	X19900
description	pilot burner bottom part SIT 100 series nozzle ϕ 0.2mm		
For models:	ACA2001, ACA2002, ACA2003, ACA2012, ACJ0001, ACJ0003		

spare parts for 107701

	GEV No.	100245	Ref. No.	X19906
	description	pilot burner nozzle LPG code 20 bore ϕ 0.2mm Qty 1 pcs thread M8x0.75		
	GEV No.	100916	Ref. No.	—
	description	compression spring for pilot burner Qty 1 pcs		
	GEV No.	100917	Ref. No.	—
	description	gasket for pilot burner Qty 1 pcs aluminium		
	GEV No.	100918	Ref. No.	—
	description	screw for pilot burner		

accessories for 107701

	GEV No.	100246	Ref. No.	X19907
	description	pilot burner nozzle natural gas bore ϕ 0.35mm Qty 1 pcs thread M8x0.75		
	GEV No.	100904	Ref. No.	—
	description	locking screw M10x1 for pipe ϕ 4mm Qty 1 pcs		
	GEV No.	100905	Ref. No.	—
	description	locking screw M10x1 for pipe ϕ 6mm Qty 1 pcs		
	GEV No.	102110	Ref. No.	—
	description	pilot tube copper pipe ϕ 4mm thickness 1mm L 3000mm		
	GEV No.	102111	Ref. No.	—
	description	pilot tube copper pipe ϕ 6mm thickness 1mm L 3000mm		
	GEV No.	102742	Ref. No.	—
	description	pilot burner nozzle LPG code 25 bore ϕ 0.25mm Qty 1 pcs		

pilot burner nozzles



GEV No.	100245	Ref. No.	X19906
description	pilot burner nozzle LPG code 20 bore ϕ 0.2mm Qty 1 pcs thread M8x0.75		
For models:	ADA2009, ADC0001, ADC0002, ADE0001, ADH1001, ADH1002, AEC0007, AEC0008, AEH1001, AEH1002, CP49G, CP89G		

	GEV No.	100246	Ref. No.	X19907
description	pilot burner nozzle natural gas bore ϕ 0.35mm Qty 1 pcs thread M8x0.75			
For models:	ADA2009, ADC0001, ADC0002, ADE0001, AEC0007, AEC0008, CP49G, CP89G			

ignition electrodes

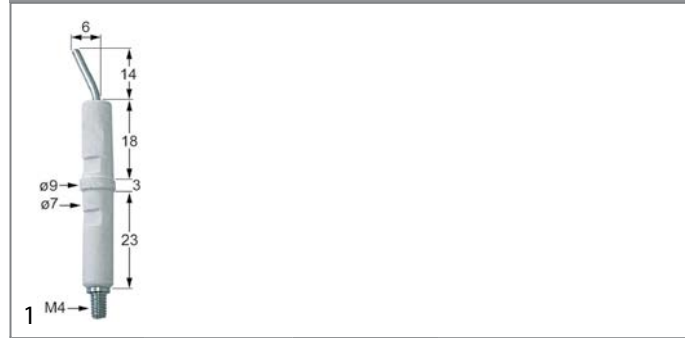

GEV No.	100706	Ref. No.	X14600
description	ignition electrode connection M4 Qty 1 pcs		
For models:	ABH1001, ABH1002, ACA2005, ACA2009, ACA2012, ACB0001, ACE0001, ACH1001, ACH1002, ACH1003, ACH1004, ADA2006, ADA2007, ADB0001, ADC0003, ADC0008, ADC0009, ADC0010, ADE0001, ADH1001, ADH1002, ADL0006, ADL0007, ADL0013, AEB0003, AEC0009, AEC0010, AEC0011, AEC0012, AEH1001, AEH1002, AEL0004, AEL0005, BM48G, CP49G, CP89G, F49G, F89G, SKPL1G, SKPL2G		

140 - 145 - 150 series



















GEV No.	100170	Ref. No.	X13000
description	pilot burner SIT type 150 series 1 flame nozzle ϕ mm gas connectionmm		
For models:	ABH3010, ABH3011, ABH3012, ABH3014, ABH3015, ABH3016, ABH3017, ABH3018, ACH3008, ACH3009, ACH3010, ACH3011, ACH3012, ACH3013, ACH3014, ACH3015, ACH3016, ACH3017, ADH3007, ADH3008, ADH3010, ADH3011, ADK2007, ADK2008, ADK2009, ADK2010, AEA2005, AEH3007, AEH3008, AEH3009, AEH3010, AEH3011, AEH3012, AEK2005, AEK2006, AEK2007, AEK2008, GFT49L, GFT49LC, GFT49R, GFT89L, GFT89LC, GFT89LR, KFT8GLR		





spare parts for	100170			
	GEV No.	100907	Ref. No.	—
	description	screw connection thread M10x1 Qty 1 pcs type SEF 1 ϕ mm for thermocouple		

accessories for	100170			
	GEV No.	100204	Ref. No.	—
	description	pilot burner nozzle SIT LPG code 14 bore ϕ 0.18/0.20mm Qty 1 pcs suitable for 140 series		
	GEV No.	100205	Ref. No.	X30000
	description	pilot burner nozzle SIT LPG code 19 bore ϕ 0.23/0.26mm Qty 1 pcs suitable for SIT 150 series		
	GEV No.	100206	Ref. No.	—
	description	pilot burner nozzle SIT natural gas code 36 bore ϕ 0.60/0.55mm Qty 1 pcs suitable for SIT 150 series		
	GEV No.	100207	Ref. No.	—
	description	pilot burner nozzle SIT natural gas code 27 bore ϕ 0.40/0.38mm suitable for SIT 140 series		

Table continues overleaf

accessories for		100170		
	GEV No.	100216	Ref. No.	—
	pilot burner nozzle SIT natural gas code 38 bore ø 0.45mm Qty 1 pcs suitable for SIT 150 series			
	GEV No.	100701	Ref. No.	X13001
	ignition electrode connection M4 Qty 1 pcs			
	GEV No.	100801	Ref. No.	—
	gasket for pilot burner Qty 1 pcs			
	GEV No.	100897	Ref. No.	—
	olive for pipe ø 4mm Qty 1 pcs for pilot burner			
	GEV No.	100898	Ref. No.	—
	olive for pipe ø 6mm Qty 1 pcs for pilot burner			
	GEV No.	100906	Ref. No.	—
	screw connection thread M10x1 for ignition electrode brass Qty 1 pcs WS 10			
	GEV No.	100908	Ref. No.	—
	union screw thread M10x1 for pipe ø 4mm Qty 1 pcs			
	GEV No.	100909	Ref. No.	—
	union screw thread M10x1 for pipe ø 6mm Qty 1 pcs			

160 series				
	1			
GEV No.	100056	Ref. No.	X17000	
description	pilot burner SIT type 160 series 3 flames nozzle ømm gas connectionmm			
For models:	ACK2001, BRG70			
spare parts for	100056			
	GEV No.	100907	Ref. No.	—
	screw connection thread M10x1 Qty 1 pcs type SEF 1 ømm for thermocouple			
accessories for	100056			
	GEV No.	100202	Ref. No.	—
	pilot burner nozzle natural gas code 41 Qty 1 pcs nozzle ø 0.41mm			
	GEV No.	100203	Ref. No.	—
	pilot burner nozzle LPG code 25 Qty 1 pcs nozzle ø 0.25mm			
	GEV No.	100701	Ref. No.	X13001
	ignition electrode connection M4 Qty 1 pcs			
	GEV No.	100801	Ref. No.	—
	gasket for pilot burner Qty 1 pcs			
	GEV No.	100869	Ref. No.	—
	pilot burner nozzle natural gas code 51 Qty 1 pcs suitable for 160 series nozzle ø 0.51mm			
	GEV No.	100870	Ref. No.	—
	olive for pipe ø 4mm Qty 1 pcs suitable for 160 series for pilot burner			

accessories for		100056		
	GEV No.	100906	Ref. No.	—
	screw connection thread M10x1 for ignition electrode brass Qty 1 pcs WS 10			
	GEV No.	100908	Ref. No.	—
	union screw thread M10x1 for pipe ø 4mm Qty 1 pcs			
	GEV No.	100909	Ref. No.	—
	union screw thread M10x1 for pipe ø 6mm Qty 1 pcs			
	GEV No.	101287	Ref. No.	—
	olive for pipe ø 6mm Qty 1 pcs			
	GEV No.	102110	Ref. No.	—
	pilot tube copper pipe ø 4mm thickness 1mm L 3000mm			
	GEV No.	102111	Ref. No.	—
	pilot tube copper pipe ø 6mm thickness 1mm L 3000mm			
	GEV No.	107650	Ref. No.	—
	pilot burner nozzle SIT LPG code 30 Qty 1 pcs			

producer-specific pilot burners

STAR 10











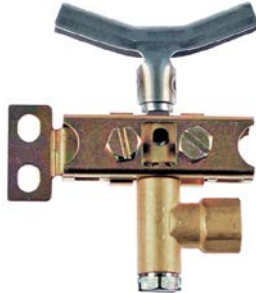





	1			
GEV No.	100145	Ref. No.	0000X19000	
description	pilot burner SIT type 100 series 3 flames nozzle ø 0.2mm gas connectionmm			
For models:	ACC0001, ACC0002, ACC0006, ACC0007, ADC0001, ADC0002, AEC0007, AEC0008			
spare parts for	100145			
	GEV No.	100245	Ref. No.	X19906
	pilot burner nozzle LPG code 20 bore ø 0.2mm Qty 1 pcs thread M8x0.75			
	GEV No.	100837	Ref. No.	—
	pilot burner cap 3 flames H 24mm L 48mm Qty 1 pcs			
	GEV No.	100855	Ref. No.	—
	pilot burner bracket triple			
	GEV No.	100881	Ref. No.	—
	pilot burner bottom part PRO-GAS 100 series nozzle ø 0.2mm			
	GEV No.	100885	Ref. No.	—
	air mixing sleeve for pilot burner Qty 1 pcs			
	GEV No.	100916	Ref. No.	—
	compression spring for pilot burner Qty 1 pcs			

Table continues overleaf



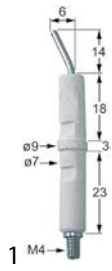
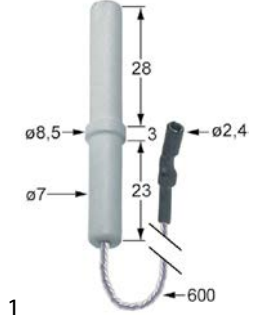

spare parts for 100145	
	GEV No. 100917 Ref. No. — gasket for pilot burner Qty 1 pcs aluminium
	GEV No. 100918 Ref. No. — screw for pilot burner
accessories for 100145	
	GEV No. 100246 Ref. No. X19907 pilot burner nozzle natural gas bore \varnothing 0.35mm Qty 1 pcs thread M8x0.75
	GEV No. 100882 Ref. No. — pilot burner bottom part PRO-GAS 100 series nozzle \varnothing 0.25mm
	GEV No. 100883 Ref. No. — pilot burner bottom part PRO-GAS 100 series nozzle \varnothing 0.35mm
	GEV No. 100904 Ref. No. — locking screw M10x1 for pipe \varnothing 4mm Qty 1 pcs
	GEV No. 100905 Ref. No. — locking screw M10x1 for pipe \varnothing 6mm Qty 1 pcs
	GEV No. 102110 Ref. No. — pilot tube copper pipe \varnothing 4mm thickness 1mm L 3000mm
	GEV No. 102111 Ref. No. — pilot tube copper pipe \varnothing 6mm thickness 1mm L 3000mm
	GEV No. 102742 Ref. No. — pilot burner nozzle LPG code 25 bore \varnothing 0.25mm Qty 1 pcs

	
GEV No.	100706 Ref. No. X14600
description	ignition electrode connection M4 Qty 1 pcs
For models:	ABH1001, ABH1002, ACA2005, ACA2009, ACA2012, ACB0001, ACE0001, ACH1001, ACH1002, ACH1003, ACH1004, ADA2006, ADA2007, ADB0001, ADC0003, ADC0008, ADC0009, ADC0010, ADE0001, ADH1001, ADH1002, ADL0006, ADL0007, ADL0013, AEB0003, AEC0009, AEC0010, AEC0011, AEC0012, AEH1001, AEH1002, AEL0004, AEL0005, BM48G, CP49G, CP89G, F49G, F89G, SKPL1G, SKPL2G

	
GEV No.	100733 Ref. No. X14500
description	ignition electrode D1 \varnothing 7mm D2 \varnothing 8.5mm cable length 600mm BL1 28mm BL2 3mm BL3 23mm to clip connection \varnothing 2.4mm
For models:	ACA2004, ACA2006, ACA2008, ACA2010, ACA2011

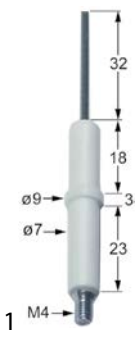
electrodes

	
GEV No.	100701 Ref. No. X13001
description	ignition electrode connection M4 Qty 1 pcs
For models:	ABH3010, ABH3011, ABH3012, ABH3014, ABH3015, ABH3016, ABH3017, ABH3018, ACH3008, ACH3009, ACH3010, ACH3011, ACH3012, ACH3013, ACH3014, ACH3015, ACH3016, ACH3017, ADA2017, ADH3007, ADH3008, ADH3010, ADH3011, ADK2007, ADK2008, ADK2009, ADK2010, AEA2005, AEH3007, AEH3008, AEH3009, AEH3010, AEH3011, AEH3012, AEK2005, AEK2006, AEK2007, AEK2008, GFT49L, GFT49LC, GFT49R, GFT89L, GFT89LC, GFT89LR, KFT8GLR
accessories for 100701	
	GEV No. 100906 Ref. No. — screw connection thread M10x1 for ignition electrode brass Qty 1 pcs WS 10

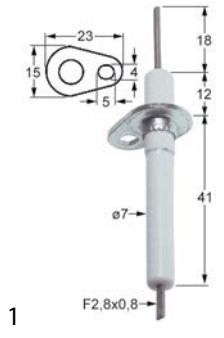
	
GEV No.	100818 Ref. No. X68041
description	ignition electrode flange length 23mm flange width 15mm D1 \varnothing 7mm L1 18mm BL1 12mm BL2 41mm connection F 2.8x0.8mm fixing dimensions \varnothing 5x4mm with flange
For models:	ACA2004, ACA2008

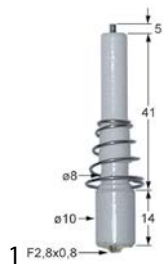

GEV No.	100729	Ref. No.	068032 X15000
description	ignition electrode L1 5mm D1 ø 8mm D2 ø 10mm BL1 41mm BL2 14mm connection F 2.8x0.8mm to clip with spring		
For models:	ABJ0001, ABJ0002, BSC4FG, BSC6FG, C127FE, C127FG, C2G, C3FG, C3G, C5FG, C5GFE, C87FE, C87FG, CREP1G, CREP1G400, CREP2G, GRMGZL, GR-MGZ-L-2129, GRMGZR, GR-MGZ-R-2128, HP4652G, HP8654G, PC127G, PC1G, PC2G, PC2G-4370, PC47G, PC4G, PC87G, TOP2G, TOPG		

ignition cables

pre-assembled cables



GEV No.	100176	Ref. No.	E10000
description	ignition cable cable length 1000mm connection ø2.4mm / ø4mm permanent temperature 200°C		
For models:	ADL0006, ADL0007, ADL0013, AEL0004, AEL0005		



GEV No.	100036	Ref. No.	068033
description	ignition cable cable length 500mm connection F2.8mm / F2.8mm		
For models:	BSC4FG, BSC6FG, C127FE, C127FG, C2G, C3G, C87FE, C87FG, CP1G, CP1GM, CREP1G, CREP1G400, CREP2G, F121GT, F121GTM, F122GT, F47IRGT, F87IRGT, FRY121GTM-1191, FRY47IRGT-1162, FT1G, FT1GR40, FT87GC, GFTL11070, GFTL4070, GFTL7570, GFTR11070, GFTR4070, GFTR7570, GLP11070, GLP4070, GLP7570, GMV11070, GMV4070, GMV7570, GRMGZL, GR-MGZ-L-2129, GRMGZR, GR-MGZ-R-2128, HP4652G, HP8654G, PC127G, PC1G, PC2G, PC2G-4370, PC47G, PC4G, PC87G, TOP2G, TOPFT60GL...(Other models you can see in the webshop)		



GEV No.	100177	Ref. No.	X40500
description	ignition cable cable length 600mm		
For models:	ABJ0001, ABJ0002, ACE0001, ADK2007, ADK2008, ADK2009, ADK2010, AEK2005, AEK2006, AEK2007, AEK2008		



GEV No.	100015	Ref. No.	X40100
description	ignition cable cable length 600mm connection ø2.4mm / ø2.4mm		
For models:	ABH3010, ABH3011, ABH3012, ABH3014, ABH3015, ABH3016, ABH3017, ABH3018, ACB0001, ACC0001, ACC0002, ACC0006, ACC0007, ACH3008, ACH3009, ACH3010, ACH3011, ACH3012, ACH3013, ACH3014, ACH3015, ACH3016, ACH3017, ACK2001, ADB0001, ADH1001, ADH1002, AEB0003, AEH1001, AEH1002, AEH3007, AEH3008, AEH3009, AEH3010, AEH3011, AEH3012, BM48G, BRG70, KFT8GLR		

piezoelectric igniters

mounting diameter 18mm



GEV No.	100003	Ref. No.	M00500
description	piezoelectric igniter body metal blowing mounting ø 18mm connection F2.8x0.8		
For models:	ABH1001, ABH1002, ABH3010, ABH3011, ABH3012, ABH3014, ABH3015, ABH3016, ABH3017, ABH3018, ABJ0001, ABJ0002, ACA2004, ACA2005, ACA2006, ACA2008, ACA2009, ACA2010, ACA2011, ACA2012, ACB0001, ACC0001, ACC0002, ACC0006, ACC0007, ACE0001, ACH1001, ACH1002, ACH1003, ACH1004, ACH3008, ACH3009, ACH3010, ACH3011, ACH3012, ACH3013, ACH3014, ACH3015, ACH3016, ACH3017, ADH3007, ADH3008, ADH3010, ADH3011, AEH3007, AEH3008, AEH3009, AEH3010, AEH3011, AEH3012...(Other models you can see in the webshop)		

ignition units



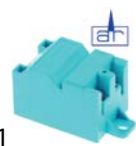

GEV No.	101009	Ref. No.	068160
description	ignition unit outputs 2 1.5 V/DC dimensions 88x23x34mm mounting distance 73mm inlet F6.3x0.8 outlet F2.8x0.8 mounting ø 73mm		
For models:	C127FG, C2G, C87FP, CP1G, CP1GM, CREP1G, CREP1G400, CREP2G, F121GT, F121GTM, F122GT, F47GTM, F47IRGT, F87GTM, F87IRGT, FRY121GTM-1191, FRY47IRGT-1162, FT1G, FT1GC, FT1GC-4321, FT1GC-4364, FT1GL, FT1GR, FT1GR40, FT2GC, FT2GL, FT2GLC, FT2GLR, FT47GC, FT47GL, FT47GR, FT67GC, FT67GL, FT67GLR, FT87GC, FT87GLR, GFTL11070, GFTL4070, GFTL7570, GFTR11070, GFTR4070, GFTR7570, GLP11070, GLP4070, GLP7570, GMV4070, GMV7570, GRMGZL, GR-MGZ-L-2129, GRMGZR...(Other models you can see in the webshop)		
accessories for	101009		
	GEV No.	301195	Ref. No. 068163
		ignition switch for battery type AA 1.5V mounting ø 22mm built-in depth 42mm connection male faston 2.8mm/6.3mm red ignitionA protection IP40 ambient temperature max. 125/55°C	



GEV No.	101012	Ref. No.	068034
description	ignition unit outputs 2 230VAC dimensions 48x32x32mm mounting distance 56mm inlet F2.8x0.8 outlet F2.8x0.8 type ZIG2 50-60Hz		
For models:	BSC6FG, FT1GC-4521		



			
1			
GEV No.	101002	Ref. No.	068034 X50000
description	ignition unit outputs 2 230VAC dimensions 88x23x34mm mounting distance 73mm inlet F6.3x0.8 outlet F2.8x0.8 0.6VA 50/60Hz		
For models:	ADK2007, ADK2008, ADK2009, ADK2010, AEK2005, AEK2006, AEK2007, AEK2008		

			
2			
GEV No.	101031	Ref. No.	068161
description	ignition unit outputs 4 1.5 V/DC dimensions 111x23x34mm mounting distance 100mm inlet F6.3x0.8 outlet F2.8x0.8 mounting ø 100mm		
For models:	BSC4FE80, BSC4FG, C3G, C87FE, F87IRGT, GMV11070, HP8654G, PC127FTE, PC127FTG, PC2G, PC4G, PC87G, TOP2G		

			
1			
GEV No.	101019	Ref. No.	068162
description	ignition unit outputs 6 1.5 V/DC		
For models:	C127FE, C127FG, C5FG, C5GFE, C87FG, PC127G		

ignition switches

			
1			
GEV No.	301195	Ref. No.	068163
description	ignition switch for battery type AA 1.5V mounting ø 22mm built-in depth 42mm connection male faston 2.8mm/6.3mm red ignitionA protection IP40 ambient temperature max. 125/55°C		
For models:	BSC4FE80, BSC4FG, BSC6FG, C127FE, C127FG, C2G, C3G, C5FG, C5GFE, C87FE, C87FG, CP1G, CP1GM, CREP1G, CREP1G400, CREP2G, F121GT, F121GTM, F122GT, F47GTM, F47IRGT, F87GTM, F87IRGT, FRY121GTM-1191, FRY47IRGT-1162, FT1G, FT1GC, FT1GC-4321, FT1GC-4364, FT1GL, FT1GR, FT1GR40, FT2GC, FT2GL, FT2GLC, FT2GLR, FT47GC, FT47GL, FT47GR, FT67GC, FT67GL, FT67GLR, FT87GC, FT87GLR, GFTL11070, GFTL4070, GFTL7570, GFTR11070, GFTR4070, GFTR7570...(Other models you can see in the webshop)		
accessories for	301195		
	GEV No.	101009	Ref. No. 068160
	ignition unit outputs 2 1.5 V/DC dimensions 88x23x34mm mounting distance 73mm inlet F6.3x0.8 outlet F2.8x0.8 mounting ø 73mm		
	GEV No.	101031	Ref. No. 068161
	ignition unit outputs 4 1.5 V/DC dimensions 111x23x34mm mounting distance 100mm inlet F6.3x0.8 outlet F2.8x0.8 mounting ø 100mm		
	GEV No.	101032	Ref. No. —
	ignition unit outputs 6 1.5 V/DC dimensions 135x23x34mm mounting distance 123mm inlet F6.3x0.8 outlet F2.8x0.8 mounting ø 122mm		

thermocouples

plug-in thermocouples

plug-in thermocouples standard

with barrel socket ø6(6.5)mm

thermocouples SIT

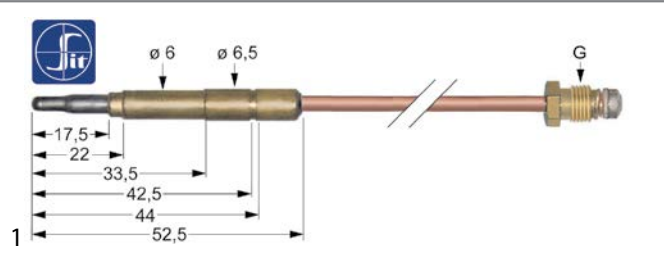

GEV No.	107601	Ref. No.	068159
description	thermocouple SIT M8x1 L 600mm plug connection ø6.0(6.5)mm		
For models:	F47GTM, F47IRGT, F87GTM, F87IRGT, FRY47IRGT-1162, GFTL11070, GFTL4070, GFTL7570, GFTR11070, GFTR4070, GFTR7570, GLP11070, GLP4070, GLP7570, GMV11070, GMV4070, GMV7570, GY100G, GY40G, GY60G, GY80G, GYROS-100G-9828, GYROS-40G-9825, GYROS-60G-9826, GYROS-80G-9827, PC49G, TOPFT60GL, TOPFT60GLC		

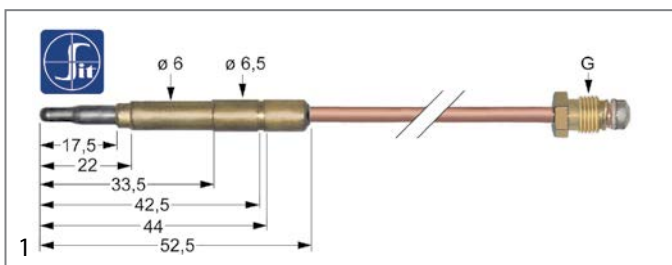

GEV No.	107614	Ref. No.	X14900
description	thermocouple SIT M9x1 L 1500mm plug connection ø6.0(6.5)mm		
For models:	ACA2005, ACA2009, ACA2012		

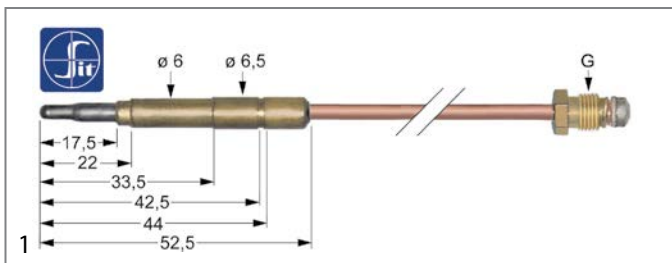

GEV No.	107608	Ref. No.	X13900
description	thermocouple SIT M9x1 L 500mm plug connection ø6.0(6.5)mm		
For models:	ABH1001, ABH1002, ACA2001, ACA2002, ACA2003, ACA2004, ACA2005, ACA2006, ACA2008, ACA2009, ACA2010, ACA2011, ACA2012, ACB0001, ACJ0001, ACJ0003, ACK2001, ADA2006, ADA2007, ADA2009, BRG70, SKPL1G, SKPL2G		

GEV No.	107609	Ref. No.	068167 X14100 X14200
description	thermocouple SIT M9x1 L 600mm plug connection $\phi 6.0(6.5)$ mm		
For models:	ABH3010, ABH3011, ABH3012, ABH3014, ABH3015, ABH3016, ABH3017, ABH3018, ACA2001, ACA2002, ACA2003, ACA2004, ACA2005, ACA2006, ACA2007, ACA2008, ACA2009, ACA2010, ACA2011, ACA2012, ACE0001, ACH1001, ACH1002, ACH1003, ACH1004, ACH3008, ACH3009, ACH3010, ACH3011, ACH3012, ACH3013, ACH3014, ACH3015, ACH3016, ACH3017, ACJ0001, ACJ0003, ADA2001, ADA2002, ADA2003, ADA2004, ADA2005, ADA2006, ADA2007, ADA2008, ADA2009, ADA2010, ADA2017, ADB0001, ADE0001...(Other models you can see in the webshop)		

GEV No.	107177	Ref. No.	X19100
description	thermocouple SIT with interrupter M9x1 L 600mm plug connection $\phi 6.0$ mm F 6.3mm		

threaded thermocouples

threaded thermocouples standard

with socket with thread M8x1

SIT

plug-in thermocouples with interruption

GEV No.	100172	Ref. No.	X14300
description	thermocouple SIT with interrupter ASA 11/32 L 400mm plug connection $\phi 6.0$ mm F 6.3mm		
For models:	ADH3007, ADH3008, ADH3010, ADH3011, ADK2007, ADK2008, ADK2009, ADK2010, AEH3007, AEH3008, AEH3009, AEH3010, AEH3011, AEH3012, AEK2005, AEK2006, AEK2007, AEK2008, GFT49L, GFT49LC, GFT49R, GFT89L, GFT89LC, GFT89LR, KFT8GLR		

GEV No.	107633	Ref. No.	068135
description	thermocouple SIT M8x1 L 1200mm M8x1		
accessories for	107633		
	GEV No.	102067	Ref. No. —
	nut thread M8x1 H 3mm brass Qty 1 pcs type SEF 1		

GEV No.	107164	Ref. No.	X14000
description	thermocouple SIT with interrupter M9x1 L 1000mm plug connection $\phi 6.0(6.5)$ mm soldering connection		
For models:	ADL0013, AEL0004		

GEV No.	107634	Ref. No.	068138 X68045
description	thermocouple SIT M8x1 L 1500mm M8x1		
For models:	ACA2004, ACA2008, C127FG, C2FG, C3G, C5FG, C87FG, SA650G, SAM650G, SAM650G-2623		
accessories for	107634		
	GEV No.	102067	Ref. No. —
	nut thread M8x1 H 3mm brass Qty 1 pcs type SEF 1		



GEV No.	107636	Ref. No.	X15700
description	thermocouple SIT M9x1 L 600mm M8x1		
For models:	ABJ0001, ABJ0002		
accessories for	107636		
GEV No.	102067	Ref. No.	—
description	nut thread M8x1 H 3mm brass Qty 1 pcs type SEF 1		

accessories for	103066		
GEV No.	104101	Ref. No.	068097 M00600
description	burner holder for burner cap ø 80mm with nozzle holder with mixing sleeve		

GEV No.	104102	Ref. No.	068064 M00900
description	burner head for burner cap ø 100mm ext. ø 130		
For models:	ABJ0001, ABJ0002, BSC6FG, PC2G, PC2G-4370, TOP2G		

gas burners

hob burners

universal hob burners

GEV

GEV No.	106379	Ref. No.	N/A
description	air mixing tube for burner cap ø 80mm L 23mm D1 ø 20mm D2 ø 15.6mm D3 ø 14mm		

GEV No.	103068	Ref. No.	068067 M00400
description	burner cap ø 100mm		
For models:	ABJ0001, ABJ0002, BSC6FG, PC2G, PC2G-4370, TOP2G		
accessories for	103068		
GEV No.	103067	Ref. No.	068070 M01100
description	burner ring for burner cap ø 100mm		
GEV No.	104102	Ref. No.	068064 M00900
description	burner head for burner cap ø 100mm ext. ø 130		
GEV No.	104103	Ref. No.	068063 M00700
description	burner holder suitable for burner ø100mm with nozzle holder		

GEV No.	103066	Ref. No.	068098 M00300
description	burner cap ø 80mm		
For models:	ABJ0001, ABJ0002, BSC6FG, PC2G, TOP2G		
accessories for	103066		
GEV No.	103065	Ref. No.	068099 M01000
description	burner ring for burner cap ø 80mm		
GEV No.	104100	Ref. No.	068085 M00800
description	burner head for burner cap ø 80mm		

GEV No.	104100	Ref. No.	068085 M00800
description	burner head for burner cap ø 80mm		
For models:	ABJ0001, ABJ0002, BSC6FG, PC2G, TOP2G		

accessories for	104100		
GEV No.	103065	Ref. No.	068099 M01000
description	burner ring for burner cap ø 80mm		

GEV No.	103066	Ref. No.	068098 M00300
description	burner cap ø 80mm		





GEV No.	104103	Ref. No.	068063 M00700
description	burner holder suitable for burner ø100mm with nozzle holder		

GEV No.	104101	Ref. No.	068097 M00600
description	burner holder for burner cap ø 80mm with nozzle holder with mixing sleeve		
For models:	ABJ0001, ABJ0002, BSC6FG, PC2G, TOP2G		

accessories for	104101		
GEV No.	103065	Ref. No.	068099 M01000
description	burner ring for burner cap ø 80mm		

GEV No.	103066	Ref. No.	068098 M00300
description	burner cap ø 80mm		





GEV No.	104100	Ref. No.	068085 M00800
description	burner head for burner cap ø 80mm		

			
1			
GEV No.	104103	Ref. No.	068063 M00700
description	burner holder suitable for burner ø100mm with nozzle holder		
For models:	ABJ0001, ABJ0002, BSC6FG, KT3VD, PC2G, PC2G-4370, TOP2G		
accessories for	104103		
	GEV No.	103067	Ref. No. 068070 M01100
burner ring for burner cap ø 100mm			
	GEV No.	103068	Ref. No. 068067 M00400
burner cap ø 100mm			
	GEV No.	104102	Ref. No. 068064 M00900
burner head for burner cap ø 100mm ext. ø 130			

			
1			
GEV No.	103067	Ref. No.	068070 M01100
description	burner ring for burner cap ø 100mm		
For models:	ABJ0001, ABJ0002, BSC6FG, PC2G, PC2G-4370, TOP2G		
accessories for	103067		
	GEV No.	103068	Ref. No. 068067 M00400
burner cap ø 100mm			
	GEV No.	104102	Ref. No. 068064 M00900
burner head for burner cap ø 100mm ext. ø 130			
	GEV No.	104103	Ref. No. 068063 M00700
burner holder suitable for burner ø100mm with nozzle holder			

			
1			
GEV No.	103065	Ref. No.	068099 M01000
description	burner ring for burner cap ø 80mm		
For models:	ABJ0001, ABJ0002, BSC6FG, PC2G, TOP2G		
accessories for	103065		
	GEV No.	103066	Ref. No. 068098 M00300
burner cap ø 80mm			
	GEV No.	104100	Ref. No. 068085 M00800
burner head for burner cap ø 80mm			
	GEV No.	104101	Ref. No. 068097 M00600
burner holder for burner cap ø 80mm with nozzle holder with mixing sleeve			

producer-specific hob burners			
STAR 10			
600 series			
			
1			
GEV No.	106379	Ref. No.	N/A
description	air mixing tube for burner cap ø 80mm L 23mm D1 ø 20mm D2 ø 15.6mm D3 ø 14mm		





			
1			
GEV No.	103068	Ref. No.	068067 M00400
description	burner cap ø 100mm		
For models:	ABJ0001, ABJ0002, BSC6FG, PC2G, PC2G-4370, TOP2G		
accessories for	103068		
	GEV No.	103067	Ref. No. 068070 M01100
burner ring for burner cap ø 100mm			
	GEV No.	104102	Ref. No. 068064 M00900
burner head for burner cap ø 100mm ext. ø 130			
	GEV No.	104103	Ref. No. 068063 M00700
burner holder suitable for burner ø100mm with nozzle holder			





			
1			
GEV No.	103066	Ref. No.	068098 M00300
description	burner cap ø 80mm		
For models:	ABJ0001, ABJ0002, BSC6FG, PC2G, TOP2G		
accessories for	103066		
	GEV No.	103065	Ref. No. 068099 M01000
burner ring for burner cap ø 80mm			
	GEV No.	104100	Ref. No. 068085 M00800
burner head for burner cap ø 80mm			
	GEV No.	104101	Ref. No. 068097 M00600
burner holder for burner cap ø 80mm with nozzle holder with mixing sleeve			

			
1			
GEV No.	104102	Ref. No.	068064 M00900
description	burner head for burner cap ø 100mm ext. ø 130		
For models:	ABJ0001, ABJ0002, BSC6FG, PC2G, PC2G-4370, TOP2G		



 <p>1</p>			
GEV No.	104100	Ref. No.	068085 M00800
description	burner head for burner cap ø 80mm		
For models:	ABJ0001, ABJ0002, BSC6FG, PC2G, TOP2G		
accessories for	104100		
	GEV No.	103065	Ref. No. 068099 M01000
burner ring for burner cap ø 80mm			
	GEV No.	103066	Ref. No. 068098 M00300
burner cap ø 80mm			
	GEV No.	104103	Ref. No. 068063 M00700
burner holder suitable for burner ø100mm with nozzle holder			

 <p>1</p>			
GEV No.	104101	Ref. No.	068097 M00600
description	burner holder for burner cap ø 80mm with nozzle holder with mixing sleeve		
For models:	ABJ0001, ABJ0002, BSC6FG, PC2G, TOP2G		
accessories for	104101		
	GEV No.	103065	Ref. No. 068099 M01000
burner ring for burner cap ø 80mm			
	GEV No.	103066	Ref. No. 068098 M00300
burner cap ø 80mm			
	GEV No.	104100	Ref. No. 068085 M00800
burner head for burner cap ø 80mm			

 <p>1</p>			
GEV No.	104103	Ref. No.	068063 M00700
description	burner holder suitable for burner ø100mm with nozzle holder		
For models:	ABJ0001, ABJ0002, BSC6FG, KT3VD, PC2G, PC2G-4370, TOP2G		
accessories for	104103		
	GEV No.	103067	Ref. No. 068070 M01100
burner ring for burner cap ø 100mm			
	GEV No.	103068	Ref. No. 068067 M00400
burner cap ø 100mm			
	GEV No.	104102	Ref. No. 068064 M00900
burner head for burner cap ø 100mm ext. ø 130			

 <p>1</p>			
GEV No.	103067	Ref. No.	068070 M01100
description	burner ring for burner cap ø 100mm		
For models:	ABJ0001, ABJ0002, BSC6FG, PC2G, PC2G-4370, TOP2G		
accessories for	103067		
	GEV No.	103068	Ref. No. 068067 M00400
burner cap ø 100mm			
	GEV No.	104102	Ref. No. 068064 M00900
burner head for burner cap ø 100mm ext. ø 130			
	GEV No.	104103	Ref. No. 068063 M00700
burner holder suitable for burner ø100mm with nozzle holder			

 <p>1</p>			
GEV No.	103065	Ref. No.	068099 M01000
description	burner ring for burner cap ø 80mm		
For models:	ABJ0001, ABJ0002, BSC6FG, PC2G, TOP2G		
accessories for	103065		
	GEV No.	103066	Ref. No. 068098 M00300
burner cap ø 80mm			
	GEV No.	104100	Ref. No. 068085 M00800
burner head for burner cap ø 80mm			
	GEV No.	104101	Ref. No. 068097 M00600
burner holder for burner cap ø 80mm with nozzle holder with mixing sleeve			

650 series





 <p>1</p>			
GEV No.	105018	Ref. No.	069201/A
description	burner cap ø 100mm seat ø 75mm		
For models:	BSC4FE80, BSC4FG, C127FE, C2FG, C3FG, C3G, C87FE, CREP1G, CREP1G400, CREP2G, FTG47, HP1G, HP2G, HP4652G, HP8654G, PC127FTE, PC127FTG, PC127G, PC47G, PC4G, PC87G		
accessories for	105018		
	GEV No.	105019	Ref. No. 069206
burner ring for burner cap ø 100mm			
	GEV No.	105031	Ref. No. 020824
gasket ø 80mm for burner cap ø 100mm ID ø 56mm thickness 2mm fibre			
	GEV No.	105033	Ref. No. 062150/A
nozzle holder			
	GEV No.	105034	Ref. No. 006911 alt
burner lower part for burner cap ø 100mm with venturi			



 1			
GEV No.	105029	Ref. No.	069200/17 069200/A
description	burner cap ø 80mm		
accessories for	105029		
	GEV No.	105030	Ref. No. 069205
	burner ring for burner cap ø 80mm		
	GEV No.	105032	Ref. No. 006912
	burner lower part for burner cap ø 80mm with venturi		
	GEV No.	105033	Ref. No. 062150/A
	nozzle holder		
	GEV No.	105038	Ref. No. 020822
	gasket for burner cap ø 80mm		

 1			
GEV No.	105940	Ref. No.	069113
description	burner head for burner cap ø 80mm		

 1			
GEV No.	106945	Ref. No.	006911
description	burner lower part for burner cap ø 100mm new edition		

 1			
GEV No.	105034	Ref. No.	006911 alt
description	burner lower part for burner cap ø 100mm with venturi		
accessories for	105034		
	GEV No.	105010	Ref. No. 069201
	burner cap ø 100mm seat ø 75mm		
	GEV No.	105016	Ref. No. 069111
	burner head for burner cap ø 100mm		
	GEV No.	105031	Ref. No. 020824
	gasket ø 80mm for burner cap ø 100mm ID ø 56mm thickness 2mm fibre		

 1			
GEV No.	105032	Ref. No.	006912
description	burner lower part for burner cap ø 80mm with venturi		
For models:	BSC4FE80, HP4652G, HP8654G, PC127FTE, PC127FTG, PC1G40, PC2G, TOP2G, TOPG		
accessories for	105032		
	GEV No.	105029	Ref. No. 069200/17 069200/A
	burner cap ø 80mm		
	GEV No.	105030	Ref. No. 069205
	burner ring for burner cap ø 80mm		
	GEV No.	105033	Ref. No. 062150/A
	nozzle holder		
	GEV No.	105038	Ref. No. 020822
	gasket for burner cap ø 80mm		

 1			
GEV No.	105019	Ref. No.	069206
description	burner ring for burner cap ø 100mm		
accessories for	105019		
	GEV No.	105018	Ref. No. 069201/A
	burner cap ø 100mm seat ø 75mm		
	GEV No.	105031	Ref. No. 020824
	gasket ø 80mm for burner cap ø 100mm ID ø 56mm thickness 2mm fibre		
	GEV No.	105033	Ref. No. 062150/A
	nozzle holder		
	GEV No.	105034	Ref. No. 006911 alt
	burner lower part for burner cap ø 100mm with venturi		













 1			
GEV No.	105030	Ref. No.	069205
description	burner ring for burner cap ø 80mm		
accessories for	105030		
	GEV No.	105029	Ref. No. 069200/17 069200/A
	burner cap ø 80mm		
	GEV No.	105032	Ref. No. 006912
	burner lower part for burner cap ø 80mm with venturi		

Table continues overleaf



accessories for	105030			
	GEV No.	105033	Ref. No.	062150/A
	nozzle holder			
	GEV No.	105038	Ref. No.	020822
	gasket for burner cap ø 80mm			





1				
GEV No.	105038	Ref. No.	020822	
description	gasket for burner cap ø 80mm			
accessories for	105038			
	GEV No.	105029	Ref. No.	069200/17 069200/A
	burner cap ø 80mm			
	GEV No.	105030	Ref. No.	069205
	burner ring for burner cap ø 80mm			
	GEV No.	105032	Ref. No.	006912
	burner lower part for burner cap ø 80mm with venturi			
	GEV No.	105033	Ref. No.	062150/A
	nozzle holder			
	GEV No.	105879	Ref. No.	069200
	burner cap ø 80mm			
	GEV No.	105880	Ref. No.	—
	burner head for burner cap ø 80mm			
	GEV No.	105881	Ref. No.	069112
	burner lower part for burner cap ø 80mm			

1				
GEV No.	105031	Ref. No.	020824	
description	gasket ø 80mm for burner cap ø 100mm ID ø 56mm thickness 2mm fibre			
accessories for	105031			
	GEV No.	105010	Ref. No.	069201
	burner cap ø 100mm seat ø 75mm			
	GEV No.	105016	Ref. No.	069111
	burner head for burner cap ø 100mm			
	GEV No.	105017	Ref. No.	069110
	burner lower part ø 100mm			
	GEV No.	105018	Ref. No.	069201/A
	burner cap ø 100mm seat ø 75mm			
	GEV No.	105019	Ref. No.	069206
	burner ring for burner cap ø 100mm			
	GEV No.	105033	Ref. No.	062150/A
	nozzle holder			





accessories for	105031			
	GEV No.	105034	Ref. No.	006911 alt
	burner lower part for burner cap ø 100mm with venturi			





1				
GEV No.	105033	Ref. No.	062150/A	
description	nozzle holder			
accessories for	105033			
	GEV No.	105018	Ref. No.	069201/A
	burner cap ø 100mm seat ø 75mm			
	GEV No.	105019	Ref. No.	069206
	burner ring for burner cap ø 100mm			
	GEV No.	105029	Ref. No.	069200/17 069200/A
	burner cap ø 80mm			
	GEV No.	105030	Ref. No.	069205
	burner ring for burner cap ø 80mm			
	GEV No.	105032	Ref. No.	006912
	burner lower part for burner cap ø 80mm with venturi			
	GEV No.	105034	Ref. No.	006911 alt
	burner lower part for burner cap ø 100mm with venturi			
	GEV No.	105038	Ref. No.	020822
	gasket for burner cap ø 80mm			

700 series

1				
GEV No.	105010	Ref. No.	069201	
description	burner cap ø 100mm seat ø 75mm			
For models:	C2FG, C3FG, C3G			
accessories for	105010			
	GEV No.	105016	Ref. No.	069111
	burner head for burner cap ø 100mm			
	GEV No.	105031	Ref. No.	020824
	gasket ø 80mm for burner cap ø 100mm ID ø 56mm thickness 2mm fibre			
	GEV No.	105034	Ref. No.	006911 alt
	burner lower part for burner cap ø 100mm with venturi			

			
1			
GEV No.	105879	Ref. No.	069200
description	burner cap ø 80mm		





			
1			
GEV No.	105016	Ref. No.	069111
description	burner head for burner cap ø 100mm		
accessories for	105016		
	GEV No.	105010	Ref. No. 069201
burner cap ø 100mm seat ø 75mm			
	GEV No.	105031	Ref. No. 020824
gasket ø 80mm for burner cap ø 100mm ID ø 56mm thickness 2mm fibre			
	GEV No.	105034	Ref. No. 006911 alt
burner lower part for burner cap ø 100mm with venturi			

			
1			
GEV No.	105034	Ref. No.	006911 alt
description	burner lower part for burner cap ø 100mm with venturi		
accessories for	105034		
	GEV No.	105010	Ref. No. 069201
burner cap ø 100mm seat ø 75mm			
	GEV No.	105016	Ref. No. 069111
burner head for burner cap ø 100mm			
	GEV No.	105031	Ref. No. 020824
gasket ø 80mm for burner cap ø 100mm ID ø 56mm thickness 2mm fibre			

			
1			
GEV No.	105881	Ref. No.	069112
description	burner lower part for burner cap ø 80mm		

			
1			
GEV No.	105032	Ref. No.	006912
description	burner lower part for burner cap ø 80mm with venturi		
For models:	BSC4FE80, HP4652G, HP8654G, PC127FTE, PC127FTG, PC1G40, PC2G, TOP2G, TOPG		
accessories for	105032		
	GEV No.	105029	Ref. No. 069200/17 069200/A
burner cap ø 80mm			
	GEV No.	105030	Ref. No. 069205
burner ring for burner cap ø 80mm			
	GEV No.	105033	Ref. No. 062150/A
nozzle holder			
	GEV No.	105038	Ref. No. 020822
gasket for burner cap ø 80mm			

			
1			
GEV No.	105017	Ref. No.	069110
description	burner lower part ø 100mm		
For models:	GR-MGZ-L-2129, GR-MGZ-R-2128		

			
1			
GEV No.	105030	Ref. No.	069205
description	burner ring for burner cap ø 80mm		
accessories for	105030		
	GEV No.	105029	Ref. No. 069200/17 069200/A
burner cap ø 80mm			
	GEV No.	105032	Ref. No. 006912
burner lower part for burner cap ø 80mm with venturi			
	GEV No.	105033	Ref. No. 062150/A
nozzle holder			
	GEV No.	105038	Ref. No. 020822
gasket for burner cap ø 80mm			



 <p>1</p>			
GEV No.	105038	Ref. No.	020822
description	gasket for burner cap ø 80mm		
accessories for	105038		
	GEV No.	105029	Ref. No. 069200/17 069200/A
burner cap ø 80mm			
	GEV No.	105030	Ref. No. 069205
burner ring for burner cap ø 80mm			
	GEV No.	105032	Ref. No. 006912
burner lower part for burner cap ø 80mm with venturi			
	GEV No.	105033	Ref. No. 062150/A
nozzle holder			
	GEV No.	105879	Ref. No. 069200
burner cap ø 80mm			
	GEV No.	105880	Ref. No. —
burner head for burner cap ø 80mm			
	GEV No.	105881	Ref. No. 069112
burner lower part for burner cap ø 80mm			

 <p>1</p>			
GEV No.	105031	Ref. No.	020824
description	gasket ø 80mm for burner cap ø 100mm ID ø 56mm thickness 2mm fibre		
accessories for	105031		
	GEV No.	105010	Ref. No. 069201
burner cap ø 100mm seat ø 75mm			
	GEV No.	105016	Ref. No. 069111
burner head for burner cap ø 100mm			
	GEV No.	105017	Ref. No. 069110
burner lower part ø 100mm			
	GEV No.	105018	Ref. No. 069201/A
burner cap ø 100mm seat ø 75mm			
	GEV No.	105019	Ref. No. 069206
burner ring for burner cap ø 100mm			
	GEV No.	105033	Ref. No. 062150/A
nozzle holder			
	GEV No.	105034	Ref. No. 006911 alt
burner lower part for burner cap ø 100mm with venturi			

 <p>1</p>			
GEV No.	105020	Ref. No.	068171
description	venturi		

pan supports

 <p>1</p>			
GEV No.	210226	Ref. No.	059006
description	pan support W 340mm L 620mm		

accessories

pan supports

 <p>1</p>			
GEV No.	210163	Ref. No.	0550M48200
description	pan support		
For models:	ABJ0001, ABJ0002		

 <p>1</p>			
GEV No.	210226	Ref. No.	059006
description	pan support W 340mm L 620mm		

 <p>1</p>			
GEV No.	210161	Ref. No.	0550X25000
description	pan support W 385mm L 580mm		
For models:	ACA2001, ACA2002, ACA2003, ACA2004, ACA2006, ACA2008, ACA2010, ACA2011, ACA2012, ACJ0001, ACJ0003		



bar burners

bar burners



GEV No.	105102	Ref. No.	X68046
description	bar burner 1-row ø 27mm Wmm Hmm L 418mm oven		
For models:	ACB0001, ADB0001, AEB0003, BM48G		
spare parts for	105102		
	GEV No.	104651	Ref. No. —
	mounting flange for igniter and thermocouple		



GEV No.	105115	Ref. No.	Y22200
description	bar burner 1-row ø 40mm Wmm Hmm L 500mm flange width 43mm flange length 43mm tilting bratt pan		
For models:	ADK2007, ADK2008, ADK2009, ADK2010, AEK2005, AEK2006, AEK2007, AEK2008		



GEV No.	105260	Ref. No.	X20100
description	bar burner 2 row L 450mm W 300mm ømm H 50mm 8.5kW griddle		
For models:	ABH3014, ABH3015, ABH3016, ABH3017, ABH3018, ACH3015, ACH3016, ACH3017		



GEV No.	105302	Ref. No.	Y22000
description	bar burner 3 row L 445mm W 280mm ømm H 40mm solid top		
For models:	AEA2005		



GEV No.	105340	Ref. No.	X24100
description	bar burner 3 row L 480mm W 305mm ømm H 60mm mounting distance 280mm chargrill		
For models:	ABH1001, ABH1002, ACH1001, ACH1002, ACH1003, ACH1004, ADH1001, ADH1002, AEH1001, AEH1002, SKPL1G, SKPL2G		



GEV No.	105303	Ref. No.	Y20100
description	bar burner 3 row L 630mm W 265mm ømm H 60mm griddle		
For models:	ADH3007, ADH3008, ADH3010, ADH3011, AEH3007, AEH3008, AEH3009, AEH3010, AEH3011, AEH3012, GFT49L, GFT49LC, GFT49R, GFT89L, GFT89LC, GFT89LR, KFT8GLR		



GEV No.	105105	Ref. No.	X20400
description	bar burner angled L 600mm W 305mm ømm Hmm oven		
For models:	ACA2005, ACA2009, ADA2009		



GEV No.	105103	Ref. No.	X68401
description	bar burner ø 27mm Wmm Hmm L 638mm oven		
For models:	ACA2004, ACA2008		

spare parts for	105103		
	GEV No.	104651	Ref. No. —
	mounting flange for igniter and thermocouple		

accessories for	105103		
	GEV No.	104651	Ref. No. —
	mounting flange for igniter and thermocouple		





 <p>1</p>			
GEV No.	105110	Ref. No.	X20600
description	bar burner ø 40mm Wmm Hmm L 323mm tilting bratt pan flange ø 61mm		
For models:	ACK2001, BRG70		

 <p>1</p>			
GEV No.	105718	Ref. No.	E30100
description	bar burner ø 40mm Wmm Hmm L 395mm flange ø 61mm tilting bratt pan		
For models:	ADL0006, ADL0007, ADL0013, AEL0004, AEL0005		

 <p>1</p>			
GEV No.	105108	Ref. No.	X23800
description	bar burner ø 50mm Wmm Hmm L 350mm pasta cooker		
For models:	ACE0001		

 <p>1</p>			
GEV No.	105882	Ref. No.	068187
description	bar burner ømm W 150mm H 40mm L 685mm oven		

 <p>1</p>			
GEV No.	105255	Ref. No.	X20000
description	bar burner ømm W 41mm H 34mm L 490mm flange width 70mm 5.5kW griddle		
For models:	ABH3010, ABH3011, ABH3012, ACH3008, ACH3009, ACH3010, ACH3011, ACH3012, ACH3013, ACH3014		

 <p>1</p>			
GEV No.	105341	Ref. No.	B49900
description	lava rock grid L 450mm W 330mm		
For models:	ACH1002, ACH1004		

lava rock grids

 <p>1</p>			
GEV No.	105341	Ref. No.	B49900
description	lava rock grid L 450mm W 330mm		
For models:	ACH1002, ACH1004		

tube burners

 <p>1</p>			
GEV No.	105261	Ref. No.	0900X23100
description	tubular burner ø 74mm L 180mm W 75mm H 60mm for fryer round		
For models:	ACC0001, ACC0002, ACC0006, ACC0007, ADC0001, ADC0002, AEC0007, AEC0008		

ceramic burners

accessories

burner grids

 <p>1</p>			
GEV No.	210149	Ref. No.	056451
description	burner grid L 340mm W 215mm for gyro grill		



 <p>1</p>			
GEV No.	210153	Ref. No.	056452
description	burner grid L 500mm W 215mm for gyro grill		

			
1			
GEV No.	210129	Ref. No.	056454
description	burner grid L 660mm W 215mm for gyro grill		

			
1			
GEV No.	210154	Ref. No.	056453
description	burner grid L 660mm W 215mm for gyro grill		

accessories

nozzle holders

			
1			
GEV No.	105033	Ref. No.	062150/A
description	nozzle holder		
accessories for	105033		
	GEV No.	105038	Ref. No. 020822
	gasket for burner cap ø 80mm		

gas nozzles

main nozzles

gas nozzles M7x1

			
1			
GEV No.	100519	Ref. No.	X38300
description	gas injector thread M7x1 WS 10 bore ø 0.95mm		
For models:	ABJ0001, ABJ0002		

			
1			
GEV No.	100523	Ref. No.	X38800
description	gas injector thread M7x1 WS 10 bore ø 1.4mm		
For models:	ABJ0001, ABJ0002		

			
1			
GEV No.	100524	Ref. No.	X39300
description	gas injector thread M7x1 WS 10 bore ø 1.55mm		
For models:	ABJ0001, ABJ0002		

gas nozzles M10x1

			
1			
GEV No.	100420	Ref. No.	X33600
description	gas injector thread M10x1 WS 11 bore ø 0.95mm		
For models:	ACA2001, ACA2002, ACA2003, ACA2004, ACA2005, ACA2006, ACA2007, ACA2008, ACA2009, ACA2010, ACA2011, ACA2012, ACC0001, ACC0002, ACC0006, ACC0007, ACJ0001, ACJ0003, ADA2001, ADA2002, ADA2003, ADA2004, ADA2005, ADA2006, ADA2007, ADA2008, ADA2009, ADA2010, ADA2017, ADC0001, ADC0002, AEA2001, AEA2002, AEA2003, AEA2004, AEC0007, AEC0008, K2FZ		

			
1			
GEV No.	106490	Ref. No.	X34200
description	gas injector thread M10x1 WS 11 bore ø 1.25mm		
For models:	ABH3010, ABH3011, ABH3012, ACH3008, ACH3009, ACH3010, ACH3011, ACH3012, ACH3013, ACH3014, ADA2001, ADA2002, ADA2003, ADA2004, ADA2005, ADA2006, ADA2007, ADA2008, ADA2009, ADA2010, ADA2017, AEA2001, AEA2002, AEA2003, AEA2004, K2FZ		

			
1			
GEV No.	101997	Ref. No.	X34500
description	gas injector thread M10x1 WS 11 bore ø 1.4mm		
For models:	ADA2009		

			
1			
GEV No.	100793	Ref. No.	X34700
description	gas injector thread M10x1 WS 11 bore ø 1.5mm		
For models:	ACA2001, ACA2002, ACA2003, ACA2004, ACA2005, ACA2006, ACA2007, ACA2008, ACA2009, ACA2010, ACA2011, ACA2012, ACJ0001, ACJ0003, ADA2002, ADA2003, ADA2004, ADA2005, ADA2006, ADA2007, ADA2009, ADA2017, AEA2001, AEA2002, AEA2003, AEA2004		



pilot burner nozzles

pilot burner nozzles SIT

100 series



GEV No.	100245	Ref. No.	X19906
description	pilot burner nozzle LPG code 20 bore ø 0.2mm Qty 1 pcs thread M8x0.75		
For models:	ADA2009, ADC0001, ADC0002, ADE0001, ADH1001, ADH1002, AEC0007, AEC0008, AEH1001, AEH1002, CP49G, CP89G		



GEV No.	100246	Ref. No.	X19907
description	pilot burner nozzle natural gas bore ø 0.35mm Qty 1 pcs thread M8x0.75		
For models:	ADA2009, ADC0001, ADC0002, ADE0001, AEC0007, AEC0008, CP49G, CP89G		

140/150 series



GEV No.	100205	Ref. No.	X30000
description	pilot burner nozzle SIT LPG code 19 bore ø 0.23/0.26mm Qty 1 pcs suitable for SIT 150 series		
For models:	ABH3010, ABH3011, ABH3012, ABH3014, ABH3015, ABH3016, ABH3017, ABH3018, ACH3008, ACH3009, ACH3010, ACH3011, ACH3012, ACH3013, ACH3014, ACH3015, ACH3016, ACH3017, ADA2001, ADA2002, ADA2003, ADA2004, ADA2005, ADA2006, ADA2007, ADA2008, ADA2009, ADA2010, ADA2017, ADH3007, ADH3008, ADH3010, ADH3011, ADK2007, ADK2008, ADK2009, ADK2010, AEA2001, AEA2002, AEA2003, AEA2004, AEA2005, AEH3007, AEH3008, AEH3009, AEH3010, AEH3011, AEH3012, AEK2005, AEK2006...(Other models you can see in the webshop)		

bypass nozzles

bypass nozzles PEL20/21



GEV No.	100554	Ref. No.	X11000
description	bypass nozzle type PEL20/21 bore ø 0.45mm thread M5x0.5		
For models:	ADA2001, ADA2002, ADA2003, ADA2004, ADA2005, ADA2006, ADA2007, ADA2008, ADA2009, ADA2010, ADA2017, AEA2001, AEA2002, AEA2003, AEA2004, K2FZ		



GEV No.	100278	Ref. No.	X04800
description	bypass nozzle type PEL20/21 bore ø 0.75mm thread M5x0.5		
For models:	ADA2001, ADA2002, ADA2003, ADA2004, ADA2005, ADA2006, ADA2007, ADA2008, ADA2009, ADA2010, ADA2017, AEA2001, AEA2002, AEA2003, AEA2004, K2FZ		

auxiliary gas parts

screw connections

T-pieces



GEV No.	101833	Ref. No.	062155
description	T-piece		

consumables

lava rocks / ceramic briquettes



GEV No.	105342	Ref. No.	M30500
description	lava rocks content 9kg		
For models:	ABH1001, ABH1002, ACH1001, ACH1002, ACH1003, ACH1004, ADH1001, ADH1002, AEH1001, AEH1002, SKPL1G, SKPL2G		

equipment-specific units

for meat mincers

locking screws

locking screws



GEV No.	698092	Ref. No.	AM.F2115
description	locking screw thread M10 thread L 30mm handle ø 60mm plastic		
For models:	TG12, TG12R, TS12		

funnel trays





GEV No.	698077	Ref. No.	AM.F2038 AM.F2113
description	hopper filling pipe central L 275mm W 200mm H 50mm tube ø 52mm		
For models:	TG12, TG12R, TS8		

			
1			
GEV No.	698076	Ref. No.	AM.F2207
description	hopper filling pipe central L 370mm W 250mm H 60mm tube ø 52mm		
For models:	TG22, TS22		

funnels			
			
1			
GEV No.	698085	Ref. No.	AM.F2149
description	funnel model 12 ø 15mm		
For models:	TG12, TG12R, TS12		

			
1			
GEV No.	698086	Ref. No.	AM.F2150
description	funnel model 12 ø 20mm ED ø 65mm L 135mm		
For models:	TG12, TG12R, TS12		

			
1			
GEV No.	698087	Ref. No.	AM.F2151
description	funnel model 12 ø 25mm		
For models:	TG12, TG12R, TS12		

			
1			
GEV No.	698082	Ref. No.	AM.F2050
description	funnel model 8 ø 15mm		
For models:	TS8		

			
1			
GEV No.	698083	Ref. No.	AM.F2051
description	funnel model 8 ø 20mm		
For models:	TS8		

grinder plates
ENTERPRISE
with 1 notch
with hub

			
1			
GEV No.	696117	Ref. No.	AM.F2131 (ø 10mm)
description	grinder plate type ENTERPRISE size 12 hole ø 10mm with hub grooves 1 stainless steel ø 70mm		

			
1			
GEV No.	696118	Ref. No.	AM.F2131 (ø 12mm)
description	grinder plate type ENTERPRISE size 12 hole ø 12mm with hub grooves 1 stainless steel ø 70mm		



1

GEV No.	696119	Ref. No.	AM.F2131 (ø 14mm)
description	grinder plate type ENTERPRISE size 12 hole ø 14mm with hub grooves 1 stainless steel ø 70mm		



1

GEV No.	696107	Ref. No.	AM.F2045 (ø 12mm)
description	grinder plate type ENTERPRISE size 8 hole ø 12mm with hub grooves 1 stainless steel ø 62mm		



1

GEV No.	696120	Ref. No.	AM.F2131 (ø 16mm)
description	grinder plate type ENTERPRISE size 12 hole ø 16mm with hub grooves 1 stainless steel ø 70mm		



1

GEV No.	696108	Ref. No.	AM.F2045 (ø 14mm)
description	grinder plate type ENTERPRISE size 8 hole ø 14mm with hub grooves 1 stainless steel ø 62mm		



1

GEV No.	696121	Ref. No.	AM.F2131 (ø 18mm)
description	grinder plate type ENTERPRISE size 12 hole ø 18mm with hub grooves 1 stainless steel ø 70mm		



1

GEV No.	696109	Ref. No.	AM.F2045 (ø 16mm)
description	grinder plate type ENTERPRISE size 8 hole ø 16mm with hub grooves 1 stainless steel ø 62mm		



1

GEV No.	696106	Ref. No.	AM.F2045 (ø 10mm)
description	grinder plate type ENTERPRISE size 8 hole ø 10mm with hub grooves 1 stainless steel ø 62mm		

with 2 notches

with hub



1

GEV No.	696111	Ref. No.	AM.F2131 (ø 2mm)
description	grinder plate type ENTERPRISE size 12 hole ø 2mm with hub grooves 2 stainless steel ø 70mm		

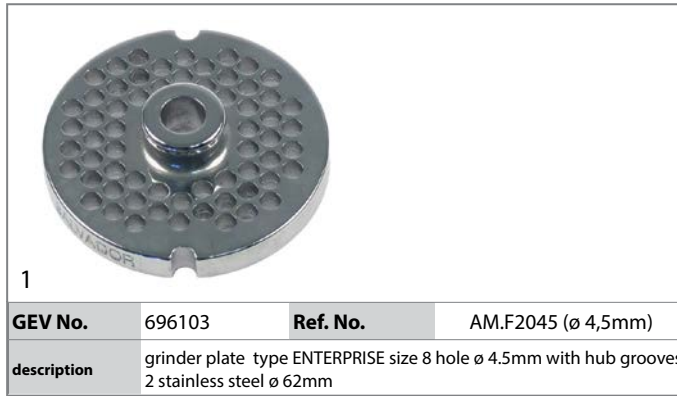
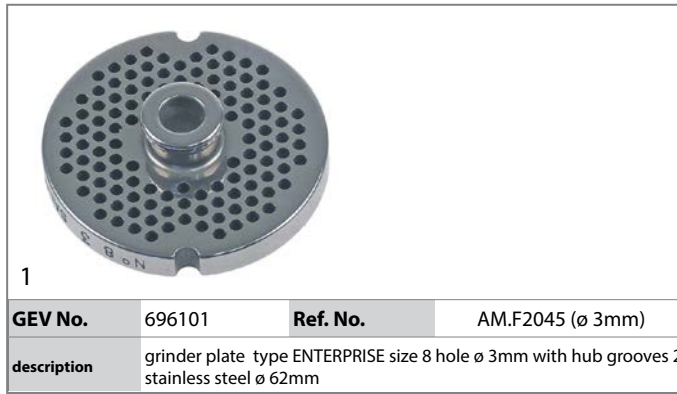
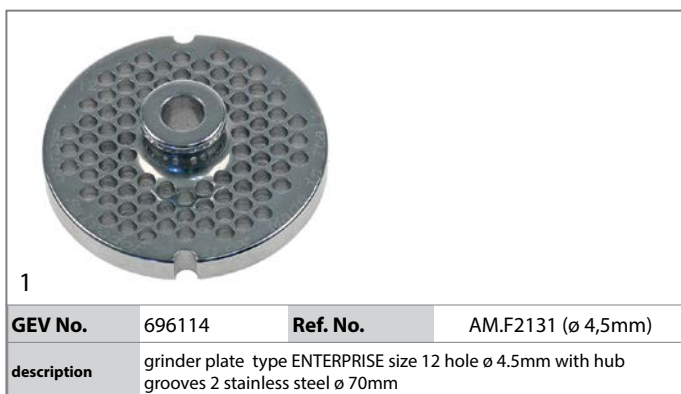
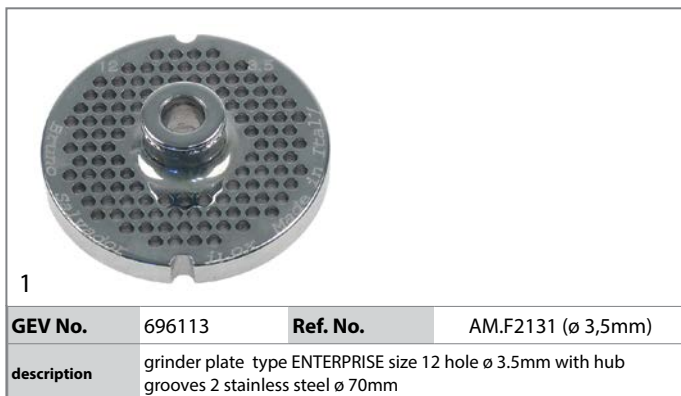



1

GEV No.	696104	Ref. No.	AM.F2045 (ø 6mm)
description	grinder plate type ENTERPRISE size 8 hole ø 6mm with hub grooves 2 stainless steel ø 62mm		



1

GEV No.	696105	Ref. No.	AM.F2045 (ø 8mm)
description	grinder plate type ENTERPRISE size 8 hole ø 8mm with hub grooves 2 stainless steel ø 62mm		

blades

ENTERPRISE



1

GEV No.	696022	Ref. No.	AM.F2130
description	knife type ENTERPRISE size 12 ø 62mm internal size 12x12mm stainless steel		
For models:	TG12, TG12R, TS12		



1

GEV No.	696021	Ref. No.	AM.F2044
description	knife type ENTERPRISE size 8 ø 55mm internal size 10x10mm stainless steel		
For models:	TS8		

ring nuts



1

GEV No.	698024	Ref. No.	AM.F2046
description	ring nut model 8 aluminium		
For models:	TS8		



1

GEV No.	698040	Ref. No.	AM.F2133
description	ring nut Unger model 12 ED ø 89mm thickness 27mm ID ø 64mm stainless steel thread M82x2		
For models:	TS12		



1

GEV No.	698039	Ref. No.	AM.F2132
description	ring nut Unger model 12 ID ø 78mm aluminium		
For models:	TG12, TG12R, TS12		



1

GEV No.	698057	Ref. No.	AM.F2220
description	ring nut Unger model 22 ID ø 73mm aluminium		
For models:	TG22, TS22		



1

GEV No.	698058	Ref. No.	AM.F2221
description	ring nut Unger model 22 ID \varnothing 74mm stainless steel thread M94x2		
For models:	TG22, TS22		

augers

complete



1

GEV No.	698037	Ref. No.	AM.F2124
description	auger model 12 \varnothing 53mm L 135mm stainless steel with spindle ENTERPRISE		
For models:	TG12, TG12R, TS12		



1

GEV No.	698035	Ref. No.	AM.F2122
description	auger model 12 \varnothing 53mm L 140mm aluminium with spindle ENTERPRISE		
For models:	TG12, TG12R, TS12		



1

GEV No.	698036	Ref. No.	AM.F2123
description	auger model 12 \varnothing 53mm L 150mm cast iron with spindle ENTERPRISE		
For models:	TG12, TG12R, TS12		



1

GEV No.	698053	Ref. No.	AM.F2214
description	auger model 22 \varnothing 63mm L 150mm aluminium with spindle ENTERPRISE		
For models:	TG22, TS22		



1

GEV No.	698054	Ref. No.	AM.F2215
description	auger model 22 \varnothing 63mm L 150mm cast iron with spindle ENTERPRISE		
For models:	TG22, TS22		



1

GEV No.	698055	Ref. No.	AM.F2216
description	auger model 22 \varnothing 64mm L 150mm stainless steel with spindle ENTERPRISE		
For models:	TG22, TS22		



1

GEV No.	698021	Ref. No.	AM.F2041
description	auger model 8 \varnothing 45mm L 117mm aluminium with spindle ENTERPRISE		
For models:	TS8		



augers chambers

inner parts



GEV No.	698032	Ref. No.	AM.F2117
description	auger chamber ENTERPRISE model 12 inlet ø 56mm cast iron		
For models:	TG12, TG12R, TS12		



GEV No.	698034	Ref. No.	AM.F2118
description	auger chamber ENTERPRISE model 12 inlet ø 61mm stainless steel		
For models:	TS12		



GEV No.	698050	Ref. No.	AM.F2212
description	auger chamber ENTERPRISE model 22 inlet ø 62mm aluminium		
For models:	TG22		



GEV No.	698051	Ref. No.	AM.F2210
description	auger chamber ENTERPRISE model 22 inlet ø 62mm cast iron		
For models:	TG22		



GEV No.	698052	Ref. No.	AM.F2211
description	auger chamber ENTERPRISE model 22 inlet ø 62mm stainless steel thread M94x2		
For models:	TG22		

accessories for	698052			
	GEV No.	690058	Ref. No.	—
	counter support for off-set 19mm mounting distance 14.25mm W 28mm L 52mm H 50mm type 6000/6004 no. 6000-020701			

plungers



GEV No.	698080	Ref. No.	AM.F2037 AM.F2114 AM.F2208
description	plunger ø 46mm L 120mm total length 240mm plastic hollow		
For models:	TG12, TG12R, TG22, TS12, TS22, TS8		

for vegetable slicers

miscellaneous



GEV No.	110703	Ref. No.	064013
description	cylindrical handle thread M10 ø 28mm L 87mm		
For models:	PIZZA41, PIZZA42, PIZZA62		

for cheese graters

miscellaneous



GEV No.	110703	Ref. No.	064013
description	cylindrical handle thread M10 ø 28mm L 87mm		
For models:	PIZZA41, PIZZA42, PIZZA62		

for dough mixers

flange bearings



GEV No.	693112	Ref. No.	X61400
description	flange bearing type UCF204 shaft ø 20mm 4 hole flange hole distance 64mm H 33mm flange length 86mm flange width 86mm hole ø 12mm flange F204 ball bearing UC204G2 FH 25.5mm		
For models:	ACK2001, ACK2003, BR70, BRG70		

for display coolers

glass panels

glass panels



1

GEV No.	695167	Ref. No.	067038
description	glass panel L 240mm W 370mm thickness 8mm for vitrine		

for deep fryers

lids



1

GEV No.	970369	Ref. No.	B65300
description	lid for fryer		
For models:	ABC0003, ABC0005, ACC0003, ACC0008, ACC0009, ACC0010, AEC0001, AEC0002, SKF4E, SKF6E		

sumps



1

GEV No.	695118	Ref. No.	058102
description	sump for fryer with hole L 320mm W 260mm H 200mm 8l		
For models:	F88M, F88T, F8M, F8T, FE8, FE88, FM8, FM8+8-1241, FM8-1240, FM88		

for gyros grills

glass panels



1

GEV No.	693053	Ref. No.	067023.1
description	glass panel L 180mm W 180mm thickness 4mm square		

gyro slicers



1

GEV No.	691029	Ref. No.	009869.23
description	slicing unit		

skewers



1

GEV No.	693653	Ref. No.	056456
description	skewer for gyro grill size 12x12mm L 460mm		



1

GEV No.	693654	Ref. No.	059017
description	skewer for gyro grill size 12x12mm L 465mm		



1

GEV No.	693655	Ref. No.	059018
description	skewer for gyro grill size 12x12mm L 615mm		



			
1			
GEV No.	693656	Ref. No.	059019
description	skewer for gyro grill size 12x12mm L 775mm		

			
1			
GEV No.	693657	Ref. No.	059020
description	skewer for gyro grill size 12x12mm L 965mm		

skewer plates			
			
1			
GEV No.	693649	Ref. No.	056422
description	skewer plate for gyro grill		

			
1			
GEV No.	693650	Ref. No.	098025
description	skewer plate for gyro grill		

cotter pins			
			
1			
GEV No.	693457	Ref. No.	020102
description	retainer clip L 73mm wire gauge ø 3mm zinc-coated steel Qty 1 pcs		
For models:	GY100E, GY100G, GY20EIR, GY30EIR, GY40E, GY40G, GY60E, GY60E-9830, GY60G, GY70G, GY80E, GY80E-9831, GY80EIR, GY80G, GY90EIR, GY90G, GYINO10E, GY-INO10E-9841, GYINO10G, GYINO30G, GYROS-100G-9828, GYROS-10G-9842, GYROS-20G-9843, GYROS-40G-9825, GYROS-60G-9826, GYROS-80G-9827		

for hot dog machines

lids			
			
1			
GEV No.	693098	Ref. No.	058502
description	lid		

glass cylinders			
			
1			
GEV No.	693002	Ref. No.	066006
description	glass cylinder ø 200mm Pyrex glass H 240mm		
For models:	STARHD, STARHD4, STARSW		

miscellaneous			
			
1			
GEV No.	693468	Ref. No.	057501
description	grid basket for hot dog grill ø 180mm H 210mm		

skewers			
			
1			
GEV No.	693094	Ref. No.	055804
description	bun spikes		
For models:	STARHD, STARHD4, STARSP4, STARSP6		

for tilting bratt pans

spindles			
			
1			
GEV No.	690546	Ref. No.	K49100
description	thread block thread Tr24x5 right-hand thread W 38mm bolt ø 20mm D 40mm H 40mm		
For models:	ADK2001, ADK2002, ADK2003, ADK2004, ADK2007, ADK2008, ADK2009, ADK2010, AEK2001, AEK2002, AEK2003, AEK2004, AEK2005, AEK2006, AEK2007, AEK2008		



GEV No.	690543	Ref. No.	X65400
description	threaded rod		
For models:	ACK2001, ACK2003, BRE70, BRG70		

for pizza ovens

glass panels



GEV No.	693123	Ref. No.	067020
description	glass panel L 123mm W 50mm thickness 5mm rectangular		

for salamander grills



GEV No.	693054	Ref. No.	055813
description	mechanism for salamander grill		

for toasters

pliers

pliers



GEV No.	690010	Ref. No.	PIN-T
description	plier for toaster H 180mm total length 100mm		

knobs

producer-specific knobs

STAR 10



GEV No.	111845	Ref. No.	082345
description	knob dial plate energy regulator 1-4 + MAX grey		



GEV No.	111844	Ref. No.	082335
description	knob dial plate energy regulator 1-4 + MAX yellow		



GEV No.	110496	Ref. No.	082348
description	knob dial plate energy regulator 1-6 / 7-position grey		



GEV No.	110495	Ref. No.	082338
description	knob dial plate energy regulator 1-6 / 7-position yellow		



GEV No.	111854	Ref. No.	082340
description	knob dial plate switch 0-1 grey		

1

GEV No.	110476	Ref. No.	082330
description	knob dial plate switch 0-1 yellow		



1

GEV No.	111851	Ref. No.	082307
description	knob dial plate gas tap with ignition flame yellow		



1

GEV No.	111853	Ref. No.	082333
description	knob dial plate thermostat 50-250°C yellow		



1

GEV No.	111841	Ref. No.	082316
description	knob dial plate gas tap without ignition flame		



1

GEV No.	111855	Ref. No.	082343
description	knob dial plate thermostat t.max. 250°C 50-250°C grey		



1

GEV No.	111883	Ref. No.	082306
description	knob dial plate gas tap without ignition flame grey		
For models:	BSC6FG, PC1G40, PC2G		



1

GEV No.	110491	Ref. No.	082331
description	knob dial plate thermostat t.max. 90°C 30-90°C yellow		



1

GEV No.	110484	Ref. No.	082310
description	knob dial plate switch 0-1		



1

GEV No.	111846	Ref. No.	082315
description	knob dial plate energy regulator 1-4 + MAX grey		



1

GEV No.	110403	Ref. No.	082300
description	knob dial plate switch 0-1 yellow		



1

GEV No.	111852	Ref. No.	082317
description	knob dial plate gas tap with ignition flame		



1

GEV No.	111842	Ref. No.	082308
description	knob dial plate switch 7-position yellow		



1

GEV No.	111849	Ref. No.	082313
description	knob dial plate thermostat t.max. 250°C 50-250°C		



1

GEV No.	111848	Ref. No.	082303
description	knob dial plate thermostat t.max. 250°C 50-250°C yellow		



1

GEV No.	110478	Ref. No.	082314
description	knob dial plate thermostat t.max. 300°C 50-300°C		



1

GEV No.	110490	Ref. No.	082311
description	knob dial plate thermostat t.max. 90°C 30-90°C		



1

GEV No.	110483	Ref. No.	082301
description	knob dial plate thermostat t.max. 90°C 30-90°C yellow		



1

GEV No.	110771	Ref. No.	0000X00800
description	knob gas tap with ignition flame ø 60mm shaft ø 8x6.5mm shaft flat upper black		
For models:	ABH1001, ABH1002, ABH3010, ABH3011, ABH3012, ABH3014, ABH3015, ABH3016, ABH3017, ABH3018, ACA2001, ACA2002, ACA2003, ACA2012, ACH1001, ACH1002, ACH1003, ACH1004, ACH3008, ACH3010, ACH3011, ACH3013, ACH3014, ACH3015, ACH3017, ACJ0001, ACJ0003, SKPL1G, SKPL2G		

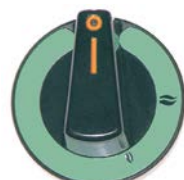

1

GEV No.	110049	Ref. No.	0000X00100
description	knob gas tap without ignition flame ø 60mm shaft ø 8x6.5mm shaft flat upper		
For models:	ABJ0001, ABJ0002, ACA2004, ACA2006, ACA2008, ACA2010, ACA2011		



1

GEV No.	110352	Ref. No.	0000X00900
description	knob gas thermostat 1-8 ø 60mm shaft ø 8x6.5mm shaft flat upper black		
For models:	ACA2004, ACA2008		



1

GEV No.	110774	Ref. No.	0000X03800 old version
description	knob oven ø 60mm shaft ø 6x4.6mm shaft flat lower black		



1

GEV No.	110775	Ref. No.	0000X01200
description	knob oven TH/BH/TH+BH ø 60mm shaft ø 6x4.6mm shaft flat upper black		
For models:	ACA1004, ACA1005, ACA1006, ACA2007		



1

GEV No.	110773	Ref. No.	0000X00600
description	knob switch 0-1 ø 60mm shaft ø 6x4.6mm shaft flat upper black		
For models:	ABK3001, ABK3002, ACK3001, ACK3002, ACK3003, ACK3004		



1

GEV No.	110770	Ref. No.	0000X01000
description	knob switch 4-position ø 60mm shaft ø 6x4.6mm shaft flat upper		
For models:	ACE0003, ACE0004, ACE0008		



1

GEV No.	110776	Ref. No.	0000X03700
description	knob thermostat t.max. 300°C 50-300°C ø 60mm shaft ø 6x4.6mm shaft flat upper black		
For models:	ACA1004, ACA1005, ACA1006, ACA2007		



1

GEV No.	110451	Ref. No.	0000X00500
description	knob switch 7-position ø 60mm shaft ø 6x4.6mm shaft flat upper black		
For models:	ABJ0003, ABJ0004, ACA1001, ACA1002, ACA1004, ACA1005, ACJ0005, ACJ0007, ACJ0008		



1

GEV No.	112136	Ref. No.	0000Y65011
description	knob switch 4-position t.max.°C ø 71mm shaft ø 6x4.6mm shaft flat upper black		
For models:	ADE0003, ADE0004, AEE0001, AEE0002		



1

GEV No.	110453	Ref. No.	0000X00400
description	knob thermostat t.max. 110°C 30-110°C ø 60mm shaft ø 6x4.6mm shaft flat upper black temperature range 30-110°C		
For models:	ACB0002, ACB0003, ACB0004, ACB0005		



1

GEV No.	112137	Ref. No.	0000Y65002
description	knob thermostat t.max. 195°C ø 71mm shaft ø 6x4.6mm shaft flat upper black temperature range 100-195°C		
For models:	AEC0001, AEC0002, AEC0003, AEC0004, AEC0005, AEC0006		



1

GEV No.	110455	Ref. No.	0000X00700
description	knob thermostat t.max. 195°C ø 60mm shaft ø 6x4.6mm shaft flat upper temperature range 100-195°C		
For models:	ABC0003, ABC0004, ABC0005, ACC0003, ACC0004, ACC0008, ACC0009, ACC0010, SKF2E4, SKF4E, SKF6E		



1

GEV No.	112135	Ref. No.	0000Y65004
description	knob thermostat t.max. 300°C ø 71mm shaft ø 6x4.6mm shaft flat upper black temperature range 50-300°C rotation 270°		
For models:	ADA1004, ADA1005, ADA1006, ADA2005, ADA2008, ADA2010, ADH3001, ADH3002, ADH3003, ADH3004, ADH3005, ADH3006, ADK2001, ADK2002, ADK2003, ADK2004, ADK2007, ADK2008, ADK2009, ADK2010, AEH3001, AEH3002, AEH3003, AEH3004, AEH3005, AEH3006, AEK2001, AEK2002, AEK2003, AEK2004, AEK2005, AEK2006, AEK2007, AEK2008, C89E, K4FFE		



1

GEV No.	110454	Ref. No.	0000X00300
description	knob thermostat t.max. 300°C 50-300°C ø 60mm shaft ø 6x4.6mm shaft flat upper		
For models:	ABH3001, ABH3002, ABH3003, ABH3004, ABH3005, ABH3006, ABH3007, ABH3008, ABH3009, ABK1001, ACA2006, ACA2010, ACA2011, ACH3001, ACH3002, ACH3003, ACH3004, ACH3005, ACH3006, ACH3007, ACH3018, ACH3019, ACH3020, ACK2003, BRE70, SKT40E, SKT40EC, SKT40ER		



1

GEV No.	110651	Ref. No.	RG.A14078
description	knob switch zero mark ø 50mm shaft ø 6x4.6mm shaft flat upper black		
For models:	WAFFLE1, WAFFLE2		



1

GEV No.	111923	Ref. No.	061030
description	knob switch zero mark ø 60mm		

accessories for 693113

	GEV No.	690968	Ref. No.	—
	roll pin ø 5mm L 20mm			



1

GEV No.	692431	Ref. No.	0900Y41900
description	hand wheel ø 200mm D1 ø 50mm bore ø 20mm thread groove width 8mm groove depth 12mm mounting distance 32mm L1 40mm L2 43mm handle length 65mm with folding handle		
For models:	ADK2001, ADK2003, ADK2007, ADK2009, AEK2001, AEK2003, AEK2005, AEK2007		

accessories

button springs



1

GEV No.	550132	Ref. No.	063009
description	knob spring ø 6x4.6mm Qty 10 pcs		
For models:	BM1375, BM140, BM1-40-4304, BM11, BM260, BM21, BM31, BM47, BM41, BM601, BM67, BMCR-4042, BMZ, BMZ200, BMZ2R, BMZ-4030, BMZR, BMZR200, BMZR-4035, BSC4FC, BS-C4FE-4563, BSC4FG, BSC4FV, C127E, C127FE, C127FG, C127FV, C1E, C2EF, C2G, C3E, C3EF, C3FG, C3G, C5FE, C5FG, C5GFE, C87E, C87FE, C87FG, C87FV, CG312E, CO511, CP1, CP1-4330, CP11, CP47GM, CP47M, CP67EM-7260, CP67EM-7560...(Other models you can see in the webshop)		

cylindrical handles

fixed



1

GEV No.	110703	Ref. No.	064013
description	cylindrical handle thread M10 ø 28mm L 87mm		
For models:	PIZZA41, PIZZA42, PIZZA62		

cone handles



1

GEV No.	693121	Ref. No.	065007
description	cone handle thread M8 ø 33mm L 82mm plastic black		
For models:	NGTL665, S110E-GIGA, S300E-GIGA, S350G-GIGA, SA650, SA650-2155, SA650G, SAM650, SAM650-2158, SAM650G, SAM650G-2623, ST400, ST650, ST650B, ST650G, ST900G, STA650KER		

mushroom cap handles



1

GEV No.	111782	Ref. No.	061003
description	mushroom cap handle thread M6 handle ø 25mm L 17mm plastic black		

handles and hand wheels

hand wheels

hand wheels



1

GEV No.	693113	Ref. No.	X18500	
description	hand wheel ø 150mm D1 ø 38mm bore ø 14mm thread groove width 5mm L1 38mm L2 40mm handle length 65mm with folding handle			
For models:	ACK2001, ACK2003, BRE70, BRG70			
spare parts for	693113			
	GEV No.	514255	Ref. No.	—
	folding handle ø 26mm total length 85mm seat ø 20mm shaft ø mm thread M6 with pin L 85mm			



handle bars

handle bars



1

GEV No.	690377	Ref. No.	065032
description	handle rod		

handle rails

handle rails



1

GEV No.	693790	Ref. No.	065016
description	handle alternative edition L 152mm W 69mm H 10mm SS		
For models:	GY80EIR, SP40Y, SP80Y		

bracket handles



1

GEV No.	690083	Ref. No.	065005
description	pull handle L 110mm H 38mm mounting distance 94mm temp.-resist. 150°C		
For models:	GY100E, GY100G, GY40E, GY40G, GY60E, GY60E-9830, GY60G, GY70G, GY80E, GY80E-9831, GY80EIR, GY80G, GY90EIR, GY90G, GYROS-100G-9828, GYROS-40G-9825, GYROS-60G-9826, GYROS-80G-9827, STARHD, STARHD4, STARS4, STARS6, STARSW		

accessories

miscellaneous



1

GEV No.	693119	Ref. No.	055807
description	hand protection for griddle		



1

GEV No.	693120	Ref. No.	055814
description	hand protection for griddle		

hinges

oven hinges

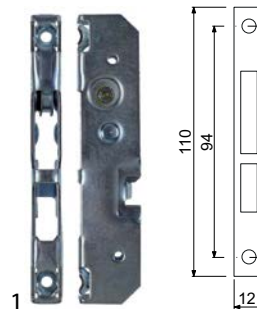

1

GEV No.	700003	Ref. No.	X68006
description	opposite support L 110mm W 12mm mounting distance 94mm		
For models:	ACA2004, ACA2006, ACA2008, ACA2010, ACA2011		

GEV No.	700013	Ref. No.	X68021
description	oven hinge mounting distance 118mm lug mounting 13mm lever length 119mm groove distance 13mm spring thickness 3.5mm mounting ear position left spring length 60mm L 154mm		
For models:	ACA2004, ACA2006, ACA2008, ACA2010, ACA2011		
accessories for	700013		
	GEV No.	700003	Ref. No. X68006
	opposite support L 110mm W 12mm mounting distance 94mm		

accessories for 700006

	GEV No.	700007	Ref. No.	X66100
	oven hinge mounting distance 173mm mounting distance 2 105mm lug mounting 14mm lever length 120mm groove distance 11mm spring thickness 3.5mm mounting ear position right spring length 112mm W 25mm			

GEV No.	700007	Ref. No.	X66100
description	oven hinge mounting distance 173mm mounting distance 2 105mm lug mounting 14mm lever length 120mm groove distance 11mm spring thickness 3.5mm mounting ear position right spring length 112mm W 25mm		
For models:	ACA1004, ACA1005, ACA1006, ACA2005, ACA2007, ACA2009, ACA2012, ADA1004, ADA1005, ADA1006, ADA2005, ADA2006, ADA2007, ADA2008, ADA2009, ADA2010, ADA2017, C89E, K4FFE		
accessories for	700007		
	GEV No.	700001	Ref. No. —
	opposite support L 118mm W 17mm mounting distance 94mm		

fittings for catering equipment

outlet taps

universal

GEV No.	540747	Ref. No.	062001
description	outlet tap chrome-plated brass angled W 30mm H 40mm thread 1/2" IT		
For models:	BM1, BM1375, BM140, BM1-40-4304, BM260, BMCR, BMCR-4042, BM-Z2R, BMZ2R200, BMZR, BMZR200, BMZR-4035, CP1, CP140, CP1-4330, CP1G, CP1GM, F10, F101, F1010, F10-1170, F101R, F102, F102R, F121, F12140, F121-4328, F121-4332, F121-4528, F121GT, F121M-4345, F122, F122M, F25, F25M, F88M, F88T, F8M, F8T, FM8, FM8+8-1241, FM8-1240, FM88, FRIT0001, FRY101, FRY102, FRY121G-1190, FRY122, FRY122M-1172, GFTL11070...(Other models you can see in the webshop)		

GEV No.	700014	Ref. No.	X68020
description	oven hinge mounting distance 118mm mounting distance 2mm lug mounting 13mm lever length 119mm groove distance 13mm spring thickness 3.5mm mounting ear position right spring length 60mm L 154mm		
For models:	ACA2004, ACA2006, ACA2008, ACA2010, ACA2011		
accessories for	700014		
	GEV No.	700003	Ref. No. X68006
	opposite support L 110mm W 12mm mounting distance 94mm		

GEV No.	700006	Ref. No.	X66000
description	oven hinge mounting distance 173mm mounting distance 2 105mm lug mounting 14mm lever length 120mm groove distance 11mm spring thickness 3.5mm mounting ear position left spring length 112mm W 25mm		
For models:	ACA1004, ACA1005, ACA1006, ACA2005, ACA2007, ACA2009, ACA2012, ADA1004, ADA1005, ADA1006, ADA2005, ADA2006, ADA2007, ADA2008, ADA2009, ADA2010, ADA2017, C89E, K4FFE		
accessories for	700006		
	GEV No.	700001	Ref. No. —
	opposite support L 118mm W 17mm mounting distance 94mm		



producer-specific

STAR 10



1

GEV No.	540730	Ref. No.	062055
description	ball valve connection 3/4" IT - 3/4" IT DN20 total length 70mm with lever handle handle length 95mm		
For models:	BM3GNI, BM47, BM4GNI, BM67, F4710, F4715, F6710, F8715, RG100, RG105, RG70		



1

GEV No.	514006	Ref. No.	062010
description	drain pipe L 200mm thread ø 22mm		
For models:	BM47, BM67, F121, F121GT, F25M, F4710, F6710, FRIT0001, FRY121G, FRY121G-1190, RG100, RG105, RG70, RG80		



1

GEV No.	540952	Ref. No.	062012
description	outlet tap L 84mm fryer lever handle grommet ø 30mm grommet length 29mm thread 3/4" IT handle length 81mm		
For models:	BM11, BM21, BM3GNI, BM31, BM4GNI, BM41, BM60I, CP1-4330, CP11, CP47GM, CP47M, CP67EM-7560, CP67M, CR32000C, F121GM, F121GT, F121GTM, F121M, F121M-4345, F4715, F47GM, F47GTM, F47IR, F47IRG, F47IRGT, F8715, F87GM, F87GTM, F87IR, F87IRG, F87IRGT, FR87IR, FRIT0001, FRY121G, FRY121G-1190, FRY121GM, FRY121GTM-1191, FRY121M-1171, FRY47IR-1164, FRY47IRGT-1162, RG100, RG80		

lid hinges







type RUBINETTERIE DEL FRIULI

for circular lids

lid hinges



1

GEV No.	540839	Ref. No.	E50000
description	lid hinge L 270mm mounting distance 139mm flange radius 470mm opening angle 80° spring thickness 5mm bore ø M16mm for circular lids		
For models:	ADL0001, ADL0002, ADL0006, ADL0007, ADL0013, AEL0001, AEL0002, AEL0004, AEL0005		
spare parts for	540839		
	GEV No.	514137	Ref. No. —
	spring guide for lid hinge ID ø 28mm ED ø 32mm L 225mm zinc-coated steel		
	GEV No.	514140	Ref. No. —
	lid hinge body lid radius 470mm		
	GEV No.	514144	Ref. No. —
	bracket for lid hinge		
	GEV No.	514145	Ref. No. —
	adjusting bush L 108mm ø 80/60mm		
	GEV No.	540854	Ref. No. —
	torsion spring ø 50.8mm wire gauge ø 5.1mm L1 34mm L2 104mm L3 29mm mounting pos. right		
	GEV No.	540855	Ref. No. —
	torsion spring ø 50.8mm wire gauge ø 5.1mm L1 34mm L2 104mm L3 29mm mounting pos. left		

filters

grease filters

baffle filters



1

GEV No.	106075	Ref. No.	055330
description	baffle filter W 560mm SS		

equipment feet and end caps

bolting feet



1

GEV No.	691814	Ref. No.	RG.A13003
description	equipment foot ø 22mm H 20mm bore ø 4mm Qty 1 pcs		
For models:	WAFFLE1, WAFFLE2		



1

GEV No.	693442	Ref. No.	064001
description	equipment foot ø 29mm H 15mm rubber bore ø 6mm Qty 1 pcs		

miscellaneous

with fixing plate

ø100mm



1

GEV No.	700307	Ref. No.	066031
description	swivel castor with brake ø 100mm plates fixing 75x70mm housing zinc-plated sheet steel hole distance 60x50mm H 135mm wheel width 27mm		

baskets

fryer baskets

STAR 10



1

GEV No.	970215	Ref. No.	Y47700 Y48000
description	fryer basket L1 280mm W1 200mm H1 100mm chrome-plated steel		
For models:	ABC0003, ABC0005, ACC0003, ACC0008, ACC0009, ACC0010, AEC0001, AEC0002, SKF4E, SKF6E		



1

GEV No.	970214	Ref. No.	Y47900
description	fryer basket L1 295mm W1 100mm H1 105mm		
For models:	ABC0003, ABC0005, ACC0003, ACC0008, ACC0009, ACC0010, AEC0001, AEC0002, SKF4E, SKF6E		



1

GEV No.	970449	Ref. No.	X63100
description	fryer basket L1 300mm W1 110mm H1 110mm chrome-plated steel		
For models:	ABC0004, ACC0001, ACC0002, ACC0004, ACC0006, ACC0007, SKF2E4		



1

GEV No.	970217	Ref. No.	X62000
description	fryer basket L1 300mm W1 230mm H1 105mm		
For models:	ACC0001, ACC0002, ACC0006, ACC0007		

crumb screens



1

GEV No.	970222	Ref. No.	Y47800
description	crumb screen L 303mm W 212mm suitable for fryer		
For models:	ABC0003, ABC0005, ACC0003, ACC0008, ACC0009, ACC0010, AEC0001, AEC0002, SKF4E, SKF6E		

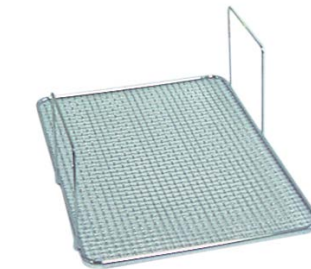

1

GEV No.	970219	Ref. No.	X62200
description	crumb screen L 337mm W 237mm fryer		
For models:	ACC0001, ACC0002, ACC0006, ACC0007		



wire baskets for hot dog machines



1

GEV No.	693468	Ref. No.	057501
description	grid basket for hot dog grill ø 180mm H 210mm		

shelves and shelf rails

grates

producer-specific



1

GEV No.	693443	Ref. No.	055809
description	chargrill grid W 400mm D 345mm SS wire gauge frame 8mm lengthwise wires gauge 3mm crossing wires 1		

shelf rails and supports

universal



1

GEV No.	690332	Ref. No.	9792
description	shelf support L 31/28mm W 22mm H 17mm SS with hook Qty 1 pcs		
For models:	COMP2GN-9805, COMP3E-9746, COMP3GN-9806, DIAM150-9770, DIAM40-9755, DIAM40BT-9748, DIAM75-2P-9798, DIAM75-9765, DIAM75BT-9815		
accessories for	690332		
	GEV No.	Ref. No.	—
	rack L 1000mm W 22mm H 4mm aperture 3x8mm hole distance 12.5mm stainless steel		

gaskets

gaskets for heated units

door seals

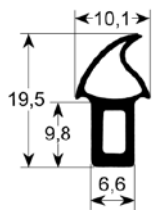

1

GEV No.	900544	Ref. No.	0000X05600
description	door seal profile 2740 L 1350mm Qty 1		
For models:	ACA1004, ACA1005, ACA1006, ACA2005, ACA2007, ACA2009, ACA2012, ADA1004, ADA1005, ADA1006, ADA2005, ADA2008, ADA2009, ADA2010, C89E, K4FFE		

door seals with fixing hook



1

GEV No.	900509	Ref. No.	068203
description	door seal		
For models:	BSC4FE80, C87VFE		

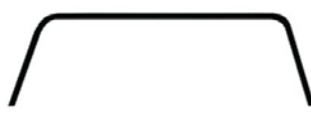

1

GEV No.	900231 ¹	Ref. No.	068201 X68201
description	door seal L 590mm W 300mm 3-sided long side open with mounting clip		
For models:	ACA2004, ACA2006, ACA2008, ACA2010, ACA2011, BSC6FG, C127FE, C127FG, C2FP, C3FP, C5FG, C5GFE, C87FE, C87FG, C87FP, C87FV		

¹3-sided, long side open

O-rings

EPDM



1

GEV No.	510899	Ref. No.	X05400
description	O-ring EPDM thickness 3.53mm ID ø 37.69mm Qty 1 pcs		
For models:	ACC0005, ACE0008, ADE0003, ADE0004, AEC0003, AEC0004, AEC0005, AEC0006, AEE0001, AEE0002		

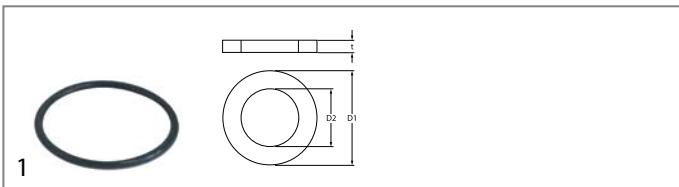

GEV No.	532545	Ref. No.	X05000
description	O-ring Viton thickness 3.53mm ID ø 49.21mm Qty 1 pcs		
For models:	ACC0005, ACE0008, ADE0003, ADE0004, AEC0003, AEC0004, AEC0005, AEC0006, AEE0001, AEE0002		

Viton

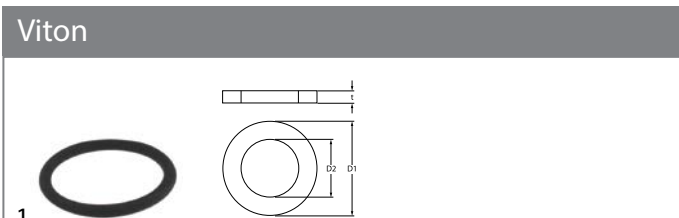

GEV No.	528155	Ref. No.	X05300
description	O-ring Viton thickness 3.53mm ID ø 32.93mm Qty 1 pcs		
For models:	ACC0005, ACE0008, ADE0003, ADE0004, AEC0003, AEC0004, AEC0005, AEC0006, AEE0001, AEE0002		

evaporation and condensing trays

unheated condensing trays



GEV No.	750182	Ref. No.	Q32-0195
description	condensing tray L 540mm W 235mm H 70mm		
For models:	HD140A, HD70A		

transmission technology and ball bearings

drive belts

round belts



GEV No.	693875	Ref. No.	009453.51
description	round belt ø 8mm L 784mm		
For models:	STP40		

springs

torsion springs

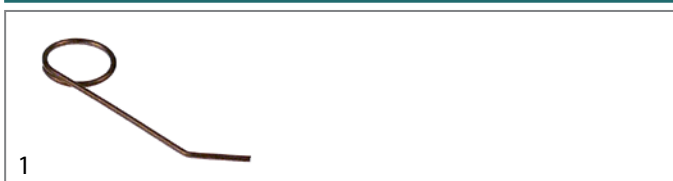

GEV No.	695168	Ref. No.	009451.53 009456.27
description	spring wire gauge ø 1.4mm L1 61mm		



GEV No.	700569	Ref. No.	002001
description	torsion spring ø 21.5mm L2 40mm wire gauge ø 3.3mm L1 100mm L3 45mm		
For models:	PANINIMC-2004		



GEV No.	690548	Ref. No.	Y71500
description	torsion spring ø 39mm wire gauge ø 7mm L1 281mm L2 31mm L3 24mm mounting pos. left		
For models:	ADK2001, ADK2002, ADK2003, ADK2004, ADK2007, ADK2008, ADK2009, ADK2010, AEK2001, AEK2002, AEK2003, AEK2004, AEK2005, AEK2006, AEK2007, AEK2008		



GEV No.	690549	Ref. No.	Y71800
description	torsion spring ø 39mm wire gauge ø 7mm L1 31mm L2 281mm L3 24mm mounting pos. left		
For models:	ADK2003, ADK2004, ADK2009, ADK2010, AEK2003, AEK2004, AEK2007, AEK2008		



kitchen accessories

spillage trays

			
1			
GEV No.	698112	Ref. No.	AM.F2047
description	meat collecting tray L 255mm W 195mm H 50mm		

			
1			
GEV No.	698071	Ref. No.	AM.F2069
description	meat collecting tray ø 160mm Lmm Wmm H 60mm		
For models:	FGM113		

			
1			
GEV No.	698073	Ref. No.	AM.F2169
description	meat collecting tray ø 220mm Lmm Wmm H 90mm		
For models:	FGS106		

valves and tank inlets

ball valves

universal

ball valves with lever handle

			
1			
GEV No.	514325	Ref. No.	M75400
description	ball valve connection 1" IT - 1" IT DN25 total length 83mm with lever handle		
For models:	ACC0005, ACE0001, ADC0003, ADC0008, ADC0009, ADC0010, ADE0001, ADE0003, ADE0004, AEC0009, AEC0010, AEC0011, AEC0012, AEE0001, AEE0002, CP49G, CP89G, F49G, F89G		

			
1			
GEV No.	540730	Ref. No.	062055
description	ball valve connection 3/4" IT - 3/4" IT DN20 total length 70mm with lever handle handle length 95mm		
For models:	BM3GNI, BM47, BM4GNI, BM67, F4710, F4715, F6710, F8715, RG100, RG105, RG70		

producer-specific

STAR 10

			
1			
GEV No.	514212	Ref. No.	0000X15300
description	ball valve total length 93mm handle length 95mm L 93mm inlet 3/4" ET lever handle grommet ø 22mm outlet ø22mm		
For models:	ACC0001, ACC0002, ACC0003, ADC0001, ADC0002, AEC0001, AEC0002, AEC0003, AEC0004, AEC0005, AEC0006, AEC0007, AEC0008		

accessories





			
1			
GEV No.	514217	Ref. No.	M75700
description	handle for outlet tap		
For models:	ACE0001, ADE0001, ADE0003, ADE0004, AEE0001, AEE0002, CP49G, CP89G		

shut-off valves

universal



1

GEV No.	514370	Ref. No.	X18000
description	shut-off valve connection 1/2" 1/2" hot total length 54mm shaft ø M5x0.8mm		
For models:	ACE0001, ACE0003, ACE0004, ACE0008, ADB0001, ADB0002, ADB0003, ADE0001, ADE0003, ADE0004, ADK2001, ADK2002, ADK2003, ADK2004, ADK2008, ADK2010, AEB0001, AEB0002, AEB0003, AEE0001, AEE0002, AEK2001, AEK2002, AEK2003, AEK2004, AEK2006, AEK2008, BM48G, BM49E, BM89E, CP49G, CP89G		
spare parts for	514370		
	GEV No.	514085	Ref. No. —
	rosette connection 26x19G chrome-plated total lengthmm mounting pos.		
	GEV No.	514086	Ref. No. —
	hexagonal nut connection 26x19G brass total lengthmm mounting pos. H 6mm WS 34 Qty 1 pcs		
	GEV No.	540414	Ref. No. —
	star handle connection hot total lengthmm mounting pos. shaft diameter 7x7mm ø 55mm 35 built-in depth 22mm		
	GEV No.	540415	Ref. No. —
	star handle connection cold total lengthmm mounting pos. shaft diameter 7x7mm ø 55mm 35 built-in depth 22mm		
	GEV No.	540672	Ref. No. —
	gasket suitable for tap head		



1

GEV No.	514208	Ref. No.	M75600
description	shut-off valve connection 1/2" 1/2" straight total length 64mm shaft ø 8x10mm		
For models:	ADK2007, ADK2009, AEK2005, AEK2007		

fastening material

fasteners

retainer clips



1

GEV No.	693457	Ref. No.	020102
description	retainer clip L 73mm wire gauge ø 3mm zinc-coated steel Qty 1 pcs		
For models:	GY100E, GY100G, GY20EIR, GY30EIR, GY40E, GY40G, GY60E, GY60E-9830, GY60G, GY70G, GY80E, GY80E-9831, GY80EIR, GY80G, GY90EIR, GY90G, GYINO10E, GY-INO10E-9841, GYINO10G, GYINO30G, GYROS-100G-9828, GYROS-10G-9842, GYROS-20G-9843, GYROS-40G-9825, GYROS-60G-9826, GYROS-80G-9827		

retaining rings

DIN 471



1

GEV No.	691621	Ref. No.	M29600
description	retaining ring shaft ø 40mm thickness 1.8mm steel DIN 471		

consumables

lava rocks / ceramic briquetts



1

GEV No.	105342	Ref. No.	M30500
description	lava rocks content 9kg		
For models:	ABH1001, ABH1002, ACH1001, ACH1002, ACH1003, ACH1004, ADH1001, ADH1002, AEH1001, AEH1002, SKPL1G, SKPL2G		

B			
ball valves	73	heating elements for fryers	4
bar burners	50	heating elements for griddles	6
bi-metal thermostats	12, 12	heating elements for gyros grills	6
C		heating elements for ovens	3
cam switches	19	heating elements for pasta cookers	7
capillary tube clips	17	heating elements for pizza ovens	8
castors and bumper angles	70	heating elements for refrigeration	7
ceramic burners	51	heating elements for salamanders/toasters	8
ceramic heaters	9	heating elements for tilting bratt pan	7
compressors	27	hob burners	43
condensing trays heated	28	hot air fans	28
consumables	74	hot plates	11
contactors	24	I	
control equipment	21	ignition boxes	35
control thermostats	12, 16	ignition cables	40
D		ignition switches	41
door seals	71	ignition units	40
door seals with fixing hook	71	immersion heating elements	9
E		indicator lights	21
electric accessories	29	indicator lights (complete)	21
electronic controllers	25	L	
energy regulators	12	lamps	21
F		lava rocks / ceramic briquetts	53, 74
fans	28	light bulbs	22
fasteners	74	linear lamps	23
fastening material	74	M	
fluorescent lamps	23, 23	mechanical timers	23
funnel trays	53	microswitches	18
G		motors	28
gas burners	43	O	
gas control valves	35	O-rings	71
gas nozzles	52	oven hinges	67
gas taps	30	oven lamps	23
gas thermostats	32	P	
gaskets for heated units	71	piezoelectric igniters	40
grates	71	pilot burners	36
H		probe clips	17
Hall sensors	25	probes	25
heating cables	9	pumps	29
heating elements	3	pumps for ice machines	29
heating elements for bain maries	3	push/momentary push switches	18
heating elements for charginills	8	Q	
heating elements for chip scuttles	4	quartz heating elements	9
heating elements for contact grills	7	R	
heating elements for convection	10	radiation heaters	10
		relays	24

residual heat indicators	23
retainer clips	74
retaining rings	74
rocker/momentary rocker switches	17

S

safety thermostats	15
safety valves	36
shelves and shelf rails	71
shut-off valves	74
solenoid valves	27
spillage trays	73
spring clips	17
switches and momentary switches	17

T

temperature probes	25
terminals	29
thermocouples	41
thermostats	12
timers	23
tube burners	51

U

universal probes	25
------------------	----

V

valves and tank inlets	73
------------------------	----