



GAS COMPONENTS



ELECTRIC COMPONENTS



WATER TECHNOLOGY



MECHANICAL COMPONENTS



TOOLS

Spare parts suitable for

TECFRIGO

Find the complete and up-to-date range of products in our GEV Webshop



Manufacturer catalogue

The most important spare parts and accessories arranged clearly for every manufacturer

- ✓ Complete product range and all appliance data always up to date in the GEV Webshop
- ✓ Alphabetical Index at the end of the catalogue

GEV Webshop

www.gev-online.co.uk

www.gev-online.com



- 🔍 Add to Favourites
- 🔍 Sign In with email address and usual password
- 🔍 Easy-order – place several items in your basket at the same time
- 🔍 Quick Item search – no login needed





heating elements

heating elements for griddles

			
GEV No.	418014	Ref. No.	3024801
description	heating element 950W 230V heating circuits 1 L 1032mm W 85mm tube ø 8.5mm bracket mounting connection male faston 6.3mm hole ø M5mm connection length 71mm dry heating element lug length 40mm lug width 18mm		

heating elements for hot counters

			
GEV No.	418015	Ref. No.	3914801
description	heating element 1600W 220V heating circuits 1 L 227mm W 313mm connection length 37mm tube ø 6.3mm connection male faston 6.3mm dry heating element bracket mounting hole distance 345mm hole ø 5mm lug length 35mm lug width 20mm		

			
GEV No.	418013	Ref. No.	3014801
description	heating element 825W 230V heating circuits 1 L 826mm W 74mm connection length 70mm tube ø 8.5mm connection male faston 6.3mm dry heating element rectangular flange hole distance 100mm flange length 40mm flange width 18mm hole ø M5mm		

heating elements for refrigeration

heating elements for condensate evaporation

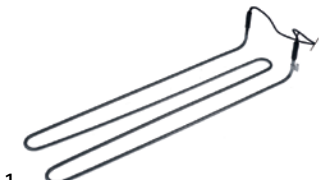
			
GEV No.	418816	Ref. No.	7764819
description	heating element 500W 230V L 500mm W 130mm H 90mm cable length 1500mm connection distance 124mm tube ø 6mm		

foil heating elements

			
GEV No.	418868	Ref. No.	2304802
description	foil heating element L 460mm W 270mm 600W 230V t.max.°C silicone cable length 2300mm thickness 1mm		

			
GEV No.	418012	Ref. No.	3154802
description	foil heating element L 560mm W 360mm 400W 230V probe ø 6mm without temperature limiter plastic cable length 490mm thickness 0.5mm		

thermostats

control and safety thermostats

PRODIGY / FIRT

control thermostats

			
GEV No.	375475	Ref. No.	A0103
description	thermostat t.max. 120°C temperature range 30-120°C 1-pole 1CO 16A probe ø 6mm probe L 105mm capillary pipe 1480mm capillary pipe isolated 100mm shaft ø 6x4.6mm shaft L 16mm shaft position lower° rotation 320°		



switches and momentary switches

rocker/momentary rocker switches

30x22mm



1

GEV No.	301251	Ref. No.	A0304
description	rocker switch mounting measurements 30x22mm green 2NO 250V 16A illuminated lighting connection male faston 6.3mm ambient temperature max. 85°C protection IP40		



1

GEV No.	346321	Ref. No.	A0303
description	rocker switch mounting measurements 30x22mm green 2NO 250V 16A illuminated lighting connection male faston 6.3mm ambient temperature max. 85°C protection IP40		

float switches



1

GEV No.	401865	Ref. No.	C7301
description	float switch thread 10mm 1NO \varnothing 28mm L 80mm mounting \varnothing 10mm 240V 0.5A cable		

lamps

linear lamps

sockets for linear lamps

R7s

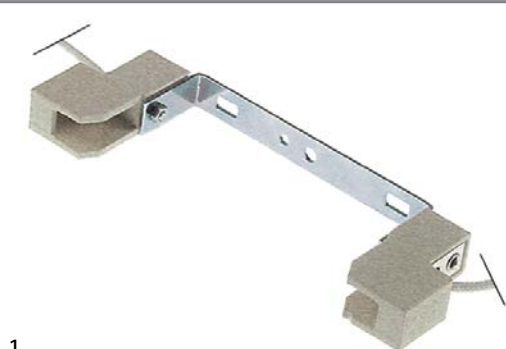

1

GEV No.	359663	Ref. No.	D9501
description	lamp socket socket R7s 250V \varnothing mm for length of lamp 117.6mm H 47mm connection cable 150mm mounting distance 65mm holder length 140.5mm Qty 1 pcs		

fluorescent lamps

fluorescent lamps

G13



1

GEV No.	359372	Ref. No.	B6303
description	fluorescent lamp socket G13 L 895mm 30W 230V Qty 1 pcs		

accessories

sockets



1

GEV No.	550845	Ref. No.	0054804
description	socket socket G13 Qty 1 pcs		



1

GEV No.	550846	Ref. No.	0054805
description	socket socket G13 Qty 1 pcs		

ballasts



1

GEV No.	401142	Ref. No.	A6802
description	electrical ballast 30W for fluorescent lamps		

covers



1

GEV No.	550844	Ref. No.	0064802
description	cover		



			
1			
GEV No.	550847	Ref. No.	0064801
description	cover		

alarm devices

alarm units

			
1			
GEV No.	350115	Ref. No.	C3601
description	alarm device 240VAC ø 40mm Hmm 1 hole fixing mounting thread M12 82dB protection IP54		

contactors

KEDU

power contactors

			
1			
GEV No.	380873	Ref. No.	C3402
description	contactor resistive load 16A 230VAC (AC3/400V) 6.1A/2.2kW main contacts 2NO/2NC auxiliary contacts connection screw connection type JD6.01		

probes

universal probes

temperature probes

			
1			
GEV No.	379064	Ref. No.	D7602
description	temperature probe PTC 1kOhm cable silicone probe -50 up to +150°C cable -50 up to +180°C probe ø6x40mm cable length 3m without screw connection 2-wire		

compressors

ACC/ZEL

R134A

HMBP monophase

High/Medium evaporation temperature above -20/-15 °C

			
1			
GEV No.	605010	Ref. No.	B5228
description	compressor coolant R134a type GP12TB 220-240V 50Hz HMBP fully hermetic 11.2kg 3/8HP power input 661W cylinder capacity 12cm ³ CSIR H 203.6mmW 143W 194W 259W 339W 432W 539W 661W 796W test method ASHRAE ambient temperature max. 43°C		

fans

axial fans

ebm-papst

				
1				
GEV No.	601089 ¹	Ref. No.	C5301	
description	axial fan L 119mm W 119mm H 38mm 230VAC 50/60Hz 19W bearing slide bearing manuf. no. 4650N metal connection male faston 2.8mm ebm-papst fan wheel ø 110mm temp.-resist. 55°C			
accessories for	601089			
	GEV No.	550898	Ref. No.	—
	connecting cable cable length 2000mm connection F 2.8 connection distance 7.9mm for axial flow fan			
	GEV No.	691104	Ref. No.	—
	guard ø 115mm mounting distance 105mm for axial fan 119mm			

¹with slide bearings



cross flow fans

COPREL

with moulded coils



1

GEV No.	601398	Ref. No.	B5102
description	cross flow fan COPREL TFL roller \varnothing 60mm roller length 180mm laminated core thickness 20mm motor position left 230V/50Hz 25W refrigeration bearing rubber connection cable 2400mm coil type impregnated -10 up to +60°C		

double fans



1

GEV No.	601645	Ref. No.	B5105
description	cross flow fan COPREL FFD roller \varnothing 60mm roller length 2x180mm laminated core thickness 43mm motor position centre 230V/50-60Hz 43W refrigeration bearing rubber connection F6.3 coil type moulded airflow 280m ³ /h -10 up to +50°C		



1

GEV No.	602108	Ref. No.	N/A
description	cross flow fan COPREL TFD roller \varnothing 60mm roller length 2x180mm laminated core thickness 30mm motor position centre 230V/50-60Hz 45W universal bearing silicone connection cable 1600mm airflow 280m ³ /h -10 up to +50°C		

hot air fans

miscellaneous



1

GEV No.	601147	Ref. No.	D0702
description	hot air fan 220-240V 32W L1 65mm L2 10mm L3 20mm L4 87mm fan wheel \varnothing 150mm FIME type C20X0E173CLH		

motors

gear motors

miscellaneous



1

GEV No.	499120	Ref. No.	B8301 X70001 X70006
description	gear motor MINGARDI type M02 130W 230V voltage AC 50Hz L 267mm W 85mm H 50mm for hood with holder		



1

GEV No.	500913	Ref. No.	00807/1 X07003
description	gear motor type B4509UI-025 230V 50Hz 1.4rpm L 83mm W 75mm H 92mm for display refrigerator		



equipment-specific units

for fridges

housing and bezels

miscellaneous



1

GEV No.	700909	Ref. No.	3590304
description	ventilation grille H 200mm L 558mm		

for display coolers

housing and bezels

lids



1

GEV No.	696362	Ref. No.	2570220
description	lid for vitrine W 430mm D 380mm H 50mm		

glass panels

glass panels



1

GEV No.	700910	Ref. No.	0270901
description	glass panel L 560mm W 555mm H 6mm thickness 6mm rectangular		

miscellaneous

with fixing plate

ø60mm



1

GEV No.	700893	Ref. No.	C2407
description	swivel castor with swivel brake ø 60mm plates fixing 60x60mm housing gold-coloured hole distance 47mm H 92mm wheel width 22mm		



1

GEV No.	700894	Ref. No.	A0814
description	swivel castor without brake ø 63mm plates fixing 60x60mm housing gold-coloured hole distance 47mm H 92mm wheel width 22mm		

shelves and shelf rails

grates

universal

without upstand



1

GEV No.	970650	Ref. No.	7750802
description	grate W 650mm D 530mm GN 2/1 chrome-plated steel wire gauge frame 8mm lengthwise wires gauge 3mm crossing wires 2		

shelf rails and supports

producer-specific



1

GEV No.	697950	Ref. No.	4100803
description	shelf support L 32mm W 15mm H 25mm plastic suitable for PRIS-MA400TNV-PF		

gaskets

refrigeration gaskets

plug-in gaskets

profile 9050

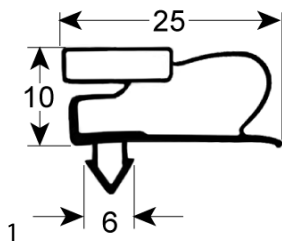

GEV No.	902051	Ref. No.	8660401
description	refrigeration gasket profile 9050 W 700mm L 1505mm plug size		

profile 9151

We offer custom-made gaskets for this profile

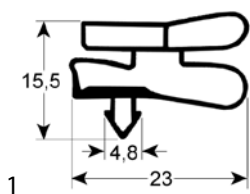

GEV No.	901458	Ref. No.	8690415
description	refrigeration gasket profile 9151 W 535mm L 1690mm plug size		

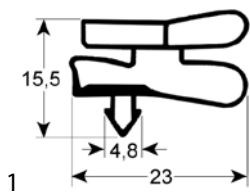

GEV No.	901080	Ref. No.	8690406
description	refrigeration gasket profile 9151 W 558mm L 1713mm plug size L1 1703mm W1 548mm external size		

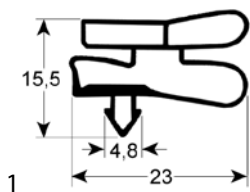

GEV No.	901322	Ref. No.	8660402
description	refrigeration gasket profile 9151 W 717mm L 1515mm plug size L1 1505mm W1 707mm external size		

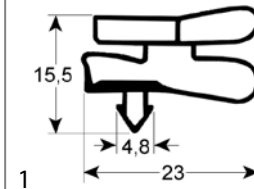

GEV No.	901085	Ref. No.	8660403
description	refrigeration gasket profile 9151 W 730mm L 1550mm plug size L1 1540mm W1 720mm external size		

profile 9154

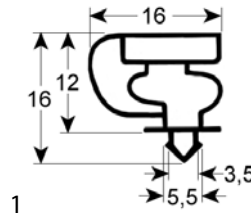

GEV No.	901397	Ref. No.	0200401
description	refrigeration gasket profile 9154 W 368mm L 1105mm		

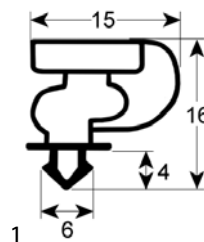

GEV No.	901133	Ref. No.	0040401
description	refrigeration gasket profile 9154 W 379mm L 586mm plug size		

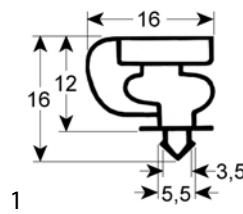

GEV No.	901134	Ref. No.	4110404
description	refrigeration gasket profile 9154 W 531mm L 1221mm plug size		

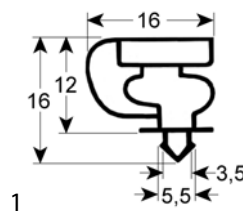

GEV No.	901135	Ref. No.	0090401
description	refrigeration gasket profile 9154 W 648mm L 690mm plug size		

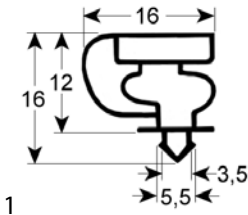
GEV No.	902267	Ref. No.	N/A
description	refrigeration gasket profile 9154 Wmm L 2500mm		

springs

tension springs



GEV No.	700425	Ref. No.	A2502
description	tension spring ø 12mm total length 244mm wire gauge ø 1.9mm		

condensers

condensers



GEV No.	750285	Ref. No.	B7401
description	condenser W 285mm D 165mm H 250mm		

A

alarm devices	5
axial fans	5

B

ballasts	4
----------	---

C

castors and bumper angles	7
compressors	5
contactors	5
cross flow fans	6

F

fans	5
float switches	4
fluorescent lamps	4,4
foil heating elements	3

G

grates	7
--------	---

H

heating elements	3
heating elements for condensate evaporation	3
heating elements for griddles	3
heating elements for refrigeration	3
hot air fans	6

L

lamps	4
linear lamps	4

M

motors	6
--------	---

P

plug-in gaskets	8
probes	5

R

refrigeration gaskets	8
rocker/momentary rocker switches	4

S

shelves and shelf rails	7
switches and momentary switches	4

T

temperature probes	5
thermostats	3

U

universal probes	5
------------------	---