



**GAS COMPONENTS**



**ELECTRIC COMPONENTS**



**WATER TECHNOLOGY**



**MECHANICAL COMPONENTS**



**TOOLS**

Spare parts suitable for

**TECHNOBLOCK**

Find the complete and up-to-date range of products in our GEV Webshop



# Manufacturer catalogue

The most important spare parts and accessories arranged clearly for every manufacturer

- ✓ Complete product range and all appliance data always up to date in the GEV Webshop
- ✓ Alphabetical Index at the end of the catalogue

## GEV Webshop

[www.gev-online.co.uk](http://www.gev-online.co.uk)

[www.gev-online.com](http://www.gev-online.com)



- 🔍 Add to Favourites
- 🔍 Sign In with email address and usual password
- 🔍 Easy-order – place several items in your basket at the same time
- 🔍 Quick Item search – no login needed



## heating elements

### heating elements for refrigeration

#### heating elements for defrosting



<b>GEV No.</b>	420296	<b>Ref. No.</b>	3RST188 4RSBI003
<b>description</b>	heating element 1300W 230V L 1200mm W 60mm H 115mm cable length 2000mm tube ø 8.5mm immersion heater defrosting		

## switches and momentary switches

### push/momentary push switches

#### 19x13mm



<b>GEV No.</b>	347692	<b>Ref. No.</b>	3INT277 4INTS008
<b>description</b>	push switch mounting measurements 19x13mm green 1NO/indicator light 250V 15A lamp connection male faston 4.8mm ambient temperature max. 105/55°C protection IP65 with cover cap		



<b>GEV No.</b>	347691 <sup>1</sup>	<b>Ref. No.</b>	3INT283 4INTS007
<b>description</b>	push switch mounting measurements 19x13mm green 2NO 250V 15A illuminated refrigeration connection male faston 4.8mm ambient temperature max. 105/55°C protection IP65 with cover cap		
<b>spare parts for</b>	347691		
	<b>GEV No.</b>	301064	<b>Ref. No.</b> —
	protective cover for pressure switch external size 23.4x17.4mm internal size 19x13mm H 7.5mm clear mounting measurementsmm		

<sup>1</sup>illuminated

## contactors

### ABB

#### power contactors



<b>GEV No.</b>	381504	<b>Ref. No.</b>	3TLR271
<b>description</b>	power contactor resistive load 25A 230VAC (AC3/400V) 5.5kW main contacts 2NO connection screw type A11-30-10		

## relays

### power relays

#### with male contacts

#### female contact 6.3mm

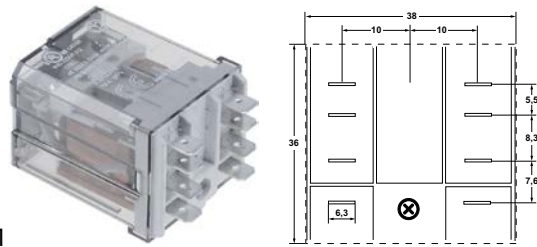

<b>GEV No.</b>	380955	<b>Ref. No.</b>	3RLM076 4RELFO03
<b>description</b>	relay FINDER 230VAC 16A 2CO connection F6.3 manuf. no. 62.82.8.230.0009 250V 2-pole connection male faston 6.3mmmm		

## transformers

### encapsulated transformers

#### PMA



<b>GEV No.</b>	379054	<b>Ref. No.</b>	3TRF150 4TRFS022
<b>description</b>	transformer primary 230VAC secondary 12VAC 3VA secondary 0.25A H 40mm L 45mm W 50mm connection screw 50/60Hz type 153/M		



## electronic controllers













## DIXELL

## refrigeration controllers

## built-in version



1

<b>GEV No.</b>	402144	<b>Ref. No.</b>	3CTL183
<b>description</b>	electronic controller DIXELL XR60CX -5N0C1 mounting measurements 71x29mm 230V voltage AC NTC/PTC relay outputs 3 NO-20A(8) CO-8A(3) NO-5A(2) NTC/PTC NTC/PTC DI -50 up to +150°C display 3½ digits		
<b>accessories for</b>	402144		
	<b>GEV No.</b>	378194	<b>Ref. No.</b> —
	temperature probe NTC 10kOhm cable PVC probe -20 up to +80°C cable -10 up to 100°C probe ø7x24.5mm cable length 1.5m without screw connection 2-wire		
	<b>GEV No.</b>	378551	<b>Ref. No.</b> —
	adapter for reducer mounting measurements 71x29mm		
	<b>GEV No.</b>	379052	<b>Ref. No.</b> —
	temperature probe PTC 1kOhm cable silicone probe -50 up to +150°C cable -50 up to +180°C probe ø6x40mm cable length 1.5m without screw connection 2-wire		
	<b>GEV No.</b>	379053	<b>Ref. No.</b> —
	temperature probe PTC 1kOhm cable PVC probe -50 up to +150°C cable -10 up to 100°C probe ø6x30mm cable length 3m without screw connection 2-wire		
	<b>GEV No.</b>	379057	<b>Ref. No.</b> —
	temperature probe NTC 10kOhm cable PVC probe -20 up to +80°C cable -10 up to 100°C probe ø6x25mm cable length 3m 2-wire		
	<b>GEV No.</b>	379064	<b>Ref. No.</b> —
	temperature probe PTC 1kOhm cable silicone probe -50 up to +150°C cable -50 up to +180°C probe ø6x40mm cable length 3m without screw connection 2-wire		
	<b>GEV No.</b>	379160	<b>Ref. No.</b> 3SNS131 4SND5111
	temperature probe NTC 10kOhm cable thermoplastic probe -40 up to +110°C cable -40 up to +110°C probe ø6x14mm cable length 1.5m without screw connection 2-wire		
	<b>GEV No.</b>	379161	<b>Ref. No.</b> —
	temperature probe NTC 10kOhm cable thermoplastic probe -40 up to +110°C cable -40 up to +110°C probe ø6x14mm cable length 3m without screw connection 2-wire		
	<b>GEV No.</b>	379343	<b>Ref. No.</b> —
	temperature probe NTC 10kOhm cable silicone probe -40 up to +110°C cable -50 up to +180°C probe ø6x40mm cable length 3m 2-wire		
	<b>GEV No.</b>	379458	<b>Ref. No.</b> —
	temperature probe NTC 10kOhm cable silicone probe -40 up to +110°C cable -50 up to +180°C probe ø6x40mm cable length 1.5m without screw connection 2-wire		
	<b>GEV No.</b>	379782	<b>Ref. No.</b> —
	temperature probe PTC 1kOhm cable thermoplastic probe -50 up to +150°C cable -40 up to +110°C probe ø6x14mm cable length 3m 2-wire resistor 1kOhm		
	<b>GEV No.</b>	402818	<b>Ref. No.</b> —
	programming key 4K for electronic controller DIXELL		

## SHANGFANG

## accessories



1

<b>GEV No.</b>	379054	<b>Ref. No.</b>	3TRF150 4TRFS022
<b>description</b>	transformer primary 230VAC secondary 12VAC 3VA secondary 0.25A H 40mm L 45mm W 50mm connection screw 50/60Hz type 153/M		

## probes

## universal probes

## temperature probes

1



<b>GEV No.</b>	379160	<b>Ref. No.</b>	3SNS131 4SND5111
<b>description</b>	temperature probe NTC 10kOhm cable thermoplastic probe -40 up to +110°C cable -40 up to +110°C probe ø6x14mm cable length 1.5m without screw connection 2-wire		

## electronics

## PCBs



1

<b>GEV No.</b>	402940	<b>Ref. No.</b>	3SCH173 4SCH5090
<b>description</b>	main PCB CSK 120 L 124mm W 100mm type MIR90		



## compressors

### SECOP DANFOSS

R404a/R507

HMBP monophase

High/Medium evaporation temperature above -20/-15 °C



1

<b>GEV No.</b>	605113	<b>Ref. No.</b>	3CMP2154
<b>description</b>	compressor coolant R404a/R507 type SC18MLX.3 220-240V 50Hz HMBP 14kg 1HP cylinder capacity 17.68cm <sup>3</sup> CSR H 219mmWW 947W 1178W 1454W 1780W 2162W 2606WW test method ASHRAE (50Hz)		

## fans

### refrigeration fans

refrigeration motors universal

miscellaneous



1

<b>GEV No.</b>	602186	<b>Ref. No.</b>	3MVN027 4MTNM051 4MTNM151
<b>description</b>	fan motor 83-18W 230V 50/60Hz cable length 1050mm 1350/1500rpm MA-VIB		

## cold air circulating fans (complete)

ebm-papst

A4E series

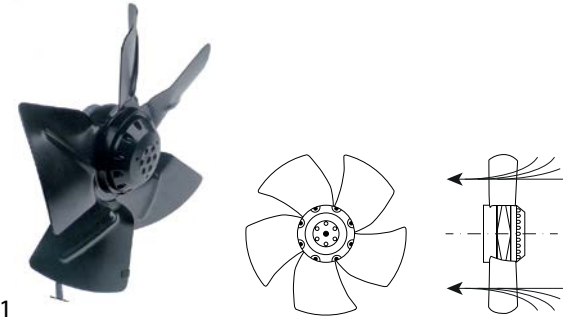

1

<b>GEV No.</b>	601623	<b>Ref. No.</b>	3MOT049 4MTVZ004
<b>description</b>	fan A4E315-AC08-19 fan wheel ø 315mm blades 5 230V 50Hz 95W 1370rpm cable length 450mm ebm-papst sucking suitable capacitor 3µF		
<b>accessories for</b>	601623		
	<b>GEV No.</b>	<b>Ref. No.</b>	—
	capacitor capacity 3µF 450V tolerance 5% 50/60Hz ambient temperature max. -25 to +85°C ø 25mm L 56mm M8 plastic connection cable 250mm 416.17.77GF protection		

## evaporators

### for fridges

producer-specific



1

<b>GEV No.</b>	750213	<b>Ref. No.</b>	3EVP416 4EVPX101
<b>description</b>	evaporator		

→ electric components



**C**

cold air circulating fans (complete)	5
compressors	5
contactors	3

**E**

electronic controllers	4
evaporators	5

**F**

fans	5
------	---

**H**

heating elements	3
heating elements for defrosting	3
heating elements for refrigeration	3

**P**

probes	4
push/momentary push switches	3

**R**

refrigeration fans	5
refrigeration motors universal	5
relays	3

**S**

switches and momentary switches	3
---------------------------------	---

**T**

temperature probes	4
transformers	3

**U**

universal probes	4
------------------	---