



**GAS COMPONENTS**



**ELECTRIC COMPONENTS**



**WATER TECHNOLOGY**



**MECHANICAL COMPONENTS**



**TOOLS**

Spare parts suitable for

**TECNODOM**

Find the complete and up-to-date range of products in our GEV Webshop



# Manufacturer catalogue

The most important spare parts and accessories arranged clearly for every manufacturer

- ✓ Complete product range and all appliance data always up to date in the GEV Webshop
- ✓ Alphabetical Index at the end of the catalogue

## GEV Webshop

[www.gev-online.co.uk](http://www.gev-online.co.uk)

[www.gev-online.com](http://www.gev-online.com)



- 🔍 Add to Favourites
- 🔍 Sign In with email address and usual password
- 🔍 Easy-order – place several items in your basket at the same time
- 🔍 Quick Item search – no login needed



## heating elements

### heating elements for refrigeration

#### heating elements for defrosting



<b>GEV No.</b>	420481	<b>Ref. No.</b>	AF52RESEV0607 RCSE700BTMN
<b>description</b>	heating element 360W 230V L 260mm W 75mm H 42mm connection female faston 6.3mm cable length 900mm tube ø 8.5mm		

#### heating elements for condensate evaporation



<b>GEV No.</b>	420480	<b>Ref. No.</b>	AF17RESVASC RCVEC92510W
<b>description</b>	heating element 150W 230V L 420mm W 70mm cable length 250mm connection distance 70mm connection male faston 6.3mm tube ø 8.5mm		

### heating cables

#### connection on both sides

#### with wire end ferrules



<b>GEV No.</b>	420479	<b>Ref. No.</b>	AF10RESPO RFPAC5700
<b>description</b>	heating cable 52W 230V L 5700mm L1 (unheated) 2x730mm L2 (heated) 4240mm silicone ø 2.7mm		

## thermostats

### control and safety thermostats

#### CAEM

#### control thermostats

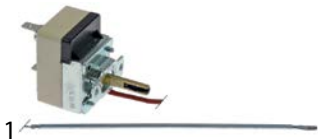

<b>GEV No.</b>	390790	<b>Ref. No.</b>	HETFR50-280
<b>description</b>	thermostat t.max. 300°C temperature range 50-280°C 1-pole 1NO 16A probe ø 3mm probe L 160mm capillary pipe 1450mm capillary pipe isolated 650mm gland nut shaft ø 6x4.6mm shaft L 22mm rotation 270° 250V		

## probes

### universal probes

#### temperature probes



<b>GEV No.</b>	379053	<b>Ref. No.</b>	ATserie
<b>description</b>	temperature probe PTC 1kOhm cable PVC probe -50 up to +150°C cable -10 up to 100°C probe ø6x30mm cable length 3m without screw connection 2-wire		

#### core probes



<b>GEV No.</b>	379549	<b>Ref. No.</b>	SONCU
<b>description</b>	core temperature probe PTC 1kOhm cable PVC probe -50 up to +150°C cable -10 up to 100°C probe ø6x110mm cable length 3.5m handle ø 8mm handle length 120x35mm 2-wire L1 120mm L2 130mm		



producer-specific probes

core probes

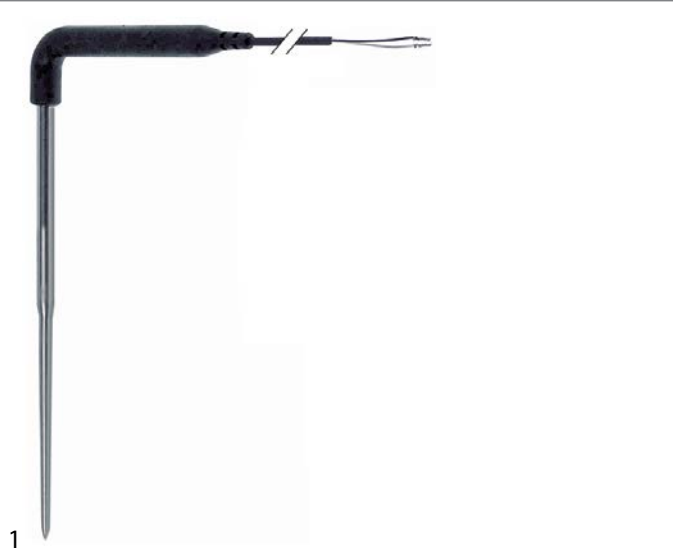

<b>GEV No.</b>	379549	<b>Ref. No.</b>	SONCU
<b>description</b>	core temperature probe PTC 1kOhm cable PVC probe -50 up to +150°C cable -10 up to 100°C probe ø6x110mm cable length 3.5m handle ø8mm handle length 120x35mm 2-wire L1 120mm L2 130mm		

compressors

ACC/ZEL

R404a/R507

HMBP monophase

High/Medium evaporation temperature above -20/-15 °C



<b>GEV No.</b>	605068	<b>Ref. No.</b>	AF82ML45TB AF82ML45TG
<b>description</b>	compressor coolant R404a/R507 type ML45TB 220-240V 50Hz HMBP fully hermetic 10kg 1/5HP cylinder capacity 4.5cm³ CSIR H 175.5mmW 192W 246W 309W 382W 465W 557W 659W 771W test method ASHRAE		

electronics

PCBs



<b>GEV No.</b>	403887	<b>Ref. No.</b>	ETPVCABT2 SCDAB3/5T
<b>description</b>	electronic controller kit for deep freezer L 105mm W 95mm		



<b>GEV No.</b>	605014	<b>Ref. No.</b>	AF82ML80TB
<b>description</b>	compressor coolant R404a/R507 type ML80TB 220-240V 50Hz HMBP fully hermetic 11.4kg 3/8HP cylinder capacity 7.57cm³ CSIR H 175.5mmW 261W 346W 446W 561W 691W 835W 993W 1167W test method ASHRAE ambient temperature max. 43°C		





fans

axial fans

import



1

<b>GEV No.</b>	601080 <sup>1</sup>	<b>Ref. No.</b>	VENTILATORECOMP
<b>description</b>	axial fan L 119mm W 119mm H 38mm 230VAC 50/60Hz 23/20W bearing ball bearing connection male faston 2.8mm metal ADDA fan wheel ø 110mm temp.-resist. 70°C		
<b>accessories for</b>	601080		
	<b>GEV No.</b>	550898	<b>Ref. No.</b> —
	connecting cable cable length 2000mm connection F 2.8 connection distance 7.9mm for axial flow fan		
	<b>GEV No.</b>	692519	<b>Ref. No.</b> —
	guard L 120mm W 120mm plastic		

<sup>1</sup>with ball bearings

refrigeration fans

refrigeration motors universal

accessories

fan wheels

aluminium

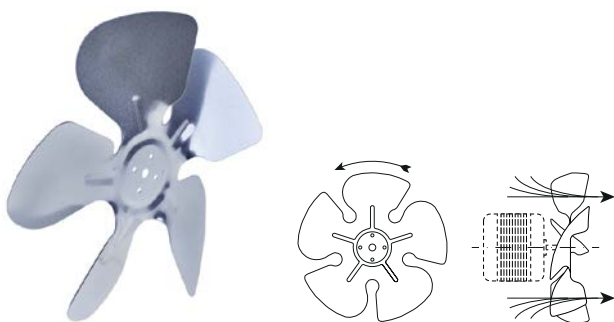

1

<b>GEV No.</b>	601571	<b>Ref. No.</b>	AF83VENCOND
<b>description</b>	fan wheel blowing ø 230mm fan wheel mounting 25.4mm blade angle 28° W 43mm aluminium		

cold air circulating fans (complete)

ebm-papst

A4E series

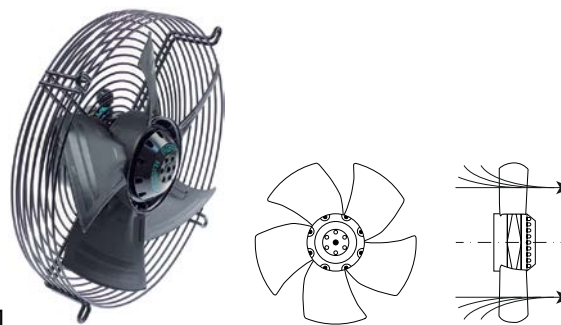

1

<b>GEV No.</b>	602049	<b>Ref. No.</b>	VENTBAST
<b>description</b>	fan A4E300-A572-06 fan wheel ø 300mm blades 5 230V 50/60Hz 72/90W ø 340mm mounting distance 265mm 1320/1500rpm cable lengthmm ebm-papst		

cross flow fans

COPREL

with moulded coils



1

<b>GEV No.</b>	602104	<b>Ref. No.</b>	N/A
<b>description</b>	cross flow fan COPREL FFL roller ø 60mm roller length 240mm laminated core thickness 20mm motor position left 230V/50-60Hz 26W universal bearing silicone connection cable 500mm airflow 149m <sup>3</sup> /h -10 up to +50°C		

## hinges

### spring assisted hinges

universal

INTERKLIMAT

hinges



1

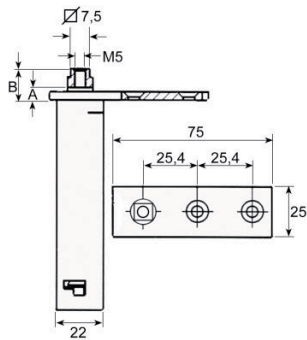

<b>GEV No.</b>	690622	<b>Ref. No.</b>	AF07CERN AF07CERN 10 AFCERN1400
<b>description</b>	spring assisted hinge series 28L mounting pos. left/right L 75mm W 25mm H 103mm A 13mm B 18mm mounting measurements 22x22mm intake 7.5x7.5 refrigeration units		

## accessories

### miscellaneous



1

<b>GEV No.</b>	701619	<b>Ref. No.</b>	TZXXA056SX
<b>description</b>	bracket for hinge L 120mm		

## shelves and shelf rails

### grates

universal

without upstand



1

<b>GEV No.</b>	970896	<b>Ref. No.</b>	GRPL600
<b>description</b>	grate W 530mm D 550mm H 10mm plastic-coated steel wire gauge frame 8mm lengthwise wires gauge 3mm crossing wires 2 grey		

### shelf rails and supports

#### producer-specific



1

<b>GEV No.</b>	701483	<b>Ref. No.</b>	GL700
<b>description</b>	pair of setting bar L-shape L 650mm W 24mm H 28mm mounting pos. left/right		



1

<b>GEV No.</b>	692619	<b>Ref. No.</b>	GC700
<b>description</b>	pair of setting bar U-shape L 650mm W 14mm H 28mm mounting pos. left/right		



**gaskets**

**refrigeration gaskets**

**plug-in gaskets**

**profile 9048**

We offer custom-made gaskets for this profile

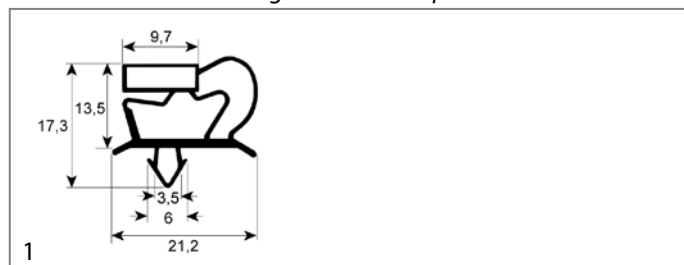

<b>GEV No.</b>	900944	<b>Ref. No.</b>	GC3CTGN
<b>description</b>	refrigeration gasket profile 9048 W 387mm L 177mm plug size		

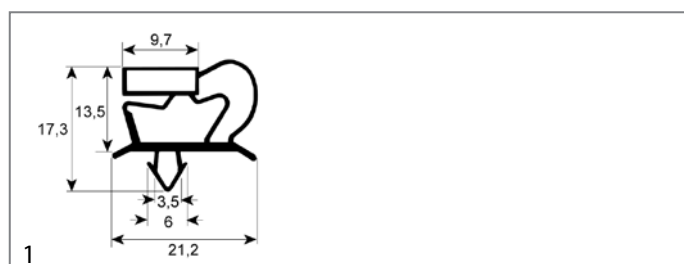

<b>GEV No.</b>	900945	<b>Ref. No.</b>	GC2CTGN
<b>description</b>	refrigeration gasket profile 9048 W 387mm L 292mm plug size		

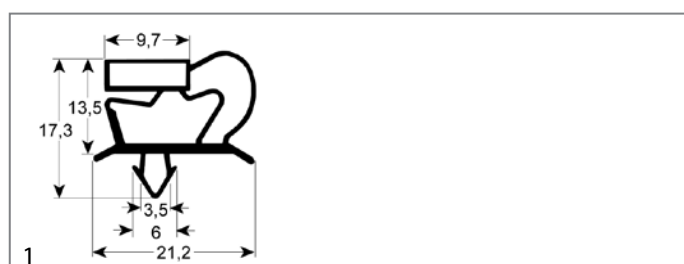

<b>GEV No.</b>	902063	<b>Ref. No.</b>	GPTGN
<b>description</b>	refrigeration gasket profile 9048 W 387mm L 633mm plug size		

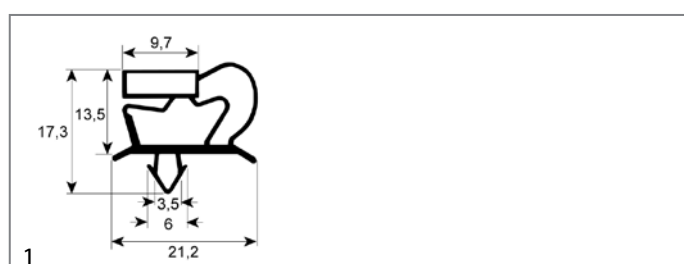

<b>GEV No.</b>	900947	<b>Ref. No.</b>	GTPA
<b>description</b>	refrigeration gasket profile 9048 W 455mm L 635mm plug size		

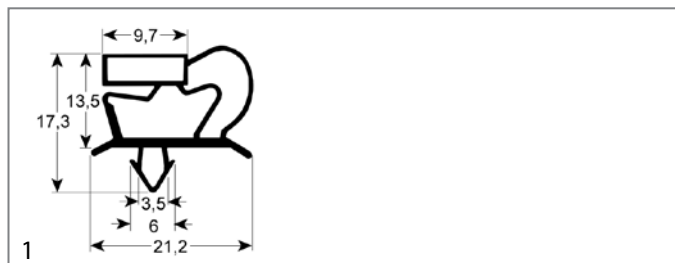

<b>GEV No.</b>	902110	<b>Ref. No.</b>	GPA400
<b>description</b>	refrigeration gasket profile 9048 W 540mm L 1390mm plug size		

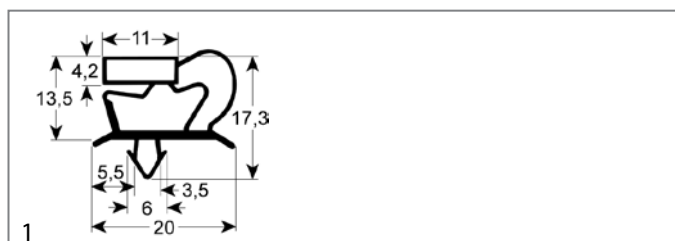

<b>GEV No.</b>	902467	<b>Ref. No.</b>	GSA
<b>description</b>	refrigeration gasket profile 9048 W 621mm L 742mm plug size		

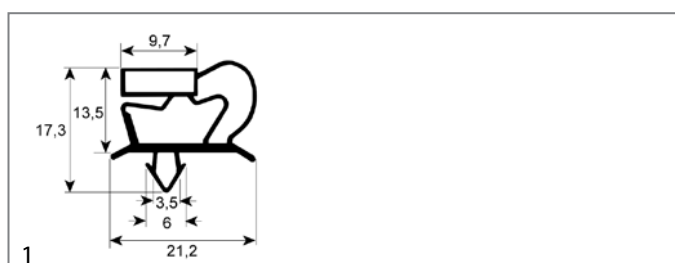

<b>GEV No.</b>	900949	<b>Ref. No.</b>	AF07-013 AF09GUAPO AF14EKOMBT GPA GPA Pos. 13
<b>description</b>	refrigeration gasket profile 9048 W 627mm L 1545mm plug size		

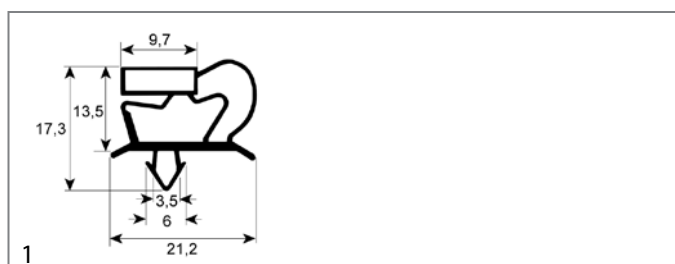

<b>GEV No.</b>	900948	<b>Ref. No.</b>	AF08GUASP AF09GUASP
<b>description</b>	refrigeration gasket profile 9048 W 637mm L 742mm plug size		

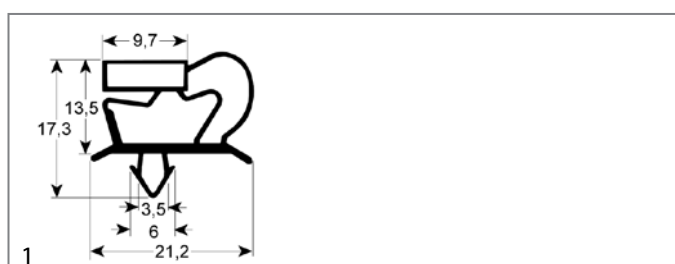

<b>GEV No.</b>	902258	<b>Ref. No.</b>	N/A
<b>description</b>	refrigeration gasket profile 9048 Wmm L 2500mm		

mechanical components, equipment accessories

## gaskets for heated units

## door seals

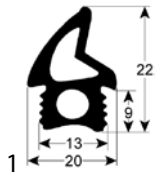

<b>GEV No.</b>	902483	<b>Ref. No.</b>	FO4NEA0039
<b>description</b>	door seal profile 2763 L 1800mm suitable for TECNODOM		



**A**

axial fans 5

**C**

cold air circulating fans (complete) 5

compressors 4

core probes 3

cross flow fans 5

**D**

door seals 8

**F**

fans 5

**G**

gaskets for heated units 8

grates 6

**H**

heating cables 3

heating elements 3

heating elements for condensate evaporation 3

heating elements for defrosting 3

heating elements for refrigeration 3

**P**

plug-in gaskets 7

probes 3

**R**

refrigeration fans 5

refrigeration gaskets 7

refrigeration motors universal 5

**S**

shelves and shelf rails 6

spring assisted hinges 6

**T**

temperature probes 3

thermostats 3

**U**

universal probes 3