



**GAS COMPONENTS**



**ELECTRIC COMPONENTS**



**WATER TECHNOLOGY**



**MECHANICAL COMPONENTS**



**TOOLS**

Spare parts suitable for

**TECNOINOX**

Find the complete and up-to-date range of products in our GEV Webshop



# Manufacturer catalogue

The most important spare parts and accessories arranged clearly for every manufacturer

- ✓ Complete product range and all appliance data always up to date in the GEV Webshop
- ✓ Alphabetical Index at the end of the catalogue

## GEV Webshop

[www.gev-online.co.uk](http://www.gev-online.co.uk)

[www.gev-online.com](http://www.gev-online.com)



- 🔍 Add to Favourites
- 🔍 Sign In with email address and usual password
- 🔍 Easy-order – place several items in your basket at the same time
- 🔍 Quick Item search – no login needed



## heating elements



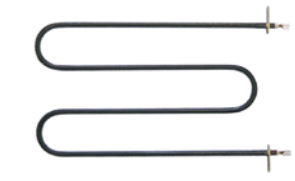

### heating elements for ovens

			
<b>GEV No.</b>	416601	<b>Ref. No.</b>	00775 RC00775000
<b>description</b>	heating element 1000W 230V L 396mm W 65mm H 35mm 2 hole fixing mounting distance 87mm connection M4 tube ø 6.5mm immersion heater thread 1/4" heating circuits 1 connection length 26mm		

### heating elements for bain maries





			
<b>GEV No.</b>	415293	<b>Ref. No.</b>	00269 RC00269000
<b>description</b>	heating element 1300W 230V heating circuits 1 L 330mm W 184mm tube ø 8.5mm lug length 40mm lug width 18mm connection male faston 6.3mm hole ø 5mm dry heating element bracket mounting		

### heating elements for frying pans

			
<b>GEV No.</b>	415292	<b>Ref. No.</b>	00528 RC00528000
<b>description</b>	heating element 1100W 230V L 205mm W 110mm connection M4 tube ø 6.3mm 2 hole fixing thread 1/4" dry heating element H 54mm mounting distance 220mm		
<b>accessories for</b>	415292		
	<b>GEV No.</b>	361182	<b>Ref. No.</b> —
	nut thread 1/4" H 5mm nickel-plated brass WS 17 Qty 1 pcs		
	<b>GEV No.</b>	510417	<b>Ref. No.</b> —
	flat gasket fibre ED ø 20mm ID ø 14mm thickness 2mm Qty 1 pcs		
	<b>GEV No.</b>	520228	<b>Ref. No.</b> —
	tooth lock washer ID ø 15.3mm ED ø 24mm steel Qty 1 pcs for thread M14		
	<b>GEV No.</b>	550262	<b>Ref. No.</b> —
	flat gasket copper ED ø 20mm ID ø 14mm thickness 2mm		

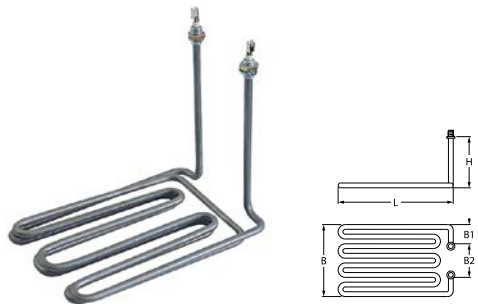
### heating elements for fryers

#### 2 hole fixing

			
<b>GEV No.</b>	416659	<b>Ref. No.</b>	00772 RC00772000
<b>description</b>	heating element 3000W 230V heating circuits 1 L 250mm W 175mm H 197mm 2 hole fixing connection male faston 6.3mm W1 35mm W2 95mm H1 175mm H2 20mm immersion heater thread 1/4" tube ø 8.9mm mounting distance 86mm connection length 21mm windings 3		
<b>accessories for</b>	416659		
	<b>GEV No.</b>	361182	<b>Ref. No.</b> —
	nut thread 1/4" H 5mm nickel-plated brass WS 17 Qty 1 pcs		
	<b>GEV No.</b>	510417	<b>Ref. No.</b> —
	flat gasket fibre ED ø 20mm ID ø 14mm thickness 2mm Qty 1 pcs		
	<b>GEV No.</b>	520228	<b>Ref. No.</b> —
	tooth lock washer ID ø 15.3mm ED ø 24mm steel Qty 1 pcs for thread M14		
	<b>GEV No.</b>	550262	<b>Ref. No.</b> —
	flat gasket copper ED ø 20mm ID ø 14mm thickness 2mm		







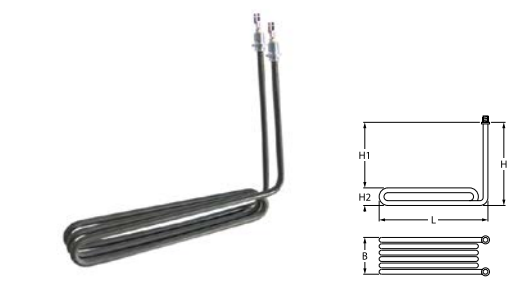

			
<b>GEV No.</b>	415291	<b>Ref. No.</b>	00282 RC00282000
<b>description</b>	heating element 2000W 230V heating circuits 1 L 250mm W 45mm H 190mm H1 154mm H2 36mm thread 1/4" tube ø 8.5mm mounting distance 30mm windings 3 2 hole fixing connection male faston 6.3mm immersion heater		
<b>spare parts for</b>	415291		
	<b>GEV No.</b>	510417	<b>Ref. No.</b> —
	flat gasket fibre ED ø 20mm ID ø 14mm thickness 2mm Qty 1 pcs		
<b>accessories for</b>	415291		
	<b>GEV No.</b>	361182	<b>Ref. No.</b> —
	nut thread 1/4" H 5mm nickel-plated brass WS 17 Qty 1 pcs		
	<b>GEV No.</b>	520228	<b>Ref. No.</b> —
	tooth lock washer ID ø 15.3mm ED ø 24mm steel Qty 1 pcs for thread M14		

Table continues overleaf



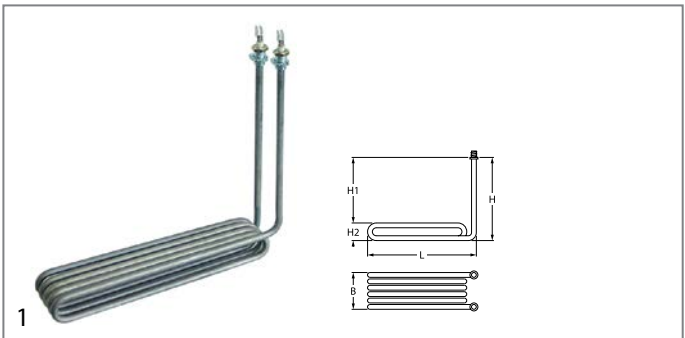



<b>accessories for</b>	415291		
	GEV No.	550262	Ref. No.
			—
	flat gasket copper ED ø 20mm ID ø 14mm thickness 2mm		

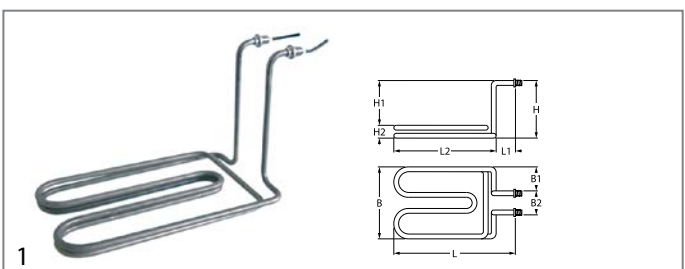

<b>GEV No.</b>	416660	<b>Ref. No.</b>	01276 RC01276000
<b>description</b>	heating element 3600W 230V heating circuits 1 L 280mm W 68mm H 246mm H1 210mm H2 36mm thread 1/4" tube ø 8.5mm windings 5 2 hole fixing connection male faston 6.3mm		
<b>accessories for</b>	416660		
	GEV No.	361182	Ref. No.
			—
	nut thread 1/4" H 5mm nickel-plated brass WS 17 Qty 1 pcs		
	GEV No.	510417	Ref. No.
			—
	flat gasket fibre ED ø 20mm ID ø 14mm thickness 2mm Qty 1 pcs		
	GEV No.	520228	Ref. No.
			—
	tooth lock washer ID ø 15.3mm ED ø 24mm steel Qty 1 pcs for thread M14		
	GEV No.	550262	Ref. No.
			—
	flat gasket copper ED ø 20mm ID ø 14mm thickness 2mm		



<b>GEV No.</b>	415284	<b>Ref. No.</b>	00067 RC00067000
<b>description</b>	heating element 3400W 230V heating circuits 1 L 301mm W 185mm H 185mm 2 hole fixing immersion heater L1 22mm L2 282mm W1 50mm W2 85mm H1 165mm H2 20mm cable length 225mm tube ø 8.5mm thread 1/4" mounting distance 76mm connection length 55mm		
<b>accessories for</b>	415284		
	GEV No.	361182	Ref. No.
			—
	nut thread 1/4" H 5mm nickel-plated brass WS 17 Qty 1 pcs		
	GEV No.	510417	Ref. No.
			—
	flat gasket fibre ED ø 20mm ID ø 14mm thickness 2mm Qty 1 pcs		
	GEV No.	520228	Ref. No.
			—
	tooth lock washer ID ø 15.3mm ED ø 24mm steel Qty 1 pcs for thread M14		
	GEV No.	550262	Ref. No.
			—
	flat gasket copper ED ø 20mm ID ø 14mm thickness 2mm		

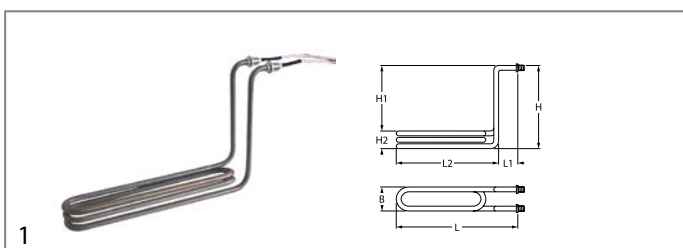

<b>GEV No.</b>	415285	<b>Ref. No.</b>	00073 RC00073000
<b>description</b>	heating element 1200W 230V heating circuits 1 L 295mm W 55mm H 185mm L1 20mm L2 275mm H1 154mm H2 31mm thread 1/4" tube ø 8.5mm cable length 290mm 2 hole fixing windings 3		
<b>accessories for</b>	415285		
	GEV No.	361182	Ref. No.
			—
	nut thread 1/4" H 5mm nickel-plated brass WS 17 Qty 1 pcs		
	GEV No.	510417	Ref. No.
			—
	flat gasket fibre ED ø 20mm ID ø 14mm thickness 2mm Qty 1 pcs		
	GEV No.	520228	Ref. No.
			—
	tooth lock washer ID ø 15.3mm ED ø 24mm steel Qty 1 pcs for thread M14		
	GEV No.	550262	Ref. No.
			—
	flat gasket copper ED ø 20mm ID ø 14mm thickness 2mm		

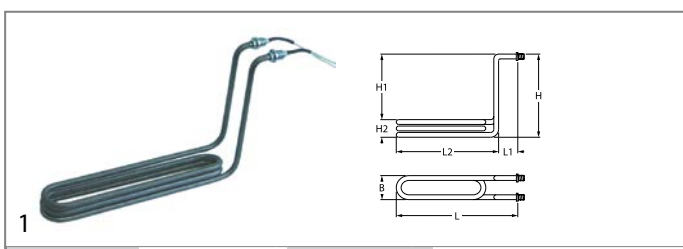

<b>GEV No.</b>	415286	<b>Ref. No.</b>	00075 RC00075000
<b>description</b>	heating element 1500W 230V heating circuits 1 L 299mm W 50mm H 180mm L1 22mm L2 275mm H1 148mm H2 32mm thread 1/4" tube ø 8.5mm cable length 295mm 2 hole fixing windings 3		
<b>accessories for</b>	415286		
	GEV No.	361182	Ref. No.
			—
	nut thread 1/4" H 5mm nickel-plated brass WS 17 Qty 1 pcs		
	GEV No.	510417	Ref. No.
			—
	flat gasket fibre ED ø 20mm ID ø 14mm thickness 2mm Qty 1 pcs		
	GEV No.	520228	Ref. No.
			—
	tooth lock washer ID ø 15.3mm ED ø 24mm steel Qty 1 pcs for thread M14		
	GEV No.	550262	Ref. No.
			—
	flat gasket copper ED ø 20mm ID ø 14mm thickness 2mm		



<b>GEV No.</b>	415287	<b>Ref. No.</b>	00142 RC00142000
<b>description</b>	heating element 2000W 230V heating circuits 1 L 298mm W 50mm H 183mm L1 22mm L2 275mm H1 144mm H2 37mm thread 1/4" tube ø 8.5mm cable length 275mm 2 hole fixing windings 3		
<b>accessories for</b>	415287		
	<b>GEV No.</b>	361182	<b>Ref. No.</b> —
	nut thread 1/4" H 5mm nickel-plated brass WS 17 Qty 1 pcs		
	<b>GEV No.</b>	510417	<b>Ref. No.</b> —
	flat gasket fibre ED ø 20mm ID ø 14mm thickness 2mm Qty 1 pcs		
	<b>GEV No.</b>	520228	<b>Ref. No.</b> —
	tooth lock washer ID ø 15.3mm ED ø 24mm steel Qty 1 pcs for thread M14		
	<b>GEV No.</b>	550262	<b>Ref. No.</b> —
	flat gasket copper ED ø 20mm ID ø 14mm thickness 2mm		

<b>GEV No.</b>	415283	<b>Ref. No.</b>	00054 RC00054000
<b>description</b>	heating element 3000W 230V heating circuits 1 L 290mm W 78mm H 185mm L1 18mm L2 267mm H1 155mm H2 27mm thread 1/4" mounting distance 67mm tube ø 8.5mm cable length 250mm 2 hole fixing connection male faston 6.3mm immersion heater windings 3		
<b>accessories for</b>	415283		
	<b>GEV No.</b>	361182	<b>Ref. No.</b> —
	nut thread 1/4" H 5mm nickel-plated brass WS 17 Qty 1 pcs		
	<b>GEV No.</b>	510417	<b>Ref. No.</b> —
	flat gasket fibre ED ø 20mm ID ø 14mm thickness 2mm Qty 1 pcs		
	<b>GEV No.</b>	520228	<b>Ref. No.</b> —
	tooth lock washer ID ø 15.3mm ED ø 24mm steel Qty 1 pcs for thread M14		
	<b>GEV No.</b>	550262	<b>Ref. No.</b> —
	flat gasket copper ED ø 20mm ID ø 14mm thickness 2mm		

<b>GEV No.</b>	415282	<b>Ref. No.</b>	00049 RC00049000
<b>description</b>	heating element 2200W 230V heating circuits 1 L 295mm W 70mm H 183mm L1 20mm L2 275mm H1 148mm H2 35mm thread 1/4" tube ø 8.5mm cable length 250mm 2 hole fixing fryer heaters windings 3		
<b>accessories for</b>	415282		
	<b>GEV No.</b>	361182	<b>Ref. No.</b> —
	nut thread 1/4" H 5mm nickel-plated brass WS 17 Qty 1 pcs		
	<b>GEV No.</b>	510417	<b>Ref. No.</b> —
	flat gasket fibre ED ø 20mm ID ø 14mm thickness 2mm Qty 1 pcs		
	<b>GEV No.</b>	520228	<b>Ref. No.</b> —
	tooth lock washer ID ø 15.3mm ED ø 24mm steel Qty 1 pcs for thread M14		
	<b>GEV No.</b>	550262	<b>Ref. No.</b> —
	flat gasket copper ED ø 20mm ID ø 14mm thickness 2mm		

heating elements for griddles

<b>GEV No.</b>	415290	<b>Ref. No.</b>	00286 RC00286000
<b>description</b>	heating element 1300W 230V heating circuits 1 L 473mm W 80mm H 55mm tube ø 6.5mm connection M4 griddle connection distance 75mm dry heating element		

<b>GEV No.</b>	416613	<b>Ref. No.</b>	00767 RC00767000
<b>description</b>	heating element 3000W 230V heating circuits 1 L 474mm W 285mm H 54mm tube ø 8.5mm connection M4 griddle connection distance 277mm dry heating element		

heating elements for chicken rotisseries

<b>GEV No.</b>	416657	<b>Ref. No.</b>	00243 RC00243000
<b>description</b>	heating element 1500W 230V 2 hole fixing thread M14x1.25 L 535mm W 49mm heating circuits 1 connection M5 dry heating element tube ø 10mm mounting distance 39mm connection length 55mm chicken rotisserie		



heating elements for pasta cookers



1

<b>GEV No.</b>	416629	<b>Ref. No.</b>	00595 01250 RC00595000 RC01250000
<b>description</b>	heating element 1600W 230V heating circuits 1 L 368mm W 70mm H 178mm connection M4 tube ø 9mm connection length 24mm dry heating element		

heating elements for chargrills





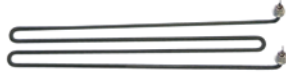

1

<b>GEV No.</b>	416601	<b>Ref. No.</b>	00775 RC00775000
<b>description</b>	heating element 1000W 230V L 396mm W 65mm H 35mm 2 hole fixing mounting distance 87mm connection M4 tube ø 6.5mm immersion heater thread 1/4" heating circuits 1 connection length 26mm		



1

<b>GEV No.</b>	415288	<b>Ref. No.</b>	00513 RC00513000
<b>description</b>	heating element 1350W 230V L 396mm W 80mm H 37mm thread 1/4" mounting distance 72mm tube ø 6.3mm connection M4 heating circuits 1 2 hole fixing dry heating element		
<b>accessories for</b>	415288		
	<b>GEV No.</b>	361182	<b>Ref. No.</b> —
	nut thread 1/4" H 5mm nickel-plated brass WS 17 Qty 1 pcs		
	<b>GEV No.</b>	510417	<b>Ref. No.</b> —
	flat gasket fibre ED ø 20mm ID ø 14mm thickness 2mm Qty 1 pcs		
	<b>GEV No.</b>	520228	<b>Ref. No.</b> —
	tooth lock washer ID ø 15.3mm ED ø 24mm steel Qty 1 pcs for thread M14		
	<b>GEV No.</b>	550262	<b>Ref. No.</b> —
	flat gasket copper ED ø 20mm ID ø 14mm thickness 2mm		



1

<b>GEV No.</b>	416618	<b>Ref. No.</b>	01111 RC01111000
<b>description</b>	heating element 1350W 230V L 450mm W 76mm H 36mm thread 1/4" mounting distance 71mm tube ø 6.3mm connection M4 heating circuits 1 connection length 36mm 2 hole fixing dry heating element		

heating elements for salamanders/toast-



1

<b>GEV No.</b>	420271	<b>Ref. No.</b>	03708 RC00003708
<b>description</b>	heating element 1000W 230V L 215mm W 95mm L1 25mm L2 25mm L3 165mm W1 16mm W2 63mm hole distance 96mm connection M4 tube ø 8.5mm flange length 106mm flange width 32mm heating circuits 1 hole ø 5mm tilt flange dry heating element H 8.5mm		

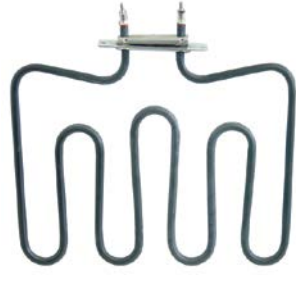

1

<b>GEV No.</b>	416653	<b>Ref. No.</b>	03804 RC00003804
<b>description</b>	heating element 2000W 230V L 225mm W 283mm L1 15mm L2 210mm W1 110mm W2 63mm hole distance 96mm connection M4 tube ø 8.5mm flange length 106mm flange width 32mm heating circuits 1 hole ø 5mm tilt flange dry heating element H 8.5mm		



1

<b>GEV No.</b>	416654	<b>Ref. No.</b>	03706 RC00003706
<b>description</b>	heating element 2000W 230V L 230mm W 230mm L1 22mm L2 208mm W1 83mm W2 63mm hole distance 96mm tube ø 8.5mm flange length 106mm flange width 32mm heating circuits 1 hole ø 5mm tilt flange dry heating element H 8.5mm		

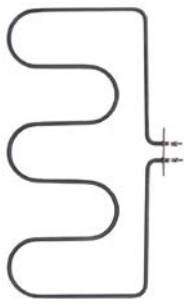

1

<b>GEV No.</b>	415280	<b>Ref. No.</b>	00171 RC00171000
<b>description</b>	heating element 1000W 230V heating circuits 1 L 217mm W 424mm L1 19mm L2 203mm W1 195mm W2 30mm flange length 70mm flange width 22mm hole distance 56mm tube ø 6.3mm windings 3 dry heating element connection M4 rectangular flange hole ø 6mm H 6.3mm		

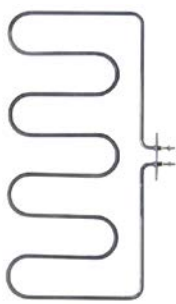
1

<b>GEV No.</b>	415279	<b>Ref. No.</b>	RC00000613
<b>description</b>	heating element 1500W 230V heating circuits 1 L 223mm W 430mm L1 12mm L2 211mm W1 200mm W2 30mm flange length 70mm flange width 23mm hole distance 56mm tube ø 6.3mm windings 4 dry heating element connection M4 rectangular flange hole ø 6mm H 6.3mm		

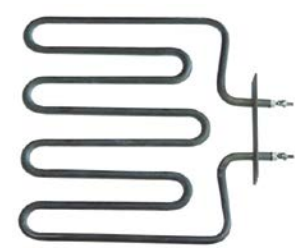

1

<b>GEV No.</b>	415621	<b>Ref. No.</b>	03706 RC00003706
<b>description</b>	heating element 2000W 230V heating circuits 1 L 228mm W 230mm L1 29mm L2 228mm W1 84mm W2 62mm flange length 116mm flange width 32mm hole distance 96mm tube ø 8.5mm connection length 17mm dry heating element connection M4 rectangular flange hole ø 5mm H 8.5mm		

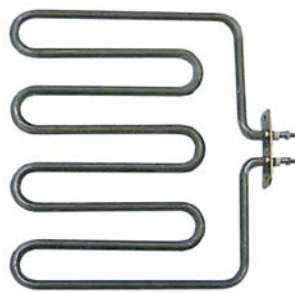

1

<b>GEV No.</b>	415622	<b>Ref. No.</b>	00109 RC00000109
<b>description</b>	heating element 2000W 230V heating circuits 1 L 229mm W 255mm L1 17mm L2 212mm W1 112mm W2 32mm flange length 70mm flange width 23mm hole distance 25mm tube ø 8.5mm connection length 20mm dry heating element connection M4 rectangular flange hole ø 5mm H 8.5mm		



1

<b>GEV No.</b>	415281	<b>Ref. No.</b>	6000 RC00006000
<b>description</b>	heating element 1000W 230V L 290mm W 130mm 2 hole fixing thread M12x1.25 mounting distance 123mm connection male faston 6.3mm dry heating element tube ø 6.3mm heating circuits 1 H 6.3mm		



1



<b>GEV No.</b>	416655	<b>Ref. No.</b>	01029 RC01029000
<b>description</b>	radiation heater rectangular 2000W 230V L 290mm W 240mm heating circuits 1 connections 2 IRCA for salamander grill		

ceramic heaters

245x60mm



1

<b>GEV No.</b>	415104	<b>Ref. No.</b>	01098 RC01098000	
<b>description</b>	ceramic emitter 1000W 230V cable beaded cord L 245mm W 60mm H 35mm			
<b>spare parts for</b>	415104			
	<b>GEV No.</b>	415109	<b>Ref. No.</b>	—
	spring clip			
<b>accessories for</b>	415104			
	<b>GEV No.</b>	415110	<b>Ref. No.</b>	—
	reflector L 245mm W 95mm H 31mm thickness 0.75mm hole ø 15x40mm			



1

<b>GEV No.</b>	415103	<b>Ref. No.</b>	00288 RC00288000	
<b>description</b>	ceramic emitter 650W 230V cable beaded cord L 245mm W 60mm H 35mm			
<b>spare parts for</b>	415103			
	<b>GEV No.</b>	415109	<b>Ref. No.</b>	—
	spring clip			
<b>accessories for</b>	415103			
	<b>GEV No.</b>	415110	<b>Ref. No.</b>	—
	reflector L 245mm W 95mm H 31mm thickness 0.75mm hole ø 15x40mm			



### immersion heating elements

3 hole flange ø47.5mm

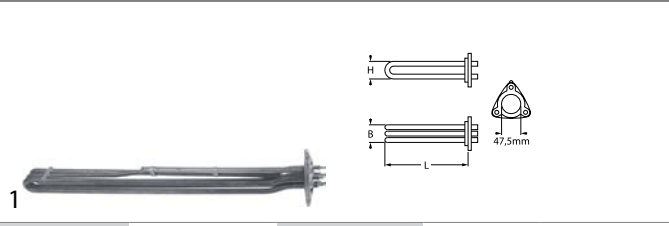

<b>GEV No.</b>	419113	<b>Ref. No.</b>	40400038 RC40400038
----------------	--------	-----------------	------------------------

**description** heating element 9000W 230V mounting ø 47.5mm heating circuits 3 L 550mm W 38mm H 45mm number of thermostat sleeves 1 thermostat sleeves ø 7.3mm length thermostat sleeves 260mm tube ø 8.5mm connection M4 3 hole flange immersion heater L1 55mm H1 33mm H2 34mm

**accessories for** 419113

<b>GEV No.</b>	510408	<b>Ref. No.</b>	—
----------------	--------	-----------------	---

 O-ring EPDM thickness 5.34mm ID ø 47mm Qty 1 pcs

### heating elements for convection



<b>GEV No.</b>	418087	<b>Ref. No.</b>	RCK6002125
----------------	--------	-----------------	------------

**description** heating element 15000W 230/400V heating circuits 3 ID ø 398mm ED ø 415mm L 452mm H 121mm L1 32mm W1 105mm H1 80mm H2 25mm flange length 142mm flange width 25mm hole distance 126mm connection M4 tube ø 8.5mm convection heating element hole ø 6mm rectangular flange

**accessories for** 418087

<b>GEV No.</b>	550548	<b>Ref. No.</b>	RCK2005173
----------------	--------	-----------------	------------

 gasket L 144mm W 25.5mm thickness 2.2mm for heating element suitable for GIORIK equiv. no. 2005173

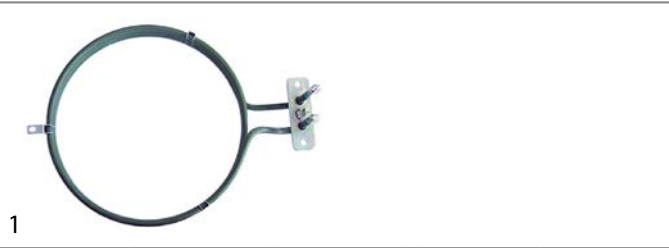

<b>GEV No.</b>	415251	<b>Ref. No.</b>	00568 RC00568000
----------------	--------	-----------------	---------------------

**description** heating element 2500W 230V heating circuits 1 ID ø 178mm ED ø 190mm L 242mm H 35mm L1 46mm W1 31mm H1 10mm H2 25mm flange length 70mm flange width 22mm hole distance 56mm connection male faston 6.3mm horizontal tube ø 6.3mm convection heating element hole ø 5mm rectangular flange

**spare parts for** 415251

<b>GEV No.</b>	510368	<b>Ref. No.</b>	—
----------------	--------	-----------------	---

 gasket L 70mm W 23.5mm hole ø 5mm hole distance 56mm FIBER thickness 2mm for heating element



<b>GEV No.</b>	418086	<b>Ref. No.</b>	RCK6002001
----------------	--------	-----------------	------------

**description** heating element 8400W 230V heating circuits 3 ID ø 218mm ED ø 235mm L 275mm H 112mm L1 40mm W1 105mm H1 32mm H2 80mm flange length 142mm flange width 25mm hole distance 64mm connection M4 tube ø 8.5mm convection heating element hole ø 6mm rectangular flange

**accessories for** 418086

<b>GEV No.</b>	550548	<b>Ref. No.</b>	RCK2005173
----------------	--------	-----------------	------------

 gasket L 144mm W 25.5mm thickness 2.2mm for heating element suitable for GIORIK equiv. no. 2005173

### radiation heaters

square



<b>GEV No.</b>	490159	<b>Ref. No.</b>	RC01434000
----------------	--------	-----------------	------------

**description** radiation heater L 300mm W 300mm 3500W 230V connections 3 square without pan detection EGO

**spare parts for** 490159

<b>GEV No.</b>	499157	<b>Ref. No.</b>	—
----------------	--------	-----------------	---

 protection pipe for temperature probe ceramic L 297mm ED ø 7mm ID ø 5mm





<b>GEV No.</b>	416655	<b>Ref. No.</b>	01029 RC01029000
----------------	--------	-----------------	---------------------

**description** radiation heater rectangular 2000W 230V L 290mm W 240mm heating circuits 1 connections 2 IRCA for salamander grill







			
1			
<b>GEV No.</b>	416656	<b>Ref. No.</b>	01030 RC01030000 RC01229000
<b>description</b>	radiation heater rectangular 4000W 230V L 490mm W 245mm heating circuits 2 connections 2+2 IRCA		
<b>spare parts for</b>	416656		
	<b>GEV No.</b>	417727	<b>Ref. No.</b>
	 terminal L 20m W 8.2mm		

1-circuit			
			
1			
<b>GEV No.</b>	490113	<b>Ref. No.</b>	00931 RC00931000
<b>description</b>	radiation heater ø 200mm 1800W 230V heating circuits 1 energy regulation with temperature signalization with ribbon heater connections 2+2 connection type male faston 6.3mm CERAMASPEED		

2-circuit			
			
1			
<b>GEV No.</b>	490118	<b>Ref. No.</b>	00932 RC00932000
<b>description</b>	radiation heater ø 250mm 2500W heating circuits 2 partial power 1000W		

accessories

flange gaskets			
			
1			
<b>GEV No.</b>	550548	<b>Ref. No.</b>	RCK2005173
<b>description</b>	gasket L 144mm W 25.5mm thickness 2.2mm for heating element suitable for GIORIK equiv. no. 2005173		

spring clips			
			
1			
<b>GEV No.</b>	550539	<b>Ref. No.</b>	RC00091000
<b>description</b>	probe clip for pipe ø 8.5mm for probe ø 4mm Qty 1 pcs		

			
1			
<b>GEV No.</b>	550398	<b>Ref. No.</b>	00333 RC00333000
<b>description</b>	probe spring for pipe ø 2x8.5mm for probe ø 4mm L 42mm W 11mm Qty 1 pcs		

hot plates

square & rectangular			
with radiused edge			
			
1			
<b>GEV No.</b>	490066 <sup>1</sup>	<b>Ref. No.</b>	01110 RC01110000
<b>description</b>	hot plate dimensions 220x220mm 2600W 230V with spill ring connection 4 screw clamps protector yes square		

<sup>1</sup>incl. protector



round

with radiused edge

for domestic and commercial kitchens

E-G-O



1

<b>GEV No.</b>	490012	<b>Ref. No.</b>	00764 RC00764000
<b>description</b>	hot plate ø 145mm 1500W 230V connection 4 screw clamps with 8mm spill ring		

E-G-O



1

<b>GEV No.</b>	490016	<b>Ref. No.</b>	00290 RC00290000
<b>description</b>	hot plate ø 180mm 2000W 230V connection 4 screw clamps with 8mm spill ring		



1

<b>GEV No.</b>	490020	<b>Ref. No.</b>	01107 RC01107000	
<b>description</b>	hot plate ø 220mm 2600W 230V connection 4 screw clamps with 8mm spill ring			
<b>accessories for</b>	490020			
	<b>GEV No.</b>	550796	<b>Ref. No.</b>	—
	fixing plate for hot plate ø220mm			

## energy regulators

EGO

1-circuit

E-G-O



1

<b>GEV No.</b>	380015	<b>Ref. No.</b>	00012 00937 06501 RC00006501 RC00012000 RC00937000
<b>description</b>	energy regulator 230V 13A single-circuit turn direction right shaft ø 6x4.6mm shaft L 23mm mounting thread M4 power release 6-100% no. 50.57021.010		

2-circuit

E-G-O



1

<b>GEV No.</b>	380027	<b>Ref. No.</b>	00938 RC00938000
<b>description</b>	energy regulator EGO 230V 13A dual circuit turn direction right shaft ø 6x4.6mm shaft L 23mm mounting thread M4 power release 6-70% no. 50.55021.100		

## thermostats

control and safety thermostats

EGO

control thermostats

55.10/19\_ series

E-G-O



1

<b>GEV No.</b>	375309	<b>Ref. No.</b>	00038 00779 RC00038000 RC00779000
<b>description</b>	thermostat t.max. 180°C temperature range 95-180°C 1-pole 1NO 16A probe ø 6mm probe L 130mm capillary pipe 1500mm capillary pipe isolated 1100mm gland nut shaft L 23mm shaft position upper rotation 270°		

E-G-O



1

<b>GEV No.</b>	375327	<b>Ref. No.</b>	00769 RC00769000
<b>description</b>	thermostat t.max. 297°C temperature range 58-297°C 1-pole 1NO 16A probe ø 3.03mm probe L 219mm capillary pipe 870mm capillary pipe isolatedmm gland nut shaft L 23mm shaft position upper rotation 270°		



<b>GEV No.</b>	375002	<b>Ref. No.</b>	00569 RC00569000
<b>description</b>	thermostat t.max. 320°C temperature range 55-320°C 1-pole 1NO 16A probe ø 3.1mm probe L 226mm capillary pipe 870mm capillary pipe isolated 850mm gland nut shaft L 23mm shaft position upper rotation 270°		



<b>GEV No.</b>	375143	<b>Ref. No.</b>	00274 RC00274000
<b>description</b>	thermostat t.max. 110°C temperature range 32-110°C 3-pole 3NO 16A probe ø 6mm probe L 138mm capillary pipe 1480mm capillary pipe isolated 1100mm gland nut M9x1 shaft ø 6x4.6mm shaft L 23mm shaft position upper rotation 270°		



<b>GEV No.</b>	375437	<b>Ref. No.</b>	RC40100042
<b>description</b>	thermostat t.max. 324°C temperature range 66-324°C 1-pole 1NO 16A probe ø 4mm probe L 124mm capillary pipe 1470mm capillary pipe isolatedmm gland nut shaft ø 6x4.6mm shaft L 23mm shaft position upper rotation 270°		



<b>GEV No.</b>	375256	<b>Ref. No.</b>	00064 RC00064000
<b>description</b>	thermostat t.max. 175°C temperature range 100-175°C 3-pole 3NO 16A probe ø 4mm probe L 157mm capillary pipe 850mm capillary pipe isolated 350mm gland nut shaft ø 6x4.6mm shaft L 23mm shaft position upper rotation 270°		

55.34\_series



<b>GEV No.</b>	375630	<b>Ref. No.</b>	1207 RC00001207
<b>description</b>	thermostat t.max. 110°C temperature range 30-110°C 3-pole 3NO 16A probe ø 6mm probe L 131mm capillary pipe 900mm capillary pipe isolatedmm gland nut M9x1 shaft ø 6x4.6mm shaft L 23mm shaft position upper rotation 318°		



<b>GEV No.</b>	390056	<b>Ref. No.</b>	00281 RC00281000
<b>description</b>	thermostat t.max. 185°C temperature range 100-185°C 3-pole 3NO 16A probe ø 4mm probe L 231mm capillary pipe 2600mm capillary pipe isolated 1000mm gland nut shaft ø 6x4.6mm shaft L 23mm shaft position upper rotation 270°		

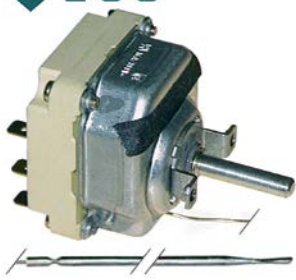

<b>GEV No.</b>	375183	<b>Ref. No.</b>	00285 RC00285000
<b>description</b>	thermostat t.max. 298°C temperature range 50-298°C 3-pole 3NO 16A probe ø 3mm probe L 219mm capillary pipe 900mm capillary pipe isolatedmm gland nut shaft ø 6x4.6mm shaft L 23mm shaft position upper rotation 318°		

safety thermostats

55.10/19\_series

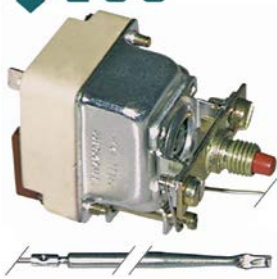

<b>GEV No.</b>	375254	<b>Ref. No.</b>	00031 RC00031000
<b>description</b>	safety thermostat 1-pole capillary pipe isolatedmm gland nut switch-off temp. 295°C probe		

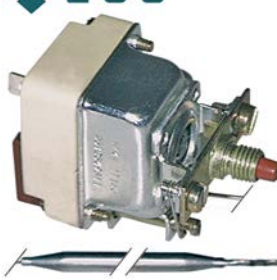

<b>GEV No.</b>	375250	<b>Ref. No.</b>	00427 RC00427000
<b>description</b>	safety thermostat capillary pipe 870mm probe ø 6mm 1-pole probe L 129mm 16A capillary pipe isolatedmm gland nut switch-off temp. 130°C probe SS		

<b>spare parts for</b>	375250			
	<b>GEV No.</b>	551083	<b>Ref. No.</b>	—

cap for safety thermostat thread M8x1

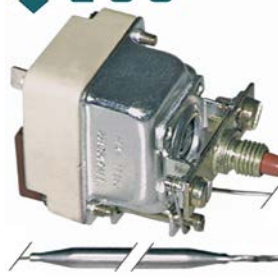

<b>GEV No.</b>	390060	<b>Ref. No.</b>	00450 RC00450000
----------------	--------	-----------------	---------------------

<b>description</b>	safety thermostat switch-off temp. 230°C 1-pole 0.5A probe SS probe ø 6mm probe L 77mm capillary pipe 870mm capillary pipe isolatedmm gland nut		
--------------------	---	--	--

<b>accessories for</b>	390060		
------------------------	--------	--	--

	<b>GEV No.</b>	551083	<b>Ref. No.</b>	—
---	----------------	--------	-----------------	---

cap for safety thermostat thread M8x1

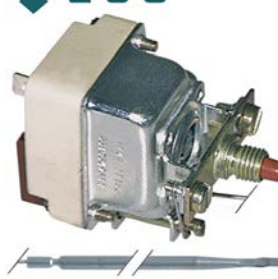

<b>GEV No.</b>	390786	<b>Ref. No.</b>	RC00770000
<b>description</b>	safety thermostat switch-off temp. 360°C 1-pole 16A probe ø 4mm probe L 128mm capillary pipe 1170mm capillary pipe isolated 990mm gland nut probe		

55.32\_series



<b>GEV No.</b>	375328	<b>Ref. No.</b>	1007 RC00001007
----------------	--------	-----------------	--------------------

<b>description</b>	safety thermostat switch-off temp. 162°C 3-pole 20A probe ø 6mm probe L 77mm capillary pipe 900mm capillary pipe isolatedmm gland nut probe		
--------------------	---	--	--



<b>GEV No.</b>	375340	<b>Ref. No.</b>	00031 00063 RC00031000 RC00063000
<b>description</b>	safety thermostat switch-off temp. 295°C 3-pole 20A probe ø 4mm probe L 120mm capillary pipe 1800mm capillary pipe isolated gland nut probe probe material SS		



<b>GEV No.</b>	390142	<b>Ref. No.</b>	00305 RC00305000
<b>description</b>	safety thermostat switch-off temp. 360°C 3-pole 20A probe ø 3.1mm probe L 188mm capillary pipe 1490mm capillary pipe isolated 800mm gland nut probe SS		



<b>GEV No.</b>	375220	<b>Ref. No.</b>	00238 RC00238000
<b>description</b>	safety thermostat switch-off temp. 330°C 3-pole 20A probe ø 11mm probe L 18.5mm capillary pipe 900mm capillary pipe isolated 900mm gland nut probe screw-in probe probe thread M14x1		

accessories

probe clips

spring clips

for thermostat

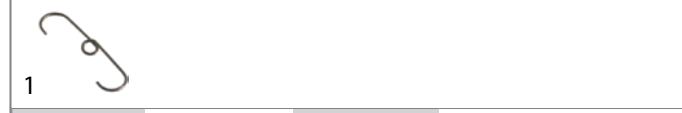

<b>GEV No.</b>	550398	<b>Ref. No.</b>	00333 RC00333000
<b>description</b>	probe spring for pipe ø 2x8.5mm for probe ø 4mm L 42mm W 11mm Qty 1 pcs		

for safety thermostat



<b>GEV No.</b>	550539	<b>Ref. No.</b>	RC00091000
<b>description</b>	probe clip for pipe ø 8.5mm for probe ø 4mm Qty 1 pcs		



<b>GEV No.</b>	375628	<b>Ref. No.</b>	RCK6010008
<b>description</b>	safety thermostat switch-off temp. 350°C 3-pole 20A probe ø 4mm probe L 120mm capillary pipe 900mm capillary pipe isolated 670mm gland nut M10x1 probe SS		

switches and momentary switches

rocker/momentary rocker switches

30x22mm



<b>GEV No.</b>	301003	<b>Ref. No.</b>	00021 04702 RC00004702 RC00021000
<b>description</b>	rocker switch mounting measurements 30x22mm green 2NO 250V 16A illuminated 0-1 connection male faston 6.3mm ambient temperature max. 125/55°C protection IP65		

accessories for 301003

	<b>GEV No.</b>	301036	<b>Ref. No.</b>	—
protective cover internal size 30x22mm for rocker switch mounting measurementsmm				



## push/momentary push switches

ø16mm



1

<b>GEV No.</b>	346346	<b>Ref. No.</b>	RCK6032038
<b>description</b>	momentary push switch mounting ø 16mm red 1NO/indicator light 250V 3A connection male faston 2.8mm ambient temperature max. 125/55°C protection IP40		

## microswitches

lever actuated



1

<b>GEV No.</b>	345107	<b>Ref. No.</b>	00204 RC00204000
<b>description</b>	microswitch with lever 250V 16A 1CO connection male faston 6.3mm L 98mm ambient temperature max. 125°C mounting distance 22mm actuating force: 30g lever length 90mm		

pin-plunger actuated



1

<b>GEV No.</b>	300092	<b>Ref. No.</b>	00092 RC00092000
<b>description</b>	microswitch with plunger 400V 16A 2NO connection male faston 6.3mm ambient temperature max. 85°C mounting distance 22mm type XTD22A21 actuating force: 150g fryer black		



1

<b>GEV No.</b>	345285	<b>Ref. No.</b>	00283 RC7804 n.änd. RC00283000
<b>description</b>	microswitch with plunger 400V 16A 2NO connection male faston 6.3mm ambient temperature max. 85°C mounting distance 22mm type XTD22J actuating force: 400g black		

M10



1

<b>GEV No.</b>	347216	<b>Ref. No.</b>	RC01853000
<b>description</b>	microswitch with plunger thread M10x0.75 thread L 14mm 250V 10A 1CO connection male faston 6.3mm stroke 7.5mm mounting distance 22mm L 28mm ambient temperature max. 125°C type NR6K5 actuating force: 260g		



1

<b>GEV No.</b>	346347	<b>Ref. No.</b>	RCK6043088
<b>description</b>	microswitch with plunger thread M10x0.75 thread L 14mm 250V 6A 2NO connection male faston 6.3mm stroke 4mm mounting distance 22mm ambient temperature max. 85°C actuating force: 100g		

## cam switches

on/off



1

<b>GEV No.</b>	300129	<b>Ref. No.</b>	RCK6030007
<b>description</b>	cam switch 2 operating positions 2NO sequence 0-1 16A shaft ø 6x4.6mm shaft L 23mm connection male faston 6.3mm ceramic		

7-position



1

<b>GEV No.</b>	300004	<b>Ref. No.</b>	00291 RC00291000
<b>description</b>	cam switch 7 operating positions 1NO/2CO sequence 0-1-2-3-4-5-6 16A shaft ø 6x4.6mm shaft L 23mm connection male faston 6.3mm 7-position ceramic		



1

<b>GEV No.</b>	300106	<b>Ref. No.</b>	RC01482000
<b>description</b>	cam switch 7 operating positions 1NO/2CO sequence 0-1-2-3-4-5-6 32A shaft ø 6x4.6mm shaft L 23mm connection screw 7-position shaft flat upper		



4 operating positions



1

<b>GEV No.</b>	345765	<b>Ref. No.</b>	01071 RC01071000
<b>description</b>	cam switch 4 operating positions 8NO sequence 0-1-2-3 16A shaft ø 6x4.6mm shaft L 23mm connection male faston 6.3mm plastic		

with potentiometer



1

<b>GEV No.</b>	345636	<b>Ref. No.</b>	01028 RC01028000
<b>description</b>	cam switch 2 operating positions 4NO sequence 0-1 16A shaft ø 6x4.6mm shaft L 23mm connection cable 560mm 0.1-10KOhm with potentiometer		

operation switches



1

<b>GEV No.</b>	300002	<b>Ref. No.</b>	00070 RC00070000
<b>description</b>	cam switch 2 operating positions 4NO 16A sequence 0-1 shaft ø 6x4.6mm shaft L 23mm connection male faston 6.3mm ceramic		



1

<b>GEV No.</b>	300080	<b>Ref. No.</b>	RC40100006
<b>description</b>	cam switch 2 operating positions 4NO 16A sequence 0-1 shaft ø 6x4.6mm shaft L 23mm connection screw operation switch ceramic ambient temperature max. 150°C		
<b>accessories for</b>	300080		
	<b>GEV No.</b>	551456	<b>Ref. No.</b> —
gasket for switch ED ø 14mm ID ø 2.5mm thickness 3.5mm white			



1

<b>GEV No.</b>	300200	<b>Ref. No.</b>	00037 RC00037000
<b>description</b>	operation switch 2 operating positions 2NO 16A sequence 0-1 shaft ø 6x4.6mm shaft L 23mm connection male faston 6.3mm operation switch ceramic		

rotary switches

BREMAS

A1600 series



1

<b>GEV No.</b>	346341	<b>Ref. No.</b>	RCK6030030
<b>description</b>	rotary switch 8 1-2-3-4-5-6-7-8 sets of contacts 10 type CS0169134 400V 16A shaft ø 4x5mm shaft L 20mm shaft square connection screw		

control equipment

GENERAL ELECTRIC (AEG)

push buttons



1

<b>GEV No.</b>	346854	<b>Ref. No.</b>	RC00004811
<b>description</b>	push button mounting measurements ø22mm green		

encoders and potentiometers



1

<b>GEV No.</b>	345636	<b>Ref. No.</b>	01028 RC01028000
<b>description</b>	cam switch 2 operating positions 4NO sequence 0-1 16A shaft ø 6x4.6mm shaft L 23mm connection cable 560mm 0.1-10KOhm with potentiometer		



			
1			
<b>GEV No.</b>	300187	<b>Ref. No.</b>	RCK6010097
<b>description</b>	potentiometer 4.7KOhm rotation 310° shaft ø 0.6x4.5mm shaft L 20mm cable length 650mm		

## lamps



### indicator lights



#### indicator lights 2-piece (lens and indicator lamp)

#### indicator light lenses

#### ø10mm (type SRZ-3)

			
1			
<b>GEV No.</b>	359228	<b>Ref. No.</b>	RC01783000
<b>description</b>	indicator light housings mounting measurements ø10mm clear round Qty 1 pcs		

				
1				
<b>GEV No.</b>	359123	<b>Ref. No.</b>	00053 RC00053000	
<b>description</b>	indicator light housings mounting measurements ø10mm green round Qty 1 pcs			
<b>accessories for</b>	359123			
	<b>GEV No.</b>	359132	<b>Ref. No.</b>	00052 RC01782000
	indicator lamp green 250V connection male faston 6.3mm protection IP54 ambient temperature max. 85°C			

				
1				
<b>GEV No.</b>	359124	<b>Ref. No.</b>	00319 RC00319000	
<b>description</b>	indicator light housings mounting measurements ø10mm yellow round Qty 1 pcs			
<b>accessories for</b>	359124			
	<b>GEV No.</b>	359132	<b>Ref. No.</b>	00052 RC01782000
	indicator lamp green 250V connection male faston 6.3mm protection IP54 ambient temperature max. 85°C			

#### indicator lamps for socket type SRZ / SDK / SDY / SFK

			
1			
<b>GEV No.</b>	359130	<b>Ref. No.</b>	RC00052000
<b>description</b>	indicator lamp 230V clear connection male faston 6.3mm ø 8mm		

			
1			
<b>GEV No.</b>	359132	<b>Ref. No.</b>	00052 RC01782000
<b>description</b>	indicator lamp green 250V connection male faston 6.3mm protection IP54 ambient temperature max. 85°C		

### indicator lights (complete)

#### ø 6mm

			
1			
<b>GEV No.</b>	357084	<b>Ref. No.</b>	RC00006601
<b>description</b>	indicator lamp ø 6mm 240V green		

			
1			
<b>GEV No.</b>	359031	<b>Ref. No.</b>	00011 RC00011000
<b>description</b>	indicator light ø 6mm 230V green		

#### ø12mm

#### with screw socket

			
1			
<b>GEV No.</b>	359048	<b>Ref. No.</b>	RC40200150
<b>description</b>	indicator light ø 12mm 230V yellow connection male faston 6.3mm		

### screw-on/push-on fit

#### light bulbs

#### for ovens

			
1			
<b>GEV No.</b>	359610	<b>Ref. No.</b>	00566 RC00566000
<b>description</b>	light bulb t.max. 300°C socket E14 15W 230V ø 22mm L 47mm lens L 20mm for oven lamp type Philips		





halogen lamp

for socket G4 / G6.35 / G9



1

<b>GEV No.</b>	357191	<b>Ref. No.</b>	RCE00C4396
<b>description</b>	halogen lamp socket G4 12V 10W temp.-resist. 300°C OSRAM HALOSTAR OVEN		



1

<b>GEV No.</b>	359599	<b>Ref. No.</b>	RCK6061054
<b>description</b>	halogen lamp socket G4 12V 20W temp.-resist. 500°C		



1

<b>GEV No.</b>	359946	<b>Ref. No.</b>	RC01856000
<b>description</b>	halogen lamp socket G9 230V 40W temp.-resist. 300°C		

linear lamps

infrared lamps

with base type X lug



1

<b>GEV No.</b>	359617	<b>Ref. No.</b>	00217 RC00217000
<b>description</b>	infrared lamp 1000W 220V L 365mm lens L 340mm total length 480mm with mounting strap		

sockets for linear lamps

X lug



1

<b>GEV No.</b>	359710	<b>Ref. No.</b>	00218 RC00218000
<b>description</b>	lamp socket L 70mm W 70mm H 49mm mounting distance 50mm bracket mounting		



oven lamps

universal oven lamps

mounting diameter 35.5mm



1

<b>GEV No.</b>	359718	<b>Ref. No.</b>	00805 RC00805000	
<b>description</b>	oven lamp mounting ø 35.5mm 230V 15W socket E14 temp.-resist. 300°C connection male faston 6.3mm hard glas			
<b>spare parts for</b>	359718			
	<b>GEV No.</b>	359701	<b>Ref. No.</b>	—
	lamp socket socket E14 220-230V mounting ø 35.5mm connection male faston 6.3mm 15W			
	<b>GEV No.</b>	359740	<b>Ref. No.</b>	—
	light bulb t.max. 300°C socket E14 15W 230V ø 22mm L 48mm lens L 20mm for oven lamp IMPORT			

30x70mm



1

<b>GEV No.</b>	359338	<b>Ref. No.</b>	RCK6063077
<b>description</b>	lamp glass		



1

<b>GEV No.</b>	359337	<b>Ref. No.</b>	RCK6063075	
<b>description</b>	oven lamp socket G4 cable length 800mm connection Faston 6.3mm L 70mm W 29mm			
<b>accessories for</b>	359337			
	<b>GEV No.</b>	359599	<b>Ref. No.</b>	RCK6061054
	halogen lamp socket G4 12V 20W temp.-resist. 500°C			

55x70mm





1

<b>GEV No.</b>	359659	<b>Ref. No.</b>	00275 RC00275000
<b>description</b>	oven lamp complete 230V 25W socket E14 L 70mm W 55mm mounting measurements 55x70mm temp.-resist. 300°C connection male faston 6.3mm		



			
1			
<b>GEV No.</b>	359299	<b>Ref. No.</b>	RC02027000
<b>description</b>	gasket L 91mm W 77mm hole ø 3mm for oven lamp		

lamps			
light bulbs			
			
1			
<b>GEV No.</b>	359610	<b>Ref. No.</b>	00566 RC00566000
<b>description</b>	light bulb t.max. 300°C socket E14 15W 230V ø 22mm L 47mm lens L 20mm for oven lamp type Philips		

halogen lamps			
for socket G4 / G6.35 / G9			
			
1			
<b>GEV No.</b>	357191	<b>Ref. No.</b>	RCE00C4396
<b>description</b>	halogen lamp socket G4 12V 10W temp.-resist. 300°C OSRAM HALOSTAR OVEN		

			
1			
<b>GEV No.</b>	359599	<b>Ref. No.</b>	RCK6061054
<b>description</b>	halogen lamp socket G4 12V 20W temp.-resist. 500°C		

			
1			
<b>GEV No.</b>	359946	<b>Ref. No.</b>	RC01856000
<b>description</b>	halogen lamp socket G9 230V 40W temp.-resist. 300°C		



## timers

### electric timers

#### with time spread

			
1			
<b>GEV No.</b>	350074	<b>Ref. No.</b>	RCK6032047
<b>description</b>	timer MS65 operation time 120min time spread 30min 1CO/2NO/1NC at 250V 16A permanent position yes impulse electric shaft ø 6x4.6mm shaft L 22mm mounting distance 28mm connection lateral Invensys 4-pole shaft position lower°		

### mechanical timers

			
1			
<b>GEV No.</b>	350032	<b>Ref. No.</b>	00022 00713 RC00000713 RC00022000
<b>description</b>	timer M2 2-pole operation time 15min impulse mechanical 2NO at 250V 16A permanent position no shaft ø 6x4.6mm shaft 6x4.6mm shaft L 18mm mounting distance 28mm connection rear		
<b>accessories for</b>	350032		
	<b>GEV No.</b>	110366	<b>Ref. No.</b> —
	knob switch zero mark t.max.°C ø 44mm shaft ø 6x4.6mm shaft flat upper black		
	<b>GEV No.</b>	110371	<b>Ref. No.</b> —
	dial plate graduation 15min permanent position no rotation 30-330° ø 60mm timers knob ø 45mm		

			
1			
<b>GEV No.</b>	350049	<b>Ref. No.</b>	RC01261000
<b>description</b>	timer M2 with bell 2-pole operation time 30min impulse mechanical 2NO at 250V 16A permanent position yes shaft ø 6x4.6mm shaft 6x4.6mm shaft L 23mm mounting distance 28mm connection lateral		
<b>accessories for</b>	350049		
	<b>GEV No.</b>	110366	<b>Ref. No.</b> —
	knob switch zero mark t.max.°C ø 44mm shaft ø 6x4.6mm shaft flat upper black		
	<b>GEV No.</b>	111205	<b>Ref. No.</b> —
	dial plate graduation 30min permanent position yes rotation 30-300° ø 60mm		



			
1			
<b>GEV No.</b>	350040	<b>Ref. No.</b>	RC00576000
<b>description</b>	timer M2 with bell 2-pole operation time 60min impulse mechanical 2NO at 250V 16A permanent position yes shaft ø 6x4.6mm shaft 6x4.6mm shaft L 23mm mounting distance 28mm connection lateral		
<b>accessories for</b>	350040		
	<b>GEV No.</b>	110366	<b>Ref. No.</b> —
	knob switch zero mark t.max.°C ø 44mm shaft ø 6x4.6mm shaft flat upper black		
	<b>GEV No.</b>	111202	<b>Ref. No.</b> —
	dial plate graduation 60min permanent position yes rotation 0-300° ø 60mm timers knob ø 45mm with permanent position		

audible timers

			
1			
<b>GEV No.</b>	350036	<b>Ref. No.</b>	00570 RC00570000
<b>description</b>	audible timer operation time 60min ø 55mm shaft ø 6x4.6mm shaft L 22mm mounting distance 28mm		

alarm devices

buzzers



			
1			
<b>GEV No.</b>	350080	<b>Ref. No.</b>	RCK6010103
<b>description</b>	buzzer buzzer		

contactors

ISKRA (FANAL)

power contactors

			
1			
<b>GEV No.</b>	380204	<b>Ref. No.</b>	00938 06208 RC00006208 RC00938000
<b>description</b>	power contactor resistive load 25A 230VAC (AC3/400V) 9A/4kW main contacts 3NO auxiliary contacts 1NO connection screw connection type Fanal DSL9 10 type ISKRA KNL9 10		

			
1			
<b>GEV No.</b>	380424	<b>Ref. No.</b>	RCK6046041
<b>description</b>	power contactor resistive load 35A 230VAC (AC3/400V) 32A/15kW main contacts 3NO auxiliary contacts 1NO connection screw connection type Fanal DSL9 10 type ISKRA KNL30		
<b>accessories for</b>	380424		
	<b>GEV No.</b>	381378	<b>Ref. No.</b> —
	overload switch connection screw setting range 24,5-30A for contactors KNL30 type BR30 24.5-30A		

miscellaneous

overload switches

			
1			
<b>GEV No.</b>	380373	<b>Ref. No.</b>	00239 RC00239000
<b>description</b>	overload switch		



## relays

## power relays

## with bracket mounting



1

<b>GEV No.</b>	380403	<b>Ref. No.</b>	00774 01213 RC00001213 RC00774000
<b>description</b>	power relays FINDER 230VAC 16A 3CO connection F6.3 bracket mounting manuf. no. 62.83.8.230.0500		

## time relays

## time relays



1

<b>GEV No.</b>	381119	<b>Ref. No.</b>	RCK6042049
<b>description</b>	time relay LOVATO TM D time range 0.06-180s		



1

<b>GEV No.</b>	380607	<b>Ref. No.</b>	RCK6042054
<b>description</b>	time relay LOVATO TM M1 time range 0s-10 days 12-24V AC/DC 8A 1CO connection grip connection		



1

<b>GEV No.</b>	380606	<b>Ref. No.</b>	RCK6042056
<b>description</b>	time relay LOVATO TM PL time range 2x 0.1s-100 days 12-240V AC/DC 8A 1CO connection grip connection		

## transformers

## for lighting



1

<b>GEV No.</b>	401175	<b>Ref. No.</b>	RCK6041065
<b>description</b>	transformer primary 230V secondary 11.5V 90VA		

## probes

## universal probes

## temperature probes



1

<b>GEV No.</b>	379860	<b>Ref. No.</b>	RCK6000100
<b>description</b>	temperature probe NTC 10kOhm cable PVC probe -20 up to +80°C cable -10 up to 100°C probe ø6x40mm cable length 1.5m without screw connection 2-wire		



1

<b>GEV No.</b>	379222 <sup>1</sup>	<b>Ref. No.</b>	RCK6000083
<b>description</b>	temperature probe Pt100 cable Vetrotex probe -200 up to +600°C cable -50 up to +350°C probe ø4x110mm cable length 1.4m 3-wire		

<sup>1</sup>3-wire

## electronics

## PCBs

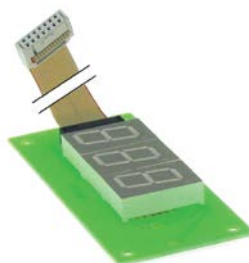

1

<b>GEV No.</b>	401166	<b>Ref. No.</b>	RCK6010095
<b>description</b>	display		



1

<b>GEV No.</b>	400952	<b>Ref. No.</b>	01014 RC01014000
<b>description</b>	PCB		

1

<b>GEV No.</b>	400953	<b>Ref. No.</b>	01015 RC01015000
<b>description</b>	PCB		



1

<b>GEV No.</b>	401171	<b>Ref. No.</b>	RCK6010084
<b>description</b>	PCB combi-steamer		



1

<b>GEV No.</b>	401172	<b>Ref. No.</b>	RCK6010093
<b>description</b>	PCB combi-steamer VE 06/10		



1

<b>GEV No.</b>	401167	<b>Ref. No.</b>	RCK6010096	
<b>description</b>	PCB combi-steamer VE 06/10 230V 50/60Hz			
<b>accessories for</b>	401167			
	<b>GEV No.</b>	401062	<b>Ref. No.</b>	—
	buzzer board 230VAC L 48mm W 45mm connection Faston 6.3mm			

## keypads

### front foils



1

<b>GEV No.</b>	693150	<b>Ref. No.</b>	01016 RC01016000
<b>description</b>	keypad foil salamander grill QSE40		



1

<b>GEV No.</b>	693151	<b>Ref. No.</b>	01017 RC01017000
<b>description</b>	keypad foil salamander grill QSE60		

## solenoid valves

### solenoid valves (water)

RPE



1

<b>GEV No.</b>	374017	<b>Ref. No.</b>	RCK6042070
<b>description</b>	solenoid valve single straight 230VAC inlet 3/4" outlet 10mm input 6l/min DN10 RPE polyamide flow regulating valve inlet white membranes NBR pressure range 0.2-10bar		

JOHN GUEST



1

<b>GEV No.</b>	370768 <sup>1</sup>	<b>Ref. No.</b>	RC01964000
<b>description</b>	solenoid valve single straight 230VAC inlet 3/4" outlet 10mm input/ min output/min DN10 t.max. 90°C duty cycle 100% RPE		

<sup>1</sup>cylindrical outlet



## pressure switches

### for steam control

			
1			
<b>GEV No.</b>	541074	<b>Ref. No.</b>	RC01842000
<b>description</b>	pressure control ø 45mm triggering pressure 0.5bar reset pressure 0.35bar pressure connection vertical steam control pressure range 0.35/0.51bar connection 1/8" pressure connection 1/8"		

## fans



### axial fans

#### import

			
1			
<b>GEV No.</b>	601604 <sup>1</sup>	<b>Ref. No.</b>	RC01863000
<b>description</b>	axial fan L 119mm W 119mm H 38mm 230VAC 50/60Hz 17/15W bearing slide bearing manuf. no. AA1282HS-AT connection cable 300mm fan wheel ø 110mm temp.-resist. 70°C input current 0.1A airflow 130m <sup>3</sup> /h 2600rpm		

<sup>1</sup>with slide bearings

### hot air motors

			
1			
<b>GEV No.</b>	500640	<b>Ref. No.</b>	RCK6032122
<b>description</b>	fan motor 220-240V 1 phase 50Hz 0.05/0.25HP 1400/2700rpm speeds 2 L1 145mm L2 65mm L3 35mm D1 ø 15mm D2 ø 12mm M10L ET 1.1/0.55A suitable capacitor 12.5µF/450V at 50Hz 1400/2700rpm type 2758D2253 no. 6032122		
<b>spare parts for</b>	500640		
	<b>GEV No.</b>	560280	<b>Ref. No.</b> —
	nut thread M10L H 8mm WS 17 SS DIN/ISO DIN 934 / ISO 4032/8673 Qty 1 pcs		

			
1			
<b>GEV No.</b>	500642	<b>Ref. No.</b>	RCK6033145
<b>description</b>	fan motor 380-415V 3 phase 50Hz 0.22/0.75kW 700/1400rpm speeds 2 L1 166mm L2 45mm L3 67mm D1 ø 24mm D2 ø 20mm M6R ITA at 50Hz 380-415V at 50Hz 700/1400rpm type FB80 4/8 no. 629764		

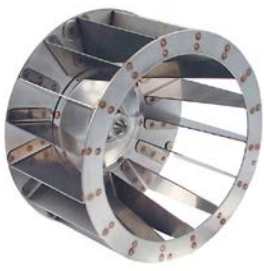
			
1			
<b>GEV No.</b>	601202	<b>Ref. No.</b>	RCK5901006
<b>description</b>	fan wheel D1 ø 180mm H1 100mm blades 16 D2 ø 11.5mm D3 ø 16mm H2 30mm		

			
1			
<b>GEV No.</b>	601203	<b>Ref. No.</b>	RCK5901010
<b>description</b>	fan wheel D1 ø 310mm H1 100mm blades 30 D2 ø 19.5mm D3 ø 23mm H2 46mm		

### hot air fans

#### ebm-papst

			
1			
<b>GEV No.</b>	601103	<b>Ref. No.</b>	00229 RC00229000
<b>description</b>	radial fan 230V 47W L1 60mm L2 26mm L3 20mm L4 157mm fan wheel ø 150mm type G25150-AB08-44		



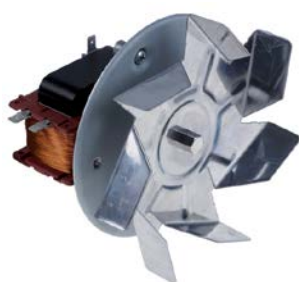

miscellaneous

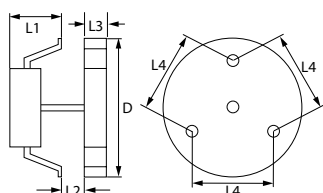

1





<b>GEV No.</b>	601011	<b>Ref. No.</b>	00565 RC00565000
<b>description</b>	hot air fan 220-240V 40W 50/60Hz L1 65mm L2 15mm L3 25mm L4 87mm fan wheel ø 150mm FIME type C25R8023CLH		
<b>accessories for</b>	601011		
	<b>GEV No.</b>	550879	<b>Ref. No.</b> —
	insulation ø 130mm thickness 3mm hole ø 20mm for hot air fan		
	<b>GEV No.</b>	601260	<b>Ref. No.</b> —
	nut thread M6L IT for hot air fan		

pumps

vibration pumps



1

<b>GEV No.</b>	500568	<b>Ref. No.</b>	RC01969000
<b>description</b>	vibration pump 230V 32W 50Hz inlet ø 7 outlet ø 1/8" IT CEME type E512/A32		
<b>spare parts for</b>	500568		
	<b>GEV No.</b>	390698	<b>Ref. No.</b> —
	thermal fuse switch-off temp. 110°C suitable for ULKA pump		
	<b>GEV No.</b>	520153	<b>Ref. No.</b> —
	bracket rubber dimensions 53x34x28mm		

condensators & interference sup-  
pression filters

operating capacitors

plastic



1

<b>GEV No.</b>	365014	<b>Ref. No.</b>	LF3068081 RCK2013001
<b>description</b>	operating capacitor capacity 12.5µF 450V tolerance 5%Hz ambient temperature max. -25 to +85°C ø 35mm L 70mm M8 plastic connection male faston 6.3mm 45S.C3DS.12.5 protection		

filters

interference suppression filters



1

<b>GEV No.</b>	365044	<b>Ref. No.</b>	RCK6090050
<b>description</b>	interference suppression filter type FC701Y2F 250V 50-60Hz conductor 2 with E connection cable 200mm L 42mm ø 23mm Hmm Wmm plastic Qty 1 pcs		

fuses

fine fuses



1

<b>GEV No.</b>	358677	<b>Ref. No.</b>	RC01861000
<b>description</b>	fine fuse size ø5x20mm 4A fast-acting rated 250V Qty 10 pcs		

electric accessories

cables

accessories

cable glands

threaded cable glands

screw connections



1

<b>GEV No.</b>	550571	<b>Ref. No.</b>	RC00241000
<b>description</b>	cable gland thread PG16 cable ø 12.0-14.0mm mounting ø 21.5mm nickel-plated brass Qty 1 pcs		



## terminals

## connection terminals with screw/faston connections



1

<b>GEV No.</b>	550977 <sup>1</sup>	<b>Ref. No.</b>	RC00194000
<b>description</b>	power terminal block 6-pole max. 40A max 450V connection $\phi 6\text{mm}^2$ / F6.3 temp.-resist. 150°C cross section $6\text{mm}^2$ with ground lug		

<sup>1</sup>with ground lug

## gas taps





## PEL

## 21S series



1

<b>GEV No.</b>	101095	<b>Ref. No.</b>	50014 RC05001400
<b>description</b>	gas tap PEL type 21S gas inlet M16x1.5 (tube $\phi$ 10mm) bypass nozzle $\phi$ 0.35mm gas outlet M16x1.5 (tube $\phi$ 10/8mm) thermocouple connection M8x1 pilot connection M10x1 shaft $\phi$ 8x6.5mm shaft L 22/15mm shaft flat lower		
<b>spare parts for</b>	101095		
	<b>GEV No.</b>	100408	<b>Ref. No.</b> —
	bypass nozzle type PEL20/21 bore $\phi$ 0.35mm thread M5x0.5		
	<b>GEV No.</b>	101060	<b>Ref. No.</b> —
	magnet unit standard L 39mm D1 $\phi$ 15.4mm D2 $\phi$ 11mm suitable for PEL20-21/JUNKERS/EGA		
	<b>GEV No.</b>	101206	<b>Ref. No.</b> —
	gas tap front part shaft $\phi$ 8x6.5mm shaft L 22/15mm shaft flat upper/lower suitable for PEL21		
	<b>GEV No.</b>	101230	<b>Ref. No.</b> —
	thermocouple nut T1: M8x1 T2: M18x1 aluminium		
<b>accessories for</b>	101095		
	<b>GEV No.</b>	100908	<b>Ref. No.</b> —
	union screw thread M10x1 for pipe $\phi$ 4mm Qty 1 pcs		
	<b>GEV No.</b>	100909	<b>Ref. No.</b> —
	union screw thread M10x1 for pipe $\phi$ 6mm Qty 1 pcs		
	<b>GEV No.</b>	101246	<b>Ref. No.</b> —
	olive for pipe $\phi$ 4mm Qty 1 pcs		
	<b>GEV No.</b>	101278	<b>Ref. No.</b> —
	olive for pipe $\phi$ 10mm Qty 1 pcs		
	<b>GEV No.</b>	101286	<b>Ref. No.</b> —
	olive ID $\phi$ 6mm Qty 1 pcs		

<b>accessories for</b>	101095		
	<b>GEV No.</b>	101300	<b>Ref. No.</b> —
	union nut thread M16x1.5 tube $\phi$ 10mm		
	<b>GEV No.</b>	101450	<b>Ref. No.</b> —
	olive for pipe $\phi$ 8mm L 12.7mm Qty 1 pcs ED $\phi$ 10mm		
	<b>GEV No.</b>	101451	<b>Ref. No.</b> —
	union nut thread M16x1.5 tube $\phi$ 8mm		
	<b>GEV No.</b>	110081	<b>Ref. No.</b> RC05001300
	knob $\phi$ 70mm shaft $\phi$ 8x6.5mm shaft flat universal		
	<b>GEV No.</b>	112206	<b>Ref. No.</b> —
	knob dial plate silver gas tap PEL21/22/23 t.max.°C ED $\phi$ 63mm ID $\phi$ 45.5mm		

## 22S/V series



1

<b>GEV No.</b>	101087	<b>Ref. No.</b>	00126 RC00126000
<b>description</b>	gas tap PEL type 22S/V gas inlet M20x1.5 (tube $\phi$ 12mm) bypass nozzle $\phi$ 0.35mm gas outlet M20x1.5 (tube $\phi$ 12/10mm) thermocouple connection M9x1 pilot connection M10x1 shaft $\phi$ 10x8mm shaft L 25/17mm shaft flat upper		
<b>spare parts for</b>	101087		
	<b>GEV No.</b>	100259	<b>Ref. No.</b> —
	bypass nozzle type PEL22 bore $\phi$ 0.35mm thread M6x0.5		
	<b>GEV No.</b>	101058	<b>Ref. No.</b> —
	magnet unit L 39mm D1 $\phi$ 15.4mm D2 $\phi$ 13.5mm suitable for PEL22/EGA24197 standard		
	<b>GEV No.</b>	101201	<b>Ref. No.</b> —
	gas tap front part shaft $\phi$ 10x8mm shaft L 25/17mm shaft flat upper/lower suitable for PEL22		
	<b>GEV No.</b>	101231	<b>Ref. No.</b> —
	thermocouple nut T1: M9x1 T2: M18x1		
	<b>GEV No.</b>	101241	<b>Ref. No.</b> —
	gas connection thread M20x1.5 tube $\phi$ 12/10mm for PEL gas taps vertical		
	<b>GEV No.</b>	101460	<b>Ref. No.</b> —
	O-ring $\phi$ 12.37mm D1 $\phi$ 2.62mm suitable for PEL22		
	<b>GEV No.</b>	101461	<b>Ref. No.</b> —
	screw kit suitable for PEL22 Qty 4 pcs		
<b>accessories for</b>	101087		
	<b>GEV No.</b>	100908	<b>Ref. No.</b> —
	union screw thread M10x1 for pipe $\phi$ 4mm Qty 1 pcs		
	<b>GEV No.</b>	100909	<b>Ref. No.</b> —
	union screw thread M10x1 for pipe $\phi$ 6mm Qty 1 pcs		

Table continues overleaf





accessories for		101087	
	GEV No.	101240	Ref. No. —
gas connection thread M20x1.5 tube ø 12/10mm for PEL gas taps with gasket and screws horizontal			
	GEV No.	101246	Ref. No. —
olive for pipe ø 4mm Qty 1 pcs			
	GEV No.	101248	Ref. No. —
olive for pipe ø 12mm Qty 1 pcs suitable for PEL			
	GEV No.	101249	Ref. No. —
olive for pipe ø 10mm Qty 1 pcs			
	GEV No.	101250	Ref. No. —
union nut thread M20x1.5 for pipe ø 10mm			
	GEV No.	101251	Ref. No. —
union nut thread M20x1.5 for pipe ø 12mm			
	GEV No.	101286	Ref. No. —
olive ID ø 6mm Qty 1 pcs			
	GEV No.	110080	Ref. No. 00127 RC00127000
knob ø 70mm shaft ø 10x8mm shaft flat universal			
	GEV No.	112206	Ref. No. —
knob dial plate silver gas tap PEL21/22/23 t.max.°C ED ø 63mm ID ø 45.5mm			

accessories for		101396	
	GEV No.	520656	Ref. No. —
union nut thread 1/4" tube ø 6/8mm			
	GEV No.	560082	Ref. No. —
hexagonal screw thread M4 thread L 16mm SS WS 7 Qty 20 pcs DIN 933 / ISO 4017			

## gas thermostats

### SIT

#### 630 Eurosit series

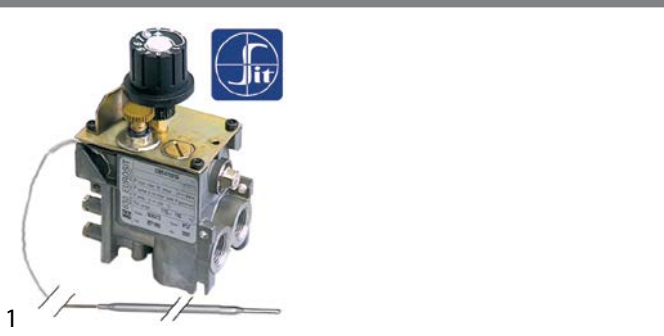

GEV No.	101188	Ref. No.	00446 RC00446000
<b>description</b>	gas thermostat type 630 Eurosit series t.max. 190°C 110-190°C gas inlet 3/8" gas outlet 3/8" thermocouple connection M9x1 pilot connection M10x1 probe ø 4mm probe L 202mm capillary pipe 1050mm SIT		

accessories for		101188	
	GEV No.	100904	Ref. No. —
locking screw M10x1 for pipe ø 4mm Qty 1 pcs			
	GEV No.	100905	Ref. No. —
locking screw M10x1 for pipe ø 6mm Qty 1 pcs			
	GEV No.	101273	Ref. No. —
olive for pipe ø 12mm L 9.5mm brass Qty 1 pcs suitable for universal			
	GEV No.	101276	Ref. No. —
union screw thread 3/8" tube ø 12mm Qty 1 pcs			
	GEV No.	101333	Ref. No. —
plug thread 3/8" with O-ring			

## SABAF



GEV No.	101396	Ref. No.	00369 RC00369000
<b>description</b>	gas tap SABAF type 10 gas inlet pipe flange ø 16mm bypass nozzle ø 0mm gas outlet 1/4" (tube ø 8mm) front fixing thermocouple connection M8x1 shaft ø 8x6.5mm shaft L 26/12mm shaft flat lower		

spare parts for		101396	
	GEV No.	101376	Ref. No. —
gasket ID ø 8mm ED ø 12mm H 3/5mm			
	GEV No.	101751	Ref. No. —
bracket			
	GEV No.	106724	Ref. No. —
magnet unit L 30mm D1 ø 12.5mm D2 ø 8.5mm suitable for SABAF			

accessories for		101396	
	GEV No.	101277	Ref. No. —
olive ID ø 8mm Qty 1 pcs			
	GEV No.	101751	Ref. No. —
bracket			

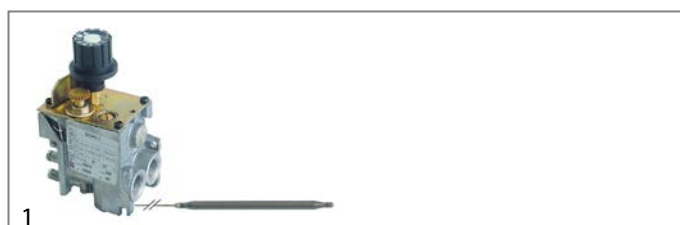

GEV No.	101696	Ref. No.	01171 RC01171000
<b>description</b>	gas thermostat type 630 Eurosit series t.max. 300°C 60-300°C gas inlet 3/8" gas outlet 3/8" thermocouple connection M9x1 pilot connection M10x1 probe ø 4mm probe L 72mm capillary pipe 1050mm SIT		

spare parts for		101696	
	GEV No.	101333	Ref. No. —
plug thread 3/8" with O-ring			

Table continues overleaf



<b>accessories for</b>	101696		
	GEV No.	100904	Ref. No. —
locking screw M10x1 for pipe ø 4mm Qty 1 pcs			
	GEV No.	100905	Ref. No. —
locking screw M10x1 for pipe ø 6mm Qty 1 pcs			
	GEV No.	101273	Ref. No. —
olive for pipe ø 12mm L 9.5mm brass Qty 1 pcs suitable for universal			
	GEV No.	101276	Ref. No. —
union screw thread 3/8" tube ø 12mm Qty 1 pcs			

**PEL**

**25ST series**



<b>GEV No.</b>	101172	<b>Ref. No.</b>	01133 RC01133000
<b>description</b>	gas thermostat PEL type 25ST 100-300°C gas inlet M16x1.5 (tube ø 10mm) bypass nozzle ø 0.35mm gas outlet M16x1.5 (tube ø 10/8mm) thermocouple connection M9x1 pilot connection M10x1 capillary pipe 1200mm probe ø 6mm probe L 100mm shaft ø 8x6.5mm shaft L 21/15mm shaft flat upper		
<b>spare parts for</b>	101172		
	GEV No.	100259	Ref. No. —
bypass nozzle type PEL22 bore ø 0.35mm thread M6x0.5			
	GEV No.	101060	Ref. No. —
magnet unit standard L 39mm D1 ø 15.4mm D2 ø 11mm suitable for PEL20-21/JUNKERS/EGA			
	GEV No.	106200	Ref. No. —
nut thread M9x1 suitable for PEL 24/25S			
<b>accessories for</b>	101172		
	GEV No.	100908	Ref. No. —
union screw thread M10x1 for pipe ø 4mm Qty 1 pcs			
	GEV No.	100909	Ref. No. —
union screw thread M10x1 for pipe ø 6mm Qty 1 pcs			
	GEV No.	101246	Ref. No. —
olive for pipe ø 4mm Qty 1 pcs			
	GEV No.	101278	Ref. No. —
olive for pipe ø 10mm Qty 1 pcs			
	GEV No.	101286	Ref. No. —
olive ID ø 6mm Qty 1 pcs			
	GEV No.	101300	Ref. No. —
union nut thread M16x1.5 tube ø 10mm			
	GEV No.	101450	Ref. No. —
olive for pipe ø 8mm L 12.7mm Qty 1 pcs ED ø 10mm			
	GEV No.	101451	Ref. No. —
union nut thread M16x1.5 tube ø 8mm			

<b>accessories for</b>	101172		
	GEV No.	110079	Ref. No. —
knob dial plate gas thermostat 1-8 silver			
	GEV No.	110081	Ref. No. RC05001300
knob ø 70mm shaft ø 8x6.5mm shaft flat universal			

**SABAF**

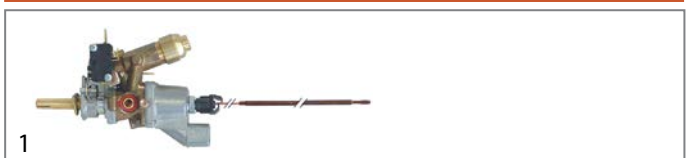



<b>GEV No.</b>	101694	<b>Ref. No.</b>	00889 RC00889000 RC02228000
<b>description</b>	gas thermostat SABAF t.max. 300°C gas inlet pipe flange bypass nozzle ø 0.38mm gas outlet M13x1 IT (tube ø 8mm) gas outlet 2 thermocouple connection M8x1 capillary pipe 850mm probe ø 4mm probe L 150mm shaft ø 8x6.5mm shaft flat lower L1 29mm L2 29mm		
<b>spare parts for</b>	101694		
	GEV No.	101060	Ref. No. —
magnet unit standard L 39mm D1 ø 15.4mm D2 ø 11mm suitable for PEL20-21/JUNKERS/EGA			
<b>accessories for</b>	101694		
	GEV No.	101277	Ref. No. —
olive ID ø 8mm Qty 1 pcs			
	GEV No.	101376	Ref. No. —
gasket ID ø 8mm ED ø 12mm H 3/5mm			
	GEV No.	101477	Ref. No. —
union screw thread M13x1 tube ø 8mm Qty 1 pcs			
	GEV No.	101751	Ref. No. —
bracket			



<b>GEV No.</b>	101695	<b>Ref. No.</b>	00890 RC00890000
<b>description</b>	gas thermostat SABAF t.max. 300°C gas inlet pipe flange bypass nozzle ø 0.52mm gas outlet M13x1 IT (tube ø 8mm) gas outlet 2 thermocouple connection M8x1 capillary pipe 850mm probe ø 4mm probe L 150mm shaft ø 8x6.5mm shaft L 29/29mm shaft flat lower		
<b>spare parts for</b>	101695		
	GEV No.	101060	Ref. No. —
magnet unit standard L 39mm D1 ø 15.4mm D2 ø 11mm suitable for PEL20-21/JUNKERS/EGA			
<b>accessories for</b>	101695		
	GEV No.	101277	Ref. No. —
olive ID ø 8mm Qty 1 pcs			
	GEV No.	101376	Ref. No. —
gasket ID ø 8mm ED ø 12mm H 3/5mm			

Table continues overleaf



<b>accessories for</b>	101695			
	GEV No.	101477	Ref. No.	—
	union screw thread M13x1 tube ø 8mm Qty 1 pcs			
	GEV No.	101479	Ref. No.	—
	bracket			

## gas valves and ignition boxes







### gas control valves

#### SIT

#### NOVASIT









1

<b>GEV No.</b>	101187	<b>Ref. No.</b>	RC30300014	
<b>description</b>	gas valve SIT series Novasit 820 0.17VHz gas inlet 1/2" gas outlet 1/2" thermocouple connection M9x1 pilot connection M10x1 ignition pressurembar pressure range 5-50mbar pressure regulator connection blind equiv. no. 0.820.301 supply Operator millivolt			
<b>spare parts for</b>	101187			
	GEV No.	101065	Ref. No.	—
	magnet unit with cable L 44mm D1 ø 30mm D2 ø 20mm suitable for NOVASIT			
<b>accessories for</b>	101187			
	GEV No.	100110	Ref. No.	—
	pilot burner SIT type 190 series 3 flames nozzle ømm gas connectionmm			
	GEV No.	101305	Ref. No.	—
	gas connection straight 1/2" flange 45x45mm ELETTROSIT/V4400/4600/4605 suitable for SIT/HONEYWELL hole distance 36x36mm			
	GEV No.	101306	Ref. No.	—
	gas connection angled flange 45x45mm hole distance 36x36mm 1/2" ELETTROSIT/V4400/4600/4605 screw with O-ring suitable for SIT/HONEYWELL			
	GEV No.	101307	Ref. No.	—
	gas connection straight flange 45x45mm hole distance 36x36mm 3/4" ELETTROSIT/V4400/4600/4605 screw with O-ring suitable for SIT/HONEYWELL			
	GEV No.	101308	Ref. No.	—
	gas connection angled flange 45x45mm hole distance 36x36mm 3/4" ELETTROSIT/V4400/4600/4605 screw with O-ring suitable for SIT/HONEYWELL			
	GEV No.	102116	Ref. No.	—
	thermopile ROBERTSHAW L 900mm probe ø 9mm probe L 57mm 250-750mV screw connection 7/16"			

#### TANDEM



1

<b>GEV No.</b>	101881	<b>Ref. No.</b>	RCK7020080	
<b>description</b>	gas valve 230V 50Hz gas inlet 1/2" gas outlet 1/2" pilot connection level slow ignition ignition times pressure range 3-50mbar power supply for modulator equiv. no. 0.830.041 suitable for Tandem			
<b>spare parts for</b>	101881			
	GEV No.	101379	Ref. No.	—
	solenoid coil 230V 50Hz suitable for Tandem			
<b>accessories for</b>	101881			
	GEV No.	101274	Ref. No.	RCK7070036
	olive for pipe ø 16mm Qty 1 pcs			
	GEV No.	101275	Ref. No.	—
	union screw thread 1/2" for pipe ø 16mm Qty 1 pcs			
	GEV No.	101925	Ref. No.	—
	plug with O-ring thread M10x1 for pilot burner suitable for NOVASIT			
	GEV No.	102845	Ref. No.	—
	gas connection angled 1/2" flange 32x32mm hole distance 24x24mm Tandem			
	GEV No.	102846	Ref. No.	—
	gas connection straight 1/2" flange 32x32mm hole distance 24x24mm suitable for Tandem			
	GEV No.	102847	Ref. No.	—
	O-ring			

### ignition boxes

#### SIT



1

<b>GEV No.</b>	101685	<b>Ref. No.</b>	RCK7020085	
<b>description</b>	ignition box SIT type 503EFD electrodes 2 waiting time 1.5s safety time 10s 220/240V 10VA 50-60Hz protection IP40			



# ignition parts

## pilot burners

SIT

100 series



1

<b>GEV No.</b>	106901	<b>Ref. No.</b>	01140 RC01140000
<b>description</b>	pilot burner SIT type 100 series 1 flame nozzle ø 0.2mm gas connection 6mm		
<b>spare parts for</b>	106901		
	GEV No.	100854	Ref. No. —
pilot burner bracket double			
	GEV No.	100916	Ref. No. —
compression spring for pilot burner Qty 1 pcs			
	GEV No.	100917	Ref. No. —
gasket for pilot burner Qty 1 pcs aluminium			
	GEV No.	100918	Ref. No. —
screw for pilot burner			
<b>accessories for</b>	106901		
	GEV No.	100904	Ref. No. —
locking screw M10x1 for pipe ø 4mm Qty 1 pcs			
	GEV No.	100905	Ref. No. —
locking screw M10x1 for pipe ø 6mm Qty 1 pcs			
	GEV No.	102110	Ref. No. —
pilot tube copper pipe ø 4mm thickness 1mm L 3000mm			
	GEV No.	102111	Ref. No. —
pilot tube copper pipe ø 6mm thickness 1mm L 3000mm			
	GEV No.	102742	Ref. No. —
pilot burner nozzle LPG code 25 bore ø 0.25mm Qty 1 pcs			



1

<b>GEV No.</b>	106903	<b>Ref. No.</b>	00119 RC00119000
<b>description</b>	pilot burner SIT type 100 series 3 flames nozzle ø 0.2mm gas connection 6mm		
<b>spare parts for</b>	106903		
	GEV No.	100245	Ref. No. 00435 RC00435000
pilot burner nozzle LPG code 20 bore ø 0.2mm Qty 1 pcs thread M8x0.75			

<b>spare parts for</b>	106903		
	GEV No.	100854	Ref. No. —
pilot burner bracket double			
	GEV No.	100885	Ref. No. —
air mixing sleeve for pilot burner Qty 1 pcs			
	GEV No.	100916	Ref. No. —
compression spring for pilot burner Qty 1 pcs			
	GEV No.	100917	Ref. No. —
gasket for pilot burner Qty 1 pcs aluminium			
	GEV No.	100918	Ref. No. —
screw for pilot burner			
	GEV No.	107162	Ref. No. —
pilot burner cap SIT 3 flames Hmm Lmm Qty 1 pcs			
	GEV No.	107701	Ref. No. —
pilot burner bottom part SIT 100 series nozzle ø 0.2mm			
<b>accessories for</b>	106903		
	GEV No.	100245	Ref. No. 00435 RC00435000
pilot burner nozzle LPG code 20 bore ø 0.2mm Qty 1 pcs thread M8x0.75			
	GEV No.	100246	Ref. No. 00436 RC00436000
pilot burner nozzle natural gas bore ø 0.35mm Qty 1 pcs thread M8x0.75			
	GEV No.	100904	Ref. No. —
locking screw M10x1 for pipe ø 4mm Qty 1 pcs			
	GEV No.	100905	Ref. No. —
locking screw M10x1 for pipe ø 6mm Qty 1 pcs			
	GEV No.	102110	Ref. No. —
pilot tube copper pipe ø 4mm thickness 1mm L 3000mm			
	GEV No.	102111	Ref. No. —
pilot tube copper pipe ø 6mm thickness 1mm L 3000mm			
	GEV No.	107171	Ref. No. —
pilot burner nozzle SIT natural/liquid gas bore ø 0.25mm Qty 1 pcs			
	GEV No.	107700	Ref. No. —
pilot burner bottom part SIT 100 series nozzle ø 0.25mm			
	GEV No.	107702	Ref. No. —
pilot burner bottom part SIT 100 series nozzle ø 0.35mm			



			
1			
<b>GEV No.</b>	106906	<b>Ref. No.</b>	00445 RC00445000
<b>description</b>	pilot burner SIT type 100 series 3 flames nozzle $\phi$ 0.2mm gas connection 6mm		
<b>spare parts for</b>	106906		
	<b>GEV No.</b>	100245	<b>Ref. No.</b> 00435 RC00435000
	pilot burner nozzle LPG code 20 bore $\phi$ 0.2mm Qty 1 pcs thread M8x0.75		
	<b>GEV No.</b>	100855	<b>Ref. No.</b> 00411 RC00411000
	pilot burner bracket triple		
	<b>GEV No.</b>	100885	<b>Ref. No.</b> —
	air mixing sleeve for pilot burner Qty 1 pcs		
	<b>GEV No.</b>	100916	<b>Ref. No.</b> —
	compression spring for pilot burner Qty 1 pcs		
	<b>GEV No.</b>	100917	<b>Ref. No.</b> —
	gasket for pilot burner Qty 1 pcs aluminium		
	<b>GEV No.</b>	100918	<b>Ref. No.</b> —
	screw for pilot burner		
	<b>GEV No.</b>	107162	<b>Ref. No.</b> —
	pilot burner cap SIT 3 flames Hmm Lmm Qty 1 pcs		
	<b>GEV No.</b>	107701	<b>Ref. No.</b> —
	pilot burner bottom part SIT 100 series nozzle $\phi$ 0.2mm		
<b>accessories for</b>	106906		
	<b>GEV No.</b>	100245	<b>Ref. No.</b> 00435 RC00435000
	pilot burner nozzle LPG code 20 bore $\phi$ 0.2mm Qty 1 pcs thread M8x0.75		
	<b>GEV No.</b>	100246	<b>Ref. No.</b> 00436 RC00436000
	pilot burner nozzle natural gas bore $\phi$ 0.35mm Qty 1 pcs thread M8x0.75		
	<b>GEV No.</b>	100904	<b>Ref. No.</b> —
	locking screw M10x1 for pipe $\phi$ 4mm Qty 1 pcs		
	<b>GEV No.</b>	100905	<b>Ref. No.</b> —
	locking screw M10x1 for pipe $\phi$ 6mm Qty 1 pcs		
	<b>GEV No.</b>	102110	<b>Ref. No.</b> —
	pilot tube copper pipe $\phi$ 4mm thickness 1mm L 3000mm		
	<b>GEV No.</b>	102111	<b>Ref. No.</b> —
	pilot tube copper pipe $\phi$ 6mm thickness 1mm L 3000mm		
	<b>GEV No.</b>	107171	<b>Ref. No.</b> —
	pilot burner nozzle SIT natural/liquid gas bore $\phi$ 0.25mm Qty 1 pcs		
	<b>GEV No.</b>	107700	<b>Ref. No.</b> —
	pilot burner bottom part SIT 100 series nozzle $\phi$ 0.25mm		























<b>accessories for</b>	106906		
	<b>GEV No.</b>	107702	<b>Ref. No.</b> —
	pilot burner bottom part SIT 100 series nozzle $\phi$ 0.35mm		
			
1			
<b>GEV No.</b>	106907	<b>Ref. No.</b>	RC30100005
<b>description</b>	pilot burner SIT type 100 series 3 flames nozzle $\phi$ 0.35mm gas connection 6mm		
<b>spare parts for</b>	106907		
	<b>GEV No.</b>	100246	<b>Ref. No.</b> 00436 RC00436000
	pilot burner nozzle natural gas bore $\phi$ 0.35mm Qty 1 pcs thread M8x0.75		
	<b>GEV No.</b>	100855	<b>Ref. No.</b> 00411 RC00411000
	pilot burner bracket triple		
	<b>GEV No.</b>	100885	<b>Ref. No.</b> —
	air mixing sleeve for pilot burner Qty 1 pcs		
	<b>GEV No.</b>	100916	<b>Ref. No.</b> —
	compression spring for pilot burner Qty 1 pcs		
	<b>GEV No.</b>	100917	<b>Ref. No.</b> —
	gasket for pilot burner Qty 1 pcs aluminium		
	<b>GEV No.</b>	100918	<b>Ref. No.</b> —
	screw for pilot burner		
	<b>GEV No.</b>	107162	<b>Ref. No.</b> —
	pilot burner cap SIT 3 flames Hmm Lmm Qty 1 pcs		
	<b>GEV No.</b>	107702	<b>Ref. No.</b> —
	pilot burner bottom part SIT 100 series nozzle $\phi$ 0.35mm		
<b>accessories for</b>	106907		
	<b>GEV No.</b>	100245	<b>Ref. No.</b> 00435 RC00435000
	pilot burner nozzle LPG code 20 bore $\phi$ 0.2mm Qty 1 pcs thread M8x0.75		
	<b>GEV No.</b>	100904	<b>Ref. No.</b> —
	locking screw M10x1 for pipe $\phi$ 4mm Qty 1 pcs		
	<b>GEV No.</b>	100905	<b>Ref. No.</b> —
	locking screw M10x1 for pipe $\phi$ 6mm Qty 1 pcs		
	<b>GEV No.</b>	102110	<b>Ref. No.</b> —
	pilot tube copper pipe $\phi$ 4mm thickness 1mm L 3000mm		
	<b>GEV No.</b>	102111	<b>Ref. No.</b> —
	pilot tube copper pipe $\phi$ 6mm thickness 1mm L 3000mm		
	<b>GEV No.</b>	107171	<b>Ref. No.</b> —
	pilot burner nozzle SIT natural/liquid gas bore $\phi$ 0.25mm Qty 1 pcs		

Table continues overleaf



<b>accessories for</b> 106907				
	GEV No.	107700	Ref. No.	—
	pilot burner bottom part SIT 100 series nozzle $\varnothing$ 0.25mm			
	GEV No.	107701	Ref. No.	—
	pilot burner bottom part SIT 100 series nozzle $\varnothing$ 0.2mm			

**accessories**  
pilot burner brackets  
universal

				
1				
<b>GEV No.</b>	100855	<b>Ref. No.</b>	00411 RC00411000	
<b>description</b>	pilot burner bracket triple			
<b>accessories for</b> 100855				
	GEV No.	100855	Ref. No.	00411 RC00411000
	pilot burner bracket triple			
	GEV No.	100886	Ref. No.	—
	pilot burner bracket suitable for 100 series 3-piece			
	GEV No.	100888	Ref. No.	—
	screw bolt for pilot burner			

<b>pilot burner nozzles</b>				
				
1				
<b>GEV No.</b>	100245	<b>Ref. No.</b>	00435 RC00435000	
<b>description</b>	pilot burner nozzle LPG code 20 bore $\varnothing$ 0.2mm Qty 1 pcs thread M8x0.75			

				
1				
<b>GEV No.</b>	100246	<b>Ref. No.</b>	00436 RC00436000	
<b>description</b>	pilot burner nozzle natural gas bore $\varnothing$ 0.35mm Qty 1 pcs thread M8x0.75			

**ignition electrodes**

				
1				
<b>GEV No.</b>	100706	<b>Ref. No.</b>	00120 RC00120000	
<b>description</b>	ignition electrode connection M4 Qty 1 pcs			

**140 - 145 -150 series**





























				
1				
<b>GEV No.</b>	107134	<b>Ref. No.</b>	01169 RC01169000	
<b>description</b>	pilot burner SIT type 140 series 1 flame nozzle $\varnothing$ mm gas connectionmm			
<b>accessories for</b> 107134				
	GEV No.	100204	Ref. No.	RC01219000
	pilot burner nozzle SIT LPG code 14 bore $\varnothing$ 0.18/0.20mm Qty 1 pcs suitable for 140 series			
	GEV No.	100205	Ref. No.	—
	pilot burner nozzle SIT LPG code 19 bore $\varnothing$ 0.23/0.26mm Qty 1 pcs suitable for SIT 150 series			
	GEV No.	100206	Ref. No.	—
	pilot burner nozzle SIT natural gas code 36 bore $\varnothing$ 0.60/0.55mm Qty 1 pcs suitable for SIT 150 series			
	GEV No.	100207	Ref. No.	RCK7042013
	pilot burner nozzle SIT natural gas code 27 bore $\varnothing$ 0.40/0.38mm suitable for SIT 140 series			
	GEV No.	100216	Ref. No.	—
	pilot burner nozzle SIT natural gas code 38 bore $\varnothing$ 0.45mm Qty 1 pcs suitable for SIT 150 series			
	GEV No.	100701	Ref. No.	01168 RC01168000
	ignition electrode connection M4 Qty 1 pcs			
	GEV No.	100897	Ref. No.	—
	olive for pipe $\varnothing$ 4mm Qty 1 pcs for pilot burner			
	GEV No.	100898	Ref. No.	—
	olive for pipe $\varnothing$ 6mm Qty 1 pcs for pilot burner			
	GEV No.	100906	Ref. No.	RCK7050028
	screw connection thread M10x1 for ignition electrode brass Qty 1 pcs WS 10			
	GEV No.	100907	Ref. No.	—
	screw connection thread M10x1 Qty 1 pcs type SEF 1 $\varnothing$ mm for thermocouple			
	GEV No.	100908	Ref. No.	—
	union screw thread M10x1 for pipe $\varnothing$ 4mm Qty 1 pcs			

Table continues overleaf



<b>accessories for</b>	107134		
	GEV No.	100909	Ref. No. —
	union screw thread M10x1 for pipe ø 6mm Qty 1 pcs		





<b>1</b>			
<b>GEV No.</b>	107114 <sup>1</sup>	<b>Ref. No.</b>	RCK7090028
<b>description</b>	pilot burner SIT type 140 series 2 flames nozzle ømm gas connectionmm		
<b>spare parts for</b>	107114		
	GEV No.	100907	Ref. No. —
	screw connection thread M10x1 Qty 1 pcs type SEF 1 ømm for thermocouple		
<b>accessories for</b>	107114		
	GEV No.	100204	Ref. No. RC01219000
	pilot burner nozzle SIT LPG code 14 bore ø 0.18/0.20mm Qty 1 pcs suitable for 140 series		
	GEV No.	100205	Ref. No. —
	pilot burner nozzle SIT LPG code 19 bore ø 0.23/0.26mm Qty 1 pcs suitable for SIT 150 series		
	GEV No.	100206	Ref. No. —
	pilot burner nozzle SIT natural gas code 36 bore ø 0.60/0.55mm Qty 1 pcs suitable for SIT 150 series		
	GEV No.	100207	Ref. No. RCK7042013
	pilot burner nozzle SIT natural gas code 27 bore ø 0.40/0.38mm suitable for SIT 140 series		
	GEV No.	100216	Ref. No. —
	pilot burner nozzle SIT natural gas code 38 bore ø 0.45mm Qty 1 pcs suitable for SIT 150 series		
	GEV No.	100701	Ref. No. 01168 RC01168000
	ignition electrode connection M4 Qty 1 pcs		
	GEV No.	100801	Ref. No. —
	gasket for pilot burner Qty 1 pcs		
	GEV No.	100897	Ref. No. —
	olive for pipe ø 4mm Qty 1 pcs for pilot burner		
	GEV No.	100898	Ref. No. —
	olive for pipe ø 6mm Qty 1 pcs for pilot burner		
	GEV No.	100906	Ref. No. RCK7050028
	screw connection thread M10x1 for ignition electrode brass Qty 1 pcs WS 10		
	GEV No.	100908	Ref. No. —
	union screw thread M10x1 for pipe ø 4mm Qty 1 pcs		
	GEV No.	100909	Ref. No. —
	union screw thread M10x1 for pipe ø 6mm Qty 1 pcs		
	GEV No.	102110	Ref. No. —
	pilot tube copper pipe ø 4mm thickness 1mm L 3000mm		
	GEV No.	102111	Ref. No. —
	pilot tube copper pipe ø 6mm thickness 1mm L 3000mm		

<sup>1</sup>incl. thermocouple fitting

POLIDORO			
pilot burners			
<b>1</b>			
<b>GEV No.</b>	100051	<b>Ref. No.</b>	RCK7090026
<b>description</b>	pilot burner POLIDORO 3 flames code gas connectionmm		
<b>spare parts for</b>	100051		
	GEV No.	100907	Ref. No. —
	screw connection thread M10x1 Qty 1 pcs type SEF 1 ømm for thermocouple		
<b>accessories for</b>	100051		
	GEV No.	100000	Ref. No. —
	pilot burner nozzle POLIDORO LPG code 22 bore ø 0.22mm Qty 1 pcs		
	GEV No.	100208	Ref. No. —
	pilot burner nozzle POLIDORO LPG code 20 bore ø 0.2mm Qty 1 pcs		
	GEV No.	100209	Ref. No. —
	pilot burner nozzle POLIDORO natural gas code 40 bore ø 0.4mm Qty 1 pcs		
	GEV No.	100701	Ref. No. 01168 RC01168000
	ignition electrode connection M4 Qty 1 pcs		
	GEV No.	100906	Ref. No. RCK7050028
	screw connection thread M10x1 for ignition electrode brass Qty 1 pcs WS 10		
	GEV No.	100907	Ref. No. —
	screw connection thread M10x1 Qty 1 pcs type SEF 1 ømm for thermocouple		
	GEV No.	100908	Ref. No. —
	union screw thread M10x1 for pipe ø 4mm Qty 1 pcs		
	GEV No.	100909	Ref. No. —
	union screw thread M10x1 for pipe ø 6mm Qty 1 pcs		
	GEV No.	102110	Ref. No. —
	pilot tube copper pipe ø 4mm thickness 1mm L 3000mm		
	GEV No.	102111	Ref. No. —
	pilot tube copper pipe ø 6mm thickness 1mm L 3000mm		
	GEV No.	102508	Ref. No. —
	union screw thread M10x1 for pipe ø 4mm Qty 5 pcs		
	GEV No.	102509	Ref. No. —
	union screw thread M10x1 for pipe ø 6mm Qty 5 pcs		
	GEV No.	102699	Ref. No. —
	pilot burner nozzle POLIDORO natural gas code 25.2 bore ø 2x0.25mm Qty 1 pcs 2 bores		
	GEV No.	102795	Ref. No. —
	olive for pipe ø 4mm Qty 1 pcs		
	GEV No.	102797	Ref. No. —
	olive for pipe ø 6mm Qty 1 pcs		

Table continues overleaf



accessories for		100051	
GEV No.	106703	Ref. No.	RCK7042008
	pilot burner nozzle POLIDORO natural gas code 27.2 bore $\phi$ 2x0.27mm Qty 1 pcs		
GEV No.	106704	Ref. No.	—
	pilot burner nozzle POLIDORO LPG code 16.2 bore $\phi$ 2x0.16mm Qty 1 pcs		
GEV No.	106763	Ref. No.	—
	pilot burner nozzle POLIDORO natural gas code 27.2A bore $\phi$ 2x 0.27mm Qty 1 pcs		
GEV No.	106859	Ref. No.	—
	pilot burner nozzle POLIDORO LPG code 24 bore $\phi$ 0.24mm Qty 1 pcs		

## electrodes

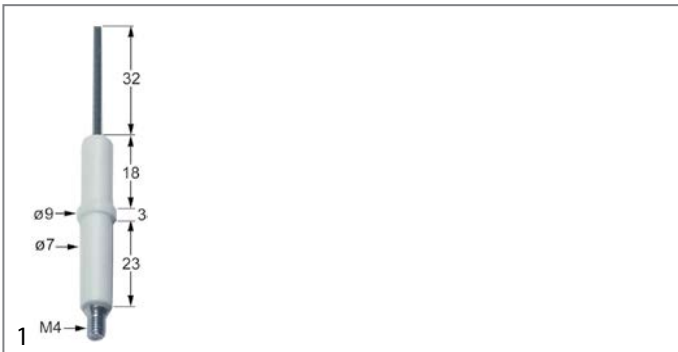

GEV No.	100701	Ref. No.	01168 RC01168000
<b>description</b>	ignition electrode connection M4 Qty 1 pcs		

accessories for		100701	
GEV No.	100906	Ref. No.	RCK7050028
	screw connection thread M10x1 for ignition electrode brass Qty 1 pcs WS 10		

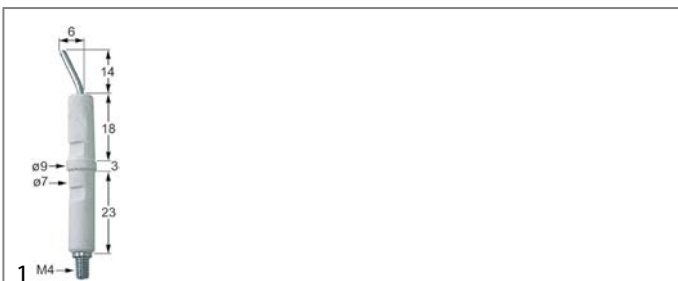

GEV No.	100706	Ref. No.	00120 RC00120000
<b>description</b>	ignition electrode connection M4 Qty 1 pcs		

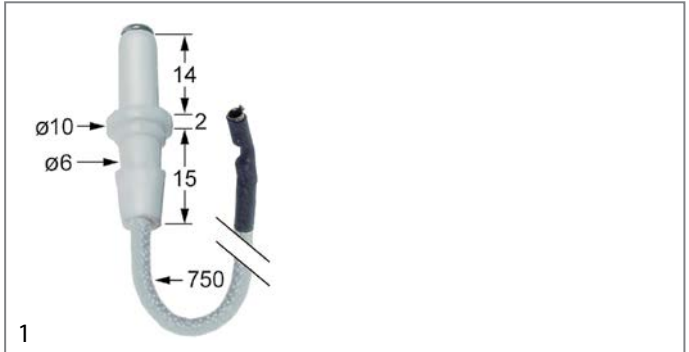

GEV No.	100738	Ref. No.	00368 RC00368000
<b>description</b>	ignition electrode D1 $\phi$ 6mm cable length 750mm D2 $\phi$ 10mm BL1 14mm BL2 2mm BL3 15mm to clip with spring and insulation connection $\phi$ 2.4mm		

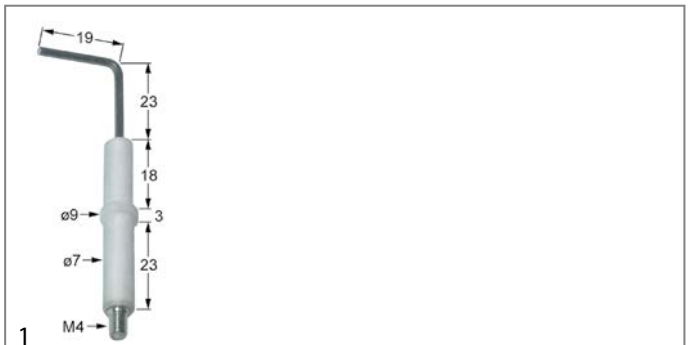

GEV No.	102333	Ref. No.	RCK2012111
<b>description</b>	ignition electrode D1 $\phi$ 7mm D2 $\phi$ 9mm connection M4 L1 23mm L2 19mm BL1 18mm BL2 3mm BL3 23mm to clip		

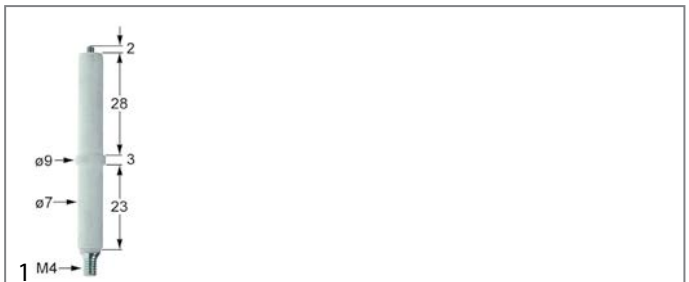

GEV No.	102314	Ref. No.	RCK6010061
<b>description</b>	ignition electrode D1 $\phi$ 7mm D2 $\phi$ 9mm connection M4 L1 2mm BL1 28mm BL2 3mm BL3 23mm to clip		

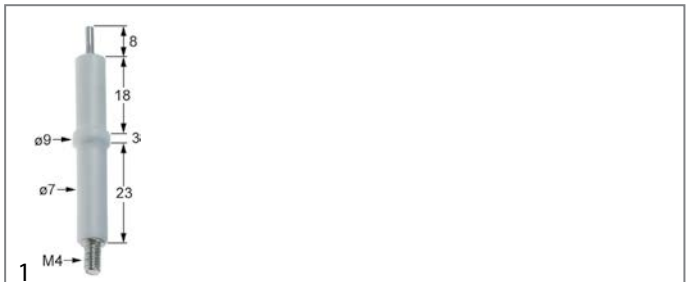

GEV No.	102871	Ref. No.	RC01168000
<b>description</b>	ignition electrode D1 $\phi$ 7mm D2 $\phi$ 9mm connection M4 L1 8mm BL1 18mm BL2 3mm BL3 23mm to clip		



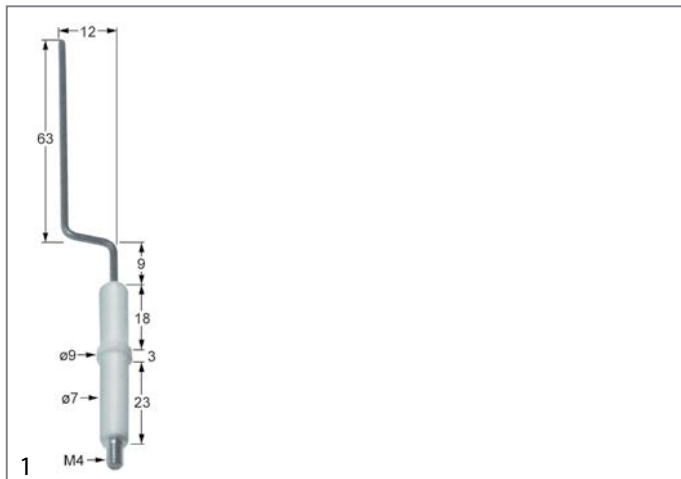

<b>GEV No.</b>	102334	<b>Ref. No.</b>	RCK2012110
<b>description</b>	ignition electrode D1 ø 7mm D2 ø 9mm connection M4 L1 9mm L2 12mm L3 62mm BL1 18mm BL2 3mm BL3 23mm to clip		

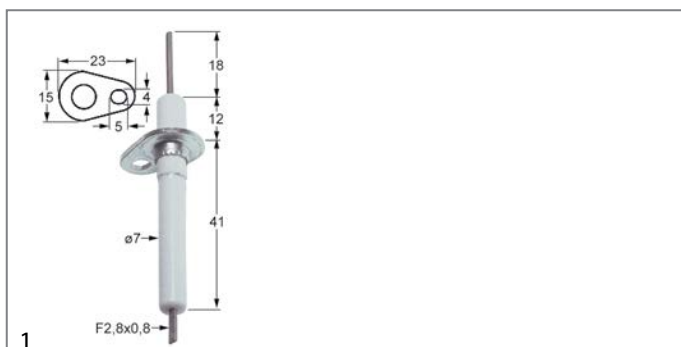

<b>GEV No.</b>	100818	<b>Ref. No.</b>	00861 RC00861000
<b>description</b>	ignition electrode flange length 23mm flange width 15mm D1 ø 7mm L1 18mm BL1 12mm BL2 41mm connection F 2.8x0.8mm fixing dimensions ø5x4mm with flange		



<b>GEV No.</b>	100906	<b>Ref. No.</b>	RCK7050028
<b>description</b>	screw connection thread M10x1 for ignition electrode brass Qty 1 pcs WS 10		

### ignition cables

#### pre-assembled cables

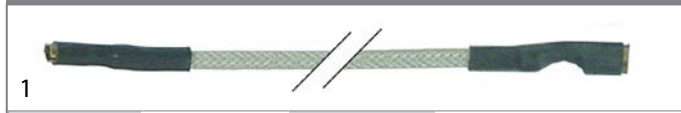

<b>GEV No.</b>	100176	<b>Ref. No.</b>	RCK6050610
<b>description</b>	ignition cable cable length 1000mm connection ø2.4mm / ø4mm permanent temperature 200°C		

<b>GEV No.</b>	100174	<b>Ref. No.</b>	00867 RC00867000
<b>description</b>	ignition cable cable length 1500mm connection F2.8mm / F2.8mm		

<b>GEV No.</b>	100140	<b>Ref. No.</b>	RCK6050051
<b>description</b>	ignition cable cable length 400mm connection ø2.4mm / ø4mm		

<b>GEV No.</b>	100018	<b>Ref. No.</b>	00123 RC00123000
<b>description</b>	ignition cable cable length 600mm connection ø2.4mm / ø4mm permanent temperature 200°C		

### piezoelectric igniters

#### mounting diameter 18mm

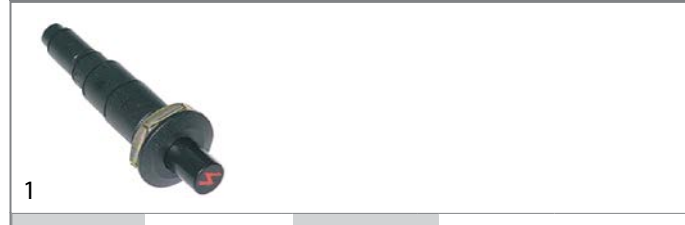

<b>GEV No.</b>	100009	<b>Ref. No.</b>	00128 RC00128000
<b>description</b>	piezoelectric igniter body plastic blowing mounting ø 18mm connection ø2.4mm front measurements 26mm M18x1.5		

<b>accessories for</b>	100009			
	<b>GEV No.</b>	101339	<b>Ref. No.</b>	—
	cover cap for piezoelectric igniter			
	<b>GEV No.</b>	106869	<b>Ref. No.</b>	—
	cover cap for piezoelectric igniter ID ø 22mm ED ø 35mm H 25mm			
	<b>GEV No.</b>	107931	<b>Ref. No.</b>	—
	cover cap for piezoelectric igniter ID ø 21mm ED ø 36mm			

### ignition units



<b>GEV No.</b>	102485	<b>Ref. No.</b>	RC00862000 RCK6041059
<b>description</b>	ignition unit outputs 2 220-240VAC 0.6VA 50-60Hz		



gas components

			
<b>1</b>			
<b>GEV No.</b>	101002	<b>Ref. No.</b>	00862
<b>description</b>	ignition unit outputs 2 230VAC dimensions 88x23x34mm mounting distance 73mm inlet F6.3x0.8 outlet F2.8x0.8 0.6VA 50/60Hz		

## thermocouples

### plug-in thermocouples

### plug-in thermocouples standard

with barrel socket  $\varnothing 6(6.5)$ mm

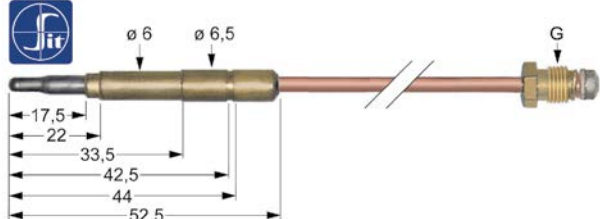
			
<b>1</b>			
<b>GEV No.</b>	107605	<b>Ref. No.</b>	RC01483000
<b>description</b>	thermocouple SIT M8x1 L 1500mm plug connection $\varnothing 6.0(6.5)$ mm		

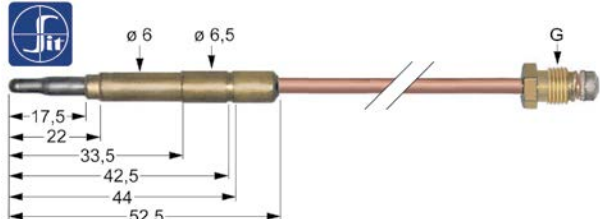
			
<b>1</b>			
<b>GEV No.</b>	107613	<b>Ref. No.</b>	RC40400100
<b>description</b>	thermocouple SIT M9x1 L 1200mm plug connection $\varnothing 6.0(6.5)$ mm		

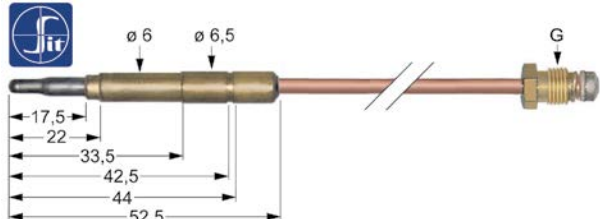
			
<b>1</b>			
<b>GEV No.</b>	107609	<b>Ref. No.</b>	00118 RC00118000
<b>description</b>	thermocouple SIT M9x1 L 600mm plug connection $\varnothing 6.0(6.5)$ mm		

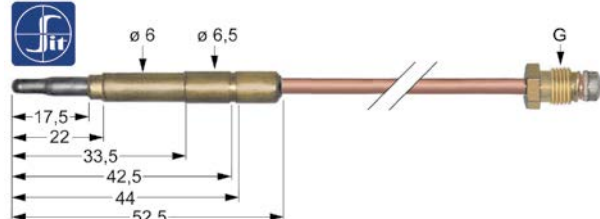

			
<b>1</b>			
<b>GEV No.</b>	107611	<b>Ref. No.</b>	RC40400110 RCK6010057
<b>description</b>	thermocouple SIT M9x1 L 850mm plug connection $\varnothing 6.0(6.5)$ mm		



### threaded thermocouples

### threaded thermocouples standard

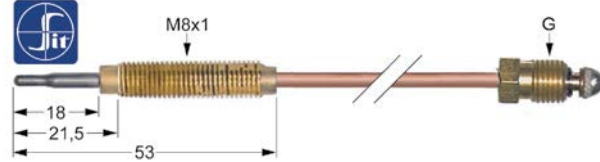
with socket with thread M8x1

SIT

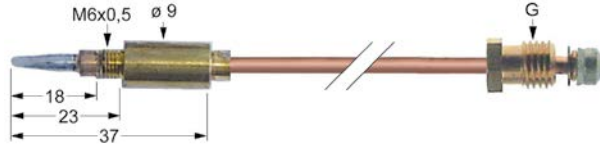
			
<b>1</b>			
<b>GEV No.</b>	107634	<b>Ref. No.</b>	00864 RC00864000
<b>description</b>	thermocouple SIT M8x1 L 1500mm M8x1		
<b>accessories for</b>	107634		
	<b>GEV No.</b>	102067	<b>Ref. No.</b>
			00865 RC00865000
	nut thread M8x1 H 3mm brass Qty 1 pcs type SEF 1		

			
<b>1</b>			
<b>GEV No.</b>	102121	<b>Ref. No.</b>	00367 RC00367000
<b>description</b>	thermocouple M8x1 L 600mm M6x0.5		
<b>accessories for</b>	102121		
	<b>GEV No.</b>	100892	<b>Ref. No.</b>
			—
	thermocouple nut thread M6x0.5 H 6.5mm WS 8 brass Qty 1 pcs		

### accessories

### nuts

			
<b>1</b>			
<b>GEV No.</b>	102067	<b>Ref. No.</b>	00865 RC00865000
<b>description</b>	nut thread M8x1 H 3mm brass Qty 1 pcs type SEF 1		



interrupters

 <p>1</p>			
<b>GEV No.</b>	101265	<b>Ref. No.</b>	RC00460000
<b>description</b>	interrupter thread M9x1		





gas burners





hob burners

universal hob burners

SABAF

1 series

 <p>1</p>			
<b>GEV No.</b>	104288	<b>Ref. No.</b>	00375 RC00375000
<b>description</b>	burner cap 3.6kW ø 120mm		
<b>accessories for</b>	104288		
	<b>GEV No.</b>	104289	<b>Ref. No.</b> 00377 RC00377000
burner lower part 3/3.6kW for burner cap ø 90/120mm			
	<b>GEV No.</b>	105086	<b>Ref. No.</b> —
burner ring 3.6kW for burner cap ø 120mm			
	<b>GEV No.</b>	105087	<b>Ref. No.</b> —
burner head 3.6kW for burner cap ø 120mm			

 <p>1</p>			
<b>GEV No.</b>	104286	<b>Ref. No.</b>	00373 RC00373000
<b>description</b>	burner cap 3kW ø 90mm		
<b>accessories for</b>	104286		
	<b>GEV No.</b>	104289	<b>Ref. No.</b> 00377 RC00377000
burner lower part 3/3.6kW for burner cap ø 90/120mm			
	<b>GEV No.</b>	105089	<b>Ref. No.</b> —
burner ring 3kW for burner cap ø 90mm			
	<b>GEV No.</b>	105090	<b>Ref. No.</b> —
burner head 3kW for burner cap ø 90mm			





 <p>1</p>			
<b>GEV No.</b>	104289	<b>Ref. No.</b>	00377 RC00377000
<b>description</b>	burner lower part 3/3.6kW for burner cap ø 90/120mm		
<b>accessories for</b>	104289		
	<b>GEV No.</b>	104286	<b>Ref. No.</b> 00373 RC00373000
burner cap 3kW ø 90mm			
	<b>GEV No.</b>	104288	<b>Ref. No.</b> 00375 RC00375000
burner cap 3.6kW ø 120mm			
	<b>GEV No.</b>	105086	<b>Ref. No.</b> —
burner ring 3.6kW for burner cap ø 120mm			
	<b>GEV No.</b>	105087	<b>Ref. No.</b> —
burner head 3.6kW for burner cap ø 120mm			
	<b>GEV No.</b>	105089	<b>Ref. No.</b> —
burner ring 3kW for burner cap ø 90mm			
	<b>GEV No.</b>	105090	<b>Ref. No.</b> —
burner head 3kW for burner cap ø 90mm			
	<b>GEV No.</b>	106482	<b>Ref. No.</b> —
gas injector thread M6x0.75 WS 7 bore ø 1.1mm			
	<b>GEV No.</b>	106485	<b>Ref. No.</b> —
gas injector thread M6x0.75 WS 7 bore ø 1.6mm			

producer-specific hob burners



TECNOINOX

650 (1) series



 <p>1</p>			
<b>GEV No.</b>	104288	<b>Ref. No.</b>	00375 RC00375000
<b>description</b>	burner cap 3.6kW ø 120mm		
<b>accessories for</b>	104288		
	<b>GEV No.</b>	104289	<b>Ref. No.</b> 00377 RC00377000
burner lower part 3/3.6kW for burner cap ø 90/120mm			
	<b>GEV No.</b>	105086	<b>Ref. No.</b> —
burner ring 3.6kW for burner cap ø 120mm			
	<b>GEV No.</b>	105087	<b>Ref. No.</b> —
burner head 3.6kW for burner cap ø 120mm			

			
1			
<b>GEV No.</b>	104286	<b>Ref. No.</b>	00373 RC00373000
<b>description</b>	burner cap 3kW ø 90mm		
<b>accessories for</b>	104286		
	<b>GEV No.</b>	104289	<b>Ref. No.</b> 00377 RC00377000
burner lower part 3/3.6kW for burner cap ø 90/120mm			
	<b>GEV No.</b>	105089	<b>Ref. No.</b> —
burner ring 3kW for burner cap ø 90mm			
	<b>GEV No.</b>	105090	<b>Ref. No.</b> —
burner head 3kW for burner cap ø 90mm			





			
1			
<b>GEV No.</b>	104289	<b>Ref. No.</b>	00377 RC00377000
<b>description</b>	burner lower part 3/3.6kW for burner cap ø 90/120mm		
<b>accessories for</b>	104289		
	<b>GEV No.</b>	104286	<b>Ref. No.</b> 00373 RC00373000
burner cap 3kW ø 90mm			
	<b>GEV No.</b>	104288	<b>Ref. No.</b> 00375 RC00375000
burner cap 3.6kW ø 120mm			
	<b>GEV No.</b>	105086	<b>Ref. No.</b> —
burner ring 3.6kW for burner cap ø 120mm			
	<b>GEV No.</b>	105087	<b>Ref. No.</b> —
burner head 3.6kW for burner cap ø 120mm			
	<b>GEV No.</b>	105089	<b>Ref. No.</b> —
burner ring 3kW for burner cap ø 90mm			
	<b>GEV No.</b>	105090	<b>Ref. No.</b> —
burner head 3kW for burner cap ø 90mm			
	<b>GEV No.</b>	106482	<b>Ref. No.</b> —
gas injector thread M6x0.75 WS 7 bore ø 1.1mm			
	<b>GEV No.</b>	106485	<b>Ref. No.</b> —
gas injector thread M6x0.75 WS 7 bore ø 1.6mm			





			
1			
<b>GEV No.</b>	104287	<b>Ref. No.</b>	00374 RC00374000
<b>description</b>	burner ring for burner cap ø 120mm		
<b>accessories for</b>	104287		
	<b>GEV No.</b>	105086	<b>Ref. No.</b> —
burner ring 3.6kW for burner cap ø 120mm			

<b>accessories for</b>	104287		
	<b>GEV No.</b>	105087	<b>Ref. No.</b> —
burner head 3.6kW for burner cap ø 120mm			





			
1			
<b>GEV No.</b>	104285	<b>Ref. No.</b>	00372 RC00372000
<b>description</b>	burner ring ø 90mm for burner cap ø 90mm		
<b>accessories for</b>	104285		
	<b>GEV No.</b>	105089	<b>Ref. No.</b> —
burner ring 3kW for burner cap ø 90mm			
	<b>GEV No.</b>	105090	<b>Ref. No.</b> —
burner head 3kW for burner cap ø 90mm			





650 (2) series





			
1			
<b>GEV No.</b>	105379	<b>Ref. No.</b>	00969 RC00969000
<b>description</b>	air mixing tube		
<b>accessories for</b>	105379		
	<b>GEV No.</b>	105376	<b>Ref. No.</b> 00967 RC00967000
burner cap ø 110mm			
	<b>GEV No.</b>	105377	<b>Ref. No.</b> 00968 RC00968000
burner head for burner cap ø 110mm			
	<b>GEV No.</b>	105378	<b>Ref. No.</b> 00976 RC00976000
burner holder			





			
1			
<b>GEV No.</b>	105376	<b>Ref. No.</b>	00967 RC00967000
<b>description</b>	burner cap ø 110mm		
<b>accessories for</b>	105376		
	<b>GEV No.</b>	105377	<b>Ref. No.</b> 00968 RC00968000
burner head for burner cap ø 110mm			
	<b>GEV No.</b>	105378	<b>Ref. No.</b> 00976 RC00976000
burner holder			
	<b>GEV No.</b>	105379	<b>Ref. No.</b> 00969 RC00969000
air mixing tube			











			
1			
<b>GEV No.</b>	105377	<b>Ref. No.</b>	00968 RC00968000
<b>description</b>	burner head for burner cap ø 110mm		
<b>accessories for</b>	105377		
	<b>GEV No.</b>	105376	<b>Ref. No.</b> 00967 RC00967000
burner cap ø 110mm			
	<b>GEV No.</b>	105378	<b>Ref. No.</b> 00976 RC00976000
burner holder			
	<b>GEV No.</b>	105379	<b>Ref. No.</b> 00969 RC00969000
air mixing tube			

			
1			
<b>GEV No.</b>	105378	<b>Ref. No.</b>	00976 RC00976000
<b>description</b>	burner holder		
<b>accessories for</b>	105378		
	<b>GEV No.</b>	105376	<b>Ref. No.</b> 00967 RC00967000
burner cap ø 110mm			
	<b>GEV No.</b>	105377	<b>Ref. No.</b> 00968 RC00968000
burner head for burner cap ø 110mm			
	<b>GEV No.</b>	105379	<b>Ref. No.</b> 00969 RC00969000
air mixing tube			

700 series			
			
1			
<b>GEV No.</b>	105393	<b>Ref. No.</b>	01142 RC01142000
<b>description</b>	air mixing tube H 44mm ø 20mm suitable for burner 4.5kW		
<b>accessories for</b>	105393		
	<b>GEV No.</b>	105390	<b>Ref. No.</b> 01150 RC01150000
burner cap ø 110mm 4.5kW			
	<b>GEV No.</b>	105391	<b>Ref. No.</b> 01147 RC01147000
burner head for burner cap ø 110mm 4.5kW			
	<b>GEV No.</b>	105392	<b>Ref. No.</b> 01139 RC01139000
venturi suitable for burner 4.5kW			

			
1			
<b>GEV No.</b>	105397	<b>Ref. No.</b>	01143 RC01143000
<b>description</b>	air mixing tube H 48mm ø 22mm suitable for burner 7.2kW		
<b>accessories for</b>	105397		
	<b>GEV No.</b>	105394	<b>Ref. No.</b> 01149 RC01149000
burner cap ø 130mm 7.2kW with central hole			
	<b>GEV No.</b>	105395	<b>Ref. No.</b> 01146 RC01146000
burner head for burner cap ø 130mm 7.2kW			
	<b>GEV No.</b>	105396	<b>Ref. No.</b> 01137 RC01137000
venturi suitable for burner 7.2kW			

			
1			
<b>GEV No.</b>	105389	<b>Ref. No.</b>	01141 RC01141000
<b>description</b>	air mixing tube L 44mm ø 16mm suitable for burner 3.3kW		
<b>accessories for</b>	105389		
	<b>GEV No.</b>	105386	<b>Ref. No.</b> 01151 RC01151000
burner cap ø 75mm 3.3kW			
	<b>GEV No.</b>	105387	<b>Ref. No.</b> 01148 RC01148000
burner head for burner cap ø 75mm 3.3kW			
	<b>GEV No.</b>	105388	<b>Ref. No.</b> 01138 RC01138000
venturi suitable for burner 3.3kW			

			
1			
<b>GEV No.</b>	105390	<b>Ref. No.</b>	01150 RC01150000
<b>description</b>	burner cap ø 110mm 4.5kW		
<b>accessories for</b>	105390		
	<b>GEV No.</b>	105391	<b>Ref. No.</b> 01147 RC01147000
burner head for burner cap ø 110mm 4.5kW			
	<b>GEV No.</b>	105392	<b>Ref. No.</b> 01139 RC01139000
venturi suitable for burner 4.5kW			
	<b>GEV No.</b>	105393	<b>Ref. No.</b> 01142 RC01142000
air mixing tube H 44mm ø 20mm suitable for burner 4.5kW			









			
1			
<b>GEV No.</b>	105394	<b>Ref. No.</b>	01149 RC01149000
<b>description</b>	burner cap ø 130mm 7.2kW with central hole		
<b>accessories for</b>	105394		
	<b>GEV No.</b>	105395	<b>Ref. No.</b> 01146 RC01146000
burner head for burner cap ø 130mm 7.2kW			



Table continues overleaf





<b>accessories for</b> 105394				
	GEV No.	105396	Ref. No.	01137 RC01137000
venturi suitable for burner 7.2kW				
	GEV No.	105397	Ref. No.	01143 RC01143000
air mixing tube H 48mm ø 22mm suitable for burner 7.2kW				





				
<b>GEV No.</b>	105386	<b>Ref. No.</b>	01151 RC01151000	
<b>description</b>	burner cap ø 75mm 3.3kW			
<b>accessories for</b> 105386				
	GEV No.	105387	Ref. No.	01148 RC01148000
burner head for burner cap ø 75mm 3.3kW				
	GEV No.	105388	Ref. No.	01138 RC01138000
venturi suitable for burner 3.3kW				
	GEV No.	105389	Ref. No.	01141 RC01141000
air mixing tube L 44mm ø 16mm suitable for burner 3.3kW				

				
<b>GEV No.</b>	105391	<b>Ref. No.</b>	01147 RC01147000	
<b>description</b>	burner head for burner cap ø 110mm 4.5kW			
<b>accessories for</b> 105391				
	GEV No.	105390	Ref. No.	01150 RC01150000
burner cap ø 110mm 4.5kW				
	GEV No.	105392	Ref. No.	01139 RC01139000
venturi suitable for burner 4.5kW				
	GEV No.	105393	Ref. No.	01142 RC01142000
air mixing tube H 44mm ø 20mm suitable for burner 4.5kW				





				
<b>GEV No.</b>	105395	<b>Ref. No.</b>	01146 RC01146000	
<b>description</b>	burner head for burner cap ø 130mm 7.2kW			
<b>accessories for</b> 105395				
	GEV No.	105394	Ref. No.	01149 RC01149000
burner cap ø 130mm 7.2kW with central hole				
	GEV No.	105396	Ref. No.	01137 RC01137000
venturi suitable for burner 7.2kW				
	GEV No.	105397	Ref. No.	01143 RC01143000
air mixing tube H 48mm ø 22mm suitable for burner 7.2kW				

				
<b>GEV No.</b>	105387	<b>Ref. No.</b>	01148 RC01148000	
<b>description</b>	burner head for burner cap ø 75mm 3.3kW			
<b>accessories for</b> 105387				
	GEV No.	105386	Ref. No.	01151 RC01151000
burner cap ø 75mm 3.3kW				
	GEV No.	105388	Ref. No.	01138 RC01138000
venturi suitable for burner 3.3kW				
	GEV No.	105389	Ref. No.	01141 RC01141000
air mixing tube L 44mm ø 16mm suitable for burner 3.3kW				

				
<b>GEV No.</b>	105388	<b>Ref. No.</b>	01138 RC01138000	
<b>description</b>	venturi suitable for burner 3.3kW			
<b>accessories for</b> 105388				
	GEV No.	105386	Ref. No.	01151 RC01151000
burner cap ø 75mm 3.3kW				
	GEV No.	105387	Ref. No.	01148 RC01148000
burner head for burner cap ø 75mm 3.3kW				
	GEV No.	105389	Ref. No.	01141 RC01141000
air mixing tube L 44mm ø 16mm suitable for burner 3.3kW				

				
<b>GEV No.</b>	105392	<b>Ref. No.</b>	01139 RC01139000	
<b>description</b>	venturi suitable for burner 4.5kW			
<b>accessories for</b> 105392				
	GEV No.	105390	Ref. No.	01150 RC01150000
burner cap ø 110mm 4.5kW				
	GEV No.	105391	Ref. No.	01147 RC01147000
burner head for burner cap ø 110mm 4.5kW				
	GEV No.	105393	Ref. No.	01142 RC01142000
air mixing tube H 44mm ø 20mm suitable for burner 4.5kW				





			
1			
<b>GEV No.</b>	105396	<b>Ref. No.</b>	01137 RC01137000
<b>description</b>	venturi suitable for burner 7.2kW		
<b>accessories for</b>	105396		
			
GEV No.	105394	Ref. No.	01149 RC01149000
burner cap ø 130mm 7.2kW with central hole			
			
GEV No.	105395	Ref. No.	01146 RC01146000
burner head for burner cap ø 130mm 7.2kW			
			
GEV No.	105397	Ref. No.	01143 RC01143000
air mixing tube H 48mm ø 22mm suitable for burner 7.2kW			

pan supports			
			
1			
<b>GEV No.</b>	210182	<b>Ref. No.</b>	01144 RC01144000
<b>description</b>	pan support W 285mm L 315mm		

			
1			
<b>GEV No.</b>	210155	<b>Ref. No.</b>	00376 RC00376000
<b>description</b>	pan support W 320mm L 530mm		

			
1			
<b>GEV No.</b>	210181	<b>Ref. No.</b>	00970 RC00970000
<b>description</b>	pan support W 330mm L 540mm		

reducers for pan supports			
			
1			
<b>GEV No.</b>	210050	<b>Ref. No.</b>	N/A
<b>description</b>	reducer for pan support L 260mm W 260mm chrome-plated steel suitable for universal		

			
1			
<b>GEV No.</b>	210001	<b>Ref. No.</b>	N/A
<b>description</b>	reducer for pan support L 265mm W 265mm SS suitable for universal		

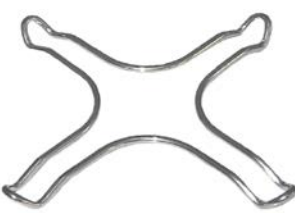
accessories			
reducers for pan supports			
			
1			
<b>GEV No.</b>	210050	<b>Ref. No.</b>	N/A
<b>description</b>	reducer for pan support L 260mm W 260mm chrome-plated steel suitable for universal		

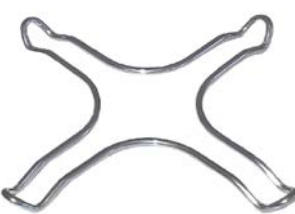
			
1			
<b>GEV No.</b>	210001	<b>Ref. No.</b>	N/A
<b>description</b>	reducer for pan support L 265mm W 265mm SS suitable for universal		



pan supports			
			
1			
<b>GEV No.</b>	210182	<b>Ref. No.</b>	01144 RC01144000
<b>description</b>	pan support W 285mm L 315mm		









			
1			
<b>GEV No.</b>	210155	<b>Ref. No.</b>	00376 RC00376000
<b>description</b>	pan support W 320mm L 530mm		



			
1			
<b>GEV No.</b>	210181	<b>Ref. No.</b>	00970 RC00970000
<b>description</b>	pan support W 330mm L 540mm		





### air mixers

			
1			
<b>GEV No.</b>	105379	<b>Ref. No.</b>	00969 RC00969000
<b>description</b>	air mixing tube		
<b>accessories for</b>	105379		
	<b>GEV No.</b>	105378	<b>Ref. No.</b>
burner holder			00976 RC00976000

			
1			
<b>GEV No.</b>	105393	<b>Ref. No.</b>	01142 RC01142000
<b>description</b>	air mixing tube H 44mm ø 20mm suitable for burner 4.5kW		
<b>accessories for</b>	105393		
	<b>GEV No.</b>	105390	<b>Ref. No.</b>
burner cap ø 110mm 4.5kW			01150 RC01150000
	<b>GEV No.</b>	105391	<b>Ref. No.</b>
burner head for burner cap ø 110mm 4.5kW			01147 RC01147000
	<b>GEV No.</b>	105392	<b>Ref. No.</b>
venturi suitable for burner 4.5kW			01139 RC01139000

			
1			
<b>GEV No.</b>	105397	<b>Ref. No.</b>	01143 RC01143000
<b>description</b>	air mixing tube H 48mm ø 22mm suitable for burner 7.2kW		
<b>accessories for</b>	105397		
	<b>GEV No.</b>	105394	<b>Ref. No.</b>
burner cap ø 130mm 7.2kW with central hole			01149 RC01149000

<b>accessories for</b>	105397		
	<b>GEV No.</b>	105395	<b>Ref. No.</b>
burner head for burner cap ø 130mm 7.2kW			01146 RC01146000
	<b>GEV No.</b>	105396	<b>Ref. No.</b>
venturi suitable for burner 7.2kW			01137 RC01137000

			
1			
<b>GEV No.</b>	105389	<b>Ref. No.</b>	01141 RC01141000
<b>description</b>	air mixing tube L 44mm ø 16mm suitable for burner 3.3kW		
<b>accessories for</b>	105389		
	<b>GEV No.</b>	105386	<b>Ref. No.</b>
burner cap ø 75mm 3.3kW			01151 RC01151000
	<b>GEV No.</b>	105387	<b>Ref. No.</b>
burner head for burner cap ø 75mm 3.3kW			01148 RC01148000
	<b>GEV No.</b>	105388	<b>Ref. No.</b>
venturi suitable for burner 3.3kW			01138 RC01138000

### bar burners

			
1			
<b>GEV No.</b>	105483	<b>Ref. No.</b>	00539 RC00539000
<b>description</b>	bar burner 2 row L 468mm W 200mm ømm H 45mm chargrill		

			
1			
<b>GEV No.</b>	104292	<b>Ref. No.</b>	50000 RC05000000
<b>description</b>	bar burner 2 row L 493mm W 200mm ømm H 45mm chargrill		

			
1			
<b>GEV No.</b>	105408	<b>Ref. No.</b>	01164 RC01164000
<b>description</b>	bar burner 2 row L 510mm W 190mm ømm H 40mm griddle		







			
1			
<b>GEV No.</b>	105475	<b>Ref. No.</b>	RCK2010924
<b>description</b>	bar burner 2 row L 575mm W 225mm ømm H 45mm 11kW chargrill		

			
1			
<b>GEV No.</b>	105776	<b>Ref. No.</b>	RCK7090100
<b>description</b>	bar burner ø 50mm Wmm Hmm L 305mm with bolt M5x12 flange width 52mm convection oven flange ø 75mm		

			
1			
<b>GEV No.</b>	105427	<b>Ref. No.</b>	00117 RC00117000
<b>description</b>	bar burner 2 row L 680mm W 240mm ømm H 260mm salamander grill		

			
1			
<b>GEV No.</b>	105407	<b>Ref. No.</b>	00587 RC00587000
<b>description</b>	bar burner ø 50mm Wmm Hmm L 320mm flange width 72mm pasta cooker flange ø 75mm		

			
1			
<b>GEV No.</b>	104291	<b>Ref. No.</b>	00420 RC00420000
<b>description</b>	bar burner ø 26mm Wmm Hmm L 260mm bain marie		

			
1			
<b>GEV No.</b>	104290	<b>Ref. No.</b>	00366 RC00366000
<b>description</b>	bar burner ø 50mm Wmm Hmm L 390mm tilting bratt pan		

			
1			
<b>GEV No.</b>	105405	<b>Ref. No.</b>	00882 RC00882000
<b>description</b>	bar burner ø 27mm Wmm Hmm L 640mm oven		

			
1			
<b>GEV No.</b>	105775	<b>Ref. No.</b>	RCK7090101
<b>description</b>	bar burner ø 50mm Wmm Hmm L 425mm with bolt M5x12 flange width 52mm convection oven flange ø 75mm		

			
1			
<b>GEV No.</b>	105406	<b>Ref. No.</b>	01134 RC01134000
<b>description</b>	bar burner ø 40mm Wmm Hmm L 520mm flange width 46mm oven flange ø 61mm		

			
1			
<b>GEV No.</b>	211025	<b>Ref. No.</b>	00541 RC00541000
<b>description</b>	chargrill grid L 480mm W 305mm H 14mm		
<b>accessories for</b>	211025		
<b>GEV No.</b>	211098	<b>Ref. No.</b>	RC05001900
<b>description</b>	handle ø 28mm L 89mm thread M10x1 black		



1

<b>GEV No.</b>	211024	<b>Ref. No.</b>	00543 RC00543000
<b>description</b>	lava rock grid L 420mm W 268mm		

## chargrill grids



1

<b>GEV No.</b>	211025	<b>Ref. No.</b>	00541 RC00541000
<b>description</b>	chargrill grid L 480mm W 305mm H 14mm		
<b>accessories for</b>	211025		
	<b>GEV No.</b>	211098	<b>Ref. No.</b> RC05001900
	handle ø 28mm L 89mm thread M10x1 black		

## lava rock grids



1

<b>GEV No.</b>	211024	<b>Ref. No.</b>	00543 RC00543000
<b>description</b>	lava rock grid L 420mm W 268mm		

## tube burners



1

<b>GEV No.</b>	105409	<b>Ref. No.</b>	01184 RC01184000
<b>description</b>	tubular burner L 300mm W 75mm H 42mm for fryer oval		



1

<b>GEV No.</b>	104293	<b>Ref. No.</b>	00440 RC00440000
<b>description</b>	tubular burner ø 74mm L 200mm H 60mm round for fryer		

## solid top burners



1

<b>GEV No.</b>	105398	<b>Ref. No.</b>	01161 RC01161000
<b>description</b>	solid top burner ø 65mm H 102mm L 284mm		

## accessories

## nozzle holders



1

<b>GEV No.</b>	105399	<b>Ref. No.</b>	00414 RC00414000
<b>description</b>	nozzle holder		

## gas nozzles

## main nozzles

## gas nozzles M10x1



1

<b>GEV No.</b>	100477	<b>Ref. No.</b>	01195
<b>description</b>	gas injector thread M10x1 WS 12 bore ø 1.65mm		

## pilot burner nozzles

## pilot burner nozzles POLIDORO



1

<b>GEV No.</b>	106703	<b>Ref. No.</b>	RCK7042008
<b>description</b>	pilot burner nozzle POLIDORO natural gas code 27.2 bore ø 2x0.27mm Qty 1 pcs		



pilot burner nozzles SIT

100 series

1 			
<b>GEV No.</b>	100245	<b>Ref. No.</b>	00435 RC00435000
<b>description</b>	pilot burner nozzle LPG code 20 bore ø 0.2mm Qty 1 pcs thread M8x0.75		

1 			
<b>GEV No.</b>	100246	<b>Ref. No.</b>	00436 RC00436000
<b>description</b>	pilot burner nozzle natural gas bore ø 0.35mm Qty 1 pcs thread M8x0.75		

140/150 series

1 			
<b>GEV No.</b>	100204	<b>Ref. No.</b>	RC01219000
<b>description</b>	pilot burner nozzle SIT LPG code 14 bore ø 0.18/0.20mm Qty 1 pcs suitable for 140 series		



1 			
<b>GEV No.</b>	100207	<b>Ref. No.</b>	RCK7042013
<b>description</b>	pilot burner nozzle SIT natural gas code 27 bore ø 0.40/0.38mm suitable for SIT 140 series		

auxiliary gas parts

screw connections

olives

1  Image not available			
<b>GEV No.</b>	106426	<b>Ref. No.</b>	RCK7070025
<b>description</b>	olive		

1 			
<b>GEV No.</b>	101274	<b>Ref. No.</b>	RCK7070036
<b>description</b>	olive for pipe ø 16mm Qty 1 pcs		
<b>accessories for</b>	101274		
	<b>GEV No.</b>	101275	<b>Ref. No.</b> —
	union screw thread 1/2" for pipe ø 16mm Qty 1 pcs		

union screws

1 			
<b>GEV No.</b>	100906	<b>Ref. No.</b>	RCK7050028
<b>description</b>	screw connection thread M10x1 for ignition electrode brass Qty 1 pcs WS 10		

gas lines

pilot tubes

producer-specific

1 			
<b>GEV No.</b>	106883	<b>Ref. No.</b>	RC00125000 RC0082551
<b>description</b>	pilot tube tube ø 6mm L 245mm copper T1: M10x1 T2: M10x1 with screw connection		

consumables

lava rocks / ceramic briquetts

1 			
<b>GEV No.</b>	211002	<b>Ref. No.</b>	50017 RC05001700
<b>description</b>	lava rocks size ca.40mm Qty 3.3Kg		



## equipment-specific units

### for vegetable slicers

#### miscellaneous



1

<b>GEV No.</b>	110703	<b>Ref. No.</b>	4205 RC00004205
<b>description</b>	cylindrical handle thread M10 ø 28mm L 87mm		

### for cheese graters

#### miscellaneous



1

<b>GEV No.</b>	110703	<b>Ref. No.</b>	4205 RC00004205
<b>description</b>	cylindrical handle thread M10 ø 28mm L 87mm		

### for cream whipping machines

#### spare parts



1

<b>GEV No.</b>	655001	<b>Ref. No.</b>	RC00492000
<b>description</b>	angle piece for cream maker		



1

<b>GEV No.</b>	750219	<b>Ref. No.</b>	RC00003211
<b>description</b>	container lid for cream maker		



1

<b>GEV No.</b>	750220	<b>Ref. No.</b>	RC00003511
<b>description</b>	lid handle for cream maker mounting pos. front		



1

<b>GEV No.</b>	750221	<b>Ref. No.</b>	RC00003011
<b>description</b>	lid handle for cream maker rear		

### decorator tips



1

<b>GEV No.</b>	696411	<b>Ref. No.</b>	RC00087000
<b>description</b>	decorator tip for cream maker L 36mm ID ø 25mm ED ø 29.5mm		
<b>For models:</b>	POLOBAR		

### for grills

#### glass panels



1

<b>GEV No.</b>	693152	<b>Ref. No.</b>	00213 RC00213000
<b>description</b>	glass panel L 280mm W 65mm thickness 4mm rectangular		

### for convection ovens/combi-steamers

#### doors



1

<b>GEV No.</b>	690585	<b>Ref. No.</b>	RCK2011212
<b>description</b>	bush for door mechanism L 35mm ED ø 36mm int. ø 1 31mm int. ø 2 13mm mounting distance 28mm brass		

#### door mechanics

#### miscellaneous





1

<b>GEV No.</b>	690585	<b>Ref. No.</b>	RCK2011212
<b>description</b>	bush for door mechanism L 35mm ED ø 36mm int. ø 1 31mm int. ø 2 13mm mounting distance 28mm brass		



vibration pumps

 <p>1</p>			
<b>GEV No.</b>	500568	<b>Ref. No.</b>	RC01969000
<b>description</b>	vibration pump 230V 32W 50Hz inlet $\phi$ 7 outlet $\phi$ 1/8" IT CEME type E512/A32		
<b>spare parts for</b>	500568		
	<b>GEV No.</b>	390698	<b>Ref. No.</b> —
	thermal fuse switch-off temp. 110°C suitable for ULKA pump		
	<b>GEV No.</b>	520153	<b>Ref. No.</b> —
	bracket rubber dimensions 53x34x28mm		

for toasters

pliers

pliers

 <p>1</p>			
<b>GEV No.</b>	690010	<b>Ref. No.</b>	9014
<b>description</b>	plier for toaster H 180mm total length 100mm		

knobs

universal knobs

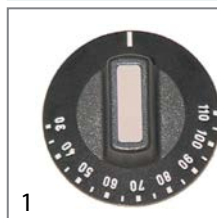
 <p>1</p>			
<b>GEV No.</b>	110241	<b>Ref. No.</b>	00598 RC00598000
<b>description</b>	knob thermostat t.max. 110°C $\phi$ 50mm shaft $\phi$ 6x4.6mm shaft flat upper black temperature range 30-110°C		

producer-specific knobs

TECNOINOX

 <p>1</p>			
<b>GEV No.</b>	110701	<b>Ref. No.</b>	06301 RC00006301
<b>description</b>	knob energyregulator 1-10 + MAX t.max.°C temperature range°C $\phi$ 38mm shaft $\phi$ 6x4.6mm shaft flat upper black		

 <p>1</p>			
<b>GEV No.</b>	110081	<b>Ref. No.</b>	RC05001300
<b>description</b>	knob $\phi$ 70mm shaft $\phi$ 8x6.5mm shaft flat universal		

 <p>1</p>			
<b>GEV No.</b>	110702	<b>Ref. No.</b>	00035 RC00035000
<b>description</b>	knob switch zero mark $\phi$ 40mm shaft $\phi$ 6x4.6mm shaft flat upper black		

 <p>1</p>			
<b>GEV No.</b>	110709	<b>Ref. No.</b>	00086 01113 RC00001113 RC00086000
<b>description</b>	knob switch zero mark t.max.°C temperature range°C $\phi$ 38mm shaft $\phi$ 6x4.6mm shaft flat upper black		

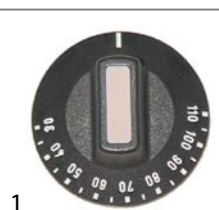
 <p>1</p>			
<b>GEV No.</b>	110241	<b>Ref. No.</b>	00598 RC00598000
<b>description</b>	knob thermostat t.max. 110°C $\phi$ 50mm shaft $\phi$ 6x4.6mm shaft flat upper black temperature range 30-110°C		



1

<b>GEV No.</b>	110708	<b>Ref. No.</b>	00287 RC00287000
<b>description</b>	knob energy regulator 1-6 + MAX t.max.°C temperature range°C ø 60mm shaft ø 6x4.6mm shaft flat left black		



1

<b>GEV No.</b>	110711	<b>Ref. No.</b>	00289 RC00289000
<b>description</b>	knob switch 7-position t.max.°C temperature range°C ø 60mm shaft ø 6x4.6mm shaft flat right black		



1

<b>GEV No.</b>	110716	<b>Ref. No.</b>	00538 RC00538000
<b>description</b>	knob gas tap with ignition flame t.max.°C temperature range°C ø 60mm shaft ø 8x6.5mm shaft flat lower black		



1

<b>GEV No.</b>	110715	<b>Ref. No.</b>	00280 RC00280000
<b>description</b>	knob thermostat t.max. 190°C temperature range 10x9°C ø 60mm shaft ø 6x4.6mm shaft flat right black		



1

<b>GEV No.</b>	110710	<b>Ref. No.</b>	00401 RC00401000
<b>description</b>	knob gas tap without ignition flame t.max.°C temperature range°C ø 60mm shaft ø 8x6.5mm shaft flat lower black		



1

<b>GEV No.</b>	110707	<b>Ref. No.</b>	00495 RC00495000
<b>description</b>	knob thermostat t.max. 275°C temperature range 50-275°C ø 59mm shaft ø 6x4.6mm shaft flat right rotation 270° black		



1

<b>GEV No.</b>	110714	<b>Ref. No.</b>	00448 RC00448000
<b>description</b>	knob gas thermostat 1-7 t.max.°C temperature range°C ø 60mm shaft ø 8x6.5mm shaft flat lower black		



1

<b>GEV No.</b>	110713	<b>Ref. No.</b>	00284 RC00284000
<b>description</b>	knob thermostat t.max. 310°C temperature range 100-310°C ø 60mm shaft ø 6x4.6mm shaft flat right black		



1

<b>GEV No.</b>	110938	<b>Ref. No.</b>	00917 RC00917000
<b>description</b>	knob gas thermostat t.max. 260°C ø 60mm shaft ø 8x6.5mm shaft flat lower black		





1

<b>GEV No.</b>	110712	<b>Ref. No.</b>	00268 RC00268000
<b>description</b>	knob thermostat t.max. 90°C temperature range 30-90°C ø 60mm shaft ø 6x4.6mm shaft flat right rotation 270° black		





 <p>1</p>			
<b>GEV No.</b>	110706	<b>Ref. No.</b>	00494 RC00494000
<b>description</b>	knob time 50min ø 60mm shaft ø 6x4.6mm shaft flat right black		

 <p>1</p>			
<b>GEV No.</b>	110940	<b>Ref. No.</b>	01059 RC01059000
<b>description</b>	knob oven BH/TH/BH+TH ø 70mm shaft ø 6x4.6mm shaft flat right blue		

 <p>1</p>			
<b>GEV No.</b>	110937	<b>Ref. No.</b>	01070 RC01070000
<b>description</b>	knob energy regulator 1-6 + MAX ø 70mm shaft ø 6x4.6mm shaft flat left blue		

 <p>1</p>			
<b>GEV No.</b>	110944	<b>Ref. No.</b>	01249 RC01249000
<b>description</b>	knob switch 4-position ø 70mm shaft ø 6x4.6mm shaft flat left blue		

 <p>1</p>			
<b>GEV No.</b>	110943	<b>Ref. No.</b>	01172 RC01172000
<b>description</b>	knob gas thermostat 1-7 ø 70mm shaft ø 8x6.5mm shaft flat lower blue		

 <p>1</p>			
<b>GEV No.</b>	110936	<b>Ref. No.</b>	01109 RC01109000
<b>description</b>	knob switch 7-position ø 70mm shaft ø 6x4.6mm shaft flat right blue		

 <p>1</p>			
<b>GEV No.</b>	110939	<b>Ref. No.</b>	01152 RC01152000
<b>description</b>	knob gas thermostat t.max. 290°C temperature range 150-290°C ø 70mm shaft ø 8x6.5mm shaft flat upper blue		

 <p>1</p>			
<b>GEV No.</b>	110946	<b>Ref. No.</b>	01121 RC01121000
<b>description</b>	knob thermostat t.max. 190°C temperature range 100-190°C ø 70mm shaft ø 6x4.6mm shaft flat right blue		

 <p>1</p>			
<b>GEV No.</b>	110732	<b>Ref. No.</b>	01011 RC01011000
<b>description</b>	knob graduated ø 70mm shaft ø 6x4.6mm shaft flat left blue		

 <p>1</p>			
<b>GEV No.</b>	110942	<b>Ref. No.</b>	01079 RC01079000
<b>description</b>	knob thermostat t.max. 300°C temperature range 100-300°C ø 70mm shaft ø 6x4.6mm shaft flat right rotation 270° blue		



1

<b>GEV No.</b>	110941	<b>Ref. No.</b>	01060 RC01060000
<b>description</b>	knob thermostat t.max. 300°C temperature range 60-300°C ø 70mm shaft ø 6x4.6mm shaft flat right rotation 270° blue		



1

<b>GEV No.</b>	110945	<b>Ref. No.</b>	01085 RC01085000
<b>description</b>	knob thermostat t.max. 90°C temperature range 30-90°C ø 70mm shaft ø 6x4.6mm shaft flat right blue		

mushroom cap handles



1

<b>GEV No.</b>	110705	<b>Ref. No.</b>	00323 RC00323000
<b>description</b>	mushroom cap handle thread M5 handle ø 25mm L 19mm plastic black		

bracket handles



1

<b>GEV No.</b>	700551	<b>Ref. No.</b>	3101 70501611 RC00003101
<b>description</b>	pull handle L 200mm H 62mm mounting distance 179mm handle M8		

handles and hand wheels

cylindrical handles

fixed



1

<b>GEV No.</b>	110703	<b>Ref. No.</b>	4205 RC00004205
<b>description</b>	cylindrical handle thread M10 ø 28mm L 87mm		

lever handles



1

<b>GEV No.</b>	211098	<b>Ref. No.</b>	RC05001900
<b>description</b>	handle ø 28mm L 89mm thread M10x1 black		

cone handles



1

<b>GEV No.</b>	110704	<b>Ref. No.</b>	00329 RC00329000
<b>description</b>	cone handle thread M6 ø 16mm L 25mm plastic black		

locks

handle latches

producer-specific

TECNOINOX



1

<b>GEV No.</b>	694067	<b>Ref. No.</b>	RC01940000
<b>description</b>	door catch with spigot 1-stage L 26mm total length 51mm thread M8		





espagnolette locks

universal



1	<b>GEV No.</b> 690041	<b>Ref. No.</b> RCK5900121
<b>description</b>	cam L 148mm mounting distance 32mm	



1	<b>GEV No.</b> 690040	<b>Ref. No.</b> RCK5900122
<b>description</b>	door catch with roller H 42mm L 40mm W 40mm zinc die cast mounting distance 26mm type 0751 series	



1	<b>GEV No.</b> 700771	<b>Ref. No.</b> RCK5900123
<b>description</b>	latch gear opening to the left shaft intake ø 8x8mm L 170mm W 40mm H 40mm	

hinges

oven hinges

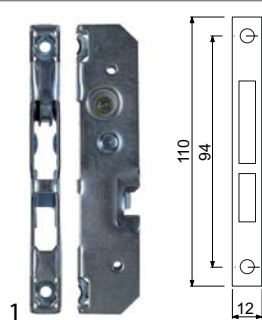

1	<b>GEV No.</b> 700003	<b>Ref. No.</b> 00804 RC00804000
<b>description</b>	opposite support L 110mm W 12mm mounting distance 94mm	



1	<b>GEV No.</b> 690496	<b>Ref. No.</b> 00940 RC00940000
<b>description</b>	oven hinge mounting distance 118mm lug mounting 13mm lever length 119mm groove distance 12mm spring thickness 3.5mm mounting ear position left spring length 59mm mounting pos. W 21mm	





1	<b>GEV No.</b> 690498	<b>Ref. No.</b> 00802 RC00802000
<b>description</b>	oven hinge mounting distance 118mm lug mounting 13mm lever length 119mm groove distance 12mm spring thickness 4mm mounting ear position right spring length 59mm L 155mm W 21mm	
<b>accessories for</b>	690498	
	<b>GEV No.</b> 700003	<b>Ref. No.</b> 00804 RC00804000
<b>description</b>	opposite support L 110mm W 12mm mounting distance 94mm	





1	<b>GEV No.</b> 694505	<b>Ref. No.</b> 00803 RC00803000
<b>description</b>	oven hinge mounting distance 118mm mounting distance 2mm lug mounting 13mm lever length 125mm groove distance 12mm spring thickness 4mm mounting ear position left spring length 59mm L 155mm W 21mm with hook	

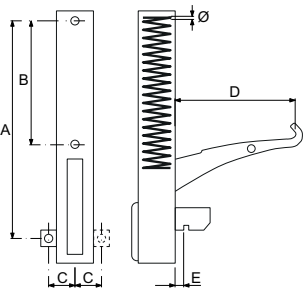

1	<b>GEV No.</b> 690495	<b>Ref. No.</b> 00939 RC00939000
<b>description</b>	oven hinge mounting distance 118mm spring thickness 3.5mm spring length 59mm L 155mm mounting pos. right W 22mm C 13mm D 119mm	

			
<b>GEV No.</b>	700006	<b>Ref. No.</b>	01067 RC01067000
<b>description</b>	oven hinge mounting distance 173mm mounting distance 2 105mm lug mounting 14mm lever length 120mm groove distance 11mm spring thickness 3.5mm mounting ear position left spring length 112mm W 25mm		
<b>accessories for</b>	700006		
			
<b>GEV No.</b>	700001	<b>Ref. No.</b>	—
<b>description</b>	opposite support L 118mm W 17mm mounting distance 94mm		
			
<b>GEV No.</b>	700007	<b>Ref. No.</b>	01068 RC01068000
<b>description</b>	oven hinge mounting distance 173mm mounting distance 2 105mm lug mounting 14mm lever length 120mm groove distance 11mm spring thickness 3.5mm mounting ear position right spring length 112mm W 25mm		

			
			
<b>GEV No.</b>	700007	<b>Ref. No.</b>	01068 RC01068000
<b>description</b>	oven hinge mounting distance 173mm mounting distance 2 105mm lug mounting 14mm lever length 120mm groove distance 11mm spring thickness 3.5mm mounting ear position right spring length 112mm W 25mm		
<b>accessories for</b>	700007		
			
<b>GEV No.</b>	700001	<b>Ref. No.</b>	—
<b>description</b>	opposite support L 118mm W 17mm mounting distance 94mm		

## fittings for catering equipment

### inlet taps

			
<b>GEV No.</b>	514048	<b>Ref. No.</b>	00583 RC00583000
<b>description</b>	ball valve connection 1/2" complete total length 55mm mounting pos. any brass H 30mm L 55mm rosette ø 70mm rosette thread G2 M22x1		
<b>spare parts for</b>	514048		
			
<b>GEV No.</b>	540871	<b>Ref. No.</b>	—
<b>description</b>	lever handle cold water suitable for intake tap		

## baskets

### fryer baskets

#### TECNOINOX

			
<b>GEV No.</b>	970188	<b>Ref. No.</b>	00024 RC00024000
<b>description</b>	fryer basket L1 245mm W1 130mm H1 100mm		
			
<b>GEV No.</b>	970194	<b>Ref. No.</b>	00055 RC00055000
<b>description</b>	fryer basket L1 245mm W1 220mm H1 100mm		





1

<b>GEV No.</b>	970139	<b>Ref. No.</b>	00678 RC00678000
<b>description</b>	fryer basket L1 265mm W1 210mm H1 105mm L2 480mm H2 147mm H3 205mm chrome-plated steel		



1

<b>GEV No.</b>	970420	<b>Ref. No.</b>	RC01295000
<b>description</b>	fryer basket L1 290mm W1 105mm H1 120mm L2 490mm H2 170mm H3 200mm chrome-plated steel		



1

<b>GEV No.</b>	970147	<b>Ref. No.</b>	00076 RC00076000
<b>description</b>	fryer basket L1 290mm W1 220mm H1 100mm L2 540mm H2 230mm H3 175mm chrome-plated steel		

pasta baskets

TECNOINOX



1

<b>GEV No.</b>	970387	<b>Ref. No.</b>	00606 RC00606000
<b>description</b>	pasta basket H1 200mm W1 290mm L1 145mm H3 343mm stainless steel		
<b>accessories for</b>	970387		
	<b>GEV No.</b>	691314	<b>Ref. No.</b> —
	cylindrical handle thread M8 ø 28mm L 86mm		



1

<b>GEV No.</b>	970388	<b>Ref. No.</b>	00603 RC00603000
<b>description</b>	pasta basket H1 200mm W1 290mm L1 290mm H3 340mm stainless steel		



1

<b>GEV No.</b>	970385	<b>Ref. No.</b>	00605 RC00605000
<b>description</b>	pasta basket left H1 200mm W1 145mm L1 145mm H3 340mm stainless steel		



1

<b>GEV No.</b>	970386	<b>Ref. No.</b>	00604 RC00604000
<b>description</b>	pasta basket right H1 200mm W1 145mm L1 145mm H3 340mm stainless steel		

gaskets

gaskets for heated units

door seals

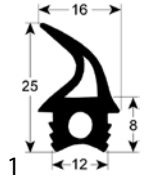

1

<b>GEV No.</b>	902409	<b>Ref. No.</b>	RCK7070100
<b>description</b>	door seal profile 2714 Qty supplied by meter suitable for GIORIK		

1

<b>GEV No.</b>	900439	<b>Ref. No.</b>	RCK7070166
<b>description</b>	door seal profile 2750 Qty supplied by meter		

door seals with fixing hook

1

<b>GEV No.</b>	901434	<b>Ref. No.</b>	RC70044040
<b>description</b>	door seal W 600mm with 6 mounting clips H 400mm		

1

<b>GEV No.</b>	901371	<b>Ref. No.</b>	RC70044030
<b>description</b>	oven gasket L 540mm W 390mm with 6 mounting clips		

O-rings

EPDM

1

<b>GEV No.</b>	529545	<b>Ref. No.</b>	RC00002611
<b>description</b>	O-ring EPDM thickness 1.78mm ID ø 10.82mm Qty 1 pcs		
<b>For models:</b>	POLOBAR		

1

<b>GEV No.</b>	532011	<b>Ref. No.</b>	RC00009011
<b>description</b>	O-ring EPDM thickness 1.78mm ID ø 17.17mm Qty 10 pcs		
<b>For models:</b>	POLOBAR		

1

<b>GEV No.</b>	510824	<b>Ref. No.</b>	RC00007811
<b>description</b>	O-ring EPDM thickness 1.78mm ID ø 20.35mm Qty 1 pcs		

1

<b>GEV No.</b>	532014	<b>Ref. No.</b>	RC00003315
<b>description</b>	O-ring EPDM thickness 1.78mm ID ø 21.95mm Qty 10 pcs		
<b>For models:</b>	POLOBAR		

1

<b>GEV No.</b>	532003	<b>Ref. No.</b>	RC00009511
<b>description</b>	O-ring EPDM thickness 1.78mm ID ø 3.69mm Qty 10 pcs		

1

<b>GEV No.</b>	510177	<b>Ref. No.</b>	RC00008711
<b>description</b>	O-ring EPDM thickness 1.78mm ID ø 7.66mm Qty 1 pcs		
<b>For models:</b>	POLOBAR		

1

<b>GEV No.</b>	532050	<b>Ref. No.</b>	RC00008911
<b>description</b>	O-ring EPDM thickness 2.62mm ID ø 11.91mm Qty 10 pcs		
<b>For models:</b>	POLOBAR		



1

<b>GEV No.</b>	532053	<b>Ref. No.</b>	RC00008012
<b>description</b>	O-ring EPDM thickness 2.62mm ID $\phi$ 15.88mm Qty 10 pcs		

1

<b>GEV No.</b>	511513	<b>Ref. No.</b>	RC00009711
<b>description</b>	O-ring EPDM thickness 2.62mm ID $\phi$ 20.24mm Qty 10 pcs		

1

<b>GEV No.</b>	532081	<b>Ref. No.</b>	RC00007211
<b>description</b>	O-ring EPDM thickness 2.62mm ID $\phi$ 60mm Qty 10 pcs		

1

<b>GEV No.</b>	532118	<b>Ref. No.</b>	RCK6090145
<b>description</b>	O-ring EPDM thickness 3.53mm ID $\phi$ 55.56mm Qty 10 pcs		

### shaft gaskets

#### shaft gaskets

1

<b>GEV No.</b>	550549	<b>Ref. No.</b>	RCK7070150
<b>description</b>	shaft sealing for fan motor		

1

<b>GEV No.</b>	550550	<b>Ref. No.</b>	RCK7070151
<b>description</b>	shaft sealing for fan motor		

## fittings, hose and pipe connectors

### fittings

#### angle pieces

1

<b>GEV No.</b>	520824	<b>Ref. No.</b>	RCK7050374
<b>description</b>	angle piece thread 1/8" ET - 1/8" IT nickel-plated brass		

### push-in fittings

#### JOHN GUEST

1

<b>GEV No.</b>	520494	<b>Ref. No.</b>	RC01922000	
<b>description</b>	push-in fitting John Guest angled pipe connection $\phi$ 10mm - $\phi$ 10mm			
<b>accessories for</b>	520494			
	<b>GEV No.</b>	520973	<b>Ref. No.</b>	—
	hose John Guest thickness 1.5mm LLDPE blue ID $\phi$ 7mm ED $\phi$ 10mm			

1

<b>GEV No.</b>	520495	<b>Ref. No.</b>	RC01927000	
<b>description</b>	push-in fitting John Guest straight thread 1/8" BSP stub $\phi$ 8mm			
<b>accessories for</b>	520495			
	<b>GEV No.</b>	520971	<b>Ref. No.</b>	—
	hose thickness 1mm LLDPE blue ID $\phi$ 4mm ED $\phi$ 6mm operating pressure at 20°C 16bar			



## valves and tank inlets

## ball valves

universal

ball valves with lever handle



1

<b>GEV No.</b>	540758	<b>Ref. No.</b>	00579 RC00579000
<b>description</b>	ball valve connection 1" IT - 1" ET DN25 total length 90mm with lever handle handle length 95mm		

## fastening material

## nuts

hexagonal nuts

hexagonal nuts metric (without norm)



1

<b>GEV No.</b>	102067	<b>Ref. No.</b>	00865 RC00865000
<b>description</b>	nut thread M8x1 H 3mm brass Qty 1 pcs type SEF 1		

## consumables

## lava rocks / ceramic briquettes



1

<b>GEV No.</b>	211002	<b>Ref. No.</b>	50017 RC05001700
<b>description</b>	lava rocks size ca.40mm Qty 3.3Kg		

## fuses

## fine fuses

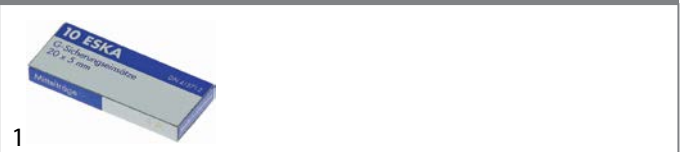

1

<b>GEV No.</b>	358677	<b>Ref. No.</b>	RC01861000
<b>description</b>	fine fuse size ø5x20mm 4A fast-acting rated 250V Qty 10 pcs		

<b>A</b>			
alarm devices	19	heating elements for convection	8
audible timers	19	heating elements for fryers	3
axial fans	22	heating elements for frying pans	3
<b>B</b>		heating elements for griddles	5
ball valves	54	heating elements for ovens	3
bar burners	40	heating elements for pasta cookers	6
<b>C</b>		heating elements for salamanders/toasters	6
cable glands	23	hexagonal nuts	54
cables	23	hob burners	35
cam switches	14	hot air fans	22
ceramic heaters	7	hot air motors	22
condensators & interference suppression filters	23	hot plates	9
consumables	54	<b>I</b>	
contactors	19	ignition boxes	27
control equipment	15	ignition cables	33
control thermostats	10	ignition units	33
<b>D</b>		immersion heating elements	8
door seals	51	indicator lights	16
door seals with fixing hook	52	indicator lights (complete)	16
<b>E</b>		infrared lamps	17
electric accessories	23	<b>L</b>	
electric timers	18	lamps	16
energy regulators	10	lava rocks / ceramic briquetts	43, 54
espagnolette locks	49	light bulbs	16
<b>F</b>		linear lamps	17
fans	22	<b>M</b>	
fastening material	54	mechanical timers	18
filters	23	microswitches	14
fine fuses	54	<b>N</b>	
fittings	53	nuts	54
fuses	23, 54	<b>O</b>	
<b>G</b>		operating capacitors	23
gas burners	35	O-rings	52
gas control valves	27	oven hinges	49
gas lines	43	oven lamps	17
gas nozzles	42	<b>P</b>	
gas taps	24	piezoelectric igniters	33
gas thermostats	25	pilot burners	28
gaskets for heated units	51	pressure switches	22
<b>H</b>		probe clips	13
halogen lamp	17	probes	20
heating elements	3	pumps	23
heating elements for bain maries	3	push/momentary push switches	14
heating elements for charrills	6	push-in fittings	53
		<b>R</b>	
		radiation heaters	8

relays	20
rocker/momentary rocker switches	13
rotary switches	15

**S**

safety thermostats	12
shaft gaskets	53
solenoid valves	21
solid top burners	42
spring clips	13
switches and momentary switches	13

**T**

temperature probes	20
terminals	24
thermocouples	34
thermostats	10
threaded cable glands	23
time relays	20
timers	18
transformers	20
tube burners	42

**U**

universal probes	20
------------------	----

**V**

valves and tank inlets	54
vibration pumps	23