



GAS COMPONENTS



ELECTRIC COMPONENTS



WATER TECHNOLOGY



MECHANICAL COMPONENTS



TOOLS

Spare parts suitable for

TEIKOS

Find the complete and up-to-date range of products in our GEV Webshop



Manufacturer catalogue

The most important spare parts and accessories arranged clearly for every manufacturer

- ✓ Complete product range and all appliance data always up to date in the GEV Webshop
- ✓ Alphabetical Index at the end of the catalogue

GEV Webshop

www.gev-online.co.uk

www.gev-online.com



- 🔍 Add to Favourites
- 🔍 Sign In with email address and usual password
- 🔍 Easy-order – place several items in your basket at the same time
- 🔍 Quick Item search – no login needed



heating elements

immersion heating elements

3 hole flange ø47.5mm

GEV No.	415259	Ref. No.	843511
description	heating element 4500W 230V mounting ø 47.5mm heating circuits 3 L 370mm W 31mm H 40mm number of thermostat sleeves 1 thermostat sleeves ø 7.5mm length thermostat sleeves 240mm thermostat sleeve centre not clinging tube ø 8.5mm hole distance 64mm hole ø 8mm connection male faston 6.3mm 3 hole flange immersion heater		
spare parts for	415259		
	GEV No.	510408	Ref. No. —
	O-ring EPDM thickness 5.34mm ID ø 47mm Qty 1 pcs		
accessories for	415259		
	GEV No.	510562	Ref. No. —
	O-ring silicone thickness 5.34mm ID ø 47mm Qty 1 pcs		

GEV No.	418681	Ref. No.	843515
description	heating element 6000W 230V mounting ø 47.5mm heating circuits 3 L 370mm W 32mm H 36mm number of thermostat sleeves 1 thermostat sleeves ø 8mm length thermostat sleeves 240mm thermostat sleeve upper centre not clinging tube ø 6mm hole distance 62mm hole ø 8mm connection male faston 6.3mm 3 hole flange immersion heater		
spare parts for	418681		
	GEV No.	510408	Ref. No. —
	O-ring EPDM thickness 5.34mm ID ø 47mm Qty 1 pcs		
accessories for	418681		
	GEV No.	510562	Ref. No. —
	O-ring silicone thickness 5.34mm ID ø 47mm Qty 1 pcs		

GEV No.	415258	Ref. No.	843512
description	heating element 2700W 230V mounting ø 47.5mm thermostat sleeve eccentric immersion heater		
accessories for	415258		
	GEV No.	510408	Ref. No. —
	O-ring EPDM thickness 5.34mm ID ø 47mm Qty 1 pcs		

accessories for	415258		
	GEV No.	521012	Ref. No. —
	gasket graphite ED ø 15mm ID ø 5mm thickness 1.2mm Qty 1 pcs		

GEV No.	418217	Ref. No.	843514
description	heating element 2500W 230V mounting ø 47.5mm heating circuits 1 L 240mm W 30mm H 30mm number of thermostat sleeves 1 thermostat sleeves ø 7mm length thermostat sleeves 205mm thermostat sleeve upper tube ø 6.5mm hole distance 60mm hole ø 10mm connection male faston 6.3mm 3 hole flange immersion heater		
spare parts for	418217		
	GEV No.	510408	Ref. No. —
	O-ring EPDM thickness 5.34mm ID ø 47mm Qty 1 pcs		
accessories for	418217		
	GEV No.	510408	Ref. No. —
	O-ring EPDM thickness 5.34mm ID ø 47mm Qty 1 pcs		
	GEV No.	510562	Ref. No. —
	O-ring silicone thickness 5.34mm ID ø 47mm Qty 1 pcs		

with compression flange 50 x 26mm

GEV No.	415049	Ref. No.	843501
description	heating element 2700W 220V heating circuits 1 compression flange flange 50x26mm L 273mm W 98mm H 23mm L1 50mm L2 223mm W1 30mm W2 33mm connection male faston 6.3mm cable length 100mm tube ø 6.3mm connection length 55mm immersion heater		
accessories for	415049		
	GEV No.	510387	Ref. No. —
	gasket L 46mm W 22mm ømm EPDM for heating element for flange 50x26mm		
	GEV No.	510388	Ref. No. —
	counterflange ømm hole distance mm perforation ømm L 43mm W 21mm SS for heating element for flange 50x26mm		

GEV No.	419213	Ref. No.	843500
description	heating element 2000W 230V L 345mm W 30mm W1 115mm tube ø 7mm		
For models:	TS80		



accessories

sealing washers

O-rings

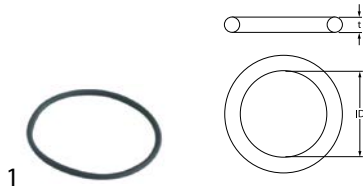

GEV No.	528902	Ref. No.	839701
----------------	--------	-----------------	--------

description O-ring EPDM thickness 3.53mm ID ø 66.27mm Qty 1 pcs

IMIT / TEMPOMATIC / ARTHERMO

control thermostats



GEV No.	375403	Ref. No.	843630
----------------	--------	-----------------	--------

description thermostat t.max. 90°C temperature range 30-90°C 1-pole 1CO 15A probe ø 6mm probe L 90mm capillary pipe 1500mm capillary pipe isolated 1400mm gland nut shaft ø 6x4.6mm shaft L 15mm shaft position upper rotation 270° probe material SS

thermostats

control and safety thermostats

EGO

control thermostats

55.10/19_ series

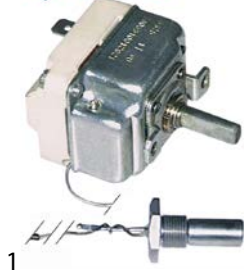

GEV No.	390065	Ref. No.	843621 843625
----------------	--------	-----------------	------------------

description thermostat t.max. 90°C temperature range 30-90°C 1-pole 1CO 16A probe ø 11mm probe L 28mm capillary pipe 1000mm capillary pipe isolated 1000mm gland nut shaft ø 6x4.6mm shaft L 23mm shaft position upper rotation 270° screw-in probe probe thread M14x1

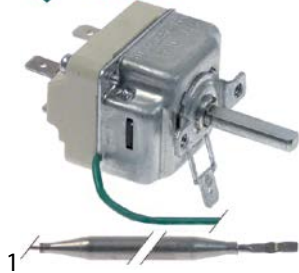

GEV No.	390040	Ref. No.	843601
----------------	--------	-----------------	--------

description thermostat t.max. 90°C temperature range 30-90°C 1-pole 1CO 16A probe ø 6mm probe L 130mm capillary pipe 2040mm capillary pipe isolated 1940mm gland nut shaft ø 6x4.6mm shaft L 23mm shaft position upper rotation 270° probe material SS

switches and momentary switches

rocker/momentary rocker switches

30x22mm



GEV No.	301036	Ref. No.	844600
----------------	--------	-----------------	--------

description protective cover internal size 30x22mm for rocker switch mounting measurementsmm



GEV No.	346474	Ref. No.	829533
----------------	--------	-----------------	--------

description dummy element external size 30x22mm suitable for rocker switch



GEV No.	301078	Ref. No.	844507
----------------	--------	-----------------	--------

description momentary rocker switch mounting measurements 30x22mm black 2NO 250V 16A momentary 0-I connection male faston 6.3mm ambient temperature max. 85/125°C protection IP40

accessories for 301078



GEV No.	301036	Ref. No.	844600
----------------	--------	-----------------	--------

protective cover internal size 30x22mm for rocker switch mounting measurementsmm

blank



GEV No.	345983	Ref. No.	844103
----------------	--------	-----------------	--------

description momentary rocker switch mounting measurements 30x22mm green 2NO 250V 16A illuminated 0-I connection male faston 6.3mm ambient temperature max. 85°C protection IP65 with cover cap



accessories for 345983



GEV No.	301036	Ref. No.	844600
----------------	--------	-----------------	--------

protective cover internal size 30x22mm for rocker switch mounting measurementsmm







 <p>1</p>			
GEV No.	346297	Ref. No.	844307
description	rocker switch mounting measurements 30x22mm orange 2NO 230V 16A illuminated connection male faston 6.3mm ambient temperature max. 125/55°C protection IP65		
accessories for	346297		
	GEV No.	301036	Ref. No. 844600
	protective cover internal size 30x22mm for rocker switch mounting measurementsmm		





push/momentary push switches

28.5x52.6mm

 <p>1</p>			
GEV No.	347441	Ref. No.	844107
description	double momentary switch mounting measurements 28.5x52.6mm black/green 1NO/indicator light 250V 16A washing cycle connection male faston 6.3mm ambient temperature max. 85°C protection IP40		

 <p>1</p>			
GEV No.	347853	Ref. No.	844509
description	double momentary switch mounting measurements 28.5x52.6mm black/yellow 1NO/indicator light 250V 16A drain pump connection male faston 6.3mm ambient temperature max. 150/75°C		
spare parts for	347853		
	GEV No.	345130	Ref. No. —
	momentary switch unit 1NO 250V 16A connection male faston 6.3mm		
	GEV No.	345601	Ref. No. —
	indicator lamp holder V ø 11mm		
	GEV No.	345602	Ref. No. —
	element holder double mounting measurements 28.5x52.6mm black for push buttons 23x23mm		
	GEV No.	346246	Ref. No. —
	indicator light lens size 23x23mm yellow		
	GEV No.	359350	Ref. No. —
	indicator light 230V blue connection male faston 6.3mm ø 11mm		

 <p>1</p>			
GEV No.	347852	Ref. No.	844109
description	switch combination mounting measurements 28.5x52.6mm black 2CO 250V 16A clock connection male faston 6.3mm ambient temperature max. 85°C		
spare parts for	347852		
	GEV No.	345602	Ref. No. —
	element holder double mounting measurements 28.5x52.6mm black for push buttons 23x23mm		
	GEV No.	345612	Ref. No. —
	blank size 23x23mm black		
	GEV No.	346231	Ref. No. —
	push button size 23x23mm black timer with lens		

 <p>1</p>			
GEV No.	347851	Ref. No.	844113
description	switch combination mounting measurements 28.5x52.6mm black/blue 2NO/indicator light 250V 16A regeneration connection male faston 6.3mm ambient temperature max. 150/75°C protection IP40		
spare parts for	347851		
	GEV No.	345601	Ref. No. —
	indicator lamp holder V ø 11mm		
	GEV No.	345602	Ref. No. —
	element holder double mounting measurements 28.5x52.6mm black for push buttons 23x23mm		
	GEV No.	345720	Ref. No. —
	switch 2NO 250V 16A connection male faston 6.3mm		
	GEV No.	346248	Ref. No. —
	indicator light lens size 23x23mm blue		
	GEV No.	359350	Ref. No. —
	indicator light 230V blue connection male faston 6.3mm ø 11mm		

 <p>1</p>			
GEV No.	347440	Ref. No.	844309
description	switch combination mounting measurements 28.5x52.6mm black/yellow 2NO/indicator light 250V 16A with indicator main switch connection male faston 6.3mm ambient temperature max. 85°C protection IP40		



30x22mm			
			
1			
GEV No.	301036	Ref. No.	844600
description	protective cover internal size 30x22mm for rocker switch mounting measurementsmm		

accessories

blank elements

			
1			
GEV No.	347442	Ref. No.	829535
description	dummy element black mounting measurements 28.5x52.6mm		

microswitches

pin-plunger actuated

M10			
			
1			
GEV No.	345032	Ref. No.	844301
description	microswitch with plunger thread M10x1 thread L 12mm 250V 16A 1CO connection male faston 6.3mm stroke 7mm mounting distance 22mm L 28mm ambient temperature max. 125°C type SP9603 actuating force: 180g		

lamps

indicator lights



indicator lights (complete)



30x22mm			
			
1			
GEV No.	346965	Ref. No.	844899
description	indicator light mounting measurements 30x22mm 230V yellow		

			
1			
GEV No.	346968	Ref. No.	844903
description	indicator light mounting measurements 30x22mm 230V yellow/red connection male faston 6.3mm		

timers

programme timers

			
1			
GEV No.	360244	Ref. No.	842129
description	timer CDC 7803 engines 1 chambers 3 operation time 20min 230V manuf. no. 7803F1 / 907173 motor type M37RN		
spare parts for	360244		
	GEV No.	360119	Ref. No.
	motor CDC pinion ø 5.4mm teeth 12 230V turn direction right motor ø 37mm motor type M37RN for timer		

			
1			
GEV No.	360404	Ref. No.	842125
description	timer CDC 7804 engines 1 chambers 4 operation time 5min 230V		
spare parts for	360404		
	GEV No.	360119	Ref. No.
	motor CDC pinion ø 5.4mm teeth 12 230V turn direction right motor ø 37mm motor type M37RN for timer		

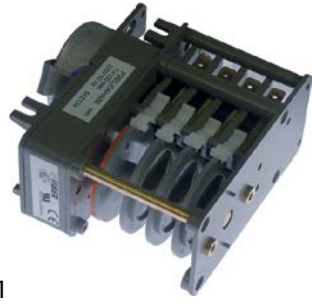
			
1			
GEV No.	360326	Ref. No.	842119 842124
description	timer CDC 7804F engines 1 chambers 4 operation time 150s 230V shaft ømm shaft Lmm		

1

GEV No.	360562	Ref. No.	842127
description	timer CDC 7806M engines 1 chambers 6 operation time 5min 230V shaft ømm shaft Lmm manif. no. 7806M1 motor type M37RN voltage AC		



1

GEV No.	360405	Ref. No.	842121
description	timer FIBER P26 engines 1 chambers 2 operation time 3min 230V 50Hz shaft ømm shaft Lmm		
For models:	LS3		



1

GEV No.	403537	Ref. No.	842134
description	PCB warewashing L 133mm W 82mm for timer		



1

GEV No.	403219	Ref. No.	842130
description	PCB warewashing TS420/TS820 L 73mm W 66mm for timer type ELH.0		

contactors

miscellaneous

power contactors



1

GEV No.	380852	Ref. No.	842501 842503
description	power contactor 230V resistive load 20A (AC3/400V) 9A/4kW main contacts 3NO auxiliary contacts 1NO connection screw type GHMC3.10		

electronics

PCBs



1

GEV No.	403572	Ref. No.	215032-1
description	PCB dishwasher Protech 1113/611 TR10 L 178mm W 125mm		

solenoïd valves

solenoïd valves (water)

TP



1







































GEV No.	370021	Ref. No.	843103	
description	solenoid valve double straight 230VAC inlet 3/4" outlet 11.5mm DN10 TP flow regulating valve inlet white			
spare parts for	370021			
	GEV No.	371013	Ref. No.	—
accessories for	370021			
	GEV No.	371220	Ref. No.	—
description	reducer TP flow rate 3l/min red tolerance ±15%			
	GEV No.	371221	Ref. No.	—
description	reducer TP flow rate 5.5l/min yellow tolerance ±15%			
	GEV No.	371222	Ref. No.	—
description	reducer TP flow rate 6l/min grey tolerance ±15%			
	GEV No.	371223	Ref. No.	—
description	reducer TP flow rate 10l/min white tolerance ±15%			
	GEV No.	371224	Ref. No.	—
description	reducer TP flow rate 12l/min bronze tolerance ±15%			

Table continues overleaf



accessories for		370021		
	GEV No.	371225	Ref. No.	—
reducer TP flow rate 16l/min light brown tolerance $\pm 15\%$				
	GEV No.	371226	Ref. No.	—
reducer TP flow rate 20l/min red tolerance $\pm 15\%$				
	GEV No.	371230	Ref. No.	—
reducer TP flow rate 0.25l/min red tolerance $\pm 25\%$				
	GEV No.	371231	Ref. No.	—
reducer TP flow rate 0.35l/min violet tolerance $\pm 25\%$				
	GEV No.	371232	Ref. No.	—
reducer TP flow rate 0.5l/min orange tolerance $\pm 25\%$				
	GEV No.	371233	Ref. No.	—
reducer TP flow rate 0.8l/min white tolerance $\pm 25\%$				
	GEV No.	371234	Ref. No.	—
reducer TP flow rate 1l/min light blue tolerance $\pm 25\%$				
	GEV No.	371235	Ref. No.	—
reducer TP flow rate 1.2l/min brown tolerance $\pm 25\%$				
	GEV No.	371236	Ref. No.	—
reducer TP flow rate 1.5l/min light brown tolerance $\pm 25\%$				
	GEV No.	371237	Ref. No.	—
reducer TP flow rate 2.5l/min yellow tolerance $\pm 25\%$				
	GEV No.	371238	Ref. No.	—
reducer TP flow rate 3.4l/min dark green tolerance $\pm 25\%$				
	GEV No.	371239	Ref. No.	—
reducer TP flow rate 5l/min black tolerance $\pm 25\%$				
	GEV No.	371240	Ref. No.	—
reducer TP flow rate 8l/min blue tolerance $\pm 20\%$				

  1				
GEV No.	370017	Ref. No.	843101	
description	solenoid valve single straight 230VAC inlet 3/4" outlet 11.5mm DN10 TP p max 10bar			
spare parts for	370017			
	GEV No.	371013	Ref. No.	—
solenoid coil TP 230VAC 50/60Hz				
accessories for	370017			
	GEV No.	371220	Ref. No.	—
reducer TP flow rate 3l/min red tolerance $\pm 15\%$				
	GEV No.	371221	Ref. No.	—
reducer TP flow rate 5.5l/min yellow tolerance $\pm 15\%$				

accessories for		370017		
	GEV No.	371222	Ref. No.	—
reducer TP flow rate 6l/min grey tolerance $\pm 15\%$				
	GEV No.	371223	Ref. No.	—
reducer TP flow rate 10l/min white tolerance $\pm 15\%$				
	GEV No.	371224	Ref. No.	—
reducer TP flow rate 12l/min bronze tolerance $\pm 15\%$				
	GEV No.	371225	Ref. No.	—
reducer TP flow rate 16l/min light brown tolerance $\pm 15\%$				
	GEV No.	371226	Ref. No.	—
reducer TP flow rate 20l/min red tolerance $\pm 15\%$				
	GEV No.	371230	Ref. No.	—
reducer TP flow rate 0.25l/min red tolerance $\pm 25\%$				
	GEV No.	371231	Ref. No.	—
reducer TP flow rate 0.35l/min violet tolerance $\pm 25\%$				
	GEV No.	371232	Ref. No.	—
reducer TP flow rate 0.5l/min orange tolerance $\pm 25\%$				
	GEV No.	371233	Ref. No.	—
reducer TP flow rate 0.8l/min white tolerance $\pm 25\%$				
	GEV No.	371234	Ref. No.	—
reducer TP flow rate 1l/min light blue tolerance $\pm 25\%$				
	GEV No.	371235	Ref. No.	—
reducer TP flow rate 1.2l/min brown tolerance $\pm 25\%$				
	GEV No.	371236	Ref. No.	—
reducer TP flow rate 1.5l/min light brown tolerance $\pm 25\%$				
	GEV No.	371237	Ref. No.	—
reducer TP flow rate 2.5l/min yellow tolerance $\pm 25\%$				
	GEV No.	371238	Ref. No.	—
reducer TP flow rate 3.4l/min dark green tolerance $\pm 25\%$				
	GEV No.	371239	Ref. No.	—
reducer TP flow rate 5l/min black tolerance $\pm 25\%$				
	GEV No.	371240	Ref. No.	—
reducer TP flow rate 8l/min blue tolerance $\pm 20\%$				



pressure switches

for warewashing

ø 58mm with male faston 6.3mm

with connection horizontal



1

GEV No.	541251	Ref. No.	843303
description	pressure control pressure range 55/20mbar connection male faston 6.3mm ø 58mm pressure connection horizontal warewashing pressure connection ø 6mm		

pumps





wash and rinse pumps

ALBA (C&A)

pumps







1

GEV No.	500296	Ref. No.	841145	
description	pump inlet ø 28mm outlet ø 28mm type C903 230V 50Hz 1 phase 0.11kW 0.15HP L 200mm rotation direction left capacitor 6.3µF auxiliary pressure connection 13mm supporting pressure closed ALBA PUMPS (C&A)			
spare parts for	500296			
	GEV No.	365012	Ref. No.	—
	operating capacitor capacity 6.3µF 450V tolerance 5% 50Hz ambient temperature max. -25 to +85°C ø 30mm L 61mm M8 plastic connection male faston 6.3mm protection			
	GEV No.	510692	Ref. No.	—
	mechanical shaft seal for shaft ø 11mm slide ring ext. ø 24mm slide ring H 13mm counter ring mounting ø 26mm height counter ring 8mm counter ring int. ø 14mm			
	GEV No.	521226	Ref. No.	—
	impellor ø 72mm H 19mm thread M7R shaft ø 11mm shaft length 29mm blades 3			
	GEV No.	521521	Ref. No.	—
	pump cover ALBA PUMPS (C&A) inlet ø 28mm outlet ø 28mm auxiliary pressure connection 13mm supporting pressure closed turn direction left ø 93mm ID ø 76mm inner height 31mm			
	GEV No.	532490	Ref. No.	—
	O-ring EPDM thickness 2.62mm ID ø 72.69mm Qty 1 pcs			



1

GEV No.	500302	Ref. No.	841161	
description	pump inlet ø 62mm outlet ø 50mm type C12002 230/400V 50Hz 3 phase 0.55kW 0.75HP L 320mm rotation direction right auxiliary pressure connection 12mm supporting pressure closed ALBA PUMPS (C&A)			
spare parts for	500302			
	GEV No.	510551	Ref. No.	841519
	pump cover gasket ID ø 158.3mm pump type 1214/1293/1225/2243/1226/1204/3473/1241 thickness 3.53mm EPDM Qty 1 pcs			
	GEV No.	510620	Ref. No.	—
	impellor ø 109mm H 27mm rotation direction right thread M8L blades 6			
	GEV No.	510693	Ref. No.	—
	mechanical shaft seal for shaft ø 12mm slide ring ext. ø 24mm slide ring H 15.5mm slide ring int. ø 11mm counter ring mounting ø 24mm height counter ring 8mm counter ring int. ø 13.5mm			
	GEV No.	521536	Ref. No.	—
	pump cover ALBA / LGB inlet ø 62mm outlet ø 50mm auxiliary pressure connection 12mm supporting pressure closed turn direction right ø 180mm ID ø 150mm inner height 38mm			



1









GEV No.	500308	Ref. No.	841181	
description	pump inlet ø 63mm outlet ø 48mm type C2002 230/400V 3 phase 1.1kW 1.5HP L 325mm rotation direction right auxiliary pressure connection 12mm supporting pressure closed ALBA PUMPS (C&A)			
spare parts for	500308			
	GEV No.	510551	Ref. No.	841519
	pump cover gasket ID ø 158.3mm pump type 1214/1293/1225/2243/1226/1204/3473/1241 thickness 3.53mm EPDM Qty 1 pcs			
	GEV No.	510620	Ref. No.	—
	impellor ø 109mm H 27mm rotation direction right thread M8L blades 6			

Table continues overleaf

spare parts for 500308			
	GEV No.	510693	Ref. No. —
mechanical shaft seal for shaft \varnothing 12mm slide ring ext. \varnothing 24mm slide ring H 15.5mm slide ring int. \varnothing 11mm counter ring mounting \varnothing 24mm height counter ring 8mm counter ring int. \varnothing 13.5mm			
	GEV No.	521536	Ref. No. —
pump cover ALBA / LGB inlet \varnothing 62mm outlet \varnothing 50mm auxiliary pressure connection 12mm supporting pressure closed turn direction right \varnothing 180mm ID \varnothing 150mm inner high 38mm			

FIR pumps



1			
GEV No.	500035	Ref. No.	841151
description	pump inlet \varnothing 63mm outlet \varnothing 47mm type 1293.1402 230V 50Hz 1 phase 0.55kW 0.75HP L 295mm rotation direction right capacitor 12.5 μ F FIR inlet \varnothing 63mm outlet \varnothing 48mm		
spare parts for 500035			
	GEV No.	365014	Ref. No. —
operating capacitor capacity 12.5 μ F 450V tolerance 5%Hz ambient temperature max. -25 to +85°C \varnothing 35mm L 70mm M8 plastic connection male faston 6.3mm 45S.C3DS.12.5 protection			
	GEV No.	510601	Ref. No. —
impellor \varnothing 103mm H 25mm rotation direction right thread M8L seat \varnothing 12.2mm blades 6			
	GEV No.	510693	Ref. No. —
mechanical shaft seal for shaft \varnothing 12mm slide ring ext. \varnothing 24mm slide ring H 15.5mm slide ring int. \varnothing 11mm counter ring mounting \varnothing 24mm height counter ring 8mm counter ring int. \varnothing 13.5mm			
	GEV No.	521513	Ref. No. —
pump cover FIR inlet \varnothing 63mm outlet \varnothing 47mm turn direction right ID \varnothing 150mm inner high 32mm			
	GEV No.	524416	Ref. No. —
pump cover gasket thickness 4x4mm Qty 1 pcs			

LGB



1			
GEV No.	500494	Ref. No.	841147
description	pump inlet \varnothing 28mm outlet \varnothing 26mm type ZF130DX 230V 50Hz 1 phase 0.3kW 0.4HP L 200mm rotation direction left capacitor 6.3 μ F LGB		
spare parts for 500494			
	GEV No.	365012	Ref. No. —
operating capacitor capacity 6.3 μ F 450V tolerance 5% 50Hz ambient temperature max. -25 to +85°C \varnothing 30mm L 61mm M8 plastic connection male faston 6.3mm protection			
	GEV No.	510703	Ref. No. —
mechanical shaft seal for shaft \varnothing 13mm slide ring H 13mm height counter ring 5.5mm ED \varnothing 26mm			
	GEV No.	521107	Ref. No. —
pump cover LGB inlet \varnothing 28mm outlet \varnothing 26mm auxiliary pressure connection 12mm ID \varnothing 77mm			
	GEV No.	521228	Ref. No. —
impellor \varnothing 72mm H 17mm rotation direction left thread M7R shaft \varnothing 13mm shaft length 12mm blades 3			
	GEV No.	528800	Ref. No. —
O-ring EPDM thickness 2.62mm ID \varnothing 75.87mm Qty 1 pcs			













1			
GEV No.	500474	Ref. No.	841110
description	pump inlet \varnothing 60mm outlet \varnothing 50mm type ZF400SX 230V 50Hz 1 phase 0.7kW 0.95HP L 215mm rotation direction right capacitor 16 μ F LGB		
spare parts for 500474			
	GEV No.	365021	Ref. No. —
operating capacitor capacity 16 μ F 425V tolerance 5% 50/60Hz ambient temperature max. -25 to +85°C \varnothing 35mm L 73mm single M8 plastic connection male faston 6.3mm 416.10.99 protection			





Table continues overleaf

spare parts for 500474	
	GEV No. 509020 Ref. No. — impellor ø 104mm H 25mm M8L
	GEV No. 510703 Ref. No. — mechanical shaft seal for shaft ø 13mm slide ring H 13mm height counter ring 5.5mm ED ø 26mm
	GEV No. 521547 Ref. No. — pump cover LGB inlet ø 60mm outlet ø 50mm supporting pressure M8 turn direction right ø 160mm ID ø 127mm inner high 36mm
	GEV No. 532623 Ref. No. — O-ring EPDM thickness 2.62mm ID ø 120.32mm Qty 1 pcs



1	
GEV No. 500486	Ref. No. 841112
description	pump inlet ø 60mm outlet ø 50mm type ZF400VSX 230V 50Hz 1 phase 0.7kW 0.95HP L 255mm rotation direction right capacitor 16µF LGB
spare parts for 500486	
	GEV No. 365021 Ref. No. — operating capacitor capacity 16µF 425V tolerance 5% 50/60Hz ambient temperature max. -25 to +85°C ø 35mm L 73mm single M8 plastic connection male faston 6.3mm 416.10.99 protection
	GEV No. 509020 Ref. No. — impellor ø 104mm H 25mm M8L
	GEV No. 510703 Ref. No. — mechanical shaft seal for shaft ø 13mm slide ring H 13mm height counter ring 5.5mm ED ø 26mm
	GEV No. 512404 Ref. No. — bracket mounting distance 130mm
	GEV No. 521058 Ref. No. — fanwheel cover suitable for LGB ID ø 138mm ED ø 142mm H 59mm plastic
	GEV No. 521547 Ref. No. — pump cover LGB inlet ø 60mm outlet ø 50mm supporting pressure M8 turn direction right ø 160mm ID ø 127mm inner high 36mm
	GEV No. 532623 Ref. No. — O-ring EPDM thickness 2.62mm ID ø 120.32mm Qty 1 pcs



1	
GEV No. 500943	Ref. No. 841114
description	pump inlet ø 62mm outlet ø 50mm type ZF522VSX 230V 50Hz 1 phase 0.7kW 0.95HP L 250mm rotation direction right capacitor 16µF LGB
spare parts for 500943	
	GEV No. 365021 Ref. No. — operating capacitor capacity 16µF 425V tolerance 5% 50/60Hz ambient temperature max. -25 to +85°C ø 35mm L 73mm single M8 plastic connection male faston 6.3mm 416.10.99 protection
	GEV No. 510551 Ref. No. 841519 pump cover gasket ID ø 158.3mm pump type 1214/1293/1225/2243/1226/1204/3473/1241 thickness 3.53mm EPDM Qty 1 pcs
	GEV No. 510694 Ref. No. — mechanical shaft seal for shaft ø 13mm height counter ring 8mm ID ø 11.5mm H 16mm mounting ø 24/26mm int. ø 1 14mm
	GEV No. 521239 Ref. No. — impellor ø 110mm H 26mm rotation direction right thread M8L shaft ø 19.5mm shaft length 17mm seat ø 8.2mm blades 6
	GEV No. 521536 Ref. No. — pump cover ALBA / LGB inlet ø 62mm outlet ø 50mm auxiliary pressure connection 12mm supporting pressure closed turn direction right ø 180mm ID ø 150mm inner high 38mm

drain pumps

ASKOLL	
1	
	Askoll
GEV No. 500054	Ref. No. 461400 841193
description	drain pump inlet ø 24mm outlet ø 22mm 230V 40W 50Hz ASKOLL type R113



GRE



1	GEV No.	500039	Ref. No.	841104
description pump inlet ø 24mm outlet ø 24mm 190W 230V 50Hz GRE				

equipment-specific units
for dishwashers

drain and intake components

TEIKOS

drain /intake bodies



1	GEV No.	507419	Ref. No.	835105
description drain fitting angled thread 3/4" hose ø 25mm				



1	GEV No.	507422	Ref. No.	825363
description drain fitting thread 1" H 36mm hose ø 28mm				

accessories for

	GEV No.	507423	Ref. No.	826513
nut				



1	GEV No.	507424	Ref. No.	835107
description drain fitting thread 1 1/4" - 2" H 87mm ID ø 44mm				



1	GEV No.	507420	Ref. No.	835111
description drain fitting thread 3/4" ID ø 22mm				



1	GEV No.	507423	Ref. No.	826513
description nut				



1	GEV No.	513057	Ref. No.	839597
description O-ring EPDM thickness 1.78mm ID ø 28.3mm Qty 1 pcs				



1	GEV No.	528339	Ref. No.	839599
description O-ring EPDM thickness 2.62mm ID ø 40.95mm Qty 1 pcs				

filters



1	GEV No.	504218	Ref. No.	837101
description round filters ø 80mm H 34mm				
For models: TS820				



1	GEV No.	507382	Ref. No.	837201
description round filters suction ø 160mm H 70mm				
spare parts for 507382				
	GEV No.	507383	Ref. No.	847701
screw connection for filter				



overflow pipes



1

GEV No.	517335	Ref. No.	453303 835113
description	overflow pipe L 120mm ø 22mm		



1

GEV No.	510765	Ref. No.	453307
description	overflow pipe L 140mm ø 40mm		



1

GEV No.	517334	Ref. No.	835109
description	overflow pipe L 210mm ø 40mm		



1

GEV No.	510754	Ref. No.	453301
description	overflow pipe L 66mm ø 22mm		

containers



salt tanks





1

GEV No.	510929	Ref. No.	843405
description	salt tank ø 120mm H 117mm hose ø 10mm mounting ø 70mm overall height 157mm		

spare parts for 510929

	GEV No.	506015	Ref. No.	—
	O-ring EPDM thickness 3.53mm ID ø 39.69mm Qty 1 pcs			
	GEV No.	510018	Ref. No.	—
	nut ø 92mm H 10.5mm for salt tank ID ø 64mm			
	GEV No.	524177	Ref. No.	—
	lid ø 69mm H 20mm for salt tank ID ø 50mm			

accessories for 510929

	GEV No.	510071	Ref. No.	—
	flat gasket rubber ED ø 81mm ID ø 68mm thickness 3mm for salt tank Qty 1 pcs			
	GEV No.	510654	Ref. No.	—
	gasket H 6mm D1 ø 82mm D2 ø 68mm			
	GEV No.	510883	Ref. No.	—
	gasket rubber ED ø 86mm ID ø 66mm thickness 2mm for salt tank Qty 1 pcs			

rotation plates

accessories



1

GEV No.	519422	Ref. No.	823301
description	bearing bolt		

			
1			
GEV No.	519421	Ref. No.	825553
description	bush for rotation plate ø 32mm		

softener cartridges

softening columns

			
1			
GEV No.	530000	Ref. No.	843401 843403
description	softener 4-fold L 380mm W 180mm		

air traps

air traps

			
1			
GEV No.	510762	Ref. No.	833513
description	air trap		
accessories for	510762		
	GEV No.	510764	Ref. No. 839331
	flat gasket rubber ED ø 24mm ID ø 12mm thickness 2mm Qty 1 pcs		
	GEV No.	511453	Ref. No. 833517
	hose connector		
	GEV No.	528223	Ref. No. 839711
	O-ring EPDM thickness 2.62mm ID ø 11.91mm Qty 1 pcs		

air trap accessories

			
1			
GEV No.	511453	Ref. No.	833517
description	hose connector		

screw connections

			
1			
GEV No.	507383	Ref. No.	847701
description	screw connection for filter		

washing and rinsing systems

			
1			
GEV No.	517329	Ref. No.	826541
description	gasket		

			
1			
GEV No.	517327	Ref. No.	825697
description	nut for wash arm support		

			
1			
GEV No.	507514	Ref. No.	826523
description	nut thread M15x1 H 7.5mm brass WS 22 ID ø 19.8mm inner height 1.7mm Qty 1 pcs		

			
1			
GEV No.	524935	Ref. No.	449331 849331
description	rinse pipe mounting pos. lower ø 15mm L 200mm		

			
1			
GEV No.	524936	Ref. No.	855250
description	slide ring for wash arm mounting pos. 1/3 bottom ED ø 46mm ID ø 38mm thickness 6.8mm		

1

GEV No.	517330	Ref. No.	425105 825885
description	spacer piece for wash arm ø 60mm L 102mm mounting pos. lower SS		



1

GEV No.	517331	Ref. No.	425101 825881
description	spacer piece for wash arm ø 60mm L 30mm mounting pos. upper SS		



1

GEV No.	517328	Ref. No.	440100
description	wash arm bearing		



1

GEV No.	517831	Ref. No.	825721
description	wash arm bearing ø 60mm H 78mm thread M15x1		



1

GEV No.	517326	Ref. No.	825695	
description	wash arm support			
spare parts for	517326			
	GEV No.	517327	Ref. No.	825697
	nut for wash arm support			

washing and rinsing systems (sorted by producer)

TEIKOS



1

GEV No.	507542	Ref. No.	441109
description	wash arm L 390mm nozzles 6 mounting ø 42.3mm mounting pos. lower		



1

GEV No.	517324	Ref. No.	441107
description	wash arm L 480mm nozzles 8 mounting ø 42.3mm mounting pos. upper/lower		



1

GEV No.	507543	Ref. No.	443105
description	rinse arm L 360mm nozzles 4 mounting pos. lower		





1

GEV No.	507438	Ref. No.	443125
description	rinse arm L 450mm nozzles 4		

			
1			
GEV No.	517325	Ref. No.	443121 443123
description	rinse arm mounting pos. upper/lower L 450mm nozzles 4 mounting ø 13.5mm		

miscellaneous

			
1			
GEV No.	510786	Ref. No.	826110
description	rinse jet		

			
1			
GEV No.	510785	Ref. No.	826303
description	swirl hole ø 2.5mm H 3.5mm ø 18.5mm		

			
1			
GEV No.	510784	Ref. No.	826125
description	wash jet		

			
1			
GEV No.	507417	Ref. No.	825691
description	wash arm support mounting pos. lower ø 56mm H 68mm		

			
1			
GEV No.	507513	Ref. No.	825720
description	wash arm support mounting pos. lower ø 60mm D1 ø 42mm D2 ø 40mm H 120mm ID ø 30mm		

			
1			
GEV No.	507418	Ref. No.	440102
description	wash arm bearing mounting pos. lower H 68mm		

rinse arm shafts

			
1			
GEV No.	507421	Ref. No.	449327 849327
description	rinse arm shaft mounting pos. lower ø 15mm H 146mm thread M15x1		

equipment feet and end caps

screw-in feet

			
1			
GEV No.	701283	Ref. No.	829313
description	equipment foot thread M8 thread L 35mm ø 35mm H 34mm Qty 1 pcs		

gaskets

O-rings

EPDM

			
1			
GEV No.	510302	Ref. No.	839595
description	O-ring EPDM ID ø 12.42mm thickness 1.78mm Qty 1 pcs		

			
1			
GEV No.	540682	Ref. No.	839593
description	O-ring EPDM thickness 1.78mm ID ø 18.77mm Qty 1 pcs		



1			
GEV No.	513057	Ref. No.	839597
description	O-ring EPDM thickness 1.78mm ID ø 28.3mm Qty 1 pcs		

1			
GEV No.	532652	Ref. No.	839707
description	O-ring EPDM thickness 3.53mm ID ø 71.44mm Qty 1 pcs		

1			
GEV No.	528223	Ref. No.	839711
description	O-ring EPDM thickness 2.62mm ID ø 11.91mm Qty 1 pcs		

1			
GEV No.	510551	Ref. No.	841519
description	pump cover gasket ID ø 158.3mm pump type 1214/1293/1225/2243/1226/1204/3473/1241 thickness 3.53mm EPDM Qty 1 pcs		

1			
GEV No.	529251	Ref. No.	839709
description	O-ring EPDM thickness 2.62mm ID ø 15.08mm Qty 1 pcs		

sealing washers

rubber gaskets

1			
GEV No.	510764	Ref. No.	839331
description	flat gasket rubber ED ø 24mm ID ø 12mm thickness 2mm Qty 1 pcs		

1			
GEV No.	532453	Ref. No.	839705
description	O-ring EPDM thickness 2.62mm ID ø 21.89mm Qty 1 pcs		

dosing pumps
peristaltic dosing pumps

MICRODOS

built-in version
with time control



1			
GEV No.	361000	Ref. No.	843895
description	dosing pump MICRODOS time control 3l/h 230VAC detergent hose ø 4x6mm hose Santoprene suction level 1.5m horizontal/vertical type MP3-T dosing time 1-25s		









spare parts for	361000			
	GEV No.	361284	Ref. No.	—
	pump hose detergent ID ø 6.25mm ED ø 10.55mm hose ø 4x6mm hose type Santoprene with connections Shore 55°			
	GEV No.	361514	Ref. No.	—
	roller assembly detergent hose type Santoprene beige			
	GEV No.	361549	Ref. No.	—
	pump hose detergent ID ø 6mm ED ø 10.5mm hose ø 10.5mm hose ø 6mm hose type Santoprene L 1000mm dosing Qty 1m Shore 55°			

1			
GEV No.	502036	Ref. No.	839713
description	O-ring EPDM thickness 2.62mm ID ø 28.25mm Qty 1 pcs		



1			
GEV No.	528339	Ref. No.	839599
description	O-ring EPDM thickness 2.62mm ID ø 40.95mm Qty 1 pcs		

1			
GEV No.	528902	Ref. No.	839701
description	O-ring EPDM thickness 3.53mm ID ø 66.27mm Qty 1 pcs		

membrane dosing pumps
self-priming
SEKO

1				
GEV No.	361217	Ref. No.	843901 843911 844905	
description	dosing pump type DIB3E rinse aid pump rate 0-3cm ³ per stroke pressure connection ø 4x6mm suction connection ø 4x6mm SEKO			
spare parts for	361217			
	GEV No.	361301	Ref. No.	—
	hose connector for type DIB3E/DIB5E			
	GEV No.	361302	Ref. No.	—
	valve bush for type DIB3E/DIB5E			
	GEV No.	361304	Ref. No.	—
	O-ring EPDM ID ø 11.11mm thickness 1.78mm Qty 1 pcs for type DIB3E/DIB5E			
	GEV No.	361305	Ref. No.	—
	valve disc for type DIB3E/DIB5E DIB3P/DIB5P			
	GEV No.	361306	Ref. No.	—
	membrane for type DIB3E/DIB5E ø 49mm hole ø 5mm			
	GEV No.	361307	Ref. No.	—
	membrane dosing pump ø 68mm hole ø 6mm for type DIB3P/DIB5P			
	GEV No.	361481	Ref. No.	—
	lip valve for type DIB3P/DIB5P DIB3E/DIB5E			
accessories for	361217			
	GEV No.	361240	Ref. No.	—
	hose connector 1-way hose ø 6mm plastic connection M10x1			
	GEV No.	361241	Ref. No.	—
	hose connector 1-way hose ø 9mm plastic connection M10x1			

various

1				
GEV No.	361370	Ref. No.	843915	
description	dosing pump type model 2 rinse aid inlet 4x6mm outlet 4x6mm pressure connection ø 4x6mm suction connection ø 4x6mm			
spare parts for	361370			
	GEV No.	361307	Ref. No.	—
	membrane dosing pump ø 68mm hole ø 6mm for type DIB3P/DIB5P			
	GEV No.	361459	Ref. No.	—
	hose connector ø 6mm for dosing pump			

self-priming with supporting pressure
GERMAC
type 1000













1				
GEV No.	361519	Ref. No.	843917	
description	dosing pump type 1000 rinse aid inlet 4x6mm outlet M10x1 pressure connection ø M10x1 IT for pipes ø 6mm suction connection ø PVC 4x6mm supporting pressure 11mm rebound ball PTFE 1mm GERMAC CODE VNR/A3			
spare parts for	361519			
	GEV No.	361550	Ref. No.	—
	hose connector hose ø 4x6mm			
	GEV No.	361551	Ref. No.	—
	compression spring wire gauge ø 1mm			
	GEV No.	361703	Ref. No.	—
	hose connector thread M10x1 brass pipe connection ø 4x6mmmm			
	GEV No.	361705	Ref. No.	—
	gasket for hose connector M12x1			
	GEV No.	510298	Ref. No.	—
	lip valve dosing pump suitable for DB2/DS5			
accessories for	361519			
	GEV No.	361553	Ref. No.	—
	membrane EPDM			
	GEV No.	361700	Ref. No.	—
	hose connector rotary hose ø 4x6mm plastic connection M10x1			

Table continues overleaf



accessories for 361519				
	GEV No.	361702	Ref. No.	—
	hose connector brass hose ø 4x6mm			
	GEV No.	361704	Ref. No.	—
	hose connector brass straight thread M12x1 hose ø 11mm Qty 1 pcs			
	GEV No.	510296	Ref. No.	—
	membrane silicone			
	GEV No.	520090	Ref. No.	—
	PVC hose ID ø 4mm ED ø 6mm L 2m thickness 1mm t.max. 60°C transparent			
	GEV No.	520091	Ref. No.	—
	nylon hose ID ø 4mm ED ø 6mm L 2m thickness 1mm operating p. 10bar burst p. 50bar t.max. 100°C transparent			

hoses

formed hoses

form L

				
1				
GEV No.	530088	Ref. No.	833115	
description	formed hose end piece A ext. ø 33mm end piece A int. ø 28mm AD2 ø 33mm ø end piece B 28mm for wash pump L 185mm L-shape Qty 1 black			

				
1				
GEV No.	530772	Ref. No.	833116	
description	formed hose end piece A ext. ø 36mm end piece A int. ø 27mm AD2 ø 36mm ø end piece B 28mm L 180mm for wash pump			

with branch

				
1				
GEV No.	530801	Ref. No.	833113	
description	formed hose ID ø 15/50mm ED ø 25/63mm L 72mm straight with piggyback			

C

contactors	7
control thermostats	4,4

D

dosing pumps	17
drain pumps	11

F

formed hoses	19
--------------	----

H

heating elements	3
hoses	19

I

immersion heating elements	3
indicator lights	6
indicator lights (complete)	6

L

lamps	6
-------	---

M

microswitches	6
---------------	---

O

O-rings	16
---------	----

P

pressure switches	9
programme timers	6
pumps	9
push/momentary push switches	5

R

rocker/momentary rocker switches	4
----------------------------------	---

S

sealing washers	17
solenoid valves	7
switches and momentary switches	4

T

thermostats	4
timers	6

W

wash and rinse pumps	9
----------------------	---