



GAS COMPONENTS



ELECTRIC COMPONENTS



WATER TECHNOLOGY



MECHANICAL COMPONENTS



TOOLS

Spare parts suitable for

THERMA

Find the complete and up-to-date range of products in our GEV Webshop



Manufacturer catalogue

The most important spare parts and accessories arranged clearly for every manufacturer

- ✓ Complete product range and all appliance data always up to date in the GEV Webshop
- ✓ Alphabetical Index at the end of the catalogue

GEV Webshop

www.gev-online.co.uk

www.gev-online.com



- 🔍 Add to Favourites
- 🔍 Sign In with email address and usual password
- 🔍 Easy-order – place several items in your basket at the same time
- 🔍 Quick Item search – no login needed



heating elements

heating elements for ovens

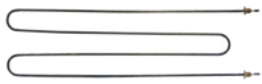

1

GEV No.	415350	Ref. No.	OK4982
description	heating element 1600W 400V heating circuits 1 L 610mm W 180mm tube ø 6.5mm 2 hole fixing thread 1/4" dry heating element bain marie mounting distance 173mm		

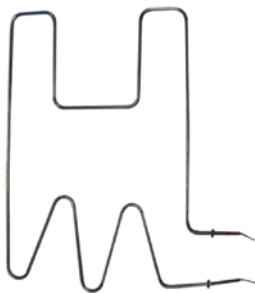

1

GEV No.	415356	Ref. No.	OK4863
description	heating element 2750W 400V heating circuits 1 L 538mm W 618mm L1 58mm L2 480mm W1 523mm W2 95mm mounting distance 86.5mm tube ø 8.5mm connection M4 dry heating element		

heating elements for bain maries

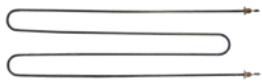

1

GEV No.	415350	Ref. No.	OK4982
description	heating element 1600W 400V heating circuits 1 L 610mm W 180mm tube ø 6.5mm 2 hole fixing thread 1/4" dry heating element bain marie mounting distance 173mm		



1

GEV No.	415624	Ref. No.	OK4984
description	heating element 2400W 400V heating circuits 1 L 605mm W 380mm connection male faston 6.3mm tube ø 6.5mm 2 hole fixing thread M14x1.5 dry heating element bain marie mounting distance 374mm		

heating elements for griddles



1

GEV No.	415624	Ref. No.	OK4984
description	heating element 2400W 400V heating circuits 1 L 605mm W 380mm connection male faston 6.3mm tube ø 6.5mm 2 hole fixing thread M14x1.5 dry heating element bain marie mounting distance 374mm		

heating elements for large hobs

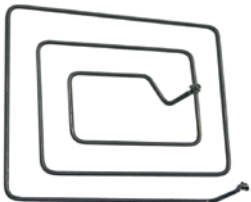

1

GEV No.	415576	Ref. No.	OK4814
description	heating element 1335W 400V L 320mm W 275mm H 76mm heating circuits 1 tube ø 6.3mm mounting pos. centre connection length 18mm connection male faston dry heating element 400V		

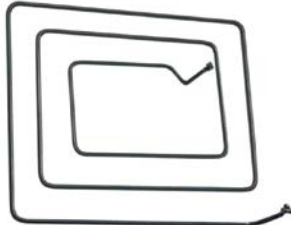

1

GEV No.	420291	Ref. No.	OK4855
description	heating element 1505W 440V L 350mm W 300mm H 95mm heating circuits 1 tube ø 6.5mm mounting pos. outer connection length 22mm connection M5		

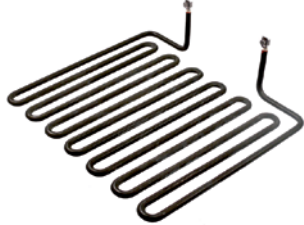



1

GEV No.	418701	Ref. No.	OG2883
description	heating element 4000W 400V heating circuits 1 L 300mm W 330mm H 80mm tube ø 8.5mm W1 92.5mm W2 145mm connection screw clamp windings 7		









heating elements for tilting bratt pan

			
1			
GEV No.	415747	Ref. No.	N/A
description	heating element tilting bratt pan 2500W 230V L 518mm W 95mm dry heating element heating circuits 1 tube ø 8.5mm cable length 215mm connection distance 87mm		

			
1			
GEV No.	415355	Ref. No.	OK4810
description	heating element tilting bratt pan 2500W 230V L 612mm W 130mm H 8.5mm dry heating element heating circuits 1 tube ø 8.5mm cable length 750mm connection length 17mm connection distance 122mm		



heating elements for salamanders/toast-

			
1			
GEV No.	415559	Ref. No.	OK4777
description	heating element 2100W 400V heating circuits 1 L 260mm W 217mm H 20mm thread M14x1.25 mounting distance 210mm connection length 14mm tube ø 6.5mm 2 hole fixing dry heating element		

				
1				
GEV No.	415558	Ref. No.	OK4784	
description	heating element 2600W 400V L 361mm W 310mm H 30mm thread M14x1.5 mounting distance 280mm connection length 34mm tube ø 8.5mm connection M4 2 hole fixing dry heating element			
accessories for	415558			
	GEV No.	510417	Ref. No.	—
	flat gasket fibre ED ø 20mm ID ø 14mm thickness 2mm Qty 1 pcs			
	GEV No.	520228	Ref. No.	—
	tooth lock washer ID ø 15.3mm ED ø 24mm steel Qty 1 pcs for thread M14			
	GEV No.	520230	Ref. No.	—
	nut thread M14x1.5 H 5mm WS 19 zinc-coated steel Qty 1 pcs			
	GEV No.	521101	Ref. No.	—
	nut thread M14x1.5 H 5mm WS 19 SS Qty 1 pcs			
	GEV No.	550262	Ref. No.	—
	flat gasket copper ED ø 20mm ID ø 14mm thickness 2mm			



ceramic heaters

245x60mm

				
1				
GEV No.	415104	Ref. No.	0A2843	
description	ceramic emitter 1000W 230V cable beaded cord L 245mm W 60mm H 35mm			
spare parts for	415104			
	GEV No.	415109	Ref. No.	—
	spring clip			
accessories for	415104			
	GEV No.	415110	Ref. No.	—
	reflector L 245mm W 95mm H 31mm thickness 0.75mm hole ø 15x40mm			



immersion heating elements

3 hole flange ø47.5mm

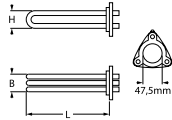
				
1				
GEV No.	415063	Ref. No.	OC5336	
description	heating element 17000W 230V mounting ø 47.5mm heating circuits 3 L 590mm W 29mm H 38mm number of thermostat sleeves 1 thermostat sleeves ø 4mm length thermostat sleeves 225mm thermostat sleeve centre tube ø 8.5mm hole distance 63mm hole ø 10mm connection M5 3 hole flange immersion heater			
accessories for	415063			
	GEV No.	510408	Ref. No.	067620
	O-ring EPDM thickness 5.34mm ID ø 47mm Qty 1 pcs			
	GEV No.	510562	Ref. No.	—
	O-ring silicone thickness 5.34mm ID ø 47mm Qty 1 pcs			

1

GEV No.	415066	Ref. No.	OL1849
description	heating element 4500W 230V mounting \varnothing 47.5mm heating circuits 3 L 310mm W 30mm H 36mm number of thermostat sleeves 1 thermostat sleeves \varnothing 7mm length thermostat sleeves 185mm thermostat sleeve eccentric, clinging tube \varnothing 6.3mm hole distance 64mm hole \varnothing 10mm connection male faston 6.3mm 3 hole flange immersion heater		
spare parts for	415066		
	GEV No.	510408	Ref. No. 067620
	O-ring EPDM thickness 5.34mm ID \varnothing 47mm Qty 1 pcs		
accessories for	415066		
	GEV No.	510408	Ref. No. 067620
	O-ring EPDM thickness 5.34mm ID \varnothing 47mm Qty 1 pcs		
	GEV No.	510562	Ref. No. —
	O-ring silicone thickness 5.34mm ID \varnothing 47mm Qty 1 pcs		

with round flange \varnothing 47.5mm



1

GEV No.	418782	Ref. No.	OK4734
description	heating element 4500W 230V heating circuits 3 L 330mm W 43mm H 33mm tube \varnothing 6.3mm thermostat sleeves \varnothing 6.25mm length thermostat sleeves 203mm number of thermostat sleeves 1 connection male faston 6.3mm immersion heater round flange mounting \varnothing 47.5mm with temperature protection		
accessories for	418782		
	GEV No.	510408	Ref. No. 067620
	O-ring EPDM thickness 5.34mm ID \varnothing 47mm Qty 1 pcs		

with round flange \varnothing 57.5mm



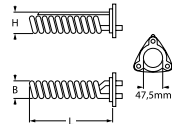

1

GEV No.	418983	Ref. No.	OK7530
description	heating element 12000W 220V heating circuits 3 mounting \varnothing 57.5mm L 455mm W 40mm H 30mm connection M5 immersion heater tube \varnothing 6.3mm connection length 20mm thermostat sleeves \varnothing 6mm number of thermostat sleeves 1 length thermostat sleeves 290mm thermostat sleeve upper dishwasher		

1

GEV No.	415668	Ref. No.	OK3789
description	heating element 2625W 230V mounting \varnothing 47.5mm heating circuits 1 L 190mm W 41mm H 54mm number of thermostat sleeves 1 thermostat sleeves \varnothing 7mm length thermostat sleeves 170mm thermostat sleeve eccentric, non clinging tube \varnothing 6.3mm hole distance 62mm hole \varnothing 8mm connection M4 3 hole flange immersion heater		
spare parts for	415668		
	GEV No.	510408	Ref. No. 067620
	O-ring EPDM thickness 5.34mm ID \varnothing 47mm Qty 1 pcs		
accessories for	415668		
	GEV No.	510562	Ref. No. —
	O-ring silicone thickness 5.34mm ID \varnothing 47mm Qty 1 pcs		





1

GEV No.	418982	Ref. No.	OL1833
description	heating element 4000W 230V heating circuits 3 mounting \varnothing 57.5mm L 455mm W 40mm H 32mm connection male faston 6.3mm immersion heater tube \varnothing 6.3mm thermostat sleeves \varnothing 6mm number of thermostat sleeves 1 length thermostat sleeves 290mm thermostat sleeve upper dishwasher		



1

GEV No.	418615	Ref. No.	OL1859
description	heating element 7500W 230V heating circuits 3 mounting \varnothing round flange \varnothing 57.5mm L 440mm W 35mm H 55mm round flange immersion heater tube \varnothing 6.2mm H1 20mm H2 35mm L1 40mm L2 400mm		
spare parts for	418615		
	GEV No.	510409	Ref. No. —
	O-ring EPDM thickness 5.34mm ID \varnothing 56.52mm Qty 1 pcs		
accessories for	418615		
	GEV No.	550002	Ref. No. —
	tension strap H 10mm L 21mm W 10mm hole \varnothing 6.5mm for heating element		

3 hole flange \varnothing 57.5mm

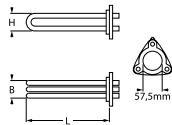

1

GEV No.	418779	Ref. No.	OL1630
description	heating element 9000W 230V mounting \varnothing 57.5mm heating circuits 3 L 340mm W 52mm H 54mm tube \varnothing 8.5mm hole distance 72mm hole \varnothing 8mm with integrated fuse INCOLOY		
spare parts for	418779		
	GEV No.	510409	Ref. No. —
	O-ring EPDM thickness 5.34mm ID \varnothing 56.52mm Qty 1 pcs		







3/4"



GEV No.	415580	Ref. No.	OG0334
description	heating element 5000W 400V heating circuits 1 L 404mm W 23mm H 80mm cable length 400mm connection length 85mm immersion heater flange with thread H1 52mm H2 28mm thread 3/4"		
accessories for	415580		
	GEV No.	510403	Ref. No. —
	flat gasket fibre ED ø 36.5mm ID ø 27mm thickness 2mm Qty 1 pcs		
	GEV No.	510421	Ref. No. —
	gasket copper ED ø 31.8mm ID ø 26.4mm thickness 2.2mm for thread 3/4"		
	GEV No.	520234	Ref. No. —
	nut thread 3/4" H 5mm brass WS 30 Qty 1 pcs		



GEV No.	415072	Ref. No.	048086
description	heating element 2200W 230V heating circuits 1 L 325mm W 83mm H 25mm thread M14x1 mounting distance 75mm tube ø 8.5mm connection male faston 6.3mm 2 hole fixing immersion heater		
accessories for	415072		
	GEV No.	510417	Ref. No. —
	flat gasket fibre ED ø 20mm ID ø 14mm thickness 2mm Qty 1 pcs		
	GEV No.	520228	Ref. No. —
	tooth lock washer ID ø 15.3mm ED ø 24mm steel Qty 1 pcs for thread M14		
	GEV No.	521133	Ref. No. —
	nut thread M14x1.5 H 6mm WS 19 zinc-coated steel Qty 1 pcs		
	GEV No.	550261	Ref. No. —
	nut thread M14x1 H 4mm WS 19 SS Qty 1 pcs		
	GEV No.	550262	Ref. No. —
	flat gasket copper ED ø 20mm ID ø 14mm thickness 2mm		

radiation heaters

square



GEV No.	490008	Ref. No.	OK0589
description	radiation heater L 300mm W 300mm 4000W 400V heating circuits 2 connections 3 square connection type male faston 6.3mm without pan detection EGO		
spare parts for	490008		
	GEV No.	499157	Ref. No. —
	protection pipe for temperature probe ceramic L 297mm ED ø 7mm ID ø 5mm		



GEV No.	416999	Ref. No.	005942
description	radiation heater rectangular 5000W 230V L 410mm W 280mm heating circuits 3 connections 3x 2 IRCA for fryer		

hot plates

square & rectangular



with radiused edge



GEV No.	490056 ¹	Ref. No.	052198
description	hot plate dimensions 300x300mm 3000W 230V with spill ring connection 4 screw clamps protector yes square		

¹incl. protector





 			
1			
GEV No.	490057 ¹	Ref. No.	OK4756
description	hot plate dimensions 300x300mm 3000W 400V with spill ring connection 4 screw clamps protector yes square		

¹incl. protector

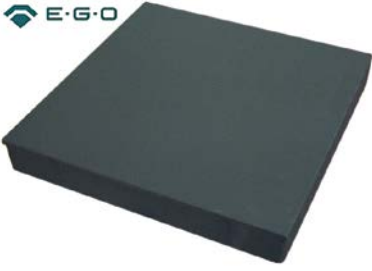

			
1			
GEV No.	490187	Ref. No.	OG0233
description	hot plate dimensions 350x400mm 4500W 380V with spill ring		

<p>tiltable</p>  			
1			
GEV No.	490090	Ref. No.	OK0381
description	hot plate dimensions 300x300mm 4000W 400V with cast edge tilt boiling plate connection 4 screw clamps H 43mm square		

<p>miscellaneous</p> 			
1			
GEV No.	490165	Ref. No.	OK4760
description	hot plate dimensions 350x400mm 4000W 400V connection 2x3		

<p>round</p> <p>with radiused edge</p> <p>for domestic and commercial kitchens</p>			
			
1			
GEV No.	490021	Ref. No.	003931
description	hot plate ø 220mm 2600W 400V connection 4 screw clamps with 8mm spill ring		

<p>accessories</p> <p>fasteners</p>			
			
1			
GEV No.	550129	Ref. No.	OG4300
description	bearing screw for tilt boiling plate straight thread M12x80		

<p>energy regulators</p> <p>EGO</p>			
<p>1-circuit</p>  			
1			
GEV No.	380015	Ref. No.	OC1605
description	energy regulator 230V 13A single-circuit turn direction right shaft ø 6x4.6mm shaft L 23mm mounting thread M4 power release 6-100% no. 50.57021.010		





<p>thermostats</p> <p>bi-metal thermostats</p> <p>safety bi-metal thermostats</p>			
			
1			
GEV No.	390138	Ref. No.	048887
description	bi-metal safety thermostat hole distancemm switch-off temp. 112°C 1NC 1-pole 16A connection F6.3		
accessories for	390138		
	GEV No.	504736	Ref. No.
			—
	bracket for contact thermostat		

Table continues overleaf



accessories for	390138		
	GEV No.	550388	Ref. No.
			—
	bracket for contact thermostat mounting distance 24.5mm mounting ø 3.8		

bi-metal thermostats

	1		
GEV No.	390101	Ref. No.	048487
description	bi-metal thermostat hole distance 38mm switch-off temp. 53°C 1CO 1-pole 16A connection F6.3 2 hole fixing		

control and safety thermostats

EGO

control thermostats

55.13_ series

	1		
GEV No.	375871	Ref. No.	0E5032
description	thermostat t.max. 110°C temperature range 30-110°C 1-pole 1CO 16A probe ø 6mm probe L 113mm capillary pipe 2930mm capillary pipe isolated gland nut M9x1 shaft ø 6x4.6mm shaft L 23mm shaft position upper rotation 270° H 40mm W 35mm D 30mm		

	1		
GEV No.	375505	Ref. No.	0H2049
description	thermostat t.max. 320°C temperature range 50-320°C 1-pole 1NO 16A probe ø 3mm probe L 160mm capillary pipe 870mm capillary pipe isolated gland nut shaft ø 6x4.6mm shaft L 23mm shaft position upper rotation 270°		

E-G-O



1

GEV No.	375810	Ref. No.	0H9843
description	thermostat t.max. 80°C temperature range fixed 80°C 1-pole 1NC 16A probe ø 7.5mm probe L 30.5mm capillary pipe 810mm capillary pipe isolated gland nut shaft L 23mm		

55.34_ series

E-G-O



1

GEV No.	375022	Ref. No.	0H6127
description	thermostat t.max. 180°C temperature range 95-180°C 3-pole 3NO 16A probe ø 6mm probe L 133mm capillary pipe 1780mm capillary pipe isolated 1400mm gland nut M9x1 shaft ø 6x4.6mm shaft L 23mm rotation 270°		

E-G-O



1

GEV No.	375766	Ref. No.	002587
description	thermostat t.max. 190°C temperature range 120-190°C 3-pole 1CO/2NO 16A probe ø 6mm probe L 133mm capillary pipe 880mm capillary pipe isolated 350mm gland nut shaft ø 6x4.6mm shaft L 23mm shaft position upper rotation 270°		



GEV No.	375763	Ref. No.	OKW841
description	thermostat t.max. 206°C temperature range 120-206°C 3-pole 1CO/2NO 16A probe ø 4mm probe L 157mm capillary pipe 1780mm capillary pipe isolated 1500mm gland nut shaft ø 6x4.6mm shaft L 23mm shaft position upper rotation 270°		



GEV No.	390038	Ref. No.	OKI260
description	thermostat t.max. 90°C temperature range 30-90°C 3-pole 3CO 16A probe ø 6mm probe L 215mm capillary pipe 900mm capillary pipe isolatedmm gland nut shaft Lmm		



GEV No.	375038	Ref. No.	0H6217
description	thermostat t.max. 300°C temperature range 50-300°C 3-pole 3NO 16A probe ø 6mm probe L 79mm capillary pipe 1740mm capillary pipe isolated 800mm gland nut shaft ø 6x4.6mm shaft L 23mm shaft position upper rotation 270°		
accessories for	375038		
	GEV No.	110123	Ref. No. —
	knob thermostat t.max. 300°C ø 50mm shaft ø 6x4.6mm shaft flat upper black temperature range 50-300°C rotation 270°		

safety thermostats

55.13_ series



GEV No.	375854	Ref. No.	0E5086
description	safety thermostat switch-off temp. 126°C 1-pole 16A probe ø 6mm probe L 129mm capillary pipe 1730mm capillary pipe isolated 800mm gland nut M9x1 shaft ø 6x4.6mm starting temperature 120°C probe		



GEV No.	375621	Ref. No.	OK8421
description	thermostat t.max. 320°C temperature range 50-320°C 3-pole 3NO 16A probe ø 3mm probe L 219mm capillary pipe 1200mm capillary pipe isolated 1200mm gland nut shaft ø 6x4.6mm shaft L 23mm shaft position upper rotation 318°		



GEV No.	375106	Ref. No.	0H6142
description	safety thermostat switch-off temp. 190°C 1-pole 16A probe ø 3.1mm probe L 178mm capillary pipe 350mm capillary pipe isolatedmm gland nut M9x1 probe SS		

55.31_series



GEV No.	375108	Ref. No.	052331
description	safety thermostat switch-off temp. 250°C 3-pole 1x20/2x0.5A probe ø 6mm probe L 157mm capillary pipe 1230mm capillary pipe isolated 800mm gland nut probe SS		

55.32_series



GEV No.	375394	Ref. No.	0K3967
description	safety thermostat switch-off temp. 135°C 3-pole 1CO/2NC 20A probe ø 6mm probe L 73mm capillary pipe 1490mm capillary pipe isolated 1350mm gland nut M9x1 probe SS		

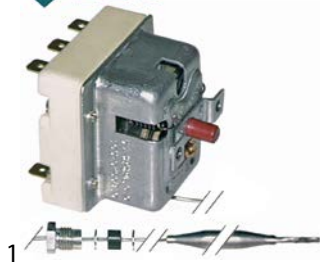

GEV No.	375150	Ref. No.	0H6219
description	safety thermostat switch-off temp. 145°C 3-pole 20A probe ø 3mm probe L 178mm capillary pipe 1790mm capillary pipe isolatedmm gland nut M9x1 probe		



GEV No.	375455	Ref. No.	002730
description	safety thermostat switch-off temp. 350°C 1-pole 16A probe ø 11mm probe L 16mm capillary pipe 900mm capillary pipe isolated 900mm gland nut probe screw-in probe probe thread M14x1		

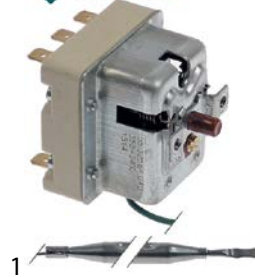

GEV No.	390141	Ref. No.	006826
description	safety thermostat switch-off temp. 350°C 3-pole 3NC 20A probe ø 6mm probe L 77mm capillary pipe 1490mm capillary pipe isolated 800mm gland nut probe SS		

control thermostats with operation switch

55.10/19_series



GEV No.	390052	Ref. No.	052330
description	thermostat t.max. 185°C temperature range 90-185°C 1-pole 1NO 15A probe ø 4mm probe L 229mm capillary pipe 2500mm capillary pipe isolated 1200/200mm gland nut shaft ø 6x4.6mm shaft L 23mm shaft position upper° rotation 270° outer switch 2NO		



55.13_series





GEV No.	375053	Ref. No.	OK5023
description	thermostat t.max. 110°C temperature range 30-110°C 1-pole 1NO 16A probe ø 6mm probe L 113mm capillary pipe 830mm capillary pipe isolated 800mm gland nut shaft ø 6x4.6mm shaft L 23mm shaft position upper rotation 270° outer switch 2NO/2NO		

55.34_series



GEV No.	375877	Ref. No.	0G2529
description	thermostat t.max. 530°C temperature range 100-530°C 3-pole 3NO 16A probe ø 3.9mm probe L 228mm capillary pipe 1110mm capillary pipe isolated 1000mm gland nut shaft ø 6x4.6mm shaft L 23mm shaft position shaft position 90° rotation 270° outer switch 0-1 with operation switch		



GEV No.	390919	Ref. No.	077018015428
description	thermostat temperature range 50-300°C 3-pole 3NO 16A probe ø 4mm probe L 292mm capillary pipe 2300mm capillary pipe isolated 2260mm gland nut shaft ø 6x4.6mm shaft L 25.5mm shaft position upper rotation 270° outer switch 49.41015.500		
spare parts for	390919		
	GEV No.	300002	Ref. No. 0A2134
	cam switch 2 operating positions 4NO 16A sequence 0-1 shaft ø 6x4.6mm shaft L 23mm connection male faston 6.3mm ceramic		
	GEV No.	550059	Ref. No. 0A2205
	connecting bow short for switch Qty 1 pcs		

accessories

gland nut accessories

locking screws



GEV No.	504738	Ref. No.	067899
description	screw connection for probe thread M12x1 ID ø 6.3mm L 18mm		
accessories for	504738		
	GEV No.	528485	Ref. No. —
	O-ring EPDM thickness 1.78mm ID ø 6.07mm Qty 1 pcs		

connecting bows



GEV No.	550059	Ref. No.	0A2205
description	connecting bow short for switch Qty 1 pcs		

switches and momentary switches

rocker/momentary rocker switches

30x11mm



GEV No.	301014	Ref. No.	OK6805
description	momentary rocker switch mounting measurements 30x11mm black 1NO 250V 16A connection male faston 6.3mm ambient temperature max. 85/125°C protection IP40 mounting ømm male faston 6.3mm		

30x22mm



GEV No.	301091	Ref. No.	OK7092
description	rocker switch mounting measurements 30x22mm red 2NO 400V 10A illuminated 0-1 connection male faston 6.3mm ambient temperature max. 125/55°C protection IP40		



microswitches

lever actuated



1

GEV No.	347006	Ref. No.	OK5144
description	microswitch with lever 250V 1NO connection with cable ambient temperature max. 85°C		



1

GEV No.	345254	Ref. No.	046286
description	microswitch with lever 250V 16A 1CO connection male faston 6.3mm ambient temperature max. 120°C mounting distance 22mm actuating force: 60g lever length 58mm		



1

GEV No.	346072	Ref. No.	0E0209
description	microswitch with lever 250V 6A 1CO connection male faston 6.3mm ambient temperature max. 85°C lever length 71mm		



1

GEV No.	345049	Ref. No.	OK3764
description	microswitch with lever CO connection male faston		

roller-lever actuated

non-standard



1

GEV No.	347008	Ref. No.	0E5629
description	microswitch with handle with a switch 250V 5A 1CO connection cable ambient temperature max. 85°C lever length 20mm		

pin-plunger actuated

M10



1

GEV No.	345032	Ref. No.	OKI395
description	microswitch with plunger thread M10x1 thread L 12mm 250V 16A 1CO connection male faston 6.3mm stroke 7mm mounting distance 22mm L 28mm ambient temperature max. 125°C type SP9603 actuating force: 180g		

M12



1

GEV No.	347009	Ref. No.	OK7633
description	microswitch with plunger thread M12x1 380V 20A 1CO connection screw ambient temperature max. 85°C		

non-standard



1

GEV No.	345777	Ref. No.	004288
description	microswitch		

position switches

TELEMECANIQUE (EFA)



1

GEV No.	346807	Ref. No.	OK4382
description	position switch plastic 1NO/1NC 400V 3A L 116.7mm W 40mm H 36mm protection IP67 actuating force: 1800g screw connection M19 mounting distance 30x60mm		



float switches

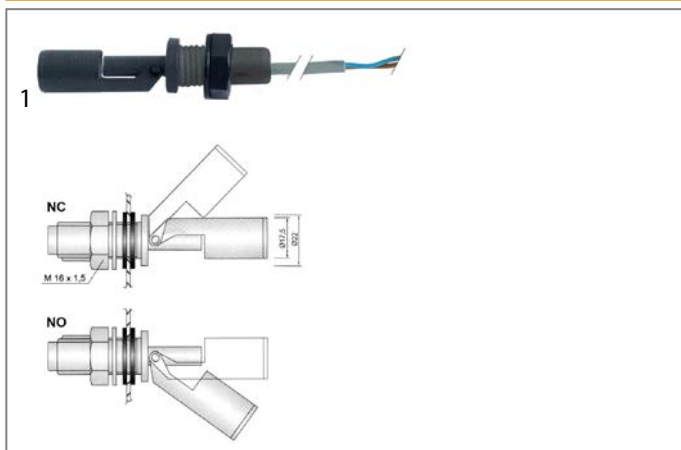

GEV No.	345484	Ref. No.	OE5808
description	float switch thread M16x1.5 1NO or 1NC ø 17.5mm L 92mm mounting ø 16mm 250V 1A cable cable length 2000mm		

cam switches

on/off

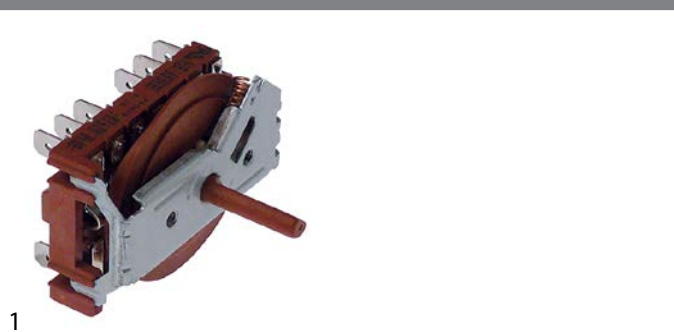

GEV No.	300218	Ref. No.	OE5222
description	cam switch 2 operating positions 6NO sequence 0-1 16A shaft ø 6x4.6mm shaft L 23mm connection male faston 6.3mm plastic		

4-position



GEV No.	300007	Ref. No.	OH6602
description	cam switch 4 operating positions 1NO/2CO sequence 0-1-2-3 16A shaft ø 6x4.6mm shaft L 23mm connection male faston 6.3mm 4-position ceramic		

7-position



GEV No.	300004	Ref. No.	OK6627
description	cam switch 7 operating positions 1NO/2CO sequence 0-1-2-3-4-5-6 16A shaft ø 6x4.6mm shaft L 23mm connection male faston 6.3mm 7-position ceramic		

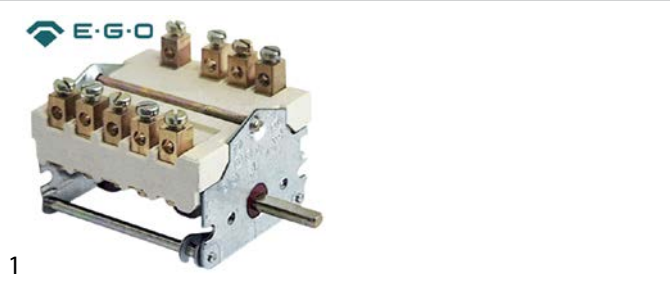

GEV No.	300106	Ref. No.	0A2022
description	cam switch 7 operating positions 1NO/2CO sequence 0-1-2-3-4-5-6 32A shaft ø 6x4.6mm shaft L 23mm connection screw 7-position shaft flat upper		



GEV No.	300237	Ref. No.	18005022
description	cam switch 7-position shaft ø 6x4.6mm shaft L 23mm ambient temperature max. 150°C		

with potentiometer

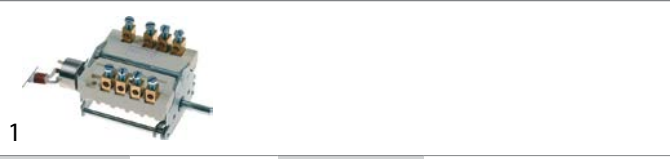

GEV No.	346984	Ref. No.	OK5063
description	cam switch 2 operating positions 4NO sequence 0-1 32A shaft ø 6x4.6mm shaft L 23mm connection cable 2400mm cable length 2400mm 50kOhm ceramic		



operation switches

E-G-O



1

GEV No.	300002	Ref. No.	0A2134
description	cam switch 2 operating positions 4NO 16A sequence 0-1 shaft \varnothing 6x4.6mm shaft L 23mm connection male faston 6.3mm ceramic		

E-G-O



1

GEV No.	300080	Ref. No.	026945
description	cam switch 2 operating positions 4NO 16A sequence 0-1 shaft \varnothing 6x4.6mm shaft L 23mm connection screw operation switch ceramic ambient temperature max. 150°C		

accessories for 300080

GEV No.	551456	Ref. No.	—
gasket for switch ED \varnothing 14mm ID \varnothing 2.5mm thickness 3.5mm white			

E-G-O



1

GEV No.	300200	Ref. No.	054375
description	operation switch 2 operating positions 2NO 16A sequence 0-1 shaft \varnothing 6x4.6mm shaft L 23mm connection male faston 6.3mm operation switch ceramic		

miscellaneous



1

GEV No.	300221	Ref. No.	0E5131
description	cam switch 2 operating positions 4NO sequence 1-2 16A shaft \varnothing 6x4.6mm shaft L 23mm connection male faston 6.3mm plastic		

rotary switches

GOTTAK



1

GEV No.	300219	Ref. No.	0E5132
description	switch 3 operating positions 3NO sequence 0-1 momentary switch 16A shaft \varnothing 6x4.6mm shaft L 23mm connection male faston 6.3mm plastic		

KRAUS & NAIMER

rotary switches



1

GEV No.	301206	Ref. No.	0K4923
description	rotary switch 4 0-1-2-3 sets of contacts 8 type CA11-AT08A188 690V 7.5A shaft \varnothing 4.8x6mm shaft L 18mm shaft round connection screw code 37/000100 marking 7BC540		

miscellaneous



1

GEV No.	346390	Ref. No.	0K4925
description	rotary switch sets of contacts 1 2 0-1 250V 16A illuminated connection male faston 6.3mm mounting measurements 25x25mm		

magnetic switches

35x22mm

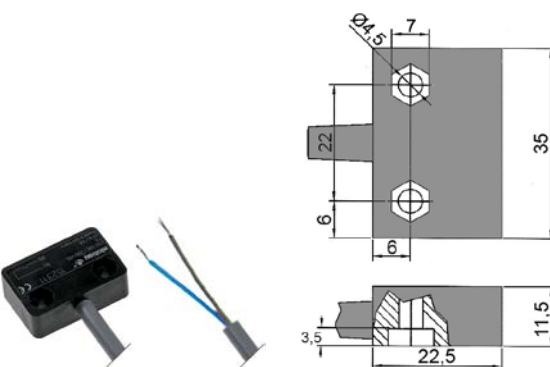

1

GEV No.	347003	Ref. No.	0K7171
description	magnetic switch L 35mm W 22mm 1NO 230V 1A 60W		



36x26mm

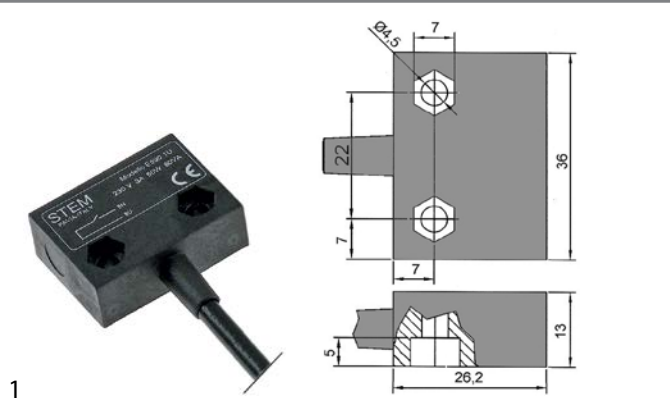

GEV No.	346998	Ref. No.	049966
description	magnetic switch L 36mm W 26mm 1NO 230V 3A P max. 60W connection cable cable length 2000mm		
accessories for	346998		
	GEV No.	347001	Ref. No. 088361
	magnet ømm L 23mm H 18mm W 16mm ID ømm ED ømm M5		

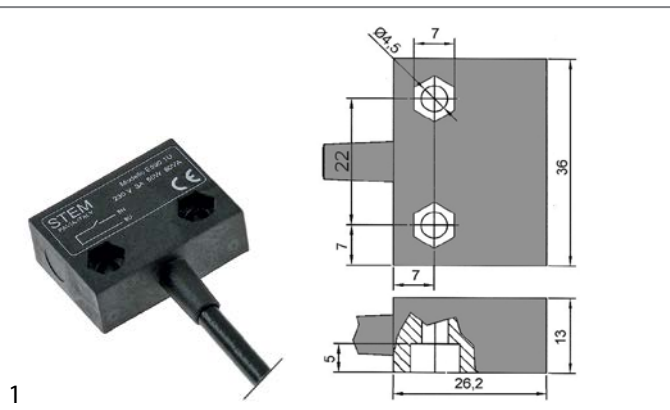

GEV No.	347000	Ref. No.	049967
description	magnetic switch L 36mm W 26mm 1NO 230V 3A P max. 60W connection cable cable length 5500mm		

accessories

magnets

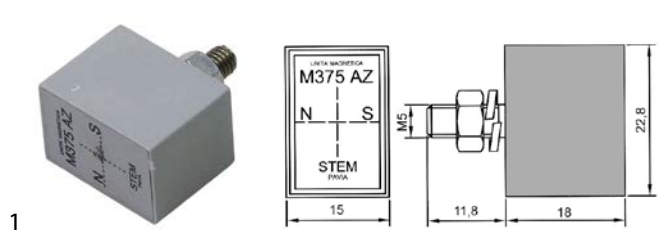

GEV No.	347001	Ref. No.	088361
description	magnet ømm L 23mm H 18mm W 16mm ID ømm ED ømm M5		

miscellaneous

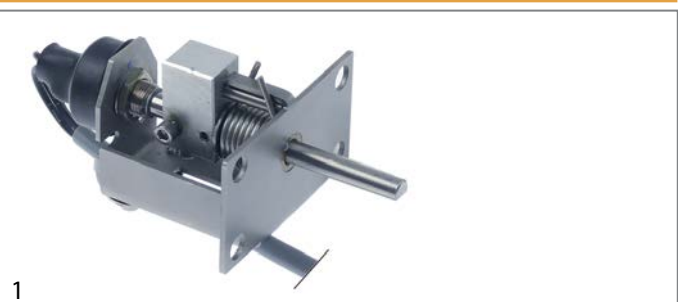

GEV No.	347830	Ref. No.	769045-01
description	switch for tilting kettle with potentiometer		
accessories for	347830		
	GEV No.	347831	Ref. No. —
	stop for switch shaft ø 6x4.6mm		

control equipment

lamps



GEV No.	359606	Ref. No.	OK2043
description	neon light bulb socket Ba9s 220V 2W clear ø 10mm L 28mm		
accessories for	359606		
	GEV No.	359832	Ref. No. —
	lamp socket mounting measurements ø16.2mm socket Ba9s connection male faston 6.3mm		
	GEV No.	359853	Ref. No. —
	lamp socket mounting measurements ø18.2mm socket Ba9s connection male faston 6.3mm		



GEV No.	359807	Ref. No.	OK9110
description	light bulb socket Ba9s 24V 2W ø 10mm L 28mm clear		

encoders and potentiometers



GEV No.	346984	Ref. No.	OK5063
description	cam switch 2 operating positions 4NO sequence 0-1 32A shaft ø 6x4.6mm shaft L 23mm connection cable 2400mm cable length 2400mm 50kOhm ceramic		



1

GEV No.	402070	Ref. No.	OG0317
description	potentiometer 10KOhm rotation 360° shaft ø6x4.6mm shaft L 18mm connection male faston 2.8mm thread M10x0.75 thread L 9mm		



1

GEV No.	402071	Ref. No.	OG2907
description	potentiometer cable length 1200mm		

lamps

indicator lights

indicator lights 2-piece (lens and indicator lamp)

indicator light lenses

ø10mm (type SRZ-3)



1

GEV No.	359123	Ref. No.	004896
description	indicator light housings mounting measurements ø10mm green round Qty 1 pcs		
accessories for	359123		
	GEV No.	Ref. No.	—
	359132		
description	indicator lamp green 250V connection male faston 6.3mm protection IP54 ambient temperature max. 85°C		

indicator lamps for socket type SRZ / SDK / SDY / SFK



1

GEV No.	359133	Ref. No.	OKI362
description	indicator lamp 400V green connection male faston 6.3mm		

indicator lights 3-piece (housing, lens and bulb)

lamps

light bulbs



1

GEV No.	359807	Ref. No.	OK9110
description	light bulb socket Ba9s 24V 2W ø 10mm L 28mm clear		

neon light bulbs



1

GEV No.	359606	Ref. No.	OK2043
description	neon light bulb socket Ba9s 220V 2W clear ø 10mm L 28mm		
accessories for	359606		
	GEV No.	Ref. No.	—
	359832		
description	lamp socket mounting measurements ø16.2mm socket Ba9s connection male faston 6.3mm		
	GEV No.	Ref. No.	—
	359853		
description	lamp socket mounting measurements ø18.2mm socket Ba9s connection male faston 6.3mm		



1

GEV No.	359602	Ref. No.	OH7036
description	neon light bulb socket E14 230V clear ø 14mm L 30mm		



1

GEV No.	359603	Ref. No.	OH7037
description	neon light bulb socket E14 380V clear ø 14mm L 30mm		

indicator lights (complete)

ø10mm

with screw socket



1

GEV No.	359378	Ref. No.	0A2224
description	indicator light ø 10mm 230V green connection male faston 6.3mm socket screw base		

ø12.5mm





1

GEV No.	359999	Ref. No.	OK9096
description	indicator light ø 12.5mm 230V clear connection male faston 6.3mm		





ø14mm			
with plug-in socket			
			
1			
GEV No.	359150	Ref. No.	053153
description	indicator light ø 14mm red 400V connection male faston 6.3mm temp.-resist. 105°C square		

ø19mm			
			
1			
GEV No.	359519	Ref. No.	0K4898
description	indicator light housings mounting measurements ø19mm socket E14 clear		

ø20mm			
			
1			
GEV No.	359516	Ref. No.	0K4903
description	indicator light ø 20mm 230V clear		



			
1			
GEV No.	359514	Ref. No.	18003964
description	indicator light ø 20mm 230V green connection male faston 6.3mm ambient temperature max. 125°C		

ø22mm			
			
1			
GEV No.	359506	Ref. No.	0K5094
description	indicator light ø 22mm 230V green connection screw temp.-resist. 60°C		

			
1			
GEV No.	359512	Ref. No.	0K6368
description	indicator light ø 22mm 400V clear connection screw temp.-resist. 60°C		

			
1			
GEV No.	359510	Ref. No.	0K6366
description	indicator light ø 22mm 400V green connection screw temp.-resist. 60°C		

miscellaneous			
			
1			
GEV No.	359006	Ref. No.	0K3776
description	indicator light white 230V		

screw-on/push-on fit				
neon light bulbs				
				
1				
GEV No.	359606	Ref. No.	0K2043	
description	neon light bulb socket Ba9s 220V 2W clear ø 10mm L 28mm			
accessories for	359606			
	GEV No.	359832	Ref. No.	—
	lamp socket mounting measurements ø16.2mm socket Ba9s connection male faston 6.3mm			
	GEV No.	359853	Ref. No.	—
	lamp socket mounting measurements ø18.2mm socket Ba9s connection male faston 6.3mm			

			
1			
GEV No.	359602	Ref. No.	0H7036
description	neon light bulb socket E14 230V clear ø 14mm L 30mm		

			
1			
GEV No.	359603	Ref. No.	0H7037
description	neon light bulb socket E14 380V clear ø 14mm L 30mm		

light bulbs			
for ovens			
			
1			
GEV No.	359612	Ref. No.	054840
description	light bulb t.max. 300°C socket E14 25W 230V ø 25mm L 56mm lens L 30mm for oven lamp type Philips		

for indicator lights



1

GEV No.	359807	Ref. No.	OK9110
description	light bulb socket Ba9s 24V 2W ø 10mm L 28mm clear		

oven lamps

universal oven lamps

55x100mm



1

GEV No.	359714	Ref. No.	055022
description	gasket for bulb socket		



1

GEV No.	101372	Ref. No.	OK7521	
description	oven lamp complete L 100mm W 55mm 230V 25W socket E14 rectangular temp.-resist. 300°C connection male faston 6.3mm			
spare parts for	101372			
	GEV No.	359612	Ref. No.	054840
	description	light bulb t.max. 300°C socket E14 25W 230V ø 25mm L 56mm lens L 30mm for oven lamp type Philips		
	GEV No.	359698	Ref. No.	—
	description	lamp socket L 100mm W 55mm socket E14 connection male faston 6.3mm		
	GEV No.	359714	Ref. No.	055022
	description	gasket for bulb socket		
	GEV No.	359715	Ref. No.	—
	description	lamp glass L 110mm W 65mm thickness 5mm		
	GEV No.	359716	Ref. No.	—
	description	frame for bulb socket		

lamps

light bulbs



1

GEV No.	359612	Ref. No.	054840
description	light bulb t.max. 300°C socket E14 25W 230V ø 25mm L 56mm lens L 30mm for oven lamp type Philips		

timers

programme timers



1

GEV No.	360349	Ref. No.	069926	
description	timer CDC 11803 engines 1 chambers 3 operation time 150s 230V shaft ømm shaft Lmm manuf. no. 11803F1BEE000.0010 motor type M48R ATS type 11803F1 / 238046			
spare parts for	360349			
	GEV No.	360673	Ref. No.	—
	description	motor kit pinion ø 6.8mm teeth 15 230V voltage AC 50/60Hz turn direction clockwise motor ø 48mm H 18.5mm motor type UDS-40NE1RNZ165 cable length 150mm with holder		

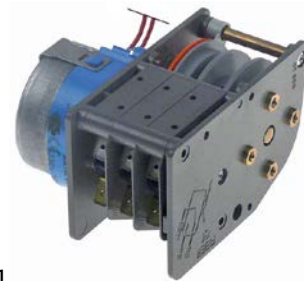

1

GEV No.	360024	Ref. No.	069926 (old version)	
description	timer FIBER P25 engines 1 chambers 3 operation time 2min 230V shaft ømm shaft Lmm manuf. no. P255J03H3N6 motor type M51B-JOL6400			
spare parts for	360024			
	GEV No.	360674	Ref. No.	—
	description	motor kit pinion ø 6.8mm teeth 15 230V voltage AC 50/60Hz turn direction counterclockwise motor ø 48mm H 18.5mm motor type UDS40NE1RNZ165 cable length 150mm with holder		



mechanical timers



1

GEV No.	350170	Ref. No.	0H6114
description	timer 600 2-pole operation time 60min impulse mechanical 2NO at 250V 16A permanent position no shaft 6x4.6mm shaft L 21mm mounting distance 28mm		

contactors

BENEDIKT & JÄGER

power contactors



1

GEV No.	380777	Ref. No.	0K9134
description	auxiliary contactor resistive load 20A 230VAC main contacts 4NO type K2-07A40230		



1

GEV No.	380773	Ref. No.	0L0285
description	power contactor resistive load 25A 230VAC (AC3/400V) 10A/4kW main contacts 3NO auxiliary contacts 1NC connection screw connection type K3-10A01230		



1

GEV No.	380679	Ref. No.	003598
description	power contactor resistive load 25A 230VAC (AC3/400V) 12A/5.5kW main contacts 3NO auxiliary contacts 1NO connection screw connection type K2-12A01230		



1

GEV No.	380674	Ref. No.	0H7051
description	power contactor resistive load 25A 230VAC (AC3/400V) 12A/5.5kW main contacts 4NO connection screw connection type K2-12A0040230		



1

GEV No.	381079	Ref. No.	004012
description	power contactor resistive load 25A 230VAC (AC3/400V) 16A/7.5kW main contacts 3NO auxiliary contacts 1NO connection screw connection type K2-16A10230		



1

GEV No.	380779	Ref. No.	0K3968
description	power contactor resistive load 25A 24VAC (AC3/400V) 14A/5.5kW main contacts 3NO auxiliary contacts 1NO connection screw connection type K3-14ND10		



1

GEV No.	380789	Ref. No.	0K9132
description	power contactor resistive load 32A 230VAC main contacts 3 auxiliary contacts 1 with 2 auxiliary contacts NC		

1

GEV No.	381171	Ref. No.	0K9124
description	power contactor resistive load 32A 24VAC (AC3/400V) 22A/11kW main contacts 3NO auxiliary contacts 1NO connection screw connection type K3-22ND10		



1

GEV No.	380637	Ref. No.	054928
description	power contactor resistive load 45A 230VAC main contacts 3NO auxiliary contacts 1NO connection screw type K2-23A10 230		



1

GEV No.	380776	Ref. No.	007104
description	power contactor resistive load 80A 230VAC (AC3/400V) 40A/18.5kW main contacts 3NO auxiliary contacts connection screw connection type K3-40A00230 contacts		



1

GEV No.	380676	Ref. No.	0TRA70
description	power contactor resistive load 80A 230VAC (AC3/400V) 45A/20kW main contacts 3NO connection screw connection type K2-45A00230		

auxiliary contacts



1

GEV No.	380677	Ref. No.	047046
description	auxiliary contact contacts 1NC AC15 10A for contactors K2/K3 connection screw type HN01 AC1 25A		



1

GEV No.	380678	Ref. No.	046995
description	auxiliary contact contacts 1NO AC15 10A for contactors K2/K3 connection screw type HN10 AC1 25A		



1

GEV No.	380781	Ref. No.	048497
description	auxiliary contact contacts 1NO AC15 6A for contactors K2/K5 connection screw type HA10 AC1 25A		

solid state relays

CRYDOM



1

GEV No.	403038	Ref. No.	0K5070
description	solid state relay CRYDOM 1 phase 50A 480V 4-32VDC L 57mm W 45mm screw type CWD4850P		

relays

power relays

with bracket mounting



1

GEV No.	380702	Ref. No.	005033
description	power relays FINDER 230VAC 16A 3NO connection male faston 6.3mm flange dimensions 36x38x68mm manuf. no. 62.83.8.230.0300 230V		

with male contacts

bullet connectors, 11 contacts



1

GEV No.	380132	Ref. No.	0K3700	
description	power relays Italiana Relè 230VAC 10A 3CO connection plug-in connection round 11-pole manuf. no. C43-230AC ZVE11 250V 11-pole			
accessories for	380132			
	GEV No.	380136	Ref. No.	—
	relay socket 11-pole connection plug-in connection round 11-pole dimensions 65x28x40mm 250V voltage AC 10A Italiana Relè manuf. no. ZVE11			

female contact 4.8mm





1

GEV No.	380475	Ref. No.	0K4944	
description	power relays FINDER 220-240VAC 12A 2CO connection F4.8 raster size 10mm plug-in connection manuf. no. 56.32.8.230.0040 250V 2-pole connection 4.8mm			
accessories for	380475			
	GEV No.	380476	Ref. No.	—
	relay socket dimensions 78x27x33.5mm 250V voltage AC 10A FINDER manuf. no. 96.72			

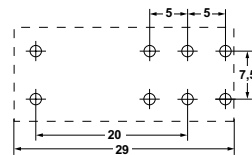
plug-in/print relays



1

GEV No.	380333	Ref. No.	0E5849	
description	print relay 230VAC 2CO at 250V 8A connection pins raster size 5mm FINDER manuf. no. 40.52.8.230.0000 95.65/95.75			
accessories for	380333			
	GEV No.	380340	Ref. No.	—
	relay socket dimensions 62x36x15mm 250V voltage AC 10A Italiana Relè manuf. no. ZMEM/5			
	GEV No.	380505	Ref. No.	—
	relay socket 2CO 40.52 dimensions 81.9x15.5x75mm 250V voltage AC 10A FINDER manuf. no. 95.95.3			
	GEV No.	381181	Ref. No.	—
	relay socket 2-pole 40.51/40.52/40.61 connection screw clamp dimensions 15.8x78.6mm 250V voltage AC 10A FINDER manuf. no. 95.75			

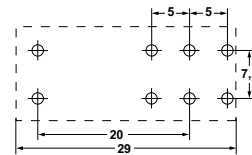

1

GEV No.	380853	Ref. No.	0E5172
description	print relay 24VAC 1CO at 250V 16A connection pins raster size 5mm FINDER manuf. no. 40.61.8.024.0000 95.65/95.75		

time relays

time relays



1

GEV No.	360407	Ref. No.	075659
description	timer FINDER T23522203F0 time range 0.5s-120h 24VAC 2x6A mounting measurements 45x70mm 2CO		



transformers

toroidal core transformers

			
1			
GEV No.	401663	Ref. No.	OL0174
description	transformer primary 230V secondary 12V 25VA		

encapsulated transformers

with screw connection

			
1			
GEV No.	401665	Ref. No.	OL1158
description	transformer primary 230/400V secondary 24-48V 400VA connection screw 50-60Hz		

for lighting

			
1			
GEV No.	401547	Ref. No.	002856
description	transformer primary 230V secondary 11.5V 50W		

electronic controllers

ELIWELL

universal controllers

built-in version

			
1			
GEV No.	379559	Ref. No.	OS0989
description	electronic controller ELIWELL type IC901 mounting measurements 71x29mm 12V voltage AC/DC NTC/PTC relay outputs 1 relay refrigeration front measurements 74x32mm built-in depth 60mm protection IP65 accuracy superior to 0.5% from final value% defr. funct. no -55 up to +150°C display 2½ digit Templ1 yes 15A		
accessories for	379559		
	GEV No.	379053	Ref. No. —
	temperature probe PTC 1kOhm cable PVC probe -50 up to +150°C cable -10 up to 100°C probe ø6x30mm cable length 3m without screw connection 2-wire		
	GEV No.	379064	Ref. No. —
	temperature probe PTC 1kOhm cable silicone probe -50 up to +150°C cable -50 up to +180°C probe ø6x40mm cable length 3m without screw connection 2-wire		
	GEV No.	379161	Ref. No. —
	temperature probe NTC 10kOhm cable thermoplastic probe -40 up to +110°C cable -40 up to +110°C probe ø6x14mm cable length 3m without screw connection 2-wire		
	GEV No.	379782	Ref. No. —
	temperature probe PTC 1kOhm cable thermoplastic probe -50 up to +150°C cable -40 up to +110°C probe ø6x14mm cable length 3m 2-wire resistor 1kOhm		

			
1			
GEV No.	379690	Ref. No.	OS0789
description	electronic controller ELIWELL type ICP16D0750000 mounting measurements 71x29mm 230V voltage AC NTC/PTC relay outputs 1 CO-15A(8) NTC/PTC built-in depth 60mm defr. funct. -50 up to +150°C display 3½ digits		
accessories for	379690		
	GEV No.	378194	Ref. No. —
	temperature probe NTC 10kOhm cable PVC probe -20 up to +80°C cable -10 up to 100°C probe ø7x24.5mm cable length 1.5m without screw connection 2-wire		
	GEV No.	379052	Ref. No. —
	temperature probe PTC 1kOhm cable silicone probe -50 up to +150°C cable -50 up to +180°C probe ø6x40mm cable length 1.5m without screw connection 2-wire		
	GEV No.	379053	Ref. No. —
	temperature probe PTC 1kOhm cable PVC probe -50 up to +150°C cable -10 up to 100°C probe ø6x30mm cable length 3m without screw connection 2-wire		

Table continues overleaf



accessories for	379690		
GEV No.	379057	Ref. No.	—
description	temperature probe NTC 10kOhm cable PVC probe -20 up to +80°C cable -10 up to 100°C probe ø6x25mm cable length 3m 2-wire		
GEV No.	379064	Ref. No.	—
description	temperature probe PTC 1kOhm cable silicone probe -50 up to +150°C cable -50 up to +180°C probe ø6x40mm cable length 3m without screw connection 2-wire		
GEV No.	379142	Ref. No.	—
description	temperature probe PTC 1kOhm cable PVC probe -50 up to +150°C cable -10 up to 100°C probe ø6x30mm cable length 1.5m without screw connection 2-wire		
GEV No.	379160	Ref. No.	—
description	temperature probe NTC 10kOhm cable thermoplastic probe -40 up to +110°C cable -40 up to +110°C probe ø6x14mm cable length 1.5m without screw connection 2-wire		
GEV No.	379161	Ref. No.	—
description	temperature probe NTC 10kOhm cable thermoplastic probe -40 up to +110°C cable -40 up to +110°C probe ø6x14mm cable length 3m without screw connection 2-wire		
GEV No.	379343	Ref. No.	—
description	temperature probe NTC 10kOhm cable silicone probe -40 up to +110°C cable -50 up to +180°C probe ø6x40mm cable length 3m 2-wire		
GEV No.	379458	Ref. No.	—
description	temperature probe NTC 10kOhm cable silicone probe -40 up to +110°C cable -50 up to +180°C probe ø6x40mm cable length 1.5m without screw connection 2-wire		
GEV No.	379781	Ref. No.	—
description	temperature probe PTC 1kOhm cable thermoplastic probe -50 up to +150°C cable -40 up to +110°C probe ø6x14mm cable length 1.5m without screw connection 2-wire		
GEV No.	379782	Ref. No.	—
description	temperature probe PTC 1kOhm cable thermoplastic probe -50 up to +150°C cable -40 up to +110°C probe ø6x14mm cable length 3m 2-wire resistor 1kOhm		



GEV No.	400910	Ref. No.	0C0202
description	temperature probe NTC 10kOhm cable silicone probe -40 up to +110°C cable -50 up to +180°C connection coded plug thread probe ø4.5x30mm cable length 0.35m		



GEV No.	379404	Ref. No.	0K8490
description	temperature probe Pt1000 cable glass fibre probe -70 up to +500°C cable -50 up to +350°C connection male faston thread probe ø4x60mm cable length 1.6m		



GEV No.	379100	Ref. No.	0C5342
description	temperature probe Pt1000 cable silicone probe -70 up to +500°C cable -50 up to +180°C connection male faston 4.8mm thread probe ø4x235mm cable length 1.8m		

accessories for	379100		
GEV No.	693745	Ref. No.	—
description	gasket PTFE ED ø 20mm ID ø 15mm thickness 1mm Qty 1 pcs		
GEV No.	697993	Ref. No.	—
description	sleeve for temperature probe ø 11mm ID ø 4.3mm H 22.4mm		



GEV No.	378012	Ref. No.	0K5047
description	temperature probe PTC 2kOhm cable probe -50 up to +150°C cable°C connection F6.3 thread M10x1 cable lengthm		

miscellaneous

miscellaneous			
GEV No.	381419	Ref. No.	712.340.179
description	electronic controller kit type ERT4V 230V Pt1000 +50 up to +130°C relay outputs 1CO		



GEV No.	402005	Ref. No.	086344
description	temperature probe PTC 2kOhm cable TPE probe -50 up to +150°C cable -40 up to +110°C connection plug thread probe ø6x50mm cable length 1.6m		

probes

producer-specific probes

probes			
GEV No.	379476	Ref. No.	0K5154
description	probe Pt1000 cable PTFE probe -100 up to 450°C cable -40 up to +250°C connection male faston 4.8mm thread probe ø6/10x22mm cable length 2m		



GEV No.	379427	Ref. No.	0K5058
description	temperature probe thermocouple K (NiCr-Ni) cable glass fibre probe -50 up to 1150°C cable -50 up to +350°C connection 2-wire thread probe ø4x20mm cable length 2.6m		



GEV No.	379098	Ref. No.	0K5623
description	temperature probe thermocouple K (NiCr-Ni) cable Vetrotex probe -50 up to 1150°C cable -50 up to +350°C connection 2-wire thread M6/M10 probe ø6x20mm cable length 2.1m		



core probes



1

GEV No.	379407	Ref. No.	OK8488
description	core temperature probe Pt1000 cable SS corrugated hose probe -40 up to +250°C cable -40 up to +250°C connection 2-wire probe ø4x100mm thread M8 cable length 2.7m handle ø 10mm handle length 45mm		



1

GEV No.	379060	Ref. No.	002673
description	core temperature probe Pt1000 cable SS corrugated hose probe -40 up to +250°C cable -40 up to +250°C connection 2-wire probe ø4x100mm thread M8 cable length 2m handle ø 10mm handle length 45mm		

accessories

adapters



1

GEV No.	379093	Ref. No.	OK5057
description	bayonet adapter L 18mm thread M6x1 ID ø 7/4mm ED ø 12mm		





1

GEV No.	378127	Ref. No.	OKI657
description	bayonet adapter L 32mm thread M6x1 ID ø 7/4mm ED ø 12mm		



1

GEV No.	379094	Ref. No.	OG2155
description	bayonet adapter L 39mm thread M6x1 ID ø 7/4mm ED ø 12mm		
accessories for	379094		
	GEV No.	Ref. No.	—
	379092		
description	temperature probe thermocouple K (NiCr-Ni) cable silicone probe -50 up to 1150°C cable -50 up to +180°C connection 2-wire thread probe ø4x20mm cable length 2.6m		



1

GEV No.	378128	Ref. No.	0KE127
description	bayonet adapter L 59mm thread M6x1 ID ø 7/4mm ED ø 12mm		

miscellaneous



1

GEV No.	550924	Ref. No.	002075
description	gasket for probe ID ø 6mm EPDM		

electronics

PCBs



1

GEV No.	401575	Ref. No.	OK4880
description	control PCB		



1

GEV No.	400929	Ref. No.	048926
description	PCB		



1

GEV No.	401964	Ref. No.	OK5071
description	PCB		

1

GEV No.	401573	Ref. No.	OK4882
description	power PCB		

Triacs



1

GEV No.	402072	Ref. No.	OK5065
description	Triac		

keypads

front foils



1

GEV No.	401574	Ref. No.	OK4333
description	keypad foil		

membrane keypads



1

GEV No.	400915	Ref. No.	049956
description	membrane keypad		

accessories



1

GEV No.	400997	Ref. No.	002670
description	push button		

solenoid valves

solenoid valves (water)

ROBERTSHAW/INVENSYS

medium temperature: 90°C 90°C 60°C
 ambient temperature: 60°C 25°C 60°C
 duty cycle: 40% 100% 100%



1

GEV No.	372021	Ref. No.	OK5389
description	solenoid valve double straight 230VAC inlet 3/4" outlet 11.5mm DN10 EATON (INVENSYS)		

spare parts and accessories

reducers

outlet side



1

GEV No.	371252	Ref. No.	OK5369
description	reducer type EATON (INVENSYS) flow rate 1.2l/min pressure range 0 up to 10bar tolerance ±15/25% blue		



1

GEV No.	371253	Ref. No.	OK5368
description	reducer type EATON (INVENSYS) flow rate 2.5l/min pressure range 0 up to 10bar tolerance ±15/25% brown		

TP

solenoid valves with reducers



1

GEV No.	370375	Ref. No.	0F0001
description	solenoid valve triple straight 230VAC inlet 3/4" outlet 11.5mm t.max. 90°C TP plastic output A 2.5l/min output C 0.25l/min flow regulating valve outlet A yellow flow regulating valve outlet C red		



solenoid valves (gas)

BRAHMA

spare parts and accessories

solenoid coils



1

GEV No.	101968	Ref. No.	005548
description	solenoid valve 230VAC 20VA seat ø 17mm coil type 13902001 BRAHMA		

ball valves electric



1

GEV No.	401139	Ref. No.	0C0882
description	ball valve inlet 3/4" IT outlet 3/4" IT with plug 230V L 65mm 50/60Hz closed off-current mode of operation electric connection cable 200mm		

pressure switches

for boiling pans



1

GEV No.	541459	Ref. No.	0G2935
description	pressure control with cable		

electrodes



1

GEV No.	400121	Ref. No.	055346
description	level electrode 1/4" total length 121mm probe L 94mm insulated probe length 90mm PTFE insulated connection angled, male faston 6.3mm stainless steel		

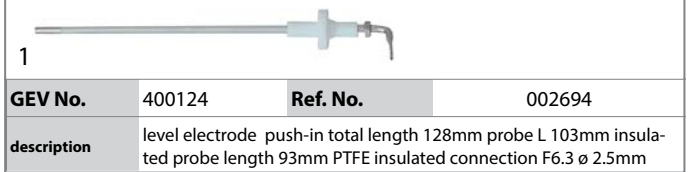

1

GEV No.	400124	Ref. No.	002694
description	level electrode push-in total length 128mm probe L 103mm insulated probe length 93mm PTFE insulated connection F6.3 ø 2.5mm		

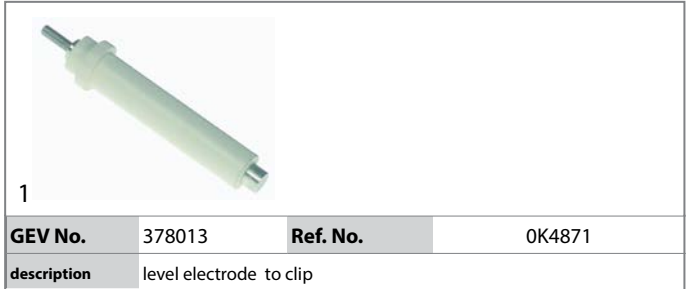

1

GEV No.	378013	Ref. No.	0K4871
description	level electrode to clip		



fans

axial fans

import



1

GEV No.	601080 ¹	Ref. No.	0C4423	
description	axial fan L 119mm W 119mm H 38mm 230VAC 50/60Hz 23/20W bearing ball bearing connection male faston 2.8mm metal ADDA fan wheel ø 110mm temp.-resist. 70°C			
accessories for	601080			
	GEV No.	550898	Ref. No.	—
	connecting cable cable length 2000mm connection F 2.8 connection distance 7.9mm for axial flow fan			
	GEV No.	692519	Ref. No.	—
	guard L 120mm W 120mm plastic			

¹with ball bearings

refrigeration fans

cold air circulating fans (complete)

ebm-papst

R2E series



GEV No.	601536	Ref. No.	0E5666
description	fan R2E190-A026-73 fan wheel ø 190mm blades 6 230V 50/60Hz 58/75W ø 190mm H 70mm 2700rpm cable length 450mm rotation direction right ebm-papst sucking suitable capacitor 2µF		
spare parts for	601536		
	GEV No.	365170	Ref. No.
	capacitor capacity 2µF 425V tolerance 5% 50/60Hz ambient temperature max. -25 to +85°C ø 25mm L 49mm M8 plastic connection cable 250mm 416.17.74 protection		

cross flow fans

ebm-papst



GEV No.	601505	Ref. No.	0K5059
description	cross flow fan QLN65/2400A17-3030L roller ø 65mm roller length 240mm laminated core thickness 29mm motor position right 230V/50Hz 22W refrigeration bearing silicone connection F 6.3 0 up to +60°C 230V throughput 200m³/h 50Hz		

COPREL

double fans



GEV No.	601026	Ref. No.	0K3707
description	cross flow fan COPREL TFD(FD) roller ø 60mm roller length 2x180mm laminated core thickness 35mm motor position centre 230V/50-60Hz 42W refrigeration bearing rubber connection male faston 6.3mm coil type airflow 255m³/h -10 up to +60°C		

hot air motors

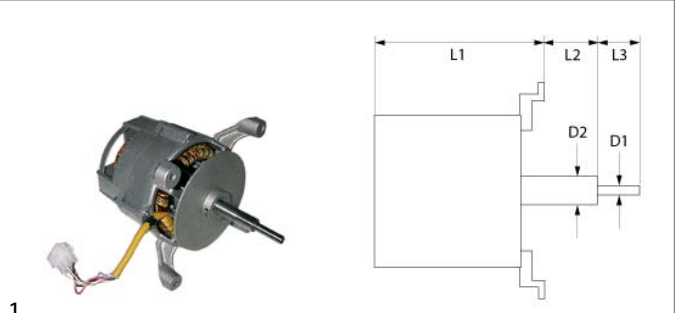

GEV No.	500141	Ref. No.	0F0007
description	fan motor 230V 1 phase 50/60Hz 0.19kW 1450/1750rpm speeds 1 L1 150mm L2 52mm L3 35mm D1 ø 9/10mm D2 ø 14mm M6R IT 1.3A Cos(φ) 0.91 at 50Hz 1450rpm at 60Hz 1750rpm type LM80/4 no. 596477 shaft flat length 12mm		



GEV No.	601220	Ref. No.	0C6462
description	fan wheel D1 ø 280mm H1 100mm blades 6 D2 ø 10mm D3 ø 10mm H2 37mm H3 22mm		



GEV No.	511300	Ref. No.	002873
description	O-ring Viton thickness 3.53mm ID ø 28.17mm for 57 series for motor shaft		



GEV No.	511301	Ref. No.	002699
description	shaft seal ID ø 16mm ED ø 38mm thickness 18mm		





hot air fans

miscellaneous

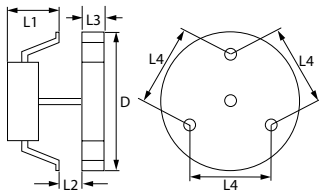

1



GEV No.	601011	Ref. No.	031484
description	hot air fan 220-240V 40W 50/60Hz L1 65mm L2 15mm L3 25mm L4 87mm fan wheel ø 150mm FIME type C25R8023CLH		
accessories for	601011		
	GEV No.	550879	Ref. No. —
	insulation ø 130mm thickness 3mm hole ø 20mm for hot air fan		
	GEV No.	601260	Ref. No. —
	nut thread M6L IT for hot air fan		

motors

gear motors

for tilting bratt pans



1

GEV No.	501580	Ref. No.	763001 763090
description	gear motor SKF/ATB type MAX30-C220450A101N0-005 24V L 490mm W 185mm H 120mm		

miscellaneous



1

GEV No.	500620	Ref. No.	0K4843
description	gear motor for kettle		

spindle motors

SKF/ATB



1

GEV No.	501580	Ref. No.	763001 763090
description	gear motor SKF/ATB type MAX30-C220450A101N0-005 24V L 490mm W 185mm H 120mm		

pumps







wash and rinse pumps

ALBA (C&A)

pumps



1

GEV No.	500090	Ref. No.	046370
description	pump inlet ø 45mm outlet ø 40mm type C5803 230V 50Hz 1 phase 0.55kW 0.75HP L 210mm rotation direction right capacitor 12.5µF ALBA PUMPS (C&A)		
spare parts for	500090		
	GEV No.	365014	Ref. No. —
	operating capacitor capacity 12.5µF 450V tolerance 5%Hz ambient temperature max. -25 to +85°C ø 35mm L 70mm M8 plastic connection male faston 6.3mm 45S.C3DS.12.5 protection		
	GEV No.	504320	Ref. No. —
	pump cover gasket ID ø 160.75mm thickness 3.53mm EPDM Qty 1 pcs		
	GEV No.	509021	Ref. No. —
	impeller ø 102mm H 32mm shaft intake ø 9/8mm rotation direction right		
	GEV No.	510692	Ref. No. —
	mechanical shaft seal for shaft ø 11mm slide ring ext. ø 24mm slide ring H 13mm counter ring mounting ø 26mm height counter ring 8mm counter ring int. ø 14mm		
	GEV No.	521531	Ref. No. —
	pump cover ALBA PUMPS (C&A) inlet ø 45mm outlet ø 40mm turn direction right ø 153mm ID ø 127mm inner height 24mm		
	GEV No.	521709	Ref. No. —
	O-ring EPDM thickness 3mm ID ø 126mm Qty 1 pcs		



FIR
pumps



1

GEV No.	500985	Ref. No.	0L0437
description	pump inlet ø 62mm outlet ø 64mm type 4290.2700 220-240/380-415V 50Hz 3 phase 1.5kW 2HP L 350mm rotation direction right FIR installation kit inclusive		

spare parts for	500003		
	GEV No.	510693	Ref. No.
	mechanical shaft seal for shaft ø 12mm slide ring ext. ø 24mm slide ring H 15.5mm slide ring int. ø 11mm counter ring mounting ø 24mm height counter ring 8mm counter ring int. ø 13.5mm		

drain pumps

PLASET







1

GEV No.	500206	Ref. No.	047562
description	drain pump with auxiliary pressure connection inlet ø 25mm outlet ø 22mm 230V 90W 50Hz PLASET type 8411		

OLYMPIA
pumps



1

GEV No.	500003	Ref. No.	069540
description	pump inlet ø 45mm outlet ø 32mm type T30 230V 50Hz 1 phase 0.29kW 0.39HP L 190mm rotation direction right capacitor 8µF OLYMPIA		
spare parts for	500003		
	GEV No.	365013	Ref. No.
	operating capacitor capacity 8µF 400V tolerance 5%Hz ambient temperature max. -25 to +85°C ø 31.5mm L 55mm M8 plastic connection male faston 6.3mm protection		
	GEV No.	510512	Ref. No.
	pump cover OLYMPIA inlet ø 45mm outlet ø 31mm outlet 2 ø 24 turn direction right ø 130mm ID ø 124mm inner height 20mm		
	GEV No.	510554	Ref. No.
	O-ring EPDM thickness 2mm ID ø 120mm Qty 1 pcs		
	GEV No.	510615	Ref. No.
	impellor ø 90mm H 22mm rotation direction right thread M10L blades 4		

condensators & interference suppression filters

operating capacitors

metal



1

GEV No.	365139	Ref. No.	056148
description	operating capacitor capacity 10µF 450V tolerance 5% 60Hz ambient temperature max. -25 up to +70°C ø 40mm L 83mm M8 aluminium connection male faston 6.3mm C.87.8BF2 MKP protection		

filters

interference suppression filters



1

GEV No.	365045	Ref. No.	0K4865
description	interference suppression filter type FC701Y2F 250V 50-60Hz conductor 2 with E connection cable 200mm L 40mm ø 30mm Hmm Wmm plastic Qty 1 pcs		



fuses

fine fuses

			
1			
GEV No.	358677	Ref. No.	057783
description	fine fuse size ø5x20mm 4A fast-acting rated 250V Qty 10 pcs		

			
1			
GEV No.	358695	Ref. No.	005032
description	fine fuse size ø5x20mm 3.15A medium lag rated 250V Qty 10 pcs		

			
1			
GEV No.	358703	Ref. No.	002750
description	fine fuse size ø5x20mm 0.4A slow-acting rated 250V Qty 10 pcs		

various

			
1			
GEV No.	358397	Ref. No.	0K5074
description	fuse size 76mm 25A rated 690V Qty 1 pcs		

overload switches

			
1			
GEV No.	358523	Ref. No.	0H6104
description	overload switch drop-away current 0.6A		

line circuit breakers

miscellaneous

			
1			
GEV No.	380689	Ref. No.	0K3682
description	line circuit breaker		

electric accessories

cables

copper wire

up to 200°C

			
1			
GEV No.	550081	Ref. No.	0K3285
description	copper wire 1.5mm ² permanent temperature -60 up to +200°C conductor nickel-plated copper wire insulation glass fibre braiding/silicone rubber Qty 10m green/yellow t.max. 250°C rated 300/500V test voltage 2000V		

terminals

connection terminals with screw/faston connections

			
1			
GEV No.	550411	Ref. No.	046347
description	power terminal block 6-pole max. 40A max 450V connection ø6mm ² / F6.3 temp.-resist. 150°C cross section 6mm ²		

gas taps

PEL

21S series

				
1				
GEV No.	101897	Ref. No.	0C0205	
description	gas tap PEL type 21S gas inlet pipe flange ø21mm bypass nozzle ø 0.35mm gas outlet M16x1.5 (tube ø 10/8mm) thermocouple connection M8x1 pilot connection M10x1 shaft ø 8x6.5mm shaft L 32/25mm shaft flat upper			
spare parts for	101897			
	GEV No.	101060	Ref. No.	—
	magnet unit standard L 39mm D1 ø 15.4mm D2 ø 11mm suitable for PEL20-21/JUNKERS/EGA			
	GEV No.	101230	Ref. No.	—
	thermocouple nut T1: M8x1 T2: M18x1 aluminium			
	GEV No.	101875	Ref. No.	—
	gas tap front part shaft ø 8x6.5mm shaft L 32/25mm shaft flat upper/lower type PEL21			
	GEV No.	528347	Ref. No.	—
	O-ring Viton thickness 1.78mm ID ø 2.9mm Qty 1 pcs			



Table continues overleaf



accessories for	101897		
	GEV No.	100908	Ref. No. 052125
	union screw thread M10x1 for pipe ø 4mm Qty 1 pcs		
	GEV No.	100909	Ref. No. —
	union screw thread M10x1 for pipe ø 6mm Qty 1 pcs		
	GEV No.	101246	Ref. No. —
	olive for pipe ø 4mm Qty 1 pcs		
	GEV No.	101278	Ref. No. 060325
	olive for pipe ø 10mm Qty 1 pcs		
	GEV No.	101286	Ref. No. —
	olive ID ø 6mm Qty 1 pcs		
	GEV No.	101300	Ref. No. —
	union nut thread M16x1.5 tube ø 10mm		
	GEV No.	110081	Ref. No. —
	knob ø 70mm shaft ø 8x6.5mm shaft flat universal		
	GEV No.	112206	Ref. No. —
	knob dial plate silver gas tap PEL21/22/23 t.max.°C ED ø 63mm ID ø 45.5mm		



GEV No.	106060	Ref. No.	OKI367
description	gas tap PEL type 21S/O gas inlet pipe flange ø21mm bypass nozzle ø 0mm gas outlet M16x1.5 (tube ø 10/8mm) thermocouple connection M8x1 pilot connection M10x1 shaft ø 6x4.6mm shaft L 45/19mm shaft flat upper		
spare parts for	106060		
	GEV No.	101060	Ref. No. —
	magnet unit standard L 39mm D1 ø 15.4mm D2 ø 11mm suitable for PEL20-21/JUNKERS/EGA		
	GEV No.	101230	Ref. No. —
	thermocouple nut T1: M8x1 T2: M18x1 aluminium		
	GEV No.	101880	Ref. No. —
	gasket Viton ED ø 14mm ID ø 9mm thickness 7.7mm Qty 1 pcs		
accessories for	106060		
	GEV No.	101278	Ref. No. 060325
	olive for pipe ø 10mm Qty 1 pcs		
	GEV No.	101300	Ref. No. —
	union nut thread M16x1.5 tube ø 10mm		















22N/V series			
	1		
GEV No.	106169	Ref. No.	OG0113
description	gas tap PEL type 22N/V gas inlet M20x1.5 (tube ø 12mm) bypass nozzle ø 0.35mm gas outlet M20x1.5 (tube ø 12/10mm) thermocouple connection pilot connection M10x1 shaft ø 6x4.6mm shaft L 45/20mm shaft flat left		
spare parts for	106169		
	GEV No.	100259	Ref. No. —
	bypass nozzle type PEL22 bore ø 0.35mm thread M6x0.5		
	GEV No.	101213	Ref. No. —
	gas tap front part shaft ø 6x4.6mm shaft L 45/20mm shaft flat right/left suitable for PEL22		
	GEV No.	101241	Ref. No. —
	gas connection thread M20x1.5 tube ø 12/10mm for PEL gas taps vertical		
	GEV No.	101460	Ref. No. —
	O-ring ø 12.37mm D1 ø 2.62mm suitable for PEL22		
	GEV No.	101461	Ref. No. —
	screw kit suitable for PEL22 Qty 4 pcs		
accessories for	106169		
	GEV No.	100908	Ref. No. 052125
	union screw thread M10x1 for pipe ø 4mm Qty 1 pcs		
	GEV No.	100909	Ref. No. —
	union screw thread M10x1 for pipe ø 6mm Qty 1 pcs		
	GEV No.	101246	Ref. No. —
	olive for pipe ø 4mm Qty 1 pcs		
	GEV No.	101248	Ref. No. 050682
	olive for pipe ø 12mm Qty 1 pcs suitable for PEL		
	GEV No.	101249	Ref. No. —
	olive for pipe ø 10mm Qty 1 pcs		
	GEV No.	101250	Ref. No. —
	union nut thread M20x1.5 for pipe ø 10mm		
	GEV No.	101251	Ref. No. —
	union nut thread M20x1.5 for pipe ø 12mm		
	GEV No.	101286	Ref. No. —
	olive ID ø 6mm Qty 1 pcs		



22S/O series



1

GEV No.	106022	Ref. No.	OK5756
description	gas tap PEL type 22S/O gas inlet M20x1.5 (tube ø 12mm) bypass nozzle ø 0.35mm gas outlet M20x1.5 (tube ø 12/10mm) thermocouple connection M8x1 pilot connection M10x1 shaft ø 6x4.6mm shaft L 45/20mm shaft flat left		
spare parts for	106022		
	GEV No.	101058	Ref. No. 056594
	magnet unit L 39mm D1 ø 15.4mm D2 ø 13.5mm suitable for PEL22/EGA24197 standard		
	GEV No.	101213	Ref. No. —
	gas tap front part shaft ø 6x4.6mm shaft L 45/20mm shaft flat right/left suitable for PEL22		
	GEV No.	101230	Ref. No. —
	thermocouple nut T1: M8x1 T2: M18x1 aluminium		
	GEV No.	101240	Ref. No. —
	gas connection thread M20x1.5 tube ø 12/10mm for PEL gas taps with gasket and screws horizontal		
	GEV No.	101460	Ref. No. —
	O-ring ø 12.37mm D1 ø 2.62mm suitable for PEL22		
	GEV No.	101461	Ref. No. —
	screw kit suitable for PEL22 Qty 4 pcs		
accessories for	106022		
	GEV No.	100908	Ref. No. 052125
	union screw thread M10x1 for pipe ø 4mm Qty 1 pcs		
	GEV No.	100909	Ref. No. —
	union screw thread M10x1 for pipe ø 6mm Qty 1 pcs		
	GEV No.	101241	Ref. No. —
	gas connection thread M20x1.5 tube ø 12/10mm for PEL gas taps vertical		
	GEV No.	101246	Ref. No. —
	olive for pipe ø 4mm Qty 1 pcs		
	GEV No.	101248	Ref. No. 050682
	olive for pipe ø 12mm Qty 1 pcs suitable for PEL		
	GEV No.	101249	Ref. No. —
	olive for pipe ø 10mm Qty 1 pcs		
	GEV No.	101250	Ref. No. —
	union nut thread M20x1.5 for pipe ø 10mm		
	GEV No.	101251	Ref. No. —
	union nut thread M20x1.5 for pipe ø 12mm		
	GEV No.	101286	Ref. No. —
	olive ID ø 6mm Qty 1 pcs		



1

GEV No.	106023	Ref. No.	OK5619
description	gas tap PEL type 22S/O gas inlet M20x1.5 (tube ø 12mm) bypass nozzle ø 0mm gas outlet M20x1.5 (tube ø 12/10mm) thermocouple connection M8x1 pilot connection M10x1 shaft ø 6x4.6mm shaft L 29/19.5mm shaft flat lower		
spare parts for	106023		
	GEV No.	101058	Ref. No. 056594
	magnet unit L 39mm D1 ø 15.4mm D2 ø 13.5mm suitable for PEL22/EGA24197 standard		
	GEV No.	101230	Ref. No. —
	thermocouple nut T1: M8x1 T2: M18x1 aluminium		
	GEV No.	101240	Ref. No. —
	gas connection thread M20x1.5 tube ø 12/10mm for PEL gas taps with gasket and screws horizontal		
	GEV No.	101460	Ref. No. —
	O-ring ø 12.37mm D1 ø 2.62mm suitable for PEL22		
	GEV No.	101461	Ref. No. —
	screw kit suitable for PEL22 Qty 4 pcs		
	GEV No.	106154	Ref. No. —
	gas tap front part shaft ø 6x4.6mm shaft L 29/19.5mm shaft flat upper/lower suitable for PEL22		
accessories for	106023		
	GEV No.	100908	Ref. No. 052125
	union screw thread M10x1 for pipe ø 4mm Qty 1 pcs		
	GEV No.	100909	Ref. No. —
	union screw thread M10x1 for pipe ø 6mm Qty 1 pcs		
	GEV No.	101246	Ref. No. —
	olive for pipe ø 4mm Qty 1 pcs		
	GEV No.	101248	Ref. No. 050682
	olive for pipe ø 12mm Qty 1 pcs suitable for PEL		
	GEV No.	101249	Ref. No. —
	olive for pipe ø 10mm Qty 1 pcs		
	GEV No.	101250	Ref. No. —
	union nut thread M20x1.5 for pipe ø 10mm		
	GEV No.	101251	Ref. No. —
	union nut thread M20x1.5 for pipe ø 12mm		
	GEV No.	101286	Ref. No. —
	olive ID ø 6mm Qty 1 pcs		
	GEV No.	110080	Ref. No. —
	knob ø 70mm shaft ø 10x8mm shaft flat universal		

Table continues overleaf















accessories for 106023	
	GEV No. 112206 Ref. No. —
knob dial plate silver gas tap PEL21/22/23 t.max.°C ED ø 63mm ID ø 45.5mm	



gas thermostats

SIT

710 Minisit series



GEV No.	106061	Ref. No.	OK5692
description	gas thermostat SIT type MINISIT 710 t.max. 340°C 100-340°C		
spare parts for	106061		
	GEV No. 100809	Ref. No.	—
O-ring EPDM thickness 2mm ID ø 21mm Qty 1 pcs			
	GEV No. 101053	Ref. No.	—
magnet unit T1: M9x1 T2: M24x1 L 45mm ø 17mm suitable for Minisit			
	GEV No. 101136	Ref. No.	054269
piezoelectric igniter suitable for Minisit with cover cap ømm connection F6.3x0.8			
	GEV No. 101269	Ref. No.	—
gas connection thread 1/2" angled with O-ring MINISIT 710			
	GEV No. 101516	Ref. No.	—
flat-headed bolt thread M4 thread L 16mm SS DIN 7985/ISO 7045 Qty 1 pcs			
	GEV No. 101517	Ref. No.	—
flat-headed bolt thread M4 thread L 23mm			
	GEV No. 102107	Ref. No.	—
probe 100-340°C probe ø 4mm probe L 72mm capillary pipe 1050mm t.max. 340°C oven/grill probe type type C1 suitable for MINISIT 710			
	GEV No. 107564	Ref. No.	—
piezoelectric igniter body plastic blowing connection F6.3x0.8 ø 22mm			
	GEV No. 110068	Ref. No.	054268
knob suitable for Minisit ø 37mm			
accessories for	106061		
	GEV No. 101273	Ref. No.	—
olive for pipe ø 12mm L 9.5mm brass Qty 1 pcs suitable for universal			
	GEV No. 101274	Ref. No.	—
olive for pipe ø 16mm Qty 1 pcs			
	GEV No. 101275	Ref. No.	—
union screw thread 1/2" for pipe ø 16mm Qty 1 pcs			

accessories for 106061	
	GEV No. 101276 Ref. No. —
union screw thread 3/8" tube ø 12mm Qty 1 pcs	
	GEV No. 101278 Ref. No. 060325
olive for pipe ø 10mm Qty 1 pcs	
	GEV No. 101279 Ref. No. —
union screw thread 3/8" for pipe ø 10mm Qty 1 pcs	

gas valves and ignition boxes

gas control valves

SIT

ELETTROSIT



1

GEV No.	101127	Ref. No.	057543
description	gas valve SIT type ELETTROSIT 230V gas inlet 3/4" gas outlet 3/4" thermocouple connection M9x1 pilot connection M10x1 lateral equiv. no. 0.810.175		
spare parts for	101127		
	GEV No. 101312	Ref. No.	—
microswitch			
	GEV No. 101352	Ref. No.	—
solenoid coil 230V 50Hz suitable for ELETTROSIT			
accessories for	101127		
	GEV No. 100006	Ref. No.	—
piezoelectric igniter suitable for ELETTROSIT body plastic blowing connection ø2.4mm ø 14mm			
	GEV No. 100904	Ref. No.	—
locking screw M10x1 for pipe ø 4mm Qty 1 pcs			
	GEV No. 100905	Ref. No.	—
locking screw M10x1 for pipe ø 6mm Qty 1 pcs			
	GEV No. 101301	Ref. No.	—
gas connection thread 1/2" straight ELETTROSIT screw with O-ring			
	GEV No. 101303	Ref. No.	—
gas connection straight thread 3/4" ELETTROSIT			
	GEV No. 101309	Ref. No.	—
extension			



NOVASIT



1			
GEV No.	101187	Ref. No.	002606
description	gas valve SIT series Novasit 820 0.17VHz gas inlet 1/2" gas outlet 1/2" thermocouple connection M9x1 pilot connection M10x1 ignition pressurebar pressure range 5-50mbar pressure regulator connection blind equiv. no. 0.820.301 supply Operator millivolt		
spare parts for	101187		
	GEV No.	101065	Ref. No. —
	magnet unit with cable L 44mm D1 ø 30mm D2 ø 20mm suitable for NOVASIT		
accessories for	101187		
	GEV No.	100110	Ref. No. —
	pilot burner SIT type 190 series 3 flames nozzle ømm gas connectionmm		
	GEV No.	101305	Ref. No. —
	gas connection straight 1/2" flange 45x45mm ELETTROSIT/V4400/4600/4605 suitable for SIT/HONEYWELL hole distance 36x36mm		
	GEV No.	101306	Ref. No. —
	gas connection angled flange 45x45mm hole distance 36x36mm 1/2" ELETTROSIT/V4400/4600/4605 screw with O-ring suitable for SIT/HONEYWELL		
	GEV No.	101307	Ref. No. —
	gas connection straight flange 45x45mm hole distance 36x36mm 3/4" ELETTROSIT/V4400/4600/4605 screw with O-ring suitable for SIT/HONEYWELL		
	GEV No.	101308	Ref. No. —
	gas connection angled flange 45x45mm hole distance 36x36mm 3/4" ELETTROSIT/V4400/4600/4605 screw with O-ring suitable for SIT/HONEYWELL		
	GEV No.	102116	Ref. No. 002607
	thermopile ROBERTSHAW L 900mm probe ø 9mm probe L 57mm 250-750mV screw connection 7/16"		

accessories



1			
GEV No.	101928	Ref. No.	059305
description	knob adapter shaft ø 10x8mm shaft L 18mm catch upper suitable for ZANUSSI shaft flat upper		

TANDEM



1			
GEV No.	106219	Ref. No.	0K5838
description	gas valve 230V 50Hz gas inlet 1/2" gas outlet 1/2" pilot connection M10x1 level slow ignition standard ignition time 3-7s Tandem equiv. no. 0.830.020		
spare parts for	106219		
	GEV No.	101379	Ref. No. —
	solenoid coil 230V 50Hz suitable for Tandem		
accessories for	106219		
	GEV No.	101274	Ref. No. —
	olive for pipe ø 16mm Qty 1 pcs		
	GEV No.	101275	Ref. No. —
	union screw thread 1/2" for pipe ø 16mm Qty 1 pcs		
	GEV No.	101925	Ref. No. —
	plug with O-ring thread M10x1 for pilot burner suitable for NOVASIT		
	GEV No.	101936	Ref. No. —
	gasket with screw Tandem		
	GEV No.	102845	Ref. No. —
	gas connection angled 1/2" flange 32x32mm hole distance 24x24mm Tandem		
	GEV No.	102846	Ref. No. —
	gas connection straight 1/2" flange 32x32mm hole distance 24x24mm suitable for Tandem		

ignition parts

pilot burners

SIT

100 series



















1			
GEV No.	106902	Ref. No.	029776
description	pilot burner SIT type 100 series 2 flames nozzle ø 0.2mm gas connection 6mm		
spare parts for	106902		
	GEV No.	100245	Ref. No. 056799
	pilot burner nozzle LPG code 20 bore ø 0.2mm Qty 1 pcs thread M8x0.75		

Table continues overleaf





spare parts for		106902		
	GEV No.	100842	Ref. No.	—
pilot burner cap 2 flames Qty 1 pcs				
	GEV No.	100885	Ref. No.	—
air mixing sleeve for pilot burner Qty 1 pcs				
	GEV No.	100916	Ref. No.	—
compression spring for pilot burner Qty 1 pcs				
	GEV No.	100917	Ref. No.	—
gasket for pilot burner Qty 1 pcs aluminium				
	GEV No.	100918	Ref. No.	—
screw for pilot burner				
	GEV No.	107161	Ref. No.	—
pilot burner cap SIT 2 flames Hmm Lmm Qty 1 pcs				
	GEV No.	107701	Ref. No.	—
pilot burner bottom part SIT 100 series nozzle ø 0.2mm				
accessories for		106902		
	GEV No.	100246	Ref. No.	056656
pilot burner nozzle natural gas bore ø 0.35mm Qty 1 pcs thread M8x0.75				
	GEV No.	100904	Ref. No.	—
locking screw M10x1 for pipe ø 4mm Qty 1 pcs				
	GEV No.	100905	Ref. No.	—
locking screw M10x1 for pipe ø 6mm Qty 1 pcs				
	GEV No.	102110	Ref. No.	—
pilot tube copper pipe ø 4mm thickness 1mm L 3000mm				
	GEV No.	102111	Ref. No.	—
pilot tube copper pipe ø 6mm thickness 1mm L 3000mm				
	GEV No.	107171	Ref. No.	—
pilot burner nozzle SIT natural/liquid gas bore ø 0.25mm Qty 1 pcs				
	GEV No.	107700	Ref. No.	—
pilot burner bottom part SIT 100 series nozzle ø 0.25mm				
	GEV No.	107702	Ref. No.	—
pilot burner bottom part SIT 100 series nozzle ø 0.35mm				

spare parts for		106907		
	GEV No.	100855	Ref. No.	—
pilot burner bracket triple				
	GEV No.	100885	Ref. No.	—
air mixing sleeve for pilot burner Qty 1 pcs				
	GEV No.	100916	Ref. No.	—
compression spring for pilot burner Qty 1 pcs				
	GEV No.	100917	Ref. No.	—
gasket for pilot burner Qty 1 pcs aluminium				
	GEV No.	100918	Ref. No.	—
screw for pilot burner				
	GEV No.	107162	Ref. No.	—
pilot burner cap SIT 3 flames Hmm Lmm Qty 1 pcs				
	GEV No.	107702	Ref. No.	—
pilot burner bottom part SIT 100 series nozzle ø 0.35mm				
accessories for		106907		
	GEV No.	100245	Ref. No.	056799
pilot burner nozzle LPG code 20 bore ø 0.2mm Qty 1 pcs thread M8x0.75				
	GEV No.	100904	Ref. No.	—
locking screw M10x1 for pipe ø 4mm Qty 1 pcs				
	GEV No.	100905	Ref. No.	—
locking screw M10x1 for pipe ø 6mm Qty 1 pcs				
	GEV No.	102110	Ref. No.	—
pilot tube copper pipe ø 4mm thickness 1mm L 3000mm				
	GEV No.	102111	Ref. No.	—
pilot tube copper pipe ø 6mm thickness 1mm L 3000mm				
	GEV No.	107171	Ref. No.	—
pilot burner nozzle SIT natural/liquid gas bore ø 0.25mm Qty 1 pcs				
	GEV No.	107700	Ref. No.	—
pilot burner bottom part SIT 100 series nozzle ø 0.25mm				
	GEV No.	107701	Ref. No.	—
pilot burner bottom part SIT 100 series nozzle ø 0.2mm				

				
1				
GEV No.	106907	Ref. No.	058329	
description	pilot burner SIT type 100 series 3 flames nozzle ø 0.35mm gas connection 6mm			
spare parts for		106907		
	GEV No.	100246	Ref. No.	056656
pilot burner nozzle natural gas bore ø 0.35mm Qty 1 pcs thread M8x0.75				





accessories			
pilot burner brackets			
universal			
			
1			
GEV No.	100854	Ref. No.	052256
description	pilot burner bracket double		

pilot burner nozzles			
			
1			
GEV No.	100245	Ref. No.	056799
description	pilot burner nozzle LPG code 20 bore \varnothing 0.2mm Qty 1 pcs thread M8x0.75		

			
1			
GEV No.	100246	Ref. No.	056656
description	pilot burner nozzle natural gas bore \varnothing 0.35mm Qty 1 pcs thread M8x0.75		

ignition electrodes			
			
1			
GEV No.	100706	Ref. No.	056754
description	ignition electrode connection M4 Qty 1 pcs		

140 - 145 -150 series			
			
1			
GEV No.	100094	Ref. No.	059214
description	pilot burner SIT type 140 series 1 flame nozzle \varnothing mm gas connectionmm for thermocouple \varnothing 5mm		
accessories for	100094		
	GEV No.	100182	Ref. No. 003547
cover for pilot burner Qty 1 pcs			
	GEV No.	100204	Ref. No. —
pilot burner nozzle SIT LPG code 14 bore \varnothing 0.18/0.20mm Qty 1 pcs suitable for 140 series			
	GEV No.	100205	Ref. No. —
pilot burner nozzle SIT LPG code 19 bore \varnothing 0.23/0.26mm Qty 1 pcs suitable for SIT 150 series			

accessories for	100094		
	GEV No.	100206	Ref. No. —
pilot burner nozzle SIT natural gas code 36 bore \varnothing 0.60/0.55mm Qty 1 pcs suitable for SIT 150 series			
	GEV No.	100207	Ref. No. —
pilot burner nozzle SIT natural gas code 27 bore \varnothing 0.40/0.38mm suitable for SIT 140 series			
	GEV No.	100216	Ref. No. —
pilot burner nozzle SIT natural gas code 38 bore \varnothing 0.45mm Qty 1 pcs suitable for SIT 150 series			
	GEV No.	100897	Ref. No. 059161
olive for pipe \varnothing 4mm Qty 1 pcs for pilot burner			
	GEV No.	100898	Ref. No. —
olive for pipe \varnothing 6mm Qty 1 pcs for pilot burner			
	GEV No.	100908	Ref. No. 052125
union screw thread M10x1 for pipe \varnothing 4mm Qty 1 pcs			
	GEV No.	100909	Ref. No. —
union screw thread M10x1 for pipe \varnothing 6mm Qty 1 pcs			
	GEV No.	102110	Ref. No. —
pilot tube copper pipe \varnothing 4mm thickness 1mm L 3000mm			
	GEV No.	102111	Ref. No. —
pilot tube copper pipe \varnothing 6mm thickness 1mm L 3000mm			











JUNKERS			
CB 503 series			
pilot burners			
			
1			
GEV No.	100058	Ref. No.	0K0205
description	pilot burner JUNKERS type CB503006 natural gas nozzle no.26 gas connection 4mm		
spare parts for	100058		
	GEV No.	100224	Ref. No. —
pilot burner nozzle natural gas gas pressure 25mbar code 26 Qty 1 pcs suitable for JUNKERS CB503_			
	GEV No.	101281	Ref. No. —
olive for pipe \varnothing 4mm L 8.7mm Qty 1 pcs suitable for CB 502/503			
	GEV No.	101283	Ref. No. —
union screw thread M10x1 for pipe \varnothing 4mm Qty 1 pcs			
accessories for	100058		
	GEV No.	100220	Ref. No. 0K1176
pilot burner nozzle LPG gas pressure 50mbar code 2 Qty 1 pcs suitable for JUNKERS CB503_			
	GEV No.	100221	Ref. No. —
pilot burner nozzle LPG gas pressure 30mbar code 29 Qty 1 pcs suitable for JUNKERS CB50203_			

Table continues overleaf



accessories for		100058	
	GEV No.	100222	Ref. No. 0K1126
pilot burner nozzle LPG gas pressure 50mbar code 5 Qty 1 pcs suitable for JUNKERS CB50203_			
	GEV No.	100223	Ref. No. —
pilot burner nozzle natural gas gas pressure 20mbar code 3 Qty 1 pcs suitable for JUNKERS CB503_			
	GEV No.	100226	Ref. No. —
pilot burner nozzle LPG gas pressure 50mbar code 15 suitable for JUNKERS			
	GEV No.	100227	Ref. No. —
pilot burner nozzle natural gas gas pressure 25mbar code 6 Qty 1 pcs suitable for JUNKERS CB50203_			
	GEV No.	100228	Ref. No. —
pilot burner nozzle town gas gas pressure 8mbar code 4 Qty 1 pcs suitable for JUNKERS CB50203_			
	GEV No.	100909	Ref. No. —
union screw thread M10x1 for pipe ø 6mm Qty 1 pcs			
	GEV No.	101287	Ref. No. —
olive for pipe ø 6mm Qty 1 pcs			
	GEV No.	102110	Ref. No. —
pilot tube copper pipe ø 4mm thickness 1mm L 3000mm			
	GEV No.	102111	Ref. No. —
pilot tube copper pipe ø 6mm thickness 1mm L 3000mm			





spare parts for		100093	
	GEV No.	100908	Ref. No. 052125
union screw thread M10x1 for pipe ø 4mm Qty 1 pcs			
accessories for		100093	
	GEV No.	100204	Ref. No. —
pilot burner nozzle SIT LPG code 14 bore ø 0.18/0.20mm Qty 1 pcs suitable for 140 series			
	GEV No.	100205	Ref. No. —
pilot burner nozzle SIT LPG code 19 bore ø 0.23/0.26mm Qty 1 pcs suitable for SIT 150 series			
	GEV No.	100206	Ref. No. —
pilot burner nozzle SIT natural gas code 36 bore ø 0.60/0.55mm Qty 1 pcs suitable for SIT 150 series			
	GEV No.	100207	Ref. No. —
pilot burner nozzle SIT natural gas code 27 bore ø 0.40/0.38mm suitable for SIT 140 series			
	GEV No.	100803	Ref. No. —
gasket for pilot burner Qty 1 pcs			
	GEV No.	100898	Ref. No. —
olive for pipe ø 6mm Qty 1 pcs for pilot burner			
	GEV No.	100909	Ref. No. —
union screw thread M10x1 for pipe ø 6mm Qty 1 pcs			
	GEV No.	102110	Ref. No. —
pilot tube copper pipe ø 4mm thickness 1mm L 3000mm			
	GEV No.	102111	Ref. No. —
pilot tube copper pipe ø 6mm thickness 1mm L 3000mm			

PRO-GAS

140 - 145 -150 series

pilot burners



GEV No.	100093	Ref. No.	0H6311
description pilot burner type 150 series 1 flame with accessories			
spare parts for		100093	
	GEV No.	100216	Ref. No. —
pilot burner nozzle SIT natural gas code 38 bore ø 0.45mm Qty 1 pcs suitable for SIT 150 series			
	GEV No.	100701	Ref. No. 059380
ignition electrode connection M4 Qty 1 pcs			
	GEV No.	100897	Ref. No. 059161
olive for pipe ø 4mm Qty 1 pcs for pilot burner			
	GEV No.	100906	Ref. No. 057960
screw connection thread M10x1 for ignition electrode brass Qty 1 pcs WS 10			
	GEV No.	100907	Ref. No. —
screw connection thread M10x1 Qty 1 pcs type SEF 1 ømm for thermocouple			

producer-specific pilot burners

THERMA

Thermaline S90 series (version 1)

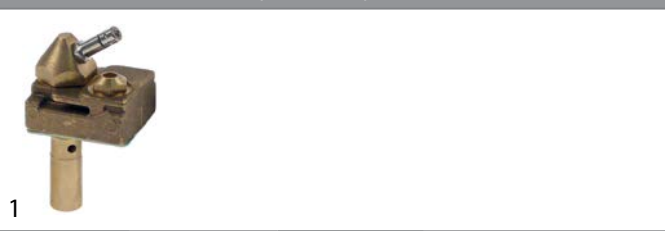

GEV No.	102956	Ref. No.	-
description pilot burner type C without nozzle			







GEV No.	102957	Ref. No.	-
description pilot burner type D without nozzle			



			
1			
GEV No.	102958	Ref. No.	-
description	pilot burner type E without nozzle		

Thermaline S90 series (version 2)

			
1			
GEV No.	101856	Ref. No.	0G3101
description	pilot burner with nozzles		
spare parts for	101856		

	GEV No.	100900	Ref. No.	—
	air mixing sleeve for pilot burner Qty 1 pcs			
	GEV No.	100979	Ref. No.	—
	pilot burner nozzle LPG bore ø 0.25mm code 25 gas pressure 30mbar thread M5x0.8			
	GEV No.	101534	Ref. No.	0G2372
	pilot burner nozzle LPG bore ø 0.19mm code 19 gas pressure 50mbar thread M5x0.8 suitable for THERMA/ELECTROLUX			
	GEV No.	101543	Ref. No.	0K1185
	pilot burner nozzle natural gas bore ø 0.3mm code 30 gas pressure 20mbar thread M5x0.8			
	GEV No.	101583	Ref. No.	—
	pilot burner head slit width 0.8mm bore ø 3mm ø 6mm M7x0.75mm total length 22mm WS 8 nickel-plated brass			
	GEV No.	101587	Ref. No.	—
	gasket for pilot burner without ignition electrode			

Thermaline 800 / 900 series

			
1			
GEV No.	102916	Ref. No.	0K5767
description	cap for pilot burner		

			
1			
GEV No.	102917	Ref. No.	0K5768
description	cap for pilot burner		

			
1			
GEV No.	106247	Ref. No.	0K5715
description	double nipple T1: M10x1 T2: M10x1		

miscellaneous

			
1			
GEV No.	101937	Ref. No.	0G2965
description	pilot burner		

electrodes

			
1			
GEV No.	102965	Ref. No.	0K1351
description	ignition electrode connection F 2.8x0.8mm		



GEV No.	100701	Ref. No.	059380
description	ignition electrode connection M4 Qty 1 pcs		
accessories for	100701		
	GEV No.	100906	Ref. No.
			057960
description	screw connection thread M10x1 for ignition electrode brass Qty 1 pcs WS 10		

GEV No.	100706	Ref. No.	056754
description	ignition electrode connection M4 Qty 1 pcs		

GEV No.	101779	Ref. No.	N/A
description	ignition electrode D1 ø 7mm D2 ø 9mm connection M4 L1 10mm L2 5mm BL1 18mm BL2 3mm BL3 23mm to clip		

GEV No.	102170	Ref. No.	0A5169
description	ignition electrode flange length 24mm flange width 17mm D1 ø 10mm fixing dimensions ø4.5mm with flange		

GEV No.	102169	Ref. No.	003556
description	ignition electrode flange length 24mm flange width 17mm D1 ø 9.5mm L1 45mm L2 30mm L4 18mm L3 17mm BL1 30mm BL2 28mm fixing dimensions ø4.5mm with flange connection ø 6mm		

GEV No.	100906	Ref. No.	057960
description	screw connection thread M10x1 for ignition electrode brass Qty 1 pcs WS 10		

ignition cables

pre-assembled cables

GEV No.	100026	Ref. No.	054273
description	ignition cable cable length 1000mm connection ø4mm / F6.3mm		

piezoelectric igniters

miscellaneous

GEV No.	nla ¹	Ref. No.	0K5693
description	piezoelectric igniter body metal connection F6.3x0.8 3 hole fixing ø 22mm		

¹no longer available

1

GEV No.	nla ¹	Ref. No.	002057
description	piezoelectric igniter suitable for Minisit connection F6.3x0.8 ømm		

¹no longer available



1

GEV No.	nla ¹	Ref. No.	054269
description	piezoelectric igniter suitable for Minisit with cover cap ømm connection F6.3x0.8		
spare parts for	101136		
	GEV No.	100001	Ref. No. 002057
	piezoelectric igniter suitable for Minisit connection F6.3x0.8 ømm		

¹no longer available

ignition switches



1

GEV No.	301014	Ref. No.	0K6805
description	momentary rocker switch mounting measurements 30x11mm black 1NO 250V 16A connection male faston 6.3mm ambient temperature max. 85/125°C protection IP40 mounting ømm male faston 6.3mm		

thermocouples

plug-in thermocouples

plug-in thermocouples standard

with barrel socket ø5mm - type Junkers with aluminised tip





1

GEV No.	102202	Ref. No.	0K1368
description	thermocouple M8x1 L 320mm plug connection ø5.0mm		
accessories for	102202		
	GEV No.	101260	Ref. No. —
	thermocouple fitting thread M8x1 Qty 1 pcs		



1

GEV No.	102205	Ref. No.	058332
description	thermocouple M8x1 L 750mm plug connection ø5.0mm		
accessories for	102205		
	GEV No.	101260	Ref. No. —
	thermocouple fitting thread M8x1 Qty 1 pcs		



1

GEV No.	102294	Ref. No.	0K1369
description	thermocouple M8x1 L 750mm plug connection ø5.0mm		

with barrel socket ø6(6.5)mm thermocouples SIT

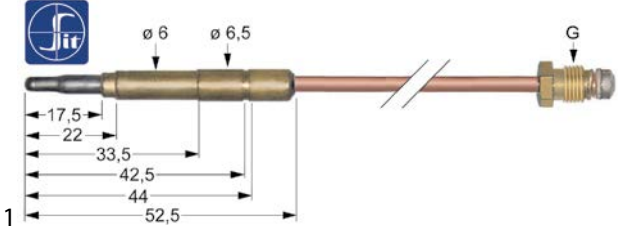

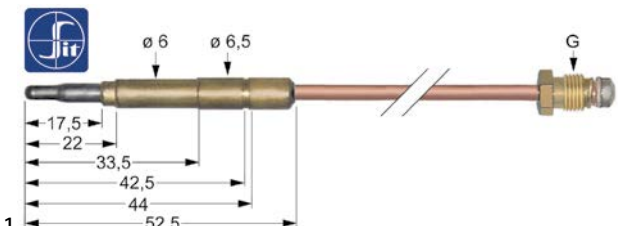

1

GEV No.	107601	Ref. No.	0G1120
description	thermocouple SIT M8x1 L 600mm plug connection ø6.0(6.5)mm		



1

GEV No.	107602	Ref. No.	0C0202
description	thermocouple SIT M8x1 L 850mm plug connection ø6.0(6.5)mm		
accessories for	107602		
	GEV No.	100920	Ref. No. —
	thermocouple fitting thread M8x1 / M9x1 Qty 1 pcs		
	GEV No.	100922	Ref. No. —
	thermocouple fitting thread M10x1 / ASA 11/32 Qty 1 pcs		



GEV No.	107613	Ref. No.	0K3464
description	thermocouple SIT M9x1 L 1200mm plug connection ø6.0(6.5)mm		

plug-in thermocouples with interruption

GEV No.	107863	Ref. No.	0C3162
description	thermocouple SIT with interrupter M9x1 L 1000mm plug connection ø6.0(6.5)mm cable 820mm		

threaded thermocouples
threaded thermocouples standard
with socket with thread M8x1
SIT

GEV No.	107630	Ref. No.	19012635	
description	thermocouple SIT M8x1 L 600mm M8x1			
accessories for	107630			
	GEV No.	102067	Ref. No.	—
	nut thread M8x1 H 3mm brass Qty 1 pcs type SEF 1			

thermopiles

GEV No.	102116	Ref. No.	002607
description	thermopile ROBERTSHAW L 900mm probe ø 9mm probe L 57mm 250-750mV screw connection 7/16"		

accessories

screws

GEV No.	106246	Ref. No.	0K5713
description	screw thread M8x1 IT / M12x1 ET for thermocouple		

miscellaneous

GEV No.	106245	Ref. No.	0K5775
description	sleeve for thermocouple thread M12x1		

gas burners
hob burners

producer-specific hob burners

THERMA

Thermaline S90 series

GEV No.	104540	Ref. No.	17012726
description	burner cap C ø 83mm 3.5kW		

GEV No.	104460	Ref. No.	17012727
description	burner cap D ø 94mm 5kW with central hole		

GEV No.	104542	Ref. No.	17012728	
description	burner cap E ø 114mm mounting ø 105mm ID ø 45mm 7kW with central hole bore ø 3mm			
accessories for	104542			
	GEV No.	104507	Ref. No.	17012725
	burner head E for burner cap ø 115mm			





		
1		
GEV No.	104500	Ref. No.
		17012723
description	burner head C for burner cap ø 85mm	

		
1		
GEV No.	104505	Ref. No.
		17012724
description	burner head D for burner cap ø 95mm	

		
1		
GEV No.	104507	Ref. No.
		17012725
description	burner head E for burner cap ø 115mm	

		
1		
GEV No.	104707	Ref. No.
		17012729
description	burner lower part C complete	

		
1		
GEV No.	104708	Ref. No.
		17012730
description	burner lower part D complete	

		
1		
GEV No.	104709	Ref. No.
		17012731
description	burner lower part E complete	

		
1		
GEV No.	104511	Ref. No.
		17012722
description	gasket ø 72mm ID ø 45mm for burner head H 1.2mm perforation ø 5mm	

		
1		
GEV No.	104522	Ref. No.
		17012721
description	nozzle holder ID ø 10mm ET M17x1	

Thermaline 800/900, Starline series

		
1		
GEV No.	106248	Ref. No.
		19012588
description	air mixing tube ID ø 15mm	

		
1		
GEV No.	106249	Ref. No.
		19012587
description	air mixing tube ID ø 17mm	

		
1		
GEV No.	104744	Ref. No.
		19012600
description	burner cap 3.5kW ø 53mm	

		
1		
GEV No.	104746	Ref. No.
		19012601
description	burner cap 5.6kW ø 78mm	

		
1		
GEV No.	104748	Ref. No.
		19012602
description	burner cap 8.4kW ø 103mm	

		
1		
GEV No.	105990	Ref. No.
		19012941
description	burner cap ø 103mm 7kW with central hole mounting pos. outer	



			
1			
GEV No.	105988	Ref. No.	19012942
description	burner cap ø 40mm 7kW mounting pos. inner		

			
1			
GEV No.	104750	Ref. No.	19012925
description	burner head 3.5kW for burner cap ø 53mm KBF suitable for simmering plate		

			
1			
GEV No.	104759	Ref. No.	0G1905
description	burner head 3.5kW for burner cap ø 53mm simmering plate		

			
1			
GEV No.	104747	Ref. No.	0K5682
description	burner head 5.6kW for burner cap ø 78mm		

			
1			
GEV No.	104751	Ref. No.	19012619
description	burner head 5.6kW for burner cap ø 78mm		

			
1			
GEV No.	104769	Ref. No.	19013008
description	burner head 5.6kW for burner cap ø 78mm grill/griddle plate		

			
1			
GEV No.	104749	Ref. No.	19012612
description	burner head 8.4kW for burner cap ø 103mm		

			
1			
GEV No.	105989	Ref. No.	19012946
description	burner head for burner cap ø 40/103mm 7kW		

			
1			
GEV No.	104745	Ref. No.	0K5681
description	burner head suitable for burner 3.7kW		

			
1			
GEV No.	104753	Ref. No.	19012711
description	nozzle holder		

bar burners

bar burners

			
1			
GEV No.	104581	Ref. No.	006650
description	bar burner 2 row L 550mm W 190mm ømm H 50mm griddle		

			
1			
GEV No.	104580	Ref. No.	0A5124
description	bar burner 3 row L 645mm W 190mm ømm H 45mm griddle		



			
1			
GEV No.	104186	Ref. No.	0H6337
description	bar burner ømm W 28mm H 49mm L 510mm with ignition bridge 170mm flange width 35mm flange length 70mm tilting bratt pan		

			
1			
GEV No.	105999	Ref. No.	0G3823
description	bar burner slotted ømm W 30mm H 55mm L 500mm gas range		

			
1			
GEV No.	104590	Ref. No.	0TR593
description	bar burner T-shape L 224mm ø 32mm bain marie		

tube burners

			
1			
GEV No.	105071	Ref. No.	059297
description	tubular burner L 265mm W 50mm H 71mm for fryer oval suitable for 700/900 series		

accessories

nozzle holders

			
1			
GEV No.	104753	Ref. No.	19012711
description	nozzle holder		

			
1			
GEV No.	104522	Ref. No.	17012721
description	nozzle holder ID ø 10mm ET M17x1		

gas nozzles

main nozzles

gas nozzles M10x1

			
1			
GEV No.	100155	Ref. No.	056470
description	gas injector thread M10x1 bore ø 1.45mm L 30mm WS 12		

			
1			
GEV No.	106403	Ref. No.	054033
description	gas injector thread M10x1 bore ø 1.9mm L 30mm WS 12		

			
1			
GEV No.	102499	Ref. No.	056471
description	gas injector thread M10x1 bore ø 2.25mm L 30mm WS 12		

gas nozzles M12x1

			
1			
GEV No.	100279	Ref. No.	0KW937
description	gas injector thread M12x1 WS 14 bore ø 0.82mm		

			
1			
GEV No.	100280	Ref. No.	0G2773
description	gas injector thread M12x1 WS 14 bore ø 0.93mm		

			
1			
GEV No.	100282	Ref. No.	0KW934
description	gas injector thread M12x1 WS 14 bore ø 0.95mm		





			
1			
GEV No.	100285	Ref. No.	0G2774
description	gas injector thread M12x1 WS 14 bore ø 1.10mm		

			
1			
GEV No.	100239	Ref. No.	0G2396
description	gas injector thread M12x1 WS 14 bore ø 1.65mm		

			
1			
GEV No.	100243	Ref. No.	0KW933
description	gas injector thread M12x1 WS 14 bore ø 1.12mm		

			
1			
GEV No.	100288	Ref. No.	0K1229
description	gas injector thread M12x1 WS 14 bore ø 1.70mm		

			
1			
GEV No.	100286	Ref. No.	0K1246
description	gas injector thread M12x1 WS 14 bore ø 1.30mm		

			
1			
GEV No.	100289	Ref. No.	0G3001
description	gas injector thread M12x1 WS 14 bore ø 1.80mm		

			
1			
GEV No.	100669	Ref. No.	0G2395
description	gas injector thread M12x1 WS 14 bore ø 1.37mm		

			
1			
GEV No.	100740	Ref. No.	0G2397
description	gas injector thread M12x1 WS 14 bore ø 1.95mm		

			
1			
GEV No.	100307	Ref. No.	0K1224
description	gas injector thread M12x1 WS 14 bore ø 1.40mm		

			
1			
GEV No.	100291	Ref. No.	0G2914
description	gas injector thread M12x1 WS 14 bore ø 2.00mm		

			
1			
GEV No.	100700	Ref. No.	0G3463
description	gas injector thread M12x1 WS 14 bore ø 1.50mm		

			
1			
GEV No.	100744	Ref. No.	0G2915
description	gas injector thread M12x1 WS 14 bore ø 2.12mm		

			
1			
GEV No.	100301	Ref. No.	0G3804
description	gas injector thread M12x1 WS 14 bore ø 1.55mm		

			
1			
GEV No.	100309	Ref. No.	0K1230
description	gas injector thread M12x1 WS 14 bore ø 2.30mm		



1

GEV No.	100294	Ref. No.	0G3803
description	gas injector thread M12x1 WS 14 bore ø 2.40mm		



1

GEV No.	100416	Ref. No.	0G3511
description	gas injector thread M12x1 WS 14 bore ø 2.55mm		



1

GEV No.	100304	Ref. No.	0G3891
description	gas injector thread M12x1 WS 14 bore ø 2.60mm		



1

GEV No.	100752	Ref. No.	0G2964
description	gas injector thread M12x1 WS 14 bore ø 3.20mm		



1

GEV No.	100762	Ref. No.	0G3892
description	gas injector thread M12x1 WS 14 bore ø 4.10mm		

pilot burner nozzles

pilot burner nozzles EGA



1

GEV No.	101534	Ref. No.	0G2372
description	pilot burner nozzle LPG bore ø 0.19mm code 19 gas pressure 50mbar thread M5x0.8 suitable for THERMA/ELECTROLUX		



1

GEV No.	101543	Ref. No.	0K1185
description	pilot burner nozzle natural gas bore ø 0.3mm code 30 gas pressure 20mbar thread M5x0.8		

pilot burner nozzles JUNKERS

CB 50203_/503_ series



1

GEV No.	100220	Ref. No.	0K1176
description	pilot burner nozzle LPG gas pressure 50mbar code 2 Qty 1 pcs suitable for JUNKERS CB503_		



1

GEV No.	100222	Ref. No.	0K1126
description	pilot burner nozzle LPG gas pressure 50mbar code 5 Qty 1 pcs suitable for JUNKERS CB50203_		

pilot burner nozzles SIT

100 series



1

GEV No.	100245	Ref. No.	056799
description	pilot burner nozzle LPG code 20 bore ø 0.2mm Qty 1 pcs thread M8x0.75		



1

GEV No.	100246	Ref. No.	056656
description	pilot burner nozzle natural gas bore ø 0.35mm Qty 1 pcs thread M8x0.75		



1

GEV No.	107170	Ref. No.	058525
description	pilot burner nozzle SIT natural gas bore ø 0.35mm Qty 1 pcs		

160 series



1

GEV No.	107172	Ref. No.	054593
description	pilot burner nozzle SIT LPG code 25 Qty 1 pcs		



bypass nozzles

bypass nozzles PEL20/21



1			
GEV No.	100554	Ref. No.	002900
description	bypass nozzle type PEL20/21 bore ø 0.45mm thread M5x0.5		



1			
GEV No.	100548	Ref. No.	002991
description	bypass nozzle type PEL20/21 bore ø 0.65mm thread M5x0.5		



1			
GEV No.	100528	Ref. No.	002926
description	bypass nozzle type PEL20/21 bore ø 0.9mm thread M5x0.5		

bypass nozzles PEL22



1			
GEV No.	100414	Ref. No.	004261
description	bypass nozzle type PEL22 bore ø 0.45mm thread M6x0.5		

auxiliary gas parts

screw connections

olives



1			
GEV No.	101278	Ref. No.	060325
description	olive for pipe ø 10mm Qty 1 pcs		

accessories for	101278		
	GEV No.	100943	Ref. No. OKL494
	union nut thread M17x1 tube ø 10mm		

	GEV No.	101300	Ref. No. —
	union nut thread M16x1.5 tube ø 10mm		

	GEV No.	101478	Ref. No. —
	union nut thread 3/8" for pipe ø 10mm		

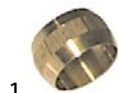

1			
GEV No.	101248	Ref. No.	050682
description	olive for pipe ø 12mm Qty 1 pcs suitable for PEL		

accessories for	101248		
	GEV No.	101251	Ref. No. —
	union nut thread M20x1.5 for pipe ø 12mm		



1			
GEV No.	100897	Ref. No.	059161
description	olive for pipe ø 4mm Qty 1 pcs for pilot burner		

union nuts



1			
GEV No.	100943	Ref. No.	OKL494
description	union nut thread M17x1 tube ø 10mm		

accessories for	100943		
	GEV No.	101278	Ref. No. 060325
	olive for pipe ø 10mm Qty 1 pcs		

union screws



1			
GEV No.	100906	Ref. No.	057960
description	screw connection thread M10x1 for ignition electrode brass Qty 1 pcs WS 10		



1			
GEV No.	100908	Ref. No.	052125
description	union screw thread M10x1 for pipe ø 4mm Qty 1 pcs		

accessories for	100908		
	GEV No.	100897	Ref. No. 059161
	olive for pipe ø 4mm Qty 1 pcs for pilot burner		

	GEV No.	101246	Ref. No. —
	olive for pipe ø 4mm Qty 1 pcs		

	GEV No.	101280	Ref. No. —
	olive for pipe ø 4mm Qty 1 pcs		

	GEV No.	101282	Ref. No. —
	olive for pipe ø 4mm L 7.4mm Qty 1 pcs		

equipment-specific units

for convection ovens/combi-steamers

filters



1

GEV No.	514425	Ref. No.	0C1740
description	drain filter ø 102mm		

for boiling pans

miscellaneous



1

GEV No.	691254	Ref. No.	0KJ532
description	lever for tilting kettle		



1

GEV No.	540993	Ref. No.	0TR591
description	support for manometer size 1/2"		

for dishwashers

containers

accessories



1

GEV No.	504703	Ref. No.	048434
description	lid suitable for ZANUSSI equiv. no. 048434 external height 20mm		

boilers

accessories



1

GEV No.	517339	Ref. No.	005381
description	flange ø 74mm ID ø 33mm thickness 1mm hole ø 9mm		

air traps

air traps



1

GEV No.	504620	Ref. No.	048308
----------------	--------	-----------------	--------

description air trap**accessories for** 504620

GEV No.	504618	Ref. No.	—
description	O-ring EPDM thickness 2.62mm ID ø 15.54mm Qty 1 pcs		



GEV No.	504621	Ref. No.	—
description	nut		



1

GEV No.	504622	Ref. No.	046631
----------------	--------	-----------------	--------

description air trap**accessories for** 504622

GEV No.	511452	Ref. No.	—
description	gasket for air trap		



GEV No.	528487	Ref. No.	—
description	O-ring EPDM thickness 2.62mm ID ø 9.19mm Qty 1 pcs		



1

GEV No.	510103	Ref. No.	069515
----------------	--------	-----------------	--------

description air trap L 85mm W 20mm H 80mm hose ø 6mm plastic**spare parts for** 510103

GEV No.	505045	Ref. No.	—
description	O-ring EPDM thickness 1.78mm ID ø 5.28mm Qty 1 pcs		



GEV No.	505094	Ref. No.	—
description	air trap		



GEV No.	510016	Ref. No.	—
description	eye bolt for rinse aid container connection		

Table continues overleaf



spare parts for 510103			
	GEV No.	510105	Ref. No. —
hose connector for air trap			

mechanics for flight type dishwashers

			
1	GEV No.	510598	Ref. No. 0E5006
description guide for spindle L 60mm W 40mm hole ø 21mm thickness 15mm			

			
1	GEV No.	511483	Ref. No. 0K8142
description hook			

			
1	GEV No.	504603	Ref. No. 0K8166
description hook for dishwasher			

door mechanics

springs

roller springs

			
1	GEV No.	519449	Ref. No. 0E5158
description roller spring W 25mm ID ø 32mm lug lengthmm			

locks

			
1	GEV No.	504659	Ref. No. 047491
description door catch L 84mm W 19mm H 31mm mounting distance 64mm catch housing			

curtains

curtains

			
1	GEV No.	533004	Ref. No. 0E5038
description curtain W 550mm H 355mm			

washing and rinsing systems

			
1	GEV No.	504547	Ref. No. 047283
description knurled nut thread M8x1 ø 25mm H 6mm SS			

			
1	GEV No.	504258	Ref. No. 0E2969
description wash pipe ø 63mm L 185mm L-shape			

knobs

universal knobs

			
1	GEV No.	110242	Ref. No. 0K9909
description knob thermostat t.max. 180°C ø 50mm shaft ø 6x4.6mm shaft flat upper black temperature range 100-180°C			

producer-specific knobs

ELECTROLUX/THERMA

			
1	GEV No.	112054	Ref. No. 0KI391
description knob gas tap with ignition flame t.max.°C temperature range°C ø 60mm shaft ø 6x4.6mm shaft flat lower blue			



1

GEV No.	111824	Ref. No.	OG3711
description	knob gas tap with ignition flame t.max.°C temperature range°C ø 60mm shaft ø 6x4.6mm shaft flat upper blue		



1

GEV No.	111827	Ref. No.	OG3648
description	knob switch zero mark t.max.°C temperature range°C ø 60mm shaft ø 6x4.6mm shaft flat lower dark blue		

accessories

covers



1

GEV No.	112107	Ref. No.	OG3399
description	lid knob		

fascias



1

GEV No.	112106	Ref. No.	OK5794
description	bezel zero mark		

handles and hand wheels

hand wheels

hand wheels



1

GEV No.	690085	Ref. No.	OK5532
description	hand wheel ø 200mm D1 ø 48mm bore ø 20mm thread groove widthmm L1 30mm L2 60mm handle length 82mm with folding handle		
spare parts for	690085		
	GEV No.	514255	Ref. No. —
	folding handle ø 26mm total length 85mm seat ø 20mm shaft ømm thread M6 with pin L 85mm		



1

GEV No.	690551	Ref. No.	0H6472
description	hand wheel ø 200mm D1 ø 48mm bore ø 20mm thread M8 groove widthmm L1 30mm L2 60mm handle length 80mm no fold-away handle		

lever handles



1

GEV No.	540929	Ref. No.	056887
description	lever handle suitable for outlet tap shaft 8x8mm L 90mm		

recessed handles



1

GEV No.	504780	Ref. No.	047481
description	handle		



locks

edgemount latches

handle latches

producer-specific

ZANUSSI

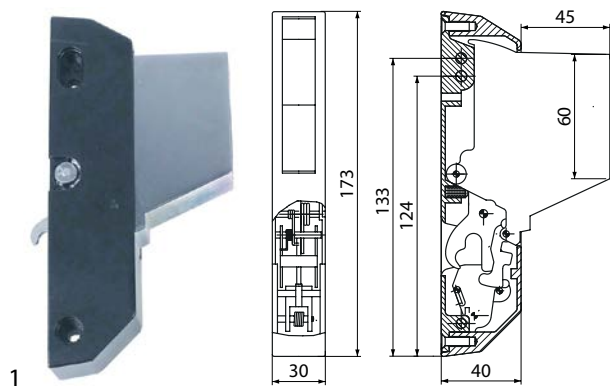

GEV No.	700467	Ref. No.	002647
description	catch L 173mm H 40mm mounting distance 133/124mm W 30mm non lockable 6200 total length 170mm overall height 85mm		
accessories for	700467		
	GEV No.	693937	Ref. No. 0F0029
	door handle H 44mm L 220mm W 50mm plastic black		
	GEV No.	700468	Ref. No. 002650
	door catch with roller		
	GEV No.	701412	Ref. No. —
	cover cap plastic round ø 11mm black for catch thickness 8mm		

door catches



GEV No.	700468	Ref. No.	002650
description	door catch with roller		

hinges

door bearing



GEV No.	700480	Ref. No.	002875
description	hinge bearing mounting pos. lower with bolt		

accessories

base plate



GEV No.	700479	Ref. No.	002877
description	base plate for door hinge mounting pos. upper left		

miscellaneous



GEV No.	700474	Ref. No.	002653
description	disc for hinge corrugated		





GEV No.	700478	Ref. No.	002645
description	protector for glass door for hinge		



fittings for catering equipment

aerators and air bleeders



GEV No.	540014	Ref. No.	OK5787
description	aerator and air bleeder thread 1/2" ET chrome-plated L 78mm		
spare parts for	540014		
	GEV No.	112777	Ref. No. —
	star handle shaft 6x6mm ø 50mm L 18mm black plastic		
	GEV No.	540365	Ref. No. —
	star handle shaft 6x6mm ø 50mm L 18mm black thermoplastic		

GEV No.	540013	Ref. No.	OG3246	
description	aerator and air bleeder thread 3/8" ET WS 27 chrome-plated L 86mm			
spare parts for	540013			
	GEV No.	112777	Ref. No.	—
	star handle shaft 6x6mm ø 50mm L 18mm black plastic			
	GEV No.	540365	Ref. No.	—
	star handle shaft 6x6mm ø 50mm L 18mm black thermoplastic			



GEV No.	540949	Ref. No.	0H9729
description	aerator and air bleeder thread 1/2" ET chrome-plated with O-ring L 15mm ø 25mm		

lid hinges



type ECHTERMANN

10 series

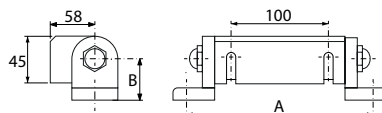
10.81

GEV No.	692648	Ref. No.	OK5245
description	lid hinge type 1081 level of centre of rotation 35mm load capacity 10-20NM opening angle 75° closing angle 10° mounting distance 198mm bore ø 11mm MD lid 100mm chrome-plated brass		

GEV No.	691203	Ref. No.	OK5247	
description	lid hinge type 1081 level of centre of rotation 45mm load capacity 50-60NM opening angle 75° closing angle 10° mounting distance 198mm bore ø 11mm MD lid 100mm chrome-plated brass			
spare parts for	691203			
	GEV No.	691614	Ref. No.	—
	repair kit for lid hinge load capacity 50-60NM			

FITTINGS FOR CATERING EQUIPMENT THERMA

10.82

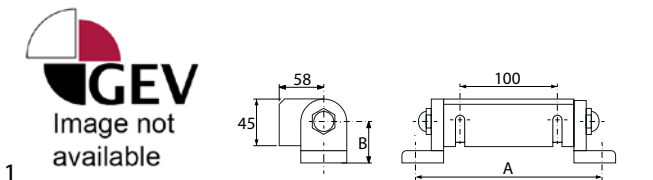
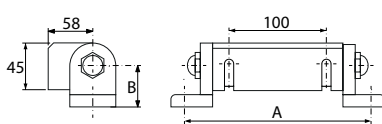
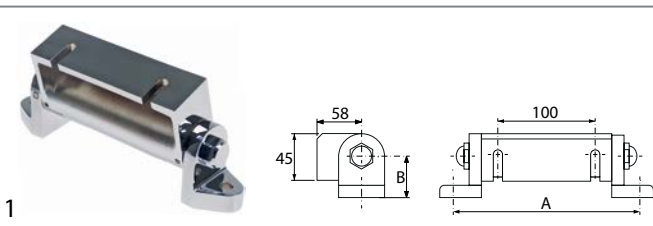
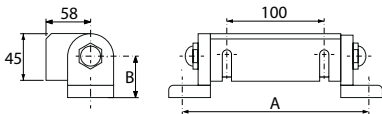



Image not available



GEV No.	692652	Ref. No.	OG3736
description	lid hinge type 1082 level of centre of rotation 35mm load capacity 70-100NM opening angle 72° closing angle 10° mounting distance 220mm bore ø 11mm MD lid 100mm chrome-plated brass		

GEV No.	691204	Ref. No.	0H9913	
description	lid hinge type 1082 level of centre of rotation 35mm load capacity 70-100NM opening angle 75° closing angle 10° mounting distance 220mm bore ø 11mm MD lid 100mm chrome-plated brass			
spare parts for	691204			
	GEV No.	691615	Ref. No.	—
	repair kit for lid hinge load capacity 70-100NM			

drain taps

brass

drain taps



GEV No.	548001	Ref. No.	OS1037	
description	drain tap 1 1/2" IT O-ring seal kettle connection with union nut A 80mm B1 68mm B2 132mm			
spare parts for	548001			
	GEV No.	505092	Ref. No.	—
	O-ring EPDM thickness 5,34mm ID ø 43,82mm Qty 1 pcs			
	GEV No.	540213	Ref. No.	—
	handle ID ø 5mm L 117mm			



			
1			
GEV No.	540275	Ref. No.	0C4850
description	drain tap 2" IT with union nut A 90mm B 151mm B1 80mm chrome-plated brass		
spare parts for	540275		
	GEV No.	540214	Ref. No. —
	handle ID ø 6mm L 145mm		
accessories for	540275		
	GEV No.	529484	Ref. No. —
	flat gasket fibre ED ø 58mm ID ø 50mm thickness 2mm Qty 1 pcs		
	GEV No.	542448	Ref. No. —
	gasket silicone 60x49x2 for drain tap 2"		

accessories			
			
1			
GEV No.	540222	Ref. No.	053809
description	O-ring EPDM thickness 2.62mm ID ø 47.3mm Qty 1 pcs		

			
1			
GEV No.	540083	Ref. No.	0K1469
description	pressure bolt for drain tap		

steam traps

steam traps

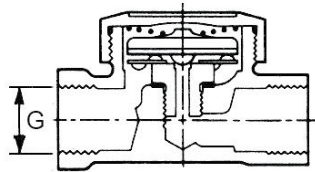
 			
1			
GEV No.	541461	Ref. No.	0K5388
description	thermostatic steam trap thread 1/2" type BPT135 brass		

safety valves

			
1			
GEV No.	541458	Ref. No.	0K5784
description	safety valve T1: 1/2" T2: 1/2" triggering pressure 1.3bar		

gaskets

gaskets for heated units

door seals

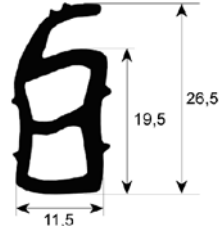
			
1			
GEV No.	900763	Ref. No.	0K9170
description	door seal profile 2276 Qty supplied by meter		

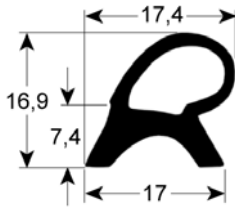
			
1			
GEV No.	900758	Ref. No.	0K8016
description	door seal profile 2450 W 445mm H 1360mm external size Qty 1 suitable for ELECTROLUX 450x1360		

GEV No.	900759	Ref. No.	OK8015
description	door seal profile 2450 W 450mm H 720mm external size Qty 1 suitable for ELECTROLUX 447x719		

GEV No.	900764	Ref. No.	OK8159
description	door seal profile 2921 L 1600mm Qty 1		

GEV No.	900579	Ref. No.	005708
description	door seal profile 2520 W 450mm L 1490mm external size Qty 1 suitable for ELECTROLUX 450x1490		

boiling pan gaskets

GEV No.	900755	Ref. No.	OK5571
description	boiling pan gasket profile 3030 L 1130mm W 655mm		

GEV No.	900577	Ref. No.	005710
description	door seal profile 2520 W 450mm L 550mm external size Qty 1 suitable for ELECTROLUX 450x550		

GEV No.	900609	Ref. No.	OK5574
description	door seal profile 3030 ø 430mm		

GEV No.	900578	Ref. No.	005709
description	door seal profile 2520 W 450mm L 770mm external size Qty 1 suitable for ELECTROLUX 450x770		

O-rings

EPDM

GEV No.	532003	Ref. No.	059293
description	O-ring EPDM thickness 1.78mm ID ø 3.69mm Qty 10 pcs		

GEV No.	900753	Ref. No.	OK9171
description	door seal profile 2905 Qty supplied by meter		

GEV No.	532581	Ref. No.	0E5118
description	O-ring EPDM thickness 2.3mm ID ø 17.2mm Qty 1 pcs		

GEV No.	540222	Ref. No.	053809
description	O-ring EPDM thickness 2.62mm ID ø 47.3mm Qty 1 pcs		



1

GEV No.	510009	Ref. No.	069531
description	O-ring EPDM thickness 3.53mm ID ø 101.2mm Qty 1 pcs		

1

GEV No.	510408	Ref. No.	067620
description	O-ring EPDM thickness 5.34mm ID ø 47mm Qty 1 pcs		

Viton

1

GEV No.	511300	Ref. No.	002873
description	O-ring Viton thickness 3.53mm ID ø 28.17mm for 57 series for motor shaft		

1

GEV No.	528412	Ref. No.	002874
description	O-ring Viton thickness 3.53mm ID ø 31.34mm Qty 1 pcs		

sealing washers

rubber gaskets

1

GEV No.	504776	Ref. No.	049828
description	gasket rubber ED ø 60mm ID ø 50mm thickness 1.5mm for intake body		

shaft gaskets

miscellaneous

1

GEV No.	511301	Ref. No.	002699
description	shaft seal ID ø 16mm ED ø 38mm thickness 18mm		

special gaskets

miscellaneous

1

GEV No.	550924	Ref. No.	002075
description	gasket for probe ID ø 6mm EPDM		

1

GEV No.	900775	Ref. No.	0K5103
description	gasket L 1000mm size 10x2mm self-adhesive silicone		

1

GEV No.	691252	Ref. No.	0K5262
description	gasket profile V ED ø 46mm ID ø 36mm		

transmission technology and ball bearings

drive belts

toothed belts



1

GEV No.	504778	Ref. No.	0E5050
description	toothed belt profile T10 L 610mm H 4mm teeth 61 rubber with textile insertion CODE 354TI W 16mm		

springs

compression springs



1

GEV No.	504660	Ref. No.	047492
description	compression spring ϕ 8.9mm L 37.5mm wire gauge ϕ 1.15mm		

roller springs

roller springs



1

GEV No.	519449	Ref. No.	0E5158
description	roller spring W 25mm ID ϕ 32mm lug lengthmm		



1

GEV No.	504518	Ref. No.	0E5167
description	roller spring W 39mm ID ϕ 32mm lug lengthmm		

manometers



1

GEV No.	541460	Ref. No.	0K5402
description	manometer pressure range 0 up to 2.5bar marking 1.3		

hoses

supply hoses

PVC supply hoses



1

GEV No.	520011	Ref. No.	0L1887
description	supply hose PVC straight-curved DN13 connections 3/4" L 2000mm operating p. 10bar burst p. 32bar t.max. 90°C approval VDE flat seal		

industrial hoses

Niplaflex hoses



1

GEV No.	530561	Ref. No.	0C4158
description	pressure hose ID ϕ 10mm ED ϕ 17mm L 5m thickness 3.5mm operating p. 10bar burst p. 30bar t.max. 110°C		

valves and tank inlets

ball valves

universal

ball valves with butterfly handle



1

GEV No.	540982	Ref. No.	005927
description	ball valve connection 3/4" IT - 3/4" ET DN20 total length 69mm shaft ϕ 8x5mm		



ball valves electric

 <p>1</p>			
GEV No.	401139	Ref. No.	0C0882
description	ball valve inlet 3/4" IT outlet 3/4" IT with plug 230V L 65mm 50/60Hz closed off-current mode of operation electric connection cable 200mm		

ancillary products

clamps

hose clamps

DIN 3017 - W2

 <p>1</p>			
GEV No.	520112	Ref. No.	048126
description	hose clamp ø 12-20mm width 9mm Qty 10 pcs DIN 3017		

 <p>1</p>			
GEV No.	520116	Ref. No.	046878
description	hose clamp ø 32-50mm width 9mm Qty 5 pcs DIN 3017		

 <p>1</p>			
GEV No.	520118	Ref. No.	046855
description	hose clamp ø 50-70mm width 9mm Qty 5 pcs DIN 3017		

measuring equipment

thermometers

built-in thermometers

 <p>1</p>			
GEV No.	541522	Ref. No.	048525
description	thermometer mounting measurements 45x45mm +40 up to +120°C capillary pipe 5000mm probe ø 6mm probe L 36mm front measurements 48x48mm		

fastening material

nuts

knurled nuts

 <p>1</p>			
GEV No.	504547	Ref. No.	047283
description	knurled nut thread M8x1 ø 25mm H 6mm SS		

hexagonal nuts

DIN 6923 / ISO 4161

 <p>1</p>			
GEV No.	504315	Ref. No.	0E5372
description	nut thread M5 H 5mm WS 8 Qty 10 pcs		

washers

washers

DIN 125A

 <p>1</p>			
GEV No.	560114	Ref. No.	0K5101
description	plain washer ID ø 8.4mm ED ø 16mm thickness 1.6mm SS Qty 20 pcs DIN 125A for thread M8		

fasteners

slot nuts



GEV No.	560268	Ref. No.	0E5048
description	slot nut W 8mm H 7mm L 35mm		

clamps

hose clamps

DIN 3017 - W2



GEV No.	520112	Ref. No.	048126
description	hose clamp ø 12-20mm width 9mm Qty 10 pcs DIN 3017		



GEV No.	520116	Ref. No.	046878
description	hose clamp ø 32-50mm width 9mm Qty 5 pcs DIN 3017		



GEV No.	520118	Ref. No.	046855
description	hose clamp ø 50-70mm width 9mm Qty 5 pcs DIN 3017		

roll pins



GEV No.	692013	Ref. No.	0H6043
description	roll pin ø 3mm L 16mm		

consumables

sealants and adhesives

high temperature silicone



GEV No.	890050	Ref. No.	OK3948
description	high temperature silicone NOVASIL 576 acetoxy-curing -40 up to +265°C t.max. 280°C anthracite cartridge 310ml		
description	<p>Novasil 556 - cartridge 310ml - anthracite</p> <ul style="list-style-type: none"> - Developed for applications in the home appliance industry: <ul style="list-style-type: none"> - Gluing of oven door seals - Gluing of mounting brackets for cooker fascias, oven door seals and handles - Attachment of elastic seals, e.g. to oven doors <p>Temperature resistance: -40°C to +265°C</p>		

lubricants

silicone fats



GEV No.	890101	Ref. No.	0H7004
description	silicone grease FERMIT GLISSA tube 60g -40 to +200°C approval		
description	<p>Fermit GLISSA - tube 60g</p> <p>Non-drip lubricating grease for drinking water valves and fittings. Glissa silicone grease is suitable as a lubricant and sealant for drinking water valves and fittings (e.g. cartridges of single-lever mixers, switching valves and swivel spouts). Water-repellent, physiologically safe, sealing and has a high temperature resistance up to 200°C. Complies with the guidelines of the UBA for sanitary lubricants, tested by TZW for suitability for drinking water and approved in accordance with DIN ISO 21469.</p> <p>Temperature range: -40°C to +200°C</p>		

fuses

fine fuses



GEV No.	358677	Ref. No.	057783
description	fine fuse size ø5x20mm 4A fast-acting rated 250V Qty 10 pcs		



			
1			
GEV No.	358695	Ref. No.	005032
description	fine fuse size ø5x20mm 3.15A medium lag rated 250V Qty 10 pcs		

			
1			
GEV No.	358703	Ref. No.	002750
description	fine fuse size ø5x20mm 0.4A slow-acting rated 250V Qty 10 pcs		

			
1			
GEV No.	358397	Ref. No.	OK5074
description	fuse size 76mm 25A rated 690V Qty 1 pcs		

A			
axial fans		26	
B			
ball valves		56	
ball valves electric		26, 57	
bar burners		43	
bi-metal thermostats		7, 8	
boiling pan gaskets		54	
C			
cables		30	
cam switches		13	
ceramic heaters		4	
clamps		57, 58	
cold air circulating fans (complete)		27	
condensators & interference suppression filters		29	
consumables		58	
contactors		19	
control equipment		15	
control thermostats		8	
copper wire		30	
cross flow fans		27	
D			
door catches		51	
door seals		53	
drain pumps		29	
E			
edgemount latches		51	
electric accessories		30	
electrodes		26	
electronic controllers		22	
energy regulators		7	
F			
fans		26	
fasteners		58	
fastening material		57	
filters		29	
fine fuses		58	
float switches		13	
fuses		30, 58	
G			
gas burners		41	
gas control valves		33	
gas nozzles		44	
gas taps		30	
gas thermostats		33	
gaskets for heated units		53	
H			
handle latches		51	
heating elements		3	
heating elements for bain maries		3	
heating elements for griddles		3	
heating elements for large hobs		3	
heating elements for ovens		3	
heating elements for salamanders/toasters		4	
heating elements for tilting bratt pan		4	
hexagonal nuts		57	
high temperature silicone		58	
hob burners		41	
hose clamps		57, 58	
hoses		56	
hot air fans		28	
hot air motors		27	
hot plates		6	
I			
ignition cables		39	
ignition switches		40	
immersion heating elements		4	
indicator lights		16	
indicator lights (complete)		16	
industrial hoses		56	
K			
knurled nuts		57	
L			
lamps		16	
light bulbs		17	
lubricants		58	
M			
magnetic switches		14	
measuring equipment		57	
mechanical timers		19	
microswitches		12	
motors		28	
N			
neon light bulbs		16, 17	
Niplaflex hoses		56	
nuts		57	
O			
operating capacitors		29	
O-rings		54	
oven lamps		18	

P

piezoelectric igniters	39
pilot burners	34
position switches	12
pressure switches	26
probes	23
programme timers	18
pumps	28
PVC supply hoses	56

R

radiation heaters	6
refrigeration fans	27
relays	21
rocker/momentary rocker switches	11
roll pins	58
rotary switches	14

S

safety bi-metal thermostats	7
safety thermostats	9
sealants and adhesives	58
sealing washers	55
shaft gaskets	55
silicone	58
silicone fats	58
slot nuts	58
solenoid valves	25
solid state relays	20
supply hoses	56
switches and momentary switches	11

T

terminals	30
thermocouples	40
thermostats	7
time relays	21
timers	18
transformers	22
tube burners	44

V

valves and tank inlets	56
------------------------	----

W

wash and rinse pumps	28
washers	57