



GAS COMPONENTS



ELECTRIC COMPONENTS



WATER TECHNOLOGY



MECHANICAL COMPONENTS



TOOLS

Spare parts suitable for

THIELMANN

Find the complete and up-to-date range of products in our GEV Webshop



Manufacturer catalogue

The most important spare parts and accessories arranged clearly for every manufacturer

- ✓ Complete product range and all appliance data always up to date in the GEV Webshop
- ✓ Alphabetical Index at the end of the catalogue

GEV Webshop

www.gev-online.co.uk

www.gev-online.com



- 🔍 Add to Favourites
- 🔍 Sign In with email address and usual password
- 🔍 Easy-order – place several items in your basket at the same time
- 🔍 Quick Item search – no login needed



heating elements

heating elements for ovens

GEV No.	418223	Ref. No.	144168 540471
description	heating element 2000W 400V L 490mm W 560mm L1 25mm L2 465mm W1 530mm W2 30mm flange length 70mm flange width 22mm hole distance 56mm hole ø M4mm tube ø 6.3mm connection length 41mm connection male faston 6.3mm heating circuits 1 rectangular flange dry heating element oven		

GEV No.	418222	Ref. No.	144169 540831
description	heating element 2800W 400V L 500mm W 560mm L1 50mm L2 450mm W1 530mm W2 30mm flange length 70mm flange width 22mm hole distance 56mm tube ø 6.3mm dry heating element oven		

heating elements for fryers

GEV No.	415753	Ref. No.	N/A
description	heating element 6000W 400V L 324mm W 195mm H 265mm rectangular flange connection cable heating circuits 3 immersion heater L1 64mm L2 260mm hole distance 27mm hole ø 7mm flange length 90mm flange width 40mm cable length 1000mm tube ø 18mm W1 64mm W2 65mm		

GEV No.	418263	Ref. No.	144187 540441
description	heating element 7200W 230/400V heating circuits 3 L 360mm W 150mm H 220mm L1 25mm L2 335mm W1 58mm W2 42mm flange length 75mm flange width 30mm hole distance 63mm hole ø 5.5mm rectangular flange immersion heater		

GEV No.	415484	Ref. No.	N/A
description	heating element 6000W 230/400V heating circuits 3 L 367mm W 175mm H 246mm L1 90mm L2 277mm H1 229mm H2 17mm W1 50mm W2 75mm windings 6 flange ø 40.4mm cable length 130mm mounting ø 27mm rotation flange immersion heater		

GEV No.	415613	Ref. No.	140768
description	heating element 8000W 380V heating circuits 3 L 423mm W 145mm H 308mm L1 65mm L2 358mm W1 65mm W2 17mm H1 33mm H2 258mm H3 17mm thread M26x1.5 cable length 1200mm immersion heater		

heating elements for griddles

GEV No.	415759	Ref. No.	N/A	
description	heating element 2000W 230V heating circuits 1 L 455mm W 153mm H 20mm tube ø 8.5mm 2 hole fixing connection male faston 6.3mm thread M14x1.5 mounting distance 140mm for grill dry heating element			
accessories for	415759			
	GEV No.	510417	Ref. No.	—
	flat gasket fibre ED ø 20mm ID ø 14mm thickness 2mm Qty 1 pcs			
	GEV No.	520228	Ref. No.	—
	tooth lock washer ID ø 15.3mm ED ø 24mm steel Qty 1 pcs for thread M14			



Table continues overleaf

electric components





bottom heaters





GEV No.	415760	Ref. No.	144167 540463
description	bottom heater 1800W 230V heating circuits 1 ø 196mm safety thermostat°C thermostat 128°C M5 mounting distance 180mm		
spare parts for	415760		
	GEV No.	375300	Ref. No. —
accessories for	415760		
	GEV No.	520323	Ref. No. 144334
description	thermostat t.max. 128°C temperature range 35-128°C 1-pole 1NO 16A probe ø 3.1mm probe L 174mm capillary pipe 880mm capillary pipe isolated 800mm gland nut shaft L 23mm shaft position lower rotation 270°		
	GEV No.	520324	Ref. No. 144343
description	gasket ID ø 160mm ED ø 200mm hole distance 90/180mm hole ø 7mm silicone for bottom heaters		
description	counterflange ID ø 160mm ED ø 200mm hole distance 90/180mm hole ø 7mm SS for bottom heaters		

pilot heating elements



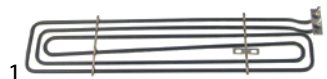

GEV No.	415653	Ref. No.	143895
description	heating element 600W 230V heating circuits 1 mounting ø 47.5mm L 280mm W 36mm H 16mm round flange connection male faston 6.3mm immersion heater tube ø 6.3mm thermostat sleeves ø 7mm length thermostat sleeves 220mm number of thermostat sleeves 1 pilot heating element		
spare parts for	415653		
	GEV No.	510408	Ref. No. —
accessories for	415653		
	GEV No.	510562	Ref. No. —
description	O-ring EPDM thickness 5.34mm ID ø 47mm Qty 1 pcs		
	GEV No.	550675	Ref. No. —
description	O-ring silicone thickness 5.34mm ID ø 47mm Qty 1 pcs		
description	O-ring Viton thickness 6mm ID ø 47mm Qty 1 pcs		

accessories for	415759		
	GEV No.	520230	Ref. No. —
description	nut thread M14x1.5 H 5mm WS 19 zinc-coated steel Qty 1 pcs		
	GEV No.	521101	Ref. No. —
description	nut thread M14x1.5 H 5mm WS 19 SS Qty 1 pcs		
	GEV No.	550262	Ref. No. —
description	flat gasket copper ED ø 20mm ID ø 14mm thickness 2mm		

	GEV No.	418238	Ref. No. 143831 540458
description	heating element 2000W 400V heating circuits 1 L 494mm W 96mm H 29mm tube ø 6.3mm rectangular flange connection male faston 6.3mm hole distance 36mm flange length 45mm flange width 16mm connection length 28mm mounting thread M4 dry heating element		

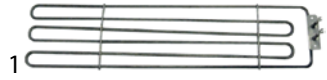
	GEV No.	415733	Ref. No. N/A
description	heating element 2500W 220V heating circuits 1 L 484mm W 150mm H 85mm tube ø 6.3mm L1 50mm L2 434mm W1 36mm W2 78mm 2 hole fixing connection male faston 6.3mm thread M10x1 windings 3 mounting distance 72mm for grill dry heating element		

	GEV No.	415594	Ref. No. 143648 182329
description	heating element 2565W 400V L 556mm W 126mm H 33mm connection male faston 6.3mm dry heating element heating circuits 1 tube ø 6.3mm W1 48mm W2 30mm rectangular flange hole distance 56mm flange length 70mm flange width 22mm mounting thread M4		

	GEV No.	415732	Ref. No. N/A
description	heating element 3000W 230V heating circuits 1 L 440mm W 180mm H 176mm tube ø 8.5mm L1 40mm L2 400mm W1 10mm W2 160mm 2 hole fixing connection male faston 6.3mm thread M14x1.5 mounting distance 152mm grill dry heating element		

heating elements for tilting bratt pan

	GEV No.	415594	Ref. No. 143648 182329
description	heating element 2565W 400V L 556mm W 126mm H 33mm connection male faston 6.3mm dry heating element heating circuits 1 tube ø 6.3mm W1 48mm W2 30mm rectangular flange hole distance 56mm flange length 70mm flange width 22mm mounting thread M4		



immersion heating elements

with round flange ø47.5mm



GEV No.	415604	Ref. No.	143833 541218
description	heating element 3000W 230/400V heating circuits 3 L 160mm W 36mm H 25mm connection male faston 6.3mm immersion heater round flange mounting ø 47.5mm		
accessories for	415604		
	GEV No.	510408	Ref. No. —
	O-ring EPDM thickness 5.34mm ID ø 47mm Qty 1 pcs		
	GEV No.	510562	Ref. No. —
	O-ring silicone thickness 5.34mm ID ø 47mm Qty 1 pcs		
	GEV No.	520235	Ref. No. —
	3 hole flange hole distance 70.5mm perforation ø 6.5mm ID ø 53.5mm		
	GEV No.	520236	Ref. No. —
	flange for heating element ID ø 50mm ED ø 90mm hole ø 6.5mm 3 holes		
	GEV No.	550002	Ref. No. —
	tension strap H 10mm L 21mm W 10mm hole ø 6.5mm for heating element		
	GEV No.	550362	Ref. No. —
	blind flange ø 64mm mounting ø 47.5mm		







GEV No.	418286	Ref. No.	143834 540821
description	heating element 6000W 230V heating circuits 2 L 392mm W 35mm H 40mm tube ø 6.2mm connection male faston 6.3mm immersion heater round flange L1 32mm L2 360mm H1 27mm H2 13mm mounting ø 47.5mm		
accessories for	418286		
	GEV No.	510408	Ref. No. —
	O-ring EPDM thickness 5.34mm ID ø 47mm Qty 1 pcs		
	GEV No.	510562	Ref. No. —
	O-ring silicone thickness 5.34mm ID ø 47mm Qty 1 pcs		
	GEV No.	520235	Ref. No. —
	3 hole flange hole distance 70.5mm perforation ø 6.5mm ID ø 53.5mm		
	GEV No.	520236	Ref. No. —
	flange for heating element ID ø 50mm ED ø 90mm hole ø 6.5mm 3 holes		
	GEV No.	550002	Ref. No. —
	tension strap H 10mm L 21mm W 10mm hole ø 6.5mm for heating element		
	GEV No.	550362	Ref. No. —
	blind flange ø 64mm mounting ø 47.5mm		

GEV No.	415405	Ref. No.	144346
description	heating element 6000W 230V heating circuits 3 L 465mm W 38mm H 24mm tube ø 6.3mm connection male faston 6.3mm immersion heater round flange mounting ø 47.5mm		
spare parts for	415405		
	GEV No.	504148	Ref. No. —
	boiler		
accessories for	415405		
	GEV No.	520235	Ref. No. —
	3 hole flange hole distance 70.5mm perforation ø 6.5mm ID ø 53.5mm		
	GEV No.	520236	Ref. No. —
	flange for heating element ID ø 50mm ED ø 90mm hole ø 6.5mm 3 holes		
	GEV No.	521012	Ref. No. —
	gasket graphite ED ø 15mm ID ø 5mm thickness 1.2mm Qty 1 pcs		
	GEV No.	550002	Ref. No. —
	tension strap H 10mm L 21mm W 10mm hole ø 6.5mm for heating element		
	GEV No.	550362	Ref. No. —
	blind flange ø 64mm mounting ø 47.5mm		



GEV No.	418270	Ref. No.	143836 540717
description	heating element 9000W 230V heating circuits 3 L 535mm W 36mm H 45mm tube ø 6.2mm connection male faston 6.3mm immersion heater round flange L1 35mm L2 500mm H1 35mm H2 10mm mounting ø 47.5mm		
accessories for	418270		
	GEV No.	510408	Ref. No. —
	O-ring EPDM thickness 5.34mm ID ø 47mm Qty 1 pcs		
	GEV No.	510562	Ref. No. —
	O-ring silicone thickness 5.34mm ID ø 47mm Qty 1 pcs		
	GEV No.	520235	Ref. No. —
	3 hole flange hole distance 70.5mm perforation ø 6.5mm ID ø 53.5mm		
	GEV No.	520236	Ref. No. —
	flange for heating element ID ø 50mm ED ø 90mm hole ø 6.5mm 3 holes		
	GEV No.	550002	Ref. No. —
	tension strap H 10mm L 21mm W 10mm hole ø 6.5mm for heating element		
	GEV No.	550362	Ref. No. —
	blind flange ø 64mm mounting ø 47.5mm		





1 			
GEV No.	418287	Ref. No.	144347
description	heating element 9000W 230V heating circuits 3 L 540mm W 37mm H 28mm tube ø 6.2mm immersion heater round flange mounting ø 47.5mm		
accessories for	418287		
	GEV No.	510408	Ref. No. —
	O-ring EPDM thickness 5.34mm ID ø 47mm Qty 1 pcs		
	GEV No.	510562	Ref. No. —
	O-ring silicone thickness 5.34mm ID ø 47mm Qty 1 pcs		
	GEV No.	520235	Ref. No. —
	3 hole flange hole distance 70.5mm perforation ø 6.5mm ID ø 53.5mm		
	GEV No.	520236	Ref. No. —
	flange for heating element ID ø 50mm ED ø 90mm hole ø 6.5mm 3 holes		
	GEV No.	550002	Ref. No. —
	tension strap H 10mm L 21mm W 10mm hole ø 6.5mm for heating element		
	GEV No.	550362	Ref. No. —
	blind flange ø 64mm mounting ø 47.5mm		

accessories

flange gaskets

1 			
GEV No.	520324	Ref. No.	144343
description	counterflange ID ø 160mm ED ø 200mm hole distance 90/180mm hole ø 7mm SS for bottom heaters		
accessories for	520324		
	GEV No.	520323	Ref. No. 144334
	gasket ID ø 160mm ED ø 200mm hole distance 90/180mm hole ø 7mm silicone for bottom heaters		

1 			
GEV No.	520323	Ref. No.	144334
description	gasket ID ø 160mm ED ø 200mm hole distance 90/180mm hole ø 7mm silicone for bottom heaters		

counterflanges			
1 			
GEV No.	520324	Ref. No.	144343
description	counterflange ID ø 160mm ED ø 200mm hole distance 90/180mm hole ø 7mm SS for bottom heaters		
accessories for	520324		
	GEV No.	520323	Ref. No. 144334
	gasket ID ø 160mm ED ø 200mm hole distance 90/180mm hole ø 7mm silicone for bottom heaters		

hot plates

square & rectangular



tiltable

1 			
GEV No.	490090	Ref. No.	144171
description	hot plate dimensions 300x300mm 4000W 400V with cast edge tilt boiling plate connection 4 screw clamps H 43mm square		

energy regulators

EGO

1-circuit

1 			
GEV No.	380036	Ref. No.	221406 538255
description	energy regulator 230V 13A turn direction right shaft ø 6x4.6mm mounting thread M12x1 no. 50.57024.010		
accessories for	380036		
	GEV No.	510792	Ref. No. —
	hexagonal nut thread M12x1 H 4mm WS 17 stainless steel Qty 1 pcs		



thermostats

control and safety thermostats

EGO

control thermostats

55.34_series



GEV No.	375708	Ref. No.	143766 540444
description	thermostat t.max. 188°C temperature range 95-188°C 3-pole 3NO 16A probe ø 6mm probe L 117mm capillary pipe 1780mm capillary pipe isolated 1400mm gland nut shaft ø 6x4.6mm shaft L 23mm shaft position upper rotation 270°		

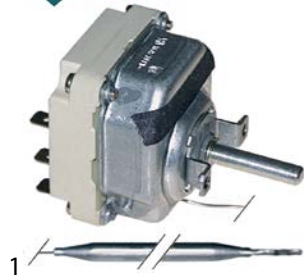

GEV No.	375038	Ref. No.	139783
description	thermostat t.max. 300°C temperature range 50-300°C 3-pole 3NO 16A probe ø 6mm probe L 79mm capillary pipe 1740mm capillary pipe isolated 800mm gland nut shaft ø 6x4.6mm shaft L 23mm shaft position upper rotation 270°		
accessories for	375038		
	GEV No.	110123	Ref. No. —
	knob thermostat t.max. 300°C ø 50mm shaft ø 6x4.6mm shaft flat upper black temperature range 50-300°C rotation 270°		



GEV No.	375019	Ref. No.	144180
description	thermostat t.max. 85°C temperature range 30-85°C 3-pole 3NO 16A probe ø 6mm probe L 131mm capillary pipe 1440mm capillary pipe isolatedmm gland nut M9x1 shaft ø 6x4.6mm shaft L 23mm shaft position upper rotation 270°		

safety thermostats

55.13_series



GEV No.	375519	Ref. No.	143830 540414
description	safety thermostat switch-off temp. 130°C 1-pole 1NO 16A probe ø 6mm probe L 129mm capillary pipe 830mm capillary pipe isolatedmm gland nut mounting thread M8x1 probe SS		
accessories for	375519		
	GEV No.	102067	Ref. No. —
	nut thread M8x1 H 3mm brass Qty 1 pcs type SEF 1		

55.32_series

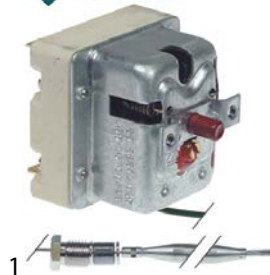

GEV No.	375707	Ref. No.	144182 540443
description	safety thermostat switch-off temp. 230°C 3-pole 20A probe ø 6mm probe L 87mm capillary pipe 1490mm capillary pipe isolated 1100mm gland nut M9x1 probe SS		

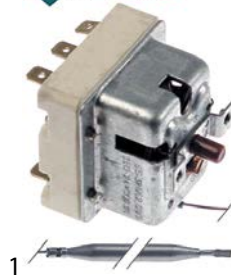

GEV No.	375695	Ref. No.	251116 540470
description	safety thermostat switch-off temp. 350°C 3-pole 20A probe ø 6mm probe L 77mm capillary pipe 890mm capillary pipe isolatedmm gland nut probe SS		

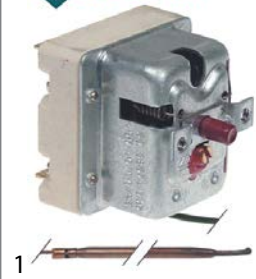

GEV No.	375706	Ref. No.	144095 540406
description	safety thermostat switch-off temp. 400°C 3-pole 3NC 20A probe ø 3.9mm probe L 228mm capillary pipe 1190mm capillary pipe isolatedmm gland nut probe SS		

4-position



GEV No.	300104	Ref. No.	141188
description	cam switch 4 operating positions 3NO/1CO sequence 0-1-2-3 32A shaft ø 6x4.6mm shaft L 23mm connection screw ceramic		

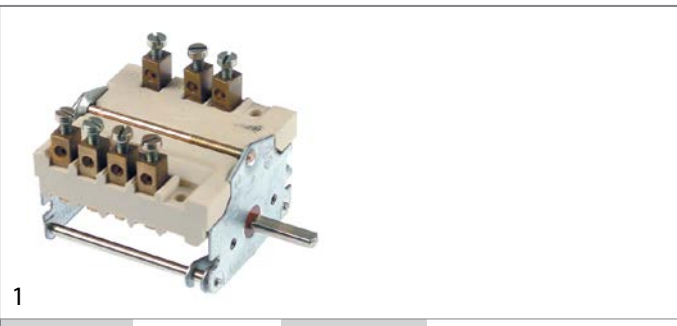

GEV No.	300190	Ref. No.	141924 540472
description	cam switch 4-position sequence 0-3-2-1 shaft ø 6x4.6mm connection screw clamp 3-pole		

7-position



GEV No.	300106	Ref. No.	141187
description	cam switch 7 operating positions 1NO/2CO sequence 0-1-2-3-4-5-6 32A shaft ø 6x4.6mm shaft L 23mm connection screw 7-position shaft flat upper		

4 operating positions

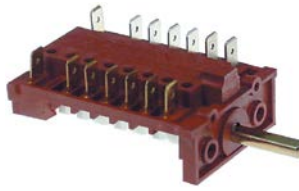

GEV No.	300193	Ref. No.	143765 540445
description	cam switch sequence 0-1-0-2		

switches and momentary switches

microswitches

pin-plunger actuated



GEV No.	345061	Ref. No.	144412
description	microswitch with plunger 250V 16A 1NC connection male faston 6.3mm ambient temperature max. 85°C mounting distance 22mm type BS1011 actuating force: 350g red stroke 15mm		



GEV No.	345060	Ref. No.	141907
description	microswitch with plunger 250V 16A 1NO connection male faston 6.3mm ambient temperature max. 85°C mounting distance 22mm type BS1010 actuating force: 350g red stroke 9mm		

cam switches

on/off



GEV No.	300074	Ref. No.	144696
description	cam switch 4 operating positions 2NO sequence 0-1-0-1 16A shaft ø 6x4.6mm shaft L 23mm connection male faston 6.3mm ceramic		



operation switches



1

GEV No.	300200	Ref. No.	142752 540461
description	operation switch 2 operating positions 2NO 16A sequence 0-1 shaft \varnothing 6x4.6mm shaft L 23mm connection male faston 6.3mm operation switch ceramic		

control equipment

MOELLER/EATON

push buttons - signal lamps



1

GEV No.	346271	Ref. No.	144412
description	push button mounting measurements \varnothing 22mm silver without button plate momentary		

switch blocks



1

GEV No.	345707	Ref. No.	143052
description	contact block 1NC/1NO		

button plates with symbol



1

GEV No.	346435	Ref. No.	141188 144411 144415
description	button plate black arrow		

lamps

indicator lights

indicator lights (complete)

\varnothing 12mm

with screw socket



1

GEV No.	359026	Ref. No.	540181
description	indicator light \varnothing 12mm 230V red connection male faston 6.3mm model CM/5		



1

GEV No.	359048	Ref. No.	540180
description	indicator light \varnothing 12mm 230V yellow connection male faston 6.3mm		



1

GEV No.	359027	Ref. No.	143841
description	indicator light \varnothing 12mm 250V green connection male faston 6.3mm		

contactors

GENERAL ELECTRIC (AEG)

power contactors



1

GEV No.	380261	Ref. No.	130274
description	power contactor resistive load 32A 230VAC (AC3/400V) 17A/7.5kW main contacts 3NO auxiliary contacts 1NO connection screw connection type AEG LS7K 10A type GE CL02A 310		



1

GEV No.	380265	Ref. No.	144345
description	power contactor resistive load 60A 230VAC (AC3/400V) 32A/16kW main contacts 3NO auxiliary contacts 1NO connection screw connection type AEG LS15K 00A type GE CL04A 310 H 98mm L 87mm W 55mm		

pressure switches

for steam control



1

GEV No.	541408	Ref. No.	143896 540416
description	pressure control ø 45mm pressure range 450/300mbar pressure connection vertical steam control pressure range 0.45/0.3bar connection 1/4" pressure connection 1/4"		

electric accessories

terminals and connectors

not insulated

female bullets



1

GEV No.	100112	Ref. No.	144992
description	female bullet size 2mm 0.25-1.0mm ² CuZn gal Sn t.max. 125°C Qty 20 pcs		

gas taps

PEL

21S series



1













GEV No.	101095	Ref. No.	144424	
description	gas tap PEL type 21S gas inlet M16x1.5 (tube ø 10mm) bypass nozzle ø 0.35mm gas outlet M16x1.5 (tube ø 10/8mm) thermocouple connection M8x1 pilot connection M10x1 shaft ø 8x6.5mm shaft L 22/15mm shaft flat lower			
spare parts for	101095			
	GEV No.	100408	Ref. No.	—
	bypass nozzle type PEL20/21 bore ø 0.35mm thread M5x0.5			
	GEV No.	101060	Ref. No.	—
	magnet unit standard L 39mm D1 ø 15.4mm D2 ø 11mm suitable for PEL20-21/JUNKERS/EGA			
	GEV No.	101206	Ref. No.	—
	gas tap front part shaft ø 8x6.5mm shaft L 22/15mm shaft flat upper/lower suitable for PEL21			
	GEV No.	101230	Ref. No.	—
	thermocouple nut T1: M8x1 T2: M18x1 aluminium			
accessories for	101095			
	GEV No.	100908	Ref. No.	—
	union screw thread M10x1 for pipe ø 4mm Qty 1 pcs			
	GEV No.	100909	Ref. No.	—
	union screw thread M10x1 for pipe ø 6mm Qty 1 pcs			
	GEV No.	101246	Ref. No.	—
	olive for pipe ø 4mm Qty 1 pcs			
	GEV No.	101278	Ref. No.	—
	olive for pipe ø 10mm Qty 1 pcs			
	GEV No.	101286	Ref. No.	—
	olive ID ø 6mm Qty 1 pcs			
	GEV No.	101300	Ref. No.	—
	union nut thread M16x1.5 tube ø 10mm			
	GEV No.	101450	Ref. No.	—
	olive for pipe ø 8mm L 12.7mm Qty 1 pcs ED ø 10mm			
	GEV No.	101451	Ref. No.	—
	union nut thread M16x1.5 tube ø 8mm			
	GEV No.	110081	Ref. No.	—
	knob ø 70mm shaft ø 8x6.5mm shaft flat universal			
	GEV No.	112206	Ref. No.	—
	knob dial plate silver gas tap PEL21/22/23 t.max.°C ED ø 63mm ID ø 45.5mm			



23S/V series



1

GEV No.	101630	Ref. No.	130124
description	gas tap PEL type 23S/V gas inlet 1/2" IT bypass nozzle ø 0.35mm gas outlet 1/2" MT (tube ø 14mm) thermocouple connection M10x1 pilot connection M10x1 shaft ø 10mm shaft L 25mm shaft flat		
spare parts for	101630		
	GEV No.	100455	Ref. No. —
	bypass nozzle type PEL23/24 bore ø 0.35mm thread M8x0.5		
	GEV No.	101059	Ref. No. —
	magnet unit T1: M10x1 T2: M22x1 L 46mm ø 18mm suitable for PEL23S M10x1		
	GEV No.	102767	Ref. No. —
	gas tap front part shaft ø 10mm shaft L 26.5mm shaft flat suitable for PEL23S		
accessories for	101630		
	GEV No.	100908	Ref. No. —
	union screw thread M10x1 for pipe ø 4mm Qty 1 pcs		
	GEV No.	100909	Ref. No. —
	union screw thread M10x1 for pipe ø 6mm Qty 1 pcs		
	GEV No.	100945	Ref. No. —
	roll pin ø 3.2mm L 10mm		
	GEV No.	101218	Ref. No. —
	shaft extension JUNKERS		
	GEV No.	101219	Ref. No. —
	shaft extension L 25mm JUNKERS		
	GEV No.	101246	Ref. No. —
	olive for pipe ø 4mm Qty 1 pcs		
	GEV No.	101286	Ref. No. —
	olive ID ø 6mm Qty 1 pcs		
	GEV No.	110064	Ref. No. —
	knob		
	GEV No.	110066	Ref. No. —
	knob screw		
	GEV No.	550396	Ref. No. —
	shaft extension L 25mm JUNKERS		

alternatives to JUNKERS



1

GEV No.	101630	Ref. No.	130124
description	gas tap PEL type 23S/V gas inlet 1/2" IT bypass nozzle ø 0.35mm gas outlet 1/2" MT (tube ø 14mm) thermocouple connection M10x1 pilot connection M10x1 shaft ø 10mm shaft L 25mm shaft flat		
spare parts for	101630		
	GEV No.	100455	Ref. No. —
	bypass nozzle type PEL23/24 bore ø 0.35mm thread M8x0.5		
	GEV No.	101059	Ref. No. —
	magnet unit T1: M10x1 T2: M22x1 L 46mm ø 18mm suitable for PEL23S M10x1		
	GEV No.	102767	Ref. No. —
	gas tap front part shaft ø 10mm shaft L 26.5mm shaft flat suitable for PEL23S		
accessories for	101630		
	GEV No.	100908	Ref. No. —
	union screw thread M10x1 for pipe ø 4mm Qty 1 pcs		
	GEV No.	100909	Ref. No. —
	union screw thread M10x1 for pipe ø 6mm Qty 1 pcs		
	GEV No.	100945	Ref. No. —
	roll pin ø 3.2mm L 10mm		
	GEV No.	101218	Ref. No. —
	shaft extension JUNKERS		
	GEV No.	101219	Ref. No. —
	shaft extension L 25mm JUNKERS		
	GEV No.	101246	Ref. No. —
	olive for pipe ø 4mm Qty 1 pcs		
	GEV No.	101286	Ref. No. —
	olive ID ø 6mm Qty 1 pcs		
	GEV No.	110064	Ref. No. —
	knob		
	GEV No.	110066	Ref. No. —
	knob screw		
	GEV No.	550396	Ref. No. —
	shaft extension L 25mm JUNKERS		















gas thermostats

PEL

24ST series



GEV No.	101900	Ref. No.	144428
description	gas thermostat PEL type 24ST up to 280°C gas inlet M20x1.5 (tube ø 12mm) bypass nozzle ø 0.8mm gas outlet M20x1.5 (tube ø 12/10mm) thermocouple connection M8x1 pilot connection M10x1 capillary pipe 1200mm probe ø 6mm probe L 120mm shaft ø 10x9mm shaft L 31/15mm shaft flat upper		
spare parts for	101900		
	GEV No.	100497	Ref. No. —
	bypass nozzle type PEL23/24 bore ø 0.8mm thread M8x0.5		
	GEV No.	101058	Ref. No. —
	magnet unit L 39mm D1 ø 15.4mm D2 ø 13.5mm suitable for PEL22/ EGA24197 standard		
	GEV No.	106199	Ref. No. —
	nut thread M8x1		
accessories for	101900		
	GEV No.	100908	Ref. No. —
	union screw thread M10x1 for pipe ø 4mm Qty 1 pcs		
	GEV No.	100909	Ref. No. —
	union screw thread M10x1 for pipe ø 6mm Qty 1 pcs		
	GEV No.	101246	Ref. No. —
	olive for pipe ø 4mm Qty 1 pcs		
	GEV No.	101248	Ref. No. —
	olive for pipe ø 12mm Qty 1 pcs suitable for PEL		
	GEV No.	101249	Ref. No. —
	olive for pipe ø 10mm Qty 1 pcs		
	GEV No.	101250	Ref. No. —
	union nut thread M20x1.5 for pipe ø 10mm		
	GEV No.	101251	Ref. No. —
	union nut thread M20x1.5 for pipe ø 12mm		
	GEV No.	101286	Ref. No. —
	olive ID ø 6mm Qty 1 pcs		
	GEV No.	110079	Ref. No. —
	knob dial plate gas thermostat 1-8 silver		
	GEV No.	110080	Ref. No. —
	knob ø 70mm shaft ø 10x8mm shaft flat universal		

24STS series

















GEV No.	106027	Ref. No.	144561 540403
description	gas thermostat PEL type 24STS 100-300°C gas inlet M20x1.5 (tube ø 12/10mm) bypass nozzle ø 0mm gas outlet M20x1.5 (tube ø 12/10mm) thermocouple connection M9x1 pilot connection M10x1 capillary pipe 1200mm probe ø 6mm probe L 100mm shaft ø 10x8mm shaft L 27/17mm shaft flat upper t.max. 300°C		
spare parts for	106027		
	GEV No.	100455	Ref. No. —
	bypass nozzle type PEL23/24 bore ø 0.35mm thread M8x0.5		
	GEV No.	101058	Ref. No. —
	magnet unit L 39mm D1 ø 15.4mm D2 ø 13.5mm suitable for PEL22/ EGA24197 standard		
accessories for	106027		
	GEV No.	101235	Ref. No. —
	gas connection thread M20x1.5 tube ø 12/10mm for PEL gas taps horizontal		
	GEV No.	101236	Ref. No. —
	gas connection thread M20x1.5 tube ø 12/10mm for PEL gas taps vertical		
	GEV No.	101240	Ref. No. —
	gas connection thread M20x1.5 tube ø 12/10mm for PEL gas taps with gasket and screws horizontal		
	GEV No.	101241	Ref. No. —
	gas connection thread M20x1.5 tube ø 12/10mm for PEL gas taps vertical		
	GEV No.	101248	Ref. No. —
	olive for pipe ø 12mm Qty 1 pcs suitable for PEL		
	GEV No.	101249	Ref. No. —
	olive for pipe ø 10mm Qty 1 pcs		
	GEV No.	101250	Ref. No. —
	union nut thread M20x1.5 for pipe ø 10mm		
	GEV No.	101251	Ref. No. —
	union nut thread M20x1.5 for pipe ø 12mm		
	GEV No.	101356	Ref. No. —
	gas tap PEL type 21S gas inlet M16x1.5 (tube ø 10mm) bypass nozzle ø 0.35mm gas outlet M16x1.5 (tube ø 10/8mm) thermocouple connection M10x1 pilot connection M10x1 shaft ø 8x6.5mm shaft L 22/15mm shaft flat lower		
	GEV No.	101460	Ref. No. —
	O-ring ø 12.37mm D1 ø 2.62mm suitable for PEL22		
	GEV No.	101461	Ref. No. —
	screw kit suitable for PEL22 Qty 4 pcs		
	GEV No.	106165	Ref. No. —
	gasket ø 27mm		

Table continues overleaf



accessories for 106027			
	GEV No.	110079	Ref. No. —
knob dial plate gas thermostat 1-8 silver			
	GEV No.	110080	Ref. No. —
knob ø 70mm shaft ø 10x8mm shaft flat universal			

accessories for 102831			
	GEV No.	100206	Ref. No. —
pilot burner nozzle SIT natural gas code 36 bore ø 0.60/0.55mm Qty 1 pcs suitable for SIT 150 series			
	GEV No.	100207	Ref. No. —
pilot burner nozzle SIT natural gas code 27 bore ø 0.40/0.38mm suitable for SIT 140 series			
	GEV No.	100216	Ref. No. —
pilot burner nozzle SIT natural gas code 38 bore ø 0.45mm Qty 1 pcs suitable for SIT 150 series			
	GEV No.	100897	Ref. No. —
olive for pipe ø 4mm Qty 1 pcs for pilot burner			
	GEV No.	100898	Ref. No. —
olive for pipe ø 6mm Qty 1 pcs for pilot burner			
	GEV No.	100908	Ref. No. —
union screw thread M10x1 for pipe ø 4mm Qty 1 pcs			
	GEV No.	100909	Ref. No. —
union screw thread M10x1 for pipe ø 6mm Qty 1 pcs			

gas valves and ignition boxes

ignition boxes

HONEYWELL







			
1			
GEV No.	101166	Ref. No.	144750 540409
description	ignition box HONEYWELL type S4560B 1006 electrodes 1 waiting time 0s safety time 10s 220-240V 10VA 50Hz		

ignition parts

pilot burners

SIT

140 - 145 -150 series

			
1			
GEV No.	102831	Ref. No.	144400 540450
description	pilot burner SIT type 140 series 2 flames nozzle ømm gas connectionmm		
spare parts for	102831		
	GEV No.	100701	Ref. No. —
ignition electrode connection M4 Qty 1 pcs			
	GEV No.	100906	Ref. No. —
screw connection thread M10x1 for ignition electrode brass Qty 1 pcs WS 10			
	GEV No.	100907	Ref. No. —
screw connection thread M10x1 Qty 1 pcs type SEF 1 ømm for thermocouple			
accessories for	102831		
	GEV No.	100204	Ref. No. —
pilot burner nozzle SIT LPG code 14 bore ø 0.18/0.20mm Qty 1 pcs suitable for 140 series			
	GEV No.	100205	Ref. No. —
pilot burner nozzle SIT LPG code 19 bore ø 0.23/0.26mm Qty 1 pcs suitable for SIT 150 series			

JUNKERS

CB 502 series

pilot burners

















			
1			
GEV No.	100062	Ref. No.	130132
description	pilot burner JUNKERS type CB502021 natural gas nozzle no.6 gas connection 6mm with primary air		
spare parts for	100062		
	GEV No.	100227	Ref. No. —
pilot burner nozzle natural gas gas pressure 25mbar code 6 Qty 1 pcs suitable for JUNKERS CB50203_			
	GEV No.	100719	Ref. No. —
ignition electrode D1 ø 7mm D2 ø 9mm connection M4 L1 12mm L2 17mm BL1 18mm BL2 3mm BL3 23mm			
	GEV No.	100907	Ref. No. —
screw connection thread M10x1 Qty 1 pcs type SEF 1 ømm for thermocouple			
	GEV No.	100909	Ref. No. —
union screw thread M10x1 for pipe ø 6mm Qty 1 pcs			
	GEV No.	101287	Ref. No. —
olive for pipe ø 6mm Qty 1 pcs			
	GEV No.	101291	Ref. No. —
screw connection for igniter			

Table continues overleaf

accessories for		100062		
	GEV No.	100220	Ref. No.	143544
	pilot burner nozzle LPG gas pressure 50mbar code 2 Qty 1 pcs suitable for JUNKERS CB503_			
	GEV No.	100221	Ref. No.	—
	pilot burner nozzle LPG gas pressure 30mbar code 29 Qty 1 pcs suitable for JUNKERS CB50203_			
	GEV No.	100222	Ref. No.	—
	pilot burner nozzle LPG gas pressure 50mbar code 5 Qty 1 pcs suitable for JUNKERS CB50203_			
	GEV No.	100223	Ref. No.	—
	pilot burner nozzle natural gas gas pressure 20mbar code 3 Qty 1 pcs suitable for JUNKERS CB503_			
	GEV No.	100224	Ref. No.	—
	pilot burner nozzle natural gas gas pressure 25mbar code 26 Qty 1 pcs suitable for JUNKERS CB503_			
	GEV No.	100225	Ref. No.	—
	pilot burner nozzle LPG gas pressure 30mbar code 39 Qty 1 pcs suitable for JUNKERS CB503_			
	GEV No.	100226	Ref. No.	—
	pilot burner nozzle LPG gas pressure 50mbar code 15 suitable for JUNKERS			
	GEV No.	100228	Ref. No.	—
	pilot burner nozzle town gas gas pressure 8mbar code 4 Qty 1 pcs suitable for JUNKERS CB50203_			
	GEV No.	101281	Ref. No.	—
	olive for pipe ø 4mm L 8.7mm Qty 1 pcs suitable for CB 502/503			
	GEV No.	101283	Ref. No.	—
	union screw thread M10x1 for pipe ø 4mm Qty 1 pcs			

accessories for		100085		
	GEV No.	100220	Ref. No.	143544
	pilot burner nozzle LPG gas pressure 50mbar code 2 Qty 1 pcs suitable for JUNKERS CB503_			
	GEV No.	100221	Ref. No.	—
	pilot burner nozzle LPG gas pressure 30mbar code 29 Qty 1 pcs suitable for JUNKERS CB50203_			
	GEV No.	100222	Ref. No.	—
	pilot burner nozzle LPG gas pressure 50mbar code 5 Qty 1 pcs suitable for JUNKERS CB50203_			
	GEV No.	100223	Ref. No.	—
	pilot burner nozzle natural gas gas pressure 20mbar code 3 Qty 1 pcs suitable for JUNKERS CB503_			
	GEV No.	100224	Ref. No.	—
	pilot burner nozzle natural gas gas pressure 25mbar code 26 Qty 1 pcs suitable for JUNKERS CB503_			
	GEV No.	100225	Ref. No.	—
	pilot burner nozzle LPG gas pressure 30mbar code 39 Qty 1 pcs suitable for JUNKERS CB503_			
	GEV No.	100226	Ref. No.	—
	pilot burner nozzle LPG gas pressure 50mbar code 15 suitable for JUNKERS			
	GEV No.	100228	Ref. No.	—
	pilot burner nozzle town gas gas pressure 8mbar code 4 Qty 1 pcs suitable for JUNKERS CB50203_			
	GEV No.	101281	Ref. No.	—
	olive for pipe ø 4mm L 8.7mm Qty 1 pcs suitable for CB 502/503			
	GEV No.	101283	Ref. No.	—
	union screw thread M10x1 for pipe ø 4mm Qty 1 pcs			

				
1				
GEV No.	100085	Ref. No.	140928	
description	pilot burner JUNKERS type CB502031 natural gas nozzle no.6 gas connection 6mm with primary air			
spare parts for	100085			
	GEV No.	100227	Ref. No.	—
	pilot burner nozzle natural gas gas pressure 25mbar code 6 Qty 1 pcs suitable for JUNKERS CB50203_			
	GEV No.	100704	Ref. No.	—
	ignition electrode D1 ø 9mm connection M4 D2 ø 11mm L1 17mm L2 17mm BL1 13mm BL2 4mm BL3 22mm			
	GEV No.	100909	Ref. No.	—
	union screw thread M10x1 for pipe ø 6mm Qty 1 pcs			
	GEV No.	101287	Ref. No.	—
	olive for pipe ø 6mm Qty 1 pcs			
	GEV No.	101292	Ref. No.	—
	union screw for igniter suitable for CB 502/505 Qty 1 pcs			
	GEV No.	101295	Ref. No.	—
	clamping collet for thermocouple suitable for CB 502/505 Qty 1 pcs			







				
1				
GEV No.	100061	Ref. No.	140928	
description	pilot burner JUNKERS type CB502031 natural gas nozzle no.6 gas pressure 25mbar gas connection 6mm with primary air code 6			
spare parts for	100061			
	GEV No.	100227	Ref. No.	—
	pilot burner nozzle natural gas gas pressure 25mbar code 6 Qty 1 pcs suitable for JUNKERS CB50203_			
	GEV No.	100909	Ref. No.	—
	union screw thread M10x1 for pipe ø 6mm Qty 1 pcs			
	GEV No.	101287	Ref. No.	—
	olive for pipe ø 6mm Qty 1 pcs			
	GEV No.	101295	Ref. No.	—
	clamping collet for thermocouple suitable for CB 502/505 Qty 1 pcs			
accessories for	100061			
	GEV No.	100220	Ref. No.	143544
	pilot burner nozzle LPG gas pressure 50mbar code 2 Qty 1 pcs suitable for JUNKERS CB503_			



Table continues overleaf









accessories for		100061	
	GEV No.	100221	Ref. No. —
pilot burner nozzle LPG gas pressure 30mbar code 29 Qty 1 pcs suitable for JUNKERS CB50203_			
	GEV No.	100222	Ref. No. —
pilot burner nozzle LPG gas pressure 50mbar code 5 Qty 1 pcs suitable for JUNKERS CB50203_			
	GEV No.	100223	Ref. No. —
pilot burner nozzle natural gas gas pressure 20mbar code 3 Qty 1 pcs suitable for JUNKERS CB503_			
	GEV No.	100224	Ref. No. —
pilot burner nozzle natural gas gas pressure 25mbar code 26 Qty 1 pcs suitable for JUNKERS CB503_			
	GEV No.	100225	Ref. No. —
pilot burner nozzle LPG gas pressure 30mbar code 39 Qty 1 pcs suitable for JUNKERS CB503_			
	GEV No.	100226	Ref. No. —
pilot burner nozzle LPG gas pressure 50mbar code 15 suitable for JUNKERS			
	GEV No.	100228	Ref. No. —
pilot burner nozzle town gas gas pressure 8mbar code 4 Qty 1 pcs suitable for JUNKERS CB50203_			
	GEV No.	100704	Ref. No. —
ignition electrode D1 ø 9mm connection M4 D2 ø 11mm L1 17mm L2 17mm BL1 13mm BL2 4mm BL3 22mm			
	GEV No.	100851	Ref. No. —
cover for pilot burner suitable for JUNKERS CB502_ SS			
	GEV No.	100907	Ref. No. —
screw connection thread M10x1 Qty 1 pcs type SEF 1 ømm for thermocouple			
	GEV No.	101281	Ref. No. —
olive for pipe ø 4mm L 8.7mm Qty 1 pcs suitable for CB 502/503			
	GEV No.	101283	Ref. No. —
union screw thread M10x1 for pipe ø 4mm Qty 1 pcs			
	GEV No.	101292	Ref. No. —
union screw for igniter suitable for CB 502/505 Qty 1 pcs			

CB 503 series

pilot burners

			
1			
GEV No.	100118	Ref. No.	141118
description	pilot burner JUNKERS type CB503002 natural gas nozzle no.3 gas connection 4mm with primary air		
spare parts for	100118		
	GEV No.	100223	Ref. No. —
pilot burner nozzle natural gas gas pressure 20mbar code 3 Qty 1 pcs suitable for JUNKERS CB503_			
	GEV No.	101281	Ref. No. —
olive for pipe ø 4mm L 8.7mm Qty 1 pcs suitable for CB 502/503			

spare parts for		100118	
	GEV No.	101283	Ref. No. —
union screw thread M10x1 for pipe ø 4mm Qty 1 pcs			
accessories for		100118	
	GEV No.	100220	Ref. No. 143544
pilot burner nozzle LPG gas pressure 50mbar code 2 Qty 1 pcs suitable for JUNKERS CB503_			
	GEV No.	100221	Ref. No. —
pilot burner nozzle LPG gas pressure 30mbar code 29 Qty 1 pcs suitable for JUNKERS CB50203_			
	GEV No.	100222	Ref. No. —
pilot burner nozzle LPG gas pressure 50mbar code 5 Qty 1 pcs suitable for JUNKERS CB50203_			
	GEV No.	100224	Ref. No. —
pilot burner nozzle natural gas gas pressure 25mbar code 26 Qty 1 pcs suitable for JUNKERS CB503_			
	GEV No.	100909	Ref. No. —
union screw thread M10x1 for pipe ø 6mm Qty 1 pcs			
	GEV No.	101287	Ref. No. —
olive for pipe ø 6mm Qty 1 pcs			



















			
1			
GEV No.	100101	Ref. No.	141119
description	pilot burner JUNKERS type CB503003 LPG nozzle no.2 gas connection 4mm with primary air		
spare parts for	100101		
	GEV No.	100224	Ref. No. —
pilot burner nozzle natural gas gas pressure 25mbar code 26 Qty 1 pcs suitable for JUNKERS CB503_			
	GEV No.	101281	Ref. No. —
olive for pipe ø 4mm L 8.7mm Qty 1 pcs suitable for CB 502/503			
	GEV No.	101283	Ref. No. —
union screw thread M10x1 for pipe ø 4mm Qty 1 pcs			
accessories for		100101	
	GEV No.	100220	Ref. No. 143544
pilot burner nozzle LPG gas pressure 50mbar code 2 Qty 1 pcs suitable for JUNKERS CB503_			
	GEV No.	100221	Ref. No. —
pilot burner nozzle LPG gas pressure 30mbar code 29 Qty 1 pcs suitable for JUNKERS CB50203_			
	GEV No.	100222	Ref. No. —
pilot burner nozzle LPG gas pressure 50mbar code 5 Qty 1 pcs suitable for JUNKERS CB50203_			
	GEV No.	100223	Ref. No. —
pilot burner nozzle natural gas gas pressure 20mbar code 3 Qty 1 pcs suitable for JUNKERS CB503_			
	GEV No.	100226	Ref. No. —
pilot burner nozzle LPG gas pressure 50mbar code 15 suitable for JUNKERS			

Table continues overleaf



accessories for		100101	
	GEV No.	100227	Ref. No. —
pilot burner nozzle natural gas gas pressure 25mbar code 6 Qty 1 pcs suitable for JUNKERS CB50203_			
	GEV No.	100228	Ref. No. —
pilot burner nozzle town gas gas pressure 8mbar code 4 Qty 1 pcs suitable for JUNKERS CB50203_			
	GEV No.	100909	Ref. No. —
union screw thread M10x1 for pipe ø 6mm Qty 1 pcs			
	GEV No.	101287	Ref. No. —
olive for pipe ø 6mm Qty 1 pcs			
	GEV No.	102110	Ref. No. —
pilot tube copper pipe ø 4mm thickness 1mm L 3000mm			
	GEV No.	102111	Ref. No. —
pilot tube copper pipe ø 6mm thickness 1mm L 3000mm			

			
1	GEV No.	100058	Ref. No. 141118
description pilot burner JUNKERS type CB503006 natural gas nozzle no.26 gas connection 4mm			
spare parts for		100058	
	GEV No.	100224	Ref. No. —
pilot burner nozzle natural gas gas pressure 25mbar code 26 Qty 1 pcs suitable for JUNKERS CB503_			
	GEV No.	101281	Ref. No. —
olive for pipe ø 4mm L 8.7mm Qty 1 pcs suitable for CB 502/503			
	GEV No.	101283	Ref. No. —
union screw thread M10x1 for pipe ø 4mm Qty 1 pcs			
accessories for		100058	
	GEV No.	100220	Ref. No. 143544
pilot burner nozzle LPG gas pressure 50mbar code 2 Qty 1 pcs suitable for JUNKERS CB503_			
	GEV No.	100221	Ref. No. —
pilot burner nozzle LPG gas pressure 30mbar code 29 Qty 1 pcs suitable for JUNKERS CB50203_			
	GEV No.	100222	Ref. No. —
pilot burner nozzle LPG gas pressure 50mbar code 5 Qty 1 pcs suitable for JUNKERS CB50203_			
	GEV No.	100223	Ref. No. —
pilot burner nozzle natural gas gas pressure 20mbar code 3 Qty 1 pcs suitable for JUNKERS CB503_			
	GEV No.	100226	Ref. No. —
pilot burner nozzle LPG gas pressure 50mbar code 15 suitable for JUNKERS			
	GEV No.	100227	Ref. No. —
pilot burner nozzle natural gas gas pressure 25mbar code 6 Qty 1 pcs suitable for JUNKERS CB50203_			
	GEV No.	100228	Ref. No. —
pilot burner nozzle town gas gas pressure 8mbar code 4 Qty 1 pcs suitable for JUNKERS CB50203_			

accessories for		100058	
	GEV No.	100909	Ref. No. —
union screw thread M10x1 for pipe ø 6mm Qty 1 pcs			
	GEV No.	101287	Ref. No. —
olive for pipe ø 6mm Qty 1 pcs			
	GEV No.	102110	Ref. No. —
pilot tube copper pipe ø 4mm thickness 1mm L 3000mm			
	GEV No.	102111	Ref. No. —
pilot tube copper pipe ø 6mm thickness 1mm L 3000mm			

producer-specific pilot burners

THIELMANN



1	GEV No.	102829	Ref. No. 193301 540920
description pilot burner type C			



1	GEV No.	102830	Ref. No. 193303 540921
description pilot burner type D/E			

ignition cables

terminals and connectors



1	GEV No.	100112	Ref. No. 144992
description female bullet size 2mm 0.25-1.0mm ² CuZn gal Sn t.max. 125°C Qty 20 pcs			



piezoelectric igniters

mounting diameter 18mm



1			
GEV No.	100004	Ref. No.	540955
description	piezoelectric igniter body plastic blowing mounting ø 18mm connection ø2.4mm		

mounting diameter 22mm



1			
GEV No.	100008	Ref. No.	144333
description	piezoelectric igniter body plastic blowing mounting ø 22mm connection ø2mm cable lengthmm		

miscellaneous



1			
GEV No.	nla ¹	Ref. No.	137552
description	piezoelectric igniter body metal connection F6.3x0.8 2 hole fixing ø 22mm		

¹no longer available

thermocouples

plug-in thermocouples

plug-in thermocouples standard

with barrel socket ø5mm - type Junkers with aluminised tip



GEV No.	102204	Ref. No.	144902
description	thermocouple M8x1 L 600mm plug connection ø5.0mm		

with barrel socket ø6mm

type Junkers with aluminised tip

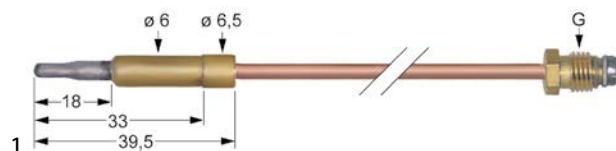

GEV No.	102017	Ref. No.	136031
description	thermocouple M8x1 L 1000mm plug connection ø6.0mm		

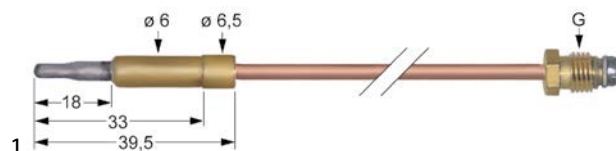

GEV No.	102219	Ref. No.	136030
description	thermocouple M8x1 L 450mm plug connection ø6.0mm		

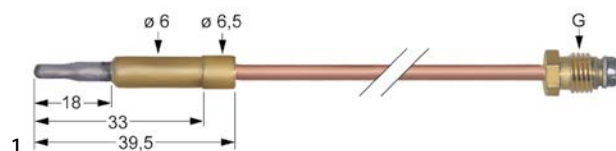

GEV No.	102220	Ref. No.	139384
description	thermocouple M8x1 L 600mm plug connection ø6.0mm		

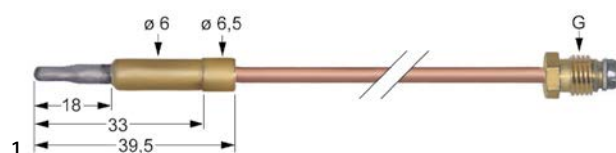

GEV No.	102221	Ref. No.	136031
description	thermocouple M8x1 L 750mm plug connection ø6.0mm		

with barrel socket ø6(6.5)mm

thermocouples SIT

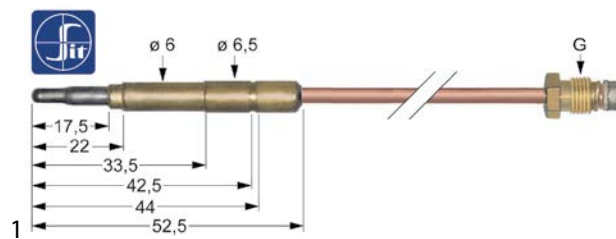

GEV No.	107619	Ref. No.	144404
description	thermocouple SIT M10x1 L 1000mm plug connection ø6.0(6.5)mm		



threaded thermocouples

threaded thermocouples standard

with socket with thread M8x1

SIT

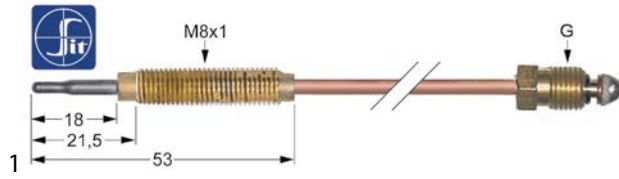

GEV No.	107628	Ref. No.	144305
----------------	--------	-----------------	--------

description thermocouple SIT M8x1 L 320mm M8x1

accessories for 107628

	GEV No.	102067	Ref. No.	—
nut thread M8x1 H 3mm brass Qty 1 pcs type SEF 1				

accessories

display adapters



GEV No.	100947	Ref. No.	141109
----------------	--------	-----------------	--------

description display adapter thread M8x1

interrupters



GEV No.	101258	Ref. No.	140286
----------------	--------	-----------------	--------

description interrupter thread M10x1

gas burners

hob burners

producer-specific hob burners

THIELMANN

HG series



GEV No.	105873	Ref. No.	144340 540486
----------------	--------	-----------------	------------------

description burner cap C ø 94mm with central hole



GEV No.	105874	Ref. No.	114341 540487
----------------	--------	-----------------	------------------

description burner cap D/E ø 94mm with central hole



GEV No.	105871	Ref. No.	193466
----------------	--------	-----------------	--------

description burner head C



GEV No.	105870	Ref. No.	193467
----------------	--------	-----------------	--------

description burner head D



GEV No.	105869	Ref. No.	193468
----------------	--------	-----------------	--------

description burner head E

solid tops



GEV No.	105875	Ref. No.	144818
----------------	--------	-----------------	--------

description burner suitable for solid top





bar burners

bar burners

 <p>1</p>			
GEV No.	105905	Ref. No.	141960 541545
description	bar burner ømm W 28mm H 42mm L 295mm flange width 35mm flange length 70mm kettle		

 <p>Image not available</p> <p>1</p>			
GEV No.	105877	Ref. No.	193635
description	burner griddle		

 <p>Image not available</p> <p>1</p>			
GEV No.	105917	Ref. No.	144615
description	burner ømm tilting bratt pan		

 <p>1</p>			
GEV No.	105919	Ref. No.	144558
description	burner ømm tilting bratt pan		

 <p>Image not available</p> <p>1</p>			
GEV No.	105876	Ref. No.	193660
description	burner oven		

gas nozzles

pilot burner nozzles

pilot burner nozzles JUNKERS

CB 50203_/503_ series

 <p>1</p>			
GEV No.	100220	Ref. No.	143544
description	pilot burner nozzle LPG gas pressure 50mbar code 2 Qty 1 pcs suitable for JUNKERS CB503_		

knobs

producer-specific knobs

THIELMANN

 <p>1</p>			
GEV No.	111831	Ref. No.	144104 540422
description	knob without symbol ø 68mm shaft ø 6x4.6mm shaft flat upper		

 <p>1</p>			
GEV No.	111835	Ref. No.	540449
description	knob dial plate gas tap with ignition flame ED ø 65mm ID ø 50mm		

 <p>1</p>			
GEV No.	111839	Ref. No.	540456
description	knob dial plate gas thermostat 1-8 t.max.°C		



1

GEV No.	111833	Ref. No.	144108 540469
description	knob dial plate oven TH/BH/TH+BH t.max. °C ED ø 65mm ID ø 50mm		



1

GEV No.	111838	Ref. No.	144107 540477
description	knob dial plate switch 7-position		



1

GEV No.	111869	Ref. No.	541138
description	knob dial plate thermostat t.max. 180°C 100-180°C		

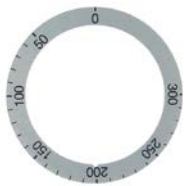

1

GEV No.	111834	Ref. No.	144109 540457
description	knob dial plate thermostat t.max. 300°C 50-300°C ED ø 65mm ID ø 50mm		

handles and hand wheels

hand wheels

hand wheels



1

GEV No.	690800	Ref. No.	144139 540403
description	hand wheel ø 160mm D1 ø 45mm bore ø 16mm depth of bore 32mm thread groove width 5mm L1 25mm L2 60mm handle length 82mm with folding handle		
spare parts for	690800		
	GEV No.	514428	Ref. No. —
	folding handle ø 25mm total length 115mm seat ø 26mm thread M8 with automatic return		



1

GEV No.	690901	Ref. No.	144139 540403
description	hand wheel ø 160mm D1 ø 45mm bore ø 16mm thread groove width 5mm L1 27mm L2 60mm handle length 85mm with folding handle		
spare parts for	690901		
	GEV No.	514428	Ref. No. —
	folding handle ø 25mm total length 115mm seat ø 26mm thread M8 with automatic return		



accessories

marking caps



1

GEV No.	514358	Ref. No.	151904
description	marking cap blue hood handle		



1

GEV No.	514359	Ref. No.	151903
description	marking cap red hood handle		

fittings for catering equipment

lid hinges

type ECHTERMANN

10 series

10.80

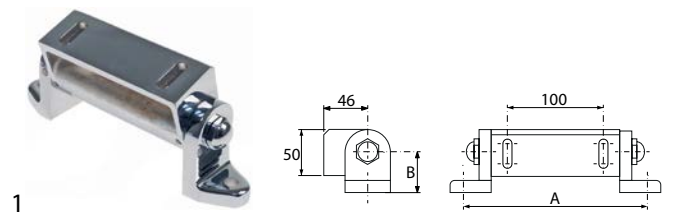

GEV No.	693448	Ref. No.	144466
description	lid hinge type 1080 level of centre of rotation 45mm load capacity 50-60NM opening angle 80° closing angle 10° mounting distance 198mm bore ø 11mm MD lid 100mm chrome-plated brass		
spare parts for	693448		
	GEV No.	691614	Ref. No.
	repair kit for lid hinge load capacity 50-60NM		

12 series

12.84

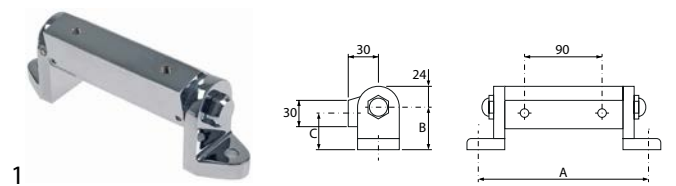

GEV No.	693447	Ref. No.	144138
description	lid hinge type 1284 level of centre of rotation 50mm load capacity 30-50NM opening angle 80° closing angle 10° mounting distance 198mm bore ø 11mm MD lid 90mm 26.5 MT lid M8mm chrome-plated brass		
spare parts for	693447		
	GEV No.	691613	Ref. No.
	repair kit for lid hinge load capacity 30-50NM		

steam traps

steam traps

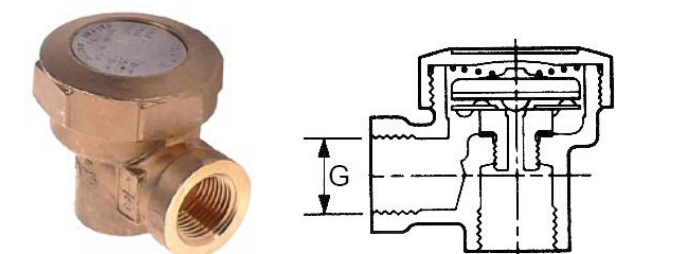

1

GEV No.	514272	Ref. No.	144742 540408
description	thermostatic steam trap thread 1/2" type AV13 brass		

safety valves

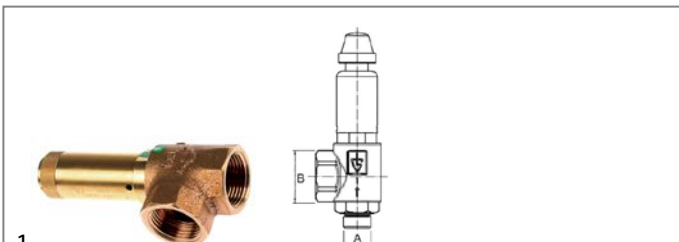

1

GEV No.	514354	Ref. No.	144749
description	safety valve T1: 1" T2: 1" triggering pressure 0.5bar		



1

GEV No.	700515	Ref. No.	144661 541124
description	gas tension spring 900N		

valves and tank inlets

inlet taps

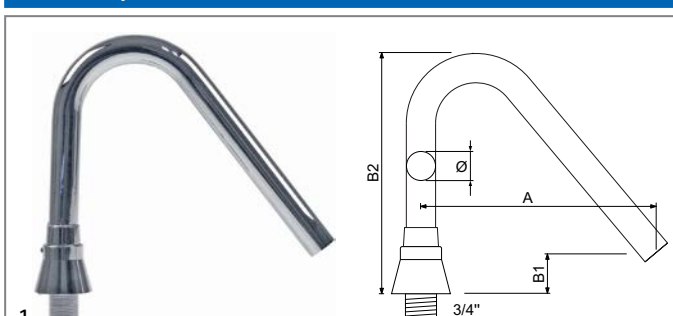

1

GEV No.	514332	Ref. No.	144407
description	inlet tap connection 3/4" ET tube ø 25mm projection 200mm overall height 200mm spout height 25mm rotation 360°		

baskets

fryer baskets

THIELMANN



1

GEV No.	970448	Ref. No.	143772 540446
description	fryer basket L1 320mm W1 180mm H1 120mm		

springs

gas tension springs

gas tension springs



1

GEV No.	700513	Ref. No.	144662 540478
description	gas tension spring 700N		

B		
bar burners	19	
bottom heaters	4	
C		
cam switches	8	
contactors	9	
control equipment	9	
control thermostats	7	
E		
electric accessories	10	
energy regulators	6	
F		
female bullets	10	
G		
gas burners	18	
gas nozzles	19	
gas taps	10	
gas thermostats	12	
H		
heating elements	3	
heating elements for fryers	3	
heating elements for griddles	3	
heating elements for ovens	3	
heating elements for tilting bratt pan	4	
hob burners	18	
hot plates	6	
I		
ignition boxes	13	
ignition cables	16	
immersion heating elements	5	
indicator lights	9	
indicator lights (complete)	9	
inlet spouts	22	
inlet taps	22	
L		
lamps	9	
M		
microswitches	8	
P		
piezoelectric igniters	17	
pilot burners	13	
pilot heating elements	4	
pressure switches	10	
S		
safety thermostats	7	
switches and momentary switches	8	
T		
terminals and connectors	10	
thermocouples	17	
thermostats	7	
V		
valves and tank inlets	22	