



GAS COMPONENTS



ELECTRIC COMPONENTS



WATER TECHNOLOGY



MECHANICAL COMPONENTS



TOOLS

Spare parts suitable for

TURBOCHEF

Find the complete and up-to-date range of products in our GEV Webshop



Manufacturer catalogue

The most important spare parts and accessories arranged clearly for every manufacturer

- ✓ Complete product range and all appliance data always up to date in the GEV Webshop
- ✓ Alphabetical Index at the end of the catalogue

GEV Webshop

www.gev-online.co.uk

www.gev-online.com





- 🔍 Add to Favourites
- 🔍 Sign In with email address and usual password
- 🔍 Easy-order – place several items in your basket at the same time
- 🔍 Quick Item search – no login needed





heating elements

heating elements for microwaves

 <p>1</p>			
GEV No.	418738	Ref. No.	HHB-3202 HHB-3216 HHB-8099 HHB-8201
description	heating element 2500W 208V heating circuits 1 L 450mm W 170mm thread 1/4" mounting distance 162mm tube ø 8mm dry heating element 2 hole fixing connection length 60mm with mounting kit Qty 2 pcs		
For models:	HHB, HHB2		

 <p>1</p>			
GEV No.	418717	Ref. No.	100649 NGC-3003 NGC-3086
description	heating element 3000W 208V heating circuits 1 L 395mm W 395mm W2 305mm tube ø 11mm cable length 200mm W1 45mm flange ø 25mm mounting ø 19mm suitable for TURBOCHEF NGC		
For models:	NGC		

heaters

 <p>1</p>			
GEV No.	418712	Ref. No.	100661 NGC-3011
description	heater 3300W 208V heating circuits 1 L 320mm W 147mm H 30mm connection M5 convection heating element hole ø 6.5mm suitable for TURBOCHEF NGC		
For models:	NGC		
spare parts for	418712		
	GEV No.	691396	Ref. No. NGC-1043
	 <p>gasket L 320mm W 145mm for heating element</p>		

 <p>1</p>			
GEV No.	418715	Ref. No.	100652-1
description	heating element 4800W 240V heating circuits 1 L 250mm W 180mm H 53mm tube ø 11mm thread 5/8" UNF cable length 160mm hot air H1 7mm H2 46mm mounting distance 170mm suitable for Turbochef		
For models:	C3, C3AB, C3C, C3C-MULTI, C3D, C3-MULTI		

heating elements for convection

 <p>1</p>			
GEV No.	418758	Ref. No.	i5-3216 i5-9317
description	heating element 3000+3000W 208V L 330mm W 170mm tube ø 8mm service kit		

 <p>1</p>			
GEV No.	418971	Ref. No.	i3-9378
description	heating element 3000W 208V heating circuits 1 L 255mm W 75mm flange length 65mm flange width 19mm		

accessories

flange gaskets

 <p>1</p>			
GEV No.	691433	Ref. No.	C0342 TC3-0194
description	gasket L 290mm W 230mm for heating element		
For models:	C3, C3AB, C3C, C3C-MULTI, C3D, C3-MULTI		

 <p>1</p>			
GEV No.	691396	Ref. No.	NGC-1043
description	gasket L 320mm W 145mm for heating element		
For models:	NGC		

 <p>1</p>			
GEV No.	418716	Ref. No.	NGC-3012
description	insulation for heating element		
For models:	NGC		



thermostats

bi-metal thermostats

bi-metal thermostats



GEV No.	390615	Ref. No.	102085 102086
description	bi-metal thermostat hole distance 23.5mm switch-off temp. °C 1NO 16A connection F6.3 starting temperature 48.9°C for axial flow fan		
For models:	C3, C3AB, C3C, C3C-MULTI, C3D, C3-MULTI, HHB, HHB2, HHC2020, HHC3240, i3, i5, NGC, NGO		



GEV No.	390614	Ref. No.	102070
description	bi-metal thermostat hole distance 40mm switch-off temp. 100°C 1NC 16A connection F6.3 for Magnetron suitable for TURBOCHEF C3		
For models:	C3, C3AB, C3C, C3C-MULTI, C3D, C3-MULTI, i5, NGC		

control and safety thermostats

EGO

safety thermostats

55.33_series



GEV No.	375882	Ref. No.	102075
description	safety thermostat switch-off temp. 300°C 3-pole 20A probe ø 4mm probe L 157mm capillary pipe 520mm capillary pipe isolatedmm gland nut probe SS		

56._series



GEV No.	375883	Ref. No.	7603 R7603
description	safety thermostat switch-off temp. 350°C 1-pole 16A probe ø 3.03mm probe L 138mm capillary pipe 1760mm capillary pipe isolated 1710mm gland nut probe SS		
For models:	C3, C3AB, C3C, C3C-MULTI, C3-MULTI		

switches and momentary switches

microswitches

lever actuated



GEV No.	347010	Ref. No.	102012
description	microswitch with lever 250V 16A 1CO connection male faston 4.8mm L 36mm ambient temperature max. 105°C mounting distance 22mm type D3V-16G443-1C25-K actuating force: 50g lever length 28mm		
For models:	C3D, HHB2, i3, i5, NGC, NGO		



GEV No.	347201	Ref. No.	102013 i1-3207
description	microswitch with lever 250V 16A 1CO connection male faston 4.8mm L 37mm ambient temperature max. 105°C mounting distance 22mm type D3V-16G443-1C25-K actuating force: 70g lever length 27mm		
For models:	NGO		

accessories



GEV No.	691391	Ref. No.	NGC-1194
description	holding plate for microswitch L 28mm W 16mm		
For models:	NGC		



			
1			
GEV No.	691389	Ref. No.	NGC-1126
description	opposite support for microswitch L 44mm W 13mm		
For models:	NGC		

magnetic switches

29x19mm

			
1			
GEV No.	347005	Ref. No.	HHB-3209
description	magnetic switch L 29mm W 19mm 1NO		
For models:	HHB		

accessories

magnets

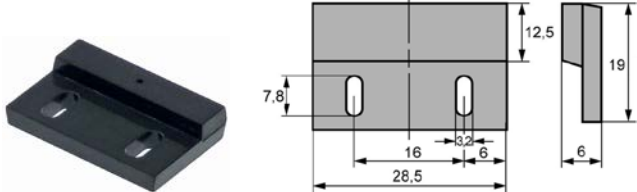
			
1			
GEV No.	345700	Ref. No.	102789
description	magnet \varnothing mm L 29mm H 6.5mm W 19mm hole distance 16mm M3 hole \varnothing 3.5mm		
For models:	HHB		



alarm devices

alarm units

			
1			
GEV No.	350139	Ref. No.	NGC-3083
description	alarm device \varnothing 31.75mm H 9.5mm 2 hole fixing 80dB protection IP54		
For models:	C3, C3D, HHB, HHB2, NGC		

solid state relays

CRYDOM

				
1				
GEV No.	400780	Ref. No.	101285 TC3-3221	
description	solid state relay CRYDOM 1 phase 50A 240V 3-32VDC L 59mm W 46mm kit screw type D2450			
For models:	C3, C3AB, C3C, C3C-MULTI, C3-MULTI			
spare parts for	400780			
	GEV No.	400781	Ref. No.	—
	description	solid state relay CRYDOM 1 phase 50A 24-280V 3-32VDC L 59mm W 46mm screw type D2450		
	GEV No.	401676	Ref. No.	—
	description	heat-conducting foil L 57mm W 45mm		

			
1			
GEV No.	400559	Ref. No.	101284 NGC-3005
description	solid state relay CRYDOM 2 phase 40A 120-240V 24VDC L 59mm W 46mm plug-in connection type D2440DE-6816		
For models:	C3, C3D, HHB, HHB2, HHC2020, i3, i5, NGC, NGO		

accessories

diodes

high voltage diodes

			
1			
GEV No.	379654	Ref. No.	100480 100481
description	hv diode type HV07-16 connection F6.3 cable lengthmm suitable for TURBOCHEF NGC		
For models:	C3, C3AB, C3C, C3C-MULTI, C3D, C3-MULTI, i3, i5, NGC, NGO		



relays

power relays

with DIN rail mounting

upper



1			
GEV No.	380884	Ref. No.	101279
description	power relays MAGNECRAFT 24VDC NO 30A/NC 3A 2CO connection male faston 6.3mm dimensions 34x52mm manuf. no. W92S11D22D-24 277V		
For models:	HHC2020		

with bracket mounting



1			
GEV No.	380806	Ref. No.	101274
description	power relays 24VDC 20A		
For models:	HHC3240, i3, i5, NGC, NGO		
accessories for	380806		
	GEV No.	380805	Ref. No.
			—
	support bracket		



1			
GEV No.	380861	Ref. No.	101271 101273
description	power relays MAGNECRAFT 24VDC 16A 2CO connection male faston 6.3mm raster size 22.2mm bracket mounting at 250V 15A manuf. no. 389CX-179 24VDC		
For models:	C3D, HHB, HHB2, i3, i5, NGC, NGO		



1			
GEV No.	380860	Ref. No.	101272
description	power relays MAGNECRAFT 24VDC 16A 3CO connection male faston 6.3mm raster size 11.1mm bracket mounting at 250V 15A manuf. no. 389CX-178 24VDC		
For models:	i3, i5, NGC, NGO		

plug-in/print relays



1			
GEV No.	380862	Ref. No.	T0278
description	plug-in relay 2CO		
For models:	C3, C3AB, C3C, C3C-MULTI, C3-MULTI		

relay sockets



1			
GEV No.	380863	Ref. No.	T0309
description	relay socket		
For models:	C3, C3AB, C3C, C3C-MULTI, C3-MULTI		



magnetrons



1

GEV No.	402048	Ref. No.	100860 TC3-3233
description	Magnetron HITACHI type 2M121A suitable for TURBOCHEF C3		
For models:	C3, C3AB, C3C, C3C-MULTI, C3D, C3-MULTI		
accessories for	402048		
	GEV No.	390614	Ref. No. 102070
	bi-metal thermostat hole distance 40mm switch-off temp. 100°C 1NC 16A connection F6.3 for Magnetron suitable for TURBOCHEF C3		



1

GEV No.	402053	Ref. No.	100861
description	Magnetron LG type suitable for TURBOCHEF NGC		



1

GEV No.	403321	Ref. No.	NGC-3015
description	Magnetron TOSHIBA type 2M248J(FD) suitable for TURBOCHEF NGC		
For models:	i3, i5, NGC, NGO		

transformers

HV transformers



1

GEV No.	402050	Ref. No.	102104 NGC-3061-2
description	filament transformer		
For models:	i3, i5, NGC, NGO		



1

GEV No.	401989	Ref. No.	102093 102093-1 TC3-3223
description	HV transformer		
For models:	C3, C3AB, C3C, C3C-MULTI, C3D, C3-MULTI		



1

GEV No.	401987	Ref. No.	102091 102091-1 TC3-3222
description	HV transformer primary 200-208/240VV 50/60Hz for microwaves		
For models:	C3, C3AB, C3C, C3C-MULTI, C3D, C3-MULTI		



1

GEV No.	401998	Ref. No.	102103 DPC102103 NGC-3062-2
description	HV transformer primary 230V secondary 2000KV connection male faston 50Hz type DPC102103 for microwave		
For models:	i3, i5, NGC, NGO		



probes

producer-specific probes

probes



GEV No.	379643	Ref. No.	HHC-6517
description	probe Pt100 cable glass fibre probe -200 up to +600°C cable -50 up to +350°C connection plug thread probe ø5x150mm cable length 0.3m		
For models:	HHC3240, i3, i5		



GEV No.	379642	Ref. No.	HHC-6517-2
description	probe Pt100 cable glass fibre probe -200 up to +600°C cable -50 up to +350°C connection plug thread probe ø5x50mm cable length 0.3m		
For models:	HHC2020, NGO		

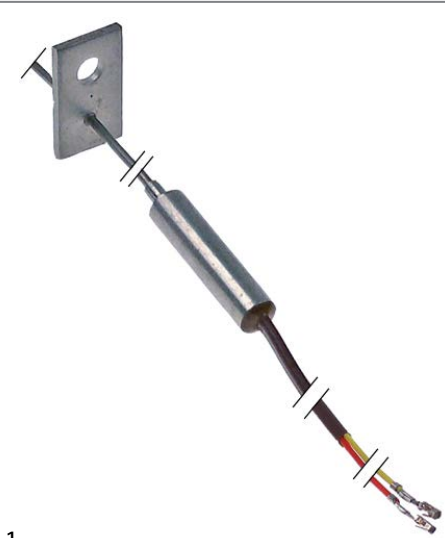

GEV No.	379897	Ref. No.	HHB-8170 NGC-1140
description	thermocouple thermocouple J (Fe-CuNi) cable PTFE probe -50 up to +750°C cable -40 up to +250°C connection 2-wire thread probe ø1.5x155mm cable length 1m		
For models:	HHB, HHB2, NGC		

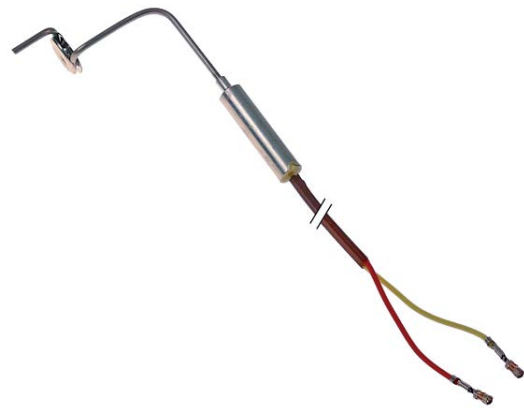

GEV No.	379895	Ref. No.	HHB-8170 NGC-1140
description	thermocouple thermocouple K (NiCr-Ni) cable PTFE probe -50 up to 1150°C cable -40 up to +250°C connection 2-wire thread		



GEV No.	379894	Ref. No.	102065
description	thermocouple thermocouple K (NiCr-Ni) cable PTFE probe -50 up to 1150°C cable -40 up to +250°C connection 2-wire thread probe ø1.5x155mm cable length 1m		
For models:	C3, C3AB, C3C, C3C-MULTI, C3D, C3-MULTI		



GEV No.	379896	Ref. No.	700-1199
description	thermocouple thermocouple K (NiCr-Ni) cable PTFE probe -50 up to 1150°C cable -40 up to +250°C connection 2-wire thread probe ø2.5x10mm cable length 0.1m		
For models:	C3, C3D, HHB, HHB2, i5, NGC		

accessories

screw connections



GEV No.	691450	Ref. No.	102718
description	screw connection thread 1/16 x 1/8NPT		

electronics

EPROMS



GEV No.	401978	Ref. No.	NGC-1099-9
description	EPROM SUBWAY suitable for TURBOCHEF NGC CODE 3C0173		

1

GEV No.	401999	Ref. No.	NGC-1099-17 NGC-3027-1
description	EPROM suitable for DUNKIN DONUTS CODE 39F9B5 15.03.07		



1

GEV No.	401979	Ref. No.	NGC-1099-4
description	EPROM suitable for TURBOCHEF NGC CODE 3C8F89 11.05.05		

PCBs



1

GEV No.	401901	Ref. No.	HHB-3213-1
description	control PCB		



1

GEV No.	401973	Ref. No.	CON-3007-4-1 NGC-3026-4 NGC-3044-1
description	control PCB		



1

GEV No.	401988	Ref. No.	C0265 TC3-3213-0294
description	control PCB countries Europe Smart Menü		



1

GEV No.	402132	Ref. No.	NGC-1054-2
description	control PCB hot-air microwave oven TURBOCHEF NGC complete		
For models:	NGC		



1

GEV No.	403864	Ref. No.	CON-3008-1-1
description	control PCB L 185mm W 115mm		



1

GEV No.	403883	Ref. No.	CON-3009-2-25
description	control PCB L 185mm W 115mm countries Europe Smart Menü		



1

GEV No.	401704	Ref. No.	CON-3007-11-3 NGC-3055-3
description	control PCB STARBUCKS		



1

GEV No.	401995	Ref. No.	HHB-3204 HHB-8131
description	display		



1

GEV No.	402177	Ref. No.	103360 CON-7004 i5-3207
description	display L 130mm W 105mm suitable for TURBOCHEF i5 service kit		
For models:	i3, i5		

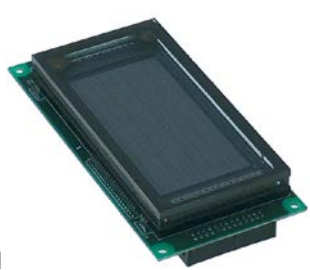

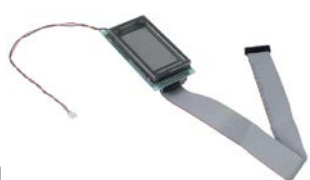

1

GEV No.	401996	Ref. No.	T0238 TC3-3229
description	display suitable for TURBOCHEF C3 complete incl. control		



1

GEV No.	401997	Ref. No.	T0238 TC3-3229	
description	display suitable for TURBOCHEF C3 complete incl. control			
For models:	C3, C3AB, C3C, C3C-MULTI, C3D, C3-MULTI			
spare parts for	401997			
	GEV No.	401971	Ref. No.	NGC-1110-1
	membrane keypad suitable for Turbochef L 295mm W 100mm			
	GEV No.	401996	Ref. No.	T0238 TC3-3229
	display suitable for TURBOCHEF C3 complete incl. control			



1

GEV No.	402229	Ref. No.	100505 HHB-3204 HHB-8131
description	display suitable for TURBOCHEF HHC2020 complete incl. control		
For models:	HHB, HHB2, HHC2020, HHC3240		





1

GEV No.	401910	Ref. No.	100505 HHB-3204 HHB-8131 TC3-3229
description	display suitable for Turbochef model 3240/2020 VFD		



1

GEV No.	401991	Ref. No.	HHB-3204 NGC-3023	
description	display suitable for TURBOCHEF NGC with cable			
For models:	HHC2020, NGC			
spare parts for	401991			
	GEV No.	401680	Ref. No.	100184 NGC-1530
	ribbon cable 26-pole L 290mm plug type FC-26P raster size 2.54mm			



1

GEV No.	402299	Ref. No.	100446 CON-7039
description	PCB		
For models:	i3, i5, NGO		



1

GEV No.	403051	Ref. No.	CON-3007-8-7
description	PCB microwave Turbochef NGC, SAGE 2, SUBWAY countries (Europe,Asia,Pacific) with „BLANK SMART CARD“ Service Kit I/O PCB Subway		



1

GEV No.	403601	Ref. No.	CON-7013
description	PCB NGC-HHB-C3D-2020		
For models:	C3, C3D, HHB, HHB2, HHC2020, NGC		



1

GEV No.	401886	Ref. No.	100446 CON-7039
description	PCB NGO-i3-i5		



1

GEV No.	402102	Ref. No.	NGC-1008 NGC-3049-7
description	PCB suitable for TURBOCHEF NGC countries (Europe,Asia,Pacific) with „BLANK SMART CARD“ Service Kit I/O PCB Subway		
For models:	HHB		

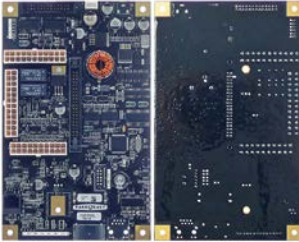

1

GEV No.	402178	Ref. No.	CON-3001 CON-3001-1-1 CON-3001-XXXX i5-3208-1
description	PCB TURBOCHEF i3-i5 L 190mm W 115mm service kit		
For models:	i3, i5		



1

GEV No.	401985	Ref. No.	M9608
description	power PCB TURBOCHEF C3 115-230V vottage output 24VDCV		
For models:	C3, C3AB, C3C, C3C-MULTI, C3-MULTI		



1

GEV No.	401990	Ref. No.	101206 NGC-3069 (old version)
description	power supply voltage input 100-240VACV vottage output 24VDCV		
For models:	HHB		



1

GEV No.	401984	Ref. No.	101211 NGC-3069
description	power supply with housing		
For models:	C3D, HHB, HHB2, HHC2020, HHC3240, i3, i5, NGC, NGO		

central units



1

GEV No.	401993	Ref. No.	100431 TC3-3234-1
description	menübox		

keypads

membrane keypads



1

GEV No.	402179	Ref. No.	i5-9247
description	membrane keypad buttons 26 suitable for TURBOCHEF i5 L 634mm W 85mm		
For models:	i5		



1

GEV No.	402227	Ref. No.	i3-9247
description	membrane keypad for i3 L 515mm W 85mm		



1

GEV No.	402180	Ref. No.	HHC-1234
description	membrane keypad for oven buttons 11 L 203mm W 74mm		
For models:	HHC2020, HHC3240		



1

GEV No.	401907	Ref. No.	NGC-1110-3
description	membrane keypad STARBUCKS suitable for Turbochef L 295mm W 98mm		
For models:	NGC		

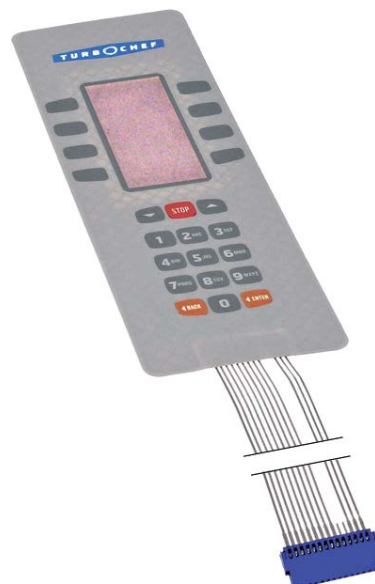

1

GEV No.	401971	Ref. No.	NGC-1110-1
description	membrane keypad suitable for Turbochef L 295mm W 100mm		
For models:	NGC		



1

GEV No.	401972	Ref. No.	NGC-1110-2
description	membrane keypad suitable for TURBOCHEF SUBWAY L 295mm W 100mm		
For models:	NGC		

accessories



1

GEV No.	691406	Ref. No.	NGC-1040
description	front panel suitable for TURBOCHEF NGC		
For models:	NGC		



fans

axial fans



import



GEV No.	601460 ¹	Ref. No.	TC3-3210
description	axial fan L 119mm W 119mm H 25mm 230VAC 50/60Hz 14/16W bearing ball bearing connection male faston 6.3mm conversion kit ORION suitable for TURBOCHEF C3 fan wheel ø 110mm temp.-resist. 80°C		
For models:	C3		
spare parts for	601460		
	GEV No.	601131	Ref. No. —
	axial fan L 119mm W 119mm H 25mm 230VAC 50/60Hz 19/18W bearing ball bearing connection male faston 2.8mm metal ADDA fan wheel ø 110mm temp.-resist. 70°C		

¹with ball bearings



GEV No.	601080 ¹	Ref. No.	100516
description	axial fan L 119mm W 119mm H 38mm 230VAC 50/60Hz 23/20W bearing ball bearing connection male faston 2.8mm metal ADDA fan wheel ø 110mm temp.-resist. 70°C		
For models:	HHB, HHB2, NGO		
accessories for	601080		
	GEV No.	550898	Ref. No. —
	connecting cable cable length 2000mm connection F 2.8 connection distance 7.9mm for axial flow fan		
	GEV No.	692519	Ref. No. —
	guard L 120mm W 120mm plastic		

¹with ball bearings

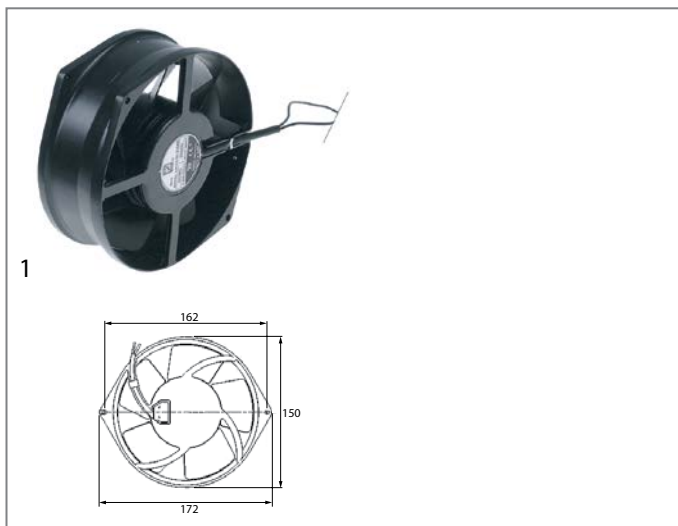

GEV No.	601469 ¹	Ref. No.	100085
description	axial fan L 172mm W 150mm H 55mm 230VAC 50/60Hz 42W bearing ball bearing connection cable metal ORION fan wheel ø 140mm temp.-resist. 70°C		
For models:	C3		

¹with ball bearings

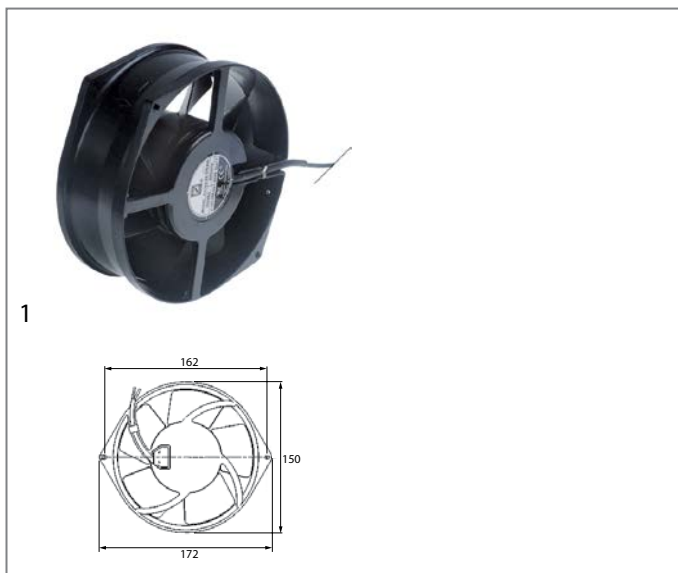

GEV No.	601500 ¹	Ref. No.	TC3-0433
description	axial fan L 172mm W 150mm H 55mm 230VAC 50/60Hz 42W bearing ball bearing connection cable metal ORION fan wheel ø 145mm temp.-resist. 70°C		
For models:	C3D, HHC2020, i3, i5		

¹with ball bearings

ebmpapst

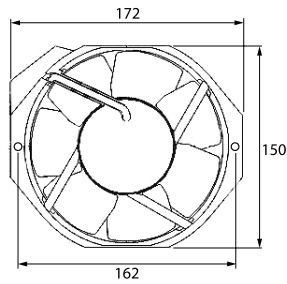

1

GEV No.	601459	Ref. No.	100518 NGC-3077
description	axial fan L 172mm W 150mm H 55mm 230VAC 50/60Hz		

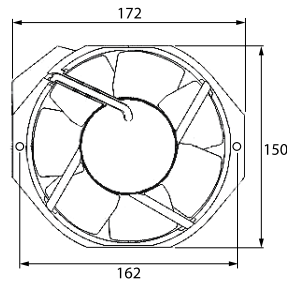

1

GEV No.	601473 ¹	Ref. No.	100518 100574 NGC-3077
description	axial fan L 172mm W 150mm H 55mm 230VAC 50/60Hz 35W bearing ball bearing connection male faston 2.8mm metal ORION suitable for Turbochef fan wheel ø 140mm temp.-resist. 70°C		
For models:	NGC		

¹with ball bearings



1

GEV No.	601468 ¹	Ref. No.	100519 100519-1 M9609 TC3-3202
description	axial fan D1 ø 172mm D2 ø 195mm H 55mm 24VDC 50W bearing ball bearing manuf. no. FDD24Z3A2 connection cable 300mm cable length 300mm with protective grid FALCON suitable for Turbochef fan wheel ø 155mm round		
For models:	C3, C3AB, C3C, C3C-MULTI, C3-MULTI		

¹with ball bearings

hot air motors



1

GEV No.	601461	Ref. No.	NGC-1019-2 NGC-1020 NGC-3007	
description	fan wheel D1 ø 160mm H1 40mm blades 12 D2 ø 16mm D3 ø 16mm H2 16mm			
For models:	NGC			
spare parts for	601461			
	GEV No.	601466	Ref. No.	700-0306-2
	flange for fan motor ED ø 44.5mm int. ø 2 16mm thickness 6.5mm steel			



1

GEV No.	601466	Ref. No.	700-0306-2
description	flange for fan motor ED ø 44.5mm int. ø 2 16mm thickness 6.5mm steel		
For models:	C3, C3AB, C3D, C3-MULTI		





hot air fans

miscellaneous

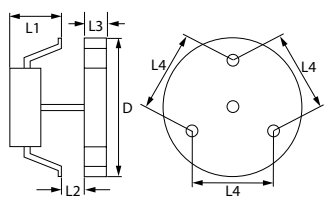

1



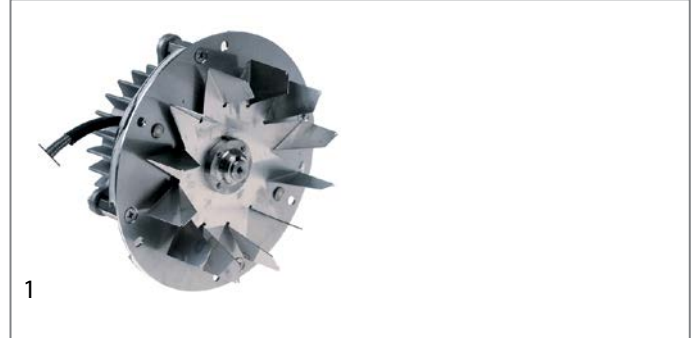

GEV No.	601462	Ref. No.	100882 NGC-1025
description	hot air fan 180V L1 91mm L2 5mm L3 40mm L4 95mm fan wheel ø 180mm Aspen type M34-0030 2A		
For models:	NGC		
spare parts for	601462		
	GEV No.	601461	Ref. No. NGC-1019-2 NGC-1020 NGC-3007
fan wheel D1 ø 160mm H1 40mm blades 12 D2 ø 16mm D3 ø 16mm H2 16mm			

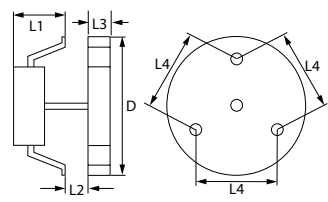

1



GEV No.	601465	Ref. No.	HHB-8106 TC3-0213
description	hot air fan 180V L1 91mm L2 5mm L3 45mm L4 95mm fan wheel ø 170mm Aspen type M34-0030 2A		
For models:	C3, C3D, HHB, HHB2		
spare parts for	601465		
	GEV No.	601466	Ref. No. 700-0306-2
flange for fan motor ED ø 44.5mm int. ø 216mm thickness 6.5mm steel			
	GEV No.	691380	Ref. No. 605-0070
ring ø 170mm for fan wheel			

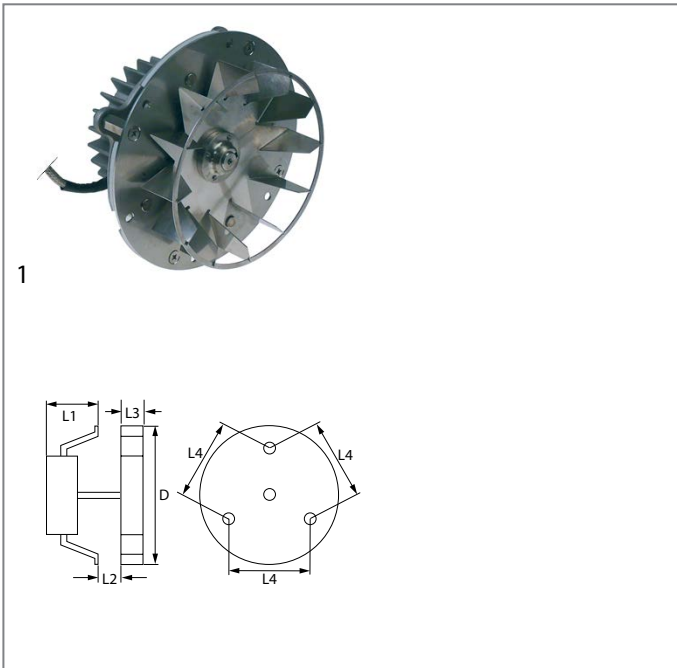

GEV No.	601471	Ref. No.	C0299 T0076 T0299 TC3-3201
description	hot air fan 180V L1 91mm L2 7mm L3 43mm L4 95mm fan wheel ø 160mm Aspen type M34-0030 with PCB and service instruction 2A		
For models:	C3, C3AB, C3C, C3C-MULTI, C3-MULTI		
spare parts for	601471		
	GEV No.	403601	Ref. No. CON-7013
PCB NGC-HHB-C3D-2020			



GEV No.	601675	Ref. No.	103551 i3-3209-2 i3-3209-4 i3-9042
description	fan motor 180VAC 1.4A mounting pos. lower fan wheel ø 97mm		
For models:	i5		



GEV No.	601676	Ref. No.	i3-3209-1 i3-3209-3 i3-9040 i3-9040.B
description	fan motor 180VAC 1.4A mounting pos. upper L1 90mm L2mm L3mm L4 100mm fan wheel ø 97mm type RM34-0111		



GEV No.	601660	Ref. No.	i5-3218-2 i5-3218-4 i5-9042 i5-9221
description	fan motor 180VAC 250W 1.4A mounting pos. lower L1 88mm L2 18mm L3 52mm L4 100mm fan wheel ø 97mm for i5		
For models:	i5		



GEV No.	601661	Ref. No.	i5-3218-1 i5-3218-3 i5-9040 i5-9220
description	fan motor 180VAC 250W 1.4A mounting pos. upper L1 88mm L2 18mm L3 52mm L4 100mm fan wheel ø 97mm		
For models:	i5		





accessories

fan wheels for hot air fans



1

GEV No.	691432	Ref. No.	605-0069
description	fan wheel ø 170mm W 42.5mm shaft intake ø 25mm blades 12		
For models:	C3, C3AB, C3C, C3C-MULTI, C3D, C3-MULTI		
accessories for	691432		
	GEV No.	601466	Ref. No. 700-0306-2
	flange for fan motor ED ø 44.5mm int. ø 2 16mm thickness 6.5mm steel		
	GEV No.	691380	Ref. No. 605-0070
	ring ø 170mm for fan wheel		

miscellaneous



1

GEV No.	691380	Ref. No.	605-0070
description	ring ø 170mm for fan wheel		
For models:	C3, C3AB, C3C, C3C-MULTI, C3D, C3-MULTI		

radial fans

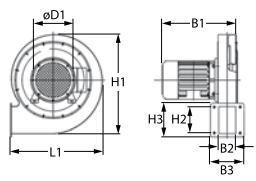
1

GEV No.	601472	Ref. No.	100083
description	radial fan 230V voltage AC 50/60Hz 65/80W H1 190mm L1 195mm D1 ø 110mm W1 71mm W2 44.5mm H2 47mm W3 49mm H3 68mm		
For models:	C3D, HHC3240, i5, NGC		

miscellaneous



1

GEV No.	601464	Ref. No.	T0262
description	radial fan 24V voltage DC 26W H1 160mm L1 160mm D1 ø 101mm W1 50mm W2 34mm H2 62mm W3 40mm H3 115mm for Magnetron		
For models:	C3, C3AB, C3C, C3C-MULTI, C3-MULTI		

motors

gear motors

for ovens

for flues



1

GEV No.	601467	Ref. No.	100891
description	gear motor CROUZET type 823440 3W 230V 50Hz 6rpm shaft ø 4mm L 65mm W 51mm H 34mm		
For models:	C3, C3AB, C3C, C3C-MULTI, C3D, C3-MULTI		
accessories for	601467		
	GEV No.	691422	Ref. No. C0283 T0283
	gear wheel for gear motor suitable for TURBOCHEF C3		



1

GEV No.	601470	Ref. No.	HHB-3200 HHB-3231 HHB-8048 HHB-8135
description	gear motor CROUZET type 80533004 16.7W 230V 60Hz 3.6rpm shaft ø 8mm L 87mm W 61mm H 56mm		
For models:	HHB, HHB2		

condensators & interference suppression filters

filters

line filters

with housing



1

GEV No.	365071	Ref. No.	100541 100542 C0980
description	line filter 15A capacity 0.004µF		
For models:	C3, C3C-MULTI, C3D, C3-MULTI, HHC3240		



1

GEV No.	365112	Ref. No.	100543
description	line filter 250V 50/60Hz 40A		
For models:	NGC, NGO		



1

GEV No.	365075	Ref. No.	100545
description	line filter 36A		
For models:	NGC		



1

GEV No.	365104	Ref. No.	100546
description	line filter 440V 50/60Hz 50A		
For models:	i3, i5		



1

GEV No.	365069	Ref. No.	100539
description	line filter 6A capacity 0.055µF		
For models:	HHB, HHB2, HHC2020		

HV capacitors



1

GEV No.	365091 ¹	Ref. No.	100232
description	HV capacitor for microwave 0.91 / 0.19µF type N64H2511G24A4 2500V 50/60Hz double connection male faston 6.3mm L 109mm H 46.5mm W 71mm dependent on equipment aluminium Qty 1 pcs		
For models:	i3, i5, NGO		

¹incl. mounting clip



1

GEV No.	365068	Ref. No.	100201 NGC-3020
description	HV capacitor for microwave 0.91µF type N42H2591G21A4 2500V 50/60Hz triple connection male faston 6.3mm aluminium Qty 1 pcs		
For models:	NGC		



1

GEV No.	365072 ¹	Ref. No.	100200 100205 100206 TC3-3220
description	HV capacitor for microwave 1.05 / 0.15µF type HCH-250515P 2500V 50/60Hz double connection male faston 6.3mm L 108mm H 46mm W 70mm retainer set aluminium Qty 1 pcs		
For models:	C3, C3AB, C3C, C3C-MULTI, C3D, C3-MULTI		

spare parts for 365072

GEV No.	365070	Ref. No.	TC3-3219
description	HV capacitor for microwave 1.05 / 0.15µF type HCH-250515P 2500V 50/60Hz double connection male faston dependent on equipment aluminium Qty 1 pcs		

¹incl. mounting clip



1

GEV No.	365070	Ref. No.	TC3-3219
description	HV capacitor for microwave 1.05 / 0.15µF type HCH-250515P 2500V 50/60Hz double connection male faston dependent on equipment aluminium Qty 1 pcs		
For models:	C3		



			
1			
GEV No.	365074	Ref. No.	100204 NGC-3020-2
description	HV capacitor for microwave 1.15µF type HCH-252115B 2500V 50/60Hz triple connection male faston 6.3mm dependent on equipment aluminium Qty 1 pcs		
For models:	NGC		

			
1			
GEV No.	365073 ¹	Ref. No.	N42H2511G22A4 NGC-3020-2
description	HV capacitor for microwave 1.15µF type N42H2511G22A4 2500V 50/60Hz triple connection male faston 6.3mm L 107mm H 40mm W 66mm retainer set aluminium Qty 1 pcs		

¹incl. mounting clip

fuses

fine fuses

			
1			
GEV No.	358836	Ref. No.	100592 100596
description	fine fuse size ø10.4x35(38)mm 12A fast-acting rated 600V type ATMR/KTK-R Qty 1 pcs		
For models:	C3, C3AB, C3C, C3C-MULTI, C3D, C3-MULTI, HHB, HHB2, i3, i5, NGC, NGO		





			
1			
GEV No.	358837	Ref. No.	100599
description	fine fuse size ø10.4x35(38)mm 20A fast-acting rated 600V type ATMR/KTK-R Qty 1 pcs		
For models:	HHC2020, HHC3240, i3, NGC, NGO		

			
1			
GEV No.	358838	Ref. No.	100597
description	fine fuse size ø10.4x35(38)mm 25A fast-acting rated 600V type ATMR/KTK-R Qty 1 pcs		
For models:	C3, C3C		

various

			
1			
GEV No.	358009	Ref. No.	100593
description	fuse size 10.3x38mm 12A rated 600V Qty 1 pcs		
For models:	C3D, i5		

fine fuse holders

			
1			
GEV No.	358835	Ref. No.	100586
description	fuse holder suitable fuse ø6.3x32mm ø 14.5mm 30A rated 600V connection F6.3 max. 30A		
For models:	C3D, HHB, NGC		
accessories for	358835		
	GEV No.	Ref. No.	100592 100596
	 fine fuse size ø10.4x35(38)mm 12A fast-acting rated 600V type ATMR/KTK-R Qty 1 pcs		
	GEV No.	Ref. No.	100599
	 fine fuse size ø10.4x35(38)mm 20A fast-acting rated 600V type ATMR/KTK-R Qty 1 pcs		
	GEV No.	Ref. No.	100597
	 fine fuse size ø10.4x35(38)mm 25A fast-acting rated 600V type ATMR/KTK-R Qty 1 pcs		

			
1			
GEV No.	550983	Ref. No.	100590 T0703
description	fuse holder suitable fuse ø10x38mm 1-pole 30A rated 600V L 78mm W 18mm H 59mm		
For models:	C3		

line circuit breakers

miscellaneous

			
1			
GEV No.	358236	Ref. No.	103170
description	line circuit breaker 2-pole drop-away current 15A		
For models:	C3, C3C-MULTI, C3-MULTI		



			
1			
GEV No.	358235	Ref. No.	103177 T0322
description	line circuit breaker 3-pole drop-away current 35A		
For models:	C3, C3AB, C3C		

<p>connection cables</p> 			
1			
GEV No.	401980	Ref. No.	100186
description	connecting cable for Magnetron		
For models:	C3D, i3, NGC		

electric accessories

cables

power supply cables

			
1			
GEV No.	550978	Ref. No.	100194
description	connecting cable CEE 4-pole 1.9m with plug plug type 30A		
For models:	NGC		

			
1			
GEV No.	401681	Ref. No.	100182
description	connection cable L 150mm 4-pole		
For models:	HHC2020, i3, i5, NGC, NGO		

			
1			
GEV No.	550979	Ref. No.	HHB-8195-3
description	connecting cable CEE 5-pole 1.9m with plug 16A		
For models:	HHB, HHB2		

			
1			
GEV No.	401682	Ref. No.	103023
description	connection cable L 360mm 4-pole		
For models:	HHB, HHC3240		

ribbon cables

group 1

			
1			
GEV No.	401680	Ref. No.	100184 NGC-1530
description	ribbon cable 26-pole L 290mm plug type FC-26P raster size 2.54mm		
For models:	HHC2020, HHC3240, NGC		

terminals

rail-mounted terminals

WIELAND

rail-mounted terminals type 9700A

			
1			
GEV No.	550381	Ref. No.	102046 T0704
description	rail-mounted terminal WIELAND type 9700A/8 S35 1.0-10mm ² top-hat rail 35mm grey W 8mm L 46.6mm		
For models:	C3		

miscellaneous

			
1			
GEV No.	102444	Ref. No.	103575 HHC-6582-5
description	cable for flame monitoring		
For models:	HHC3240		



electronic components

chip cards

chip cards



1			
GEV No.	402054	Ref. No.	NGC-1181-21
description	chip card menu suitable for DUNKIN DONUTS edition 30.03.07		



1			
GEV No.	401982	Ref. No.	100508
description	chip card Smart Card Blank		
For models:	NGC		



1			
GEV No.	401981	Ref. No.	NGC-1181-116 NGC-1181-2(D)
description	chip card Smart Card Subway Menü General		



1			
GEV No.	401705	Ref. No.	i5-3206
description	service kit Firmware Upgrade		

chip-card readers



1			
GEV No.	401992	Ref. No.	100506
description	chip card reader		
For models:	C3D, HHB, HHB2, HHC2020, HHC3240, NGC, NGO		

inverter



1			
GEV No.	402176	Ref. No.	HHC-3012-2 HHC-6630-2
description	inverter for oven 220/240V 50/60Hz 4.3A 0-240V 0-1500Hz		
For models:	HHC2020, HHC3240		

software

service sets



1			
GEV No.	401705	Ref. No.	i5-3206
description	service kit Firmware Upgrade		



1			
GEV No.	401975	Ref. No.	NGC-3027-4 NGC-3030-1 NGC-3030-4
description	service kit suitable for Turbochef standard with software countries (Europe, Asia, Pacific MPH) for fan		
For models:	NGC		
accessories for	401975		



	GEV No.	401999	Ref. No.	NGC-1099-17 NGC-3027-1
	EPROM suitable for DUNKIN DONUTS CODE 39F9B5 15.03.07			



1			
GEV No.	401976	Ref. No.	NGC-3030-6
description	service kit suitable for Turbochef SWY with software countries (Europe, Asia, Pacific MPH) for fan		
For models:	NGC		



1			
GEV No.	401977	Ref. No.	NGC-3030-9
description	service kit suitable for Turbochef SWY with software countries (Europe, Asia, Pacific MPH) for fan		
For models:	NGC		
spare parts for	401977		



	GEV No.	401978	Ref. No.	NGC-1099-9
	EPROM SUBWAY suitable for TURBOCHEF NGC CODE 3C0173			

miscellaneous



1			
GEV No.	401696	Ref. No.	Servicekit komplett
description	service kit complete suitable for Turbochef		





voltage sensors

			
1			
GEV No.	401994	Ref. No.	100783
description	voltage sensor		
For models:	HHB, HHB2, HHC2020, i3, i5, NGC, NGO		

for microwaves

electric

microswitches

			
1			
GEV No.	691439	Ref. No.	NGC-1075 NGC-3033
description	microswitch replace set		
For models:	NGC		
spare parts for	691439		
	GEV No.	691401	Ref. No. NGC-1087
	torsion spring door catch		
	GEV No.	691421	Ref. No. NGC-1075 NGC-3033
	microswitch kit suitable for TURBOCHEF NGC		
accessories for	691439		
	GEV No.	890245	Ref. No. 100639 NGC-3006
	silicone grease Turbochef syringe 20ml		

miscellaneous

service kits

			
1	Image not available		
GEV No.	401696	Ref. No.	Servicekit komplett
description	service kit complete suitable for Turbochef		

ignition parts

ignition cables

pre-assembled cables

			
1			
GEV No.	102443	Ref. No.	103574 HHC-6582-3
description	ignition cable cable length 370mm connection F6.3mm / ø6.5mm Qty 1m ED ø 7mm insulation silicone		
For models:	HHC3240		



			
1			
GEV No.	691588	Ref. No.	TC3-0224
description	filter L 235mm W 180mm TURBOCHEF C3		
For models:	C3AB, C3C, C3C-MULTI, C3-MULTI		

equipment-specific units

for convection ovens/combi-steamers

housing and bezels

			
1			
GEV No.	692165	Ref. No.	NGC-1312
description	PTFE foil for oven L 360mm W 320mm		

 housings			
 inner parts			
			
1			
GEV No.	691443	Ref. No.	NGC-1097 NGC-3004 NGC-3029 NGC-3036
description	cover for waveguide suitable for TURBOCHEF NGC with sealant		
For models:	NGC		
accessories for	691443		
	GEV No.	890243	Ref. No. 102563 102567
	high temperature silicone PERMATHEX HIGH-TEMP RED RTV SILICONE 85g t.max. 343°C tube		



housing and bezels

			
1			
GEV No.	691460	Ref. No.	NGC-1071 NGC-1071-2
description	front panel mounting pos. lower TURBOCHEF NGC		
For models:	NGC		

			
1			
GEV No.	691383	Ref. No.	100690 NGC-1163
description	insulation suitable for Turbochef		
For models:	C3D, i3, NGC		

ceramic plates

			
1			
GEV No.	691469	Ref. No.	700-0302 TC3-3215
description	ceramic plate ø 255mm		
For models:	C3AB, C3C, C3C-MULTI, C3-MULTI		

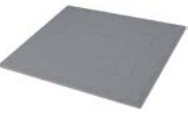
			
1			
GEV No.	691409	Ref. No.	NGC-3038
description	ceramic plate smooth L 377mm W 328mm H 10mm		
For models:	NGC		

miscellaneous

			
1			
GEV No.	691594	Ref. No.	101191
description	blank		
For models:	HHB, HHB2, NGC		

			
1			
GEV No.	691456	Ref. No.	NGC-1380
description	PTFE basket L 345mm W 345mm H 26mm		

			
1			
GEV No.	691592	Ref. No.	100011
description	PTFE basket W 370mm H 345mm bottom part perforated thickness 26mm		

doors

door hinges

			
1			
GEV No.	691440	Ref. No.	102805
description	door hinge mounting pos. left suitable for Turbochef NGC, SAGE 2, SUBWAY		
For models:	HHB2, NGC		

			
1			
GEV No.	691512	Ref. No.	102804
description	door hinge mounting pos. right suitable for Turbochef NGC, SAGE 2, SUBWAY		
For models:	HHB2, NGC		

door bumpers



1	GEV No.	691418	Ref. No.	TC3-0250
	description	door bumper kit suitable for TURBOCHEF C3		
	For models:	C3		

for ovens

housing and bezels



1	GEV No.	691462	Ref. No.	NGC-1431
	description	warning sticker „DO NOT LIFT OVEN BY DOOR HANDLE“ yellow TURBOCHEF NGC		

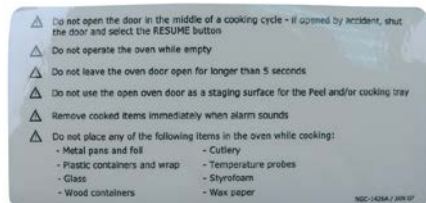

1	GEV No.	691463	Ref. No.	NGC-1426
	description	warning sticker white TURBOCHEF NGC		

miscellaneous



1	GEV No.	691464	Ref. No.	NGC-1362
	description	cleaning instruction TURBOCHEF NGC		

for pizza ovens

spare parts and accessories

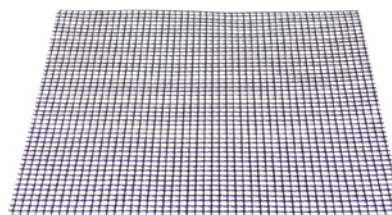

1	GEV No.	692429	Ref. No.	100014
	description	PTFE grid L 310mm W 310mm		



1	GEV No.	691410	Ref. No.	700-0673
	description	scoop wood		



handles and hand wheels

bracket handles



1

GEV No.	691430	Ref. No.	102750
description	pull handle L 327mm H 22mm mounting distance 305mm		
For models:	NGC		



1

GEV No.	691593	Ref. No.	T0267
description	pull handle L 327mm H 22mm mounting distance 305mm		
For models:	C3, C3AB, C3D, C3-MULTI		

hinges

oven hinges



1

GEV No.	691440	Ref. No.	102805
description	door hinge mounting pos. left suitable for Turbochef NGC, SAGE 2, SUBWAY		
For models:	HHB2, NGC		



1

GEV No.	691512	Ref. No.	102804
description	door hinge mounting pos. right suitable for Turbochef NGC, SAGE 2, SUBWAY		
For models:	HHB2, NGC		



1

GEV No.	700747	Ref. No.	HHB-8084
description	opposite support mounting distance 107mm L 125mm W 19mm for hinge suitable for TURBOCHEF HHB		
For models:	HHB		



1

GEV No.	700849	Ref. No.	102807 TUR-102807
description	oven hinge mounting distance 90mm lever length 39mm groove distance 11mm spring thickness 2.6mm spring length 62mm L 155mm W 22mm left/right TURBOCHEF HHB		
For models:	HHB		

door bearing







1

GEV No.	691402	Ref. No.	NGC-1076 NGC-1076-2
description	door hinge		
For models:	NGC, NGO		



1

GEV No.	700743	Ref. No.	TC3-0360 TC3-3224-1 TC3-3224-2	
description	door hinge mounting pos. left suitable for TURBOCHEF C3			
spare parts for	700743			
	GEV No.	691425	Ref. No.	C0504 T0504
	PTFE ring ø 8mm suitable for TURBOCHEF C3			
	GEV No.	700744	Ref. No.	C0508-1 C0508-2 T0508
	bearing mounting pos. left for door hinge suitable for TURBOCHEF C3			

			
1			
GEV No.	700745	Ref. No.	TC3-0360 TC3-3224-1 TC3-3224-2
description	door hinge mounting pos. right suitable for TURBOCHEF C3		
For models:	C3, C3D		
spare parts for	700745		
	GEV No.	691425	Ref. No.
			C0504 T0504
	PTFE ring ø8mm suitable for TURBOCHEF C3		
	GEV No.	700746	Ref. No.
			C0508-1 C0508-2 T0508
	bearing mounting pos. right for door hinge suitable for TURBOCHEF C3		

miscellaneous

			
1			
GEV No.	691194	Ref. No.	NGC-1061
description	hinge block		
For models:	NGC, NGO		

accessories

bearings



			
1			
GEV No.	700744	Ref. No.	C0508-1 C0508-2 T0508
description	bearing mounting pos. left for door hinge suitable for TURBOCHEF C3		

			
1			
GEV No.	700746	Ref. No.	C0508-1 C0508-2 T0508
description	bearing mounting pos. right for door hinge suitable for TURBOCHEF C3		
For models:	C3, C3AB, C3D, C3-MULTI		

filters

device filters

			
1			
GEV No.	691412	Ref. No.	C0185 T0185
description	filter L 177mm W 240mm H 38mm for microwave SS		
For models:	C3, C3AB, C3C, C3C-MULTI, C3D, C3-MULTI		

			
1			
GEV No.	691428	Ref. No.	HHB-8114
description	filter L 205mm W 128mm H 3mm aluminium for microwave thickness 3mm		
For models:	HHB		
accessories for	691428		
	GEV No.	691429	Ref. No.
			HHB-8115
	spring for filter suitable for TURBOCHEF HHB		

catalysers

for microwaves

			
1			
GEV No.	691442	Ref. No.	NGC-3065
description	catalyser service kit suitable for TURBOCHEF NGC		
For models:	NGC		

			
1			
GEV No.	691468	Ref. No.	NGC-1012
description	catalyser TURBOCHEF NGC		
For models:	NGC		



accessories

fastening material

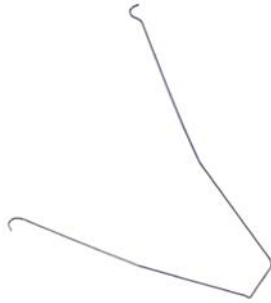

1

GEV No.	691429	Ref. No.	HHB-8115
description	spring for filter suitable for TURBOCHEF HHB		
For models:	HHB		

equipment feet and end caps

equipment feet

with screw mounting



1

GEV No.	691381	Ref. No.	100781
description	equipment foot tube ø 30mm thread 3/8" NPT thread L 11mm H 102-140mm chrome-plated steel size 1 1/4" Qty 1 pcs		
For models:	C3, NGC, NGO		

shelves and shelf rails

grates

universal

without upstand



1

GEV No.	970625	Ref. No.	NGC-1064-1
description	grate W 360mm D 395mm stainless steel suitable for refrigerator		
For models:	NGC		

producer-specific

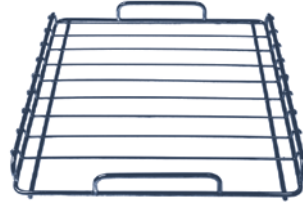

1

GEV No.	691458	Ref. No.	NGC-3064
description	grate W 395mm D 365mm H 45mm suitable for refrigerator for bottom heaters DUNKIN DONUTS		
For models:	NGC		

shelf rails and supports

producer-specific



1

GEV No.	691417	Ref. No.	HHB-3210
description	guide U-shape L 465mm mounting pos. left/right		
For models:	HHB, HHB2		

gaskets

gaskets for heated units

door seals



1

GEV No.	691434	Ref. No.	HHB-8101
description	door seal profile 2951 W 243mm L 490mm external size Qty 1 suitable for Turbochef 12 holes		
For models:	HHB		

sealing washers

PTFE gaskets



1

GEV No.	691377	Ref. No.	700-1333
description	flat gasket PTFE ED ø 235mm ID ø 230mm thickness 4mm Qty 1 pcs suitable for Turbochef		
For models:	C3, C3AB, C3C, C3C-MULTI, C3D, C3-MULTI		



special gaskets

for microwaves



GEV No.	900796	Ref. No.	T0325 TC3-3227
description	gasket L 1100mm silicone		
For models:	C3, C3AB, C3D, C3-MULTI		



GEV No.	691384	Ref. No.	NGC-3014
description	gasket L 175mm copper fabric for Magnetron		
For models:	NGC		



GEV No.	691385	Ref. No.	102021
description	gasket L 315mm copper fabric for microwave		
For models:	NGC		

transmission technology and ball bearings

ball bearings

ball bearings inch



GEV No.	691423	Ref. No.	T0541
description	ball bearing type CYR3/4S shaft \varnothing 1/4"mm ED \varnothing 3/4"mm W 1/2"mm		
For models:	C3, C3AB, C3D, C3-MULTI		

drive belts

toothed belts



GEV No.	691427	Ref. No.	T0284
description	toothed belt profile MXL L 320mm H 1mm teeth 165 splitting 1-1 PVC CODE 6G16 W 3mm suitable for TURBOCHEF C3		
For models:	C3, C3AB, C3C, C3C-MULTI, C3D, C3-MULTI		

springs

torsion springs



GEV No.	691401	Ref. No.	NGC-1087
description	torsion spring door catch		
For models:	NGC		

tension springs



GEV No.	700749	Ref. No.	C0542 T0542
description	tension spring \varnothing 19mm total length 220mm wire gauge \varnothing 2mm		
For models:	C3, C3AB, C3C, C3C-MULTI, C3D, C3-MULTI		



GEV No.	700748	Ref. No.	C0708 T0708
description	tension spring \varnothing 8.5mm total length 95mm wire gauge \varnothing 1mm		
For models:	C3, C3C, C3C-MULTI, C3D		

tools

hand tools

screwdrivers

bits



GEV No.	801637 ¹	Ref. No.	102755
description	torx bit standard with bore size T15H L 25mm		
For models:	C3, C3D, NGC		

¹with bore



GEV No.	801638 ¹	Ref. No.	102767
description	torx bit standard with bore size T20H L 25mm		
For models:	HHC3240		

¹with bore



			
1			
GEV No.	801864	Ref. No.	102746
description	bit insert for safety screws size 4.0mm L 25mm		
For models:	C3		

measuring equipment

meters

pressure measurement

digital manometers

absolute-pressure measurement

			
1			
GEV No.	541583	Ref. No.	HHC-3001
description	pressure meter 0.05-50mbar type 476A pressure measurement probe type absolute pressure sensor measurement unit mbar/psi/in.Hg/kPa/w.c./mmHg connections 1 On/Off/Zero resolution 0.01mbar hose ø 6/8mm accuracy (temperatur) ±0.05%FS accuracy (hysteresis) ±0.1%FS overload max. 0.34 bar interface sensor piezoresistant gauge pressure sensor, int. dimensions 150x72x23mm incl. bag		
For models:	HHC3240		

fastening material

screws

sheet metal screws

			
1			
GEV No.	560108	Ref. No.	101688
description	sheet metal screws ø 4.2mm L 13mm SS Qty 20 pcs DIN 7981/ISO 7049 head ø 8.2mm oval head		
For models:	HHB, HHB2, NGC		

			
1			
GEV No.	560348	Ref. No.	102752
description	sheet-metal screw ø 4.2mm L 13mm SS Qty 1 pcs 14585 intake safety torx head ø 7.8mm		
For models:	i3, i5, NGC		

countersunk screws

			
1			
GEV No.	691393	Ref. No.	102809
description	countersunk screw thread 8/32" UNC L 9.3mm SS Qty 1 pcs intake Phillips ø 7.5mm		
For models:	HHB, NGC		

oval head screws

			
1			
GEV No.	691467	Ref. No.	102748
description	oval head screw thread 8/32" UNC L 9.3mm SS intake safety torx Qty 1 pcs		
For models:	C3, C3D, NGC		

hexagonal screws

			
1			
GEV No.	691404	Ref. No.	101381
description	hexagonal screw thread 10/32" UNF thread L 12mm SS WS 8 Qty 1 pcs		
For models:	NGC		

knurled screws

			
1			
GEV No.	505255	Ref. No.	101752
description	screw thread 1/4" thread L 13mm ø 15mm H 22.5mm SS		
For models:	HHC2020, HHC3240		

nuts

hexagonal nuts

hexagonal nuts inch thread

			
1			
GEV No.	691394	Ref. No.	102962
description	nut thread 8/32" UNC H 4mm SS WS 9 Qty 1 pcs with tooth lock washer		
For models:	NGC		

washers

spring rings



1

GEV No.	691309	Ref. No.	102350
description	lock washer ID ø 5mm ED ø 8.3mm stainless steel Qty 1 pcs		
For models:	HHB, HHB2, NGC		

washers

miscellaneous



1

GEV No.	691294	Ref. No.	102140
description	flat washer ID ø 5.3mm ED ø 11mm thickness 0.8mm SS Qty 1 pcs for thread M5		
For models:	NGC		

fasteners

mounting clips



1

GEV No.	691449	Ref. No.	T0337
description	mounting clip nominal-ø 4mm L 25mm W 11mm mounting distance 18mm		
For models:	C3, C3D, NGC		

retaining rings

DIN 471



1

GEV No.	691403	Ref. No.	101312
description	retaining ring shaft ø 19mm thickness 1.2mm stainless steel DIN 471		
For models:	NGC		

DIN 6799



1

GEV No.	516198	Ref. No.	101297
description	retaining ring E D1 ø 6mm D2 ø 12mm SS DIN 6799 thickness 0.7mm for shaft ø 7-9mm		
For models:	HHB		

consumables

sealants and adhesives

high temperature silicone



1

GEV No.	890243	Ref. No.	102563 102567
description	high temperature silicone PERMATEX HIGH-TEMP RED RTV SILICONE 85g t.max. 343°C tube		
description	PERMATEX RTV RED SILICONE - tube 85g - red Formulated for hi-temp applications, or heavy-duty use. Replaces almost any cut gasket by making reliable „formed-in-place“ gaskets that resist cracking, shrinking and migrating caused by thermal cycling. Temperature range: -65°F to 650°F (-54°C bis +343°C)		
For models:	i3, i5, NGC		

adhesive tapes



1

GEV No.	691405	Ref. No.	102698 Roll 102698 Rolle
description	adhesive tape aluminium ventilation systems W 73mm		
description	Aluminium shielding tape: 73mm wide, 45m long 40µm aluminium foil, coated with electrically conductive adhesive. The tape has a siliconised paper backing. - Conductive acrylic adhesive - Good shielding properties and z-axis conductivity - Good resistance to high and low temperatures (-20°C to +155°C) - Good resistance to chemical materials, heat, acids and alkali salts - Easy to roll out		

lubricants

silicone fats



1

GEV No.	890245	Ref. No.	100639 NGC-3006
description	silicone grease Turbochef syringe 20ml		
description	TurboChef silicone grease - syringe 20ml Silicone grease for lubricating door switch springs etc.		
For models:	NGC		



cleaning agents

various cleaners



1			
GEV No.	801172	Ref. No.	103180 103180 CS
description	detergent 1l TURBOCHEF Oven Cleaner		

fuses

fine fuses

ø10.4x35/38mm 600V (USA)



1			
GEV No.	358836	Ref. No.	100592 100596
description	fine fuse size ø10.4x35(38)mm 12A fast-acting rated 600V type ATMR/KTK-R Qty 1 pcs		
For models:	C3, C3AB, C3C, C3C-MULTI, C3D, C3-MULTI, HHB, HHB2, i3, i5, NGC, NGO		



1			
GEV No.	358837	Ref. No.	100599
description	fine fuse size ø10.4x35(38)mm 20A fast-acting rated 600V type ATMR/KTK-R Qty 1 pcs		
For models:	HHC2020, HHC3240, i3, NGC, NGO		

1			
GEV No.	358838	Ref. No.	100597
description	fine fuse size ø10.4x35(38)mm 25A fast-acting rated 600V type ATMR/KTK-R Qty 1 pcs		
For models:	C3, C3C		

1			
GEV No.	358009	Ref. No.	100593
description	fuse size 10.3x38mm 12A rated 600V Qty 1 pcs		
For models:	C3D, i5		

fine fuse holders



1			
GEV No.	550829	Ref. No.	103548
description	fuse holder 30A rated 800V L 77mm W 41mm H 33mm connection F6.3x0.8		
For models:	HHB2, HHC2020, HHC3240, i3, i5		

A		K	
adhesive tapes	30	knurled screws	29
alarm devices	5	L	
axial fans	13	lubricants	30
B		M	
bi-metal thermostats	4, 4	magnetic switches	5
bits	28	magnetrons	7
C		measuring equipment	29
cables	20	meters	29
cleaning agents	31	microswitches	4
condensators & interference suppression filters	18	motors	17
connection cables	20	mounting clips	30
consumables	30	N	
countersunk screws	29	nuts	29
D		O	
door seals	27	oval head screws	29
E		oven hinges	25
electric accessories	20	P	
F		power supply cables	20
fans	13	pressure measurement	29
fasteners	30	probes	8
fastening material	29	R	
filters	18	radial fans	17
fine fuses	31	relays	6
fuses	19, 31	retaining rings	30
G		ribbon cables	20
gaskets for heated units	27	S	
grates	27	safety thermostats	4
H		screwdrivers	28
hand tools	28	screws	29
heaters	3	sealants and adhesives	30
heating elements	3	sealing washers	27
heating elements for convection	3	sheet metal screws	29
heating elements for microwaves	3	shelves and shelf rails	27
hexagonal nuts	29	silicone	30
hexagonal screws	29	silicone fats	30
high temperature silicone	30	solid state relays	5
hot air fans	15	spring rings	30
hot air motors	14	switches and momentary switches	4
HV capacitors	18	T	
I		terminals	20
ignition cables	22	thermostats	4
		tools	28
		transformers	7

W

washers

30