



GAS COMPONENTS



ELECTRIC COMPONENTS



WATER TECHNOLOGY



MECHANICAL COMPONENTS



TOOLS

Spare parts suitable for

UNIVER-BAR

Find the complete and up-to-date range of products in our GEV Webshop



Manufacturer catalogue

The most important spare parts and accessories arranged clearly for every manufacturer

- ✓ Complete product range and all appliance data always up to date in the GEV Webshop
- ✓ Alphabetical Index at the end of the catalogue

GEV Webshop

www.gev-online.co.uk

www.gev-online.com



- 🔍 Add to Favourites
- 🔍 Sign In with email address and usual password
- 🔍 Easy-order – place several items in your basket at the same time
- 🔍 Quick Item search – no login needed





heating elements

immersion heating elements

3 hole flange ø47.5mm



GEV No.	416318	Ref. No.	3010
description	heating element 3000W 230V mounting ø 47.5mm heating circuits 3 L 265mm W 32mm H 33mm number of thermostat sleeves 1 thermostat sleeves ø 6.5mm length thermostat sleeves 235mm thermostat sleeve eccentric, non clinging tube ø 6.5mm connection M4		
accessories for	416318		
	GEV No.	510408	Ref. No. 4011
	O-ring EPDM thickness 5.34mm ID ø 47mm Qty 1 pcs		
	GEV No.	510562	Ref. No. —
	O-ring silicone thickness 5.34mm ID ø 47mm Qty 1 pcs		



GEV No.	416329	Ref. No.	3371
description	heating element 4500W 230V mounting ø 47.5mm heating circuits 3 L 370mm W 33mm H 37mm number of thermostat sleeves 1 thermostat sleeves ø 7mm length thermostat sleeves 235mm thermostat sleeve eccentric, non clinging tube ø 6.5mm connection M4 3 hole flange		
spare parts for	416329		
	GEV No.	510408	Ref. No. 4011
	O-ring EPDM thickness 5.34mm ID ø 47mm Qty 1 pcs		

with compression flange 62 x 26mm







GEV No.	415266	Ref. No.	2011
description	heating element 2000W 230V heating circuits 1 compression flange flange 62x26mm L 300mm W 41mm Hmm connection male faston 6.3mm tube ø 6.3mm immersion heater		



GEV No.	416307	Ref. No.	1532
description	heating element 2000W 230V heating circuits 1 flange 62x26mm L 270mm W 42mm H 27mm tube ø 6mm connection male faston 6.3mm		

with round flange ø47.5mm



GEV No.	416306	Ref. No.	2010
description	heating element 2000W 220V heating circuits 1 mounting ø 47.5mm L 270mm W 38mm H 22mm connection M4 tube ø 6mm thermostat sleeves ø 7.5mm number of thermostat sleeves 1 length thermostat sleeves 200mm thermostat sleeve eccentric, non clinging		
accessories for	416306		
	GEV No.	510408	Ref. No. 4011
	O-ring EPDM thickness 5.34mm ID ø 47mm Qty 1 pcs		
	GEV No.	510562	Ref. No. —
	O-ring silicone thickness 5.34mm ID ø 47mm Qty 1 pcs		
	GEV No.	520235	Ref. No. —
	3 hole flange hole distance 70.5mm perforation ø 6.5mm ID ø 53.5mm		
	GEV No.	520236	Ref. No. —
	flange for heating element ID ø 50mm ED ø 90mm hole ø 6.5mm 3 holes		
	GEV No.	550002	Ref. No. 3136
	tension strap H 10mm L 21mm W 10mm hole ø 6.5mm for heating element		
	GEV No.	550362	Ref. No. —
	blind flange ø 64mm mounting ø 47.5mm		















GEV No.	416319	Ref. No.	4599
description	heating element 2000W 230V heating circuits 1 mounting ø 47.5mm L 275mm W 39mm H 35mm connection M4 H1 21mm H2 14mm		
spare parts for	416319		
	GEV No.	510408	Ref. No. 4011
	O-ring EPDM thickness 5.34mm ID ø 47mm Qty 1 pcs		
accessories for	416319		
	GEV No.	510562	Ref. No. —
	O-ring silicone thickness 5.34mm ID ø 47mm Qty 1 pcs		
	GEV No.	520235	Ref. No. —
	3 hole flange hole distance 70.5mm perforation ø 6.5mm ID ø 53.5mm		
	GEV No.	520236	Ref. No. —
	flange for heating element ID ø 50mm ED ø 90mm hole ø 6.5mm 3 holes		







Table continues overleaf

1 electric components



accessories for	416319		
	GEV No.	550002	Ref. No. 3136
	tension strap H 10mm L 21mm W 10mm hole ø 6.5mm for heating element		
	GEV No.	550362	Ref. No. —
	blind flange ø 64mm mounting ø 47.5mm		

1			
GEV No.	416327	Ref. No.	4552
description	heating element 3000W 230V heating circuits 3 mounting ø 47.5mm L 280mm W 28mm H 60mm connection M4 tube ø 6.25mm H1 24mm H2 36mm		
accessories for	416327		
	GEV No.	510408	Ref. No. 4011
	O-ring EPDM thickness 5.34mm ID ø 47mm Qty 1 pcs		
	GEV No.	510562	Ref. No. —
	O-ring silicone thickness 5.34mm ID ø 47mm Qty 1 pcs		
	GEV No.	520235	Ref. No. —
	3 hole flange hole distance 70.5mm perforation ø 6.5mm ID ø 53.5mm		
	GEV No.	520236	Ref. No. —
	flange for heating element ID ø 50mm ED ø 90mm hole ø 6.5mm 3 holes		
	GEV No.	550002	Ref. No. 3136
	tension strap H 10mm L 21mm W 10mm hole ø 6.5mm for heating element		
	GEV No.	550362	Ref. No. —
	blind flange ø 64mm mounting ø 47.5mm		

1			
GEV No.	416317	Ref. No.	4551
description	heating element 6000W 230V heating circuits 3 mounting ø 47.5mm L 400mm W 36mm H 36mm connection M4 tube ø 6.2mm thermostat sleeves ø 7mm number of thermostat sleeves 1 length thermostat sleeves 235mm thermostat sleeve eccentric, non clinging		
spare parts for	416317		
	GEV No.	510408	Ref. No. 4011
	O-ring EPDM thickness 5.34mm ID ø 47mm Qty 1 pcs		
accessories for	416317		
	GEV No.	510562	Ref. No. —
	O-ring silicone thickness 5.34mm ID ø 47mm Qty 1 pcs		
	GEV No.	520235	Ref. No. —
	3 hole flange hole distance 70.5mm perforation ø 6.5mm ID ø 53.5mm		
	GEV No.	520236	Ref. No. —
	flange for heating element ID ø 50mm ED ø 90mm hole ø 6.5mm 3 holes		
	GEV No.	550002	Ref. No. 3136
	tension strap H 10mm L 21mm W 10mm hole ø 6.5mm for heating element		
	GEV No.	550362	Ref. No. —
	blind flange ø 64mm mounting ø 47.5mm		

accessories

sealing washers

O-rings

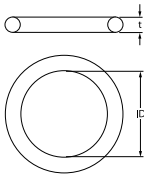
1			
			
GEV No.	510408	Ref. No.	4011
description	O-ring EPDM thickness 5.34mm ID ø 47mm Qty 1 pcs		

flange gaskets

counterflanges

1			
GEV No.	550002	Ref. No.	3136
description	tension strap H 10mm L 21mm W 10mm hole ø 6.5mm for heating element		

1			
GEV No.	550002	Ref. No.	3136
description	tension strap H 10mm L 21mm W 10mm hole ø 6.5mm for heating element		

thermostats

bi-metal thermostats

safety bi-metal thermostats

1			
GEV No.	390455	Ref. No.	4751
description	bi-metal safety thermostat hole distance 40mm switch-off temp. 100°C 2NC 2-pole 16A connection F6.3 2 hole fixing		



control and safety thermostats

IMIT / TEMPOMATIC / ARTERMO

control thermostats

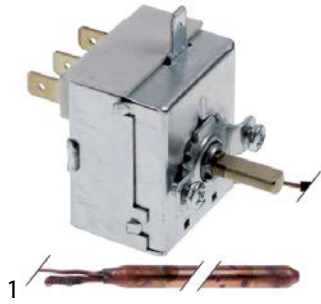

GEV No.	375920	Ref. No.	4044
description	thermostat t.max. 90°C temperature range 0-90°C 1-pole 1CO 16A probe ø 6.5mm probe L 98mm capillary pipe 1030mm capillary pipe isolated 970mm gland nut shaft ø 6x4.6mm shaft L 16mm rotation 270° probe material copper 250V		

accessories

plunger sockets



GEV No.	507462	Ref. No.	1503
description	thermowell thread M10x1 ID ø 7.7mm L 115mm for probe 100mm for probe ø 7mm		

switches and momentary switches

rocker/momentary rocker switches

30x22mm



GEV No.	345317	Ref. No.	1519 1520
description	momentary rocker switch mounting measurements 30x22mm green 2NO 230V 16A illuminated connection male faston 6.3mm ambient temperature max. 125/55°C protection IP65 with rubber collar		



GEV No.	347531	Ref. No.	4069
description	rocker switch mounting measurements 30x22mm green 2NO 250V 20A illuminated 0-I connection male faston 6.3mm ambient temperature max. 125/55°C protection IP65 with rubber collar		



GEV No.	346474	Ref. No.	4671
description	dummy element external size 30x22mm suitable for rocker switch		

blank



GEV No.	345982	Ref. No.	1521
description	rocker switch mounting measurements 30x22mm green 2CO 250V 16A illuminated connection male faston 6.3mm ambient temperature max. 125/55°C protection IP65 with cover cap		

accessories for	345982	GEV No.	301036	Ref. No.	—
	protective cover internal size 30x22mm for rocker switch mounting measurementsmm				

labelled



GEV No.	300125	Ref. No.	4070
description	rocker switch mounting measurements 30x22mm green 2NO 230V 16A 0-I connection male faston 6.3mm ambient temperature max. 125/55°C protection IP65 with cover cap		

accessories for	300125	GEV No.	301036	Ref. No.	—
	protective cover internal size 30x22mm for rocker switch mounting measurementsmm				

microswitches

lever actuated

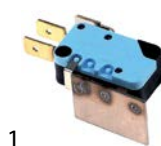

GEV No.	346067	Ref. No.	4074
description	microswitch with lever 250V 16A 1CO connection male faston 6.3mm ambient temperature max. 125°C lever length 30mm		



GEV No.	345257	Ref. No.	4095
description	microswitch with lever 250V 16A 1CO connection male faston 6.3mm L 29mm L1 33mm ambient temperature max. 120°C mounting distance 22mm actuating force: 130g lever length 31.5mm		



1

GEV No.	347607	Ref. No.	4780
description	microswitch with lever 250V 16A 1CO connection male faston 6.3mm L 77mm ambient temperature max. 85°C lever length 48mm		



1

GEV No.	346064	Ref. No.	4762
description	microswitch with lever 250V 16A 3CO connection male faston 6.3mm ambient temperature max. 125°C lever length 75mm		

lamps

indicator lights

indicator lights (complete)

ø 6mm



1

GEV No.	359434	Ref. No.	1513
description	indicator light ø 6mm 230V green		

timers

programme timers



1

GEV No.	360432	Ref. No.	4516
description	timer CDC 7802DV engines 2 chambers 2 operation time 1min / 2min 230V shaft ømm shaft Lmm motor type M37RN/M37LN		



1

GEV No.	360416	Ref. No.	1912 4090
description	timer CROUZET engines 1 chambers 2 operation time 120s 230V shaft ø 6x4.6mm shaft L 20mm manif. no. 627/5280 motor type 82340		



1

GEV No.	360415	Ref. No.	1507
description	timer CROUZET engines 1 chambers 4 operation time 120s 230V shaft ømm shaft Lmm manif. no. 642/5180 motor type 82340		

contactors

ALLEN BRADLEY

power contactors



1

GEV No.	380468	Ref. No.	3045
description	power contactor resistive load 20A 230VAC (AC3/400V) 9A/4kW main contacts 4NO connection screw connection type 100-K09*400		

relays

power relays

with flange mounting



1

GEV No.	380020	Ref. No.	4360
description	power relays FINDER 230VAC 15A 2NO connection male faston 6.3mm manif. no. 62.82.8.230.0300+062.10 2-pole		



with bracket mounting



GEV No.	380815	Ref. No.	4637
description	power relays 230VAC 16A 2NO connection male faston 6.3mm flange dimensions 36x38x68mm		

electronics

PCBs



GEV No.	403894	Ref. No.	3845
description	electronic timer L 125mm W 85mm		



GEV No.	403895	Ref. No.	4851
description	PCB L 135mm W 85mm		



GEV No.	692214	Ref. No.	4850
description	PCB warewashing MID15/COSMO/ERGON L 133mm W 84mm 50/60Hz voltage input 230/240 VacV 230V 17A		

solenoid valves

solenoid valves (water)

TP





GEV No.	370021	Ref. No.	4076
description	solenoid valve double straight 230VAC inlet 3/4" outlet 11.5mm DN10 TP flow regulating valve inlet white		

spare parts for	370021			
	GEV No.	371013	Ref. No.	—
	solenoid coil TP 230VAC 50/60Hz			

accessories for		370021		
	GEV No.	371220	Ref. No.	—
	reducer TP flow rate 3l/min red tolerance ±15%			
	GEV No.	371221	Ref. No.	—
	reducer TP flow rate 5.5l/min yellow tolerance ±15%			
	GEV No.	371222	Ref. No.	—
	reducer TP flow rate 6l/min grey tolerance ±15%			
	GEV No.	371223	Ref. No.	—
	reducer TP flow rate 10l/min white tolerance ±15%			
	GEV No.	371224	Ref. No.	—
	reducer TP flow rate 12l/min bronze tolerance ±15%			
	GEV No.	371225	Ref. No.	—
	reducer TP flow rate 16l/min light brown tolerance ±15%			
	GEV No.	371226	Ref. No.	—
	reducer TP flow rate 20l/min red tolerance ±15%			
	GEV No.	371230	Ref. No.	—
	reducer TP flow rate 0.25l/min red tolerance ±25%			
	GEV No.	371231	Ref. No.	—
	reducer TP flow rate 0.35l/min violet tolerance ±25%			
	GEV No.	371232	Ref. No.	—
	reducer TP flow rate 0.5l/min orange tolerance ±25%			
	GEV No.	371233	Ref. No.	—
	reducer TP flow rate 0.8l/min white tolerance ±25%			
	GEV No.	371234	Ref. No.	—
	reducer TP flow rate 1l/min light blue tolerance ±25%			
	GEV No.	371235	Ref. No.	—
	reducer TP flow rate 1.2l/min brown tolerance ±25%			
	GEV No.	371236	Ref. No.	—
	reducer TP flow rate 1.5l/min light brown tolerance ±25%			
	GEV No.	371237	Ref. No.	—
	reducer TP flow rate 2.5l/min yellow tolerance ±25%			
	GEV No.	371238	Ref. No.	—
	reducer TP flow rate 3.4l/min dark green tolerance ±25%			
	GEV No.	371239	Ref. No.	—
	reducer TP flow rate 5l/min black tolerance ±25%			
	GEV No.	371240	Ref. No.	—
	reducer TP flow rate 8l/min blue tolerance ±20%			

			
			
GEV No.	370017	Ref. No.	4075
description	solenoid valve single straight 230VAC inlet 3/4" outlet 11.5mm DN10 TP p max 10bar		
spare parts for	370017		
	GEV No.	371013	Ref. No. —
solenoid coil TP 230VAC 50/60Hz			
accessories for	370017		
	GEV No.	371220	Ref. No. —
reducer TP flow rate 3l/min red tolerance ±15%			
	GEV No.	371221	Ref. No. —
reducer TP flow rate 5.5l/min yellow tolerance ±15%			
	GEV No.	371222	Ref. No. —
reducer TP flow rate 6l/min grey tolerance ±15%			
	GEV No.	371223	Ref. No. —
reducer TP flow rate 10l/min white tolerance ±15%			
	GEV No.	371224	Ref. No. —
reducer TP flow rate 12l/min bronze tolerance ±15%			
	GEV No.	371225	Ref. No. —
reducer TP flow rate 16l/min light brown tolerance ±15%			
	GEV No.	371226	Ref. No. —
reducer TP flow rate 20l/min red tolerance ±15%			
	GEV No.	371230	Ref. No. —
reducer TP flow rate 0.25l/min red tolerance ±25%			
	GEV No.	371231	Ref. No. —
reducer TP flow rate 0.35l/min violet tolerance ±25%			
	GEV No.	371232	Ref. No. —
reducer TP flow rate 0.5l/min orange tolerance ±25%			
	GEV No.	371233	Ref. No. —
reducer TP flow rate 0.8l/min white tolerance ±25%			
	GEV No.	371234	Ref. No. —
reducer TP flow rate 1l/min light blue tolerance ±25%			
	GEV No.	371235	Ref. No. —
reducer TP flow rate 1.2l/min brown tolerance ±25%			
	GEV No.	371236	Ref. No. —
reducer TP flow rate 1.5l/min light brown tolerance ±25%			
	GEV No.	371237	Ref. No. —
reducer TP flow rate 2.5l/min yellow tolerance ±25%			

accessories for	370017		
	GEV No.	371238	Ref. No. —
reducer TP flow rate 3.4l/min dark green tolerance ±25%			
	GEV No.	371239	Ref. No. —
reducer TP flow rate 5l/min black tolerance ±25%			
	GEV No.	371240	Ref. No. —
reducer TP flow rate 8l/min blue tolerance ±20%			















			
			
GEV No.	370016	Ref. No.	4078
description	solenoid valve single angled 230VAC inlet 3/4" outlet 14mm DN10 TP		
spare parts for	370016		
	GEV No.	371013	Ref. No. —
solenoid coil TP 230VAC 50/60Hz			
accessories for	370016		
	GEV No.	371220	Ref. No. —
reducer TP flow rate 3l/min red tolerance ±15%			
	GEV No.	371221	Ref. No. —
reducer TP flow rate 5.5l/min yellow tolerance ±15%			
	GEV No.	371222	Ref. No. —
reducer TP flow rate 6l/min grey tolerance ±15%			
	GEV No.	371223	Ref. No. —
reducer TP flow rate 10l/min white tolerance ±15%			
	GEV No.	371224	Ref. No. —
reducer TP flow rate 12l/min bronze tolerance ±15%			
	GEV No.	371225	Ref. No. —
reducer TP flow rate 16l/min light brown tolerance ±15%			
	GEV No.	371226	Ref. No. —
reducer TP flow rate 20l/min red tolerance ±15%			
	GEV No.	371230	Ref. No. —
reducer TP flow rate 0.25l/min red tolerance ±25%			
	GEV No.	371231	Ref. No. —
reducer TP flow rate 0.35l/min violet tolerance ±25%			
	GEV No.	371232	Ref. No. —
reducer TP flow rate 0.5l/min orange tolerance ±25%			
	GEV No.	371233	Ref. No. —
reducer TP flow rate 0.8l/min white tolerance ±25%			

Table continues overleaf



accessories for 370016		GEV No.	Ref. No.	
	reducer TP flow rate 1l/min light blue tolerance ±25%	371234		—
	reducer TP flow rate 1.2l/min brown tolerance ±25%	371235		—
	reducer TP flow rate 1.5l/min light brown tolerance ±25%	371236		—
	reducer TP flow rate 2.5l/min yellow tolerance ±25%	371237		—
	reducer TP flow rate 3.4l/min dark green tolerance ±25%	371238		—
	reducer TP flow rate 5l/min black tolerance ±25%	371239		—
	reducer TP flow rate 8l/min blue tolerance ±20%	371240		—
	solenoid valve filter ø 19.5mm H 16mm	503139		—

solenoid valves with reducers

1				
GEV No.	370142	Ref. No.		1542
description	solenoid valve double straight 230VAC inlet 3/4" outlet 11.5mm output B 0.6l/min			

pressure switches

for warewashing

ø 58mm with male faston 6.3mm

with connection horizontal

1				
GEV No.	541140	Ref. No.		4054
description	pressure control pressure range 55/30mbar connection 6mm ø 58mm pressure connection horizontal warewashing			

compressors

SECOP DANFOSS

R404a/R507

LBP monophase

Lower evaporation temperature below -20°C

1				
GEV No.	605056	Ref. No.		T2178GK
description	compressor coolant R404a/R507 type SC18CLX.2 220-240V 50Hz LBP fully hermetic 13.7kg 5/8HP cylinder capacity 17.69cm ³ CSR H 219mm 562W 691W 881W 1095W 1332W 1593W test method ASHRAE			
spare parts for	605056			
	GEV No.	381548	Ref. No.	—
	start relay DANFOSS			

pumps



wash and rinse pumps

FIR

pumps

1				
GEV No.	500457	Ref. No.		3823
description	pump inlet ø 28mm outlet ø 26mm type 2213.1417 230V 50Hz 1 phase 0.15kW 0.2HP L 198mm rotation direction left capacitor 6.3µF FIR			
spare parts for	500457			
	GEV No.	365012	Ref. No.	—
	operating capacitor capacity 6.3µF 450V tolerance 5% 50Hz ambient temperature max. -25 to +85°C ø 30mm L 61mm M8 plastic connection male faston 6.3mm protection			

Table continues overleaf

spare parts for	500457		
	GEV No.	510384	Ref. No. —
	pump cover inlet ø 28mm outlet ø 26mm ø 100mm ID ø 76mm		
	GEV No.	510695	Ref. No. —
	mechanical shaft seal height counter ring 5.5mm ID ø 11mm		
	GEV No.	521703	Ref. No. —
	pump cover gasket EPDM thickness 2.5mm ID ø 75mm Qty 1 pcs		



GEV No.	500683	Ref. No.	4718
description	pump inlet ø 60mm outlet ø 50mm type 2223.U150 230V 50Hz 1 phase 0.89kW 1.2HP L 260mm rotation direction right capacitor 16µF FIR		
spare parts for	500683		
	GEV No.	365021	Ref. No. —
	operating capacitor capacity 16µF 425V tolerance 5% 50/60Hz ambient temperature max. -25 to +85°C ø 35mm L 73mm single M8 plastic connection male faston 6.3mm 416.10.99 protection		
	GEV No.	510552	Ref. No. —
	pump cover gasket pump type 1292-2/3942/3981/3911/3983		
	GEV No.	510600	Ref. No. —
	impeller ø 102mm H 29mm shaft intake ø 9/8mm rotation direction right blades 6		
	GEV No.	510692	Ref. No. —
	mechanical shaft seal for shaft ø 11mm slide ring ext. ø 24mm slide ring H 13mm counter ring mounting ø 26mm height counter ring 8mm counter ring int. ø 14mm		
	GEV No.	521511	Ref. No. —
	pump cover inlet ø 60mm outlet ø 50/30mm supporting pressure M12x1.75 supporting pressure open pump type 2233 turn direction right ø 160mm ID ø 120mm inner height 23mm		

OLYMPIA

pumps



GEV No.	500000	Ref. No.	4112
description	pump inlet ø 29mm outlet ø 28mm type T 4 230V 50Hz 1 phase 0.29kW 0.39HP L 202mm rotation direction left capacitor 8µF OLYMPIA		
spare parts for	500000		
	GEV No.	365013	Ref. No. —
	operating capacitor capacity 8µF 400V tolerance 5%Hz ambient temperature max. -25 to +85°C ø 31.5mm L 55mm M8 plastic connection male faston 6.3mm protection		
	GEV No.	510554	Ref. No. —
	O-ring EPDM thickness 2mm ID ø 120mm Qty 1 pcs		
	GEV No.	510693	Ref. No. —
	mechanical shaft seal for shaft ø 12mm slide ring ext. ø 24mm slide ring H 15.5mm slide ring int. ø 11mm counter ring mounting ø 24mm height counter ring 8mm counter ring int. ø 13.5mm		
	GEV No.	521176	Ref. No. —
	pump cover OLYMPIA inlet ø 1"mm outlet ø 28mm pump type T 4		
	GEV No.	521257	Ref. No. —
	impeller ø 80mm H 12mm rotation direction left thread M10R shaft ø 12mm shaft length 7.5mm blades 6		

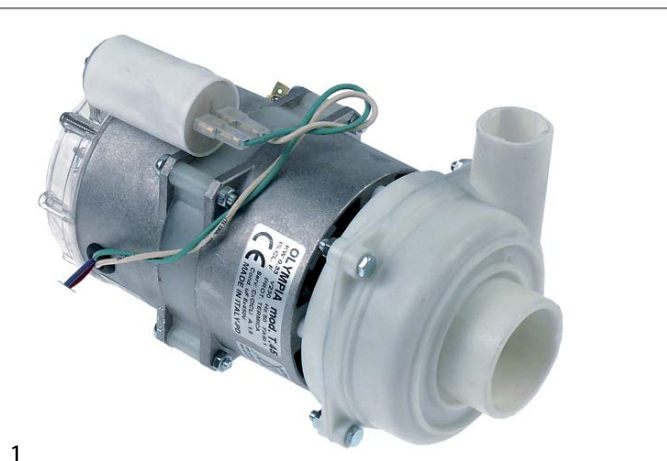









GEV No.	500476	Ref. No.	1808
description	pump inlet ø 50mm outlet ø 30mm type T45 230V 50Hz 1 phase 0.33kW 0.45HP L 215mm rotation direction left capacitor 8µF OLYMPIA		
spare parts for	500476		
	GEV No.	365013	Ref. No. —
	operating capacitor capacity 8µF 400V tolerance 5%Hz ambient temperature max. -25 to +85°C ø 31.5mm L 55mm M8 plastic connection male faston 6.3mm protection		

Table continues overleaf





spare parts for 500476				
	GEV No.	501312	Ref. No.	—
O-ring EPDM thickness 1.78mm ID ø 88.62mm Qty 1 pcs				
	GEV No.	510693	Ref. No.	—
mechanical shaft seal for shaft ø 12mm slide ring ext. ø 24mm slide ring H 15.5mm slide ring int. ø 11mm counter ring mounting ø 24mm height counter ring 8mm counter ring int. ø 13.5mm				
	GEV No.	521258	Ref. No.	—
impellor ø 80mm H 13mm thread M10R shaft ø 12mm shaft length 7.5mm blades 6				



1				
GEV No.	500477	Ref. No.	3730	
description	pump inlet ø 50mm outlet ø 40mm type T5 230V 50Hz 1 phase 0.35kW 0.48HP L 200mm rotation direction right capacitor 10µF OLYMPIA inlet ø 50mm outlet ø 40mm			
spare parts for	500477			
	GEV No.	365015	Ref. No.	—
operating capacitor capacity 10µF 400V tolerance 5%Hz ambient temperature max. -25 to +85°C ø 35.5mm L 59mm M8 plastic connection male faston 6.3mm protection				
	GEV No.	507458	Ref. No.	3731
impellor ø 90mm H 12mm rotation direction right thread M10L blades 8				
	GEV No.	510554	Ref. No.	—
O-ring EPDM thickness 2mm ID ø 120mm Qty 1 pcs				
	GEV No.	510693	Ref. No.	—
mechanical shaft seal for shaft ø 12mm slide ring ext. ø 24mm slide ring H 15.5mm slide ring int. ø 11mm counter ring mounting ø 24mm height counter ring 8mm counter ring int. ø 13.5mm				



1				
GEV No.	500475	Ref. No.	3350	
description	pump inlet ø 50mm outlet ø 48mm type T75 230V 50Hz 1 phase 0.55kW 0.75HP L 237mm rotation direction right capacitor 12.5µF OLYMPIA			
spare parts for	500475			
	GEV No.	365014	Ref. No.	—
operating capacitor capacity 12.5µF 450V tolerance 5%Hz ambient temperature max. -25 to +85°C ø 35mm L 70mm M8 plastic connection male faston 6.3mm 45S.C3D5.12.5 protection				
	GEV No.	510693	Ref. No.	—
mechanical shaft seal for shaft ø 12mm slide ring ext. ø 24mm slide ring H 15.5mm slide ring int. ø 11mm counter ring mounting ø 24mm height counter ring 8mm counter ring int. ø 13.5mm				
	GEV No.	521161	Ref. No.	—
pump cover OLYMPIA inlet ø 50mm outlet ø 48/31mm auxiliary pressure connection 10mm pump type T75				
	GEV No.	521162	Ref. No.	—
impellor ø 106mm H 22mm pump type T75 thread M10L				
	GEV No.	521727	Ref. No.	—
pump cover gasket EPDM thickness 1.78mm ID ø 145mm Qty 1 pcs				

drain pumps

ASKOLL

1				
GEV No.	500054	Ref. No.	3385	
description	drain pump inlet ø 24mm outlet ø 22mm 230V 40W 50Hz ASKOLL type R113			





electric accessories

terminals

connection boxes



1

GEV No.	550300	Ref. No.	4752
description	power terminal block 3-pole contacts P+N+E		

equipment-specific units

for dishwashers

drain and intake components

UNIVERBAR

drain /intake bodies



1

GEV No.	507449	Ref. No.	1536
description	drain fitting thread 1" hose ø 30mm		



1

GEV No.	507460	Ref. No.	4621
description	drain fitting thread 1½" ED ø 78mm ID ø 50mm		

overflow pipes



1

GEV No.	507466	Ref. No.	1534
description	overflow pipe L 107mm ø 28mm		



1

GEV No.	517178	Ref. No.	2112
description	overflow pipe L 121mm ø 28mm		



1

GEV No.	517606	Ref. No.	1201
description	overflow pipe L 149mm ø 51mm		



1

GEV No.	507500	Ref. No.	3266
description	overflow pipe L 88mm ø 28mm		

containers

salt tanks



1

GEV No.	510929	Ref. No.	4333
description	salt tank ø 120mm H 117mm hose ø 10mm mounting ø 70mm overall height 157mm		

spare parts for 510929











	GEV No.	506015	Ref. No.	—
	O-ring EPDM thickness 3.53mm ID ø 39.69mm Qty 1 pcs			
	GEV No.	510018	Ref. No.	—
	nut ø 92mm H 10.5mm for salt tank ID ø 64mm			
	GEV No.	524177	Ref. No.	—
	lid ø 69mm H 20mm for salt tank ID ø 50mm			

Table continues overleaf



accessories for 510929	
	GEV No. 510071 Ref. No. — flat gasket rubber ED ø 81mm ID ø 68mm thickness 3mm for salt tank Qty 1 pcs
	GEV No. 510654 Ref. No. — gasket H 6mm D1 ø 82mm D2 ø 68mm
	GEV No. 510883 Ref. No. — gasket rubber ED ø 86mm ID ø 66mm thickness 2mm for salt tank Qty 1 pcs



GEV No. 504045	Ref. No. 4337
description salt tank ø 123mm H 90mm	
spare parts for 504045	
	GEV No. 510018 Ref. No. — nut ø 92mm H 10.5mm for salt tank ID ø 64mm
	GEV No. 524148 Ref. No. — O-ring EPDM thickness 3.53mm ID ø 40.86mm Qty 1 pcs
	GEV No. 524177 Ref. No. — lid ø 69mm H 20mm for salt tank ID ø 50mm
accessories for 504045	
	GEV No. 510654 Ref. No. — gasket H 6mm D1 ø 82mm D2 ø 68mm
	GEV No. 510883 Ref. No. — gasket rubber ED ø 86mm ID ø 66mm thickness 2mm for salt tank Qty 1 pcs

boilers

boilers for dishwashers

	
1	
GEV No. 507465	Ref. No. 3326
description boiler without heating element ø 150mm L 415mm inlet ø 12mm outlet ø 2x 10mm	



softener cartridges

softening columns

	
1	
GEV No. 530000	Ref. No. 4331
description softener 4-fold L 380mm W 180mm	

air traps

air traps

	
1	
GEV No. 507504	Ref. No. 4032 4032I
description air trap ø 39mm H 35mm thread M8 hose ø 6mm plastic	
accessories for 507504	
	GEV No. 507447 Ref. No. 2017 flat gasket PTFE ED ø 14mm ID ø 8mm thickness 2mm Qty 1 pcs
	GEV No. 507448 Ref. No. 2018 nut thread M8 H 8mm SS WS 13 Qty 1 pcs

	
1	
GEV No. 507505	Ref. No. 1360
description air trap ø 39mm H 90mm thread M8 hose ø 6mm plastic	

backflow preventers

backflow preventers

	
1	
GEV No. 516101	Ref. No. 4221
description backflow preventer dishwasher hose ø 12mm	
spare parts for 516101	
	GEV No. 506367 Ref. No. — flat gasket rubber ED ø 40mm ID ø 28mm thickness 1.8mm Qty 1 pcs

door mechanics

miscellaneous



1

GEV No.	504428	Ref. No.	3282
description	bush for door brass ED ø 10/12mm ID ø 8mm H 5mm		



1

GEV No.	507450	Ref. No.	1598
description	spring for door		

washing and rinsing systems



1

GEV No.	517609	Ref. No.	2528
description	bush for rinse arm PTFE L 10.6mm D1 ø 14mm D2 ø 16.5mm ID ø 10mm		

washing and rinsing systems (sorted by producer)

UNIVERBAR



1

GEV No.	507502	Ref. No.	2540
description	wash and rinse arm wash arm L 385mm rinse arm L 385mm w. jets 12 r. jets 4 mounting ø 10/32mm mounting pos. upper/lower L 390mm W 390mm		



1

GEV No.	507581	Ref. No.	2541
description	wash and rinse arm wash arm L 430mm rinse arm L 425mm w. jets 12 r. jets 5		
spare parts for	507581		



GEV No.	505045	Ref. No.	—
description	O-ring EPDM thickness 1.78mm ID ø 5.28mm Qty 1 pcs		

spare parts for 507581

GEV No.	510893	Ref. No.	—
description	O-ring EPDM thickness 2.62mm ID ø 9.92mm Qty 1 pcs		
GEV No.	517092	Ref. No.	—
description	guide for rinse arm shaft		
GEV No.	517101	Ref. No.	—
description	gasket PTFE ED ø 16mm ID ø 10mm thickness 2.5mm Qty 1 pcs		
GEV No.	517102	Ref. No.	—
description	rinse arm shaft		
GEV No.	517103	Ref. No.	—
description	cover		
GEV No.	517104	Ref. No.	—
description	O-ring EPDM thickness 2.62mm ID ø 31.42mm Qty 1 pcs		
GEV No.	517408	Ref. No.	—
description	pipe for wash arm ED ø 42mm L 150mm plastic mounting ø 28mm ID ø 10mm		
GEV No.	517609	Ref. No.	2528
description	bush for rinse arm PTFE L 10.6mm D1 ø 14mm D2 ø 16.5mm ID ø 10mm		
GEV No.	560536	Ref. No.	2535
description	Thumb screw thread M8 thread L 5mm ø 20mm H 10mm SS Qty 1 pcs		



1

GEV No.	507507	Ref. No.	3342
description	wash and rinse arm wash arm L 503mm rinse arm L 475mm w. jets 10 r. jets 6 mounting ø 10/32mm mounting pos. upper/lower		



1

GEV No.	507468	Ref. No.	4080
description	end cap for rinse arm thread M10x1 H 8mm chrome-plated brass		



1

GEV No.	503317	Ref. No.	4022
description	rinse jet H 13mm thread M6x1 WS 10 conical seal		





1

GEV No.	507446	Ref. No.	2530
description	wash arm boss		





			
1			
GEV No.	507506	Ref. No.	3105
description	wash and rinse arm wash arm L 485mm rinse arm L 470mm w. jets 6 r. jets 6 mounting ø 10/43mm mounting pos. upper/lower		

			
1			
GEV No.	507468	Ref. No.	4080
description	end cap for rinse arm thread M10x1 H 8mm chrome-plated brass		

			
1			
GEV No.	503317	Ref. No.	4022
description	rinse jet H 13mm thread M6x1 WS 10 conical seal		

			
1			
GEV No.	517607	Ref. No.	3109
description	wash arm boss mounting ø 10mm ø 28mm L 77mm W 70mm H 49mm		

			
1			
GEV No.	507501	Ref. No.	3259
description	rinse arm L 375mm nozzles 4 mounting ø 10mm mounting pos. upper		
spare parts for	507501		
	GEV No.	503317	Ref. No. 4022
	rinse jet H 13mm thread M6x1 WS 10 conical seal		
	GEV No.	507468	Ref. No. 4080
	end cap for rinse arm thread M10x1 H 8mm chrome-plated brass		

			
1			
GEV No.	507468	Ref. No.	4080
description	end cap for rinse arm thread M10x1 H 8mm chrome-plated brass		

			
1			
GEV No.	503317	Ref. No.	4022
description	rinse jet H 13mm thread M6x1 WS 10 conical seal		

			
1			
GEV No.	517608	Ref. No.	3336
description	wash arm support complete mounting pos. lower thread M8x1.25 ø 35mm H 360mm		

			
1			
GEV No.	507503	Ref. No.	1918
description	wash arm support mounting pos. lower		

			
1			
GEV No.	507467	Ref. No.	4745
description	wash arm support mounting pos. lower ø 35mm H 235mm hose ø 33mm		

knobs

producer-specific knobs

UNIVERBAR

			
1			
GEV No.	110949	Ref. No.	3321
description	knob thermostat t.max. 90°C 0-90°C ø 42mm shaft ø 6x4.6mm shaft flat upper black		

accessories

rosettes



GEV No.	112195	Ref. No.	3322
description	rosette knob knob ø 42mm ø 56mm		

sealing washers

rubber gaskets



GEV No.	517181	Ref. No.	1535
description	flat gasket rubber ED ø 44mm ID ø 32mm thickness 3mm Qty 1 pcs		

gaskets

O-rings

EPDM

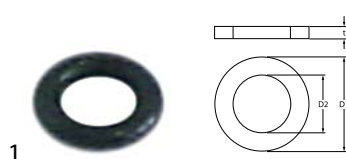

GEV No.	517035	Ref. No.	3285
description	O-ring EPDM thickness 1.78mm ID ø 4.48mm Qty 1 pcs		

PTFE gaskets



GEV No.	507447	Ref. No.	2017
description	flat gasket PTFE ED ø 14mm ID ø 8mm thickness 2mm Qty 1 pcs		

dosing pumps

peristaltic dosing pumps

SEKO

wall-mounted version

with speed control



GEV No.	361156 ¹	Ref. No.	4801
description	dosing pump SEKO speed control 0.6-4l/h 230VAC detergent hose ø 4x6mm hose type K hose Santoprene suction level 1.5m type PR wall-mounted version dimensions 103x82x92mm		

spare parts for 361156



	GEV No.	361136	Ref. No.	—
		roller assembly for dosing pump hole ø 4.8x4mm		
	GEV No.	361815	Ref. No.	—
		pump hose detergent hose ø 6x10mm hose ø 4x6mm hose type K hose Santoprene type SEKO		

accessories for 361156







	GEV No.	361142	Ref. No.	—
		mounting set detergent hose type 4x6mm hose length 2m PVC 2x hose/container filter/tank intake transparent		
	GEV No.	361891	Ref. No.	—
		mounting set detergent hose type 4x6mm hose length 2m PVC 2x hose/container filter/tank intake transparent		
	GEV No.	520090	Ref. No.	—
		PVC hose ID ø 4mm ED ø 6mm L 2m thickness 1mm t.max. 60°C transparent		
	GEV No.	520091	Ref. No.	—
		nylon hose ID ø 4mm ED ø 6mm L 2m thickness 1mm operating p. 10bar burst p. 50bar t.max. 100°C transparent		

¹with accessories



built-in version			
with frequency control			
			
1			
GEV No.	361767 ¹	Ref. No.	1916
description	dosing pump SEKO 3l/h 230VAC detergent hose ø 4x6mm hose type K hose Santoprene suction level 1.5m type NBR 3 8W built-in version peristaltic pump		
spare parts for	361767		
	GEV No.	361815	Ref. No.
	 pump hose detergent hose ø 6x10mm hose ø 4x6mm hose type K hose Santoprene type SEKO		

¹incl. inlet and conveyor hose









accessories for	361535		
	GEV No.	361701	Ref. No.
	 hose connector thread M10x1 grommet ø 7.5mm		
	GEV No.	361703	Ref. No.
	 hose connector thread M10x1 brass pipe connection ø 4x6mmmm		
	GEV No.	361704	Ref. No.
	 hose connector brass straight thread M12x1 hose ø 11mm Qty 1 pcs		
	GEV No.	510296	Ref. No.
	 membrane silicone		
	GEV No.	520090	Ref. No.
	 PVC hose ID ø 4mm ED ø 6mm L 2m thickness 1mm t.max. 60°C transparent		
	GEV No.	520091	Ref. No.
	 nylon hose ID ø 4mm ED ø 6mm L 2m thickness 1mm operating p. 10bar burst p. 50bar t.max. 100°C transparent		

membrane dosing pumps

self-priming with supporting pressure

GERMAC

type 2000

			
1			
GEV No.	361535	Ref. No.	4096
description	dosing pump type 2000 rinse aid inlet 4x6mm outlet M10x1 suction connection ø 4x6mm supporting pressure 11mm rebound ball PTFE 1mm GERMAC CODE VNR/U3		
spare parts for	361535		
	GEV No.	361550	Ref. No.
	 hose connector hose ø 4x6mm		
	GEV No.	361551	Ref. No.
	 compression spring wire gauge ø 1mm		
	GEV No.	361702	Ref. No.
	 hose connector brass hose ø 4x6mm		
	GEV No.	361705	Ref. No.
	 gasket for hose connector M12x1		
	GEV No.	510298	Ref. No.
	 lip valve dosing pump suitable for DB2/DS5		
accessories for	361535		
	GEV No.	361142	Ref. No.
	 mounting set detergent hose type 4x6mm hose length 2m PVC 2x hose/container filter/tank intake transparent		
	GEV No.	361553	Ref. No.
	 membrane EPDM		
	GEV No.	361700	Ref. No.
	 hose connector rotary hose ø 4x6mm plastic connection M10x1		

accessories



container filters

			
1			
GEV No.	361905	Ref. No.	1040
description	container filter plastic hose ø 5mm detergent		

hoses

supply hoses

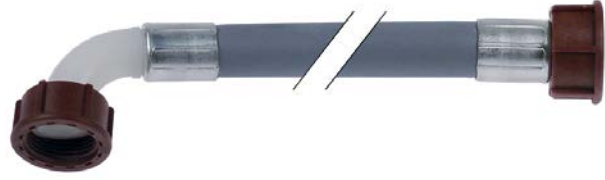
PVC supply hoses

			
1			
GEV No.	520010	Ref. No.	3204
description	supply hose PVC straight-curved DN13 connections 3/4" L 1500mm operating p. 10bar burst p. 32bar t.max. 90°C blue approval VDE flat seal		
accessories for	520010		
	GEV No.	520053	Ref. No.
	 screen connection 3/4" D1 ø 26mm D2 ø 15mm Qty 10 pcs rubber thickness 8mm		
	GEV No.	520054	Ref. No.
	 flat gasket rubber ED ø 23.5mm ID ø 14mm thickness 2.3mm Qty 10 pcs		



drain hoses

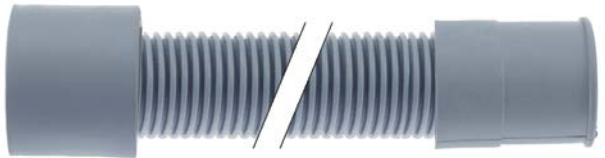

1

GEV No.	511205	Ref. No.	1604
description	drain hose DN19 L 1500mm A int. ø 23mm A ext. ø 29mm B int. ø 29mm outer hose ø 29mm B ext. ø 35mm		

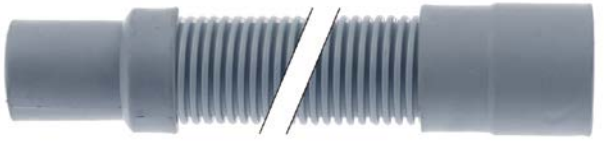

1

GEV No.	530574	Ref. No.	4717
description	drain hose DN31 L 2000mm A int. ø 31mm A ext. ø 35mm B int. ø 40mm B ext. ø 46mm outer hose ø 38mm		

nuts

hexagonal nuts

DIN 6923 / ISO 4161



1

GEV No.	507448	Ref. No.	2018
description	nut thread M8 H 8mm SS WS 13 Qty 1 pcs		

hexagonal nuts metric (without norm)



1

GEV No.	507461	Ref. No.	1505
description	hexagonal nut thread M10x1 H 3mm WS 17 SS Qty 1 pcs		

hexagonal nuts inch thread



1

GEV No.	507459	Ref. No.	1533
description	nut thread 1" H 5mm WS 36 SS Qty 1 pcs		

measuring equipment

thermometers

built-in thermometers



1

GEV No.	541086	Ref. No.	4507
description	thermometer mounting measurements 58x25.5mm 0 up to +120°C capillary pipe 2000mm probe ø 6mm probe L 23mm		

fastening material

screws

knurled screws



1

GEV No.	560536	Ref. No.	2535
description	Thumb screw thread M8 thread L 5mm ø 20mm H 10mm SS Qty 1 pcs		

B			
bi-metal thermostats	4		
C			
compressors	9		
contactors	6		
container filters	17		
control thermostats	5		
D			
dosing pumps	16		
drain hoses	18		
drain pumps	11		
E			
electric accessories	12		
F			
fastening material	18		
H			
heating elements	3		
hexagonal nuts	18		
hoses	17		
I			
immersion heating elements	3		
indicator lights	6		
indicator lights (complete)	6		
K			
knurled screws	18		
L			
lamps	6		
M			
measuring equipment	18		
microswitches	5		
N			
nuts	18		
O			
O-rings	16		
P			
plunger sockets	5		
pressure switches	9		
programme timers	6		
pumps	9		
PVC supply hoses	17		
R			
relays	6		
rocker/momentary rocker switches	5		
S			
safety bi-metal thermostats	4		
screws	18		
sealing washers	16		
solenoid valves	7		
supply hoses	17		
switches and momentary switches	5		
T			
terminals	12		
thermostats	4		
timers	6		
W			
wash and rinse pumps	9		