



**GAS COMPONENTS**



**ELECTRIC COMPONENTS**



**WATER TECHNOLOGY**



**MECHANICAL COMPONENTS**



**TOOLS**

Spare parts suitable for

**UNIVERSO**

Find the complete and up-to-date range of products in our GEV Webshop



# Manufacturer catalogue

The most important spare parts and accessories arranged clearly for every manufacturer

- ✓ Complete product range and all appliance data always up to date in the GEV Webshop
- ✓ Alphabetical Index at the end of the catalogue

## GEV Webshop

[www.gev-online.co.uk](http://www.gev-online.co.uk)

[www.gev-online.com](http://www.gev-online.com)











- 🔍 Add to Favourites
- 🔍 Sign In with email address and usual password
- 🔍 Easy-order – place several items in your basket at the same time
- 🔍 Quick Item search – no login needed



## heating elements



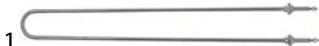

### heating elements for chicken rotisseries

			
<b>GEV No.</b>	416016	<b>Ref. No.</b>	0A0344
<b>description</b>	heating element 1700W 230V 2 hole fixing thread 1/4" L 741mm W 62mm heating circuits 1 connection M6 dry heating element tube ø 8.4mm mounting distance 54mm connection length 28mm chicken rotisserie		
<b>For models:</b>	GE312, GS312		
<b>accessories for</b>	416016		
	<b>GEV No.</b>	361182	<b>Ref. No.</b> —
	nut thread 1/4" H 5mm nickel-plated brass WS 17 Qty 1 pcs		
	<b>GEV No.</b>	510417	<b>Ref. No.</b> —
	flat gasket fibre ED ø 20mm ID ø 14mm thickness 2mm Qty 1 pcs		
	<b>GEV No.</b>	520228	<b>Ref. No.</b> —
	tooth lock washer ID ø 15.3mm ED ø 24mm steel Qty 1 pcs for thread M14		
	<b>GEV No.</b>	550262	<b>Ref. No.</b> —
	flat gasket copper ED ø 20mm ID ø 14mm thickness 2mm		

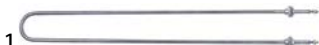
			
<b>GEV No.</b>	416026	<b>Ref. No.</b>	0A0353
<b>description</b>	heating element 2100W 230V 2 hole fixing thread 3/8" L 745mm W 86mm heating circuits 1 connection M6 dry heating element tube ø 10mm mounting distance 76mm connection length 25mm chicken rotisserie		
<b>For models:</b>	GE416		
<b>spare parts for</b>	416026		
	<b>GEV No.</b>	521137	<b>Ref. No.</b> —
	flat gasket fibre ED ø 20mm ID ø 18mm thickness 1.5mm for thread 3/8" Qty 1 pcs		
<b>accessories for</b>	416026		
	<b>GEV No.</b>	361183	<b>Ref. No.</b> —
	nut thread 3/8" H 6mm nickel-plated brass WS 20 Qty 1 pcs		

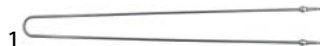
			
<b>GEV No.</b>	416017	<b>Ref. No.</b>	0A0352
<b>description</b>	heating element 2400W 220V edition up to serial no. 5350 2 hole fixing thread 3/8" L 735mm W 80mm heating circuits 1 connection M6x1 dry heating element tube ø 10mm mounting distance 86mm chicken rotisserie		
<b>For models:</b>	GE246		



			
<b>GEV No.</b>	419206	<b>Ref. No.</b>	0A0352B
<b>description</b>	heating element 2400W 230V edition from serial no. 5350 12 hole fixing thread 3/8" L 738mm W 83mm heating circuits 1 connection M6 dry heating element tube ø 10.3mm INCOLOY-800		

			
<b>GEV No.</b>	416025	<b>Ref. No.</b>	A0351B
<b>description</b>	heating element 3000W 230V edition from serial no. 5350 2 hole fixing thread 3/8" L 1035mm W 77mm heating circuits 1 connection M6 dry heating element tube ø 10mm mounting distance 67mm connection length 23mm chicken rotisserie		
<b>accessories for</b>	416025		
	<b>GEV No.</b>	361183	<b>Ref. No.</b> —
	nut thread 3/8" H 6mm nickel-plated brass WS 20 Qty 1 pcs		
	<b>GEV No.</b>	521137	<b>Ref. No.</b> —
	flat gasket fibre ED ø 20mm ID ø 18mm thickness 1.5mm for thread 3/8" Qty 1 pcs		
	<b>GEV No.</b>	692547	<b>Ref. No.</b> —
	adapter for heating element L 235mm W 40mm H 25mm steel		

## switches and momentary switches

### rocker/momentary rocker switches

<b>30x22mm</b>			
<b>blank</b>			
			
<b>GEV No.</b>	345649	<b>Ref. No.</b>	GES20019
<b>description</b>	momentary rocker switch mounting measurements 30x22mm orange 2NO 230V 16A illuminated connection male faston 6.3mm ambient temperature max. 125/55°C protection IP65 with cover cap		
<b>For models:</b>	GE312, GS312		

<b>labelled</b>			
			
<b>GEV No.</b>	345981	<b>Ref. No.</b>	GES20018
<b>description</b>	rocker switch mounting measurements 30x22mm green 2NO 250V 16A illuminated 0-1 connection male faston 6.3mm ambient temperature max. 125/55°C protection IP65 with cover cap		
<b>For models:</b>	GE312, GS312		
<b>accessories for</b>	345981		
	<b>GEV No.</b>	301036	<b>Ref. No.</b> —
	protective cover internal size 30x22mm for rocker switch mounting measurementsmm		



1

<b>GEV No.</b>	345576	<b>Ref. No.</b>	GES20017
<b>description</b>	rocker switch mounting measurements 30x22mm orange 2NO 250V 16A 0-1 connection male faston 6.3mm ambient temperature max. 100/55°C protection IP65 with cover cap		
<b>For models:</b>	GE246, GE312, GE366, GE416, GE960, GS246, GS312, GS366, GS416, GS488, GS960		
<b>accessories for</b>	345576		
	<b>GEV No.</b>	301036	<b>Ref. No.</b>
	protective cover internal size 30x22mm for rocker switch mounting measurementsmm		



1

<b>GEV No.</b>	345648	<b>Ref. No.</b>	GES20016
<b>description</b>	rocker switch mounting measurements 30x22mm white 2NO 250V 16A illuminated 0-1 connection male faston 6.3mm ambient temperature max. 100/55°C protection IP65 with cover cap		
<b>accessories for</b>	345648		
	<b>GEV No.</b>	301036	<b>Ref. No.</b>
	protective cover internal size 30x22mm for rocker switch mounting measurementsmm		

## rotary switches

### miscellaneous



1

<b>GEV No.</b>	345424	<b>Ref. No.</b>	0A0367
<b>description</b>	rotary switch 0-1-2-3 type I-8801 400V 25A connection screw 4 operating positions		



1

<b>GEV No.</b>	347660	<b>Ref. No.</b>	0A0367 A0367B
<b>description</b>	rotary switch sets of contacts 4 4 0-1-2-3 type T225-I-8801GA 440V 32A shaft ø 7.5mm shaft L 10mm shaft round connection screw		
<b>For models:</b>	GE246, GE366, GE416, GE960		

## control equipment

### SIEMENS

#### 3SB series ø22mm new

#### push buttons



1

<b>GEV No.</b>	345671	<b>Ref. No.</b>	0A0341 Start schwarz
<b>description</b>	push button mounting measurements ø22mm black		
<b>For models:</b>	GE246, GE960, GS246, GS366, GS416, GS488, GS960		



1

<b>GEV No.</b>	345672	<b>Ref. No.</b>	0A0341 Stop rot
<b>description</b>	push button mounting measurements ø22mm red		
<b>For models:</b>	GE246, GE960, GS246, GS366, GS416, GS488, GS960		



1

<b>GEV No.</b>	345669	<b>Ref. No.</b>	0A0330
<b>description</b>	contact block 1NC/1NO		
<b>For models:</b>	GE246, GE366, GE416, GE960, GS246, GS366, GS416, GS488, GS960		

#### rotary switches



1

<b>GEV No.</b>	345674	<b>Ref. No.</b>	0A0358A
<b>description</b>	rotary selector mounting measurements ø22mm black latching sequence 0-1		
<b>For models:</b>	GE246, GE366, GE416, GE960, GS246, GS366, GS416, GS488, GS960		
<b>accessories for</b>	345674		



<b>GEV No.</b>	346602	<b>Ref. No.</b>	—
	contact block SIEMENS 3SB3400-0D 2NO max 400V 10A black		



<b>GEV No.</b>	346603	<b>Ref. No.</b>	—
	contact block SIEMENS 3SB3400-0E 2NC max 400V 10A black		



<b>GEV No.</b>	346630	<b>Ref. No.</b>	—
	contact block SIEMENS 3SB3400-0B 1NO max 400V 10A black		



<b>GEV No.</b>	346631	<b>Ref. No.</b>	—
	contact block SIEMENS 3SB3400-0C 1NC max 400V 10A black		

Table continues overleaf



<b>accessories for</b>	345674		
	GEV No.	346632	Ref. No. —
	contact block SIEMENS 3SB3400-0D 1NC/1NO max 400V 10A black		

			
1			
<b>GEV No.</b>	345673	<b>Ref. No.</b>	0A0358B
<b>description</b>	rotary selector mounting measurements ø22mm black latching sequence 1-0-2		
<b>For models:</b>	GE246, GE366, GE416, GE960, GS246, GS366, GS416, GS488, GS960		

## lamps

### oven lamps

#### universal oven lamps

mounting diameter 35.5mm

			
1			
<b>GEV No.</b>	359259	<b>Ref. No.</b>	0A0339
<b>description</b>	oven lamp mounting ø 35.5mm 230V 40W socket G9 temp.-resist. 300°C connection cable 380mm hard glas		
<b>For models:</b>	GE246, GE312, GE366, GE416, GE960, GS246, GS312, GS366, GS416, GS488, GS960		
<b>spare parts for</b>	359259		
	GEV No.	357161	Ref. No. —
	lamp socket socket G9 220-230V mounting ø 35.5mm connection cable 380mm		
	GEV No.	358128	Ref. No. —
	gasket for oven lamp silicone ID ø 30mm ED ø 38mm thickness 2mm		
	GEV No.	359942	Ref. No. —
	oven lamp glass thr.ø 33.5mm ø 41mm hard glas temp.-resist. 350°C		
	GEV No.	359946	Ref. No. —
	halogen lamp socket G9 230V 40W temp.-resist. 300°C		

## relays

### power relays

#### with male contacts

#### bullet connectors, 8 contacts

			
1			
<b>GEV No.</b>	380134	<b>Ref. No.</b>	GES20022
<b>description</b>	power relays Italiana Relè 230VAC 10A 2CO connection plug-in connection round 8-pole manif. no. C42-230VAC 90.26/ZVE8 250V		
<b>For models:</b>	GE312, GS312		
<b>accessories for</b>	380134		
	GEV No.	380137	Ref. No. —
	relay socket 8-pole connection plug-in connection round 8-pole dimensions 65x28x40mm 380V voltage AC 10A Italiana Relè manif. no. ZVE8		
	GEV No.	380638	Ref. No. —
	relay socket 8-pole dimensions 51x41x23mm 250V 10A FINDER manif. no. 90.26		

## motors

### gear motors

#### for grills

			
1			
<b>GEV No.</b>	501555	<b>Ref. No.</b>	GES20026+GES20032
<b>description</b>	gear motor MECHTEX type M14 A MSE 30 shaft ø 25mm		
			
1			
<b>GEV No.</b>	500499	<b>Ref. No.</b>	GES20026
<b>description</b>	gear motor TRIAL type MR5 230V 50/60Hz shaft ø 5/8mm for chicken rotisserie		
<b>For models:</b>	GE312, GS312		









## gas taps





## PEL

## 22S/O series



1

<b>GEV No.</b>	101086	<b>Ref. No.</b>	GSP041
<b>description</b>	gas tap PEL type 22S/O gas inlet M20x1.5 (tube ø 12mm) bypass nozzle ø 0.35mm gas outlet M20x1.5 (tube ø 12/10mm) thermocouple connection M9x1 pilot connection M10x1 shaft ø 10x8mm shaft L 25/17mm shaft flat lower		
<b>For models:</b>	GS246, GS366, GS488		
<b>spare parts for</b>	101086		
	<b>GEV No.</b>	100259	<b>Ref. No.</b> —
	bypass nozzle type PEL22 bore ø 0.35mm thread M6x0.5		
	<b>GEV No.</b>	101058	<b>Ref. No.</b> —
	magnet unit L 39mm D1 ø 15.4mm D2 ø 13.5mm suitable for PEL22/EGA24197 standard		
	<b>GEV No.</b>	101201	<b>Ref. No.</b> —
	gas tap front part shaft ø 10x8mm shaft L 25/17mm shaft flat upper/lower suitable for PEL22		
	<b>GEV No.</b>	101231	<b>Ref. No.</b> —
	thermocouple nut T1: M9x1 T2: M18x1		
	<b>GEV No.</b>	101240	<b>Ref. No.</b> —
	gas connection thread M20x1.5 tube ø 12/10mm for PEL gas taps with gasket and screws horizontal		
	<b>GEV No.</b>	101460	<b>Ref. No.</b> —
	O-ring ø 12.37mm D1 ø 2.62mm suitable for PEL22		
	<b>GEV No.</b>	101461	<b>Ref. No.</b> —
	screw kit suitable for PEL22 Qty 4 pcs		
<b>accessories for</b>	101086		
	<b>GEV No.</b>	100908	<b>Ref. No.</b> —
	union screw thread M10x1 for pipe ø 4mm Qty 1 pcs		
	<b>GEV No.</b>	100909	<b>Ref. No.</b> —
	union screw thread M10x1 for pipe ø 6mm Qty 1 pcs		
	<b>GEV No.</b>	101241	<b>Ref. No.</b> —
	gas connection thread M20x1.5 tube ø 12/10mm for PEL gas taps vertical		
	<b>GEV No.</b>	101246	<b>Ref. No.</b> —
	olive for pipe ø 4mm Qty 1 pcs		
	<b>GEV No.</b>	101248	<b>Ref. No.</b> —
	olive for pipe ø 12mm Qty 1 pcs suitable for PEL		
	<b>GEV No.</b>	101249	<b>Ref. No.</b> —
	olive for pipe ø 10mm Qty 1 pcs		
	<b>GEV No.</b>	101250	<b>Ref. No.</b> —
	union nut thread M20x1.5 for pipe ø 10mm		

<b>accessories for</b>	101086		
	<b>GEV No.</b>	101251	<b>Ref. No.</b> —
	union nut thread M20x1.5 for pipe ø 12mm		
	<b>GEV No.</b>	101286	<b>Ref. No.</b> —
	olive ID ø 6mm Qty 1 pcs		
	<b>GEV No.</b>	110080	<b>Ref. No.</b> A0377 PLX20010
	knob ø 70mm shaft ø 10x8mm shaft flat universal		
	<b>GEV No.</b>	112206	<b>Ref. No.</b> —
	knob dial plate silver gas tap PEL21/22/23 t.max.°C ED ø 63mm ID ø 45.5mm		

## 22S/V series



1

<b>GEV No.</b>	101087	<b>Ref. No.</b>	PLX20009
<b>description</b>	gas tap PEL type 22S/V gas inlet M20x1.5 (tube ø 12mm) bypass nozzle ø 0.35mm gas outlet M20x1.5 (tube ø 12/10mm) thermocouple connection M9x1 pilot connection M10x1 shaft ø 10x8mm shaft L 25/17mm shaft flat upper		
<b>For models:</b>	GE312, GS312, PLX124 M, PLX47, PLX47 M, PLX60, PLX60 M, PLX80, PLX80 M		
<b>spare parts for</b>	101087		
	<b>GEV No.</b>	100259	<b>Ref. No.</b> —
	bypass nozzle type PEL22 bore ø 0.35mm thread M6x0.5		
	<b>GEV No.</b>	101058	<b>Ref. No.</b> —
	magnet unit L 39mm D1 ø 15.4mm D2 ø 13.5mm suitable for PEL22/EGA24197 standard		
	<b>GEV No.</b>	101201	<b>Ref. No.</b> —
	gas tap front part shaft ø 10x8mm shaft L 25/17mm shaft flat upper/lower suitable for PEL22		
	<b>GEV No.</b>	101231	<b>Ref. No.</b> —
	thermocouple nut T1: M9x1 T2: M18x1		
	<b>GEV No.</b>	101241	<b>Ref. No.</b> —
	gas connection thread M20x1.5 tube ø 12/10mm for PEL gas taps vertical		
	<b>GEV No.</b>	101460	<b>Ref. No.</b> —
	O-ring ø 12.37mm D1 ø 2.62mm suitable for PEL22		
	<b>GEV No.</b>	101461	<b>Ref. No.</b> —
	screw kit suitable for PEL22 Qty 4 pcs		
<b>accessories for</b>	101087		
	<b>GEV No.</b>	100908	<b>Ref. No.</b> —
	union screw thread M10x1 for pipe ø 4mm Qty 1 pcs		
	<b>GEV No.</b>	100909	<b>Ref. No.</b> —
	union screw thread M10x1 for pipe ø 6mm Qty 1 pcs		
	<b>GEV No.</b>	101240	<b>Ref. No.</b> —
	gas connection thread M20x1.5 tube ø 12/10mm for PEL gas taps with gasket and screws horizontal		

Table continues overleaf



accessories for		101087		
	GEV No.	101246	Ref. No.	—
olive for pipe ø 4mm Qty 1 pcs				
	GEV No.	101248	Ref. No.	—
olive for pipe ø 12mm Qty 1 pcs suitable for PEL				
	GEV No.	101249	Ref. No.	—
olive for pipe ø 10mm Qty 1 pcs				
	GEV No.	101250	Ref. No.	—
union nut thread M20x1.5 for pipe ø 10mm				
	GEV No.	101251	Ref. No.	—
union nut thread M20x1.5 for pipe ø 12mm				
	GEV No.	101286	Ref. No.	—
olive ID ø 6mm Qty 1 pcs				
	GEV No.	110080	Ref. No.	A0377 PLX20010
knob ø 70mm shaft ø 10x8mm shaft flat universal				
	GEV No.	112206	Ref. No.	—
knob dial plate silver gas tap PEL21/22/23 t.max.°C ED ø 63mm ID ø 45.5mm				

spare parts for		106906		
	GEV No.	107162	Ref. No.	—
pilot burner cap SIT 3 flames Hmm Lmm Qty 1 pcs				
	GEV No.	107701	Ref. No.	—
pilot burner bottom part SIT 100 series nozzle ø 0.2mm				
accessories for		106906		
	GEV No.	100245	Ref. No.	—
pilot burner nozzle LPG code 20 bore ø 0.2mm Qty 1 pcs thread M8x0.75				
	GEV No.	100246	Ref. No.	—
pilot burner nozzle natural gas bore ø 0.35mm Qty 1 pcs thread M8x0.75				
	GEV No.	100904	Ref. No.	—
locking screw M10x1 for pipe ø 4mm Qty 1 pcs				
	GEV No.	100905	Ref. No.	—
locking screw M10x1 for pipe ø 6mm Qty 1 pcs				
	GEV No.	102110	Ref. No.	—
pilot tube copper pipe ø 4mm thickness 1mm L 3000mm				
	GEV No.	102111	Ref. No.	—
pilot tube copper pipe ø 6mm thickness 1mm L 3000mm				
	GEV No.	107171	Ref. No.	—
pilot burner nozzle SIT natural/liquid gas bore ø 0.25mm Qty 1 pcs				
	GEV No.	107700	Ref. No.	—
pilot burner bottom part SIT 100 series nozzle ø 0.25mm				
	GEV No.	107702	Ref. No.	—
pilot burner bottom part SIT 100 series nozzle ø 0.35mm				

## ignition parts

### pilot burners

#### SIT

##### 100 series



1				
<b>GEV No.</b>	106906	<b>Ref. No.</b>	PLX20004	
<b>description</b>	pilot burner SIT type 100 series 3 flames nozzle ø 0.2mm gas connection 6mm			
spare parts for		106906		
	GEV No.	100245	Ref. No.	—
pilot burner nozzle LPG code 20 bore ø 0.2mm Qty 1 pcs thread M8x0.75				
	GEV No.	100855	Ref. No.	—
pilot burner bracket triple				
	GEV No.	100885	Ref. No.	—
air mixing sleeve for pilot burner Qty 1 pcs				
	GEV No.	100916	Ref. No.	—
compression spring for pilot burner Qty 1 pcs				
	GEV No.	100917	Ref. No.	—
gasket for pilot burner Qty 1 pcs aluminium				
	GEV No.	100918	Ref. No.	—
screw for pilot burner				











#### POLIDORO

##### pilot burners





1				
<b>GEV No.</b>	100079	<b>Ref. No.</b>	GS20030	
<b>description</b>	pilot burner POLIDORO 3 flames code gas connectionmm			
<b>For models:</b>	GE312, GS246, GS312, GS366, GS416, GS488, GS960			
accessories for		100079		
	GEV No.	100000	Ref. No.	—
pilot burner nozzle POLIDORO LPG code 22 bore ø 0.22mm Qty 1 pcs				
	GEV No.	100208	Ref. No.	—
pilot burner nozzle POLIDORO LPG code 20 bore ø 0.2mm Qty 1 pcs				
	GEV No.	100209	Ref. No.	—
pilot burner nozzle POLIDORO natural gas code 40 bore ø 0.4mm Qty 1 pcs				
	GEV No.	100701	Ref. No.	GS20038
ignition electrode connection M4 Qty 1 pcs				

Table continues overleaf

accessories for		100079	
	GEV No.	100906	Ref. No. —
screw connection thread M10x1 for ignition electrode brass Qty 1 pcs WS 10			
	GEV No.	100907	Ref. No. —
screw connection thread M10x1 Qty 1 pcs type SEF 1 ømm for thermocouple			
	GEV No.	100908	Ref. No. —
union screw thread M10x1 for pipe ø 4mm Qty 1 pcs			
	GEV No.	100909	Ref. No. —
union screw thread M10x1 for pipe ø 6mm Qty 1 pcs			
	GEV No.	102110	Ref. No. —
pilot tube copper pipe ø 4mm thickness 1mm L 3000mm			
	GEV No.	102111	Ref. No. —
pilot tube copper pipe ø 6mm thickness 1mm L 3000mm			
	GEV No.	102699	Ref. No. —
pilot burner nozzle POLIDORO natural gas code 25.2 bore ø 2x0.25mm Qty 1 pcs 2 bores			
	GEV No.	102795	Ref. No. —
olive for pipe ø 4mm Qty 1 pcs			
	GEV No.	102797	Ref. No. —
olive for pipe ø 6mm Qty 1 pcs			
	GEV No.	106703	Ref. No. —
pilot burner nozzle POLIDORO natural gas code 27.2 bore ø 2x0.27mm Qty 1 pcs			
	GEV No.	106704	Ref. No. —
pilot burner nozzle POLIDORO LPG code 16.2 bore ø 2x0.16mm Qty 1 pcs			
	GEV No.	106763	Ref. No. —
pilot burner nozzle POLIDORO natural gas code 27.2A bore ø 2x 0.27mm Qty 1 pcs			
	GEV No.	106859	Ref. No. —
pilot burner nozzle POLIDORO LPG code 24 bore ø 0.24mm Qty 1 pcs			

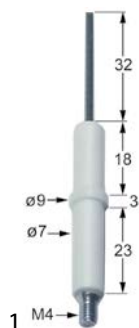
electrodes



<b>GEV No.</b>	100701	<b>Ref. No.</b>	GS20038
<b>description</b>	ignition electrode connection M4 Qty 1 pcs		
<b>For models:</b>	GE312, GS246, GS312, GS366, GS416, GS488, GS960		
<b>accessories for</b>	100701		
	GEV No.	100906	Ref. No. —
screw connection thread M10x1 for ignition electrode brass Qty 1 pcs WS 10			

ignition cables

pre-assembled cables



<b>GEV No.</b>	100018	<b>Ref. No.</b>	PLX20008
<b>description</b>	ignition cable cable length 600mm connection ø2.4mm / ø4mm permanent temperature 200°C		
<b>For models:</b>	GE312, GS246, GS312, GS366, GS416, GS488, PLX124 M, PLX47, PLX47 M, PLX60, PLX60M, PLX80, PLX80 M		

piezoelectric igniters

mounting diameter 18mm



<b>GEV No.</b>	100003	<b>Ref. No.</b>	PLX20001
<b>description</b>	piezoelectric igniter body metal blowing mounting ø 18mm connection F2.8x0.8		
<b>For models:</b>	GE312, GS246, GS312, GS366, GS416, GS488, GS960, PLX124 M, PLX47, PLX47 M, PLX60, PLX60M, PLX80, PLX80 M		

thermocouples

plug-in thermocouples

plug-in thermocouples standard

with barrel socket ø6(6.5)mm

thermocouples SIT

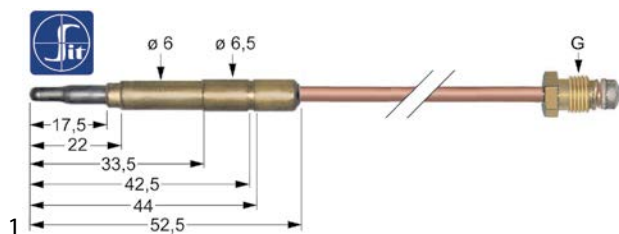

<b>GEV No.</b>	107609	<b>Ref. No.</b>	PLX20039
<b>description</b>	thermocouple SIT M9x1 L 600mm plug connection ø6.0(6.5)mm		
<b>For models:</b>	GE312, GS246, GS312, GS366, GS416, GS488, GS960, PLX124 M, PLX47, PLX47 M, PLX60, PLX60M, PLX80, PLX80 M		





## gas burners

### bar burners

#### bar burners



1

<b>GEV No.</b>	105421	<b>Ref. No.</b>	PLX20002
<b>description</b>	bar burner 3 row L 480mm W 305mm ømm H 50mm chargrill		
<b>For models:</b>	PLX47, PLX47 M, PLX80, PLX80 M		



1

<b>GEV No.</b>	105422	<b>Ref. No.</b>	PLX20003
<b>description</b>	bar burner 4 row L 480mm W 450mm ømm chargrill		
<b>For models:</b>	PLX124 M, PLX60, PLX60M		



1

<b>GEV No.</b>	105429	<b>Ref. No.</b>	GSP080
<b>description</b>	bar burner angled L 1220mm W 403mm ømm Hmm chicken rotisserie		
<b>For models:</b>	GS366, GS488		



1

<b>GEV No.</b>	105428	<b>Ref. No.</b>	GS20032
<b>description</b>	bar burner angled L 880mm W 330mm ømm Hmm chicken rotisserie		
<b>For models:</b>	GE312, GS246, GS312, GS416		



1

<b>GEV No.</b>	211013	<b>Ref. No.</b>	PLX20030
<b>description</b>	lava rock grid L 450mm W 230mm H 20mm		
<b>For models:</b>	PLX124 M, PLX60, PLX60 M		



1

<b>GEV No.</b>	105341	<b>Ref. No.</b>	PLX20029
<b>description</b>	lava rock grid L 450mm W 330mm		
<b>For models:</b>	PLX47, PLX47 M, PLX80, PLX80 M		

#### lava rock grids



1

<b>GEV No.</b>	211013	<b>Ref. No.</b>	PLX20030
<b>description</b>	lava rock grid L 450mm W 230mm H 20mm		
<b>For models:</b>	PLX124 M, PLX60, PLX60 M		



1

<b>GEV No.</b>	105341	<b>Ref. No.</b>	PLX20029
<b>description</b>	lava rock grid L 450mm W 330mm		
<b>For models:</b>	PLX47, PLX47 M, PLX80, PLX80 M		

## gas nozzles

### main nozzles

#### gas nozzles M13x1



1

<b>GEV No.</b>	102780	<b>Ref. No.</b>	PLX20012 115
<b>description</b>	gas injector thread M13x1 bore ø 1.15mm WS 13		



1

<b>GEV No.</b>	102471	<b>Ref. No.</b>	PLX20012 230
<b>description</b>	gas injector thread M13x1 bore ø 2.3mm WS 13		



1

<b>GEV No.</b>	102790	<b>Ref. No.</b>	PLX20012 255 PLX20015
<b>description</b>	gas injector thread M13x1 bore ø 2.55mm WS 13		



1

<b>GEV No.</b>	102470	<b>Ref. No.</b>	PLX20012 200
<b>description</b>	gas injector thread M13x1 bore ø 2mm WS 13		

## gas nozzles sets



1

<b>GEV No.</b>	102469	<b>Ref. No.</b>	SET PLX80 G30
<b>description</b>	gas injector set LPG PLX80 UNIVERSO		



1

<b>GEV No.</b>	102475	<b>Ref. No.</b>	SET PLX106 G20
<b>description</b>	gas injector set natural gas PLX106 UNIVERSO		



1

<b>GEV No.</b>	102472	<b>Ref. No.</b>	SET PLX47 G20
<b>description</b>	gas injector set natural gas PLX47 UNIVERSO		



1

<b>GEV No.</b>	102473	<b>Ref. No.</b>	SET PLX60 G20
<b>description</b>	gas injector set natural gas PLX60 UNIVERSO		



1

<b>GEV No.</b>	102474	<b>Ref. No.</b>	SET PLX80 G20
<b>description</b>	gas injector set natural gas PLX80 UNIVERSO		

## equipment-specific units

## for chicken rotisserie

## skewer intakes



1

<b>GEV No.</b>	690508	<b>Ref. No.</b>	GES20032
<b>description</b>	skewer intake		
<b>For models:</b>	GE312, GS312		



1

<b>GEV No.</b>	690690	<b>Ref. No.</b>	BV18
<b>description</b>	skewer intake thread M16x1.5 D1 ø 25mm D2 ø 12.5mm L 71mm		

## skewers



1

<b>GEV No.</b>	693794	<b>Ref. No.</b>	GSP031
<b>description</b>	skewer chicken rotisserie L 785mm complete W 120mm		
<b>For models:</b>	GS246		



1

<b>GEV No.</b>	689997	<b>Ref. No.</b>	A086 GES30030
<b>description</b>	skewer with skewer clamps for chicken rotisserie L 800mm thickness 10x10mm stainless steel		

## spit clamp



1

<b>GEV No.</b>	689998	<b>Ref. No.</b>	A.048
<b>description</b>	skewer clamp double for chicken rotisserie mounting pos. centre skewer 12x12mm		



miscellaneous



1

<b>GEV No.</b>	689999	<b>Ref. No.</b>	GE20015
<b>description</b>	bracket for heating element L 75mm W 43mm H 18mm stainless steel		

handles and hand wheels

cylindrical handles

fixed



1

<b>GEV No.</b>	698652	<b>Ref. No.</b>	PLX20011
<b>description</b>	cylindrical handle thread M10 ø 27.5mm L 90.5mm plastic black		



**B**

bar burners 9

**C**

control equipment 4

**G**

gas burners 9

gas nozzles 9

gas taps 6

**H**

heating elements 3

**I**

ignition cables 8

**L**

lamps 5

**M**

motors 5

**O**

oven lamps 5

**P**

piezoelectric igniters 8

pilot burners 7

**R**

relays 5

rocker/momentary rocker switches 3

rotary switches 4

**S**

switches and momentary switches 3

**T**

thermocouples 8