



GAS COMPONENTS



ELECTRIC COMPONENTS



WATER TECHNOLOGY



MECHANICAL COMPONENTS



TOOLS

Spare parts suitable for

VEGA

Find the complete and up-to-date range of products in our GEV Webshop



Manufacturer catalogue

The most important spare parts and accessories arranged clearly for every manufacturer

- ✓ Complete product range and all appliance data always up to date in the GEV Webshop
- ✓ Alphabetical Index at the end of the catalogue

GEV Webshop

www.gev-online.co.uk

www.gev-online.com





- 🔍 Add to Favourites
- 🔍 Sign In with email address and usual password
- 🔍 Easy-order – place several items in your basket at the same time
- 🔍 Quick Item search – no login needed



heating elements

heating elements for bain maries

			
GEV No.	416161	Ref. No.	92023
description	heating element 1000W 230V heating circuits 1 L 430mm W 95mm connection male faston 6.3mm connection distance 40mm connection length 10mm tube ø 6.3mm dry heating element W2 39mm H 36mm		
For models:	BM1		





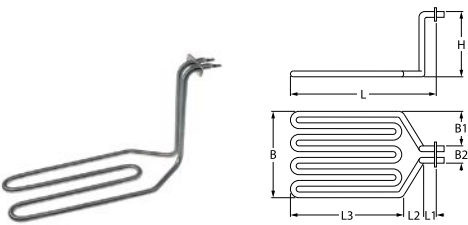

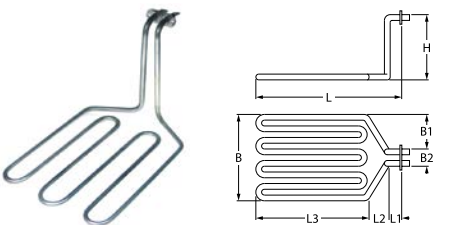

			
GEV No.	418502	Ref. No.	92028 92028G
description	heating element 1200W 230V heating circuits 1 L 410mm W 195mm connection male faston 6.3mm tube ø 6.5mm dry heating element		

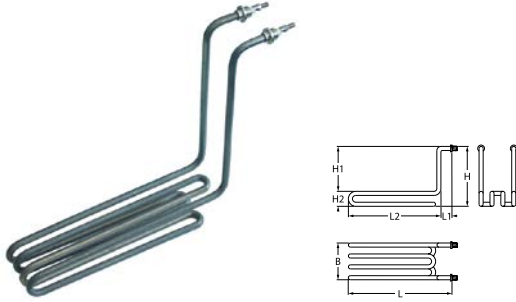
heating elements for fryers

			
GEV No.	418531	Ref. No.	N/A
description	heating element 2000W 230V heating circuits 1 L 296mm W 120mm H 170mm rectangular flange connection male faston 6.3mm immersion heater L1 14mm L2 70mm L3 212mm W1 50mm W2 27mm hole distance 40mm windings 2 hole ø 4mm flange length 51mm flange width 22mm tube ø 8.5mm connection length 37mm		

			
GEV No.	418501	Ref. No.	93178
description	heating element 3000W 230V heating circuits 1 L 280mm W 191mm H 164mm rectangular flange connection male faston 6.3mm L1 15mm L2 35mm L3 230mm W1 80mm W2 31mm hole distance 40mm windings 3 hole ø 4mm flange length 50mm flange width 22mm		

2 hole fixing

			
GEV No.	416172	Ref. No.	93097
description	heating element 3000W 230V heating circuits 1 L 300mm W 80mm H 255mm L1 43mm L2 257mm H1 215mm H2 40mm thread 1/4" mounting distance 67mm tube ø 8.5mm 2 hole fixing connection M5 connection length 12mm immersion heater windings 4		
spare parts for	416172		
	GEV No.	510417	Ref. No. —
	flat gasket fibre ED ø 20mm ID ø 14mm thickness 2mm Qty 1 pcs		
	GEV No.	528723	Ref. No. —
	flat gasket FIBER ED ø 20mm ID ø 13mm thickness 1mm Qty 1 pcs		
accessories for	416172		
	GEV No.	361182	Ref. No. —
	nut thread 1/4" H 5mm nickel-plated brass WS 17 Qty 1 pcs		
	GEV No.	520228	Ref. No. —
	tooth lock washer ID ø 15.3mm ED ø 24mm steel Qty 1 pcs for thread M14		
	GEV No.	550262	Ref. No. —
	flat gasket copper ED ø 20mm ID ø 14mm thickness 2mm		
	GEV No.	560112	Ref. No. —
	plain washer ID ø 5.3mm ED ø 10mm thickness 1mm SS Qty 20 pcs DIN 125A for thread M5		
	GEV No.	560132	Ref. No. —
	hexagonal nut thread M5 H 4mm WS 8 SS DIN/ISO DIN 934 / ISO 4032/8673 Qty 20 pcs		

heating elements for griddles





			
GEV No.	416161	Ref. No.	92023
description	heating element 1000W 230V heating circuits 1 L 430mm W 95mm connection male faston 6.3mm connection distance 40mm connection length 10mm tube ø 6.3mm dry heating element W2 39mm H 36mm		
For models:	BM1		

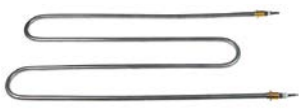

heating elements for contact grills

			
1			
GEV No.	417662	Ref. No.	Heizung zu 80879
description	heating element 2400W 230V heating circuits 1 L 315mm W 285mm H 50mm connection distance 280mm tube ø 8.5mm		

heating elements for pizza ovens

			
1			
GEV No.	416848	Ref. No.	93107
description	heating element 800W 230V L 445mm W 195mm thread 1/4" mounting distance 186mm connection length 15mm connection M4 tube ø 8.5mm heating circuits 1 dry heating element 2 hole fixing		
accessories for	416848		
	GEV No.	361182	Ref. No. —
	nut thread 1/4" H 5mm nickel-plated brass WS 17 Qty 1 pcs		
	GEV No.	510417	Ref. No. —
	flat gasket fibre ED ø 20mm ID ø 14mm thickness 2mm Qty 1 pcs		
	GEV No.	520228	Ref. No. —
	tooth lock washer ID ø 15.3mm ED ø 24mm steel Qty 1 pcs for thread M14		
	GEV No.	550262	Ref. No. —
	flat gasket copper ED ø 20mm ID ø 14mm thickness 2mm		

heating elements for rechauds

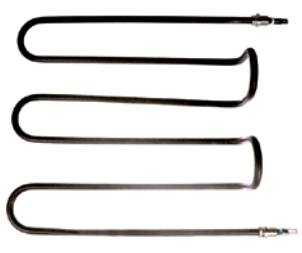
			
1			
GEV No.	418518	Ref. No.	für 81133V1
description	heating element 1300W 230V		

			
1			
GEV No.	418516	Ref. No.	für 81132
description	heating element 650W 230V		

heating elements for heated cabinets

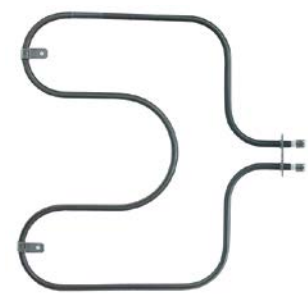
			
1			
GEV No.	416719	Ref. No.	93272
description	heating element 600W 230V heating circuits 1 L 259mm W 275mm flange length 44mm flange width 22mm connection male faston 6.3mm tube ø 6.5mm rectangular flange hole ø 4mm dry heating element L1 45mm L2 214mm W1 125mm W2 29mm		

quartz heating elements

			
1			
GEV No.	415303	Ref. No.	92027
description	heating element 400W 115V L 340mm ø 12mm connection male faston 6.3mm		
For models:	T2		

			
1			
GEV No.	419179	Ref. No.	93119 93119G
description	quartz heating element 700W 110V L 560mm ø 11.5mm connection F6.3 17.5Ohm		

			
1			
GEV No.	416020	Ref. No.	92000
description	quartz tube WV L 390mm ID ø 9mm ED ø 11mm		



energy regulators

EGO

1-circuit



GEV No.	380015	Ref. No.	93087G
description	energy regulator 230V 13A single-circuit turn direction right shaft ø 6x4.6mm shaft L 23mm mounting thread M4 power release 6-100% no. 50.57021.010		

thermostats

control and safety thermostats

EGO

control thermostats

55.10/19_ series



GEV No.	375856	Ref. No.	93238
description	thermostat t.max. 187°C temperature range 101-187°C 1-pole 1NO 16A probe ø 6mm probe L 130mm capillary pipe 900mm capillary pipe isolated 700mm gland nut M10x1 shaft ø 6x4.6mm shaft L 23mm shaft position upper rotation 270°		

55.13_ series



GEV No.	375530	Ref. No.	93044 G
description	thermostat t.max. 400°C temperature range 100-400°C 1-pole 1NO 16A probe ø 3.9mm probe L 163mm capillary pipe 830mm capillary pipe isolatedmm gland nut shaft ø 6x4.6mm shaft L 23mm shaft position upper rotation 270°		

safety thermostats

55.10/19_ series



GEV No.	375339	Ref. No.	93239G
description	safety thermostat switch-off temp. 225°C 1-pole 0.5A probe ø 6mm probe L 133mm capillary pipe 870mm capillary pipe isolatedmm gland nut M10x1 probe		

accessories for

	GEV No.	551083	Ref. No.	—
		cap for safety thermostat thread M8x1		

IMIT / TEMPOMATIC / ARTERMO

control thermostats



GEV No.	375805	Ref. No.	93001
description	thermostat t.max. 90°C temperature range 0-90°C 1-pole 1CO 15A probe ø 6.5mm probe L 85mm capillary pipe 1000mm capillary pipe isolated 900mm gland nut shaft ø 6x4.6mm shaft L 19mm rotation 270°		

TECASA

control thermostats



GEV No.	375801	Ref. No.	93179
description	thermostat t.max. 180°C temperature range 50-180°C 1-pole 1NO 16A probe ø 6mm probe L 75mm capillary pipe 420mm capillary pipe isolatedmm gland nut shaft ø 6x4.6mm rotation 270°		
For models:	81064, 81065, CHEF		

safety thermostats



GEV No.	390028	Ref. No.	93037
description	safety thermostat switch-off temp. 230°C 1-pole 16A probe ø 3mm probe L 155mm capillary pipe 890mm capillary pipe isolated 600mm gland nut probe SS		



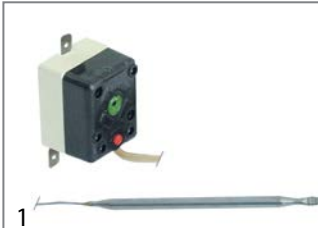

			
GEV No.	375195	Ref. No.	93180
description	safety thermostat switch-off temp. 240°C 1-pole 16A probe ø 4mm probe L 84mm capillary pipe 400mm capillary pipe isolated 130mm gland nut probe SS		
For models:	81064, 81065, CHEF		

switches and momentary switches

rocker/momentary rocker switches

30x11mm

			
GEV No.	301010	Ref. No.	93258
description	rocker switch mounting measurements 30x11mm red 1NO/indicator light 250V 16A 0-I connection male faston 6.3mm ambient temperature max. 85/125°C protection IP40		
accessories for	301010		
	GEV No.	301035	Ref. No. —
	protective cover mounting measurements 30x11mm		

30x22mm

			
GEV No.	345641	Ref. No.	93002
description	rocker switch mounting measurements 30x22mm red 2NO 230V 16A illuminated 0-I connection male faston 6.3mm ambient temperature max. 125/55°C protection IP65 with rubber collar		

microswitches

lever actuated

			
GEV No.	346969	Ref. No.	Microschalter zu 81207
description	microswitch with lever 250V 16A 1NO connection male faston 6.3mm L 59mm L1 29mm ambient temperature max. 120°C mounting distance 22mm actuating force: 50g lever length 50mm		

lamps

indicator lights

indicator lights (complete)

ø12mm

with plug-in socket

			
GEV No.	359898	Ref. No.	für 81141V1
description	indicator light ø 12mm 230V green connection male faston 6.3mm		



ø13mm

with plug-in socket

			
GEV No.	359143	Ref. No.	93004
description	indicator light ø 13mm yellow 230V connection male faston 6.3mm temp.-resist. 120°C Qty 1 pcs		
For models:	81064, 81065, T2		

timers

mechanical timers

			
GEV No.	350044	Ref. No.	93003
description	timer C20 2-pole operation time 15min impulse mechanical 2NO at 250V 16A permanent position no shaft ø 6x4.6mm shaft 6x4.6mm shaft L 20mm mounting distance 28mm connection lateral for toaster		
For models:	T2		
accessories for	350044		
	GEV No.	110285	Ref. No. —
	knob switch zero mark t.max.°C°C ø 40mm shaft ø 6x4.6mm shaft flat upper black		



equipment-specific units

for rechauds

warming plates

components



1

GEV No.	693839	Ref. No.	93234
description	warming plate dimensions 270x150x10(6)mm		

knobs

universal knobs



1

GEV No.	112121	Ref. No.	93314
description	knob thermostat t.max. 180°C ø 48mm shaft ø 6x4.6mm shaft flat upper temperature range 70-180°C rotation 270°		

producer-specific knobs

VEGA



1

GEV No.	112120	Ref. No.	93052
description	knob switch zero mark ø 40mm		



1

GEV No.	110650	Ref. No.	93052
description	knob switch zero mark ø 40mm shaft ø 6x4.6mm shaft flat lower black		



1

GEV No.	110657	Ref. No.	93052
description	knob switch zero mark t.max.°C temperature range°C ø 40mm shaft ø 6x4.6mm shaft flat lower black		



1

GEV No.	112121	Ref. No.	93314
description	knob thermostat t.max. 180°C ø 48mm shaft ø 6x4.6mm shaft flat upper temperature range 70-180°C rotation 270°		

fittings for catering equipment

outlet taps

universal



1

GEV No.	540699	Ref. No.	93038
description	outlet tap W 35mm H 35mm thread 3/4" IT		

C

control thermostats 5,5

E

energy regulators 5

H

heating elements 3

heating elements for bain maries 3

heating elements for contact grills 4

heating elements for fryers 3

heating elements for griddles 3

heating elements for heated cabinets 4

heating elements for pizza ovens 4

heating elements for rechauds 4

I

indicator lights 6

indicator lights (complete) 6

L

lamps 6

M

mechanical timers 6

microswitches 6

Q

quartz heating elements 4

R

rocker/momentary rocker switches 6

S

safety thermostats 5

switches and momentary switches 6

T

thermostats 5

timers 6