



GAS COMPONENTS



ELECTRIC COMPONENTS



WATER TECHNOLOGY



MECHANICAL COMPONENTS



TOOLS

Spare parts suitable for

VULCAN

Find the complete and up-to-date range of products in our GEV Webshop



Manufacturer catalogue

The most important spare parts and accessories arranged clearly for every manufacturer

- ✓ Complete product range and all appliance data always up to date in the GEV Webshop
- ✓ Alphabetical Index at the end of the catalogue

GEV Webshop

www.gev-online.co.uk

www.gev-online.com



- 🔍 Add to Favourites
- 🔍 Sign In with email address and usual password
- 🔍 Easy-order – place several items in your basket at the same time
- 🔍 Quick Item search – no login needed



switches and momentary switches

rocker/momentary rocker switches

37x21mm



1

GEV No.	348098 ¹	Ref. No.	00-358628-00001 358628-00001 358628-1
description	rocker switch mounting measurements 37x21mm black 2CO 250V 10A with neutral position connection male faston 6.3mm ambient temperature max. 125/55°C protection IP55		

¹with neutral position

lamps

indicator lights

indicator lights (complete)

ø12mm

with plug-in socket



1

GEV No.	580014	Ref. No.	843808 844367-7
description	indicator light ø 12mm 230V red		

contactors

HARTLAND

power contactors

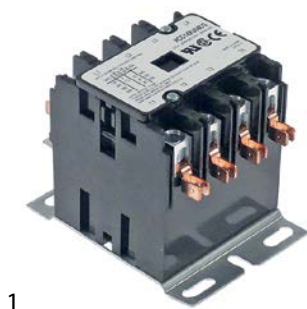

1

GEV No.	580012	Ref. No.	111497D3 411497D3 844329 853270
description	contactor resistive load 50A 240VAC 40A/10HP (AC3/240V) 40A/7.46kW main contacts 4NO connection screw clamp/male faston 6.3mm type HCCY4XU04CG		

gas valves and ignition boxes

gas control valves

ROBERTSHAW

electric controlled valves



1

GEV No.	101429	Ref. No.	470841-3
description	gas valve 120V 50/60Hz gas inlet 3/4" gas outlet 3/4" thermo-couple connection 3/8" NEF pilot connection 1/4" pipe US type 7000BMSER-120 pressure controller natural gas 3.5" W.C. suitable for ROBERTSHAW		
spare parts for	101429		
	GEV No.	101047	Ref. No. —
	magnet unit T1: ASA 11/32 T2: M24x1 L 59mm ø 4mm suitable for ROBERTSHAW		
	GEV No.	101389	Ref. No. —
	pressure controller natural gas suitable for ROBERTSHAW		
	GEV No.	580033	Ref. No. —
	knob suitable for ROBERTSHAW		
accessories for	101429		
	GEV No.	580035	Ref. No. 110839-1 410839-1
	thermopile L 36" - 915mm probe ø 9mm probe L 38mm 250-750mV screw connection 7/16" connection 3/8" NEF		

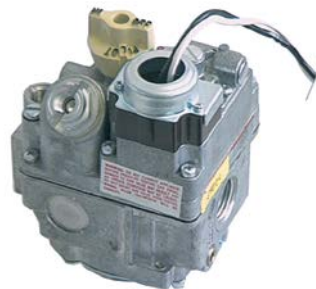





1

GEV No.	580044	Ref. No.	110841-3 410841-00003 410841-3
description	gas valve supply 120VAC 50/60Hz gas inlet 3/4" NPT gas outlet 3/4" NPT thermocouple connection 11/32" pilot connection 1/4" CCT type 7000BER-120 pressure controller natural gas 3.5" W.C. suitable for ROBERTSHAW		
spare parts for	580044		
	GEV No.	101047	Ref. No. —
	magnet unit T1: ASA 11/32 T2: M24x1 L 59mm ø 4mm suitable for ROBERTSHAW		
	GEV No.	101389	Ref. No. —
	pressure controller natural gas suitable for ROBERTSHAW		





Table continues overleaf



spare parts for 580044			
	GEV No.	106109	Ref. No. —
	locking screw thread 7/16"-24 UNS for pipe ø 1/4" L 16mm brass Qty 1 pcs WS 7/16" (11.113mm) hole ø 6.4mm		
	GEV No.	580033	Ref. No. —
	knob suitable for ROBERTSHAW		
accessories for 580044			
	GEV No.	102122	Ref. No. —
	thermocouple ROBERTSHAW ASA 11/32 L 18" - 455mm 7/16"		
	GEV No.	102277	Ref. No. —
	thermocouple ROBERTSHAW ASA 11/32 L 36" - 915mm 7/16"		

gas controlled valves



1			
GEV No.	580043	Ref. No.	110841-1 410841-1
description	gas valve supply Operator gas inlet 1/4" CCT outlet 1/4" CCT gas inlet 3/4" NPT gas outlet 3/4" NPT thermocouple connection 3/8" NEF pilot connection 1/4" CCT type 7000BMSGOR pressure controller natural gas 3.5" W.C. suitable for ROBERTSHAW		
spare parts for 580043			
	GEV No.	101042	Ref. No. —
	magnet unit T1: 3/8" NEF suitable for ROBERTSHAW for gas operator		
	GEV No.	101481	Ref. No. —
	olive for pipe ø 1/4" CCT Qty 1 pcs		
	GEV No.	106109	Ref. No. —
	locking screw thread 7/16"-24 UNS for pipe ø 1/4" L 16mm brass Qty 1 pcs WS 7/16" (11.113mm) hole ø 6.4mm		
	GEV No.	580033	Ref. No. —
	knob suitable for ROBERTSHAW		
accessories for 580043			
	GEV No.	580035	Ref. No. 110839-1 410839-1
	thermopile L 36" - 915mm probe ø 9mm probe L 38mm 250-750mV screw connection 7/16" connection 3/8" NEF		

ignition parts

pilot burners

ROBERTSHAW

pilot burners

universal series - type 2

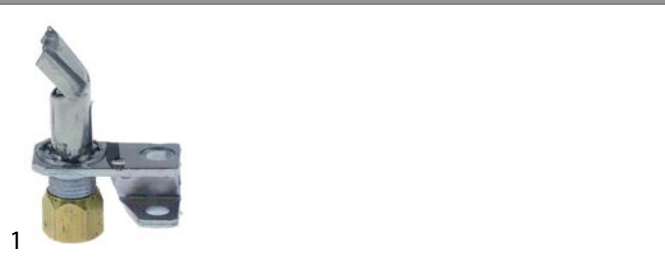

1	
GEV No.	107402
Ref. No.	109839-1 109839-3 409839-1 409839-3 409839-3 (LP) / 409839-1 (NAT)
description	pilot burner ROBERTSHAW type 2C-2 1 flame natural/liquid gas code 18/10 for pipe ø 1/4" CCT



1	
GEV No.	100117
Ref. No.	112787-1 412787-1 412787-1 (NAT)
description	pilot burner ROBERTSHAW type 2CH-1 1 flame natural gas code 18 for pipe ø 1/4" CCT

accessories for 100117			
	GEV No.	100275	Ref. No. 109839-6
	pilot burner nozzle LPG code 10 bore ø 0.1mm suitable for ROBERTSHAW		
	GEV No.	100276	Ref. No. —
	pilot burner nozzle natural gas code 18 suitable for ROBERTSHAW		
	GEV No.	100277	Ref. No. —
	pilot burner nozzle natural gas code 26 suitable for ROBERTSHAW		
	GEV No.	101286	Ref. No. —
	olive ID ø 6mm Qty 1 pcs		
	GEV No.	101481	Ref. No. —
	olive for pipe ø 1/4" CCT Qty 1 pcs		
	GEV No.	101483	Ref. No. —
	union nut thread 1/4" CCT short		







universal series - type 3

 <p>1</p>			
GEV No.	107398	Ref. No.	112082-1 112082-2 412082-1 412082-1 (NAT) / 412082-2 (LP)
description	pilot burner ROBERTSHAW type 3CH-10 2 flames natural/liquid gas code 16/10 for pipe ø 1/4" CCT		
spare parts for	107398		
	GEV No.	100275	Ref. No. 109839-6
pilot burner nozzle LPG code 10 bore ø 0.1mm suitable for ROBERTSHAW			
	GEV No.	106105	Ref. No. —
pilot burner nozzle LPG code 16 suitable for ROBERTSHAW			

universal series - type 6

Width of caps:
 6CH10 = 1" (25,4mm)
 6CH14 = 1½" (38,1mm)
 6CH24 = 2½" (63,5mm)
 6CH30 = 3" (76,2mm)

 <p>1</p>			
GEV No.	106346	Ref. No.	112212-1 412212-1
description	pilot burner ROBERTSHAW type 6CH14-10 3 flames natural gas code 22 for pipe ø 1/4" CCT gas connection 1/4" CCTmm		

 <p>1</p>			
GEV No.	107396	Ref. No.	805925-11 F5925-11
description	pilot burner ROBERTSHAW type 6CH24-6 3 flames natural/liquid gas code 16/26 for pipe ø 1/4" CCT		
spare parts for	107396		
	GEV No.	100277	Ref. No. —
pilot burner nozzle natural gas code 26 suitable for ROBERTSHAW			
	GEV No.	106105	Ref. No. —
pilot burner nozzle LPG code 16 suitable for ROBERTSHAW			

11EA series

 <p>1</p>			
GEV No.	107412	Ref. No.	00-409125-00001 00-409125-00003 109125-1 109125-3 409125-1 409125-3 729125-1 729125-3
description	pilot burner ROBERTSHAW type 11EA 1 flame natural gas for pipe ø 3/16" - 1/4" CCT		

Mini Pilot series

 <p>1</p>			
GEV No.	107414	Ref. No.	2693 802693
description	pilot burner ROBERTSHAW type 2 2 flames natural/liquid gas code for pipe ø 3/16" - 1/4" CCT with thermocouple		

producer-specific pilot burners

VULCAN HART

 <p>1</p>			
GEV No.	107391	Ref. No.	00-410662-000G1 110662G1 112071G1 112073G1 113866G1 410662G1 412071G1 412073G1 421573G4
description	pilot burner 4 flames 3/16"		



1

GEV No.	107413	Ref. No.	00-414645-0001 114645-1 414645-1
description	pilot burner type 43U4		

thermocouples

thermocouple sets universal



1

GEV No.	102281	Ref. No.	00-412788-0001 112788-1 20040 412788-1 920040
description	thermocouple set ROBERTSHAW 5-piece L 24" - 610mm		



1

GEV No.	103236	Ref. No.	00-722248
description	thermocouple set ROBERTSHAW 5-piece L 60" - 1525mm ASA 11/32		

thermopiles

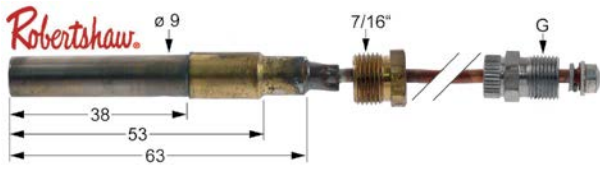

1

GEV No.	580035	Ref. No.	110839-1 410839-1
description	thermopile L 36" - 915mm probe \varnothing 9mm probe L 38mm 250-750mV screw connection 7/16" connection 3/8" NEF		

accessories

interrupters



1

GEV No.	580046	Ref. No.	00-410838-000G1 110838G1 410838G1
description	extension for interruptor L 18" - 455mm		

gas nozzles

pilot burner nozzles

pilot burner nozzles ROBERTSHAW



1

GEV No.	100275	Ref. No.	109839-6
description	pilot burner nozzle LPG code 10 bore \varnothing 0.1mm suitable for ROBERTSHAW		

hinges

overlying hinges

miscellaneous

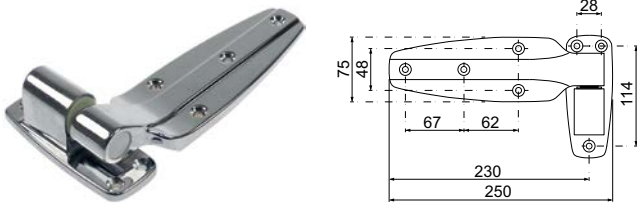

1

GEV No.	701446	Ref. No.	138057-14 430900-1-5
description	hinge overall height 54mm with gradient total length 250mm W 75mm		

baskets

fryer baskets

US producers



1

GEV No.	970183	Ref. No.	OY420563-1
description	fryer basket L1 308mm W1 160mm H1 135mm		



			
1			
GEV No.	970184	Ref. No.	110782-1 111378-2 410782-1 411378-2 420581-1 4900
description	fryer basket L1 330mm W1 315mm H1 135mm		

			
1			
GEV No.	970182	Ref. No.	108654-1 110737-1 110737-7 408654-1 410737-1 410737-7 4712 804712
description	fryer basket L1 340mm W1 165mm H1 150mm L2 620mm H2 280mm		

C

contactors 3

G

gas control valves 3

gas nozzles 6

I

indicator lights 3

indicator lights (complete) 3

L

lamps 3

O

overlying hinges 6

P

pilot burners 4

R

rocker/momentary rocker switches 3

S

switches and momentary switches 3

T

thermocouples 6