



**GAS COMPONENTS**



**ELECTRIC COMPONENTS**



**WATER TECHNOLOGY**



**MECHANICAL COMPONENTS**



**TOOLS**

Spare parts suitable for

**WAMSLER**

Find the complete and up-to-date range of products in our GEV Webshop



# Manufacturer catalogue

The most important spare parts and accessories arranged clearly for every manufacturer

- ✓ Complete product range and all appliance data always up to date in the GEV Webshop
- ✓ Alphabetical Index at the end of the catalogue

## GEV Webshop

[www.gev-online.co.uk](http://www.gev-online.co.uk)

[www.gev-online.com](http://www.gev-online.com)



- 🔍 Add to Favourites
- 🔍 Sign In with email address and usual password
- 🔍 Easy-order – place several items in your basket at the same time
- 🔍 Quick Item search – no login needed



## heating elements

### heating elements for fryers



<b>GEV No.</b>	418630	<b>Ref. No.</b>	00011110092 0783408030
<b>description</b>	heating element 6900W 400V heating circuits 3 L 375mm W 170mm H 255mm L1 105mm L2 270mm W1 35mm W2 100mm H1 230mm H2 25mm windings 12 rotation flange connection cable		

### heating elements for large hobs

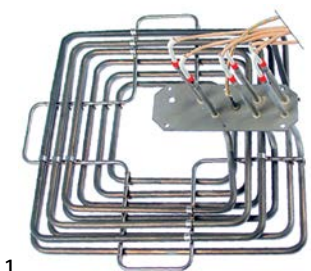

<b>GEV No.</b>	418692	<b>Ref. No.</b>	0073335100
<b>description</b>	heating element 3860W 400V heating circuits 3 L 275mm W 260mm H 47mm tube ø 6.5mm connection length 53mm cable length 1300mm		

## hot plates

### square & rectangular

#### with cast edge

#### with screw connection



<b>GEV No.</b>	490162	<b>Ref. No.</b>	0011110046
<b>description</b>	hot plate dimensions 300x300mm 4000W 230V with cast edge H 42mm connection 4 screw clamps		

## thermostats

### control and safety thermostats

#### EGO

#### control thermostats

#### 55.34\_ series



<b>GEV No.</b>	375872	<b>Ref. No.</b>	011170067
<b>description</b>	thermostat t.max. 490°C temperature range 70-490°C 3-pole 3NO 16A probe ø 3.9mm probe L 380mm capillary pipe 1180mm capillary pipe isolated 960mm gland nut shaft ø 6x4.6mm shaft L 25mm shaft position upper rotation 270° probe material copper 44mm curved		





## gas taps

### alternatives to EGA

#### GP21 series

#### with pipe outlet



<b>GEV No.</b>	101646 <sup>1</sup>	<b>Ref. No.</b>	011320055	
<b>description</b>	gas tap alternatives to EGA type GP21RD with pipe outlet with throttle screw gas inlet M15x1 (tube ø 10mm) bypass nozzle ø 0.35mm gas outlet M17x1 (tube ø 10mm) thermocouple connection M8x1 pilot connection M10x1 shaft ø 6x4.6mm shaft L 31/23mm shaft flat upper			
<b>spare parts for</b>	101646			
	<b>GEV No.</b>	100408	<b>Ref. No.</b>	—
	bypass nozzle type PEL20/21 bore ø 0.35mm thread M5x0.5			
	<b>GEV No.</b>	101060	<b>Ref. No.</b>	—
	magnet unit standard L 39mm D1 ø 15.4mm D2 ø 11mm suitable for PEL20-21/JUNKERS/EGA			
	<b>GEV No.</b>	101230	<b>Ref. No.</b>	—
	thermocouple nut T1: M8x1 T2: M18x1 aluminium			
	<b>GEV No.</b>	101526	<b>Ref. No.</b>	—
	O-ring Viton thickness 1.78mm ID ø 4.48mm Qty 1 pcs			
	<b>GEV No.</b>	101552	<b>Ref. No.</b>	—
	throttle screw thread M8x0.75			

<sup>1</sup>with reducer for main gas line  
Table continues overleaf

accessories for		101646	
	GEV No.	100908	Ref. No. —
union screw thread M10x1 for pipe ø 4mm Qty 1 pcs			
	GEV No.	100909	Ref. No. —
union screw thread M10x1 for pipe ø 6mm Qty 1 pcs			
	GEV No.	100926	Ref. No. —
centring piece thread M17x1			
	GEV No.	100942	Ref. No. —
union nut thread M15x1 for pipe ø 10mm			
	GEV No.	101246	Ref. No. —
olive for pipe ø 4mm Qty 1 pcs			
	GEV No.	101278	Ref. No. —
olive for pipe ø 10mm Qty 1 pcs			
	GEV No.	101286	Ref. No. —
olive ID ø 6mm Qty 1 pcs			
	GEV No.	110078	Ref. No. —
knob without symbol ø 70mm shaft ø 6x4.6mm shaft flat universal			
	GEV No.	112206	Ref. No. —
knob dial plate silver gas tap PEL21/22/23 t.max.°C ED ø 63mm ID ø 45.5mm			

## ignition parts

### thermocouples

#### plug-in thermocouples

#### plug-in thermocouples standard

#### with barrel socket ø6mm

#### type Junkers with aluminised tip

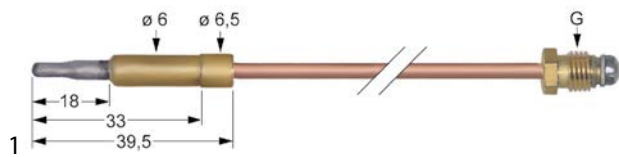



<b>GEV No.</b>	102219	<b>Ref. No.</b>	0011170027
<b>description</b>	thermocouple M8x1 L 450mm plug connection ø6.0mm		

### threaded thermocouples

#### threaded thermocouples standard

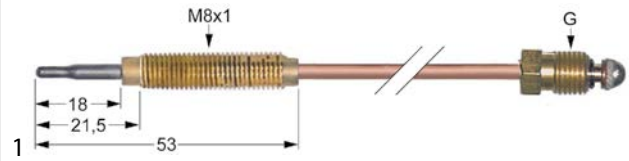
#### threaded thermocouples (miscellaneous)



<b>GEV No.</b>	102055	<b>Ref. No.</b>	011170007
<b>description</b>	thermocouple M8x1 L 450mm M8x1		
<b>accessories for</b>	102055		
	GEV No.	102067	Ref. No. —
nut thread M8x1 H 3mm brass Qty 1 pcs type SEF 1			

## gas burners

### accessories

#### nozzle holders

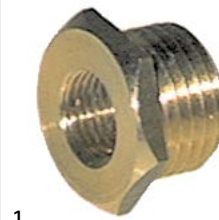

<b>GEV No.</b>	101369	<b>Ref. No.</b>	011600905
<b>description</b>	nozzle holder ET 3/8" IT M10x1 WS 19		

## gas nozzles

### pilot burner nozzles

#### pilot burner nozzles EGA



<b>GEV No.</b>	102793	<b>Ref. No.</b>	00820337700
<b>description</b>	pilot burner nozzle LPG bore ø 0.23mm Qty 1 pcs		



<b>GEV No.</b>	102792	<b>Ref. No.</b>	800337600
<b>description</b>	pilot burner nozzle natural gas bore ø 0.35mm Qty 1 pcs		



pilot burner nozzles JUNKERS

CB 50203\_/503\_ series



1

<b>GEV No.</b>	100222	<b>Ref. No.</b>	0011320009
<b>description</b>	pilot burner nozzle LPG gas pressure 50mbar code 5 Qty 1 pcs suitable for JUNKERS CB50203_		



1

<b>GEV No.</b>	100227	<b>Ref. No.</b>	0011320008
<b>description</b>	pilot burner nozzle natural gas gas pressure 25mbar code 6 Qty 1 pcs suitable for JUNKERS CB50203_		

internal nozzles

internal nozzles for EGA gas taps/nozzle holders

EGA 24197/24362



1

<b>GEV No.</b>	100340	<b>Ref. No.</b>	880331110
<b>description</b>	internal nozzle bore $\varnothing$ 0.85mm type EGA/PEL22		

baskets

fryer baskets

WAMSLER



1

<b>GEV No.</b>	970168	<b>Ref. No.</b>	N/A
<b>description</b>	fryer basket L1 305mm W1 170mm H1 120mm SS		



**C**

control thermostats 3

**G**

gas burners 4

gas nozzles 4

gas taps 3

**H**

heating elements 3

heating elements for fryers 3

heating elements for large hobs 3

hot plates 3

**T**

thermocouples 4

thermostats 3