



**GAS COMPONENTS**



**ELECTRIC COMPONENTS**



**WATER TECHNOLOGY**



**MECHANICAL COMPONENTS**



**TOOLS**

Spare parts suitable for

**WHIRLPOOL**

Find the complete and up-to-date range of products in our GEV Webshop



# Manufacturer catalogue

The most important spare parts and accessories arranged clearly for every manufacturer

- ✓ Complete product range and all appliance data always up to date in the GEV Webshop
- ✓ Alphabetical Index at the end of the catalogue

## GEV Webshop

[www.gev-online.co.uk](http://www.gev-online.co.uk)

[www.gev-online.com](http://www.gev-online.com)









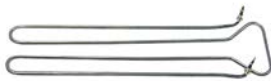

- 🔍 Add to Favourites
- 🔍 Sign In with email address and usual password
- 🔍 Easy-order – place several items in your basket at the same time
- 🔍 Quick Item search – no login needed



## heating elements

### heating elements for ovens

			
1			
<b>GEV No.</b>	415078	<b>Ref. No.</b>	771985002864
<b>description</b>	heating element 1500W 240V L 540mm W 150mm H 28mm 2 hole fixing mounting distance 145mm connection M4 tube ø 6.25mm dry heating element thread M10x1 heating circuits 1		
<b>accessories for</b>	415078		
	<b>GEV No.</b>	510416	<b>Ref. No.</b> —
	flat gasket fibre ED ø 19mm ID ø 10.5mm thickness 1.5mm for thread M10 Qty 1 pcs		
	<b>GEV No.</b>	510893	<b>Ref. No.</b> —
	O-ring EPDM thickness 2.62mm ID ø 9.92mm Qty 1 pcs		
	<b>GEV No.</b>	520231	<b>Ref. No.</b> —
	nut thread M10x1 H 6mm WS 14 zinc-coated steel Qty 1 pcs		
	<b>GEV No.</b>	521103	<b>Ref. No.</b> —
	nut thread M4 H 3mm WS 7 brass Qty 20 pcs		
	<b>GEV No.</b>	521104	<b>Ref. No.</b> —
	washer ID ø 4.3mm ED ø 8mm thickness 0.5mm brass Qty 20 pcs for thread M4		
	<b>GEV No.</b>	560111	<b>Ref. No.</b> —
	plain washer ID ø 4.3mm ED ø 9mm thickness 0.8mm SS Qty 20 pcs DIN 125A for thread M4		
	<b>GEV No.</b>	560131	<b>Ref. No.</b> —
	hexagonal nut thread M4 H 3.2mm WS 7 SS DIN/ISO DIN 934 / ISO 4032/8673 Qty 20 pcs		

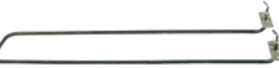
			
1			
<b>GEV No.</b>	416043	<b>Ref. No.</b>	483286009614
<b>description</b>	heating element 990W 230V L 475mm W 106mm H 24mm lug length 55mm lug width 18mm hole distance 138mm hole ø 5mm tube ø 6.3mm connection M4 heating circuits 1 bracket mounting oven		





### heating elements for frying pans



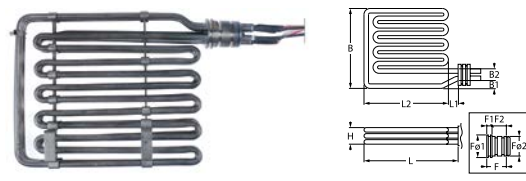

			
1			
<b>GEV No.</b>	415184	<b>Ref. No.</b>	771985003774
<b>description</b>	heating element 2000W 230V heating circuits 1 L 570mm W 86mm connection length 24mm connection M5 tube ø 8.5mm dry heating element griddle H 87mm		

## heating elements for fryers

### off-center connection

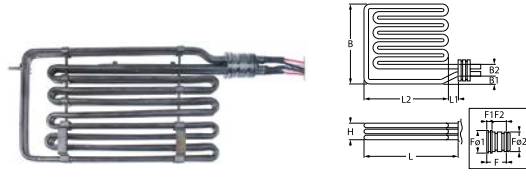
#### with retaining rings

			
1			
<b>GEV No.</b>	416408	<b>Ref. No.</b>	483286009367
<b>description</b>	heating element 12000W 230/400V heating circuits 3 mounting pos. left L 280mm W 225mm H 32mm flange length 45mm flange length 1 9.6mm flange length 2 35.4mm flange ø1 44.5mm flange ø2 39.5mm thermostat sleeves ø 7mm length thermostat sleeves 280mm number of thermostat sleeves 1 thermostat sleeve eccentric, non clinging windings 5 L1 10mm L2 270mm W1 13mm W2 31mm tube ø 8.5mm cable length 600mm rotation flange fryer connection length 50mm		
<b>accessories for</b>	416408		
	<b>GEV No.</b>	510899	<b>Ref. No.</b> 483286009314
	O-ring EPDM thickness 3.53mm ID ø 37.69mm Qty 1 pcs		
	<b>GEV No.</b>	528155	<b>Ref. No.</b> —
	O-ring Viton thickness 3.53mm ID ø 32.93mm Qty 1 pcs		
	<b>GEV No.</b>	532545	<b>Ref. No.</b> —
	O-ring Viton thickness 3.53mm ID ø 49.21mm Qty 1 pcs		
	<b>GEV No.</b>	691621	<b>Ref. No.</b> —
	retaining ring shaft ø 40mm thickness 1.8mm steel DIN 471		

			
1			
<b>GEV No.</b>	416407	<b>Ref. No.</b>	483286009359
<b>description</b>	heating element 15000W 230/400V heating circuits 3 mounting pos. left L 355mm W 190mm H 32mm flange length 45mm flange length 1 9.6mm flange length 2 35.4mm flange ø1 44.5mm flange ø2 39.5mm thermostat sleeves ø 7mm length thermostat sleeves 280mm number of thermostat sleeves 1 thermostat sleeve eccentric, clinging windings 4 L1 15mm L2 340mm W1 13mm W2 32mm tube ø 8.5mm cable length 570mm rotation flange connection length 60mm		
<b>accessories for</b>	416407		
	<b>GEV No.</b>	510899	<b>Ref. No.</b> 483286009314
	O-ring EPDM thickness 3.53mm ID ø 37.69mm Qty 1 pcs		
	<b>GEV No.</b>	528155	<b>Ref. No.</b> —
	O-ring Viton thickness 3.53mm ID ø 32.93mm Qty 1 pcs		
	<b>GEV No.</b>	532545	<b>Ref. No.</b> —
	O-ring Viton thickness 3.53mm ID ø 49.21mm Qty 1 pcs		
	<b>GEV No.</b>	691621	<b>Ref. No.</b> —
	retaining ring shaft ø 40mm thickness 1.8mm steel DIN 471		



<b>GEV No.</b>	415354	<b>Ref. No.</b>	771985003588
<b>description</b>	heating element 1500W 230V heating circuits 1 L 375mm W 26mm H 275mm rectangular flange connection M4 fryer heaters L1 20mm L2 75mm L3 280mm H1 118mm H2 115mm H3 42mm hole distance 22mm hole ø 6mm flange length 33mm flange width 41mm tube ø 8.5mm		

<b>2 hole fixing</b>			
<b>GEV No.</b>	416648	<b>Ref. No.</b>	771985009698
<b>description</b>	heating element 3000W 230V heating circuits 1 L 315mm W 185mm H 180mm L1 28mm L2 277mm thread 1/4" mounting distance 174mm tube ø 8.5mm windings 6 2 hole fixing connection male faston 6.3mm fryer heaters		
<b>accessories for</b>	416648		
	<b>GEV No.</b>	361182	<b>Ref. No.</b> —
	nut thread 1/4" H 5mm nickel-plated brass WS 17 Qty 1 pcs		
	<b>GEV No.</b>	510417	<b>Ref. No.</b> —
	flat gasket fibre ED ø 20mm ID ø 14mm thickness 2mm Qty 1 pcs		
	<b>GEV No.</b>	520228	<b>Ref. No.</b> —
	tooth lock washer ID ø 15.3mm ED ø 24mm steel Qty 1 pcs for thread M14		
	<b>GEV No.</b>	550262	<b>Ref. No.</b> —
	flat gasket copper ED ø 20mm ID ø 14mm thickness 2mm		

<b>heating elements for griddles</b>			
<b>GEV No.</b>	415079	<b>Ref. No.</b>	771985002659 771985002682
<b>description</b>	heating element 1250W 230V heating circuits 1 L 473mm W 52mm H 43mm tube ø 8.5mm griddle connection distance 44mm dry heating element		

<b>GEV No.</b>	416985	<b>Ref. No.</b>	771985000474
<b>description</b>	heating element 1250W 230V heating circuits 1 L 482mm W 54mm H 55mm tube ø 8.5mm connection male faston 6.3mm connection distance 46mm dry heating element		

<b>GEV No.</b>	416046	<b>Ref. No.</b>	483286009373
<b>description</b>	heating element 2350/2560W 220/240V heating circuits 1 L 590mm W 77mm H 80mm tube ø 8.5mm dry heating element		

## heating elements for refrigeration

<b>heating elements for defrosting</b>			
<b>GEV No.</b>	420449	<b>Ref. No.</b>	182733
<b>description</b>	heating element 160W 220V L 370mm W 60mm H 8.5mm cable length 1190mm tube ø 8.5mm refrigeration connection F6.3		

<b>GEV No.</b>	420450	<b>Ref. No.</b>	771985005004
<b>description</b>	heating element 335W 220V L 255mm W 315mm H 35mm cable length 980mm tube ø 8.5mm refrigeration		

<b>GEV No.</b>	419025	<b>Ref. No.</b>	183530
<b>description</b>	heating element 400W 230V L 440mm W 70mm H 100mm cable length 500mm tube ø 8.5mm		

<b>GEV No.</b>	419101	<b>Ref. No.</b>	208017
<b>description</b>	heating element 450W 230V L 380mm W 37mm H 100mm cable length 1100mm tube ø 8.5mm immersion heater		

<b>GEV No.</b>	420452	<b>Ref. No.</b>	182279 771985004825
<b>description</b>	heating element 540W 220V L 305mm W 695mm H 10mm cable length 985mm tube ø 8.5mm refrigeration		



<b>GEV No.</b>	420447	<b>Ref. No.</b>	182731
<b>description</b>	heating element 95W 230V L 425mm W 48mm H 120mm cable length 1200mm tube ø 8.5mm refrigerated counter		

### heating elements for condensate evaporation



<b>GEV No.</b>	418996	<b>Ref. No.</b>	208134
<b>description</b>	heating element 95W 220V L 435mm W 56mm H 28mm cable length 3000mm tube ø 6.25mm		



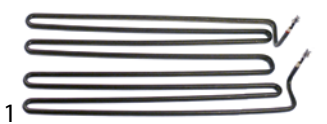

### heating elements for tilting bratt pan







<b>GEV No.</b>	417344	<b>Ref. No.</b>	483286009389
<b>description</b>	heating element tilting bratt pan 4700W 230V L 540mm W 210mm H 60mm heating circuits 1 tube ø 8.5mm W1 70mm W2 70mm		

### heating elements for pasta cookers









<b>GEV No.</b>	416408	<b>Ref. No.</b>	483286009367
<b>description</b>	heating element 12000W 230/400V heating circuits 3 mounting pos. left L 280mm W 225mm H 32mm flange length 45mm flange length 1 9.6mm flange length 2 35.4mm flange ø1 44.5mm flange ø2 39.5mm thermostat sleeves ø 7mm length thermostat sleeves 280mm number of thermostat sleeves 1 thermostat sleeve eccentric, non clinging windings 5 L1 10mm L2 270mm W1 13mm W2 31mm tube ø 8.5mm cable length 600mm rotation flange fryer connection length 50mm		
<b>accessories for</b>	416408		
	<b>GEV No.</b>	510899	<b>Ref. No.</b> 483286009314
	O-ring EPDM thickness 3.53mm ID ø 37.69mm Qty 1 pcs		
	<b>GEV No.</b>	528155	<b>Ref. No.</b> —
	O-ring Viton thickness 3.53mm ID ø 32.93mm Qty 1 pcs		
	<b>GEV No.</b>	532545	<b>Ref. No.</b> —
	O-ring Viton thickness 3.53mm ID ø 49.21mm Qty 1 pcs		
	<b>GEV No.</b>	691621	<b>Ref. No.</b> —
	retaining ring shaft ø 40mm thickness 1.8mm steel DIN 471		



<b>GEV No.</b>	416407	<b>Ref. No.</b>	483286009359
<b>description</b>	heating element 15000W 230/400V heating circuits 3 mounting pos. left L 355mm W 190mm H 32mm flange length 45mm flange length 1 9.6mm flange length 2 35.4mm flange ø1 44.5mm flange ø2 39.5mm thermostat sleeves ø 7mm length thermostat sleeves 280mm number of thermostat sleeves 1 thermostat sleeve eccentric, clinging windings 4 L1 15mm L2 340mm W1 13mm W2 32mm tube ø 8.5mm cable length 570mm rotation flange connection length 60mm		
<b>accessories for</b>	416407		
	<b>GEV No.</b>	510899	<b>Ref. No.</b> 483286009314
	O-ring EPDM thickness 3.53mm ID ø 37.69mm Qty 1 pcs		
	<b>GEV No.</b>	528155	<b>Ref. No.</b> —
	O-ring Viton thickness 3.53mm ID ø 32.93mm Qty 1 pcs		
	<b>GEV No.</b>	532545	<b>Ref. No.</b> —
	O-ring Viton thickness 3.53mm ID ø 49.21mm Qty 1 pcs		
	<b>GEV No.</b>	691621	<b>Ref. No.</b> —
	retaining ring shaft ø 40mm thickness 1.8mm steel DIN 471		



<b>GEV No.</b>	418651	<b>Ref. No.</b>	483286000159
<b>description</b>	heating element 1500W 230V heating circuits 1 L 300mm W 51mm 2 hole fixing connection male faston 6.3mm thread M14x1 tube ø 8.5mm mounting distance 43mm pasta cooker immersion heater		
<b>spare parts for</b>	418651		
	<b>GEV No.</b>	507313	<b>Ref. No.</b> —
	O-ring EPDM thickness 2.62mm ID ø 13.95mm Qty 1 pcs		
<b>accessories for</b>	418651		
	<b>GEV No.</b>	510417	<b>Ref. No.</b> —
	flat gasket fibre ED ø 20mm ID ø 14mm thickness 2mm Qty 1 pcs		
	<b>GEV No.</b>	520228	<b>Ref. No.</b> —
	tooth lock washer ID ø 15.3mm ED ø 24mm steel Qty 1 pcs for thread M14		
	<b>GEV No.</b>	521133	<b>Ref. No.</b> —
	nut thread M14x1.5 H 6mm WS 19 zinc-coated steel Qty 1 pcs		
	<b>GEV No.</b>	550261	<b>Ref. No.</b> —
	nut thread M14x1 H 4mm WS 19 SS Qty 1 pcs		
	<b>GEV No.</b>	550262	<b>Ref. No.</b> —
	flat gasket copper ED ø 20mm ID ø 14mm thickness 2mm		



## heating elements for pizza ovens

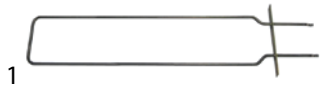

<b>GEV No.</b>	415917	<b>Ref. No.</b>	104152
<b>description</b>	heating element 1400W 230V L 572mm W 159mm flange length 220mm flange width 32mm hole distance 199mm connection length 134mm connection M5 L1 30mm L2 27mm L3 515mm W1 25mm W2 110mm tube ø 10.2mm heating circuits 1 rectangular flange hole ø 4mm dry heating element		

## heating elements for salamanders/toast-



<b>GEV No.</b>	416050	<b>Ref. No.</b>	483286002058
<b>description</b>	heating element 1600W 220V heating circuits 1 L 304mm W 208mm H 50mm W1 94mm W2 30mm flange length 70mm flange width 22mm hole distance 56mm cable length 1480mm connection cable tube ø 6.3mm connection length 29mm hole ø 6mm rectangular flange dry heating element		

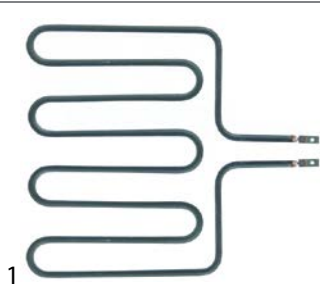

<b>GEV No.</b>	416579	<b>Ref. No.</b>	771985003375
<b>description</b>	heating element 1900W 220V heating circuits 1 L 245mm W 240mm L1 63mm L2 182mm W1 98mm W2 45mm connection distance 16mm connection M4 dry heating element tube ø 6.3mm H 6.3mm		

## heating elements for heated trolleys

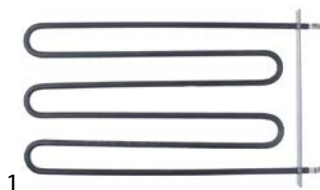

<b>GEV No.</b>	419130	<b>Ref. No.</b>	153577
<b>description</b>	heating element 1500W 230V L 388mm W 208mm connection M4 tube ø 8.5mm heating circuits 1 hole distance 230mm flange length 245mm flange width 20mm hole ø 6mm		

## heating cables

## connection on both sides

## with wire end ferrules



<b>GEV No.</b>	420385	<b>Ref. No.</b>	483286000023
<b>description</b>	heating cable 23W 220V L 4500mm for blast chiller		



<b>GEV No.</b>	420386	<b>Ref. No.</b>	483286002824
<b>description</b>	heating cable 32W 220V L 4450mm for blast chiller		

## heating cartridges



<b>GEV No.</b>	417227	<b>Ref. No.</b>	183814
<b>description</b>	heating cartridge 90W 230V ø 12mm L 124mm thread 3/8" cable length 4000mm H mm W mm condensate evaporation		

## immersion heating elements

## 3 hole flange ø38.5mm



<b>GEV No.</b>	416263	<b>Ref. No.</b>	483286008132
<b>description</b>	heating element 2600W 230V mounting ø 38.5mm heating circuits 1 L 293mm W 26mm H 26mm number of thermostat sleeves 1 thermostat sleeves ø 7mm length thermostat sleeves 260mm thermostat sleeve not clinging tube ø 6.3mm hole distance 57mm hole ø 10mm 3 hole flange connection male faston 6.3mm immersion heater		

<b>spare parts for</b>	416263		
<b>GEV No.</b>	521120	<b>Ref. No.</b>	483286008139



O-ring EPDM thickness 5.34mm ID ø 37.47mm Qty 1 pcs

<b>accessories for</b>	416263		
<b>GEV No.</b>	532577	<b>Ref. No.</b>	—



O-ring EPDM thickness 5.34mm ID ø 40.65mm Qty 1 pcs



**3 hole flange ø47.5mm**





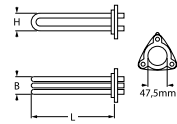

**1**

<b>GEV No.</b>	416130	<b>Ref. No.</b>	149371
<b>description</b>	heating element 2800W 230V mounting ø 47.5mm heating circuits 1 L 310mm W 8.5mm H 39mm tube ø 8.5mm hole distance 63mm hole ø 6mm connection male faston 6.3mm 3 hole flange immersion heater		
<b>accessories for</b>	416130		
	<b>GEV No.</b>	510408	<b>Ref. No.</b> —
	O-ring EPDM thickness 5.34mm ID ø 47mm Qty 1 pcs		
	<b>GEV No.</b>	510562	<b>Ref. No.</b> —
	O-ring silicone thickness 5.34mm ID ø 47mm Qty 1 pcs		



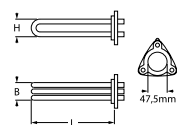

**1**

<b>GEV No.</b>	418126	<b>Ref. No.</b>	771985002940
<b>description</b>	heating element 7500W 220V mounting ø 47.5mm heating circuits 3 L 550mm W 37mm H 37mm number of thermostat sleeves 1 thermostat sleeves ø 7mm length thermostat sleeves 185mm thermostat sleeve upper tube ø 6.5mm hole distance 6.5mm hole ø 10mm connection male faston 6.3mm 3 hole flange immersion heater		
<b>spare parts for</b>	418126		
	<b>GEV No.</b>	510408	<b>Ref. No.</b> —
	O-ring EPDM thickness 5.34mm ID ø 47mm Qty 1 pcs		
<b>accessories for</b>	418126		
	<b>GEV No.</b>	510562	<b>Ref. No.</b> —
	O-ring silicone thickness 5.34mm ID ø 47mm Qty 1 pcs		

**1**

<b>GEV No.</b>	416410	<b>Ref. No.</b>	483286009435
<b>description</b>	heating element 9000W 230V mounting ø 47.5mm heating circuits 3 L 395mm W 33mm H 35mm number of thermostat sleeves 1 thermostat sleeves ø 7mm length thermostat sleeves 210mm thermostat sleeve eccentric, clinging tube ø 8.5mm hole distance 63mm hole ø 8mm connection M4		
<b>accessories for</b>	416410		
	<b>GEV No.</b>	510408	<b>Ref. No.</b> —
	O-ring EPDM thickness 5.34mm ID ø 47mm Qty 1 pcs		
	<b>GEV No.</b>	510562	<b>Ref. No.</b> —
	O-ring silicone thickness 5.34mm ID ø 47mm Qty 1 pcs		

**3 hole flange ø57.5mm**



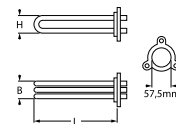

**1**

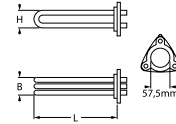
<b>GEV No.</b>	418249	<b>Ref. No.</b>	483286001218
<b>description</b>	heating element 10000W 230V mounting ø 57.5mm heating circuits 3 L 512mm W 50mm H 33mm number of thermostat sleeves 1 thermostat sleeves ø 8.5mm length thermostat sleeves 458mm thermostat sleeve eccentric, clinging tube ø 6.3mm hole distance 70mm hole ø 9mm connection length 30mm connection M4 3 hole flange immersion heater		

**1**

<b>GEV No.</b>	418779	<b>Ref. No.</b>	149992 771985010906
<b>description</b>	heating element 9000W 230V mounting ø 57.5mm heating circuits 3 L 340mm W 52mm H 54mm tube ø 8.5mm hole distance 72mm hole ø 8mm with integrated fuse INCOLOY		
<b>spare parts for</b>	418779		
	<b>GEV No.</b>	510409	<b>Ref. No.</b> —
	O-ring EPDM thickness 5.34mm ID ø 56.52mm Qty 1 pcs		

**with round flange ø47.5mm**



**1**









<b>GEV No.</b>	415652	<b>Ref. No.</b>	102751 771985000215
<b>description</b>	heating element 24000W 400V heating circuits 6 mounting ø 47.5mm L 585mm W 32mm H 35mm round flange connection male faston 6.3mm immersion heater tube ø 6.3mm connection length 86mm thermostat sleeves ø 5mm number of thermostat sleeves 1 length thermostat sleeves 155mm thermostat sleeve clinging		
<b>spare parts for</b>	415652		
	<b>GEV No.</b>	510408	<b>Ref. No.</b> —
	O-ring EPDM thickness 5.34mm ID ø 47mm Qty 1 pcs		
<b>accessories for</b>	415652		
	<b>GEV No.</b>	510408	<b>Ref. No.</b> —
	O-ring EPDM thickness 5.34mm ID ø 47mm Qty 1 pcs		
	<b>GEV No.</b>	510562	<b>Ref. No.</b> —
	O-ring silicone thickness 5.34mm ID ø 47mm Qty 1 pcs		
	<b>GEV No.</b>	520235	<b>Ref. No.</b> —
	3 hole flange hole distance 70.5mm perforation ø 6.5mm ID ø 53.5mm		
	<b>GEV No.</b>	520236	<b>Ref. No.</b> —
	flange for heating element ID ø 50mm ED ø 90mm hole ø 6.5mm 3 holes		
	<b>GEV No.</b>	550002	<b>Ref. No.</b> —
	tension strap H 10mm L 21mm W 10mm hole ø 6.5mm for heating element		

Table continues overleaf







<b>accessories for</b>	415652		
	GEV No.	550362	Ref. No. —
	blind flange ø 64mm mounting ø 47.5mm		
	GEV No.	550460	Ref. No. —
	kable set		

## with round flange ø57.5mm







<b>GEV No.</b>	420316	<b>Ref. No.</b>	248249
<b>description</b>	heating element 6000W 230V heating circuits 3 mounting ø 57.5mm L 463mm W 40mm H 40mm round flange connection male faston 6.3mm immersion heater tube ø 6.25mm thermostat sleeves ø 6.5mm number of thermostat sleeves 1 length thermostat sleeves 308mm thermostat sleeve eccentric, clinging		
<b>accessories for</b>	420316		
	GEV No.	510409	Ref. No. —
	O-ring EPDM thickness 5.34mm ID ø 56.52mm Qty 1 pcs		



<b>GEV No.</b>	416259	<b>Ref. No.</b>	4832 860 08142
<b>description</b>	heating element 1600W 230V heating circuits 1 L 275mm W 38mm H 28mm thread M10x1 mounting distance 27mm tube ø 7.1mm connection male faston 6.3mm 2 hole fixing connection length 26mm immersion heater		
<b>accessories for</b>	416259		
	GEV No.	510416	Ref. No. —
	flat gasket fibre ED ø 19mm ID ø 10.5mm thickness 1.5mm for thread M10 Qty 1 pcs		
	GEV No.	510893	Ref. No. —
	O-ring EPDM thickness 2.62mm ID ø 9.92mm Qty 1 pcs		
	GEV No.	520231	Ref. No. —
	nut thread M10x1 H 6mm WS 14 zinc-coated steel Qty 1 pcs		
	GEV No.	521129	Ref. No. —
	nut thread M10 H 6mm SS WS 17 Qty 1 pcs DIN/ISO DIN 439		





<b>GEV No.</b>	416260	<b>Ref. No.</b>	483286001391
<b>description</b>	heating element 2500W 230V heating circuits 1 L 357mm W 34mm H 39mm H1 4mm H2 35mm thread M10x1 mounting distance 28mm tube ø 6.3mm connection male faston 6.3mm 2 hole fixing immersion heater connection length 25mm		
<b>accessories for</b>	416260		
	GEV No.	510416	Ref. No. —
	flat gasket fibre ED ø 19mm ID ø 10.5mm thickness 1.5mm for thread M10 Qty 1 pcs		
	GEV No.	510893	Ref. No. —
	O-ring EPDM thickness 2.62mm ID ø 9.92mm Qty 1 pcs		
	GEV No.	520231	Ref. No. —
	nut thread M10x1 H 6mm WS 14 zinc-coated steel Qty 1 pcs		

<b>accessories for</b>	416260		
	GEV No.	521129	Ref. No. —
	nut thread M10 H 6mm SS WS 17 Qty 1 pcs DIN/ISO DIN 439		

## heating elements for convection



<b>GEV No.</b>	415966	<b>Ref. No.</b>	483286000411
<b>description</b>	heating element 2500W 230V heating circuits 1 ID ø 176mm ED ø 188mm L 210mm H 28mm L1 22mm W1 30mm H1 3mm H2 25mm flange length 70mm flange width 22mm hole distance 56mm connection male faston 6.3mm tube ø 6.3mm convection heating element hole ø 5mm rectangular flange		
<b>spare parts for</b>	415966		
	GEV No.	510368	Ref. No. —
	gasket L 70mm W 23.5mm hole ø 5mm hole distance 56mm FIBER thickness 2mm for heating element		
<b>accessories for</b>	415966		
	GEV No.	510368	Ref. No. —
	gasket L 70mm W 23.5mm hole ø 5mm hole distance 56mm FIBER thickness 2mm for heating element		







<b>GEV No.</b>	418018	<b>Ref. No.</b>	483286008226
<b>description</b>	heating element 2800W 230V heating circuits 1 ID ø 192mm L 290mm H 37mm L1 85mm W1 59mm flange length 100mm flange width 22mm hole distance 86mm ED ø 210mm connection M4 connection length 22mm tube ø 6.3mm convection heating element hole ø 5mm rectangular flange		



<b>GEV No.</b>	418019	<b>Ref. No.</b>	483286008226
<b>description</b>	heating element 3900W 230V heating circuits 3 ID ø 206mm ED ø 218mm L 275mm H 40mm L1 48mm W1 104mm H1 10mm H2 24mm flange length 142mm flange width 25mm hole distance 62.5mm connection M4 connection length 62mm tube ø 6mm convection heating element hole ø 6.5mm rectangular flange		



			
1			
<b>GEV No.</b>	415654	<b>Ref. No.</b>	771985000168
<b>description</b>	heating element 5666W 230V heating circuits 2 ID ø 465mm ED ø 480mm L 580mm H 65mm L1 90mm W1 32mm H1 34mm H2 31mm flange length 80mm flange width 45mm hole distance 56mm connection M5 connection length 108mm tube ø 8.5mm convection heating element hole ø 6mm rectangular flange		
<b>accessories for</b>	415654		
	<b>GEV No.</b>	550256	<b>Ref. No.</b> —
	gasket L 75mm W 50mm hole ø 5mm hole distance 59.5mm rubber thickness 3mm for heating element suitable for JUNO equiv. no. 55327		
	<b>GEV No.</b>	550257	<b>Ref. No.</b> 771985000169
	gasket L 137mm W 79mm thickness 3.5mm for heating element suitable for JUNO equiv. no. 02689		

			
1			
<b>GEV No.</b>	418020	<b>Ref. No.</b>	483286008722
<b>description</b>	heating element 7800W 230V heating circuits 3 ID ø 264mm ED ø 277mm L 315mm H 100mm L1 35mm W1 101mm H1 29mm H2 67mm flange length 142mm flange width 23mm hole distance 63mm connection M4 connection length 75mm tube ø 6.3mm convection heating element mounting thread M4 rectangular flange		

radiation heaters

2-circuit

			
1			
<b>GEV No.</b>	490139	<b>Ref. No.</b>	483286009165
<b>description</b>	radiation heater ø 250mm 2500W 230V heating circuits 2 energy regulation with temperature signalization partial power 1000W with ribbon heater connections 3+2 connection type male faston 6.3mm EGO		

foil heating elements

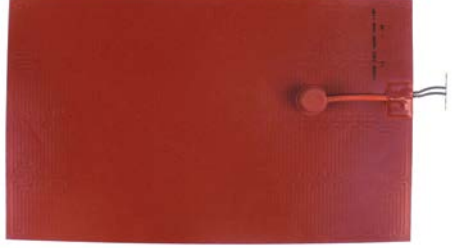
			
1			
<b>GEV No.</b>	416406	<b>Ref. No.</b>	483286009194
<b>description</b>	foil heating element L 400mm W 240mm 1000W 230V t.max. 150°C with temperature limiter silicone cable length 2000mm thickness 1mm		

hot plates

square & rectangular

with radiused edge

			
1			
<b>GEV No.</b>	490071 <sup>1</sup>	<b>Ref. No.</b>	483286009631
<b>description</b>	hot plate dimensions 300x300mm 4000W 230V with spill ring connection 4 screw clamps protector yes square		

<sup>1</sup>incl. protector

round

with radiused edge

for domestic and commercial kitchens

			
1			
<b>GEV No.</b>	490020	<b>Ref. No.</b>	483286002844
<b>description</b>	hot plate ø 220mm 2600W 230V connection 4 screw clamps with 8mm spill ring		
<b>accessories for</b>	490020		
	<b>GEV No.</b>	550796	<b>Ref. No.</b> —
	fixing plate for hot plate ø220mm		





## energy regulators

EGO

1-circuit



<b>GEV No.</b>	380015	<b>Ref. No.</b>	483286008224
<b>description</b>	energy regulator 230V 13A single-circuit turn direction right shaft $\varnothing$ 6x4.6mm shaft L 23mm mounting thread M4 power release 6-100% no. 50.57021.010		



<b>GEV No.</b>	375608	<b>Ref. No.</b>	483286008211
<b>description</b>	thermostat t.max. 265°C temperature range 50-265°C 1-pole 1NO 16A probe $\varnothing$ 3mm probe L 219mm capillary pipe 900mm capillary pipe isolated 800mm gland nut M9x1 shaft $\varnothing$ 6x4.6mm shaft L 23mm shaft position upper rotation 270°		

## thermostats

control and safety thermostats

EGO

control thermostats

55.10/19\_series



<b>GEV No.</b>	375607	<b>Ref. No.</b>	483286008707
<b>description</b>	thermostat t.max. 110°C temperature range fixed 110°C 1-pole 1CO 16A probe $\varnothing$ 3mm probe L 219mm capillary pipe 900mm capillary pipe isolated 800mm gland nut M9x1		



<b>GEV No.</b>	375237	<b>Ref. No.</b>	483286009345
<b>description</b>	thermostat t.max. 190°C temperature range 100-190°C 1-pole 1NO 16A probe $\varnothing$ 6mm probe L 130mm capillary pipe 1800mm capillary pipe isolated 1200mm gland nut M9x1 shaft L 23mm shaft position upper rotation 270°		



<b>GEV No.</b>	390068	<b>Ref. No.</b>	483286009388
<b>description</b>	thermostat t.max. 269°C temperature range 55-269°C 1-pole 1CO 16A probe $\varnothing$ 3.1mm probe L 219mm capillary pipe 1280mm capillary pipe isolated 1270mm gland nut shaft $\varnothing$ 6x4.6mm shaft L 23mm shaft position upper* rotation 318°		

55.13\_series



<b>GEV No.</b>	375954	<b>Ref. No.</b>	483286008707
<b>description</b>	thermostat t.max. 109°C 1-pole 1CO 16A probe $\varnothing$ 3.03mm probe L 198mm capillary pipe 900mm capillary pipe isolated 610mm gland nut M9x1 shaft $\varnothing$ 6mm shaft Lmm shaft position* shaft position rotation°		



<b>GEV No.</b>	375010	<b>Ref. No.</b>	481227118033
<b>description</b>	thermostat t.max. 250°C temperature range 50-250°C 1-pole 1NO 16A probe ø 3.1mm probe L 208mm capillary pipe 1130mm capillary pipe isolatedmm gland nut shaft L 23mm shaft position upper rotation 270°		

55.34\_ series



<b>GEV No.</b>	375097	<b>Ref. No.</b>	483286000171
<b>description</b>	thermostat t.max. 195°C temperature range 95-195°C 3-pole 3NO 16A probe ø 6mm probe L 117mm capillary pipe 1780mm capillary pipe isolated 1400mm gland nut M9x1 shaft ø 6x4.6mm shaft L 23mm shaft position upper rotation 270°		



<b>GEV No.</b>	375038	<b>Ref. No.</b>	483286009368	
<b>description</b>	thermostat t.max. 300°C temperature range 50-300°C 3-pole 3NO 16A probe ø 6mm probe L 79mm capillary pipe 1740mm capillary pipe isolated 800mm gland nut shaft ø 6x4.6mm shaft L 23mm shaft position upper rotation 270°			
<b>accessories for</b>	375038			
	<b>GEV No.</b>	110123	<b>Ref. No.</b>	—
	knob thermostat t.max. 300°C ø 50mm shaft ø 6x4.6mm shaft flat upper black temperature range 50-300°C rotation 270°			



safety thermostats

55.10/19\_ series



<b>GEV No.</b>	375178	<b>Ref. No.</b>	483286009341
<b>description</b>	safety thermostat switch-off temp. 230°C 1-pole 0.5A probe ø 4mm probe L 116mm capillary pipe 1500mm capillary pipe isolatedmm gland nut probe SS		



<b>GEV No.</b>	375282	<b>Ref. No.</b>	483286000478	
<b>description</b>	safety thermostat switch-off temp. 230°C 1-pole 16A probe ø 11mm probe L 28mm capillary pipe 850mm capillary pipe isolated 830mm gland nut probe screw-in probe probe thread M14x1			
<b>accessories for</b>	375282			
	<b>GEV No.</b>	507313	<b>Ref. No.</b>	—
	O-ring EPDM thickness 2.62mm ID ø 13.95mm Qty 1 pcs			
	<b>GEV No.</b>	510420	<b>Ref. No.</b>	—
	gasket copper ED ø 19.9mm ID ø 14.3mm thickness 2mm Qty 1 pcs			
	<b>GEV No.</b>	521133	<b>Ref. No.</b>	—
	nut thread M14x1.5 H 6mm WS 19 zinc-coated steel Qty 1 pcs			



<b>GEV No.</b>	390062	<b>Ref. No.</b>	483286009348	
<b>description</b>	safety thermostat switch-off temp. 235°C 1-pole 0.5A probe ø 6mm probe L 130mm capillary pipe 1800mm capillary pipe isolated 1500mm gland nut M9x1 probe SS			
<b>accessories for</b>	390062			
	<b>GEV No.</b>	551083	<b>Ref. No.</b>	—
	cap for safety thermostat thread M8x1			



<b>GEV No.</b>	375352	<b>Ref. No.</b>	48328600173
<b>description</b>	safety thermostat switch-off temp. 245°C 1-pole 1NC 16A probe ø 6mm probe L 130mm capillary pipe 1200mm capillary pipe isolated 1200mm gland nut probe		

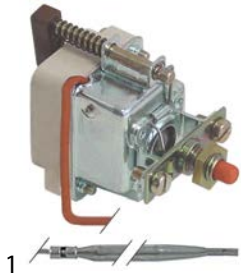

<b>GEV No.</b>	375353	<b>Ref. No.</b>	483286009238
<b>description</b>	safety thermostat switch-off temp. 355°C 1-pole 0.5A probe ø 4mm probe L 120mm capillary pipe 870mm capillary pipe isolated 870mm gland nut probe SS		

55.14\_series

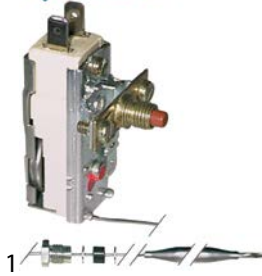

<b>GEV No.</b>	375610	<b>Ref. No.</b>	483286008208
<b>description</b>	safety thermostat switch-off temp. 340°C 1-pole 16A probe ø 3.03mm probe L 144mm capillary pipe 880mm capillary pipe isolated 750mm gland nut M9x1 probe		

55.32\_series



<b>GEV No.</b>	375649	<b>Ref. No.</b>	483286002546
<b>description</b>	safety thermostat switch-off temp. 160°C 3-pole 20A probe ø 6mm probe L 87mm capillary pipe 890mm capillary pipe isolated 880mm gland nut probe SS		





<b>GEV No.</b>	375252	<b>Ref. No.</b>	483286009372
<b>description</b>	safety thermostat switch-off temp. 350°C 3-pole 20A probe ø 6mm probe L 89mm capillary pipe 3000mm capillary pipe isolated 960mm gland nut probe		

IMIT / TEMPOMATIC / ARATHERMO

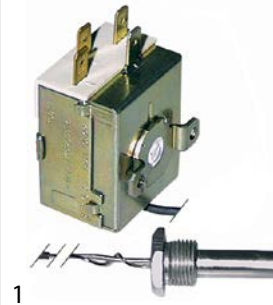
control thermostats



<b>GEV No.</b>	390310	<b>Ref. No.</b>	483286008151
<b>description</b>	thermostat t.max. 85°C temperature range fixed 55°C 1-pole 1CO 16A probe ø 9.5mm probe L 37mm capillary pipe 600mm capillary pipe isolated 540mm gland nut shaft ømm shaft Lmm shaft position rotation° screw-in probe probe thread 3/8" probe material SS		

<b>accessories for</b>	390310			
	<b>GEV No.</b>	506024	<b>Ref. No.</b>	—
	nut thread 3/8" H 6mm SS WS 22 Qty 1 pcs			
	<b>GEV No.</b>	529349	<b>Ref. No.</b>	—
	flat gasket FIBER ED ø 22mm ID ø 16.5mm thickness 2mm for thread 3/8" Qty 1 pcs			



**CAEM**

control thermostats



<b>GEV No.</b>	375609	<b>Ref. No.</b>	483286008704
<b>description</b>	thermostat t.max. 90°C temperature range 30-90°C 1-pole 1CO 16A probe ø 6mm probe L 95mm capillary pipe 1600mm capillary pipe isolated 1550mm shaft ø 6x4.6mm rotation 270°		



<b>GEV No.</b>	390211	<b>Ref. No.</b>	481927128578
<b>description</b>	thermostat ATEA type A03 0045 probe ø 2mm probe L 20mm capillary pipe 700mm starting temperature +5°C temperature range -13° up to -25°C for evaporator 68		

various

safety thermostats



<b>GEV No.</b>	390798	<b>Ref. No.</b>	756308 771985009339
<b>description</b>	safety thermostat switch-off temp. 235°C 1-pole 1CO probe ø 6mm probe L 63mm capillary pipe 1600mm capillary pipe isolated 80mm		

accessories

capillary tube clips



<b>GEV No.</b>	551105	<b>Ref. No.</b>	483286009649
<b>description</b>	capillary tube clip for pipe ø 6mm Qty 1 pcs		



<b>GEV No.</b>	550980	<b>Ref. No.</b>	483286000554
<b>description</b>	capillary tube clip for pipe ø 8.5mm Qty 1 pcs		

refrigeration thermostats

**RANCO**

K50 series





<b>GEV No.</b>	390271	<b>Ref. No.</b>	208089
<b>description</b>	thermostat RANCO type K50L3078 probe ømm probe Lmm capillary pipe 2000mm temperature range -7 up to -3°C		

switches and momentary switches

rocker/momentary rocker switches

30x22mm



<b>GEV No.</b>	301003	<b>Ref. No.</b>	483286011125	
<b>description</b>	rocker switch mounting measurements 30x22mm green 2NO 250V 16A illuminated 0-I connection male faston 6.3mm ambient temperature max. 125/55°C protection IP65			
<b>accessories for</b>	301003			
	<b>GEV No.</b>	301036	<b>Ref. No.</b>	—
	protective cover internal size 30x22mm for rocker switch mounting measurementsmm			

**ATEA**



<b>GEV No.</b>	390506	<b>Ref. No.</b>	481927128579
<b>description</b>	thermostat ATEA type A01 0046 probe ø 8mm probe L 120mm capillary pipemm temperature range°C		

labelled



<b>GEV No.</b>	300125	<b>Ref. No.</b>	483286000334	
<b>description</b>	rocker switch mounting measurements 30x22mm green 2NO 230V 16A 0-I connection male faston 6.3mm ambient temperature max. 125/55°C protection IP65 with cover cap			
<b>accessories for</b>	300125			
	<b>GEV No.</b>	301036	<b>Ref. No.</b>	—
	protective cover internal size 30x22mm for rocker switch mounting measurementsmm			



## push/momentary push switches

ø16mm



1

<b>GEV No.</b>	346287 <sup>1</sup>	<b>Ref. No.</b>	771985000077
<b>description</b>	momentary push switch mounting ø 16mm red 1NO 250V 3A illuminated connection male faston 2.8mm ambient temperature max. 125/55°C protection IP65 with cover cap		

<sup>1</sup>illuminated

1

<b>GEV No.</b>	346320	<b>Ref. No.</b>	483286008692
<b>description</b>	momentary push switch mounting ø 16mm red 1NO/indicator light 250V 3A ignition connection male faston 6.3mm ambient temperature max. 85°C protection IP40		

ø25mm



1

<b>GEV No.</b>	346094	<b>Ref. No.</b>	483286002425
<b>description</b>	push switch mounting ø 25mm orange 2NO/indicator light 250V 16A with rubber collar connection male faston 6.3mm ambient temperature max. 85°C protection IP65		

## microswitches

lever actuated



1

<b>GEV No.</b>	346927	<b>Ref. No.</b>	771985009990 820035
<b>description</b>	microswitch with lever 250V 10A 2CO connection male faston 6.3mm Lmm ambient temperature max. 125°C mounting distance 22mm double type VRSR01DA1 actuating force: 220g		

pin-plunger actuated

M10



1

<b>GEV No.</b>	345032	<b>Ref. No.</b>	483286008198
<b>description</b>	microswitch with plunger thread M10x1 thread L 12mm 250V 16A 1CO connection male faston 6.3mm stroke 7mm mounting distance 22mm L 28mm ambient temperature max. 125°C type SP9603 actuating force: 180g		

M12



1

<b>GEV No.</b>	345360	<b>Ref. No.</b>	483286002641
<b>description</b>	microswitch with plunger mounting distance 25.4mm thread M12x1 thread L 15mm 250V 10A 1CO connection screw stroke 5mm ambient temperature max. 125°C type Highly D5000 actuating force: 200g		

## system switches (ROLD)



1

<b>GEV No.</b>	345724	<b>Ref. No.</b>	192919 771985004988
<b>description</b>	cap size 23x23mm black MIN/MED/MAX		



1

<b>GEV No.</b>	345537	<b>Ref. No.</b>	483286008922
<b>description</b>	element holder mounting measurements 20.6x16.4mm grey arched for push buttons 13x17mm		



1

<b>GEV No.</b>	345539	<b>Ref. No.</b>	483286008921
<b>description</b>	push button size 17x13mm grey		



1

<b>GEV No.</b>	345605	<b>Ref. No.</b>	483286008918
<b>description</b>	switch 2CO 250V 16A connection male faston 6.3mm		





cam switches

on/off

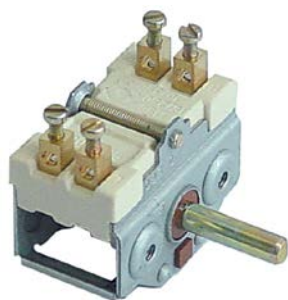

1

<b>GEV No.</b>	300151	<b>Ref. No.</b>	483286009387
<b>description</b>	cam switch 2 operating positions 2NO sequence 0-1 16A shaft $\varnothing$ 6x4.6mm shaft L 23mm connection screw ceramic		

4-position

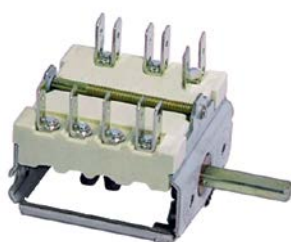

1

<b>GEV No.</b>	300007	<b>Ref. No.</b>	483286009309
<b>description</b>	cam switch 4 operating positions 1NO/2CO sequence 0-1-2-3 16A shaft $\varnothing$ 6x4.6mm shaft L 23mm connection male faston 6.3mm 4-position ceramic		

7-position



1

<b>GEV No.</b>	300004	<b>Ref. No.</b>	483286009633
<b>description</b>	cam switch 7 operating positions 1NO/2CO sequence 0-1-2-3-4-5-6 16A shaft $\varnothing$ 6x4.6mm shaft L 23mm connection male faston 6.3mm 7-position ceramic		

3 operating positions



1

<b>GEV No.</b>	300167	<b>Ref. No.</b>	483286009427
<b>description</b>	cam switch 3 operating positions 2NO/1CO sequence 0-1-2 16A shaft $\varnothing$ 6x4.6mm shaft L 23mm connection screw		

4 operating positions

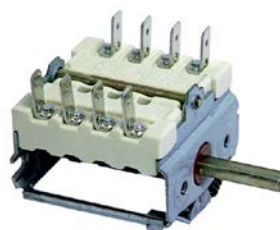

1

<b>GEV No.</b>	300184	<b>Ref. No.</b>	483286009617
<b>description</b>	cam switch 4 operating positions sequence 0-3-2-1 shaft $\varnothing$ 6x4.6mm connection male faston 4-pole		

8 operating positions

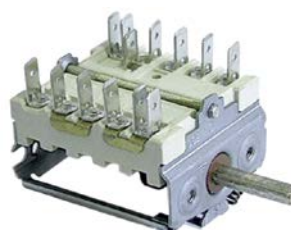

1

<b>GEV No.</b>	301094	<b>Ref. No.</b>	155017 771985007011
<b>description</b>	cam switch 8 operating positions 7NO sequence 0-1-2-3-4-5-6-7 16A shaft $\varnothing$ 6x4.6mm shaft L 23mm connection male faston 6.3mm ceramic		

operation switches



1

<b>GEV No.</b>	300080	<b>Ref. No.</b>	483286009371
<b>description</b>	cam switch 2 operating positions 4NO 16A sequence 0-1 shaft $\varnothing$ 6x4.6mm shaft L 23mm connection screw operation switch ceramic ambient temperature max. 150°C		

<b>accessories for</b>	300080		
	<b>GEV No.</b>	<b>Ref. No.</b>	—
	gasket for switch ED $\varnothing$ 14mm ID $\varnothing$ 2.5mm thickness 3.5mm white		



1	<b>GEV No.</b>	300091	<b>Ref. No.</b>	483286009351
<b>description</b>	operation switch EGO 2 operating positions 2NO 16A sequence 0-1 shaft $\varnothing$ 6x4.6mm shaft L 23mm connection screw ceramic			

rotary switches

TECNOMATIC



1	<b>GEV No.</b>	346102	<b>Ref. No.</b>	483286002479
<b>description</b>	rotary switch 6 2-1-0-3-4-5 sets of contacts 10 type HD12X303R000 600V 12A shaft $\varnothing$ 6mm shaft L 22mm shaft round connection male faston 6.3mm			

magnetic switches

36x13mm



1	<b>GEV No.</b>	347557	<b>Ref. No.</b>	188578 771985012950
<b>description</b>	magnetic switch L 36mm W 13mm 1NO cable length 800mm H 8mm mounting distance 22mm			

50x19mm

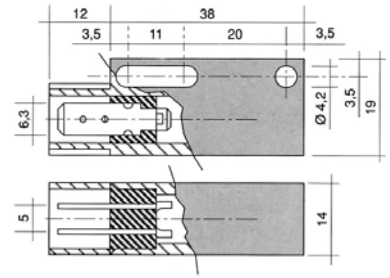

1	<b>GEV No.</b>	345821	<b>Ref. No.</b>	149921 771985002220
<b>description</b>	magnetic switch L 50mm W 19mm 1NO 250V 1A P max. 50W connection male faston 6.3mm			
<b>accessories for</b>	345821			
	<b>GEV No.</b>	519049	<b>Ref. No.</b>	149627 4832 860 08117 483286008762 483286008861
magnet $\varnothing$ mm L 63mm H 10.7mm W 18.8mm hole distance 52mm M2 hole $\varnothing$ 2mm				

M10x0.75

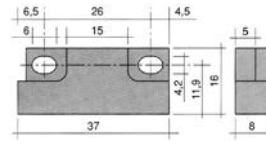

1	<b>GEV No.</b>	347936 <sup>1</sup>	<b>Ref. No.</b>	483286001215
<b>description</b>	magnetic switch thread M10x0.75 1NO 230V 0.04A P max. 10W connection Faston 6.3mm cable length 1100mm			

<sup>1</sup>with coded connector

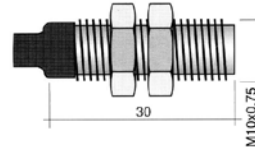

1	<b>GEV No.</b>	345632	<b>Ref. No.</b>	483286008341
<b>description</b>	magnetic switch thread M10x0.75 1NO 250V 0.5A P max. 50W connection cable cable length 2000mm type 102			
<b>accessories for</b>	345632			
	<b>GEV No.</b>	100779	<b>Ref. No.</b>	—
nut thread M10x0.75 H 3mm WS 14 SS Qty 2 pcs				



## accessories

### magnets

1

<b>GEV No.</b>	345398	<b>Ref. No.</b>	483286008354
<b>description</b>	magnet ømm L 36mm H 8mm W 13mm hole distance 20mm M3 hole ø 3mm		

1

<b>GEV No.</b>	519049	<b>Ref. No.</b>	149627 4832 860 08117 483286008762 483286008861
<b>description</b>	magnet ømm L 63mm H 10.7mm W 18.8mm hole distance 52mm M2 hole ø 2mm		
<b>accessories for</b>	519049		
	<b>GEV No.</b>	560095	<b>Ref. No.</b>
	sheet metal screws ø 2.9mm L 9.5mm SS Qty 20 pcs DIN 7981/ISO 7049 head ø 5.6mm oval head		

## encoders and potentiometers

1

<b>GEV No.</b>	403908	<b>Ref. No.</b>	483286010114
<b>description</b>	encoder shaft ø 6x4.6mm shaft L 10mm connection coded cable length 980mm		

## lamps

### indicator lights

#### indicator lights (complete)

##### ø 9mm

1

<b>GEV No.</b>	359136	<b>Ref. No.</b>	483286008203 771985010290
<b>description</b>	indicator light ø 9mm 230V green connection male faston 6.3mm temp.-resist. 120°C		

##### ø10mm

#### with screw socket

1

<b>GEV No.</b>	359378	<b>Ref. No.</b>	771985003566 771985010932
<b>description</b>	indicator light ø 10mm 230V green connection male faston 6.3mm socket screw base		

##### ø12mm

#### with plug-in socket

1

<b>GEV No.</b>	359041	<b>Ref. No.</b>	483286009168
<b>description</b>	indicator light ø 12mm green 230V connection male faston 6.3mm temp.-resist. 120°C Qty 1 pcs		

1

<b>GEV No.</b>	359042	<b>Ref. No.</b>	483286009189
<b>description</b>	indicator light ø 12mm yellow 230V connection male faston 6.3mm temp.-resist. 120°C Qty 1 pcs		

##### ø13mm

#### with plug-in socket

1

<b>GEV No.</b>	359364	<b>Ref. No.</b>	771985000510
<b>description</b>	indicator light ø 13mm green 230V		

### screw-on/push-on fit

#### halogen lamp

##### for socket G4 / G6.35 / G9

1

<b>GEV No.</b>	359074	<b>Ref. No.</b>	483286008688
<b>description</b>	halogen lamp socket G6.35 12V 35W temp.-resist. 500°C		



## oven lamps

## universal oven lamps

mounting diameter 47.8mm



<b>GEV No.</b>	357187	<b>Ref. No.</b>	771985010401
<b>description</b>	oven lamp mounting ø 47.8mm 230V 15W socket E14 temp.-resist. 300°C connection male faston 6.3mm hard glas		
<b>spare parts for</b>	357187		
	<b>GEV No.</b>	359610	<b>Ref. No.</b> —
	light bulb t.max. 300°C socket E14 15W 230V ø 22mm L 47mm lens L 20mm for oven lamp type Philips		
	<b>GEV No.</b>	359725	<b>Ref. No.</b> —
	oven lamp glass thread ø 44mm H 43mm ø 54mm hard glas temp.-resist. 350°C		

55x70mm



<b>GEV No.</b>	360731	<b>Ref. No.</b>	483286002063
<b>description</b>	oven lamp complete 230V 25W socket G9 L 70mm W 55mm		

## lamps

## halogen lamps

for socket G4 / G6.35 / G9



<b>GEV No.</b>	359074	<b>Ref. No.</b>	483286008688
<b>description</b>	halogen lamp socket G6.35 12V 35W temp.-resist. 500°C		

## sockets

G4 / G5,3 / G6,35





<b>GEV No.</b>	359369	<b>Ref. No.</b>	483286002473
<b>description</b>	lamp socket socket G4/G5.3/G6.35 24V ø 17mm H 10mm connection cable 120mm mounting distance 11.5mm for halogen lamp cable length 730mm		

## timers

## programme timers



<b>GEV No.</b>	360234	<b>Ref. No.</b>	483286008916
<b>description</b>	timer FIBER P25 engines 2 chambers 4 operation time 6s / 3min 230V shaft ømm shaft Lmm manuf. no. P255J04JBC7 motor type M51B-JOR6400 / M51BJ0L6400		
<b>spare parts for</b>	360234		
	<b>GEV No.</b>	360673	<b>Ref. No.</b> —
	motor kit pinion ø 6.8mm teeth 15 230V voltage AC 50/60Hz turn direction clockwise motor ø 48mm H 18.5mm motor type UDS-40NE1RNZ165 cable length 150mm with holder		
	<b>GEV No.</b>	360674	<b>Ref. No.</b> —
	motor kit pinion ø 6.8mm teeth 15 230V voltage AC 50/60Hz turn direction counterclockwise motor ø 48mm H 18.5mm motor type UDS40NE1RNZ165 cable length 150mm with holder		

## electric timers

## with time spread



<b>GEV No.</b>	350074	<b>Ref. No.</b>	483286008723
<b>description</b>	timer MS65 operation time 120min time spread 30min 1CO/2NO/1NC at 250V 16A permanent position yes impulse electric shaft ø 6x4.6mm shaft L 22mm mounting distance 28mm connection lateral Invensys 4-pole shaft position lower°		

## defrost timers

## miscellaneous



<b>GEV No.</b>	360187	<b>Ref. No.</b>	184986 771985005240
<b>description</b>	defrost timer type RZ-2001-21 defrosting interval 4H defrosting time 15min fan delay 5min 230V 50Hz defr. funct. 4x per 24h		



## alarm devices

### buzzer boards

			
1			
<b>GEV No.</b>	401062	<b>Ref. No.</b>	483286008724
<b>description</b>	buzzer board 230VAC L 48mm W 45mm connection Faston 6.3mm		

## contactors

### GENERAL ELECTRIC (AEG)



#### power contactors



			
1			
<b>GEV No.</b>	380244	<b>Ref. No.</b>	483286009363
<b>description</b>	power contactor resistive load 25A 230VAC (AC3/400V) 9A/4kW main contacts 3NO auxiliary contacts 1NO connection screw connection type AEG LS4K 10A type GE CL00A 310		

			
1			
<b>GEV No.</b>	380262	<b>Ref. No.</b>	483286009362
<b>description</b>	power contactor resistive load 32A 230VAC (AC3/400V) 17A/7.5kW main contacts 3NO auxiliary contacts 1NC connection screw connection type AEG LS7K01A type GE CL02A 301 H 85mm		

## LOVATO

### power contactors

				
1				
<b>GEV No.</b>	380705	<b>Ref. No.</b>	483286002413	
<b>description</b>	power contactor resistive load 20A 230VAC (AC3/400V) 9A/4kW main contacts 3NO auxiliary contacts 1NO connection screw connection type 11BG0910A230			
<b>accessories for</b>	380705			
	<b>GEV No.</b>	380057	<b>Ref. No.</b>	483286003058
	auxiliary contact contacts 1NO/1NC AC1 10A for contactors BG series connection screw type BGX1011			

				
1				
<b>GEV No.</b>	380855	<b>Ref. No.</b>	483286002467	
<b>description</b>	power contactor resistive load 25A 230VAC (AC3/400V) 4.2kW main contacts 3NO auxiliary contacts 1NO			
<b>accessories for</b>	380855			
	<b>GEV No.</b>	380055	<b>Ref. No.</b>	483286002486
	RC circuit voltage AC/DC suitable for BF09-32 rated 240V			
	<b>GEV No.</b>	380118	<b>Ref. No.</b>	483286002617
	auxiliary contact contacts 1NO/1NC AC1 10A for contactors BF series connection screw type G480/11			

### auxiliary contacts

			
1			
<b>GEV No.</b>	380118	<b>Ref. No.</b>	483286002617
<b>description</b>	auxiliary contact contacts 1NO/1NC AC1 10A for contactors BF series connection screw type G480/11		





			
1			
<b>GEV No.</b>	380057	<b>Ref. No.</b>	483286003058
<b>description</b>	auxiliary contact contacts 1NO/1NC AC1 10A for contactors BG series connection screw type BGX1011		

## miscellaneous

## RC circuits

			
1			
<b>GEV No.</b>	380056	<b>Ref. No.</b>	483286002398
<b>description</b>	RC circuit 250V		

## relays

## power relays

## with bracket mounting

			
1			
<b>GEV No.</b>	380139	<b>Ref. No.</b>	483286008915
<b>description</b>	power relays FINDER 230VAC 16A 2CO connection F6.3 bracket mounting dimensions 68x38.2x35.8mm manuf. no. 62.82.8.230.0000		

## transformers

## open transformers

## with clamp terminal

			
1			
<b>GEV No.</b>	401128	<b>Ref. No.</b>	483286002488
<b>description</b>	transformer primary 230V secondary 12V 100VA		

			
1			
<b>GEV No.</b>	401065	<b>Ref. No.</b>	483286003066
<b>description</b>	transformer primary 230V secondary 12V 120VA secondary 7.5A+2.5A connection screw 50/60Hz		

## encapsulated transformers

## multiple connections

			
1			
<b>GEV No.</b>	401136	<b>Ref. No.</b>	483286002397
<b>description</b>	transformer primary 230V secondary 12V 60VA		

			
1			
<b>GEV No.</b>	401087	<b>Ref. No.</b>	483286002556
<b>description</b>	transformer primary 230V secondary 24V 60VA secondary 2.5A connection male faston 6.3mm 50/60Hz		

## probes

## producer-specific probes

## probes

			
1			
<b>GEV No.</b>	378047	<b>Ref. No.</b>	483286002455
<b>description</b>	temperature probe NTC 100kOhm cable TPE probe -40 up to +110°C cable -40 up to +110°C connection male faston thread probe ø5x-20mm cable length 0.9m		

			
1			
<b>GEV No.</b>	378671	<b>Ref. No.</b>	483286002451
<b>description</b>	temperature probe Pt1000 cable PTFE connection 2-wire probe ø4x60mm cable length 1.3m		



core probes



1

<b>GEV No.</b>	401944	<b>Ref. No.</b>	771985011103
<b>description</b>	core temperature probe NTC 10kOhm cable silicone probe -40 up to +120°C cable -50 up to +180°C connection plug probe ø5x80mm thread cable length 3m handle ø 10mm handle length 100mm L1 150mm L2 70mm		

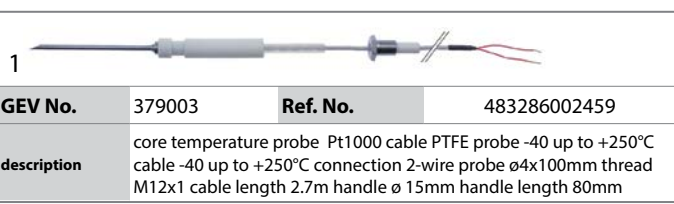

1

<b>GEV No.</b>	379003	<b>Ref. No.</b>	483286002459
<b>description</b>	core temperature probe Pt1000 cable PTFE probe -40 up to +250°C cable -40 up to +250°C connection 2-wire probe ø4x100mm thread M12x1 cable length 2.7m handle ø 15mm handle length 80mm		

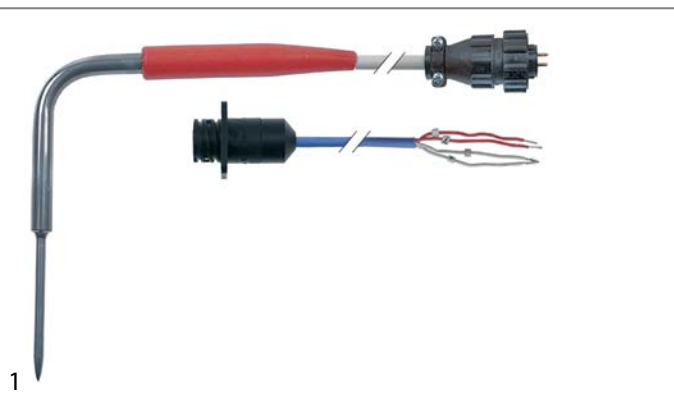

1

<b>GEV No.</b>	379548	<b>Ref. No.</b>	483286000033
<b>description</b>	core temperature probe PTC 1kOhm cable silicone probe -50 up to +150°C cable -50 up to +180°C connection 4-wire probe ø5x70mm thread cable length 1.2m handle ø 10mm handle length 120mm L1 150mm L2 80mm		

electronics

PCBs

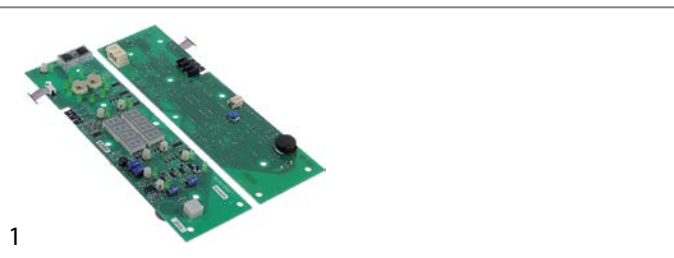

1

<b>GEV No.</b>	403444	<b>Ref. No.</b>	188591 771985011102
<b>description</b>	control PCB L 290mm W 80mm cable length 800mm green display 2x4 digits		

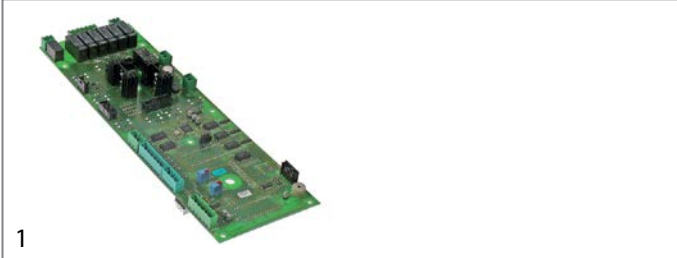

1

<b>GEV No.</b>	401063	<b>Ref. No.</b>	483286002099
<b>description</b>	keypad PCB		



1

<b>GEV No.</b>	401742	<b>Ref. No.</b>	187338
<b>description</b>	keypad PCB		

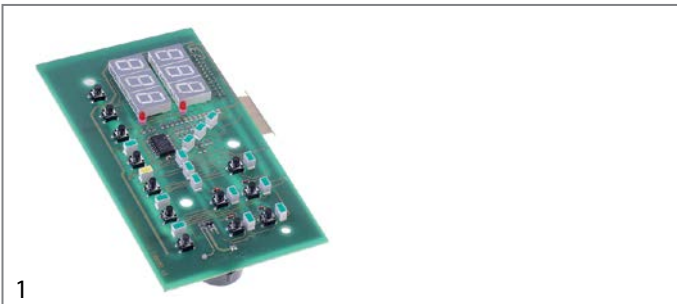

1

<b>GEV No.</b>	401780	<b>Ref. No.</b>	483286002799
<b>description</b>	keypad PCB blast chiller L 160mm W 85mm suitable for ILSA vertical		
<b>accessories for</b>	401780		
	<b>GEV No.</b>	<b>Ref. No.</b>	—
	401781		
	keypad foil vertical L 138mm W 68mm		



1

<b>GEV No.</b>	401753	<b>Ref. No.</b>	185925 771985005280
<b>description</b>	keypad PCB for HACCP with main PCB		

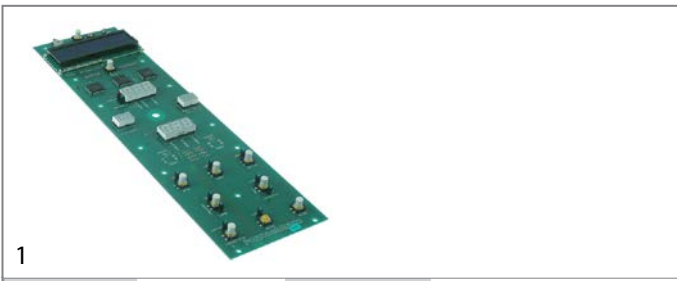

1

<b>GEV No.</b>	401064	<b>Ref. No.</b>	483286003065
<b>description</b>	keypad PCB programmable key pad F-Series encoder		



1	<b>GEV No.</b>	403608	<b>Ref. No.</b>	771985000639
	<b>description</b>	main PCB convection oven L 340mm W 115mm display		



1	<b>GEV No.</b>	403442	<b>Ref. No.</b>	190018
	<b>description</b>	PCB blast freezer BC100 L 165mm W 120mm suitable for ZANUSSI 50/60Hz 230V H 40mm 2.8A Qty 1 pcs		



1	<b>GEV No.</b>	403443	<b>Ref. No.</b>	185926 771985005281
	<b>description</b>	PCB blast freezer BCF 72/144 suitable for ZANUSSI		

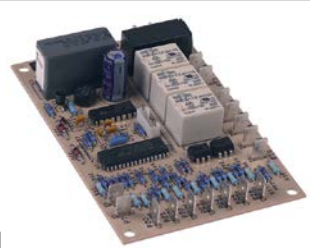

1	<b>GEV No.</b>	401029	<b>Ref. No.</b>	483286003286 4832860032B2
	<b>description</b>	PCB dishwasher LF 50 L 122mm W 80mm Qty 1 pcs		



1	<b>GEV No.</b>	403326	<b>Ref. No.</b>	483286008844
	<b>description</b>	PCB dishwasher Tronic L 145mm W 116mm		



1	<b>GEV No.</b>	401061	<b>Ref. No.</b>	483286002558
	<b>description</b>	PCB for fan		



1	<b>GEV No.</b>	401058	<b>Ref. No.</b>	483286003183
	<b>description</b>	PCB suitable for programmable key pad F-Series controller		

## solenoid valves

### solenoid valves (water)

#### ROBERTSHAW/INVENSYS

medium temperature: 90°C 90°C 60°C  
 ambient temperature: 60°C 25°C 60°C  
 duty cycle: 40% 100% 100%



1	<b>GEV No.</b>	372025	<b>Ref. No.</b>	483286008703
	<b>description</b>	solenoid valve triple straight 230VAC inlet 3/4" outlet 11.5mm DN10 EATON (INVENSYS)		

#### RPE



1	<b>GEV No.</b>	374021	<b>Ref. No.</b>	483286002456
	<b>description</b>	solenoid valve double straight 230VAC inlet 3/4" outlet 10mm DN10 RPE		





solenoid valves with reducers			
2-fold			
			
1			
<b>GEV No.</b>	374035	<b>Ref. No.</b>	483286002457
<b>description</b>	solenoid valve double straight 230VAC inlet 3/4" outlet 11.5mm input 10-12l/min t.max. 60°C duty cycle 100% plastic		

TP			
			
			
1			
<b>GEV No.</b>	370017	<b>Ref. No.</b>	483286008141
<b>description</b>	solenoid valve single straight 230VAC inlet 3/4" outlet 11.5mm DN10 TP p max 10bar		
<b>spare parts for</b>	370017		
	<b>GEV No.</b>	371013	<b>Ref. No.</b> —
solenoid coil TP 230VAC 50/60Hz			
<b>accessories for</b>	370017		
	<b>GEV No.</b>	371220	<b>Ref. No.</b> —
reducer TP flow rate 3l/min red tolerance ±15%			
	<b>GEV No.</b>	371221	<b>Ref. No.</b> —
reducer TP flow rate 5.5l/min yellow tolerance ±15%			
	<b>GEV No.</b>	371222	<b>Ref. No.</b> —
reducer TP flow rate 6l/min grey tolerance ±15%			
	<b>GEV No.</b>	371223	<b>Ref. No.</b> —
reducer TP flow rate 10l/min white tolerance ±15%			
	<b>GEV No.</b>	371224	<b>Ref. No.</b> —
reducer TP flow rate 12l/min bronze tolerance ±15%			
	<b>GEV No.</b>	371225	<b>Ref. No.</b> —
reducer TP flow rate 16l/min light brown tolerance ±15%			
	<b>GEV No.</b>	371226	<b>Ref. No.</b> —
reducer TP flow rate 20l/min red tolerance ±15%			
	<b>GEV No.</b>	371230	<b>Ref. No.</b> —
reducer TP flow rate 0.25l/min red tolerance ±25%			
	<b>GEV No.</b>	371231	<b>Ref. No.</b> —
reducer TP flow rate 0.35l/min violet tolerance ±25%			
	<b>GEV No.</b>	371232	<b>Ref. No.</b> —
reducer TP flow rate 0.5l/min orange tolerance ±25%			
	<b>GEV No.</b>	371233	<b>Ref. No.</b> —
reducer TP flow rate 0.8l/min white tolerance ±25%			

<b>accessories for</b>	370017		
	<b>GEV No.</b>	371234	<b>Ref. No.</b> —
reducer TP flow rate 1l/min light blue tolerance ±25%			
	<b>GEV No.</b>	371235	<b>Ref. No.</b> —
reducer TP flow rate 1.2l/min brown tolerance ±25%			
	<b>GEV No.</b>	371236	<b>Ref. No.</b> —
reducer TP flow rate 1.5l/min light brown tolerance ±25%			
	<b>GEV No.</b>	371237	<b>Ref. No.</b> —
reducer TP flow rate 2.5l/min yellow tolerance ±25%			
	<b>GEV No.</b>	371238	<b>Ref. No.</b> —
reducer TP flow rate 3.4l/min dark green tolerance ±25%			
	<b>GEV No.</b>	371239	<b>Ref. No.</b> —
reducer TP flow rate 5l/min black tolerance ±25%			
	<b>GEV No.</b>	371240	<b>Ref. No.</b> —
reducer TP flow rate 8l/min blue tolerance ±20%			

various			
			
1			
<b>GEV No.</b>	370673	<b>Ref. No.</b>	771985006245
<b>description</b>	solenoid valve 3-way 230VAC BÜRKERT		

metal			
SIRAI			
2-way			
L180-B series			
			
1			
<b>GEV No.</b>	370391	<b>Ref. No.</b>	483286001624
<b>description</b>	solenoid valve 2-ways 24VAC connection 3/4" L 79mm DN 18mm -10 up to +90°C coil type Z610A membranes NBR (water) p max 12bar p min 0.35bar		
<b>accessories for</b>	370391		
	<b>GEV No.</b>	371091	<b>Ref. No.</b> —
power socket plug type DIN 43650B cable lengthmm small			



solenoid valves (various)



1

<b>GEV No.</b>	370338	<b>Ref. No.</b>	483286002414
<b>description</b>	solenoid valve 2-ways 230VAC connection 1/8" DN 6mm		



1

<b>GEV No.</b>	370319	<b>Ref. No.</b>	483286002553
<b>description</b>	solenoid valve 2-ways 230VAC inlet 1/4" outlet 1/4" p max 13bar p min 0.1bar 50Hz 230V brass		
<b>spare parts for</b>	370319		
	<b>GEV No.</b>	371188	<b>Ref. No.</b> —
	solenoid coil 50Hz 230V H 35mm seat ø 13mm type H 17VA series 688		

drain valves



1

<b>GEV No.</b>	370789	<b>Ref. No.</b>	483286008384
<b>description</b>	drain valve 220-240V 50/60Hz NO inlet 50mm outlet 50/35mm MDB-O-2-SO		

ball valves electric



1

<b>GEV No.</b>	401085	<b>Ref. No.</b>	483286002415
<b>description</b>	ball valve inlet 1/2" IT outlet 1/2" IT 230V L 60mm 50/60Hz closed off-current mode of operation electric connection cable 400mm cable 3-pole		

pressure switches

for warewashing

ø 58mm with male faston 6.3mm

with connection horizontal



1

<b>GEV No.</b>	541787	<b>Ref. No.</b>	483286000512
<b>description</b>	pressure control double pressure range 40/20 90/35mbar connection 6mm ø 58mm pressure connection horizontal warewashing pressure connection ø 5.5mm		



1

<b>GEV No.</b>	541781	<b>Ref. No.</b>	483286008801
<b>description</b>	pressure control pressure range 118/50mbar connection male faston 6.3mm ø 58mm pressure connection horizontal pressure connection ø 6mm		

for coffee machines

ø 38mm



1

<b>GEV No.</b>	541340	<b>Ref. No.</b>	483286002416
<b>description</b>	pressure control ø 38mm pressure range 0.5-1.2bar pressure connection vertical preset at 0.9bar coffee machine parts connection male faston 6.3mm pressure connection 1/8"		



1

<b>GEV No.</b>	541341	<b>Ref. No.</b>	483286002417
<b>description</b>	pressure control ø 38mm pressure range 1.5-4bar pressure connection vertical preset at 3bar 16A 250V coffee machine parts connection 1/8" pressure connection 1/8"		





for steam control



1

<b>GEV No.</b>	541581	<b>Ref. No.</b>	483286002547
<b>description</b>	pressure control ø 38mm pressure range fixed 1.6bar connection 1/8" 1CO 16A preset at 1.6barbar pressure connection 1/8" ET		



1

<b>GEV No.</b>	541350	<b>Ref. No.</b>	202480
<b>description</b>	pressure control pressure range adjustable 0.3-0.8bar connection 1/4" CO 250V 10A ambient temperature max. 60°C pressure connection 1/4"		

electrodes



1

<b>GEV No.</b>	401086	<b>Ref. No.</b>	483286002548
<b>description</b>	level electrode 1/4" total length 70mm probe L 44mm insulated probe length 39mm PTFE insulated connection male faston 6.3mm stainless steel ø 2.5mm		

compressors

ACC/ZEL

R134A

HMBP monophase

High/Medium evaporation temperature above -20/-15 °C



1

<b>GEV No.</b>	605012	<b>Ref. No.</b>	185501 771985005257
<b>description</b>	compressor coolant R134a type GL45TB 220-240V 50Hz HMBP fully hermetic 8.4kg 1/6HP power input 342W cylinder capacity 4.5cm <sup>3</sup> CSIR H 175.5mmW 76W 101W 134W 175W 223W 278W 342W 413W test method ASHRAE ambient temperature max. 43°C		

CUBIGEL

R404a/R507

LBP monophase

Lower evaporation temperature below -20°C



1

<b>GEV No.</b>	605180	<b>Ref. No.</b>	483286000077
<b>description</b>	compressor coolant R404a/R507 type MX23FB 220-240V 50Hz LBP 17.5kg 1HP power input 7/8W cylinder capacity 23.2cm <sup>3</sup> CSR H 221mm 749W 982W 1246W 1541W 1868WWWWWW		

EMBRACO / ASPERA

R134A

LBP monophase

Lower evaporation temperature below -20°C



1

<b>GEV No.</b>	605231	<b>Ref. No.</b>	481936058775
<b>description</b>	compressor coolant R134a type EMT43HLP 220-240V 50Hz LBP 7.5kg 1/8HP cylinder capacity 4.85cm <sup>3</sup> RSIR/RSCR H 166mm 89W 118W 153W 195W 246W 308WWWWWW test method EN 12900 ambient temperature max. 43°C		



1

<b>GEV No.</b>	605265	<b>Ref. No.</b>	485409918009
<b>description</b>	compressor coolant R134a type NE2134Z 220-240V 50Hz LBP 11.65kg 1/2HP cylinder capacity 14.28cm <sup>3</sup> CSIR 261W 350W 458W 588W 741WWWWWW test method ASHRAE		



HBP monophase

High evaporation temperature above -15°C



<b>GEV No.</b>	605254	<b>Ref. No.</b>	485409918012
<b>description</b>	compressor coolant R134a type NJ6220Z-A 220-240V 50Hz HBP 20.3kg 1HP cylinder capacity 26.2cm <sup>3</sup> CSIRWWW 962W 1263W 1638W 2087W 2610W 3206W test method EN 12900		



<b>GEV No.</b>	605175	<b>Ref. No.</b>	485409918015
<b>description</b>	compressor coolant R134a type NJ6226Z 220-240V 50Hz HBP 19.8kg 1 1/4HP cylinder capacity 34.37cm <sup>3</sup> CSR H 253mmWWW 1144W 1497W 1892W 2340W 2852W 3438W		

R404a/R507

HMBP monophase

High/Medium evaporation temperature above -20/-15 °C



<b>GEV No.</b>	605190	<b>Ref. No.</b>	485409918034
<b>description</b>	compressor coolant R404a/R507 type NJ9232GK 220-240V 50Hz HMBP 22.1kg 1 1/4HP cylinder capacity 26.2cm <sup>3</sup> CSR H 277mmWW 1093W 1470W 1911W 2413W 2973W 3588W 4255W ambient temperature max. 45°C		



<b>GEV No.</b>	605177	<b>Ref. No.</b>	485409918084
<b>description</b>	compressor coolant R404a/R507 type NJ9238GK 220-240V 50Hz HMBP 22.1kg 1 1/2HP cylinder capacity 32.7cm <sup>3</sup> CSR H 277mmW 2016W 2640W 3315W 4045W 4830W 5668W 6560W		

R600A

LBP monophase

Lower evaporation temperature below -20°C



<b>GEV No.</b>	605246	<b>Ref. No.</b>	481236038764
<b>description</b>	compressor coolant R600a type EMT26CLP 220-240V 50Hz LBP 1/10HP cylinder capacity 5.19cm <sup>3</sup> RSIR H 166mm 54W 73W 95W 120W 151W 190WWWW test method EN 12900		



SECOP DANFOSS

R134A

HMBP monophase

High/Medium evaporation temperature above -20/-15 °C



<b>GEV No.</b>	605088	<b>Ref. No.</b>	483286008054
<b>description</b>	compressor coolant R134a type FR7.5G 220-240V 50Hz HMBP fully hermetic 10.6kg 1/5HP power input 175W cylinder capacity 6.93cm <sup>3</sup> RSIR/CSIR H 196mm 62W 99W 142W 193W 254W 325W 408W 505W 618W test method ASHRAEW		
<b>spare parts for</b>	605088		
	<b>GEV No.</b>	381529	<b>Ref. No.</b> —
	start relay DANFOSS 117U6001		

R404a/R507

LBP monophase

Lower evaporation temperature below -20°C



<b>GEV No.</b>	605056	<b>Ref. No.</b>	485409918013
<b>description</b>	compressor coolant R404a/R507 type SC18CLX.2 220-240V 50Hz LBP fully hermetic 13.7kg 5/8HP cylinder capacity 17.69cm <sup>3</sup> CSR H 219mm 562W 691W 881W 1095W 1332W 1593W test method ASHRAE		
<b>spare parts for</b>	605056		
	<b>GEV No.</b>	381548	<b>Ref. No.</b> —
	start relay DANFOSS		

evaporation and condensing trays

condensing trays heated

universal



heating cartridges

1			
<b>GEV No.</b>	417227	<b>Ref. No.</b>	183814
<b>description</b>	heating cartridge 90W 230V ø 12mm L 124mm thread 3/8" cable length 4000mm Hmm Wmm condensate evaporation		

fans

axial fans

import

1			
<b>GEV No.</b>	601080 <sup>1</sup>	<b>Ref. No.</b>	483286008695
<b>description</b>	axial fan L 119mm W 119mm H 38mm 230VAC 50/60Hz 23/20W bearing ball bearing connection male faston 2.8mm metal ADDA fan wheel ø 110mm temp.-resist. 70°C		
<b>accessories for</b>	601080		
	<b>GEV No.</b>	550898	<b>Ref. No.</b> —
	connecting cable cable length 2000mm connection F 2.8 connection distance 7.9mm for axial flow fan		
	<b>GEV No.</b>	692519	<b>Ref. No.</b> —
	guard L 120mm W 120mm plastic		

<sup>1</sup>with ball bearings

refrigeration fans

refrigeration motors universal

ebm-papst

standard motors



1	<b>GEV No.</b>	601952	<b>Ref. No.</b>	483286002784
<b>description</b> fan motor 25W 230V 50/60Hz cable length 450mm 1300/1550rpm ebm-papst 5 mounting options bearing slide bearing				

accessories

fan wheels

aluminium

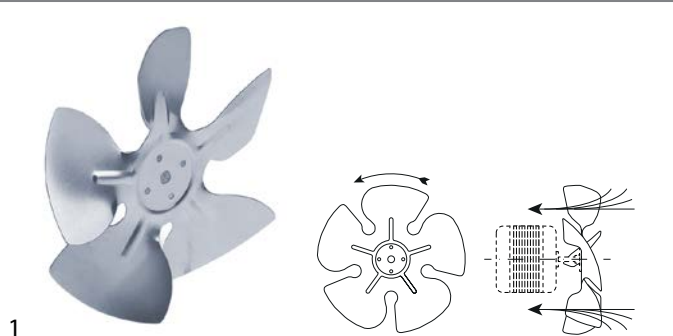

1	<b>GEV No.</b>	601566	<b>Ref. No.</b>	483286008076
<b>description</b> fan wheel sucking ø 154mm fan wheel mounting 25.4mm blade angle 28° W 34mm aluminium				

cold air circulating fans (complete)

ebm-papst

A2E series

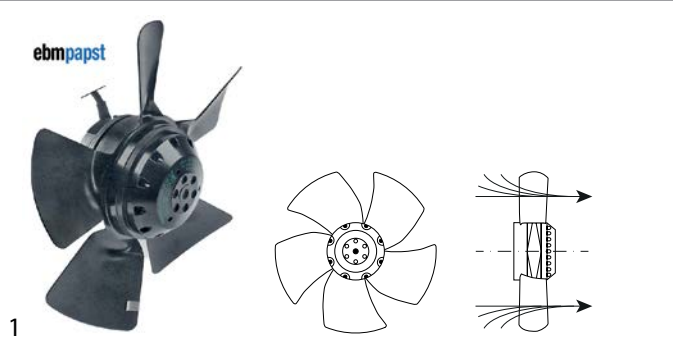

1	<b>GEV No.</b>	601959	<b>Ref. No.</b>	184722 771985005224
<b>description</b> fan A2E250-AE65-02 fan wheel ø 250mm blades 5 230V 50/60Hz 115/165W 2550/2750rpm cable length 1800mm ebm-papst blowing				

R2E series

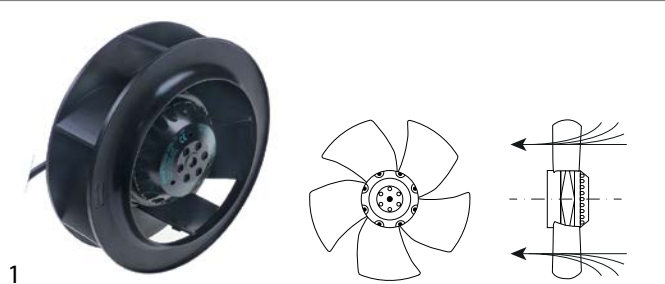

1	<b>GEV No.</b>	601536	<b>Ref. No.</b>	771985010360
<b>description</b> fan R2E190-A026-73 fan wheel ø 190mm blades 6 230V 50/60Hz 58/75W ø 190mm H 70mm 2700rpm cable length 450mm rotation direction right ebm-papst sucking suitable capacitor 2µF				
<b>spare parts for</b> 601536				
	<b>GEV No.</b>	365170	<b>Ref. No.</b>	—
 capacitor capacity 2µF 425V tolerance 5% 50/60Hz ambient temperature max. -25 to +85°C ø 25mm L 49mm M8 plastic connection cable 250mm 416.17.74 protection				

cross flow fans

EMMEVI - FERGAS

with moulded coils



1	<b>GEV No.</b>	601110	<b>Ref. No.</b>	483286008073
<b>description</b> cross flow fan TGO 60/1-180/20 roller ø 60mm roller length 180mm laminated core thickness 20mm motor position left 230V/50Hz 28W refrigeration bearing rubber connection male faston 6.3mm -30 up to +100°C 230V cable length 1800mm				

COPREL

with standard coil



1	<b>GEV No.</b>	602044	<b>Ref. No.</b>	483286008055
<b>description</b> cross flow fan COPREL TFR 180/20-14CSN roller ø 60mm roller length 180mm laminated core thickness 20mm motor position right 230V/50Hz 27W refrigeration bearing rubber connection male faston 6.3mm t.max. 60°C airflow 144m³/h -30 bis +60°C				





hot air motors

 <p>1</p>			
<b>GEV No.</b>	550049	<b>Ref. No.</b>	483286008699
<b>description</b>	counterflange for fan motor ED $\varnothing$ 60mm int. $\varnothing$ 1 27.3mm int. $\varnothing$ 2 18.5mm thickness 5.8mm brass		

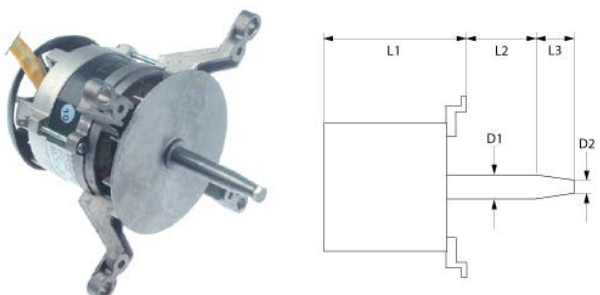
 <p>1</p>			
<b>GEV No.</b>	500630	<b>Ref. No.</b>	483286008681
<b>description</b>	fan motor 230/400V 3 phase 50Hz 0.37kW 2600rpm speeds 1 L1 175mm L2 50mm L3 28mm D1 $\varnothing$ 17mm D2 $\varnothing$ 12mm M8R IT 1.1/1.9A Cos(fi) 0.75 at 50Hz 2600rpm type 1020.5450		

 <p>1</p>			
<b>GEV No.</b>	602082	<b>Ref. No.</b>	771985000205
<b>description</b>	fan wheel blades 6 D1 $\varnothing$ 440mm D2 $\varnothing$ 10mm D3 $\varnothing$ 10mm H1 154mm H2 15mm		

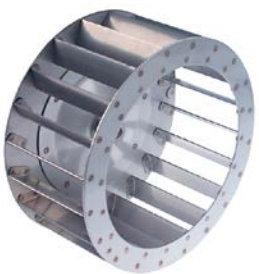
 <p>1</p>			
<b>GEV No.</b>	514261	<b>Ref. No.</b>	483286008701
<b>description</b>	fan wheel D1 $\varnothing$ 210mm H1 100mm blades 20 D2 $\varnothing$ 11mm D3 $\varnothing$ 16mm H2 30mm		

 <p>1</p>			
<b>GEV No.</b>	541580	<b>Ref. No.</b>	483286002963
<b>description</b>	fan wheel D1 $\varnothing$ 250mm H1 120mm blades 26 D2 $\varnothing$ 11.5mm D3 $\varnothing$ 16.5mm H2 29mm		

 <p>1</p>			
<b>GEV No.</b>	514262	<b>Ref. No.</b>	483286002963
<b>description</b>	fan wheel D1 $\varnothing$ 250mm H1 120mm blades 26 D2 $\varnothing$ 11mm D3 $\varnothing$ 16mm H2 30mm		

pumps

wash and rinse pumps



LGB

 <p>1</p>			
<b>GEV No.</b>	500567	<b>Ref. No.</b>	483286008976
<b>description</b>	pump inlet $\varnothing$ 28mm outlet $\varnothing$ 28mm type ZF121DX 230V 50Hz 1 phase 0.25kW L 195mm rotation direction left capacitor 6.3 $\mu$ F LGB		
<b>spare parts for</b>	500567		
	<b>GEV No.</b>	365012	<b>Ref. No.</b> —
	operating capacitor capacity 6.3 $\mu$ F 450V tolerance 5% 50Hz ambient temperature max. -25 to +85°C $\varnothing$ 30mm L 61mm M8 plastic connection male faston 6.3mm protection		
	<b>GEV No.</b>	510703	<b>Ref. No.</b> —
	mechanical shaft seal for shaft $\varnothing$ 13mm slide ring H 13mm height counter ring 5.5mm ED $\varnothing$ 26mm		

Table continues overleaf





<b>spare parts for</b> 500567			
	GEV No.	521098	Ref. No. —
pump cover LGB inlet ø 28mm outlet ø 26mm auxiliary pressure connection 12mm ID ø 77mm			
	GEV No.	521099	Ref. No. —
impellor ø 72mm H 17mm thread M7R shaft ø 13mm shaft length 12mm			
	GEV No.	528800	Ref. No. —
O-ring EPDM thickness 2.62mm ID ø 75.87mm Qty 1 pcs			



<b>1</b>			
<b>GEV No.</b>	500508	<b>Ref. No.</b>	483286008775
<b>description</b>	pump inlet ø 45mm outlet ø 38mm type ZF320VSX 230V 50Hz 1 phase 0.75kW 1HP L 230mm rotation direction right capacitor 12.5µF LGB		
<b>spare parts for</b> 500508			
	GEV No.	365014	Ref. No. —
operating capacitor capacity 12.5µF 450V tolerance 5%Hz ambient temperature max. -25 to +85°C ø 35mm L 70mm M8 plastic connection male faston 6.3mm 455.C3D5.12.5 protection			
	GEV No.	510702	Ref. No. —
mechanical shaft seal height counter ring 5.5mm ID ø 12mm			
	GEV No.	521247	Ref. No. —
impellor ø 90mm H 27mm rotation direction right thread M8L blades 6			
	GEV No.	521542	Ref. No. —
pump cover LGB inlet ø 45mm outlet ø 40mm auxiliary pressure connection 13mm supporting pressure open ø 150mm ID ø 120mm inner height 25mm			
	GEV No.	521714	Ref. No. —
pump cover gasket thickness 4x4mm Qty 1 pcs			

### drain pumps

#### GRE



<b>1</b>			
<b>GEV No.</b>	500385	<b>Ref. No.</b>	483286000127
<b>description</b>	drain pump inlet ø 30mm outlet ø 21mm 100W 230V 50Hz GRE		
<b>accessories for</b> 500385			
	GEV No.	500307	Ref. No. —
filter			



<b>1</b>			
<b>GEV No.</b>	500959	<b>Ref. No.</b>	483286003283
<b>description</b>	drain pump inlet ø 30mm outlet ø 23mm 100W 230V 50Hz GRE		

### vibration pumps

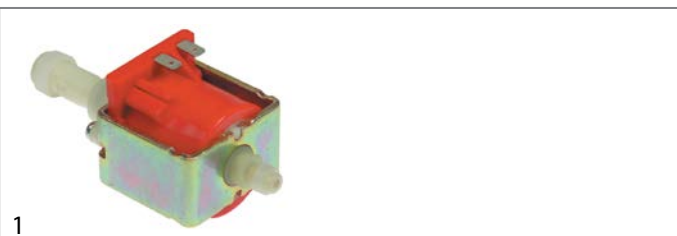

<b>1</b>			
<b>GEV No.</b>	500564	<b>Ref. No.</b>	483286002395
<b>description</b>	vibration pump type EP 5 230V 48W 50Hz inlet ø 6 outlet ø 1/8" IT ULKA L 123mm		



<b>1</b>			
<b>GEV No.</b>	500173	<b>Ref. No.</b>	483286002395
<b>description</b>	vibration pump type EP 5 230V 48W 50Hz inlet ø 6 outlet ø 1/8" IT ULKA outlet flat plastic L 123mm		



pumps for ice machines





1

<b>GEV No.</b>	500597	<b>Ref. No.</b>	186545
<b>description</b>	pump GRE type MH50F 60W 230V 50Hz outlet ø 21mm L 110mm rotation direction right for ice maker		



1

<b>GEV No.</b>	500166	<b>Ref. No.</b>	185340	
<b>description</b>	pump REBO type 63/45 150W 230V 50/60Hz inlet ø 28mm outlet ø 26mm L 200mm rotation direction right capacitor 5µF			
<b>spare parts for</b>	500166			
	<b>GEV No.</b>	365017	<b>Ref. No.</b>	—
	operating capacitor capacity 5µF 450V tolerance 5% 50/60Hz ambient temperature max. -25 to +85°C ø 28mm L 54mm M8 plastic connection male faston 6.3mm 16.10.08 protection			
	<b>GEV No.</b>	601412	<b>Ref. No.</b>	—
	fan wheel sucking ø 154mm fan wheel mounting 25.4mm blade angle 28° W 34mm plastic			
	<b>GEV No.</b>	601413	<b>Ref. No.</b>	—
	fixing plate suitable for fanwheel ED ø 32mm shaft ø 7 mounting distance 26mm			



1

<b>GEV No.</b>	500047	<b>Ref. No.</b>	186389
<b>description</b>	pump REBO type MH30F1 30W 230V 50Hz outlet ø 12.7mm L 135mm rotation direction left		



1

<b>GEV No.</b>	500048	<b>Ref. No.</b>	186124
<b>description</b>	pump REBO type MH50F 60W 230V 50Hz outlet ø 18mm L 137mm rotation direction right for ice maker		



1

<b>GEV No.</b>	500203	<b>Ref. No.</b>	186166
<b>description</b>	pump REBO type MH50F 60W 230V 50Hz outlet ø 21mm L 110mm rotation direction right for ice maker		



1

<b>GEV No.</b>	501476	<b>Ref. No.</b>	481936178251 48400000908
<b>description</b>	pump type T3400 50W 220V 50Hz outlet ø 14mm L 105mm rotation direction right for ice-cube maker		

condensators & interference suppression filters

interference suppression filters



1

<b>GEV No.</b>	365090	<b>Ref. No.</b>	483286008712
<b>description</b>	interference suppression filter 250V 50/60Hz capacity 0.47µF(X2)+2X0.027µF(Y2)+2x1mH+0.68MµF		



1

<b>GEV No.</b>	365168	<b>Ref. No.</b>	483286008914
<b>description</b>	interference suppression filter type FCP045000 250V 50/60Hz conductor 4 with E connection male faston 6.3mm L 56mm ø 38mm Hmm Wmm M8 plastic Qty 1 pcs		

## RC circuits



1

<b>GEV No.</b>	380056	<b>Ref. No.</b>	483286002398
<b>description</b>	RC circuit 250V		



1

<b>GEV No.</b>	380738	<b>Ref. No.</b>	483286002493
<b>description</b>	RC circuit type 11BGX79240 suitable for BG series rated 125-240VACV		



1

<b>GEV No.</b>	380055	<b>Ref. No.</b>	483286002486
<b>description</b>	RC circuit voltage AC/DC suitable for BF09-32 rated 240V		

## electric accessories

## terminals

## terminal blocks



1

<b>GEV No.</b>	550838	<b>Ref. No.</b>	483286000846
<b>description</b>	lustre terminal 12-pole cross section 6mm <sup>2</sup> max. 41A max 750V temp.-resist. 150°C		

## electronic magnets



1

<b>GEV No.</b>	691625	<b>Ref. No.</b>	483286002434
<b>description</b>	electronic magnet 230V 50Hz duty cycle 100% L 57mm W 46mm H 32mm		













## gas taps

## PEL









## 21S series



1

<b>GEV No.</b>	101397	<b>Ref. No.</b>	483286009272	
<b>description</b>	gas tap PEL type 21S gas inlet M16x1.5 (tube ø 10mm) bypass nozzle ø 0.35mm gas outlet M16x1.5 (tube ø 10/8mm) thermocouple connection M9x1 pilot connection M10x1 shaft ø 8x6.5mm shaft L 22/15mm shaft flat lower			
<b>For models:</b>	AGB352WP, AGB353WP, AGB354WP			
<b>spare parts for</b>	101397			
	<b>GEV No.</b>	100408	<b>Ref. No.</b>	—
	bypass nozzle type PEL20/21 bore ø 0.35mm thread M5x0.5			
	<b>GEV No.</b>	101060	<b>Ref. No.</b>	—
	magnet unit standard L 39mm D1 ø 15.4mm D2 ø 11mm suitable for PEL20-21/JUNKERS/EGA			
	<b>GEV No.</b>	101206	<b>Ref. No.</b>	—
	gas tap front part shaft ø 8x6.5mm shaft L 22/15mm shaft flat upper/lower suitable for PEL21			
	<b>GEV No.</b>	101231	<b>Ref. No.</b>	—
	thermocouple nut T1: M9x1 T2: M18x1			
<b>accessories for</b>	101397			
	<b>GEV No.</b>	100908	<b>Ref. No.</b>	—
	union screw thread M10x1 for pipe ø 4mm Qty 1 pcs			
	<b>GEV No.</b>	100909	<b>Ref. No.</b>	—
	union screw thread M10x1 for pipe ø 6mm Qty 1 pcs			
	<b>GEV No.</b>	101246	<b>Ref. No.</b>	—
	olive for pipe ø 4mm Qty 1 pcs			
	<b>GEV No.</b>	101278	<b>Ref. No.</b>	—
	olive for pipe ø 10mm Qty 1 pcs			
	<b>GEV No.</b>	101286	<b>Ref. No.</b>	—
	olive ID ø 6mm Qty 1 pcs			
	<b>GEV No.</b>	101300	<b>Ref. No.</b>	—
	union nut thread M16x1.5 tube ø 10mm			
	<b>GEV No.</b>	101450	<b>Ref. No.</b>	—
	olive for pipe ø 8mm L 12.7mm Qty 1 pcs ED ø 10mm			
	<b>GEV No.</b>	101451	<b>Ref. No.</b>	—
	union nut thread M16x1.5 tube ø 8mm			
	<b>GEV No.</b>	110081	<b>Ref. No.</b>	—
	knob ø 70mm shaft ø 8x6.5mm shaft flat universal			
	<b>GEV No.</b>	112206	<b>Ref. No.</b>	—
	knob dial plate silver gas tap PEL21/22/23 t.max.°C ED ø 63mm ID ø 45.5mm			



			
1			
<b>GEV No.</b>	101897	<b>Ref. No.</b>	270205
<b>description</b>	gas tap PEL type 215 gas inlet pipe flange ø21mm bypass nozzle ø 0.35mm gas outlet M16x1.5 (tube ø 10/8mm) thermocouple connection M8x1 pilot connection M10x1 shaft ø 8x6.5mm shaft L 32/25mm shaft flat upper		
<b>spare parts for</b>	101897		
	<b>GEV No.</b>	101060	<b>Ref. No.</b> —
	magnet unit standard L 39mm D1 ø 15.4mm D2 ø 11mm suitable for PEL20-21/JUNKERS/EGA		
	<b>GEV No.</b>	101230	<b>Ref. No.</b> —
	thermocouple nut T1: M8x1 T2: M18x1 aluminium		
	<b>GEV No.</b>	101875	<b>Ref. No.</b> —
	gas tap front part shaft ø 8x6.5mm shaft L 32/25mm shaft flat upper/lower type PEL21		
	<b>GEV No.</b>	528347	<b>Ref. No.</b> —
	O-ring Viton thickness 1.78mm ID ø 2.9mm Qty 1 pcs		
<b>accessories for</b>	101897		
	<b>GEV No.</b>	100908	<b>Ref. No.</b> —
	union screw thread M10x1 for pipe ø 4mm Qty 1 pcs		
	<b>GEV No.</b>	100909	<b>Ref. No.</b> —
	union screw thread M10x1 for pipe ø 6mm Qty 1 pcs		
	<b>GEV No.</b>	101246	<b>Ref. No.</b> —
	olive for pipe ø 4mm Qty 1 pcs		
	<b>GEV No.</b>	101278	<b>Ref. No.</b> —
	olive for pipe ø 10mm Qty 1 pcs		
	<b>GEV No.</b>	101286	<b>Ref. No.</b> —
	olive ID ø 6mm Qty 1 pcs		
	<b>GEV No.</b>	101300	<b>Ref. No.</b> —
	union nut thread M16x1.5 tube ø 10mm		
	<b>GEV No.</b>	110081	<b>Ref. No.</b> —
	knob ø 70mm shaft ø 8x6.5mm shaft flat universal		
	<b>GEV No.</b>	112206	<b>Ref. No.</b> —
	knob dial plate silver gas tap PEL21/22/23 t.max.°C ED ø 63mm ID ø 45.5mm		











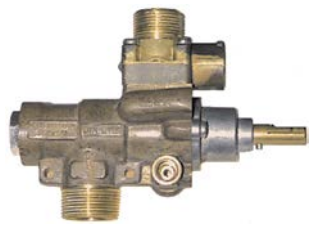







23S/V series			
			
1			
<b>GEV No.</b>	101093	<b>Ref. No.</b>	483286009212
<b>description</b>	gas tap PEL type 23S/V gas inlet M28x1.5 (tube ø 20mm) bypass nozzle ø 0.35mm thermocouple connection M10x1 pilot connection M10x1 shaft ø 10x8mm shaft L 25/17mm shaft flat lower		
<b>spare parts for</b>	101093		
	<b>GEV No.</b>	100455	<b>Ref. No.</b> —
	bypass nozzle type PEL23/24 bore ø 0.35mm thread M8x0.5		
	<b>GEV No.</b>	101059	<b>Ref. No.</b> —
	magnet unit T1: M10x1 T2: M22x1 L 46mm ø 18mm suitable for PEL23S M10x1		
	<b>GEV No.</b>	101204	<b>Ref. No.</b> —
	gas tap front part shaft ø 10x8mm shaft L 25/17mm shaft flat upper/lower suitable for PEL23S		
	<b>GEV No.</b>	101245	<b>Ref. No.</b> —
	gas connection thread M24x1.5 tube ø 12/16mm vertical for PEL gas taps		
	<b>GEV No.</b>	101463	<b>Ref. No.</b> —
	screw suitable for PEL23S Qty 4 pcs		
	<b>GEV No.</b>	528455	<b>Ref. No.</b> —
	O-ring Viton thickness 2.62mm ID ø 18.72mm Qty 1 pcs		
<b>accessories for</b>	101093		
	<b>GEV No.</b>	100908	<b>Ref. No.</b> —
	union screw thread M10x1 for pipe ø 4mm Qty 1 pcs		
	<b>GEV No.</b>	100909	<b>Ref. No.</b> —
	union screw thread M10x1 for pipe ø 6mm Qty 1 pcs		
	<b>GEV No.</b>	101246	<b>Ref. No.</b> —
	olive for pipe ø 4mm Qty 1 pcs		
	<b>GEV No.</b>	101252	<b>Ref. No.</b> —
	union nut thread M24x1.5 for pipe ø 12mm		
	<b>GEV No.</b>	101253	<b>Ref. No.</b> —
	union nut thread M24x1.5 PEL for pipe ø 16mm		
	<b>GEV No.</b>	101254	<b>Ref. No.</b> —
	union nut thread M28x1.5 tube ø 20mm		
	<b>GEV No.</b>	101255	<b>Ref. No.</b> —
	olive for pipe ø 12mm Qty 1 pcs		
	<b>GEV No.</b>	101256	<b>Ref. No.</b> —
	olive for pipe ø 16mm Qty 1 pcs		
	<b>GEV No.</b>	101257	<b>Ref. No.</b> —
	olive for pipe ø 20mm Qty 1 pcs		

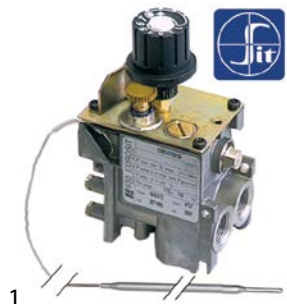





Table continues overleaf

<b>accessories for</b>	101093			
	GEV No.	101286	Ref. No.	—
	olive ID ø 6mm Qty 1 pcs			
	GEV No.	110080	Ref. No.	—
	knob ø 70mm shaft ø 10x8mm shaft flat universal			
	GEV No.	112206	Ref. No.	—
	knob dial plate silver gas tap PEL21/22/23 t.max.°C ED ø 63mm ID ø 45.5mm			

## gas thermostats

### SIT

#### 630 Eurosit series

	<b>GEV No.</b>	101188	<b>Ref. No.</b>	483286000479
	<b>description</b>	gas thermostat type 630 Eurosit series t.max. 190°C 110-190°C gas inlet 3/8" gas outlet 3/8" thermocouple connection M9x1 pilot connection M10x1 probe ø 4mm probe L 202mm capillary pipe 1050mm SIT		
<b>accessories for</b>	101188			
	GEV No.	100904	Ref. No.	—
	locking screw M10x1 for pipe ø 4mm Qty 1 pcs			
	GEV No.	100905	Ref. No.	—
	locking screw M10x1 for pipe ø 6mm Qty 1 pcs			
	GEV No.	101273	Ref. No.	—
	olive for pipe ø 12mm L 9.5mm brass Qty 1 pcs suitable for universal			
	GEV No.	101276	Ref. No.	—
	union screw thread 3/8" tube ø 12mm Qty 1 pcs			
	GEV No.	101333	Ref. No.	—
	plug thread 3/8" with O-ring			

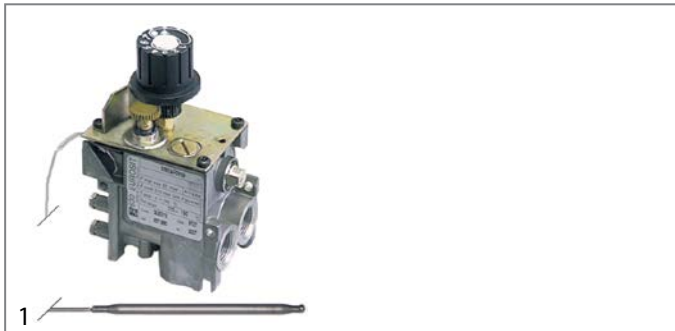

<b>GEV No.</b>	101409	<b>Ref. No.</b>	158772	
<b>description</b>	gas thermostat type 630 Eurosit series t.max. 280°C 40-280°C gas inlet 3/8" gas outlet 3/8" thermocouple connection M9x1 pilot connection M10x1 probe ø 4mm probe L 72mm capillary pipe 1050mm SIT			
<b>accessories for</b>	101409			
	GEV No.	101333	Ref. No.	—
	plug thread 3/8" with O-ring			
<b>accessories for</b>	101409			
	GEV No.	100904	Ref. No.	—
	locking screw M10x1 for pipe ø 4mm Qty 1 pcs			
	GEV No.	100905	Ref. No.	—
	locking screw M10x1 for pipe ø 6mm Qty 1 pcs			
	GEV No.	101273	Ref. No.	—
	olive for pipe ø 12mm L 9.5mm brass Qty 1 pcs suitable for universal			
	GEV No.	101276	Ref. No.	—
	union screw thread 3/8" tube ø 12mm Qty 1 pcs			







<b>GEV No.</b>	101915	<b>Ref. No.</b>	483286009225	
<b>description</b>	gas thermostat type 630 Eurosit series t.max. 320°C 80-320°C gas inlet 3/8" gas outlet 3/8" thermocouple connection M9x1 pilot connection M10x1 probe ø 4mm probe L 72mm capillary pipe 1050mm SIT			
<b>For models:</b>	AGB352WP, AGB353WP, AGB354WP			
<b>accessories for</b>	101915			
	GEV No.	100825	Ref. No.	—
	gas tap spindle shaft ø 8x6.5mm shaft L 22/14mm suitable for EUROSIT			
	GEV No.	100904	Ref. No.	—
	locking screw M10x1 for pipe ø 4mm Qty 1 pcs			
	GEV No.	100905	Ref. No.	—
	locking screw M10x1 for pipe ø 6mm Qty 1 pcs			
	GEV No.	100949	Ref. No.	—
	gasket suitable for 630 Eurosit series			



Table continues overleaf





accessories for		101915	
	GEV No.	101273	Ref. No. —
olive for pipe ø 12mm L 9.5mm brass Qty 1 pcs suitable for universal			
	GEV No.	101276	Ref. No. —
union screw thread 3/8" tube ø 12mm Qty 1 pcs			
	GEV No.	101333	Ref. No. —
plug thread 3/8" with O-ring			
	GEV No.	101390	Ref. No. —
gas tap spindle shaft ø 6x4.6mm shaft L 32/15mm gas tap with ignition flame suitable for ZANUSSI, MARENO for gas thermostat EUROSIT			
	GEV No.	101392	Ref. No. —
adapter suitable for 630 Eurosit series			
	GEV No.	110357	Ref. No. —
gas tap spindle shaft ø 8x6.5mm shaft L 36/12mm suitable for 630 Eurosit series			
	GEV No.	110358	Ref. No. —
adapter shaft ø 10x8mm shaft L 29/18mm suitable for 630 Eurosit series			

## 710 Minisit series

			
1			
GEV No.	107237	Ref. No.	153360 771985026824
description	gas thermostat without cap, button and angle SIT type MINISIT 710 t.max. 210°C 70-210°C gas inlet 1/2" gas outlet 3/8" thermocouple connection M9x1 pilot connection M10x1 probe ø 4mm probe L 122mm capillary pipe 1300mm probe type pressure controller no pressure regulator mbar gland nut		
accessories for		107237	
	GEV No.	101137	Ref. No. —
cover cap without piezoelectric igniter			
	GEV No.	101267	Ref. No. —
reducer IT 3/8" ET 1/2" L 21mm			
	GEV No.	101268	Ref. No. —
gas connection thread 3/8" angled with O-ring MINISIT 710			
	GEV No.	110068	Ref. No. —
knob suitable for Minisit ø 37mm			

## PEL

### 25ST series

			
1			
GEV No.	101955	Ref. No.	771985000630
description	gas thermostat PEL type 25ST 140 up to approx. 300°C gas inlet M16x1.5 (tube ø 10mm) bypass nozzle ø 0.5mm gas outlet M16x1.5 (tube ø 10/8mm) thermocouple connection M8x1 pilot connection M10x1 capillary pipe 1200mm probe ø 6mm probe L 120mm shaft ø 8x6.5mm shaft L 38/15mm shaft flat upper		
spare parts for		101955	
	GEV No.	100390	Ref. No. —
bypass nozzle type PEL22 bore ø 0.5mm thread M6x0.5			
	GEV No.	101060	Ref. No. —
magnet unit standard L 39mm D1 ø 15.4mm D2 ø 11mm suitable for PEL20-21/JUNKERS/EGA			
	GEV No.	106199	Ref. No. —
nut thread M8x1			
accessories for		101955	
	GEV No.	100908	Ref. No. —
union screw thread M10x1 for pipe ø 4mm Qty 1 pcs			
	GEV No.	100909	Ref. No. —
union screw thread M10x1 for pipe ø 6mm Qty 1 pcs			
	GEV No.	101246	Ref. No. —
olive for pipe ø 4mm Qty 1 pcs			
	GEV No.	101278	Ref. No. —
olive for pipe ø 10mm Qty 1 pcs			
	GEV No.	101286	Ref. No. —
olive ID ø 6mm Qty 1 pcs			
	GEV No.	101300	Ref. No. —
union nut thread M16x1.5 tube ø 10mm			
	GEV No.	101450	Ref. No. —
olive for pipe ø 8mm L 12.7mm Qty 1 pcs ED ø 10mm			
	GEV No.	101451	Ref. No. —
union nut thread M16x1.5 tube ø 8mm			
	GEV No.	110079	Ref. No. —
knob dial plate gas thermostat 1-8 silver			
	GEV No.	110081	Ref. No. —
knob ø 70mm shaft ø 8x6.5mm shaft flat universal			



conversion kits



<b>GEV No.</b>	106751	<b>Ref. No.</b>	270006
<b>description</b>	gas thermostat PEL type 25ST 150-290°C gas inlet M16x1.5 pipe input ø 10mm gas outlet M16x1.5 pipe output ø 10/8mm thermo-couple connection M8x1 probe ø 6mm probe L 120mm capillary pipe 1200mm shaft ø 8x6.5mm shaft L 25mm bypass nozzle ø 0.45/0.5/0.55/0.8/0.9mm conversion kit L1 25mm L2 15mm incl. gas/ignition gas line, nozzles, knob shaft flat upper		

<b>accessories for</b>	106280			
	<b>GEV No.</b>	101307	<b>Ref. No.</b>	—
	gas connection straight flange 45x45mm hole distance 36x36mm 3/4" ELETTROSIT/V4400/4600/4605 screw with O-ring suitable for SIT/HONEYWELL			
	<b>GEV No.</b>	101308	<b>Ref. No.</b>	—
	gas connection angled flange 45x45mm hole distance 36x36mm 3/4" ELETTROSIT/V4400/4600/4605 screw with O-ring suitable for SIT/HONEYWELL			

gas valves and ignition boxes

gas control valves

HONEYWELL



<b>GEV No.</b>	106012	<b>Ref. No.</b>	483286002568	
<b>description</b>	gas valve type VK4115V 220-240V 50/60Hz gas inlet flange 32x32mm gas outlet flange 32x32mm thermocouple connection pilot connection pressure range 15-60mbar max 60mbar operator type HONEYWELL flange 32x32mm			
<b>accessories for</b>	106012			
	<b>GEV No.</b>	102845	<b>Ref. No.</b>	—
	gas connection angled 1/2" flange 32x32mm hole distance 24x24mm Tandem			
	<b>GEV No.</b>	102846	<b>Ref. No.</b>	—
	gas connection straight 1/2" flange 32x32mm hole distance 24x24mm suitable for Tandem			



<b>GEV No.</b>	106280	<b>Ref. No.</b>	483286003056	
<b>description</b>	gas valve type VK4115V 230V 50Hz gas inlet 3/8" gas outlet ø 14mm, edgewise max 60mbar HONEYWELL			
<b>accessories for</b>	106280			
	<b>GEV No.</b>	101305	<b>Ref. No.</b>	—
	gas connection straight 1/2" flange 45x45mm ELETTROSIT/V4400/4600/4605 suitable for SIT/HONEYWELL hole distance 36x36mm			
	<b>GEV No.</b>	101306	<b>Ref. No.</b>	—
	gas connection angled flange 45x45mm hole distance 36x36mm 1/2" ELETTROSIT/V4400/4600/4605 screw with O-ring suitable for SIT/HONEYWELL			

SIT  
NOVASIT

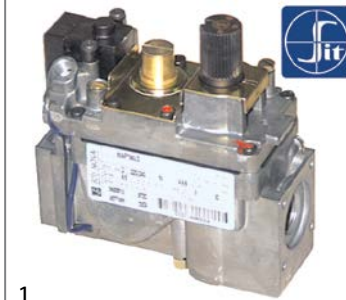

<b>GEV No.</b>	101162	<b>Ref. No.</b>	483286009413	
<b>description</b>	gas valve SIT series Novasit 820 230V 50Hz gas inlet 1/2" gas outlet 1/2" thermocouple connection M9x1 pilot connection M10x1 ignition pressure 3-5mbar pressure range 3-30mbar pressure regulator connection blind equiv. no. 0.820.010			
<b>spare parts for</b>	101162			
	<b>GEV No.</b>	101065	<b>Ref. No.</b>	—
	magnet unit with cable L 44mm D1 ø 30mm D2 ø 20mm suitable for NOVASIT			
	<b>GEV No.</b>	101313	<b>Ref. No.</b>	—
	solenoid coil 230V 50Hz			
<b>accessories for</b>	101162			
	<b>GEV No.</b>	100006	<b>Ref. No.</b>	—
	piezoelectric igniter suitable for ELETTROSIT body plastic blowing connection ø2.4mm ø 14mm			
	<b>GEV No.</b>	101305	<b>Ref. No.</b>	—
	gas connection straight 1/2" flange 45x45mm ELETTROSIT/V4400/4600/4605 suitable for SIT/HONEYWELL hole distance 36x36mm			
	<b>GEV No.</b>	101306	<b>Ref. No.</b>	—
	gas connection angled flange 45x45mm hole distance 36x36mm 1/2" ELETTROSIT/V4400/4600/4605 screw with O-ring suitable for SIT/HONEYWELL			
	<b>GEV No.</b>	101307	<b>Ref. No.</b>	—
	gas connection straight flange 45x45mm hole distance 36x36mm 3/4" ELETTROSIT/V4400/4600/4605 screw with O-ring suitable for SIT/HONEYWELL			
	<b>GEV No.</b>	101308	<b>Ref. No.</b>	—
	gas connection angled flange 45x45mm hole distance 36x36mm 3/4" ELETTROSIT/V4400/4600/4605 screw with O-ring suitable for SIT/HONEYWELL			
	<b>GEV No.</b>	101312	<b>Ref. No.</b>	483286009412
	microswitch			
	<b>GEV No.</b>	101314	<b>Ref. No.</b>	—
	solenoid coil 24V 50Hz			
	<b>GEV No.</b>	101317	<b>Ref. No.</b>	—
	plug with cable L 1000mm suitable for NOVASIT			

Table continues overleaf





<b>accessories for</b>	101162			
	GEV No.	101318	Ref. No.	—
	cover cap for solenoid coil suitable for NOVASIT			





<b>GEV No.</b>	101967	<b>Ref. No.</b>	483286008689	
<b>description</b>	gas valve SIT series Novasit 822 230V 50Hz gas inlet 1/2" gas outlet 1/2" thermocouple connection pilot connection M10x1 ignition pressure 3-5mbar pressure range 3-30mbar pressure regulator connection perforated equiv. no. 0.822.110			

<b>spare parts for</b>	101967			
	GEV No.	101313	Ref. No.	—
	solenoid coil 230V 50Hz			

	GEV No.	101542	Ref. No.	—
	solenoid coil 50Hz NOVA 822/826/827 suitable for NOVASIT 230V			

<b>accessories for</b>	101967			
	GEV No.	100904	Ref. No.	—
	locking screw M10x1 for pipe ø 4mm Qty 1 pcs			

	GEV No.	100905	Ref. No.	—
	locking screw M10x1 for pipe ø 6mm Qty 1 pcs			

	GEV No.	101305	Ref. No.	—
	gas connection straight 1/2" flange 45x45mm ELETTROSIT/V4400/4600/4605 suitable for SIT/HONEYWELL hole distance 36x36mm			

	GEV No.	101306	Ref. No.	—
	gas connection angled flange 45x45mm hole distance 36x36mm 1/2" ELETTROSIT/V4400/4600/4605 screw with O-ring suitable for SIT/HONEYWELL			

	GEV No.	101307	Ref. No.	—
	gas connection straight flange 45x45mm hole distance 36x36mm 3/4" ELETTROSIT/V4400/4600/4605 screw with O-ring suitable for SIT/HONEYWELL			

	GEV No.	101308	Ref. No.	—
	gas connection angled flange 45x45mm hole distance 36x36mm 3/4" ELETTROSIT/V4400/4600/4605 screw with O-ring suitable for SIT/HONEYWELL			

	GEV No.	101503	Ref. No.	—
	O-ring EPDM thickness 2mm ID ø 32mm Qty 1 pcs			

	GEV No.	101924	Ref. No.	—
	plug with cable L 1090mm suitable for NOVA 822/826/827			

<b>accessories</b>	1			
	GEV No.	101312	Ref. No.	483286009412
<b>description</b>	microswitch			

	GEV No.	101859	Ref. No.	483286003052
<b>description</b>	panel-mounted inlet with cable L 1000mm for rectifier suitable for NOVASIT			

## ignition boxes

### HONEYWELL

	GEV No.	102367	Ref. No.	483286002569
<b>description</b>	ignition box HONEYWELL type S4565A 2092 1 electrodes 3 waiting times safety time 10s 220-240V 4VA 50/60Hz			

## safety valves

### SIT

#### 400 series





	GEV No.	101470	Ref. No.	483286009416
<b>description</b>	safety valve front fixing M12x1 pressure range 50mbar gas inlet 1/8" IT gas outlet 1/8" - M6x0.75 thermocouple connection M8x1 equiv. no. 0.400.088 suitable for SIT			
<b>spare parts for</b>	101470			
	GEV No.	101052	Ref. No.	—
	magnet unit L 43.5mm D1 ø 15.3mm D2 ø 10.5mm suitable for SIT M1			
<b>accessories for</b>	101470			
	GEV No.	101299	Ref. No.	—
	nut thread M12x1			

Table continues overleaf

<b>accessories for</b>	101470		
	GEV No.	101499	Ref. No. —
	protection cap for safety valve thread M12x0.75 ID ø 18mm L 24mm aluminium		













## ignition parts





### pilot burners

#### SIT

#### 100 series



<b>GEV No.</b>	106904	<b>Ref. No.</b>	483286009246
<b>description</b>	pilot burner SIT type 100 series 1 flame nozzle ø 0.2mm gas connection 6mm		
<b>spare parts for</b>	106904		
	GEV No.	100245	Ref. No. —
	pilot burner nozzle LPG code 20 bore ø 0.2mm Qty 1 pcs thread M8x0.75		
	GEV No.	100855	Ref. No. —
	pilot burner bracket triple		
	GEV No.	100885	Ref. No. —
	air mixing sleeve for pilot burner Qty 1 pcs		
	GEV No.	100916	Ref. No. —
	compression spring for pilot burner Qty 1 pcs		
	GEV No.	100917	Ref. No. —
	gasket for pilot burner Qty 1 pcs aluminium		
	GEV No.	100918	Ref. No. —
	screw for pilot burner		
	GEV No.	107160	Ref. No. —
	pilot burner cap SIT 1 flame Hmm Lmm Qty 1 pcs		
	GEV No.	107166	Ref. No. —
	pilot burner head SIT 1 flame Hmm Lmm Qty 1 pcs		
	GEV No.	107701	Ref. No. —
	pilot burner bottom part SIT 100 series nozzle ø 0.2mm		
<b>accessories for</b>	106904		
	GEV No.	100246	Ref. No. 483286009258
	pilot burner nozzle natural gas bore ø 0.35mm Qty 1 pcs thread M8x0.75		
	GEV No.	100904	Ref. No. —
	locking screw M10x1 for pipe ø 4mm Qty 1 pcs		
	GEV No.	100905	Ref. No. —
	locking screw M10x1 for pipe ø 6mm Qty 1 pcs		
	GEV No.	102110	Ref. No. —
	pilot tube copper pipe ø 4mm thickness 1mm L 3000mm		

<b>accessories for</b>	106904		
	GEV No.	102111	Ref. No. —
	pilot tube copper pipe ø 6mm thickness 1mm L 3000mm		
	GEV No.	107171	Ref. No. —
	pilot burner nozzle SIT natural/liquid gas bore ø 0.25mm Qty 1 pcs		
	GEV No.	107700	Ref. No. —
	pilot burner bottom part SIT 100 series nozzle ø 0.25mm		
	GEV No.	107702	Ref. No. —
	pilot burner bottom part SIT 100 series nozzle ø 0.35mm		















	<b>1</b>		
<b>GEV No.</b>	106906	<b>Ref. No.</b>	483286009215
<b>description</b>	pilot burner SIT type 100 series 3 flames nozzle ø 0.2mm gas connection 6mm		
<b>spare parts for</b>	106906		
	GEV No.	100245	Ref. No. —
	pilot burner nozzle LPG code 20 bore ø 0.2mm Qty 1 pcs thread M8x0.75		
	GEV No.	100855	Ref. No. —
	pilot burner bracket triple		
	GEV No.	100885	Ref. No. —
	air mixing sleeve for pilot burner Qty 1 pcs		
	GEV No.	100916	Ref. No. —
	compression spring for pilot burner Qty 1 pcs		
	GEV No.	100917	Ref. No. —
	gasket for pilot burner Qty 1 pcs aluminium		
	GEV No.	100918	Ref. No. —
	screw for pilot burner		
	GEV No.	107162	Ref. No. —
	pilot burner cap SIT 3 flames Hmm Lmm Qty 1 pcs		
	GEV No.	107701	Ref. No. —
	pilot burner bottom part SIT 100 series nozzle ø 0.2mm		
<b>accessories for</b>	106906		
	GEV No.	100245	Ref. No. —
	pilot burner nozzle LPG code 20 bore ø 0.2mm Qty 1 pcs thread M8x0.75		
	GEV No.	100246	Ref. No. 483286009258
	pilot burner nozzle natural gas bore ø 0.35mm Qty 1 pcs thread M8x0.75		
	GEV No.	100904	Ref. No. —
	locking screw M10x1 for pipe ø 4mm Qty 1 pcs		

Table continues overleaf













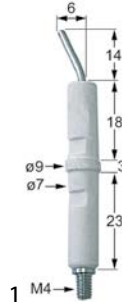





accessories for		106906	
	GEV No.	100905	Ref. No. —
locking screw M10x1 for pipe ø 6mm Qty 1 pcs			
	GEV No.	102110	Ref. No. —
pilot tube copper pipe ø 4mm thickness 1mm L 3000mm			
	GEV No.	102111	Ref. No. —
pilot tube copper pipe ø 6mm thickness 1mm L 3000mm			
	GEV No.	107171	Ref. No. —
pilot burner nozzle SIT natural/liquid gas bore ø 0.25mm Qty 1 pcs			
	GEV No.	107700	Ref. No. —
pilot burner bottom part SIT 100 series nozzle ø 0.25mm			
	GEV No.	107702	Ref. No. —
pilot burner bottom part SIT 100 series nozzle ø 0.35mm			

accessories			
pilot burner nozzles			
	1		
GEV No.	100247	Ref. No.	156578
description	pilot burner nozzle LPG bore ø 0.2mm Qty 1 pcs suitable for SIT 100 series thread M8x0.75		

	1		
GEV No.	100246	Ref. No.	483286009258
description	pilot burner nozzle natural gas bore ø 0.35mm Qty 1 pcs thread M8x0.75		
For models:	AGB352WP, AGB353WP, AGB354WP		

	1		
GEV No.	100248	Ref. No.	156750
description	pilot burner nozzle natural gas bore ø 0.3mm Qty 1 pcs suitable for SIT 100 series		

ignition electrodes			
	1		
GEV No.	100706	Ref. No.	483286009205
description	ignition electrode connection M4 Qty 1 pcs		

140 - 145 -150 series			
	1		
GEV No.	100170	Ref. No.	483286009227
description	pilot burner SIT type 150 series 1 flame nozzle ømm gas connecti-onmm		
spare parts for	100170		
	GEV No.	100907	Ref. No. —
screw connection thread M10x1 Qty 1 pcs type SEF 1 ømm for thermocouple			
accessories for	100170		
	GEV No.	100204	Ref. No. —
pilot burner nozzle SIT LPG code 14 bore ø 0.18/0.20mm Qty 1 pcs suitable for 140 series			
	GEV No.	100205	Ref. No. 483286009231
pilot burner nozzle SIT LPG code 19 bore ø 0.23/0.26mm Qty 1 pcs suitable for SIT 150 series			
	GEV No.	100206	Ref. No. 483286009232
pilot burner nozzle SIT natural gas code 36 bore ø 0.60/0.55mm Qty 1 pcs suitable for SIT 150 series			
	GEV No.	100207	Ref. No. —
pilot burner nozzle SIT natural gas code 27 bore ø 0.40/0.38mm suitable for SIT 140 series			
	GEV No.	100216	Ref. No. —
pilot burner nozzle SIT natural gas code 38 bore ø 0.45mm Qty 1 pcs suitable for SIT 150 series			
	GEV No.	100701	Ref. No. 483286009228
ignition electrode connection M4 Qty 1 pcs			
	GEV No.	100801	Ref. No. —
gasket for pilot burner Qty 1 pcs			
	GEV No.	100897	Ref. No. —
olive for pipe ø 4mm Qty 1 pcs for pilot burner			
	GEV No.	100898	Ref. No. —
olive for pipe ø 6mm Qty 1 pcs for pilot burner			
	GEV No.	100906	Ref. No. —
screw connection thread M10x1 for ignition electrode brass Qty 1 pcs WS 10			
	GEV No.	100908	Ref. No. —
union screw thread M10x1 for pipe ø 4mm Qty 1 pcs			
	GEV No.	100909	Ref. No. —
union screw thread M10x1 for pipe ø 6mm Qty 1 pcs			





accessories universal

covers



<b>GEV No.</b>	106572	<b>Ref. No.</b>	483286009639
<b>description</b>	cover for pilot burner		

electrodes

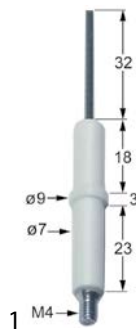

<b>GEV No.</b>	100701	<b>Ref. No.</b>	483286009228
<b>description</b>	ignition electrode connection M4 Qty 1 pcs		

accessories for 100701

	<b>GEV No.</b>	100906	<b>Ref. No.</b>	—
	screw connection thread M10x1 for ignition electrode brass Qty 1 pcs WS 10			



<b>GEV No.</b>	100706	<b>Ref. No.</b>	483286009205
<b>description</b>	ignition electrode connection M4 Qty 1 pcs		



<b>GEV No.</b>	102315	<b>Ref. No.</b>	483286008715
<b>description</b>	ignition electrode flange length 23mm flange width 15mm D1 ø 7mm L1 5mm BL1 30mm BL2 23mm connection F 2.8x0.8mm fixing dimensions ø5x4mm with flange		

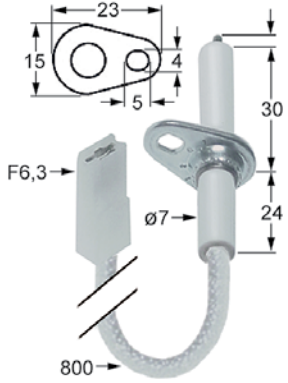

<b>GEV No.</b>	102316	<b>Ref. No.</b>	483286008714
<b>description</b>	ignition electrode flange length 23mm flange width 15mm D1 ø 7mm L1 5mm BL1 30mm BL2 24mm connection F 6.3 cable length 800mm fixing dimensions ø5x4mm with flange		



1

<b>GEV No.</b>	102293	<b>Ref. No.</b>	483286002563
<b>description</b>	ignition electrode flange length 51mm flange width 23mm cable length 440mm		



1

<b>GEV No.</b>	100004	<b>Ref. No.</b>	483286009198
<b>description</b>	piezoelectric igniter body plastic blowing mounting ø 18mm connection ø2.4mm		

ignition units



1

<b>GEV No.</b>	101002	<b>Ref. No.</b>	483286009414
<b>description</b>	ignition unit outputs 2 230VAC dimensions 88x23x34mm mounting distance 73mm inlet F6.3x0.8 outlet F2.8x0.8 0.6VA 50/60Hz		

ignition cables

pre-assembled cables



1

<b>GEV No.</b>	100176	<b>Ref. No.</b>	483286009303
<b>description</b>	ignition cable cable length 1000mm connection ø2.4mm / ø4mm permanent temperature 200°C		



1

<b>GEV No.</b>	100175	<b>Ref. No.</b>	483286009245
<b>description</b>	ignition cable cable length 1750mm connection ø2.4mm / ø4mm		



1

<b>GEV No.</b>	100178	<b>Ref. No.</b>	483286009409
<b>description</b>	ignition cable cable length 900mm connection F2.8mm / ø2.4mm		

piezoelectric igniters

mounting diameter 18mm



1

<b>GEV No.</b>	100003	<b>Ref. No.</b>	483286009226
<b>description</b>	piezoelectric igniter body metal blowing mounting ø 18mm connection F2.8x0.8		

thermocouples

plug-in thermocouples

plug-in thermocouples standard

with barrel socket ø5mm - type Junkers with aluminised tip



1

<b>GEV No.</b>	102205	<b>Ref. No.</b>	154102 154103 154104 158332
<b>description</b>	thermocouple M8x1 L 750mm plug connection ø5.0mm		
<b>accessories for</b>	102205		
	<b>GEV No.</b>	<b>Ref. No.</b>	—
	thermocouple fitting thread M8x1 Qty 1 pcs		

with barrel socket ø6mm

SIT

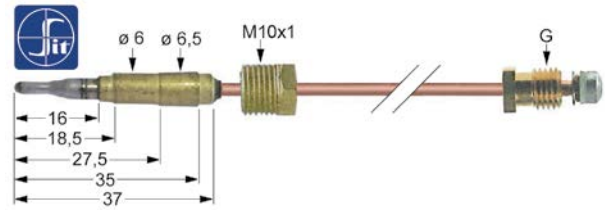

1

<b>GEV No.</b>	102438	<b>Ref. No.</b>	483286009281
<b>description</b>	thermocouple M10x1 L 600mm plug connection ø6.0mm		



with barrel socket  $\varnothing 6(6.5)$ mm

thermocouples SIT

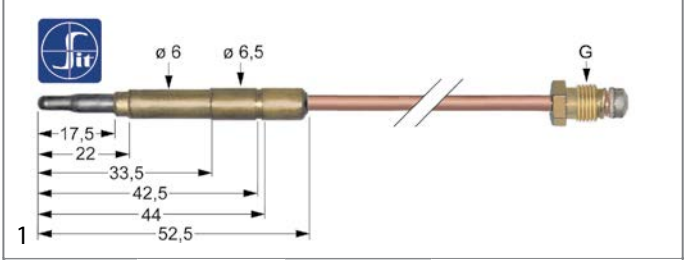

<b>GEV No.</b>	107608	<b>Ref. No.</b>	483286009247
<b>description</b>	thermocouple SIT M9x1 L 500mm plug connection $\varnothing 6.0(6.5)$ mm		

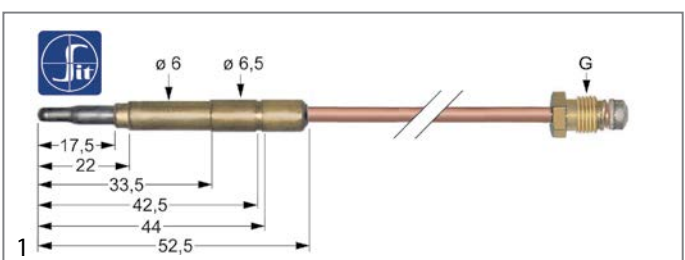

<b>GEV No.</b>	107609	<b>Ref. No.</b>	483286009282
<b>description</b>	thermocouple SIT M9x1 L 600mm plug connection $\varnothing 6.0(6.5)$ mm		
<b>For models:</b>	AGB352WP, AGB353WP, AGB354WP		

thermocouples with aluminised tip

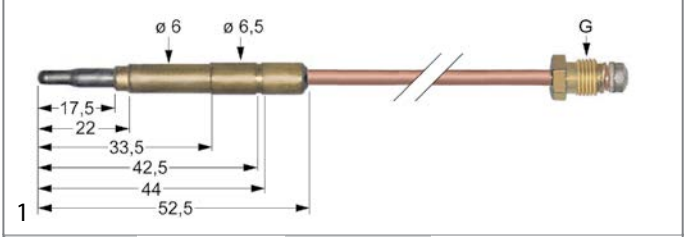

<b>GEV No.</b>	102144	<b>Ref. No.</b>	483286009294
<b>description</b>	thermocouple M9x1 L 450mm plug connection $\varnothing 6.0(6.5)$ mm		

plug-in thermocouples with interruption

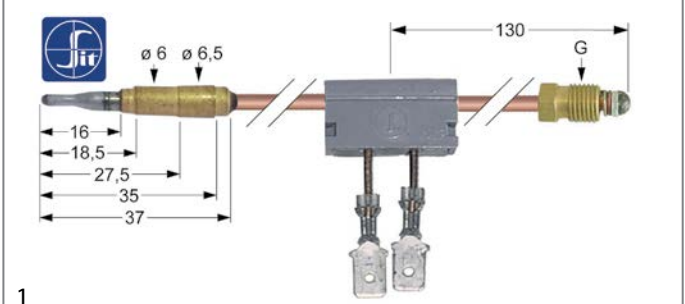

<b>GEV No.</b>	100172	<b>Ref. No.</b>	483286009229
<b>description</b>	thermocouple SIT with interrupter ASA 11/32 L 400mm plug connection $\varnothing 6.0$ mm F 6.3mm		

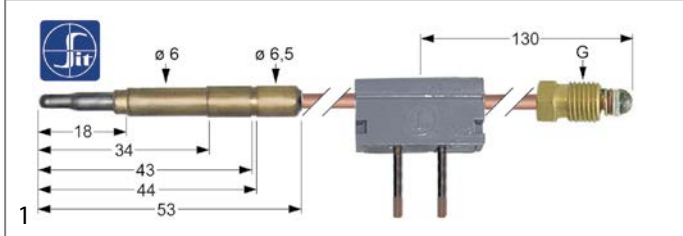

<b>GEV No.</b>	107164	<b>Ref. No.</b>	483286009219
<b>description</b>	thermocouple SIT with interrupter M9x1 L 1000mm plug connection $\varnothing 6.0(6.5)$ mm soldering connection		

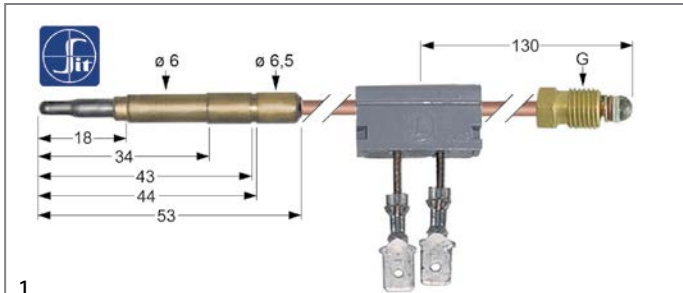

<b>GEV No.</b>	107177	<b>Ref. No.</b>	483286009324
<b>description</b>	thermocouple SIT with interrupter M9x1 L 600mm plug connection $\varnothing 6.0$ mm F 6.3mm		

extensions



<b>GEV No.</b>	102852	<b>Ref. No.</b>	483286009265
<b>description</b>	thermocouple extension thread M9x1 L 1500mm		
<b>accessories for</b>	102852		
	<b>GEV No.</b>	101261	<b>Ref. No.</b> —
	thermocouple fitting thread M9x1 Qty 1 pcs		

## gas burners

### hob burners

universal hob burners

SABAF

2 series - standard



<b>GEV No.</b>	107374	<b>Ref. No.</b>	C00319454
<b>description</b>	burner cap 3kW $\varnothing 100$ mm H 3.5mm matt finish		

<b>accessories for</b>	107374		
	<b>GEV No.</b>	105058	<b>Ref. No.</b> —
	burner head 3kW for igniter $\varnothing 6$ mm for burner cap $\varnothing 100$ mm		

	<b>GEV No.</b>	105059	<b>Ref. No.</b> —
	burner lower part 3kW for igniter $\varnothing 6$ mm for thermocouple $\varnothing 6$ mm without nozzle for burner cap $\varnothing 100$ mm		



## accessories

### pan supports



1

<b>GEV No.</b>	210138	<b>Ref. No.</b>	102436 771985000078
<b>description</b>	pan support W 285mm L 345mm		

### air mixers



1

<b>GEV No.</b>	106521	<b>Ref. No.</b>	483286009277
<b>description</b>	air mixing sleeve L 30mm thread 3/8" IT		



1

<b>GEV No.</b>	104741	<b>Ref. No.</b>	483286009249
<b>description</b>	air mixing tube L 42mm ø 20mm		

## bar burners

### bar burners



1

<b>GEV No.</b>	105718	<b>Ref. No.</b>	483286009213
<b>description</b>	bar burner ø 40mm Wmm Hmm L 395mm flange ø 61mm tilting bratt pan		

## gas nozzles

### main nozzles

#### gas nozzles M10x1



1

<b>GEV No.</b>	102867	<b>Ref. No.</b>	483286009237
<b>description</b>	gas injector thread M10x1 WS 11 bore ø 1.65mm		



1

<b>GEV No.</b>	106291	<b>Ref. No.</b>	483286002438
<b>description</b>	gas injector thread M10x1 WS 11 bore ø 1.95mm inner peaked		



1

<b>GEV No.</b>	106284	<b>Ref. No.</b>	483286009252
<b>description</b>	gas injector thread M10x1 WS 11 bore ø 2.15mm		
<b>For models:</b>	AGB352WP, AGB353WP, AGB354WP		



1

<b>GEV No.</b>	106495	<b>Ref. No.</b>	483286009287
<b>description</b>	gas injector thread M10x1 WS 11 bore ø 2.25mm		
<b>For models:</b>	AGB352WP, AGB353WP, AGB354WP		



1

<b>GEV No.</b>	107343	<b>Ref. No.</b>	483286009637
<b>description</b>	gas injector thread M10x1 WS 12 bore ø 1.2mm LPG gas pressure 30mbar		

## pilot burner nozzles

### pilot burner nozzles SIT

#### 100 series



1

<b>GEV No.</b>	100247	<b>Ref. No.</b>	156578
<b>description</b>	pilot burner nozzle LPG bore ø 0.2mm Qty 1 pcs suitable for SIT 100 series thread M8x0.75		



1

<b>GEV No.</b>	100246	<b>Ref. No.</b>	483286009258
<b>description</b>	pilot burner nozzle natural gas bore ø 0.35mm Qty 1 pcs thread M8x0.75		
<b>For models:</b>	AGB352WP, AGB353WP, AGB354WP		



1

<b>GEV No.</b>	100248	<b>Ref. No.</b>	156750
<b>description</b>	pilot burner nozzle natural gas bore ø 0.3mm Qty 1 pcs suitable for SIT 100 series		



1 gas components

140/150 series



<b>GEV No.</b>	100205	<b>Ref. No.</b>	483286009231
<b>description</b>	pilot burner nozzle SIT LPG code 19 bore $\varnothing$ 0.23/0.26mm Qty 1 pcs suitable for SIT 150 series		



<b>GEV No.</b>	100206	<b>Ref. No.</b>	483286009232
<b>description</b>	pilot burner nozzle SIT natural gas code 36 bore $\varnothing$ 0.60/0.55mm Qty 1 pcs suitable for SIT 150 series		

pan mechanics

sumps



<b>GEV No.</b>	696619	<b>Ref. No.</b>	310058 771985006362
<b>description</b>	sump for ice maker L 450mm W 185mm H 70mm white		

cutting grid



<b>GEV No.</b>	480100	<b>Ref. No.</b>	4819 259 98186
<b>description</b>	cutting grid for ice-cube maker L 350mm W 285mm H 40mm		

for convection ovens/combi-steamers

injection nozzles



<b>GEV No.</b>	691627	<b>Ref. No.</b>	483286002465
<b>description</b>	injection nozzle bore $\varnothing$ 0.4mm D1 $\varnothing$ 6mm D2 $\varnothing$ 11.5mm L 35mm WS 14 brass		



<b>GEV No.</b>	691628	<b>Ref. No.</b>	483286002466
<b>description</b>	injection nozzle bore $\varnothing$ 0.5mm D1 $\varnothing$ 6mm D2 $\varnothing$ 10.5mm L 35mm WS 14 brass		



<b>GEV No.</b>	691629	<b>Ref. No.</b>	483286002399
<b>description</b>	injection nozzle bore $\varnothing$ 0.7mm D1 $\varnothing$ 6mm D2 $\varnothing$ 11.5mm L 38mm WS 14 brass thread 1/8"		

equipment-specific units

for fridges

miscellaneous



<b>GEV No.</b>	694849	<b>Ref. No.</b>	483286008084
<b>description</b>	cover with sump for evaporator L 390mm W 355mm H 140mm plastic		

for ice-cube maker

drain systems

drain pans



<b>GEV No.</b>	696616	<b>Ref. No.</b>	310084 771985006376
<b>description</b>	drain pan L 160mm W 55mm H 200mm plastic		





## cleaning system

### nozzles



1

<b>GEV No.</b>	510000	<b>Ref. No.</b>	483286003062
<b>description</b>	nozzle ø 1.5/2.8mm H 13mm thread 1/8" ET WS 13		

## miscellaneous

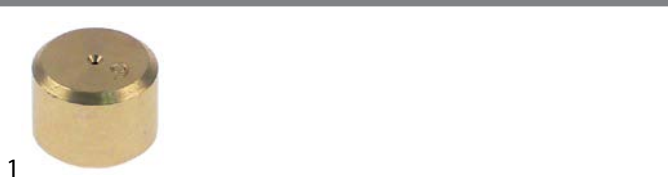

1

<b>GEV No.</b>	692446	<b>Ref. No.</b>	102091 771985000017
<b>description</b>	reducer bore ø 0.6mm brass ø 12mm thickness 9mm code 6		

## for tilting bratt pans

### spindles



1

<b>GEV No.</b>	690546	<b>Ref. No.</b>	483286009394
<b>description</b>	thread block thread Tr24x5 right-hand thread W 38mm bolt ø 20mm D 40mm H 40mm		

## for dishwashers

### boilers

#### boilers for dishwashers



1

<b>GEV No.</b>	504791	<b>Ref. No.</b>	771985000127
<b>description</b>	boiler L 700mm W 290mm H 170mm		



1

<b>GEV No.</b>	519022	<b>Ref. No.</b>	483286008869
<b>description</b>	boiler ø 150mm L 400mm		

## hood mechanics for dishwashers

### rollers



1

<b>GEV No.</b>	524963	<b>Ref. No.</b>	148260 771985001839
<b>description</b>	roller ø 49mm H 21.5mm for hood mechanics plastic white hole ø 10mm		

## air traps

### air traps



1

<b>GEV No.</b>	511450	<b>Ref. No.</b>	483286008796	
<b>description</b>	air trap			
<b>accessories for</b>	511450			
	<b>GEV No.</b>	511197	<b>Ref. No.</b>	—
	gasket L 46mm W 33mm for air trap			

door mechanics

hinges



<b>GEV No.</b>	502263	<b>Ref. No.</b>	483286008926
<b>description</b>	hinge mounting pos. left L 94mm N45/N50		



<b>GEV No.</b>	502262	<b>Ref. No.</b>	483286008927
<b>description</b>	hinge mounting pos. right L 94mm N45/N50		

miscellaneous



<b>GEV No.</b>	504435	<b>Ref. No.</b>	483286008935
<b>description</b>	flat gasket plastic ED ø 18mm ID ø 9.5mm thickness 2.5mm for door hinge Qty 1 pcs		



<b>GEV No.</b>	541996	<b>Ref. No.</b>	771985004707
<b>description</b>	plug for door handle H 14.1mm D1 ø 18.8mm D2 ø 27mm green		

curtains

curtains

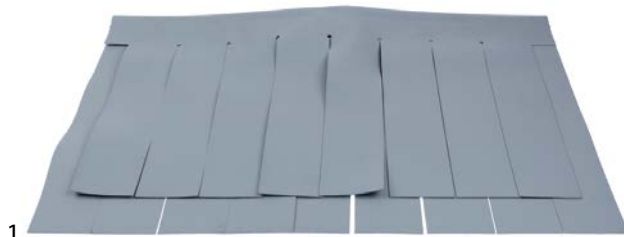

<b>GEV No.</b>	533016	<b>Ref. No.</b>	483286001676
<b>description</b>	curtain W 640mm H 410mm plastic thickness 1.5mm warewashing		

washing and rinsing systems



<b>GEV No.</b>	519167	<b>Ref. No.</b>	483286002296
<b>description</b>	bush for wash arm		

accessories for 519167



<b>GEV No.</b>	519087	<b>Ref. No.</b>	—
<b>description</b>	locknut for wash arm		



<b>GEV No.</b>	519122	<b>Ref. No.</b>	4832 860 08158
<b>description</b>	flat gasket for rinse arm		



<b>GEV No.</b>	510000	<b>Ref. No.</b>	483286003062
<b>description</b>	nozzle ø 1.5/2.8mm H 13mm thread 1/8" ET WS 13		



<b>GEV No.</b>	519007	<b>Ref. No.</b>	4832 860 01182
<b>description</b>	opposite support mounting pos. lower for wash arm support		



knobs

producer-specific knobs

WHIRLPOOL



1

<b>GEV No.</b>	112012	<b>Ref. No.</b>	483286009275 483286009382
<b>description</b>	knob gas tap with ignition flame t.max.°C°C ø 71mm shaft ø 8x6.5mm shaft flat upper		



1

<b>GEV No.</b>	112136	<b>Ref. No.</b>	483286009308
<b>description</b>	knob switch 4-position t.max.°C°C ø 71mm shaft ø 6x4.6mm shaft flat upper black		



1

<b>GEV No.</b>	112137	<b>Ref. No.</b>	483286009353
<b>description</b>	knob thermostat t.max. 195°C ø 71mm shaft ø 6x4.6mm shaft flat upper black temperature range 100-195°C		



1

<b>GEV No.</b>	112135	<b>Ref. No.</b>	483286009369
<b>description</b>	knob thermostat t.max. 300°C ø 71mm shaft ø 6x4.6mm shaft flat upper black temperature range 50-300°C rotation 270°		



1

<b>GEV No.</b>	110465	<b>Ref. No.</b>	483286009618
<b>description</b>	knob dial plate oven BH/TH/BH+TH ED ø 66mm ID ø 50mm silver		

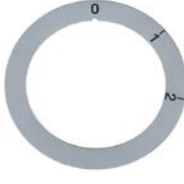

1

<b>GEV No.</b>	110690	<b>Ref. No.</b>	483286009428
<b>description</b>	knob dial plate switch 0-1-2 ED ø 66mm ID ø 50mm silver		

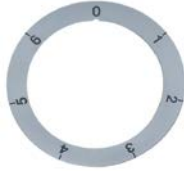

1

<b>GEV No.</b>	110464	<b>Ref. No.</b>	483286009632
<b>description</b>	knob dial plate switch 7-position ED ø 66mm ID ø 50mm silver		



1

<b>GEV No.</b>	111000	<b>Ref. No.</b>	483286002387
<b>description</b>	knob ø 60mm shaft ø 18.5x18.5mm for safety valve		



1

<b>GEV No.</b>	111072	<b>Ref. No.</b>	483286002386
<b>description</b>	knob switch zero mark ø 55mm shaft ø 6x4.6mm shaft flat upper silver		



1

<b>GEV No.</b>	111003 <sup>1</sup>	<b>Ref. No.</b>	483286002444
<b>description</b>	knob switch zero mark ø 55mm shaft ø 6x4.6mm shaft flat upper silver deepend shaft intake		

<sup>1</sup>deepend shaft intake

## handles and hand wheels

### hand wheels

#### hand wheels



1

<b>GEV No.</b>	692431	<b>Ref. No.</b>	483286009392
<b>description</b>	hand wheel ø 200mm D1 ø 50mm bore ø 20mm thread groove width 8mm groove depth 12mm mounting distance 32mm L1 40mm L2 43mm handle length 65mm with folding handle		

### bracket handles



1

<b>GEV No.</b>	691626	<b>Ref. No.</b>	483286002643
<b>description</b>	pull handle L 140mm H 73mm handle M5		



1

<b>GEV No.</b>	690448	<b>Ref. No.</b>	181906 182448 771985008758
<b>description</b>	pull handle L 402mm H 42mm mounting distance 375mm		

### door handles

#### door handles



1

<b>GEV No.</b>	694918	<b>Ref. No.</b>	132933
<b>description</b>	door handle L 198mm W 70mm H 15mm grey		

## locks

### edgemoat latches

#### handle latches

#### producer-specific

#### INOXTREND





1

<b>GEV No.</b>	690536	<b>Ref. No.</b>	483286002378
<b>description</b>	catch L 172mm mounting distance 133mm non lockable chrome-plated 6200 total length 248mm		
<b>accessories for</b>	690536		
	<b>GEV No.</b>	690123	<b>Ref. No.</b> —
		door catch with roller	



1

<b>GEV No.</b>	690146	<b>Ref. No.</b>	483286008725
<b>description</b>	handle latch L 172mm mounting distance 134mm non lockable heated units 6200 H 65mm type DUPLO total length 248mm		
<b>accessories for</b>	690146		
	<b>GEV No.</b>	690123	<b>Ref. No.</b> —
		door catch with roller	
	<b>GEV No.</b>	693777	<b>Ref. No.</b> —
		gasket H 6.6mm L 105mm W 45mm L1 78mm W1 25mm for handle	
	<b>GEV No.</b>	693778	<b>Ref. No.</b> —
		door catch	







## MODULAR

			
1			
<b>GEV No.</b>	690146	<b>Ref. No.</b>	483286008725
<b>description</b>	handle latch L 172mm mounting distance 134mm non lockable heated units 6200 H 65mm type DUPLO total length 248mm		
<b>accessories for</b>	690146		
	<b>GEV No.</b>	690123	<b>Ref. No.</b> —
	door catch with roller		
	<b>GEV No.</b>	693777	<b>Ref. No.</b> —
	gasket H 6.6mm L 105mm W 45mm L1 78mm W1 25mm for handle		
	<b>GEV No.</b>	693778	<b>Ref. No.</b> —
	door catch		

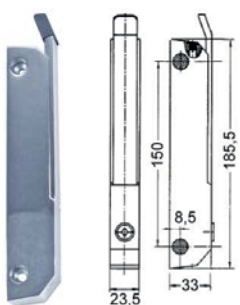
## RAHRBACH

### 6188 ERGO series

			
1			
<b>GEV No.</b>	690808	<b>Ref. No.</b>	483286000205
<b>description</b>	handle latch L 185mm mounting distance 150mm chrome-plated non lockable for headed units 6188 type ERGO		
<b>accessories for</b>	690808		
	<b>GEV No.</b>	690110	<b>Ref. No.</b> —
	base plate H 1mm L 38mm W 11mm mounting distance 26mm plastic		
	<b>GEV No.</b>	690111	<b>Ref. No.</b> —
	base plate H 2mm L 38mm W 11mm mounting distance 26mm plastic		
	<b>GEV No.</b>	690114	<b>Ref. No.</b> —
	base plate H 3.5mm L 185mm W 30mm mounting distance 150mm with inclination thread M5		
	<b>GEV No.</b>	700082	<b>Ref. No.</b> —
	door catch L 38mm W 18mm mounting distance 26mm		

## hinges

### spring assisted hinges

universal

INTERKLIMAT

hinges

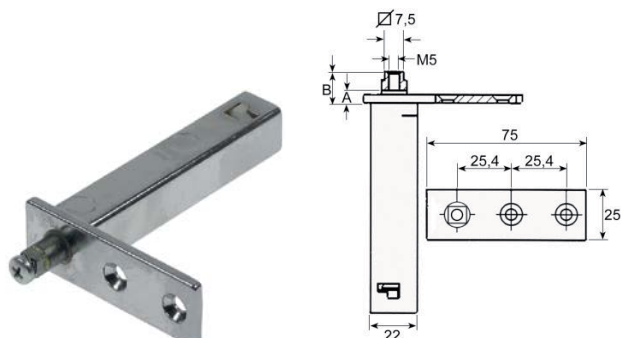
			
1			
<b>GEV No.</b>	690622	<b>Ref. No.</b>	181653 182219 771985004801
<b>description</b>	spring assisted hinge series 28L mounting pos. left/right L 75mm W 25mm H 103mm A 13mm B 18mm mounting measurements 22x22mm intake 7.5x7.5 refrigeration units		

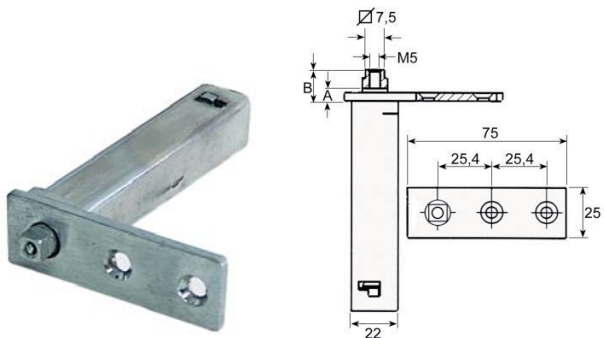
			
1			
<b>GEV No.</b>	690714	<b>Ref. No.</b>	183876 771985005195 771985010339
<b>description</b>	spring assisted hinge series 28XC mounting pos. left/right L 75mm W 25mm H 103mm A 8mm B 11mm intake 7.5x7.5 refrigeration units mounting distance 25mm		

### accessories

			
1			
<b>GEV No.</b>	690747	<b>Ref. No.</b>	771985004680 771985010369
<b>description</b>	bush for hinge ID $\varnothing$ 7.5mm L 25.5mm W 25.5mm white mounting measurements 22x22mm H 4.5mm		



producer-specific

ELECTROLUX/ZANUSSI



1

<b>GEV No.</b>	690747	<b>Ref. No.</b>	771985004680 771985010369
<b>description</b>	bush for hinge ID $\phi$ 7.5mm L 25.5mm W 25.5mm white mounting measurements 22x22mm H 4.5mm		



1

<b>GEV No.</b>	690633	<b>Ref. No.</b>	182587 771985004894
<b>description</b>	spring assisted hinge refrigerator		

**accessories for** 690633



<b>GEV No.</b>	690634	<b>Ref. No.</b>	187135 771985004875
----------------	--------	-----------------	------------------------

hinge bearing mounting pos. lower with bolt refrigerator



<b>GEV No.</b>	690635	<b>Ref. No.</b>	187136 771985004874
----------------	--------	-----------------	------------------------

hinge bearing mounting pos. upper with bolt refrigerator

SAGI



1

<b>GEV No.</b>	690747	<b>Ref. No.</b>	771985004680 771985010369
<b>description</b>	bush for hinge ID $\phi$ 7.5mm L 25.5mm W 25.5mm white mounting measurements 22x22mm H 4.5mm		

oven hinges



1

<b>GEV No.</b>	700006	<b>Ref. No.</b>	483286009243
<b>description</b>	oven hinge mounting distance 173mm mounting distance 2 105mm lug mounting 14mm lever length 120mm groove distance 11mm spring thickness 3.5mm mounting ear position left spring length 112mm W 25mm		

**accessories for** 700006



<b>GEV No.</b>	700001	<b>Ref. No.</b>	—
----------------	--------	-----------------	---

opposite support L 118mm W 17mm mounting distance 94mm

<b>accessories for</b>	700006		
<b>GEV No.</b>	700007	<b>Ref. No.</b>	483286009255
<b>description</b>	oven hinge mounting distance 173mm mounting distance 2 105mm lug mounting 14mm lever length 120mm groove distance 11mm spring thickness 3.5mm mounting ear position right spring length 112mm W 25mm		

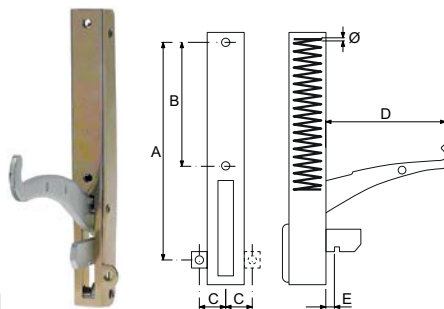

1

<b>GEV No.</b>	700007	<b>Ref. No.</b>	483286009255
<b>description</b>	oven hinge mounting distance 173mm mounting distance 2 105mm lug mounting 14mm lever length 120mm groove distance 11mm spring thickness 3.5mm mounting ear position right spring length 112mm W 25mm		

**accessories for** 700007



<b>GEV No.</b>	700001	<b>Ref. No.</b>	—
----------------	--------	-----------------	---

opposite support L 118mm W 17mm mounting distance 94mm

door bearing



1

<b>GEV No.</b>	691310	<b>Ref. No.</b>	183875 771985005194
<b>description</b>	bush L 23mm W 23mm ID $\phi$ 7mm for hinge		



1

<b>GEV No.</b>	697999	<b>Ref. No.</b>	187822 771985010780
<b>description</b>	hinge L 55mm W 20mm H 71mm mounting pos. upper bolt 45mm bolt $\phi$ 7mm suitable for refrigerator		





1

<b>GEV No.</b>	690625	<b>Ref. No.</b>	182374 771985004842
<b>description</b>	hinge bearing mounting pos. centre with bolt refrigerator		



			
1			
<b>GEV No.</b>	690634	<b>Ref. No.</b>	187135 771985004875
<b>description</b>	hinge bearing mounting pos. lower with bolt refrigerator		

			
1			
<b>GEV No.</b>	690627	<b>Ref. No.</b>	182256 771985004819
<b>description</b>	hinge bearing mounting pos. right/left with bolt refrigerator		

			
1			
<b>GEV No.</b>	690635	<b>Ref. No.</b>	187136 771985004874
<b>description</b>	hinge bearing mounting pos. upper with bolt refrigerator		

			
1			
<b>GEV No.</b>	691965	<b>Ref. No.</b>	483286008992
<b>description</b>	hinge camp mounting pos. lower		

			
1			
<b>GEV No.</b>	692501	<b>Ref. No.</b>	209124 771985006125
<b>description</b>	hinge pine L 29mm thread M5 ø 7mm for blast chiller Qty 1 pcs		

## accessories

### miscellaneous

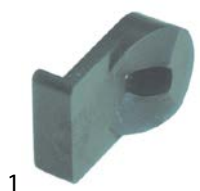
			
1			
<b>GEV No.</b>	690647	<b>Ref. No.</b>	182964 771985004997
<b>description</b>	bush refrigerator		

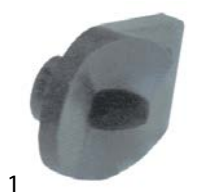
			
1			
<b>GEV No.</b>	690646	<b>Ref. No.</b>	209092 771985006103
<b>description</b>	bush refrigerator ID ø 7mm		

			
1			
<b>GEV No.</b>	690648	<b>Ref. No.</b>	182962 771985004996
<b>description</b>	pressure pin refrigerator		

## pullouts

### rollers

#### rollers

			
1			
<b>GEV No.</b>	690692	<b>Ref. No.</b>	483286002644
<b>description</b>	roller rollerø 55mm B1 10mm overall width 14mm A 55mm B 10mm C 14mm SS bore ø 12mm		

			
1			
<b>GEV No.</b>	692465	<b>Ref. No.</b>	483286008748
<b>description</b>	roller rollerø 33mm B1 8mm A 33mm B 8mm C 14.5mm D M8mm E 11.5mm plastic tread plastic bearing ball bearing thread M8x1.25 thread L 20mm Qty 1 pcs		

## fittings for catering equipment

### lid hinges







type RUBINETTERIE DEL FRIULI

for circular lids

lid hinges



1

<b>GEV No.</b>	540839	<b>Ref. No.</b>	483286009195
<b>description</b>	lid hinge L 270mm mounting distance 139mm flange radius 470mm opening angle 80° spring thickness 5mm bore ø M16mm for circular lids		
<b>spare parts for</b>	540839		
	<b>GEV No.</b>	514137	<b>Ref. No.</b> —
	spring guide for lid hinge ID ø 28mm ED ø 32mm L 225mm zinc-coated steel		
	<b>GEV No.</b>	514140	<b>Ref. No.</b> —
	lid hinge body lid radius 470mm		
	<b>GEV No.</b>	514144	<b>Ref. No.</b> —
	bracket for lid hinge		
	<b>GEV No.</b>	514145	<b>Ref. No.</b> —
	adjusting bush L 108mm ø 80/60mm		
	<b>GEV No.</b>	540854	<b>Ref. No.</b> —
	torsion spring ø 50.8mm wire gauge ø 5.1mm L1 34mm L2 104mm L3 29mm mounting pos. right		
	<b>GEV No.</b>	540855	<b>Ref. No.</b> —
	torsion spring ø 50.8mm wire gauge ø 5.1mm L1 34mm L2 104mm L3 29mm mounting pos. left		

## equipment feet and end caps

### screw-in feet



1

<b>GEV No.</b>	513284	<b>Ref. No.</b>	771985006416
<b>description</b>	equipment foot thread M8 thread L 20mm ø 30mm H 12mm Qty 1 pcs		

## baskets

### crumb screens

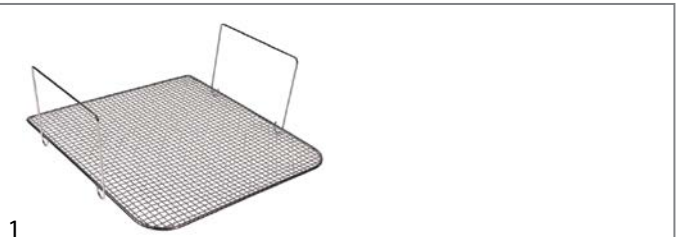

1

<b>GEV No.</b>	970605	<b>Ref. No.</b>	483286009366
<b>description</b>	crumb screen L 310mm W 295mm suitable for fryer		

## shelves and shelf rails



### grates

#### universal

#### without upstand



1

<b>GEV No.</b>	970120	<b>Ref. No.</b>	771985003454
<b>description</b>	grate W 325mm D 530mm GN 1/1 chrome-plated steel wire gauge frame 7mm lengthwise wires gauge 4mm crossing wires 1		
<b>accessories for</b>	970120		
	<b>GEV No.</b>	690330	<b>Ref. No.</b> —
	rack L 1000mm W 22mm H 4mm aperture 3x8mm hole distance 12.5mm stainless steel		
	<b>GEV No.</b>	694700	<b>Ref. No.</b> —
	shelf support L 31/28mm W 22mm H 18mm SS Qty 12 pcs		
	<b>GEV No.</b>	694701	<b>Ref. No.</b> —
	shelf support L 31/28mm W 22mm H 17mm SS with hook Qty 12 pcs		

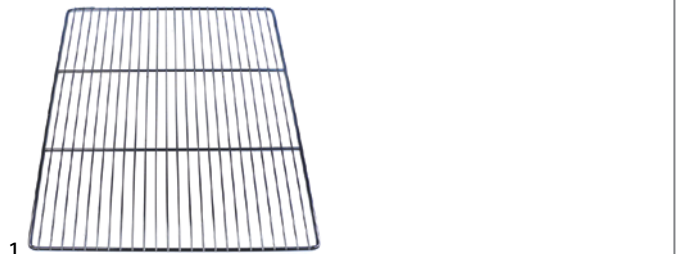

1













<b>GEV No.</b>	970121	<b>Ref. No.</b>	125020
<b>description</b>	grate W 650mm D 530mm GN 2/1 chrome-plated steel crossing wires 2		
<b>accessories for</b>	970121		
	<b>GEV No.</b>	690330	<b>Ref. No.</b> —
	rack L 1000mm W 22mm H 4mm aperture 3x8mm hole distance 12.5mm stainless steel		

Table continues overleaf



<b>accessories for</b>	970121		
	<b>GEV No.</b>	694700	<b>Ref. No.</b> —
	shelf support L 31/28mm W 22mm H 18mm SS Qty 12 pcs		
	<b>GEV No.</b>	694701	<b>Ref. No.</b> —
	shelf support L 31/28mm W 22mm H 17mm SS with hook Qty 12 pcs		

<b>with upstand</b>			
			
1			
<b>GEV No.</b>	970527	<b>Ref. No.</b>	77198500673 771985004752
<b>description</b>	grate W 530mm D 650mm GN 2/1 chrome-plated steel with hinge camp crossing wires 2 suitable for refrigerator		
<b>accessories for</b>	970527		
	<b>GEV No.</b>	690330	<b>Ref. No.</b> —
	rack L 1000mm W 22mm H 4mm aperture 3x8mm hole distance 12.5mm stainless steel		
	<b>GEV No.</b>	694700	<b>Ref. No.</b> —
	shelf support L 31/28mm W 22mm H 18mm SS Qty 12 pcs		
	<b>GEV No.</b>	694701	<b>Ref. No.</b> —
	shelf support L 31/28mm W 22mm H 17mm SS with hook Qty 12 pcs		

			
1			
<b>GEV No.</b>	970556	<b>Ref. No.</b>	182885 483286009003 771985004972
<b>description</b>	grate W 530mm D 650mm GN 2/1 plastic-coated steel with hinge camp wire gauge frame 9mm lengthwise wires gauge 5mm crossing wires 2 white suitable for refrigerator		
<b>accessories for</b>	970556		
	<b>GEV No.</b>	690330	<b>Ref. No.</b> —
	rack L 1000mm W 22mm H 4mm aperture 3x8mm hole distance 12.5mm stainless steel		
	<b>GEV No.</b>	690332	<b>Ref. No.</b> —
	shelf support L 31/28mm W 22mm H 17mm SS with hook Qty 1 pcs		
	<b>GEV No.</b>	694700	<b>Ref. No.</b> —
	shelf support L 31/28mm W 22mm H 18mm SS Qty 12 pcs		
	<b>GEV No.</b>	694701	<b>Ref. No.</b> —
	shelf support L 31/28mm W 22mm H 17mm SS with hook Qty 12 pcs		

## gaskets

### refrigeration gaskets

#### plug-in gaskets

#### profile 9048

We offer custom-made gaskets for this profile

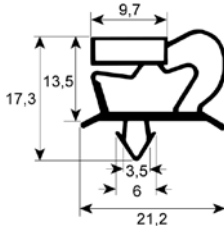
			
1			
<b>GEV No.</b>	900021	<b>Ref. No.</b>	131694 771985000885
<b>description</b>	refrigeration gasket profile 9048 W 142mm L 372mm plug size drawer refrigeration size 2/5 suitable for ELECTROLUX, ZANUSSI		

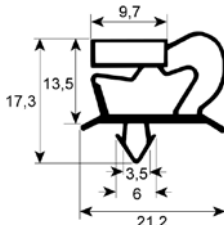
			
1			
<b>GEV No.</b>	900303	<b>Ref. No.</b>	181772 771985004725
<b>description</b>	refrigeration gasket profile 9048 W 195mm L 372mm plug size drawer refrigeration size 1/3 suitable for ELECTROLUX, ZANUSSI		

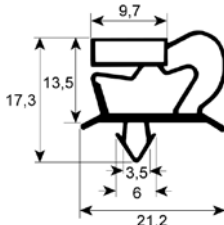
			
1			
<b>GEV No.</b>	900019	<b>Ref. No.</b>	182759
<b>description</b>	refrigeration gasket profile 9048 W 262mm L 372mm plug size drawer size 1/2		

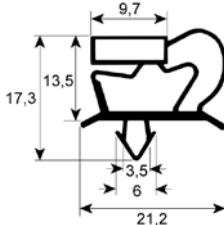
			
1			
<b>GEV No.</b>	901047	<b>Ref. No.</b>	483286009965
<b>description</b>	refrigeration gasket profile 9048 W 282mm L 390mm plug size		

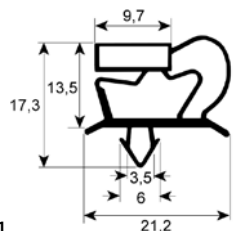

<b>GEV No.</b>	900020	<b>Ref. No.</b>	131693 771985000884
<b>description</b>	refrigeration gasket profile 9048 W 372mm L 385mm plug size drawer refrigeration size 3/5 suitable for ELECTROLUX, ZANUSSI		

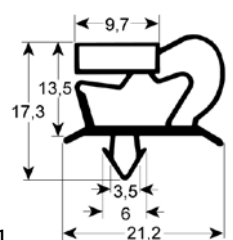

<b>GEV No.</b>	900018	<b>Ref. No.</b>	182725
<b>description</b>	refrigeration gasket profile 9048 W 372mm L 572mm plug size door size 1/1		

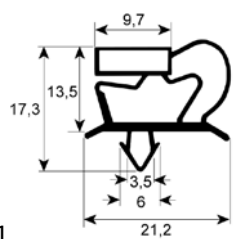

<b>GEV No.</b>	900304	<b>Ref. No.</b>	181805
<b>description</b>	refrigeration gasket profile 9048 W 372mm L 587mm plug size door refrigeration size 1/1		

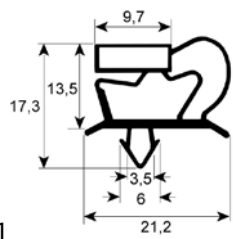

<b>GEV No.</b>	900926	<b>Ref. No.</b>	483286009955
<b>description</b>	refrigeration gasket profile 9048 W 388mm L 610mm plug size		

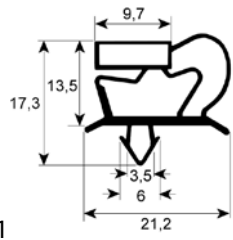

<b>GEV No.</b>	901222	<b>Ref. No.</b>	483286002794
<b>description</b>	refrigeration gasket profile 9048 W 415mm L 709mm plug size for blast chiller		

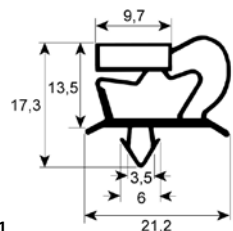

<b>GEV No.</b>	900986	<b>Ref. No.</b>	208992
<b>description</b>	refrigeration gasket profile 9048 W 450mm L 578mm plug size		

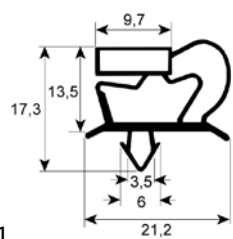

<b>GEV No.</b>	901045	<b>Ref. No.</b>	483286000052
<b>description</b>	refrigeration gasket profile 9048 W 465mm L 615mm plug size		

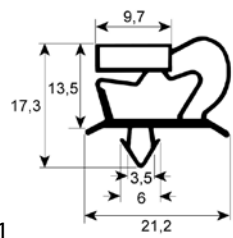

<b>GEV No.</b>	900023	<b>Ref. No.</b>	182375
<b>description</b>	refrigeration gasket profile 9048 W 647mm L 1517mm plug size door refrigeration suitable for ELECTROLUX, ZANUSSI		

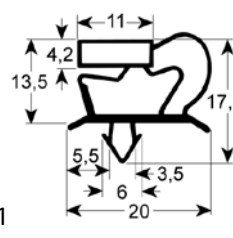

<b>GEV No.</b>	901677	<b>Ref. No.</b>	771985010351
<b>description</b>	refrigeration gasket profile 9048 W 650mm L 1550mm plug size		

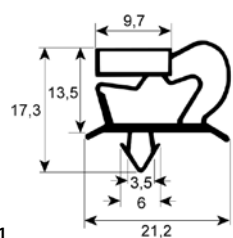

<b>GEV No.</b>	901308	<b>Ref. No.</b>	188724
<b>description</b>	refrigeration gasket profile 9048 W 650mm L 1700mm plug size		





<b>GEV No.</b>	900301	<b>Ref. No.</b>	180959
<b>description</b>	refrigeration gasket profile 9048 W 660mm L 1565mm plug size door refrigeration		

<b>GEV No.</b>	902258	<b>Ref. No.</b>	N/A
<b>description</b>	refrigeration gasket profile 9048 Wmm L 2500mm		

<b>GEV No.</b>	901235	<b>Ref. No.</b>	183461 771985005126
<b>description</b>	refrigeration gasket profile 9048 W 706mm L 1506mm plug size for blast chiller suitable for ELECTROLUX, ZANUSSI		

profile 9051

<b>GEV No.</b>	901797	<b>Ref. No.</b>	483286008098
<b>description</b>	refrigeration gasket profile 9051 W 560mm L 1685mm		

<b>GEV No.</b>	901220	<b>Ref. No.</b>	483286002826
<b>description</b>	refrigeration gasket profile 9048 W 721mm L 929mm plug size for blast chiller		

profile 9773

*We offer custom-made gaskets for this profile*

<b>GEV No.</b>	901088	<b>Ref. No.</b>	483286008003
<b>description</b>	refrigeration gasket profile 9773 W 566mm L 1705mm external size W1 553mm L1 1692mm plug size		

<b>GEV No.</b>	900375	<b>Ref. No.</b>	209180 771985006143
<b>description</b>	refrigeration gasket profile 9048 W 740mm L 1810mm plug size		

<b>GEV No.</b>	900985	<b>Ref. No.</b>	771985005298
<b>description</b>	refrigeration gasket profile 9773 W 598mm L 1690mm external size W1 585mm L1 1677mm plug size suitable for ELECTROLUX, ZANUSSI		

<b>GEV No.</b>	900379	<b>Ref. No.</b>	209099
<b>description</b>	refrigeration gasket profile 9773 W 620mm L 1700mm external size W1 607mm L1 1687mm plug size suitable for ELECTROLUX, ZANUSSI		

<b>GEV No.</b>	900983	<b>Ref. No.</b>	208225
<b>description</b>	refrigeration gasket profile 9773 W 665mm L 1570mm external size W1 652mm L1 1557mm plug size suitable for ELECTROLUX, ZANUSSI		

<b>GEV No.</b>	901039	<b>Ref. No.</b>	483286009058
<b>description</b>	refrigeration gasket profile 9773 W 658mm L 723mm external size W1 645mm L1 710mm plug size		

<b>GEV No.</b>	900254	<b>Ref. No.</b>	185719 771985005268
<b>description</b>	refrigeration gasket profile 9773 W 682mm L 1531mm external size W1 669mm L1 1518mm plug size suitable for ELECTROLUX, ZANUSSI		

<b>GEV No.</b>	901038	<b>Ref. No.</b>	483286008994
<b>description</b>	refrigeration gasket profile 9773 W 659mm L 1539mm external size W1 646mm L1 1526mm plug size		

<b>GEV No.</b>	900381	<b>Ref. No.</b>	208647
<b>description</b>	refrigeration gasket profile 9773 W 685mm L 1518mm external size W1 672mm L1 1505mm plug size suitable for ELECTROLUX, ZANUSSI		

<b>GEV No.</b>	900984	<b>Ref. No.</b>	208230
<b>description</b>	refrigeration gasket profile 9773 W 664mm L 762mm external size W1 651mm L1 749mm plug size suitable for ELECTROLUX, ZANUSSI		

<b>GEV No.</b>	901087	<b>Ref. No.</b>	483286008031
<b>description</b>	refrigeration gasket profile 9773 W 740mm L 1700mm external size W1 727mm L1 1687mm plug size		

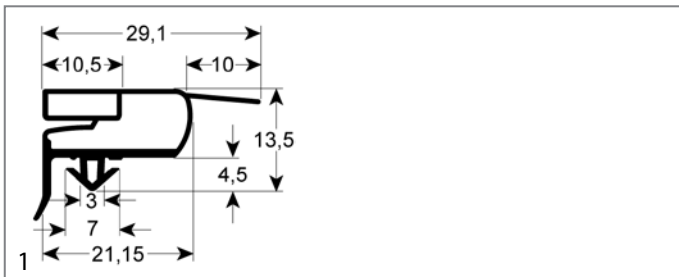

<b>GEV No.</b>	902305	<b>Ref. No.</b>	N/A
<b>description</b>	refrigeration gasket profile 9773 Wmm L 2500mm		

## profile 9704

We offer custom-made gaskets for this profile

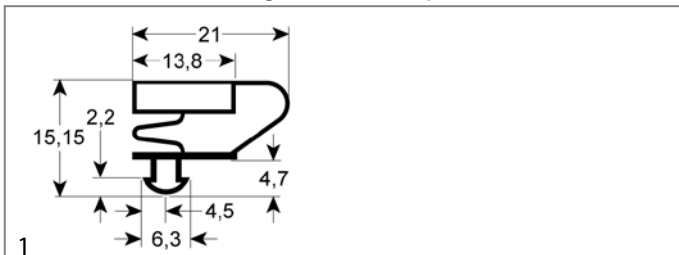

<b>GEV No.</b>	900374	<b>Ref. No.</b>	182586
<b>description</b>	refrigeration gasket profile 9704 W 665mm L 1535mm plug size glass door refrigeration suitable for ELECTROLUX, ZANUSSI		

## profile 9151

We offer custom-made gaskets for this profile

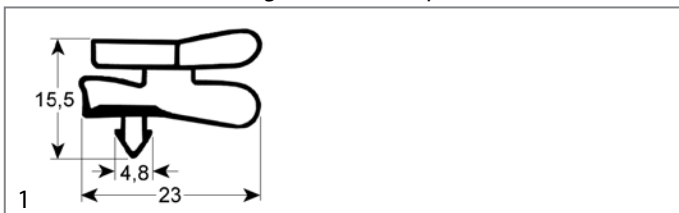

<b>GEV No.</b>	901098	<b>Ref. No.</b>	483286008065
<b>description</b>	refrigeration gasket profile 9151 W 565mm L 1690mm plug size		

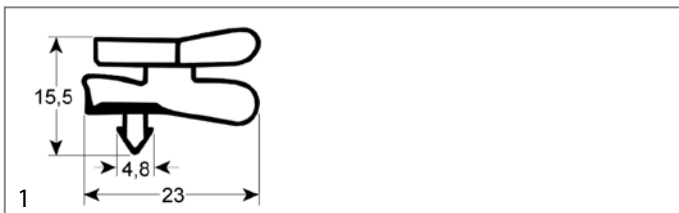

<b>GEV No.</b>	902265	<b>Ref. No.</b>	N/A
<b>description</b>	refrigeration gasket profile 9151 Wmm L 2500mm		

## profile 9237

We offer custom-made gaskets for this profile



<b>GEV No.</b>	900012	<b>Ref. No.</b>	181943
<b>description</b>	refrigeration gasket profile 9237 W 645mm L 1535mm plug size door refrigeration		

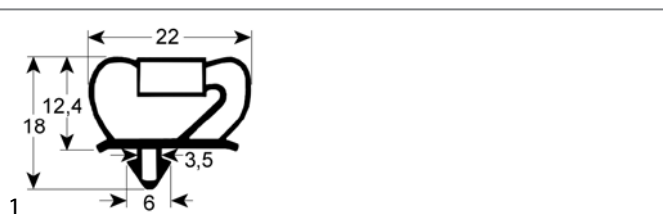

<b>GEV No.</b>	900015	<b>Ref. No.</b>	181724
<b>description</b>	refrigeration gasket profile 9237 W 710mm L 1500mm plug size door refrigeration		

## profile 9794

We offer custom-made gaskets for this profile

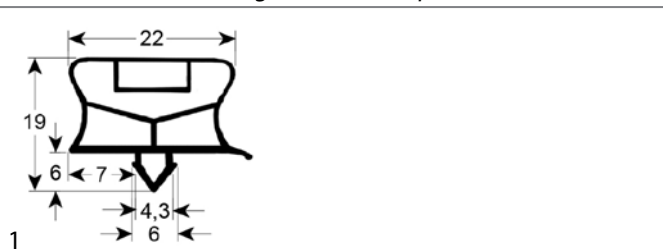

<b>GEV No.</b>	901390	<b>Ref. No.</b>	188484 771985013107
<b>description</b>	refrigeration gasket profile 9794 W 150mm L 380mm plug size plug-in gasket		

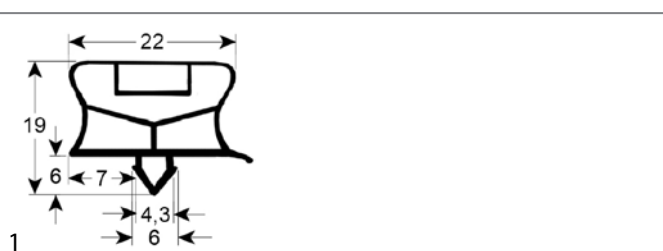

<b>GEV No.</b>	900987	<b>Ref. No.</b>	187691 771985013774
<b>description</b>	refrigeration gasket profile 9794 W 254mm L 387mm plug size		

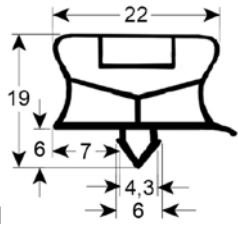

<b>GEV No.</b>	900890	<b>Ref. No.</b>	187664 771985011377
<b>description</b>	refrigeration gasket profile 9794 W 390mm L 555mm plug size		

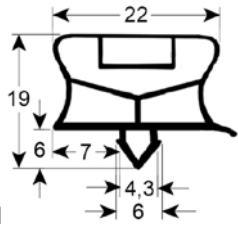

<b>GEV No.</b>	900981	<b>Ref. No.</b>	187129 771985001173
<b>description</b>	refrigeration gasket profile 9794 W 626mm L 1467mm plug size		

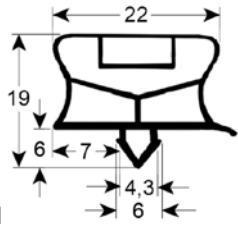

<b>GEV No.</b>	902308	<b>Ref. No.</b>	N/A
<b>description</b>	refrigeration gasket profile 9794 Wmm L 2500mm		

profile 9794Z (blast freezer)

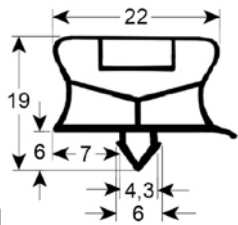

<b>GEV No.</b>	901237 <sup>1</sup>	<b>Ref. No.</b>	183377 771985005094
<b>description</b>	blast freezer gasket profile 9794Z W 406mm L 666mm plug size for blast chiller suitable for ELECTROLUX, ZANUSSI		

<sup>1</sup>for blast freezer

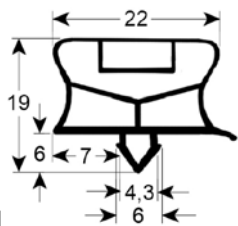

<b>GEV No.</b>	901236 <sup>1</sup>	<b>Ref. No.</b>	183397 771985005106
<b>description</b>	blast freezer gasket profile 9794Z W 666mm L 736mm plug size suitable for ELECTROLUX, ZANUSSI		

<sup>1</sup>for blast freezer

screw-in gaskets

profile 9663

We offer custom-made gaskets for this profile

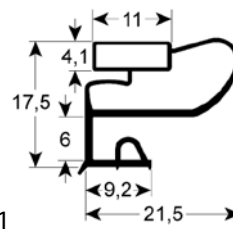

<b>GEV No.</b>	902295	<b>Ref. No.</b>	N/A
<b>description</b>	refrigeration gasket profile 9663 Wmm L 2500mm		

profile 9030

We offer custom-made gaskets for this profile

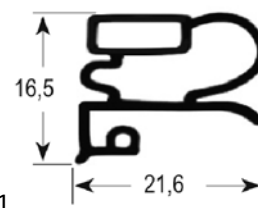

<b>GEV No.</b>	900003	<b>Ref. No.</b>	208081
<b>description</b>	refrigeration gasket profile 9030 W 390mm L 435mm external size drawer for refrigerated counter refrigeration size 3/5		

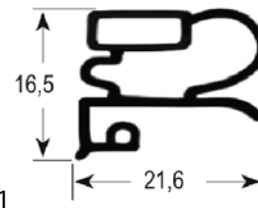

<b>GEV No.</b>	900004	<b>Ref. No.</b>	208075
<b>description</b>	refrigeration gasket profile 9030 W 391mm L 640mm external size door for refrigerated counter refrigeration size 1/1		

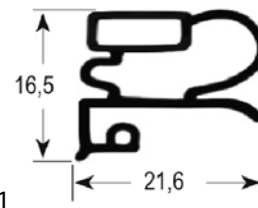

<b>GEV No.</b>	900006	<b>Ref. No.</b>	181293 208048
<b>description</b>	refrigeration gasket profile 9030 W 670mm L 1570mm external size door refrigeration suitable for ELECTROLUX, ZANUSSI		



<b>GEV No.</b>	900005	<b>Ref. No.</b>	181294 208049
<b>description</b>	refrigeration gasket profile 9030 W 675mm L 770mm external size 1/2 door refrigeration suitable for ELECTROLUX, ZANUSSI		

<b>GEV No.</b>	900828	<b>Ref. No.</b>	483286008694
<b>description</b>	window gasket profile 1885 L 2430mm Qty 1		

## gaskets for heated units

### window seals

<b>GEV No.</b>	900416	<b>Ref. No.</b>	483586008727
<b>description</b>	window gasket profile 1580 L 1800mm Qty 1 mounting pos. inner		

<b>GEV No.</b>	900826	<b>Ref. No.</b>	483286002635
<b>description</b>	window gasket profile 1886 L 600mm Qty 1 external size mounting pos. horizontal		

<b>GEV No.</b>	900825	<b>Ref. No.</b>	483286002636
<b>description</b>	window gasket profile 1886 L 800mm Qty 1 external size mounting pos. vertical		

<b>GEV No.</b>	900427	<b>Ref. No.</b>	483286002633
<b>description</b>	window gasket profile 1580 L 2900mm Qty 1 mounting pos. inner		

<b>GEV No.</b>	900425	<b>Ref. No.</b>	483286002637
<b>description</b>	window gasket profile 1890 L 2370mm Qty 1 mounting pos. outer		

<b>GEV No.</b>	900827	<b>Ref. No.</b>	483286002472
<b>description</b>	window gasket profile 1580 L 990mm Qty 1		

<b>GEV No.</b>	900415	<b>Ref. No.</b>	483286002383
<b>description</b>	window gasket profile 1895 L 3000mm Qty 1 mounting pos. outer		

<b>GEV No.</b>	900426	<b>Ref. No.</b>	483286002638
<b>description</b>	window gasket profile 1885 L 2300mm Qty 1		

<b>GEV No.</b>	900824	<b>Ref. No.</b>	483286008682
<b>description</b>	window gasket profile 1895 L 3570mm Qty 1 mounting pos. inner		



door seals

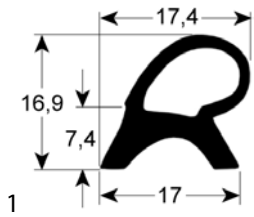

<b>GEV No.</b>	900188	<b>Ref. No.</b>	771985003102
<b>description</b>	door seal profile 2450 W 640mm H 720mm external size Qty 1 suitable for ELECTROLUX 640x720		

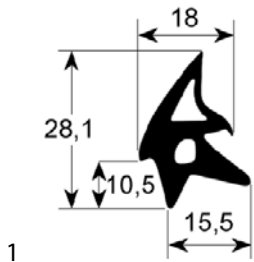

<b>GEV No.</b>	900417	<b>Ref. No.</b>	483286008726
<b>description</b>	door seal profile 2470 L 2300mm Qty 1		

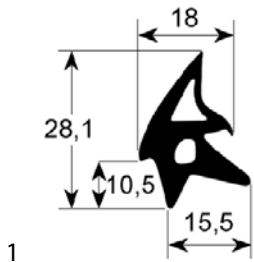

<b>GEV No.</b>	900420	<b>Ref. No.</b>	483286008684
<b>description</b>	door seal profile 2470 L 2850mm Qty 1		

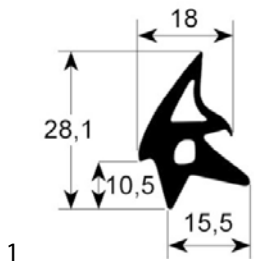

<b>GEV No.</b>	900428	<b>Ref. No.</b>	483286002634
<b>description</b>	door seal profile 2470 L 3600mm Qty 1		

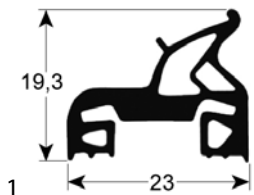

<b>GEV No.</b>	900160	<b>Ref. No.</b>	771985000576
<b>description</b>	door seal profile 2520 W 655mm L 725mm external size Qty 1 suitable for ELECTROLUX		

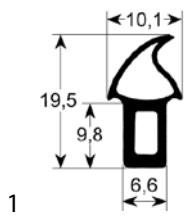

<b>GEV No.</b>	900544	<b>Ref. No.</b>	483286009256
<b>description</b>	door seal profile 2740 L 1350mm Qty 1		

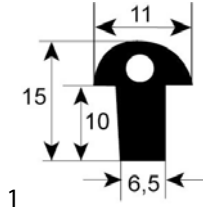

<b>GEV No.</b>	900229	<b>Ref. No.</b>	483286009256
<b>description</b>	door seal profile 2930 L 1350mm Qty 1		

O-rings

EPDM

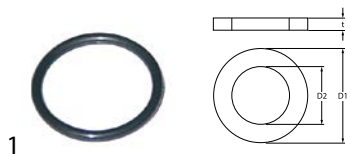

<b>GEV No.</b>	510072	<b>Ref. No.</b>	483286009313
<b>description</b>	O-ring EPDM thickness 3.53mm ID ø 32.93mm Qty 1 pcs		

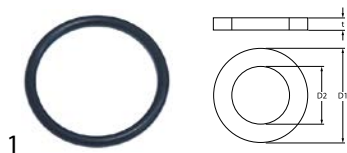

<b>GEV No.</b>	510899	<b>Ref. No.</b>	483286009314
<b>description</b>	O-ring EPDM thickness 3.53mm ID ø 37.69mm Qty 1 pcs		

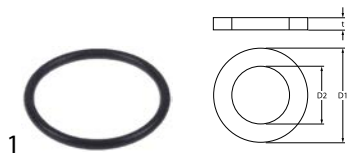

<b>GEV No.</b>	519179	<b>Ref. No.</b>	4832 860 08173
<b>description</b>	O-ring EPDM thickness 3.53mm ID ø 41.28mm Qty 1 pcs		

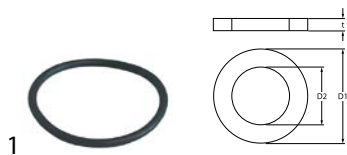

<b>GEV No.</b>	532113	<b>Ref. No.</b>	483286009312
<b>description</b>	O-ring EPDM thickness 3.53mm ID ø 49.21mm Qty 10 pcs		

<b>GEV No.</b>	521120	<b>Ref. No.</b>	483286008139
<b>description</b>	O-ring EPDM thickness 5.34mm ID ø 37.47mm Qty 1 pcs		

### sealing washers

#### rubber gaskets



<b>GEV No.</b>	519114	<b>Ref. No.</b>	483286008162
<b>description</b>	flat gasket rubber ED ø 25mm ID ø 16.5mm thickness 2mm Qty 1 pcs		



<b>GEV No.</b>	519347	<b>Ref. No.</b>	4832 860 01183
<b>description</b>	flat gasket rubber ED ø 80mm ID ø 60mm thickness 3mm Qty 1 pcs equiv. no. TR2448 suitable for Silanos		

#### plastic gaskets



<b>GEV No.</b>	504435	<b>Ref. No.</b>	483286008935
<b>description</b>	flat gasket plastic ED ø 18mm ID ø 9.5mm thickness 2.5mm for door hinge Qty 1 pcs		

## refrigeration cycle components

### valves

#### Schrader valves

##### Schrader valves (complete)



<b>GEV No.</b>	750340	<b>Ref. No.</b>	208171 771985005990	
<b>description</b>	Schrader valve complete connection soldering connection ø 6mm pipe length 100mm			
<b>accessories for</b>	750340			
	<b>GEV No.</b>	750479	<b>Ref. No.</b>	—
	screw cap CASTEL 8392/A size 1/4" SAE for Schrader valve connection 1/4" Qty 1			

### indicators

#### CASTEL



<b>GEV No.</b>	750418	<b>Ref. No.</b>	485609933017
<b>description</b>	moisture indicator CASTEL type 3940/M10 with indicator connection ODF 10mm L 117mm -30 jusqu'à +110°C		

### evaporators

#### producer-specific



<b>GEV No.</b>	750354	<b>Ref. No.</b>	483286008071
<b>description</b>	evaporator L 1000mm W 470mm Hmm suitable for BEV/KIC		



<b>GEV No.</b>	750449	<b>Ref. No.</b>	483286009936
<b>description</b>	evaporator L 490mm W 295mm H 70mm refrigerated counter suitable for ILSA		

### springs

#### torsion springs



<b>GEV No.</b>	690683	<b>Ref. No.</b>	182178
<b>description</b>	torsion spring ø 14.5mm wire gauge ø 2.5mm L1 86mm L2 30mm L3 16mm refrigerator		

			
1			
<b>GEV No.</b>	700087	<b>Ref. No.</b>	182179
<b>description</b>	torsion spring $\phi$ 14.5mm wire gauge $\phi$ 2.7mm L1 86mm L2 30mm L3 16mm refrigerator		

## manometers

			
1			
<b>GEV No.</b>	541579	<b>Ref. No.</b>	483286009207
<b>description</b>	manometer $\phi$ 52mm pressure range 0 up to 1bar connection marking 0.5 thread 1/4"		

			
1			
<b>GEV No.</b>	541798	<b>Ref. No.</b>	771985003651
<b>description</b>	manometer $\phi$ 52mm pressure range 0-6bar connection lower thread 1/4"		





## dosing pumps











### membrane dosing pumps

#### self-priming with supporting pressure

GERMAC

type 2001

			
1			
<b>GEV No.</b>	361545	<b>Ref. No.</b>	483286008816
<b>description</b>	dosing pump type 2001 rinse aid inlet 4x6mm outlet M10x1 suction connection $\phi$ 4x6mm supporting pressure 11mm rebound ball PTFE 1mm GERMAC CODE VNR/U3		
<b>spare parts for</b>	361545		
	<b>GEV No.</b>	361551	<b>Ref. No.</b>
	compression spring wire gauge $\phi$ 1mm		
	<b>GEV No.</b>	361700	<b>Ref. No.</b>
	hose connector rotary hose $\phi$ 4x6mm plastic connection M10x1		
	<b>GEV No.</b>	361702	<b>Ref. No.</b>
	hose connector brass hose $\phi$ 4x6mm		
	<b>GEV No.</b>	361705	<b>Ref. No.</b>
	gasket for hose connector M12x1		

<b>spare parts for</b>	361545		
	<b>GEV No.</b>	510298	<b>Ref. No.</b>
	lip valve dosing pump suitable for DB2/DS5		
<b>accessories for</b>	361545		
	<b>GEV No.</b>	361142	<b>Ref. No.</b>
	mounting set detergent hose type 4x6mm hose length 2m PVC 2x hose/container filter/tank intake transparent		
	<b>GEV No.</b>	361550	<b>Ref. No.</b>
	hose connector hose $\phi$ 4x6mm		
	<b>GEV No.</b>	361553	<b>Ref. No.</b>
	membrane EPDM		
	<b>GEV No.</b>	361701	<b>Ref. No.</b>
	hose connector thread M10x1 grommet $\phi$ 7.5mm		
	<b>GEV No.</b>	361703	<b>Ref. No.</b>
	hose connector thread M10x1 brass pipe connection $\phi$ 4x6mm		
	<b>GEV No.</b>	361704	<b>Ref. No.</b>
	hose connector brass straight thread M12x1 hose $\phi$ 11mm Qty 1 pcs		
	<b>GEV No.</b>	510296	<b>Ref. No.</b>
	membrane silicone		
	<b>GEV No.</b>	520090	<b>Ref. No.</b>
	PVC hose ID $\phi$ 4mm ED $\phi$ 6mm L 2m thickness 1mm t.max. 60°C transparent		
	<b>GEV No.</b>	520091	<b>Ref. No.</b>
	nylon hose ID $\phi$ 4mm ED $\phi$ 6mm L 2m thickness 1mm operating p. 10bar burst p. 50bar t.max. 100°C transparent		

## hoses

### drain hoses

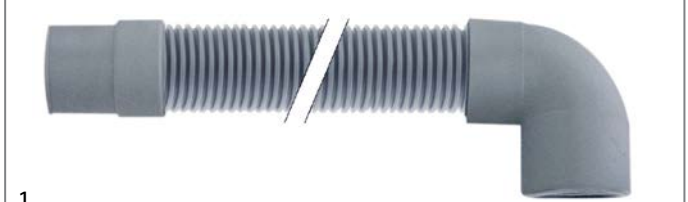
			
1			
<b>GEV No.</b>	530571	<b>Ref. No.</b>	483286008165
<b>description</b>	drain hose DN24 L 1500mm straight $\phi$ inside 24mm straight ext. $\phi$ 29mm elbow $\phi$ inside 29mm elbow ext. $\phi$ 35mm outer hose $\phi$ 28mm		



## fittings, hose and pipe connectors

### hose connectors

#### nickel-plated brass



1

<b>GEV No.</b>	519239	<b>Ref. No.</b>	4832 860 08802
<b>description</b>	hose connector nickel-plated brass thread 1/4" hose ø 11mm Qty 1 pcs		

#### producer-specific



1

<b>GEV No.</b>	520336	<b>Ref. No.</b>	483286002402
<b>description</b>	hose connector thread 1/4" grommet ø 12mm ID ø 8mm grommet length 19mm WS 14 total length 35mm thread L 10mm		



1

<b>GEV No.</b>	520337	<b>Ref. No.</b>	483286002401
<b>description</b>	hose connector thread 1/4" grommet ø 7mm ID ø 4.5mm grommet length 19mm WS 14 total length 35mm thread L 10mm		

## valves and tank inlets

### ball valves

#### ball valves electric



1





<b>GEV No.</b>	401085	<b>Ref. No.</b>	483286002415
<b>description</b>	ball valve inlet 1/2" IT outlet 1/2" IT 230V L 60mm 50/60Hz closed off-current mode of operation electric connection cable 400mm cable 3-pole		

## shut-off valves

### universal



1

<b>GEV No.</b>	514370	<b>Ref. No.</b>	483286009187	
<b>description</b>	shut-off valve connection 1/2" 1/2" hot total length 54mm shaft ø M5x0.8mm			
<b>spare parts for</b>	514370			
	<b>GEV No.</b>	514085	<b>Ref. No.</b>	—
	rosette connection 26x19G chrome-plated total lengthmm mounting pos.			
	<b>GEV No.</b>	514086	<b>Ref. No.</b>	—
	hexagonal nut connection 26x19G brass total lengthmm mounting pos. H 6mm WS 34 Qty 1 pcs			
	<b>GEV No.</b>	540414	<b>Ref. No.</b>	—
	star handle connection hot total lengthmm mounting pos. shaft diameter 7x7mm ø 55mm 35 built-in depth 22mm			
	<b>GEV No.</b>	540415	<b>Ref. No.</b>	—
	star handle connection cold total lengthmm mounting pos. shaft diameter 7x7mm ø 55mm 35 built-in depth 22mm			
	<b>GEV No.</b>	540672	<b>Ref. No.</b>	—
	gasket suitable for tap head			

## water cycle components

### pressure reduction valves

#### pressure reduction valves

#### producer-specific



1

<b>GEV No.</b>	520329	<b>Ref. No.</b>	483286002062
<b>description</b>	pressure reduction valve connection 1/2" brass		

## measuring equipment

## thermometers

## built-in thermometers

ø60mm



1

<b>GEV No.</b>	379593	<b>Ref. No.</b>	158081 771985010704
<b>description</b>	thermometer mounting ø 60mm t.max. 300°C 50-300°C probe ø 4mm probe L 135mm capillary pipe 1050mm		

## fastening material

## screws

## hexagonal screws



1

<b>GEV No.</b>	560539	<b>Ref. No.</b>	483286002139
<b>description</b>	hexagonal screw thread M10 thread L 42mm SS WS 17 Qty 1 pcs head thickness 6.5mm DIN 933 / ISO 4017		



<b>A</b>		<b>H</b>	
alarm devices	19	halogen lamp	17
axial fans	27	handle latches	48
<b>B</b>		heating cables	6
ball valves	63	heating cartridges	6
ball valves electric	24, 63	heating elements	3, 6
bar burners	43	heating elements for condensate evaporation	5
<b>C</b>		heating elements for convection	8
cam switches	15	heating elements for defrosting	4
capillary tube clips	13	heating elements for fryers	3
cold air circulating fans (complete)	28	heating elements for frying pans	3
compressors	25	heating elements for griddles	4
condensators & interference suppression filters	31	heating elements for heated trolleys	6
condensing trays heated	27	heating elements for ovens	3
contactors	19	heating elements for pasta cookers	5
control thermostats	10, 12	heating elements for pizza ovens	6
cross flow fans	28	heating elements for refrigeration	4
<b>D</b>		heating elements for salamanders/toasters	6
defrost timers	18	heating elements for tilting bratt pan	5
door seals	60	hexagonal screws	64
dosing pumps	62	hob burners	42
drain hoses	62	hose connectors	63
drain pumps	30	hoses	62
<b>E</b>		hot air motors	29
edgemount latches	48	hot plates	9
electric accessories	32	<b>I</b>	
electric timers	18	ignition boxes	37
electrodes	25	ignition cables	41
electronic magnets	32	ignition units	41
energy regulators	10	immersion heating elements	6
evaporators	61	indicator lights	17
<b>F</b>		indicator lights (complete)	17
fans	27	indicators	61
fastening material	64	<b>L</b>	
filters	31	lamps	17
foil heating elements	9	<b>M</b>	
<b>G</b>		magnetic switches	16
gas burners	42	measuring equipment	64
gas control valves	36	microswitches	14
gas nozzles	43	<b>O</b>	
gas taps	32	O-rings	60
gas thermostats	34	oven hinges	50
gaskets for heated units	59	oven lamps	18
grates	52	<b>P</b>	
		piezoelectric igniters	41
		pilot burners	38
		plug-in gaskets	53

pressure reduction valves	63, 63
pressure switches	24
probes	20
programme timers	18
pumps	29
pumps for ice machines	31
push/momentary push switches	14

**R**

radiation heaters	9
refrigeration cycle components	61
refrigeration fans	28
refrigeration gaskets	53
refrigeration motors universal	28
refrigeration thermostats	13
relays	20
rocker/momentary rocker switches	13
rotary switches	16

**S**

safety thermostats	11
safety valves	37
Schrader valves	61
screw-in gaskets	58
screws	64
sealing washers	61
shelves and shelf rails	52
shut-off valves	63
solenoid valves	22
spring assisted hinges	49
switches and momentary switches	13
system switches (ROLD)	14

**T**

terminals	32
thermocouples	41
thermostats	10
timers	18
transformers	20

**V**

valves and tank inlets	63
vibration pumps	30

**W**

wash and rinse pumps	29
water cycle components	63
window seals	59