



GAS COMPONENTS



ELECTRIC COMPONENTS



WATER TECHNOLOGY



MECHANICAL COMPONENTS



TOOLS

Spare parts suitable for

WIESHEU-WIWA

Find the complete and up-to-date range of products in our GEV Webshop



Manufacturer catalogue

The most important spare parts and accessories arranged clearly for every manufacturer

- ✓ Complete product range and all appliance data always up to date in the GEV Webshop
- ✓ Alphabetical Index at the end of the catalogue

GEV Webshop

www.gev-online.co.uk

www.gev-online.com





- 🔍 Add to Favourites
- 🔍 Sign In with email address and usual password
- 🔍 Easy-order – place several items in your basket at the same time
- 🔍 Quick Item search – no login needed





heating elements

heating elements for chicken rotisseries

			
GEV No.	415534	Ref. No.	35100
description	heating element 1000W 230V L 795mm W 50mm Hmm heating circuits 1 connection M4 dry heating element tube ø 8.5mm connection distance 42mm		

			
GEV No.	415529	Ref. No.	35157
description	heating element 1000W 230V L 917mm W 90mm heating circuits 1 connection M4 dry heating element tube ø 8.5mm grill connection distance 81mm		

			
GEV No.	415536	Ref. No.	35126
description	heating element 1100W 220V L 760mm W 44mm Hmm heating circuits 1 connection male faston 6.3mm dry heating element tube ø 6.5mm		

			
GEV No.	415535	Ref. No.	35089
description	heating element 1500W 230V L 648mm W 57mm Hmm heating circuits 1 connection M4 dry heating element tube ø 8.5mm connection length 19mm		

			
GEV No.	415530	Ref. No.	35158
description	heating element 2000W 230V L 940mm W 43mm Hmm heating circuits 1 connection M4 dry heating element tube ø 8.5mm connection length 19mm connection distance 34mm		

heating elements for salamanders/toast-



			
GEV No.	415452	Ref. No.	35682
description	heating element 750W 230V heating circuits 1 L 400mm W 55mm connection M4 tube ø 6.3mm connection length 20mm dry heating element H 6.3mm mounting distance 48mm		

immersion heating elements

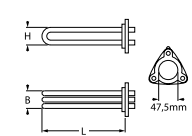
3 hole flange ø47.5mm

 			
GEV No.	415832	Ref. No.	34950
description	heating element 7000W 230V mounting ø 47.5mm heating circuits 3 L 290mm W 32mm H 40mm number of thermostat sleeves 1 thermostat sleeves ø 7mm length thermostat sleeves 210mm thermostat sleeve eccentric, non clinging hole distance 62mm hole ø 8mm connection male faston 6.3mm 3 hole flange immersion heater		

GEV No.	415832	Ref. No.	34950
description	heating element 7000W 230V mounting ø 47.5mm heating circuits 3 L 290mm W 32mm H 40mm number of thermostat sleeves 1 thermostat sleeves ø 7mm length thermostat sleeves 210mm thermostat sleeve eccentric, non clinging hole distance 62mm hole ø 8mm connection male faston 6.3mm 3 hole flange immersion heater		

spare parts for	415832			
	GEV No.	510408	Ref. No.	—
	O-ring EPDM thickness 5.34mm ID ø 47mm Qty 1 pcs			
accessories for	415832			
	GEV No.	510562	Ref. No.	34470
	O-ring silicone thickness 5.34mm ID ø 47mm Qty 1 pcs			

with expansion flange 70 x 18mm

			
GEV No.	415837	Ref. No.	36093
description	heating element 5000W 380V heating circuits 1 L 315mm W 61mm connection M4 tube ø 8.5mm immersion heater		

heating elements for convection

			
GEV No.	418635	Ref. No.	N/A
description	heating element 2600W 230V heating circuits 1 ID ø 215mm L 325mm H 12mm L1 55mm W1 29mm flange length 40mm flange width 20mm ED ø 280mm tube ø 6.6mm		



1

GEV No.	415841	Ref. No.	34671
description	heating element 3000W 230V heating circuits 1 ID ø 192mm ED ø 205mm L 220mm H 36mm L1 17mm W1 30mm H1 12mm H2 24mm flange length 70mm flange width 22mm hole distance 28mm connection male faston 6.3mm tube ø 6.3mm convection heating element hole ø 4.5mm rectangular flange		
accessories for	415841		
	GEV No.	510368	Ref. No. —
	gasket L 70mm W 23.5mm hole ø 5mm hole distance 56mm FIBER thickness 2mm for heating element		





1

GEV No.	418633	Ref. No.	38134
description	heating element 3000W 230V heating circuits 1 ID ø 200mm ED ø 213mm L 228mm H 30mm L1 15mm W1 28mm H1 4mm H2 26mm flange length 70mm flange width 22mm hole distance 32mm connection male faston 6.3mm connection length 40mm convection heating element mounting thread M5 rectangular flange with thread bolt		



1

GEV No.	415643	Ref. No.	33155
description	heating element 4000W 400V heating circuits 1 ID ø 224mm ED ø 235mm L 260mm H 30mm L1 15mm W1 32mm H1 5mm H2 25mm flange length 70mm flange width 22mm hole distance 56mm connection cable tube ø 6.3mm cable length 620mm convection heating element mounting thread M4 rectangular flange with thread bolt		
accessories for	415643		
	GEV No.	510368	Ref. No. —
	gasket L 70mm W 23.5mm hole ø 5mm hole distance 56mm FIBER thickness 2mm for heating element		





1

GEV No.	415843	Ref. No.	36518
description	heating element 4500W 230V heating circuits 3 ID ø 240mm ED ø 257mm L 306mm H 44mm L1 100mm W1 85mm H1 37mm H2 7mm flange length 121mm flange width 40mm hole distance 104mm connection 6.3 connection length 20mm tube ø 8.5mm convection heating element mounting thread M5 rectangular flange with thread bolt		





1

GEV No.	415830	Ref. No.	34948
description	heating element 7000W 230V heating circuits 3 ID ø 385mm ED ø 400mm L 400mm H 80mm W1 157mm H1 15mm H2 65mm flange length 170mm flange width 30mm tube ø 10mm		
accessories for	415830		
	GEV No.	510250	Ref. No. 36010 9085-100-001
	gasket L 168mm W 31mm for heating element suitable for WIESHEU		





1

GEV No.	415831	Ref. No.	34949
description	heating element 7000W 230V heating circuits 3 ID ø 438mm ED ø 460mm L 460mm H 92mm W1 160mm H1 26mm H2 66mm flange length 170mm flange width 30mm hole distance 35mm connection male faston 6.3mm connection length 75mm tube ø 10mm convection heating element mounting thread M5 mounting pos. outer rectangular flange with thread bolt		
accessories for	415831		
	GEV No.	510250	Ref. No. 36010 9085-100-001
	gasket L 168mm W 31mm for heating element suitable for WIESHEU		









1

GEV No.	415823	Ref. No.	33157
description	heating element 8000W 380V heating circuits 2 ID ø 268mm ED ø 300mm L 335mm H 48mm L1 20mm W1 38mm H1 30mm H2 18mm flange length 70mm flange width 22mm hole distance 55mm connection cable tube ø 6.3mm cable length 580mm convection heating element mounting thread M4 rectangular flange with thread bolt		
accessories for	415823		
	GEV No.	550937	Ref. No. 33455
	gasket L 71mm W 21mm hole ø 5mm hole distance 57mm fibre thickness 1mm for heating element		



1

GEV No.	415840	Ref. No.	34891
description	heating element 2500W 230V heating circuits 1 L 130mm W 557mm connection length 56mm connection M4 tube ø 8.6mm thread M14x1.5 2 hole fixing convection heating element mounting distance 552mm		
accessories for	415840		
	GEV No.	510417	Ref. No. —
	flat gasket fibre ED ø 20mm ID ø 14mm thickness 2mm Qty 1 pcs		
	GEV No.	520228	Ref. No. —
	tooth lock washer ID ø 15.3mm ED ø 24mm steel Qty 1 pcs for thread M14		
	GEV No.	520230	Ref. No. —
	nut thread M14x1.5 H 5mm WS 19 zinc-coated steel Qty 1 pcs		
	GEV No.	521101	Ref. No. —
	nut thread M14x1.5 H 5mm WS 19 SS Qty 1 pcs		
	GEV No.	550262	Ref. No. —
	flat gasket copper ED ø 20mm ID ø 14mm thickness 2mm		



1

GEV No.	418634	Ref. No.	N/A
description	heating element 2500W 230V heating circuits 1 L 340mm W 240mm L1 30mm L2 200mm W2 155mm tube ø 8.5mm thread M14x1.5 W1 85mm mounting distance 35mm		



1

GEV No.	415833	Ref. No.	34960
description	heating element 3000W 230V heating circuits 3 L 400mm W 100mm L1 60mm L2 170mm W2 70mm flange length 90mm flange width 35mm hole distance 38mm connection length 40mm connection male faston 6.3mm tube ø 8.5mm thread M4 W1 30mm rectangular flange dry heating element		
accessories for	415833		
	GEV No.	510251	Ref. No. 36117
	gasket L 90mm W 36mm thickness 1.7mm for heating element suitable for WIESHEU		



1

GEV No.	415839	Ref. No.	34890
description	heating element 3000W 400V heating circuits 1 L 160mm W 550mm connection length 57mm connection M4 tube ø 8.6mm thread M14x1.5 2 hole fixing convection heating element mounting distance 550mm		
accessories for	415839		
	GEV No.	510417	Ref. No. —
	flat gasket fibre ED ø 20mm ID ø 14mm thickness 2mm Qty 1 pcs		
	GEV No.	520228	Ref. No. —
	tooth lock washer ID ø 15.3mm ED ø 24mm steel Qty 1 pcs for thread M14		
	GEV No.	520230	Ref. No. —
	nut thread M14x1.5 H 5mm WS 19 zinc-coated steel Qty 1 pcs		
	GEV No.	521101	Ref. No. —
	nut thread M14x1.5 H 5mm WS 19 SS Qty 1 pcs		
	GEV No.	550262	Ref. No. —
	flat gasket copper ED ø 20mm ID ø 14mm thickness 2mm		



1

GEV No.	415834	Ref. No.	34961
description	heating element 4000W 230V heating circuits 3 L 400mm W 100mm L1 60mm L2 170mm W2 70mm flange length 90mm flange width 35mm hole distance 38mm connection length 40mm connection male faston 6.3mm tube ø 8.5mm thread M4 W1 30mm rectangular flange dry heating element		
For models:	B4ML		
accessories for	415834		
	GEV No.	510251	Ref. No. 36117
	gasket L 90mm W 36mm thickness 1.7mm for heating element suitable for WIESHEU		



accessories

sealing washers

O-rings

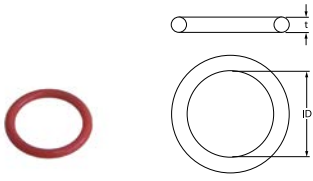

1			
GEV No.	510562	Ref. No.	34470
description	O-ring silicone thickness 5.34mm ID ø 47mm Qty 1 pcs		

flange gaskets



1			
GEV No.	550937	Ref. No.	33455
description	gasket L 71mm W 21mm hole ø 5mm hole distance 57mm fibre thickness 1mm for heating element		



1			
GEV No.	510250	Ref. No.	36010 9085-100-001
description	gasket L 168mm W 31mm for heating element suitable for WIESHEU		



1			
GEV No.	510251	Ref. No.	36117
description	gasket L 90mm W 36mm thickness 1.7mm for heating element suitable for WIESHEU		

thermostats

bi-metal thermostats

bi-metal thermostats



1			
GEV No.	390123	Ref. No.	400342
description	bi-metal thermostat hole distance 23.8mm switch-off temp. 50°C 1NC 1-pole 16A 250V connection F6.3 2 hole fixing		

control and safety thermostats

EGO

control thermostats

55.13_ series



GEV No.	375154	Ref. No.	Sach.Nr.61902,36113
description	thermostat t.max. 250°C temperature range 50-250°C 1-pole 1NO 16A probe ø 3.1mm probe L 201mm capillary pipe 2970mm capillary pipe isolatedmm gland nut shaft L 23mm shaft position upper rotation 270° probe material SS		



GEV No.	375010	Ref. No.	34352
description	thermostat t.max. 250°C temperature range 50-250°C 1-pole 1NO 16A probe ø 3.1mm probe L 208mm capillary pipe 1130mm capillary pipe isolatedmm gland nut shaft L 23mm shaft position upper rotation 270°		



GEV No.	375124	Ref. No.	61902
description	thermostat t.max. 270°C temperature range 70-270°C 1-pole 1NO 16A probe ø 7.5mm probe L 30.5mm capillary pipe 3130mm capillary pipe isolatedmm gland nut shaft L 23mm shaft position lower rotation 270°		







GEV No.	375505	Ref. No.	33073
description	thermostat t.max. 320°C temperature range 50-320°C 1-pole 1NO 16A probe ø 3mm probe L 160mm capillary pipe 870mm capillary pipe isolatedmm gland nut shaft ø 6x4.6mm shaft L 23mm shaft position upper rotation 270°		



GEV No.	375152	Ref. No.	36035 9030-145-001
description	safety thermostat switch-off temp. 145°C 1-pole 16A probe ø 4mm probe L 100mm capillary pipe 1130mm capillary pipe isolatedmm gland nut probe SS		



GEV No.	375005	Ref. No.	33003
description	thermostat t.max. 85°C temperature range 30-85°C 1-pole 1NO 16A probe ø 6mm probe L 92mm capillary pipe 830mm capillary pipe isolatedmm gland nut shaft L 23mm shaft position upper rotation 270° probe material SS		
accessories for	375005		
	GEV No.	110109	Ref. No. —
	knob thermostat t.max. 85°C ø 60mm shaft ø 6x4.6mm shaft flat upper silver temperature range 30-85°C rotation 270°		
	GEV No.	110133	Ref. No. —
	knob thermostat t.max. 85°C ø 50mm shaft ø 6x4.6mm shaft flat upper black temperature range 30-85°C rotation 270°		
	GEV No.	110240	Ref. No. —
	knob thermostat t.max. 85°C ø 50mm shaft ø 6x4.6mm shaft flat upper black temperature range 30-85°C		

55.32_series



GEV No.	375392	Ref. No.	38643
description	safety thermostat switch-off temp. 360°C 3-pole 1CO/2NC 20A probe ø 4mm probe L 120mm capillary pipe 1490mm capillary pipe isolated 1450mm gland nut probe SS		

safety thermostats

55.13_series



1

GEV No.	375151	Ref. No.	34748
description	safety thermostat switch-off temp. 135°C 1-pole capillary pipe isolatedmm gland nut probe		

switches and momentary switches

rocker/momentary rocker switches

30x22mm



GEV No.	301061	Ref. No.	35667
description	rocker switch mounting measurements 30x22mm orange 2NO 250V 16A illuminated connection male faston 6.3mm ambient temperature max. 125/55°C protection IP40		

miscellaneous



1

GEV No.	346428	Ref. No.	35667
description	rocker switch double		



GEV No.	346429	Ref. No.	35668
description	rocker switch triple		

cam switches

4-position



GEV No.	300023	Ref. No.	421053
description	cam switch 4 operating positions 1NO/2CO sequence 0-1-2-3 16A shaft ø 6x4.6mm shaft L 23mm connection screw 4-position ceramic		

control equipment

MOELLER/EATON

push buttons - signal lamps



GEV No.	346746 ¹	Ref. No.	401083
description	push button mounting measurements ø22mm black without button lense latching illuminable		

¹works as signal element



GEV No.	346723	Ref. No.	401082
description	push button mounting measurements ø22mm black without button plate momentary		

lamps



GEV No.	359606	Ref. No.	33050	
description	neon light bulb socket Ba9s 220V 2W clear ø 10mm L 28mm			
accessories for	359606			
	GEV No.	359832	Ref. No.	—
	lamp socket mounting measurements ø16.2mm socket Ba9s connection male faston 6.3mm			

accessories for	359606			
	GEV No.	359853	Ref. No.	—
	lamp socket mounting measurements ø18.2mm socket Ba9s connection male faston 6.3mm			

lamps

indicator lights

indicator lights 3-piece (housing, lens and bulb)

lamps

neon light bulbs



GEV No.	359606	Ref. No.	33050
description	neon light bulb socket Ba9s 220V 2W clear ø 10mm L 28mm		

accessories for	359606			
	GEV No.	359832	Ref. No.	—
	lamp socket mounting measurements ø16.2mm socket Ba9s connection male faston 6.3mm			

	GEV No.	359853	Ref. No.	—
	lamp socket mounting measurements ø18.2mm socket Ba9s connection male faston 6.3mm			

indicator lights (complete)

miscellaneous



GEV No.	359863	Ref. No.	35703
description	indicator light mounting measurements 90 x 35mm green 230V triple		

screw-on/push-on fit

neon light bulbs



GEV No.	359606	Ref. No.	33050
description	neon light bulb socket Ba9s 220V 2W clear ø 10mm L 28mm		

accessories for	359606			
	GEV No.	359832	Ref. No.	—
	lamp socket mounting measurements ø16.2mm socket Ba9s connection male faston 6.3mm			

	GEV No.	359853	Ref. No.	—
	lamp socket mounting measurements ø18.2mm socket Ba9s connection male faston 6.3mm			



linear lamps

infrared lamps

with base type R7s



GEV No.	359622	Ref. No.	35101 423016
description	infrared lamp socket Li_R base 230V 1000W L 428mm cable length 100mm		

timers

electric timers



GEV No.	350143	Ref. No.	33121
description	timer MS65 without bell operation time 60min time spreadmin 2CO at 250V 16A permanent position no time range 0-60min impulse electric shaft ø 6x4.6mm shaft L 22mm EATON (INVENSYS) ambient temperature max. 85°C 50Hz 2-pole 230V		

mechanical timers



GEV No.	350169	Ref. No.	421017/1
description	timer 601 2-pole operation time 60min impulse mechanical 2CO at 250V 16A permanent position no shaft ø 6x4.6mm shaft 6x4.6mm shaft L 21mm mounting distance 28mm connection lateral		

alarm devices

buzzers



GEV No.	350050	Ref. No.	36058
description	buzzer 230VAC connection male faston 6.3mm screw mounting thread M4 60dB		

transformers

open transformers

with clamp terminal



GEV No.	400064	Ref. No.	34100
description	transformer primary 220V secondary 12V		

probes

producer-specific probes

probes



GEV No.	379083	Ref. No.	34988
description	temperature probe Pt500 cable PTFE probe -100 up to 450°C cable -40 up to +250°C connection 2-wire thread 1/2" probe ø6x120mm cable length 1m		



GEV No.	379047	Ref. No.	33904
description	temperature probe Pt500 cable PTFE probe -100 up to 450°C cable -40 up to +250°C connection 2-wire thread 1/4" probe ø6x73mm cable length 1m		



GEV No.	379066	Ref. No.	34897
description	temperature probe PTC cable probe -50 up to +150°C cable°C connection M3x0.6 thread M3x0.6 probe ø0.5x39mm cable lengthm		



GEV No.	379067	Ref. No.	36287
description	temperature probe thermocouple K (NiCr-Ni) cable PTFE probe -50 up to 1150°C cable -40 up to +250°C connection 2-wire thread probe ø2x82mm cable length 3m		



GEV No.	379040	Ref. No.	36096
description	temperature probe thermocouple K (NiCr-Ni) cable PVC probe -50 up to 1150°C cable -10 up to 100°C connection 2-wire thread probe ø2x65mm cable length 1m		



core probes

1 

GEV No.	378108	Ref. No.	34370
description	core temperature probe Pt100 cable PTFE probe -40 up to +250°C cable -40 up to +250°C connection 2-wire probe ø4x100mm thread 1/4" cable length 3m handle ø 15mm handle length 85mm		

1 

GEV No.	379059	Ref. No.	38648
description	core temperature probe Pt100 cable SS corrugated hose probe -40 up to +250°C cable -40 up to +250°C connection 2-wire probe ø4x100mm thread 1/4" cable length 2.5m handle ø 15mm handle length 85mm		

1 

GEV No.	379069	Ref. No.	33905
description	core temperature probe Pt500 cable SS corrugated hose probe -40 up to +250°C cable -40 up to +250°C connection 2-wire probe ø4x110mm thread 1/4" cable length 2.5m handle ø 15mm handle length 85mm		

1 

GEV No.	400181	Ref. No.	36337T
description	PCB complete		

electrodes

1 

GEV No.	400065	Ref. No.	36090
description	level electrode M15x1.5 total length 135mm probe L 77/67/57mm insulated probe length 70mm with 3 probes connection grip connection		

fans

cross flow fans

COPREL
with standard coil

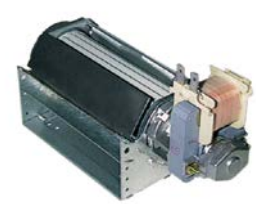
1 

GEV No.	601051	Ref. No.	33547
description	cross flow fan TFR 45-120 roller ø 45mm roller length 120mm laminated core thickness 20mm motor position right 230V/50Hz 25W universal bearing silicone connection male faston 6.3mm airflow 85m³/h -30 up to +100°C 230V 50Hz		

hot air motors

1 

GEV No.	601669	Ref. No.	33651
description	fan wheel for motor cooling ED ø 128mm H 20mm shaft intake ø 17mm		

electronics

PCBs

1 
Image not available

GEV No.	400180	Ref. No.	93022
description	control PCB with keypad		

1 
Image not available

GEV No.	400182	Ref. No.	36336 neu
description	PCB		



knobs

universal knobs



1

GEV No.	110123	Ref. No.	33084
description	knob thermostat t.max. 300°C ø 50mm shaft ø 6x4.6mm shaft flat upper black temperature range 50-300°C rotation 270°		
accessories for	110123		
	GEV No.	110135	Ref. No.
			—
	rosette knob up to ø 52mm		

gaskets

gaskets for heated units

window seals

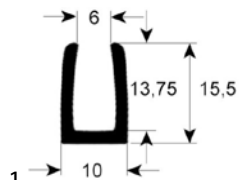

1

GEV No.	900065	Ref. No.	36070
description	window gasket profile 1610 Qty supplied by meter		

door seals

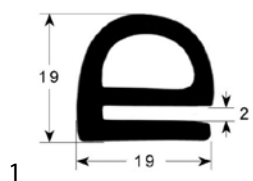

1

GEV No.	900054	Ref. No.	40038/2.4m
description	door seal profile 2210 Qty supplied by meter temp.-resist. -40 up to +250°C		

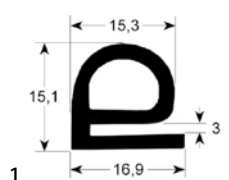

1

GEV No.	900068	Ref. No.	40038 40198
description	door seal profile 2220 Qty supplied by meter		

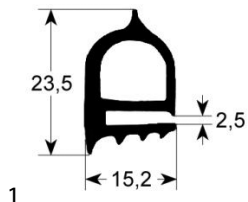

1

GEV No.	900069	Ref. No.	34914
description	door seal profile 2240 Qty supplied by meter		

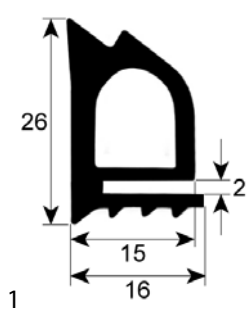

1

GEV No.	901451	Ref. No.	37884
description	door seal profile 2241 Qty supplied by meter		

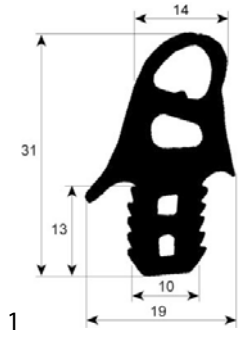

1

GEV No.	900751	Ref. No.	38605
description	door seal profile 2705 Qty supplied by meter		

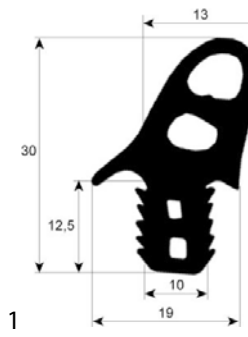

1

GEV No.	900750	Ref. No.	38604
description	door seal profile 2706 Qty supplied by meter		

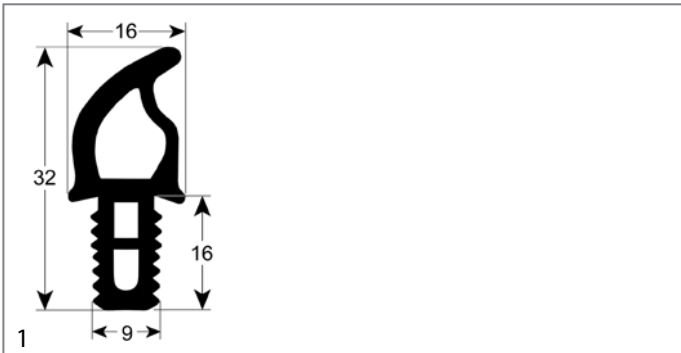

GEV No.	901766	Ref. No.	38337
description	door seal profile 2744 Qty supplied by meter		

door seals with fixing hook

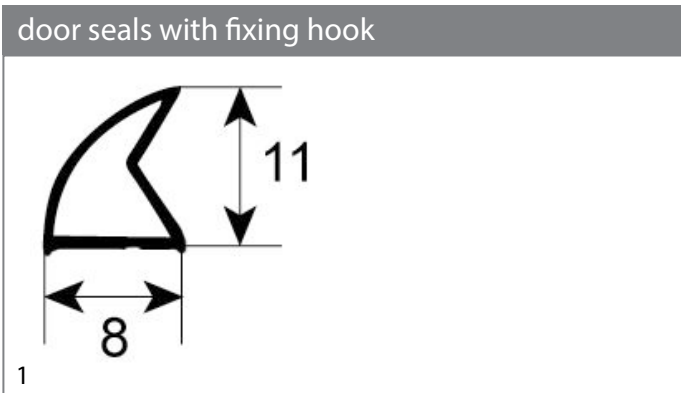

GEV No.	900370	Ref. No.	40233
description	oven gasket profile 5000 L 480mm W 320mm with 6 mounting clips external size		

O-rings

silicone

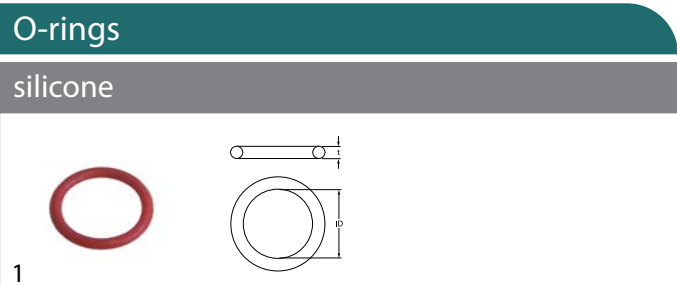

GEV No.	510562	Ref. No.	34470
description	O-ring silicone thickness 5.34mm ID ø 47mm Qty 1 pcs		

A		
alarm devices	9	
B		
bi-metal thermostats	6, 6	
C		
cam switches	8	
control equipment	8	
control thermostats	6	
cross flow fans	10	
D		
door seals	11	
door seals with fixing hook	12	
E		
electric timers	9	
electrodes	10	
F		
fans	10	
G		
gaskets for heated units	11	
H		
heating elements	3	
heating elements for convection	3	
heating elements for salamanders/toasters	3	
hot air motors	10	
I		
immersion heating elements	3	
indicator lights	8	
indicator lights (complete)	8	
infrared lamps	9	
L		
lamps	8	
linear lamps	9	
M		
mechanical timers	9	
N		
neon light bulbs	8, 8	
O		
O-rings	12	
P		
probes	9	
R		
rocker/momentary rocker switches	7	
S		
safety thermostats	7	
switches and momentary switches	7	
T		
thermostats	6	
timers	9	
transformers	9	
W		
window seals	11	