



**GAS COMPONENTS**



**ELECTRIC COMPONENTS**



**WATER TECHNOLOGY**



**MECHANICAL COMPONENTS**



**TOOLS**

Spare parts suitable for

**ZANUSSI**

Find the complete and up-to-date range of products in our GEV Webshop



# Manufacturer catalogue

The most important spare parts and accessories arranged clearly for every manufacturer

- ✓ Complete product range and all appliance data always up to date in the GEV Webshop
- ✓ Alphabetical Index at the end of the catalogue

## GEV Webshop

[www.gev-online.co.uk](http://www.gev-online.co.uk)

[www.gev-online.com](http://www.gev-online.com)







- 🔍 Add to Favourites
- 🔍 Sign In with email address and usual password
- 🔍 Easy-order – place several items in your basket at the same time
- 🔍 Quick Item search – no login needed



## induction

### induction coils



			
1			
<b>GEV No.</b>	404001	<b>Ref. No.</b>	0C0027
<b>description</b>	induction coils 5000W 400V for induction device		

<b>accessories for</b>	415078		
	<b>GEV No.</b>	521104	<b>Ref. No.</b> —
	washer ID ø 4.3mm ED ø 8mm thickness 0.5mm brass Qty 20 pcs for thread M4		
	<b>GEV No.</b>	560111	<b>Ref. No.</b> —
	plain washer ID ø 4.3mm ED ø 9mm thickness 0.8mm SS Qty 20 pcs DIN 125A for thread M4		
	<b>GEV No.</b>	560131	<b>Ref. No.</b> —
	hexagonal nut thread M4 H 3.2mm WS 7 SS DIN/ISO DIN 934 / ISO 4032/8673 Qty 20 pcs		

## heating elements

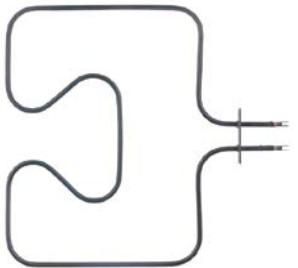

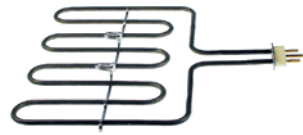

### heating elements for ovens

			
1			
<b>GEV No.</b>	418078	<b>Ref. No.</b>	005218
<b>description</b>	heating element 1000W 230V heating circuits 1 L 335mm W 345mm L1 55mm L2 280mm W1 154mm W2 36mm flange length 80mm flange width 16mm hole distance 60mm hole ø 5mm tube ø 6.3mm connection male faston 6.3mm connection length 60mm rectangular flange dry heating element		

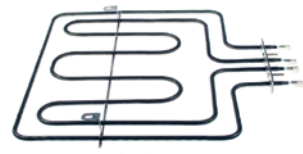
			
1			
<b>GEV No.</b>	418081	<b>Ref. No.</b>	054326
<b>description</b>	heating element 2000W 230V L 314mm W 290mm L1 11mm L2 213mm W1 126mm W2 33mm connection plug-in connection heating circuits 1 tube ø 6.5mm plug-in connection dry heating element		
<b>accessories for</b>	418081		
	<b>GEV No.</b>	550404	<b>Ref. No.</b> —
	power socket I-II phase 240V max. 16A countries I with screw connection for heating element		
	<b>GEV No.</b>	550405	<b>Ref. No.</b> —
	power socket male faston 6.3mm for heating element 2-pole + earthing		

			
1			
<b>GEV No.</b>	416977	<b>Ref. No.</b>	0C0310
<b>description</b>	heating element 1500W 230V L 530mm W 148mm H 24mm flange length 162mm flange width 18mm hole distance 72mm connection length 29mm tube ø 6.5mm connection M4 heating circuits 1 rectangular flange hole ø 6.5mm dry heating element		

			
1			
<b>GEV No.</b>	418082	<b>Ref. No.</b>	005205
<b>description</b>	heating element 2550W 230V heating circuits 2 L 333mm W 347mm L1 48mm L2 285mm W1 120mm W2 107mm flange length 120mm flange width 25mm bridge length 368mm hole ø M4mm tube ø 6.3mm connection male faston 6.3mm rectangular flange dry heating element hot air		

			
1			
<b>GEV No.</b>	415078	<b>Ref. No.</b>	054147
<b>description</b>	heating element 1500W 240V L 540mm W 150mm H 28mm 2 hole fixing mounting distance 145mm connection M4 tube ø 6.25mm dry heating element thread M10x1 heating circuits 1		
<b>accessories for</b>	415078		
	<b>GEV No.</b>	510416	<b>Ref. No.</b> —
	flat gasket fibre ED ø 19mm ID ø 10.5mm thickness 1.5mm for thread M10 Qty 1 pcs		
	<b>GEV No.</b>	510893	<b>Ref. No.</b> —
	O-ring EPDM thickness 2.62mm ID ø 9.92mm Qty 1 pcs		
	<b>GEV No.</b>	520231	<b>Ref. No.</b> —
	nut thread M10x1 H 6mm WS 14 zinc-coated steel Qty 1 pcs		
	<b>GEV No.</b>	521103	<b>Ref. No.</b> —
	nut thread M4 H 3mm WS 7 brass Qty 20 pcs		

			
1			
<b>GEV No.</b>	415378	<b>Ref. No.</b>	059237
<b>description</b>	heating element 950W 230V L 550mm W 63mm flange length 90mm flange width 25mm tube ø 8.5mm connection length 64mm heating circuits 1 hole ø 6mm connection male faston 6.3mm rectangular flange dry heating element oven		



## heating elements for bain maries

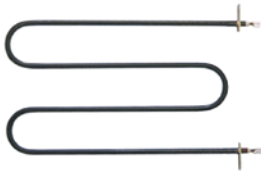

1

<b>GEV No.</b>	415293	<b>Ref. No.</b>	004910
<b>description</b>	heating element 1300W 230V heating circuits 1 L 330mm W 184mm tube ø 8.5mm lug length 40mm lug width 18mm connection male faston 6.3mm hole ø 5mm dry heating element bracket mounting		

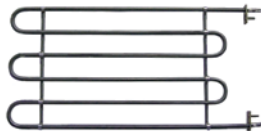

1

<b>GEV No.</b>	415596	<b>Ref. No.</b>	0G2290
<b>description</b>	heating element 1500W 230V heating circuits 1 L 395mm W 198mm tube ø 6.5mm lug length 31mm lug width 16mm connection length 30mm connection male faston 6.3mm dry heating element bracket mounting hole distance 160mm mounting thread M4		

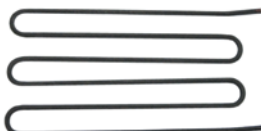

1

<b>GEV No.</b>	415353	<b>Ref. No.</b>	050933
<b>description</b>	heating element 1500W 230V heating circuits 1 L 395mm W 205mm H 25mm L1 50mm L2 345mm connection M4 connection distance 198mm tube ø 8.5mm connection length 20mm dry heating element		



1

<b>GEV No.</b>	415074	<b>Ref. No.</b>	051998
<b>description</b>	heating element 2300W 230V heating circuits 1 L 641mm W 180mm tube ø 8.5mm lug length 40mm lug width 18mm mounting thread M5 connection length 50mm connection male faston 6.3mm dry heating element rectangular flange		



1

<b>GEV No.</b>	415383	<b>Ref. No.</b>	052416
<b>description</b>	heating element 300W 230V heating circuits 1 L 532mm W 54mm flange length 72mm flange width 20mm connection length 45mm connection M5 tube ø 8.5mm rectangular flange hole ø 5mm dry heating element		



1

<b>GEV No.</b>	415096	<b>Ref. No.</b>	0A2197
<b>description</b>	heating element 550W 230V heating circuits 1 L 438mm W 44mm flange length 60mm flange width 40mm connection length 38mm connection male faston 6.3mm tube ø 6.3mm rectangular flange hole ø 6mm dry heating element		



1

<b>GEV No.</b>	415097	<b>Ref. No.</b>	0A2137
<b>description</b>	heating element 800W 230V heating circuits 1 L 630mm W 44mm flange length 60mm flange width 40mm connection length 32mm connection male faston 6.3mm tube ø 6.3mm rectangular flange hole ø 6mm dry heating element		

## heating elements for frying pans



1

<b>GEV No.</b>	420137	<b>Ref. No.</b>	0K6869
<b>description</b>	heating element 1000W 380V heating circuits 1 L 395mm W 50mm connection length 9mm connection M4 tube ø 8.3mm 2 hole fixing thread M14x1.5 dry heating element W1 6mm W2 44mm H 27mm mounting distance 36mm		



1

<b>GEV No.</b>	420123	<b>Ref. No.</b>	051358
<b>description</b>	heating element 1300W 240V heating circuits 1 L 535mm W 82mm connection cable tube ø 14mm cable length 1000mm dry heating element for tilting bratt pan L1 55mm W1 11mm W2 60mm H 100mm Qty 1 connection distance 50mm		



1

<b>GEV No.</b>	415184	<b>Ref. No.</b>	059401
<b>description</b>	heating element 2000W 230V heating circuits 1 L 570mm W 86mm connection length 24mm connection M5 tube ø 8.5mm dry heating element griddle H 87mm		

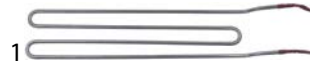

1

<b>GEV No.</b>	420139	<b>Ref. No.</b>	0K4747
<b>description</b>	heating element 2000W 230V heating circuits 1 L 585mm W 105mm connection cable tube ø 8.3mm cable length 1050mm dry heating element L1 55mm L2 20mm L3 510mm H 49mm connection distance 97mm		

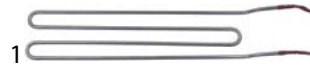

1

<b>GEV No.</b>	420129	<b>Ref. No.</b>	0K4748
<b>description</b>	heating element 2500W 230V heating circuits 1 L 580mm W 115mm connection cable tube ø 8.3mm cable length 1000mm dry heating element for tilting bratt pan L1 55mm L2 20mm L3 505mm H 48mm connection distance 107mm		



heating elements for fryers

<b>GEV No.</b>	420124	<b>Ref. No.</b>	004628
<b>description</b>	heating element 2900W 230V heating circuits 1 L 233mm W 77mm H 245mm rectangular flange connection male faston 6.3mm horizontal immersion heater H1 208mm H2 37mm hole distance 68mm hole ø 6mm flange length 84mm flange width 31mm tube ø 8.5mm connection length 27mm		

<b>GEV No.</b>	416996	<b>Ref. No.</b>	004767
<b>description</b>	heating element 2900W 230V heating circuits 1 L 285mm W 76mm H 245mm rectangular flange connection male faston 6.3mm immersion heater H1 208mm H2 37mm hole distance 68mm hole ø 6.2mm flange length 84mm flange width 31mm tube ø 8.5mm		

<b>GEV No.</b>	415377	<b>Ref. No.</b>	006698 059563
<b>description</b>	heating element 5500W 230V heating circuits 1 L 320mm W 86mm H 248mm rectangular flange connection M5 immersion heater W1 19mm W2 48mm H1 213mm H2 38mm hole distance 40mm hole ø 6mm flange length 60mm flange width 30mm tube ø 8.5mm connection length 26mm		

<b>GEV No.</b>	418002	<b>Ref. No.</b>	006571
<b>description</b>	heating element 5500W 400V heating circuits 1 L 320mm W 86mm H 248mm rectangular flange connection M5 immersion heater W1 19mm W2 48mm H1 213mm H2 35mm hole distance 40mm hole ø 6mm flange length 60mm flange width 30mm		

<b>GEV No.</b>	416993	<b>Ref. No.</b>	004752
<b>description</b>	heating element 1500W 230V heating circuits 1 L 320mm W 25mm H 215mm rectangular flange connection male faston 6.3mm immersion heater L1 30mm L2 290mm H1 62mm H2 115mm H3 38mm windings 2 hole distance 18mm hole ø 6mm flange length 33mm flange width 33mm tube ø 8.5mm		

<b>GEV No.</b>	416995	<b>Ref. No.</b>	0A5565
<b>description</b>	heating element 2900W 230V heating circuits 1 L 270mm W 60mm H 248mm rectangular flange connection male faston 6.3mm immersion heater L1 8mm L2 262mm H1 30mm H2 178mm H3 39mm windings 4 hole distance 53mm hole ø 6mm flange length 67mm flange width 32mm tube ø 8.5mm		

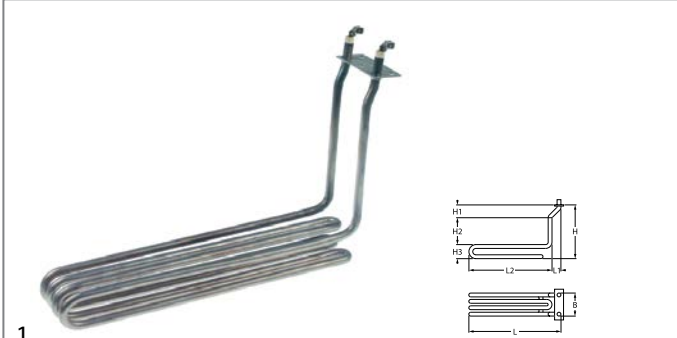

**1**

<b>GEV No.</b>	416994	<b>Ref. No.</b>	005964
<b>description</b>	heating element 2900W 230V heating circuits 1 L 310mm W 60mm H 195mm rectangular flange connection male faston 6.3mm immersion heater L1 5mm L2 305mm H1 30mm H2 125mm H3 40mm windings 4 hole distance 51mm hole ø 6mm flange length 66mm flange width 31mm tube ø 8.5mm		

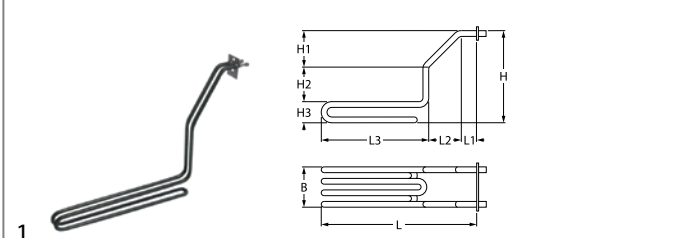

**1**

<b>GEV No.</b>	415354	<b>Ref. No.</b>	058612
<b>description</b>	heating element 1500W 230V heating circuits 1 L 375mm W 26mm H 275mm rectangular flange connection M4 fryer heaters L1 20mm L2 75mm L3 280mm H1 118mm H2 115mm H3 42mm hole distance 22mm hole ø 6mm flange length 33mm flange width 41mm tube ø 8.5mm		

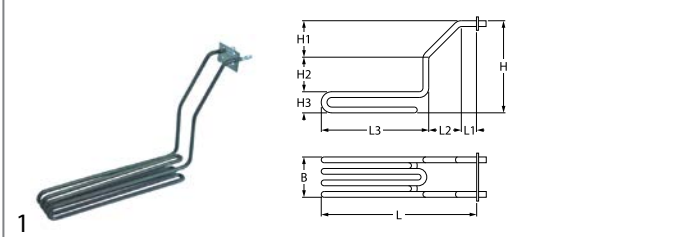



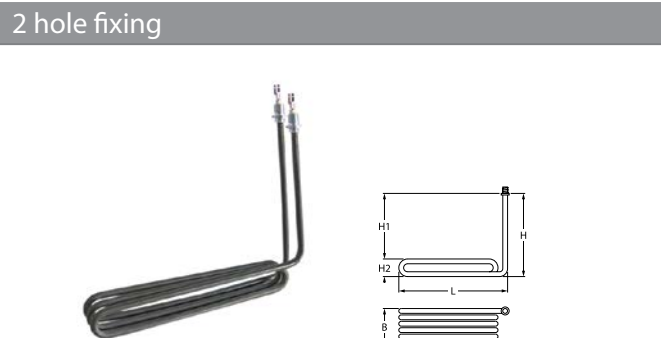

**1**

<b>GEV No.</b>	415274	<b>Ref. No.</b>	058615
<b>description</b>	heating element 3000W 230V heating circuits 1 L 400mm W 70mm H 270mm rectangular flange connection clamp immersion heater L1 20mm L2 65mm L3 315mm H1 120mm H2 110mm H3 40mm hole distance 34mm hole ø 6.3mm flange length 67mm flange width 40mm tube ø 8.5mm		

**2 hole fixing**



**1**

<b>GEV No.</b>	415291	<b>Ref. No.</b>	004926
<b>description</b>	heating element 2000W 230V heating circuits 1 L 250mm W 45mm H 190mm H1 154mm H2 36mm thread 1/4" tube ø 8.5mm mounting distance 30mm windings 3 2 hole fixing connection male faston 6.3mm immersion heater		
<b>spare parts for</b>	415291		
	<b>GEV No.</b>	510417	<b>Ref. No.</b> —
	flat gasket fibre ED ø 20mm ID ø 14mm thickness 2mm Qty 1 pcs		
<b>accessories for</b>	415291		
	<b>GEV No.</b>	361182	<b>Ref. No.</b> —
	nut thread 1/4" H 5mm nickel-plated brass WS 17 Qty 1 pcs		
	<b>GEV No.</b>	520228	<b>Ref. No.</b> —
	tooth lock washer ID ø 15.3mm ED ø 24mm steel Qty 1 pcs for thread M14		
	<b>GEV No.</b>	550262	<b>Ref. No.</b> —
	flat gasket copper ED ø 20mm ID ø 14mm thickness 2mm		

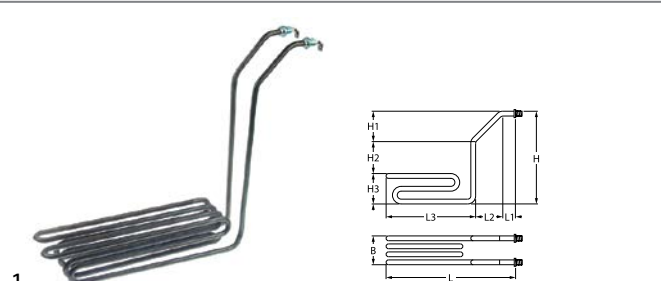

**1**







<b>GEV No.</b>	416997	<b>Ref. No.</b>	052326
<b>description</b>	heating element 4000W 230V heating circuits 1 L 415mm W 95mm H 340mm 2 hole fixing connection M5 immersion heater L1 28mm L2 57mm L3 330mm H1 60mm H2 220mm H3 60mm tube ø 8.5mm thread 1/4"		
<b>accessories for</b>	416997		
	<b>GEV No.</b>	361182	<b>Ref. No.</b> —
	nut thread 1/4" H 5mm nickel-plated brass WS 17 Qty 1 pcs		
	<b>GEV No.</b>	510417	<b>Ref. No.</b> —
	flat gasket fibre ED ø 20mm ID ø 14mm thickness 2mm Qty 1 pcs		
	<b>GEV No.</b>	520228	<b>Ref. No.</b> —
	tooth lock washer ID ø 15.3mm ED ø 24mm steel Qty 1 pcs for thread M14		
	<b>GEV No.</b>	550262	<b>Ref. No.</b> —
	flat gasket copper ED ø 20mm ID ø 14mm thickness 2mm		
	<b>GEV No.</b>	560112	<b>Ref. No.</b> —
	plain washer ID ø 5.3mm ED ø 10mm thickness 1mm SS Qty 20 pcs DIN 125A for thread M5		

Table continues overleaf





accessories for	416997			
	GEV No.	560132	Ref. No.	—
	hexagonal nut thread M5 H 4mm WS 8 SS DIN/ISO DIN 934 / ISO 4032/8673 Qty 20 pcs			

### heating elements for griddles

	1		
GEV No.	415380	Ref. No.	052919
description	heating element 1000W 230V heating circuits 1 L 600mm W 54mm H 82mm tube ø 8.5mm connection M5 connection length 16mm connection distance 46mm dry heating element		

	1		
GEV No.	415079	Ref. No.	053614
description	heating element 1250W 230V heating circuits 1 L 473mm W 52mm H 43mm tube ø 8.5mm griddle connection distance 44mm dry heating element		

	1		
GEV No.	416985	Ref. No.	004649
description	heating element 1250W 230V heating circuits 1 L 482mm W 54mm H 55mm tube ø 8.5mm connection male faston 6.3mm connection distance 46mm dry heating element		

	1		
GEV No.	415290	Ref. No.	004918
description	heating element 1300W 230V heating circuits 1 L 473mm W 80mm H 55mm tube ø 6.5mm connection M4 griddle connection distance 75mm dry heating element		

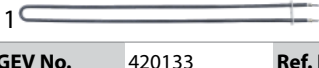
	1		
GEV No.	420133	Ref. No.	0U1489
description	heating element 1400W 240V heating circuits 1 L 610mm W 40mm tube ø 8mm rectangular flange connection M4 flange length 52mm flange width 20mm hole ø 6.5mm connection length 64mm for grill dry heating element		

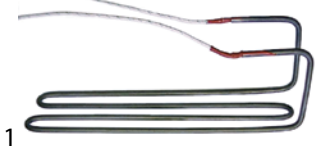
	1		
GEV No.	415099	Ref. No.	0A2208
description	heating element 1500W 220V heating circuits 1 L 380mm W 90mm H 124mm tube ø 8.5mm L1 80mm L2 300mm cable length 1000mm connection distance 68mm dry heating element		

	1		
GEV No.	416986	Ref. No.	004671
description	heating element 1500W 230V heating circuits 1 L 484mm W 90mm H 50mm tube ø 8.5mm connection male faston 6.3mm griddle connection distance 82mm dry heating element		

	1		
GEV No.	415075	Ref. No.	0K9222
description	heating element 2000W 220V heating circuits 1 L 573mm W 80mm H 70mm tube ø 9.2mm connection male faston 6.3mm connection length 21mm griddle dry heating element		

	1		
GEV No.	415382	Ref. No.	055998
description	heating element 2000W 230V heating circuits 1 L 595mm W 41mm H 40mm tube ø 6.3mm connection M5 connection distance 94mm dry heating element		

	1		
GEV No.	415098	Ref. No.	0A2247
description	heating element 2250W 220V heating circuits 1 L 533mm W 75mm H 123mm tube ø 14mm L1 78mm L2 456mm connection cable cable length 2000mm dry heating element		

	1		
GEV No.	420132	Ref. No.	006682
description	heating element 2500W 230V heating circuits 1 L 570mm W 90mm H 90mm tube ø 8.6mm connection M5 for griddle connection distance 81.4mm dry heating element		

	1		
GEV No.	416987	Ref. No.	006681
description	heating element 2500W 400V heating circuits 1 L 567mm W 90mm H 91mm tube ø 9mm connection M5 connection length 24mm connection distance 81mm dry heating element		

### heating elements for refrigeration

#### heating elements for defrosting

	1		
GEV No.	419025	Ref. No.	083530
description	heating element 400W 230V L 440mm W 70mm H 100mm cable length 500mm tube ø 8.5mm		

#### heating elements for condensate evaporation

	1		
GEV No.	418996	Ref. No.	0A8134
description	heating element 95W 220V L 435mm W 56mm H 28mm cable length 3000mm tube ø 6.25mm		



## heating elements for tilting bratt pan



1

<b>GEV No.</b>	415273	<b>Ref. No.</b>	058345
<b>description</b>	heating element 1500W 220V L 373mm W 82mm H 78mm connection M5 dry heating element heating circuits 1 tube ø 8.5mm with holder connection distance 80mm		



1

<b>GEV No.</b>	418016	<b>Ref. No.</b>	002559
<b>description</b>	heating element 1500W 230V L 375mm W 76mm H 75mm connection M5 dry heating element heating circuits 1 tube ø 8.5mm connection distance 68mm		



1

<b>GEV No.</b>	418004	<b>Ref. No.</b>	051356
<b>description</b>	heating element 1500W 230V L 530mm H 100mm dry heating element tube ø 14.5mm L1 60mm L2 535mm W1 35mm W2 80mm cable length 1000mm		



1

<b>GEV No.</b>	415098	<b>Ref. No.</b>	0A2247
<b>description</b>	heating element 2250W 220V heating circuits 1 L 533mm W 75mm H 123mm tube ø 14mm L1 78mm L2 456mm connection cable cable length 2000mm dry heating element		

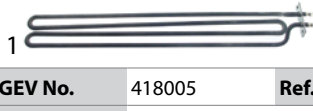

1

<b>GEV No.</b>	418005	<b>Ref. No.</b>	0C0685
<b>description</b>	heating element 2500W 400V L 545mm W 80mm H 48mm connection M4 dry heating element heating circuits 1 tube ø 8.5mm L1 25mm L2 520mm W1 23mm W2 34mm rectangular flange hole distance 56mm flange length 70mm flange width 22mm hole ø 5.5mm		



1

<b>GEV No.</b>	418003	<b>Ref. No.</b>	004469
<b>description</b>	heating element 3000W 230V L 137mm W 515mm H 48mm connection male faston 6.3mm dry heating element heating circuits 1 tube ø 8.5mm W1 242mm W2 31mm rectangular flange hole distance 57mm flange length 70mm flange width 22mm hole ø 5mm connection length 97mm		

**accessories for** 418003

<b>GEV No.</b>	510368	<b>Ref. No.</b>	—
<b>description</b>	gasket L 70mm W 23.5mm hole ø 5mm hole distance 56mm FIBER thickness 2mm for heating element		



1

<b>GEV No.</b>	420131	<b>Ref. No.</b>	0C2613
<b>description</b>	heating element 3500W 230V L 145mm W 623mm H 50mm connection M4 for tilting bratt pan heating circuits 1 tube ø 8.5mm W1 295mm W2 33mm rectangular flange hole distance 57mm flange length 70mm flange width 22mm hole ø 5mm connection length 100mm		



1

<b>GEV No.</b>	415381	<b>Ref. No.</b>	051355
<b>description</b>	heating element for tilting bratt pan 1300W 220V L 535mm W 82mm H 100mm connection cable dry heating element heating circuits 1 tube ø 14mm L1 55mm W1 11mm W2 60mm cable length 1000mm connection distance 50mm		

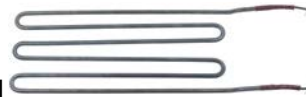

1

<b>GEV No.</b>	420128	<b>Ref. No.</b>	0K4745
<b>description</b>	heating element for tilting bratt pan 3000W 230V L 500mm W 165mm H 48mm connection cable dry heating element heating circuits 1 tube ø 8.5mm L1 55mm L2 20mm L3 425mm cable length 1000mm connection distance 156.5mm		

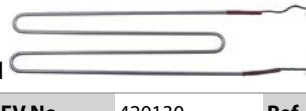

1

<b>GEV No.</b>	420130	<b>Ref. No.</b>	0K4749
<b>description</b>	heating element for tilting bratt pan 3000W 230V L 590mm W 170mm H 45mm connection cable dry heating element heating circuits 1 tube ø 8.3mm L1 55mm L2 20mm L3 515mm cable length 1000mm connection distance 162mm		



1

<b>GEV No.</b>	415747	<b>Ref. No.</b>	0K4792
<b>description</b>	heating element tilting bratt pan 2500W 230V L 518mm W 95mm dry heating element heating circuits 1 tube ø 8.5mm cable length 215mm connection distance 87mm		



heating elements for pasta cookers

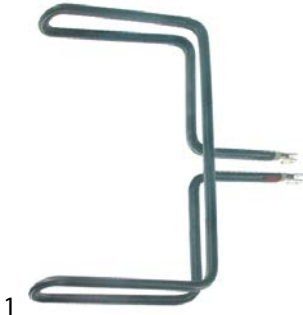

1

<b>GEV No.</b>	416981	<b>Ref. No.</b>	0A5492
<b>description</b>	heating element 1000W 230V heating circuits 1 L 245mm W 290mm H 40mm connection male faston 6.3mm tube ø 8.5mm L1 92mm L2 153mm W1 125mm W2 33mm connection distance 25mm dry heating element		



1

<b>GEV No.</b>	420127	<b>Ref. No.</b>	0K5116
<b>description</b>	heating element 1400W 230V heating circuits 1 L 530mm W 58mm rectangular flange connection M5 tube ø 6.2mm flange width 28mm L1 75mm L2 40mm L3 415mm W1 33mm W2 25mm hole distance 25mm flange length 60mm hole ø 6mm mounting distance 19mm connection length 28mm dry heating element		



1

<b>GEV No.</b>	415691	<b>Ref. No.</b>	056906
<b>description</b>	heating element 1450W 220V heating circuits 1 L 507mm W 58mm Hmm rectangular flange connection M5 tube ø 6.3mm flange width 28mm W1 25mm W2 33mm hole distance 25mm flange length 60mm hole ø 6.3mm connection length 30mm dry heating element		



1

<b>GEV No.</b>	416979	<b>Ref. No.</b>	059066
<b>description</b>	heating element 1550W 230V heating circuits 1 L 530mm W 55mm rectangular flange connection M5 tube ø 6.8mm flange width 28mm hole distance 26mm flange length 60mm hole ø 5mm connection length 80mm pasta cooker dry heating element		



1

<b>GEV No.</b>	416629	<b>Ref. No.</b>	005816
<b>description</b>	heating element 1600W 230V heating circuits 1 L 368mm W 70mm H 178mm connection M4 tube ø 9mm connection length 24mm dry heating element		





1

<b>GEV No.</b>	416980	<b>Ref. No.</b>	006853
<b>description</b>	heating element 1650W 230V heating circuits 1 L 500mm W 54mm Hmm rectangular flange connection M4 tube ø 8.5mm flange width 30mm L1 110mm L2 395mm W1 50mm W2 10mm hole distance 40mm flange length 60mm hole ø 6mm connection length 15mm dry heating element		



1

<b>GEV No.</b>	415597	<b>Ref. No.</b>	0C5347
<b>description</b>	heating element 3000W 230V heating circuits 3 L 255mm W 38mm H 26mm 3 hole flange connection male faston tube ø 6.3mm thermostat sleeves ø 7.5mm length thermostat sleeves 199mm hole distance 63mm mounting ø 47.5mm hole ø 8/10mm connection length 15mm immersion heater		
<b>accessories for</b>	415597		
		<b>GEV No.</b> 510408	<b>Ref. No.</b> 067620
		O-ring EPDM thickness 5.34mm ID ø 47mm Qty 1 pcs	
		<b>GEV No.</b> 510562	<b>Ref. No.</b> —
		O-ring silicone thickness 5.34mm ID ø 47mm Qty 1 pcs	

heating elements for pizza ovens

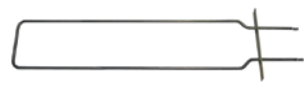

1

<b>GEV No.</b>	415678	<b>Ref. No.</b>	004151
<b>description</b>	heating element 1000W 230V L 575mm W 160mm flange length 220mm flange width 31mm hole distance 201mm connection length 133mm connection M5 L1 30mm L2 25mm L3 520mm W1 25mm W2 112mm tube ø 10mm heating circuits 1 rectangular flange hole ø 4mm dry heating element		



1

<b>GEV No.</b>	415917	<b>Ref. No.</b>	004152
<b>description</b>	heating element 1400W 230V L 572mm W 159mm flange length 220mm flange width 32mm hole distance 199mm connection length 134mm connection M5 L1 30mm L2 27mm L3 515mm W1 25mm W2 110mm tube ø 10.2mm heating circuits 1 rectangular flange hole ø 4mm dry heating element		



1

<b>GEV No.</b>	415919	<b>Ref. No.</b>	004154
<b>description</b>	heating element 2000W 230V L 870mm W 160mm flange length 220mm flange width 31mm hole distance 200mm connection length 130mm connection 5 L3 820mm W1 110mm W2 160mm tube ø 10mm heating circuits 1 rectangular flange hole ø 4mm dry heating element		





1





<b>GEV No.</b>	419090	<b>Ref. No.</b>	0K7632
<b>description</b>	heating element 1670W 230V L 440mm W 144mm tube ø 8.5mm heating circuits 1 dry heating element		





## heating elements for chargrills

			
1			
<b>GEV No.</b>	415376	<b>Ref. No.</b>	002403
<b>description</b>	heating element 1800W 230V L 615mm W 88mm H 23mm hole distance 40mm windings 2 flange length 60mm flange width 30mm connection male faston 6.3mm heating circuits 1 tube ø 8.5mm hole ø 6.5mm rectangular flange dry heating element		

			
1			
<b>GEV No.</b>	416978	<b>Ref. No.</b>	0C0495
<b>description</b>	heating element 2500W 400V L 625mm W 90mm H 40mm W1 20mm W2 48.5mm L1 15mm flange length 60mm flange width 30mm hole distance 40mm connection M5 heating circuits 1 tube ø 8.5mm connection length 54mm hole ø 6mm rectangular flange dry heating element		

			
1			
<b>GEV No.</b>	415288	<b>Ref. No.</b>	004907
<b>description</b>	heating element 1350W 230V L 396mm W 80mm H 37mm thread 1/4" mounting distance 72mm tube ø 6.3mm connection M4 heating circuits 1 2 hole fixing dry heating element		
<b>accessories for</b>	415288		
	<b>GEV No.</b>	361182	<b>Ref. No.</b> —
	nut thread 1/4" H 5mm nickel-plated brass WS 17 Qty 1 pcs		
	<b>GEV No.</b>	510417	<b>Ref. No.</b> —
	flat gasket fibre ED ø 20mm ID ø 14mm thickness 2mm Qty 1 pcs		
	<b>GEV No.</b>	520228	<b>Ref. No.</b> —
	tooth lock washer ID ø 15.3mm ED ø 24mm steel Qty 1 pcs for thread M14		
	<b>GEV No.</b>	550262	<b>Ref. No.</b> —
	flat gasket copper ED ø 20mm ID ø 14mm thickness 2mm		

			
1			
<b>GEV No.</b>	415352	<b>Ref. No.</b>	053613
<b>description</b>	heating element 2750W 240V L 480mm W 125mm H 41mm L1 70mm L2 40mm L3 370mm W1 23mm W2 79mm connection M4 connection distance 72mm tube ø 8.5mm heating circuits 1 dry heating element		

			
1			
<b>GEV No.</b>	420138	<b>Ref. No.</b>	053451
<b>description</b>	heating element 3000W 230V L 480mm W 125mm H 41mm L1 70mm L2 40mm L3 370mm W1 23mm W2 79mm connection M4 connection distance 72mm tube ø 8.5mm heating circuits 1 dry heating element		

## heating elements for salamanders/toast-

			
1			
<b>GEV No.</b>	420271	<b>Ref. No.</b>	003014
<b>description</b>	heating element 1000W 230V L 215mm W 95mm L1 25mm L2 25mm L3 165mm W1 16mm W2 63mm hole distance 96mm connection M4 tube ø 8.5mm flange length 106mm flange width 32mm heating circuits 1 hole ø 5mm tilt flange dry heating element H 8.5mm		

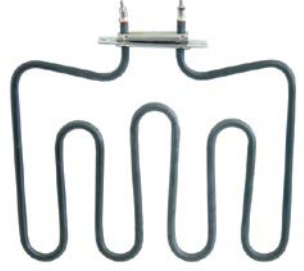
			
1			
<b>GEV No.</b>	416653	<b>Ref. No.</b>	003016
<b>description</b>	heating element 2000W 230V L 225mm W 283mm L1 15mm L2 210mm W1 110mm W2 63mm hole distance 96mm connection M4 tube ø 8.5mm flange length 106mm flange width 32mm heating circuits 1 hole ø 5mm tilt flange dry heating element H 8.5mm		

			
1			
<b>GEV No.</b>	416654	<b>Ref. No.</b>	003012 TI3706
<b>description</b>	heating element 2000W 230V L 230mm W 230mm L1 22mm L2 208mm W1 83mm W2 63mm hole distance 96mm tube ø 8.5mm flange length 106mm flange width 32mm heating circuits 1 hole ø 5mm tilt flange dry heating element H 8.5mm		

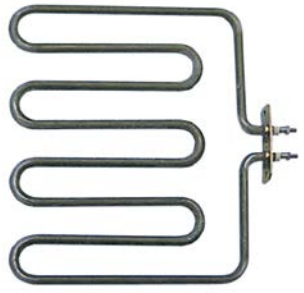
			
1			
<b>GEV No.</b>	415622	<b>Ref. No.</b>	0KD843
<b>description</b>	heating element 2000W 230V heating circuits 1 L 229mm W 255mm L1 17mm L2 212mm W1 112mm W2 32mm flange length 70mm flange width 23mm hole distance 25mm tube ø 8.5mm connection length 20mm dry heating element connection M4 rectangular flange hole ø 5mm H 8.5mm		

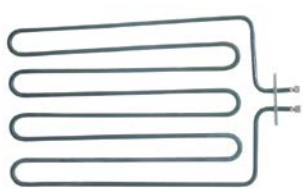
1

<b>GEV No.</b>	416581	<b>Ref. No.</b>	052836
<b>description</b>	heating element 3000W 230V heating circuits 1 L 357mm W 226mm L1 20mm L2 337mm W1 98mm W2 30mm flange length 70mm flange width 22mm hole distance 57mm tube ø 6.3mm dry heating element connection M5 rectangular flange hole ø 6mm H 6.3mm		



1

<b>GEV No.</b>	420126	<b>Ref. No.</b>	OK4778
<b>description</b>	heating element 2100W 230V heating circuits 1 L 260mm W 220mm H 22mm thread M12x1 connection length 212mm tube ø 8.3mm connection M5 dry heating element for salamander grill		

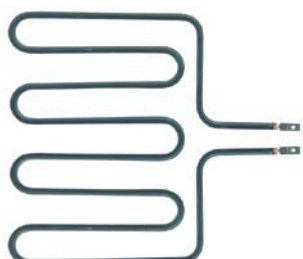

1

<b>GEV No.</b>	416579	<b>Ref. No.</b>	056783
<b>description</b>	heating element 1900W 220V heating circuits 1 L 245mm W 240mm L1 63mm L2 182mm W1 98mm W2 45mm connection distance 16mm connection M4 dry heating element tube ø 6.3mm H 6.3mm		

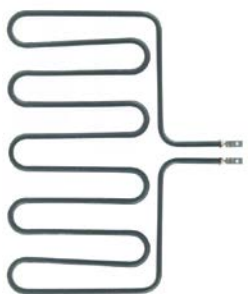

1

<b>GEV No.</b>	416580	<b>Ref. No.</b>	056782
<b>description</b>	heating element 2000W 220V heating circuits 1 L 240mm W 333mm L1 60mm L2 180mm W1 149mm W2 35mm connection distance 29mm connection M4 dry heating element tube ø 6.3mm H 6.3mm		

heating elements for heated trolleys

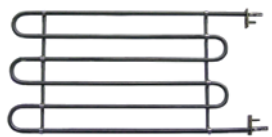

1

<b>GEV No.</b>	415596	<b>Ref. No.</b>	0G2290
<b>description</b>	heating element 1500W 230V heating circuits 1 L 395mm W 198mm tube ø 6.5mm lug length 31mm lug width 16mm connection length 30mm connection male faston 6.3mm dry heating element bracket mounting hole distance 160mm mounting thread M4		

heating cartridges



1



<b>GEV No.</b>	417227	<b>Ref. No.</b>	083814
<b>description</b>	heating cartridge 90W 230V ø 12mm L 124mm thread 3/8" cable length 4000mm Hmm Wmm condensate evaporation		

ceramic heaters

245x60mm



1

<b>GEV No.</b>	415104	<b>Ref. No.</b>	0A2843	
<b>description</b>	ceramic emitter 1000W 230V cable beaded cord L 245mm W 60mm H 35mm			
<b>spare parts for</b>	415104			
	<b>GEV No.</b>	415109	<b>Ref. No.</b>	—
	spring clip			
<b>accessories for</b>	415104			
	<b>GEV No.</b>	415110	<b>Ref. No.</b>	—
	reflector L 245mm W 95mm H 31mm thickness 0.75mm hole ø 15x40mm			



1



<b>GEV No.</b>	415103	<b>Ref. No.</b>	004898	
<b>description</b>	ceramic emitter 650W 230V cable beaded cord L 245mm W 60mm H 35mm			
<b>spare parts for</b>	415103			
	<b>GEV No.</b>	415109	<b>Ref. No.</b>	—
	spring clip			

Table continues overleaf



<b>accessories for</b>	415103			
	<b>GEV No.</b>	415110	<b>Ref. No.</b>	—
	reflector L 245mm W 95mm H 31mm thickness 0.75mm hole $\varnothing$ 15x40mm			

## immersion heating elements

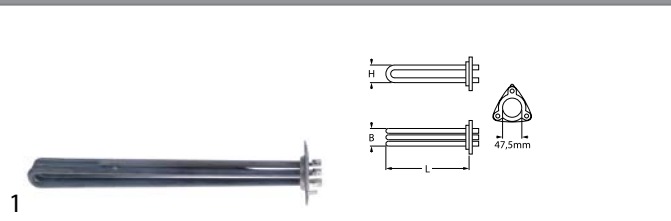
3 hole flange  $\varnothing$ 47.5mm

<b>GEV No.</b>	418683	<b>Ref. No.</b>	0L1852
----------------	--------	-----------------	--------

**description** heating element 10500W 230V heating circuits 3 L 390mm W 35mm H 35mm number of thermostat sleeves 1 thermostat sleeves  $\varnothing$  8.5mm length thermostat sleeves 270mm tube  $\varnothing$  8.5mm hole distance 62mm hole  $\varnothing$  6.5mm

**spare parts for** 418683

	<b>GEV No.</b>	510408	<b>Ref. No.</b>	067620
	O-ring EPDM thickness 5.34mm ID $\varnothing$ 47mm Qty 1 pcs			

**accessories for** 418683

	<b>GEV No.</b>	510562	<b>Ref. No.</b>	—
	O-ring silicone thickness 5.34mm ID $\varnothing$ 47mm Qty 1 pcs			

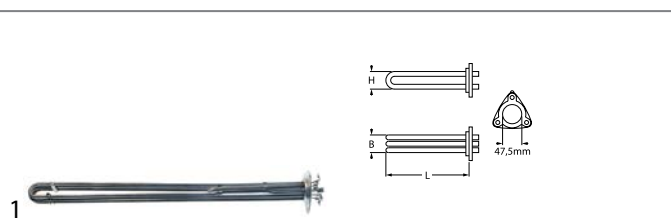

<b>GEV No.</b>	418017	<b>Ref. No.</b>	0C0715
----------------	--------	-----------------	--------

**description** heating element 10750W 230V mounting  $\varnothing$  47.5mm heating circuits 3 L 542mm W 35mm H 26mm number of thermostat sleeves 1 thermostat sleeves  $\varnothing$  8mm length thermostat sleeves 180mm thermostat sleeve not clinging tube  $\varnothing$  6.3mm hole distance 62mm hole  $\varnothing$  6mm connection M5 3 hole flange immersion heater

**accessories for** 418017

	<b>GEV No.</b>	510408	<b>Ref. No.</b>	067620
	O-ring EPDM thickness 5.34mm ID $\varnothing$ 47mm Qty 1 pcs			

**accessories for** 418017

	<b>GEV No.</b>	510562	<b>Ref. No.</b>	—
	O-ring silicone thickness 5.34mm ID $\varnothing$ 47mm Qty 1 pcs			

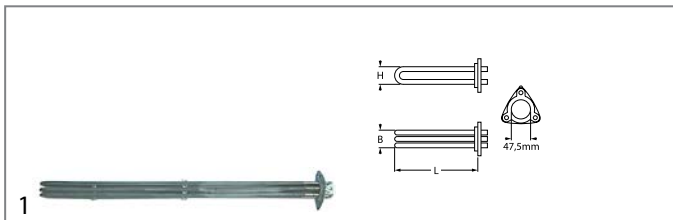

<b>GEV No.</b>	415063	<b>Ref. No.</b>	0C5336 0K8360
----------------	--------	-----------------	------------------

**description** heating element 17000W 230V mounting  $\varnothing$  47.5mm heating circuits 3 L 590mm W 29mm H 38mm number of thermostat sleeves 1 thermostat sleeves  $\varnothing$  4mm length thermostat sleeves 225mm thermostat sleeve centre tube  $\varnothing$  8.5mm hole distance 63mm hole  $\varnothing$  10mm connection M5 3 hole flange immersion heater

**accessories for** 415063

	<b>GEV No.</b>	510408	<b>Ref. No.</b>	067620
	O-ring EPDM thickness 5.34mm ID $\varnothing$ 47mm Qty 1 pcs			

	<b>GEV No.</b>	510562	<b>Ref. No.</b>	—
	O-ring silicone thickness 5.34mm ID $\varnothing$ 47mm Qty 1 pcs			

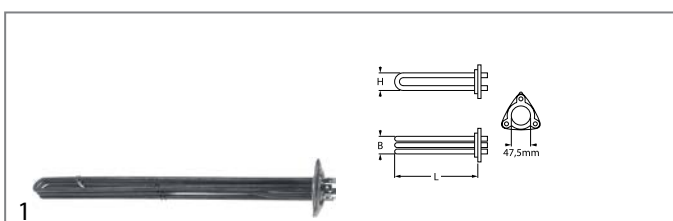

<b>GEV No.</b>	419084	<b>Ref. No.</b>	059003 214040
----------------	--------	-----------------	------------------

**description** heating element 17000W 240V mounting  $\varnothing$  47.5mm heating circuits 3 L 590mm W 32mm H 40mm number of thermostat sleeves 1 thermostat sleeves  $\varnothing$  5mm length thermostat sleeves 225mm thermostat sleeve centred, adjacent tube  $\varnothing$  8.5mm hole distance 62.5mm hole  $\varnothing$  6.5mm connection M5 3 hole flange immersion heater

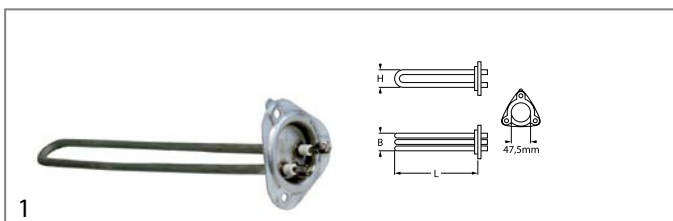

<b>GEV No.</b>	416130	<b>Ref. No.</b>	049371
----------------	--------	-----------------	--------



**description** heating element 2800W 230V mounting  $\varnothing$  47.5mm heating circuits 1 L 310mm W 8.5mm H 39mm tube  $\varnothing$  8.5mm hole distance 63mm hole  $\varnothing$  6mm connection male faston 6.3mm 3 hole flange immersion heater

**accessories for** 416130

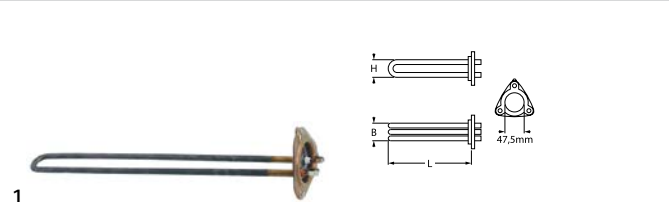

	<b>GEV No.</b>	510408	<b>Ref. No.</b>	067620
	O-ring EPDM thickness 5.34mm ID $\varnothing$ 47mm Qty 1 pcs			

	<b>GEV No.</b>	510562	<b>Ref. No.</b>	—
	O-ring silicone thickness 5.34mm ID $\varnothing$ 47mm Qty 1 pcs			



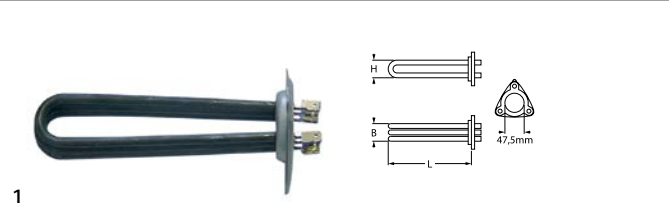



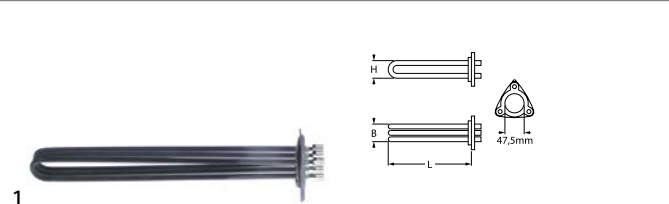

<b>GEV No.</b>	416135	<b>Ref. No.</b>	049980
<b>description</b>	heating element 2800W 230V mounting $\varnothing$ 47.5mm heating circuits 1 L 375mm W 8.5mm H 40mm tube $\varnothing$ 8.5mm hole distance 62.5mm hole $\varnothing$ 6.5mm connection male faston 6.3mm 3 hole flange immersion heater		
<b>spare parts for</b>	416135		
	<b>GEV No.</b>	510408	<b>Ref. No.</b> 067620
	O-ring EPDM thickness 5.34mm ID $\varnothing$ 47mm Qty 1 pcs		
<b>accessories for</b>	416135		
	<b>GEV No.</b>	510408	<b>Ref. No.</b> 067620
	O-ring EPDM thickness 5.34mm ID $\varnothing$ 47mm Qty 1 pcs		
	<b>GEV No.</b>	510562	<b>Ref. No.</b> —
	O-ring silicone thickness 5.34mm ID $\varnothing$ 47mm Qty 1 pcs		





<b>GEV No.</b>	415174	<b>Ref. No.</b>	0L1634
<b>description</b>	heating element 3000W 230V mounting $\varnothing$ 47.5mm heating circuits 3 L 160mm W 33mm H 39mm tube $\varnothing$ 6.3mm hole distance 65mm hole $\varnothing$ 8mm connection length 39mm connection male faston 6.3mm 3 hole flange immersion heater		
<b>spare parts for</b>	415174		
	<b>GEV No.</b>	510408	<b>Ref. No.</b> 067620
	O-ring EPDM thickness 5.34mm ID $\varnothing$ 47mm Qty 1 pcs		
<b>accessories for</b>	415174		
	<b>GEV No.</b>	510408	<b>Ref. No.</b> 067620
	O-ring EPDM thickness 5.34mm ID $\varnothing$ 47mm Qty 1 pcs		
	<b>GEV No.</b>	521012	<b>Ref. No.</b> —
	gasket graphite ED $\varnothing$ 15mm ID $\varnothing$ 5mm thickness 1.2mm Qty 1 pcs		



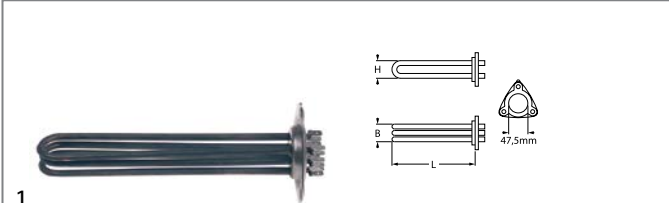

<b>GEV No.</b>	415069	<b>Ref. No.</b>	0L1875
<b>description</b>	heating element 4500W 220V mounting $\varnothing$ 47.5mm heating circuits 3 L 310mm W 30.5mm H 29mm tube $\varnothing$ 6.3mm connection male faston 6.3mm 3 hole flange immersion heater		
<b>accessories for</b>	415069		
	<b>GEV No.</b>	510408	<b>Ref. No.</b> 067620
	O-ring EPDM thickness 5.34mm ID $\varnothing$ 47mm Qty 1 pcs		

<b>accessories for</b>	415069		
	<b>GEV No.</b>	520235	<b>Ref. No.</b> —
	3 hole flange hole distance 70.5mm perforation $\varnothing$ 6.5mm ID $\varnothing$ 53.5mm		
	<b>GEV No.</b>	520236	<b>Ref. No.</b> 003362
	flange for heating element ID $\varnothing$ 50mm ED $\varnothing$ 90mm hole $\varnothing$ 6.5mm 3 holes		
	<b>GEV No.</b>	521012	<b>Ref. No.</b> —
	gasket graphite ED $\varnothing$ 15mm ID $\varnothing$ 5mm thickness 1.2mm Qty 1 pcs		
	<b>GEV No.</b>	550002	<b>Ref. No.</b> —
	tension strap H 10mm L 21mm W 10mm hole $\varnothing$ 6.5mm for heating element		
	<b>GEV No.</b>	550362	<b>Ref. No.</b> —
	blind flange $\varnothing$ 64mm mounting $\varnothing$ 47.5mm		



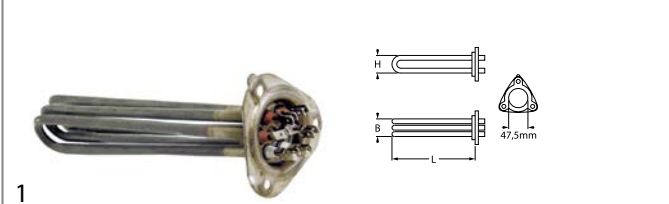

<b>GEV No.</b>	415067	<b>Ref. No.</b>	048928
<b>description</b>	heating element 4500W 230V mounting $\varnothing$ 47.5mm heating circuits 3 L 218mm W 34mm H 29mm tube $\varnothing$ 6.3mm hole $\varnothing$ 8x10mm connection male faston 6.3mm 3 hole flange immersion heater		
<b>spare parts for</b>	415067		
	<b>GEV No.</b>	510408	<b>Ref. No.</b> 067620
	O-ring EPDM thickness 5.34mm ID $\varnothing$ 47mm Qty 1 pcs		



<b>GEV No.</b>	416128	<b>Ref. No.</b>	048284 049955 0L2129
<b>description</b>	heating element 4500W 230V mounting $\varnothing$ 47.5mm heating circuits 3 L 265mm W 30mm H 35mm tube $\varnothing$ 8.5mm hole distance 60mm hole $\varnothing$ 10mm connection male faston 6.3mm 3 hole flange immersion heater		
<b>accessories for</b>	416128		
	<b>GEV No.</b>	510408	<b>Ref. No.</b> 067620
	O-ring EPDM thickness 5.34mm ID $\varnothing$ 47mm Qty 1 pcs		
	<b>GEV No.</b>	510562	<b>Ref. No.</b> —
	O-ring silicone thickness 5.34mm ID $\varnothing$ 47mm Qty 1 pcs		





**1**

<b>GEV No.</b>	415066	<b>Ref. No.</b>	0L1849
<b>description</b>	heating element 4500W 230V mounting $\varnothing$ 47.5mm heating circuits 3 L 310mm W 30mm H 36mm number of thermostat sleeves 1 thermostat sleeves $\varnothing$ 7mm length thermostat sleeves 185mm thermostat sleeve eccentric, clinging tube $\varnothing$ 6.3mm hole distance 64mm hole $\varnothing$ 10mm connection male faston 6.3mm 3 hole flange immersion heater		
<b>spare parts for</b>	415066		
	GEV No.	510408	Ref. No. 067620
	O-ring EPDM thickness 5.34mm ID $\varnothing$ 47mm Qty 1 pcs		
<b>accessories for</b>	415066		
	GEV No.	510408	Ref. No. 067620
	O-ring EPDM thickness 5.34mm ID $\varnothing$ 47mm Qty 1 pcs		
	GEV No.	510562	Ref. No. —
	O-ring silicone thickness 5.34mm ID $\varnothing$ 47mm Qty 1 pcs		



**1**

<b>GEV No.</b>	418189	<b>Ref. No.</b>	002524
<b>description</b>	heating element 4700W 230V mounting $\varnothing$ 47.5mm heating circuits 3 L 393mm W 40mm H 35mm number of thermostat sleeves 1 thermostat sleeves $\varnothing$ 7mm length thermostat sleeves 275mm thermostat sleeve eccentric, clinging tube $\varnothing$ 6.3mm hole distance 68mm hole $\varnothing$ 8/10mm connection male faston 6.3mm 3 hole flange immersion heater		
<b>spare parts for</b>	418189		
	GEV No.	510408	Ref. No. 067620
	O-ring EPDM thickness 5.34mm ID $\varnothing$ 47mm Qty 1 pcs		
<b>accessories for</b>	418189		
	GEV No.	510562	Ref. No. —
	O-ring silicone thickness 5.34mm ID $\varnothing$ 47mm Qty 1 pcs		



**1**

<b>GEV No.</b>	415080	<b>Ref. No.</b>	0L1878
<b>description</b>	heating element 6000W 220V mounting $\varnothing$ 47.5mm heating circuits 3 L 310mm W 35mm H 40mm number of thermostat sleeves 1 thermostat sleeves $\varnothing$ 7mm length thermostat sleeves 180mm thermostat sleeve clinging tube $\varnothing$ 6.3mm hole distance 63mm hole $\varnothing$ 8mm connection length 28mm connection male faston 6.3mm 3 hole flange immersion heater		
<b>spare parts for</b>	415080		
	GEV No.	510408	Ref. No. 067620
	O-ring EPDM thickness 5.34mm ID $\varnothing$ 47mm Qty 1 pcs		

**accessories for** 415080

	GEV No.	510408	Ref. No.	067620
	O-ring EPDM thickness 5.34mm ID $\varnothing$ 47mm Qty 1 pcs			





**1**

<b>GEV No.</b>	420081	<b>Ref. No.</b>	049455
<b>description</b>	heating element 6000W 230V mounting $\varnothing$ 47.5mm heating circuits 3 L 260mm W 27mm H 37mm number of thermostat sleeves 1 thermostat sleeves $\varnothing$ 7.2mm length thermostat sleeves 170mm tube $\varnothing$ 6.2mm hole distance 62.5mm hole $\varnothing$ 6.5mm connection male faston 6.3mm 3 hole flange immersion heater		





**1**

<b>GEV No.</b>	415068	<b>Ref. No.</b>	048513
<b>description</b>	heating element 6000W 230V mounting $\varnothing$ 47.5mm heating circuits 3 L 370mm W 32mm H 36mm thermostat sleeves $\varnothing$ 7mm length thermostat sleeves 165mm thermostat sleeve eccentric, non clinging tube $\varnothing$ 8.5mm hole distance 62mm hole $\varnothing$ 8mm connection male faston 6.3mm 3 hole flange immersion heater		
<b>spare parts for</b>	415068		
	GEV No.	510408	Ref. No. 067620
	O-ring EPDM thickness 5.34mm ID $\varnothing$ 47mm Qty 1 pcs		



**1**

<b>GEV No.</b>	415379	<b>Ref. No.</b>	0L1877
<b>description</b>	heating element 6000W 230V mounting $\varnothing$ 47.5mm heating circuits 3 L 479mm W 36mm H 33mm number of thermostat sleeves 1 thermostat sleeves $\varnothing$ 7mm length thermostat sleeves 270mm thermostat sleeve eccentric, clinging tube $\varnothing$ 6.3mm hole distance 62mm hole $\varnothing$ 8mm connection male faston 6.3mm 3 hole flange immersion heater		
<b>spare parts for</b>	415379		
	GEV No.	510408	Ref. No. 067620
	O-ring EPDM thickness 5.34mm ID $\varnothing$ 47mm Qty 1 pcs		
<b>accessories for</b>	415379		
	GEV No.	521012	Ref. No. —
	gasket graphite ED $\varnothing$ 15mm ID $\varnothing$ 5mm thickness 1.2mm Qty 1 pcs		



**1**

<b>GEV No.</b>	418126	<b>Ref. No.</b>	059665
<b>description</b>	heating element 7500W 220V mounting $\varnothing$ 47.5mm heating circuits 3 L 550mm W 37mm H 37mm number of thermostat sleeves 1 thermostat sleeves $\varnothing$ 7mm length thermostat sleeves 185mm thermostat sleeve upper tube $\varnothing$ 6.5mm hole distance 6.5mm hole $\varnothing$ 10mm connection male faston 6.3mm 3 hole flange immersion heater		
<b>spare parts for</b>	418126		
	<b>GEV No.</b>	<b>Ref. No.</b>	067620
	510408		
	O-ring EPDM thickness 5.34mm ID $\varnothing$ 47mm Qty 1 pcs		
<b>accessories for</b>	418126		
	<b>GEV No.</b>	<b>Ref. No.</b>	—
	510562		
	O-ring silicone thickness 5.34mm ID $\varnothing$ 47mm Qty 1 pcs		

**1**

<b>GEV No.</b>	415668	<b>Ref. No.</b>	0K3789
<b>description</b>	heating element 2625W 230V mounting $\varnothing$ 47.5mm heating circuits 1 L 190mm W 41mm H 54mm number of thermostat sleeves 1 thermostat sleeves $\varnothing$ 7mm length thermostat sleeves 170mm thermostat sleeve eccentric, non clinging tube $\varnothing$ 6.3mm hole distance 62mm hole $\varnothing$ 8mm connection M4 3 hole flange immersion heater		
<b>spare parts for</b>	415668		
	<b>GEV No.</b>	<b>Ref. No.</b>	067620
	510408		
	O-ring EPDM thickness 5.34mm ID $\varnothing$ 47mm Qty 1 pcs		
<b>accessories for</b>	415668		
	<b>GEV No.</b>	<b>Ref. No.</b>	—
	510562		
	O-ring silicone thickness 5.34mm ID $\varnothing$ 47mm Qty 1 pcs		

**1**

<b>GEV No.</b>	415394	<b>Ref. No.</b>	058666
<b>description</b>	heating element 7900W 230V mounting $\varnothing$ 47.5mm heating circuits 3 L 287mm W 33mm H 35mm tube $\varnothing$ 8.5mm hole distance 63mm hole $\varnothing$ 8mm connection M5 3 hole flange immersion heater		
<b>accessories for</b>	415394		
	<b>GEV No.</b>	<b>Ref. No.</b>	067620
	510408		
	O-ring EPDM thickness 5.34mm ID $\varnothing$ 47mm Qty 1 pcs		
	<b>GEV No.</b>	<b>Ref. No.</b>	—
	510562		
	O-ring silicone thickness 5.34mm ID $\varnothing$ 47mm Qty 1 pcs		

**1**

<b>GEV No.</b>	415002	<b>Ref. No.</b>	069455
<b>description</b>	heating element 3000W 230V mounting $\varnothing$ 47.5mm heating circuits 1 L 198mm W 35mm H 44mm number of thermostat sleeves 1 thermostat sleeves $\varnothing$ 7mm length thermostat sleeves 175mm thermostat sleeve not clinging tube $\varnothing$ 6.3mm hole distance 64mm hole $\varnothing$ 8mm connection M4 3 hole flange immersion heater		
<b>accessories for</b>	415002		
	<b>GEV No.</b>	<b>Ref. No.</b>	067620
	510408		
	O-ring EPDM thickness 5.34mm ID $\varnothing$ 47mm Qty 1 pcs		
	<b>GEV No.</b>	<b>Ref. No.</b>	—
	510562		
	O-ring silicone thickness 5.34mm ID $\varnothing$ 47mm Qty 1 pcs		
	<b>GEV No.</b>	<b>Ref. No.</b>	—
	521103		
	nut thread M4 H 3mm WS 7 brass Qty 20 pcs		
	<b>GEV No.</b>	<b>Ref. No.</b>	—
	521104		
	washer ID $\varnothing$ 4.3mm ED $\varnothing$ 8mm thickness 0.5mm brass Qty 20 pcs for thread M4		
	<b>GEV No.</b>	<b>Ref. No.</b>	—
	560111		
	plain washer ID $\varnothing$ 4.3mm ED $\varnothing$ 9mm thickness 0.8mm SS Qty 20 pcs DIN 125A for thread M4		
	<b>GEV No.</b>	<b>Ref. No.</b>	—
	560131		
	hexagonal nut thread M4 H 3.2mm WS 7 SS DIN/ISO DIN 934 / ISO 4032/8673 Qty 20 pcs		

**1**

<b>GEV No.</b>	415690	<b>Ref. No.</b>	002835
<b>description</b>	heating element 9000W 230V mounting $\varnothing$ 47.5mm heating circuits 3 L 290mm W 32mm H 38mm number of thermostat sleeves 1 thermostat sleeves $\varnothing$ 5mm length thermostat sleeves 175mm thermostat sleeve centre tube $\varnothing$ 8.5mm hole distance 63mm hole $\varnothing$ 10mm connection M5 3 hole flange immersion heater		
<b>spare parts for</b>	415690		
	<b>GEV No.</b>	<b>Ref. No.</b>	067620
	510408		
	O-ring EPDM thickness 5.34mm ID $\varnothing$ 47mm Qty 1 pcs		
<b>accessories for</b>	415690		
	<b>GEV No.</b>	<b>Ref. No.</b>	067620
	510408		
	O-ring EPDM thickness 5.34mm ID $\varnothing$ 47mm Qty 1 pcs		
	<b>GEV No.</b>	<b>Ref. No.</b>	—
	510562		
	O-ring silicone thickness 5.34mm ID $\varnothing$ 47mm Qty 1 pcs		



## 3 hole flange ø57.5mm

1

<b>GEV No.</b>	416134	<b>Ref. No.</b>	OL1772
<b>description</b>	heating element 10500W 230V mounting ø 57.5mm heating circuits 3 L 335mm W 52mm H 52mm tube ø 8.5mm hole distance 73mm hole ø 8/10mm connection male faston 6.3mm 3 hole flange immersion heater INCOLOY-800		
<b>spare parts for</b>	416134		
	<b>GEV No.</b>	510409	<b>Ref. No.</b> 007029
	O-ring EPDM thickness 5.34mm ID ø 56.52mm Qty 1 pcs		

1

<b>GEV No.</b>	418154	<b>Ref. No.</b>	OC5384
<b>description</b>	heating element 17000W 400V mounting ø 57.5mm heating circuits 6 L 450mm W 39mm H 41mm number of thermostat sleeves 1 thermostat sleeves ø 4.5mm length thermostat sleeves 180mm thermostat sleeve eccentric, clinging tube ø 6.3mm hole distance 69mm hole ø 6.5mm connection length 75mm connection male faston 6.3mm 3 hole flange immersion heater		
<b>spare parts for</b>	418154		
	<b>GEV No.</b>	510409	<b>Ref. No.</b> 007029
	O-ring EPDM thickness 5.34mm ID ø 56.52mm Qty 1 pcs		
<b>accessories for</b>	418154		
	<b>GEV No.</b>	510409	<b>Ref. No.</b> 007029
	O-ring EPDM thickness 5.34mm ID ø 56.52mm Qty 1 pcs		
	<b>GEV No.</b>	550002	<b>Ref. No.</b> —
	tension strap H 10mm L 21mm W 10mm hole ø 6.5mm for heating element		

1

<b>GEV No.</b>	418155	<b>Ref. No.</b>	OC5383
<b>description</b>	heating element 24000W 400V mounting ø 57.5mm heating circuits 6 L 570mm W 40mm H 40mm number of thermostat sleeves 1 thermostat sleeves ø 4.5mm length thermostat sleeves 180mm thermostat sleeve eccentric, clinging tube ø 6.3mm hole distance 69mm hole ø 6.5mm connection male faston 6.3mm 3 hole flange immersion heater		

1

<b>GEV No.</b>	416129	<b>Ref. No.</b>	OL2108
<b>description</b>	heating element 6000W 230V mounting ø 57.5mm heating circuits 3 L 330mm W 36mm H 40mm tube ø 8.5mm hole distance 70mm hole ø 7.8mm connection length 28mm connection male faston 6.3mm 3 hole flange immersion heater		
<b>accessories for</b>	416129		
	<b>GEV No.</b>	510409	<b>Ref. No.</b> 007029
	O-ring EPDM thickness 5.34mm ID ø 56.52mm Qty 1 pcs		

1

<b>GEV No.</b>	418779	<b>Ref. No.</b>	OL1630
<b>description</b>	heating element 9000W 230V mounting ø 57.5mm heating circuits 3 L 340mm W 52mm H 54mm tube ø 8.5mm hole distance 72mm hole ø 8mm with integrated fuse INCOLOY		
<b>spare parts for</b>	418779		
	<b>GEV No.</b>	510409	<b>Ref. No.</b> 007029
	O-ring EPDM thickness 5.34mm ID ø 56.52mm Qty 1 pcs		

1

<b>GEV No.</b>	418153	<b>Ref. No.</b>	OC5381
<b>description</b>	heating element 9000W 400V mounting ø 57.5mm heating circuits 6 L 440mm W 38mm H 40mm number of thermostat sleeves 1 thermostat sleeves ø 4mm length thermostat sleeves 180mm thermostat sleeve eccentric, clinging hole distance 68mm hole ø 6mm connection male faston 6.3mm 3 hole flange immersion heater		
<b>spare parts for</b>	418153		
	<b>GEV No.</b>	510409	<b>Ref. No.</b> 007029
	O-ring EPDM thickness 5.34mm ID ø 56.52mm Qty 1 pcs		





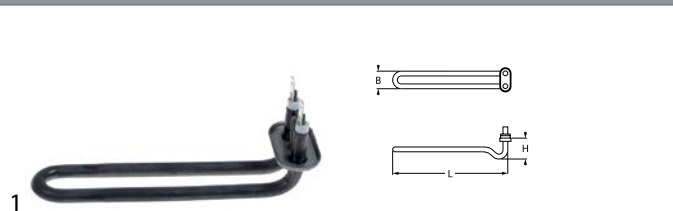

with compression flange 50 x 26mm



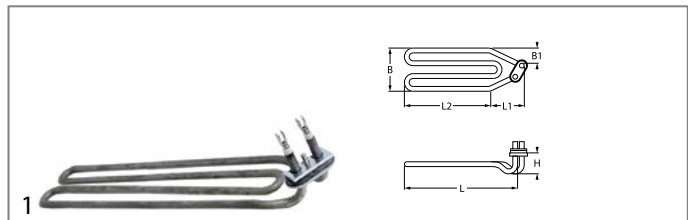

1

<b>GEV No.</b>	415272	<b>Ref. No.</b>	049059
<b>description</b>	heating element 800W 230V heating circuits 1 flange 50x26mm L 160mm W 34mm H 20mm tube ø 8.5mm connection male faston 6.3mm immersion heater compression flange		
<b>spare parts for</b>	415272		
	<b>GEV No.</b>	510387	<b>Ref. No.</b> 048483
	gasket L 46mm W 22mm ømm EPDM for heating element for flange 50x26mm		
<b>accessories for</b>	415272		
	<b>GEV No.</b>	510388	<b>Ref. No.</b> —
	counterflange ømm hole distancemm perforation ømm L 43mm W 21mm SS for heating element for flange 50x26mm		



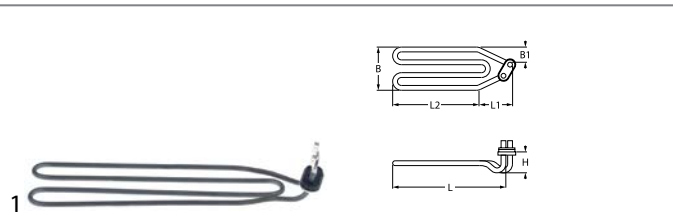

1

<b>GEV No.</b>	416132	<b>Ref. No.</b>	0L1870
<b>description</b>	heating element 3000W 230V compression flange flange 50x26mm L 360mm W 70mm H 25mm L1 60mm L2 300mm W1 20mm connection male faston 6.3mm heating circuits 1 tube ø 8.5mm immersion heater W2 50mm		
<b>accessories for</b>	416132		
	<b>GEV No.</b>	510387	<b>Ref. No.</b> 048483
	gasket L 46mm W 22mm ømm EPDM for heating element for flange 50x26mm		
	<b>GEV No.</b>	510388	<b>Ref. No.</b> —
	counterflange ømm hole distancemm perforation ømm L 43mm W 21mm SS for heating element for flange 50x26mm		



1

<b>GEV No.</b>	416133	<b>Ref. No.</b>	0L2109
<b>description</b>	heating element 2000W 230V compression flange flange 50x26mm L 365mm W 80mm H 27mm L1 95mm L2 270mm W1 30mm connection male faston 6.3mm heating circuits 1 tube ø 6.3mm immersion heater		
<b>accessories for</b>	416133		
	<b>GEV No.</b>	510387	<b>Ref. No.</b> 048483
	gasket L 46mm W 22mm ømm EPDM for heating element for flange 50x26mm		
	<b>GEV No.</b>	510388	<b>Ref. No.</b> —
	counterflange ømm hole distancemm perforation ømm L 43mm W 21mm SS for heating element for flange 50x26mm		

with expansion flange 70 x 18mm



1

<b>GEV No.</b>	418648	<b>Ref. No.</b>	049755
<b>description</b>	heating element 2000W 230V heating circuits 1 flange 70x18mm L 325mm W 65mm connection male faston 6.3mm tube ø 8.5mm immersion heater expansion flange connection length 20mm silicone		



1

<b>GEV No.</b>	418825	<b>Ref. No.</b>	049756
<b>description</b>	heating element 3000W 230V heating circuits 1 L 310mm W 68mm tube ø 8.5mm connection length 31mm mounting measurements 70x18mm		



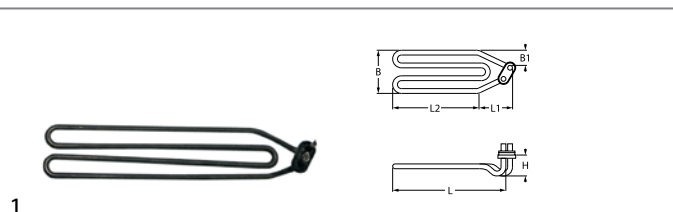

1

<b>GEV No.</b>	415459	<b>Ref. No.</b>	0H6146
<b>description</b>	heating element 5600W 230V heating circuits 2 flange 70x18mm L 272mm W 64mm connection male faston 6.3mm tube ø 8.5mm immersion heater expansion flange H 19mm		



1

<b>GEV No.</b>	415070	<b>Ref. No.</b>	048924
<b>description</b>	heating element 2200W 230V compression flange flange 50x26mm L 355mm W 75mm H 25mm L1 65mm L2 290mm W1 25mm connection male faston 6.3mm heating circuits 1 tube ø 6.3mm immersion heater W2 50mm		
<b>accessories for</b>	415070		
	<b>GEV No.</b>	510387	<b>Ref. No.</b> 048483
	gasket L 46mm W 22mm ømm EPDM for heating element for flange 50x26mm		
	<b>GEV No.</b>	510388	<b>Ref. No.</b> —
	counterflange ømm hole distancemm perforation ømm L 43mm W 21mm SS for heating element for flange 50x26mm		



1

<b>GEV No.</b>	415464	<b>Ref. No.</b>	0H6198
<b>description</b>	heating element 6000W 400V heating circuits 2 flange 70x18mm L 380mm W 65mm connection male faston 6.3mm tube ø 8.5mm immersion heater expansion flange		



with round flange ø47.5mm



<b>GEV No.</b>	419086	<b>Ref. No.</b>	056012
<b>description</b>	heating element 17000W 220V heating circuits 6 mounting ø 47.5mm L 470mm W 42mm H 42mm round flange cable length 380mm immersion heater tube ø 6.3mm connection length 130mm		



<b>GEV No.</b>	418156	<b>Ref. No.</b>	055464
<b>description</b>	heating element 17000W 240V heating circuits 3 mounting ø 47.5mm L 470mm W 36mm H 40mm round flange connection cable length 350mm immersion heater tube ø 6.3mm		

<b>accessories for</b>	418156			
	<b>GEV No.</b>	510408	<b>Ref. No.</b>	067620
	O-ring EPDM thickness 5.34mm ID ø 47mm Qty 1 pcs			
	<b>GEV No.</b>	510562	<b>Ref. No.</b>	—
	O-ring silicone thickness 5.34mm ID ø 47mm Qty 1 pcs			
	<b>GEV No.</b>	520235	<b>Ref. No.</b>	—
	3 hole flange hole distance 70.5mm perforation ø 6.5mm ID ø 53.5mm			
	<b>GEV No.</b>	520236	<b>Ref. No.</b>	003362
	flange for heating element ID ø 50mm ED ø 90mm hole ø 6.5mm 3 holes			
	<b>GEV No.</b>	550002	<b>Ref. No.</b>	—
	tension strap H 10mm L 21mm W 10mm hole ø 6.5mm for heating element			
	<b>GEV No.</b>	550362	<b>Ref. No.</b>	—
	blind flange ø 64mm mounting ø 47.5mm			



<b>GEV No.</b>	415809	<b>Ref. No.</b>	056013
<b>description</b>	heating element 24000W 400V heating circuits 3 L 225mm W 39mm H 33mm tube ø 8.3mm number of thermostat sleeves 0 connection male faston 6.3mm connection length 17mm immersion heater round flange mounting ø 47.5mm		

<b>accessories for</b>	415809			
	<b>GEV No.</b>	510408	<b>Ref. No.</b>	067620
	O-ring EPDM thickness 5.34mm ID ø 47mm Qty 1 pcs			
	<b>GEV No.</b>	510562	<b>Ref. No.</b>	—
	O-ring silicone thickness 5.34mm ID ø 47mm Qty 1 pcs			
	<b>GEV No.</b>	520235	<b>Ref. No.</b>	—
	3 hole flange hole distance 70.5mm perforation ø 6.5mm ID ø 53.5mm			
	<b>GEV No.</b>	520236	<b>Ref. No.</b>	003362
	flange for heating element ID ø 50mm ED ø 90mm hole ø 6.5mm 3 holes			
	<b>GEV No.</b>	550002	<b>Ref. No.</b>	—
	tension strap H 10mm L 21mm W 10mm hole ø 6.5mm for heating element			
	<b>GEV No.</b>	550362	<b>Ref. No.</b>	—
	blind flange ø 64mm mounting ø 47.5mm			



<b>GEV No.</b>	415652	<b>Ref. No.</b>	0C5337	
<b>description</b>	heating element 24000W 400V heating circuits 6 mounting ø 47.5mm L 585mm W 32mm H 35mm round flange connection male faston 6.3mm immersion heater tube ø 6.3mm connection length 86mm thermostat sleeves ø 5mm number of thermostat sleeves 1 length thermostat sleeves 155mm thermostat sleeve clinging			
<b>spare parts for</b>	415652			
	<b>GEV No.</b>	510408	<b>Ref. No.</b>	067620
	O-ring EPDM thickness 5.34mm ID ø 47mm Qty 1 pcs			
<b>accessories for</b>	415652			
	<b>GEV No.</b>	510408	<b>Ref. No.</b>	067620
	O-ring EPDM thickness 5.34mm ID ø 47mm Qty 1 pcs			
	<b>GEV No.</b>	510562	<b>Ref. No.</b>	—
	O-ring silicone thickness 5.34mm ID ø 47mm Qty 1 pcs			
	<b>GEV No.</b>	520235	<b>Ref. No.</b>	—
	3 hole flange hole distance 70.5mm perforation ø 6.5mm ID ø 53.5mm			
	<b>GEV No.</b>	520236	<b>Ref. No.</b>	003362
	flange for heating element ID ø 50mm ED ø 90mm hole ø 6.5mm 3 holes			
	<b>GEV No.</b>	550002	<b>Ref. No.</b>	—
	tension strap H 10mm L 21mm W 10mm hole ø 6.5mm for heating element			
	<b>GEV No.</b>	550362	<b>Ref. No.</b>	—
	blind flange ø 64mm mounting ø 47.5mm			
	<b>GEV No.</b>	550460	<b>Ref. No.</b>	—
	kable set			









<b>GEV No.</b>	420118	<b>Ref. No.</b>	0K4731
<b>description</b>	heating element 3000W 230V heating circuits 3 L 225mm W 39mm H 33mm tube ø 8.3mm number of thermostat sleeves 0 connection male faston 6.3mm connection length 17mm immersion heater round flange mounting ø 47.5mm		





<b>GEV No.</b>	420119	<b>Ref. No.</b>	0K4732
<b>description</b>	heating element 3000W 230V heating circuits 3 L 230mm W 42mm H 33mm tube ø 8.4mm thermostat sleeves ø 5mm length thermostat sleeves 190mm number of thermostat sleeves 1 thermostat sleeve eccentric, clinging/not clinging connection male faston 6.3mm connection length 16mm immersion heater round flange mounting ø 47.5mm		











 <p>Image not available</p>			
<b>GEV No.</b>	415026	<b>Ref. No.</b>	0L1874
<b>description</b>	heating element 4500W 220/380V mounting ø 47.5mm immersion heater		
<b>accessories for</b>	415026		
	<b>GEV No.</b>	510408	<b>Ref. No.</b> 067620
	O-ring EPDM thickness 5.34mm ID ø 47mm Qty 1 pcs		
	<b>GEV No.</b>	510562	<b>Ref. No.</b> —
	O-ring silicone thickness 5.34mm ID ø 47mm Qty 1 pcs		
	<b>GEV No.</b>	520235	<b>Ref. No.</b> —
	3 hole flange hole distance 70.5mm perforation ø 6.5mm ID ø 53.5mm		
	<b>GEV No.</b>	520236	<b>Ref. No.</b> 003362
	flange for heating element ID ø 50mm ED ø 90mm hole ø 6.5mm 3 holes		
	<b>GEV No.</b>	550002	<b>Ref. No.</b> —
	tension strap H 10mm L 21mm W 10mm hole ø 6.5mm for heating element		
	<b>GEV No.</b>	550362	<b>Ref. No.</b> —
	blind flange ø 64mm mounting ø 47.5mm		

			
<b>GEV No.</b>	420121	<b>Ref. No.</b>	OK4733
<b>description</b>	heating element 4500W 230V heating circuits 3 L 330mm W 39mm H 33mm tube ø 8.4mm number of thermostat sleeves 0 connection male faston 6.3mm connection length 17mm immersion heater round flange mounting ø 47.5mm		

			
<b>GEV No.</b>	420140	<b>Ref. No.</b>	OK4735
<b>description</b>	heating element 6000W 230V heating circuits 3 L 434mm W 38mm H 35mm tube ø 8.5mm number of thermostat sleeves 0 connection male faston 6.3mm connection length 17mm immersion heater round flange mounting ø 47.5mm		

			
<b>GEV No.</b>	420120	<b>Ref. No.</b>	OK4736
<b>description</b>	heating element 6000W 230V heating circuits 3 L 435mm W 43mm H 33mm tube ø 8.5mm thermostat sleeves ø 5mm length thermostat sleeves 190mm number of thermostat sleeves 1 thermostat sleeve eccentric, clinging/not clinging connection male faston 6.3mm connection length 17mm immersion heater round flange mounting ø 47.5mm		

			
<b>GEV No.</b>	415405	<b>Ref. No.</b>	0L1879
<b>description</b>	heating element 6000W 230V heating circuits 3 L 465mm W 38mm H 24mm tube ø 6.3mm connection male faston 6.3mm immersion heater round flange mounting ø 47.5mm		
<b>spare parts for</b>	415405		
	<b>GEV No.</b>	504148	<b>Ref. No.</b> —
	boiler		
<b>accessories for</b>	415405		
	<b>GEV No.</b>	520235	<b>Ref. No.</b> —
	3 hole flange hole distance 70.5mm perforation ø 6.5mm ID ø 53.5mm		
	<b>GEV No.</b>	520236	<b>Ref. No.</b> 003362
	flange for heating element ID ø 50mm ED ø 90mm hole ø 6.5mm 3 holes		
	<b>GEV No.</b>	521012	<b>Ref. No.</b> —
	gasket graphite ED ø 15mm ID ø 5mm thickness 1.2mm Qty 1 pcs		
	<b>GEV No.</b>	550002	<b>Ref. No.</b> —
	tension strap H 10mm L 21mm W 10mm hole ø 6.5mm for heating element		
	<b>GEV No.</b>	550362	<b>Ref. No.</b> —
	blind flange ø 64mm mounting ø 47.5mm		

			
<b>GEV No.</b>	420122	<b>Ref. No.</b>	OK6397
<b>description</b>	heating element 6000W 240V heating circuits 3 L 430mm W 39mm H 33mm tube ø 8.5mm thermostat sleeves ø 5mm length thermostat sleeves 190mm number of thermostat sleeves 1 thermostat sleeve eccentric, clinging/not clinging connection male faston 6.3mm connection length 17mm immersion heater round flange mounting ø 47.5mm		

			
<b>GEV No.</b>	418188	<b>Ref. No.</b>	056011
<b>description</b>	heating element 7500W 220V heating circuits 3 mounting ø 47.5mm L 260mm W 35mm H 32mm round flange cable length 1040mm immersion heater tube ø 6.2mm		
<b>accessories for</b>	418188		
	<b>GEV No.</b>	510408	<b>Ref. No.</b> 067620
	O-ring EPDM thickness 5.34mm ID ø 47mm Qty 1 pcs		
	<b>GEV No.</b>	510562	<b>Ref. No.</b> —
	O-ring silicone thickness 5.34mm ID ø 47mm Qty 1 pcs		
	<b>GEV No.</b>	520235	<b>Ref. No.</b> —
	3 hole flange hole distance 70.5mm perforation ø 6.5mm ID ø 53.5mm		
	<b>GEV No.</b>	520236	<b>Ref. No.</b> 003362
	flange for heating element ID ø 50mm ED ø 90mm hole ø 6.5mm 3 holes		
	<b>GEV No.</b>	550002	<b>Ref. No.</b> —
	tension strap H 10mm L 21mm W 10mm hole ø 6.5mm for heating element		

Table continues overleaf







<b>accessories for</b>	418188		
	<b>GEV No.</b>	550362	<b>Ref. No.</b> —
	blind flange ø 64mm mounting ø 47.5mm		



## with round flange ø57.5mm

<b>1</b>			
<b>GEV No.</b>	420313	<b>Ref. No.</b>	0E7066
<b>description</b>	heating element 10000W 230V heating circuits 3 mounting ø 57.5mm L 455mm W 44mm H 42mm round flange connection male faston 6.3mm immersion heater tube ø 6.2mm thermostat sleeves ø 7mm number of thermostat sleeves 1 length thermostat sleeves 225mm thermostat sleeve eccentric, non clinging		
<b>accessories for</b>	420313		
	<b>GEV No.</b>	510409	<b>Ref. No.</b> 007029
	O-ring EPDM thickness 5.34mm ID ø 56.52mm Qty 1 pcs		
	<b>GEV No.</b>	550002	<b>Ref. No.</b> —
	tension strap H 10mm L 21mm W 10mm hole ø 6.5mm for heating element		



<b>1</b>			
<b>GEV No.</b>	418983	<b>Ref. No.</b>	OK7530
<b>description</b>	heating element 12000W 220V heating circuits 3 mounting ø 57.5mm L 455mm W 40mm H 30mm connection M5 immersion heater tube ø 6.3mm connection length 20mm thermostat sleeves ø 6mm number of thermostat sleeves 1 length thermostat sleeves 290mm thermostat sleeve upper dishwasher		

<b>1</b>			
<b>GEV No.</b>	419132	<b>Ref. No.</b>	0E5162
<b>description</b>	heating element 12000W 230V heating circuits 3 mounting ø round flange ø57.5mm L 460mm W 35mm H 55mm round flange immersion heater tube ø 6.2mm H2 35mm L1 40mm L2 400mm		
<b>accessories for</b>	419132		
	<b>GEV No.</b>	510409	<b>Ref. No.</b> 007029
	O-ring EPDM thickness 5.34mm ID ø 56.52mm Qty 1 pcs		
	<b>GEV No.</b>	560400	<b>Ref. No.</b> —
	flat-headed bolt thread M5 thread L 8mm SS DIN 84/ISO 1207 Qty 1 pcs intake slotted head ø 8.3mm head thickness 3.2mm		
	<b>GEV No.</b>	699566	<b>Ref. No.</b> —
	connection terminal for heating element		



<b>1</b>			
<b>GEV No.</b>	420317	<b>Ref. No.</b>	OK8505
<b>description</b>	heating element 15000W 230V heating circuits 3 mounting ø 57.5mm L 480mm W 32mm H 60mm round flange connection M5 immersion heater tube ø 6.3mm H1 40mm H2 20mm L1 450mm L2 30mm number of thermostat sleeves 0		

<b>1</b>			
<b>GEV No.</b>	420316	<b>Ref. No.</b>	OK8249
<b>description</b>	heating element 6000W 230V heating circuits 3 mounting ø 57.5mm L 463mm W 40mm H 40mm round flange connection male faston 6.3mm immersion heater tube ø 6.25mm thermostat sleeves ø 6.5mm number of thermostat sleeves 1 length thermostat sleeves 308mm thermostat sleeve eccentric, clinging		
<b>accessories for</b>	420316		
	<b>GEV No.</b>	510409	<b>Ref. No.</b> 007029
	O-ring EPDM thickness 5.34mm ID ø 56.52mm Qty 1 pcs		

<b>1</b>			
<b>GEV No.</b>	420224	<b>Ref. No.</b>	OH2277
<b>description</b>	heating element 7500W 220V heating circuits 3 mounting ø 57.5mm L 324mm W 40mm H 42mm flange connection connection male faston 6.3mm immersion heater tube ø 6mm thermostat sleeves ø 7mm number of thermostat sleeves 1 length thermostat sleeves 290mm thermostat sleeve eccentric, clinging		

<b>1</b>			
<b>GEV No.</b>	418615	<b>Ref. No.</b>	OL1859
<b>description</b>	heating element 7500W 230V heating circuits 3 mounting ø round flange ø57.5mm L 440mm W 35mm H 55mm round flange immersion heater tube ø 6.2mm H1 20mm H2 35mm L1 40mm L2 400mm		
<b>spare parts for</b>	418615		
	<b>GEV No.</b>	510409	<b>Ref. No.</b> 007029
	O-ring EPDM thickness 5.34mm ID ø 56.52mm Qty 1 pcs		
<b>accessories for</b>	418615		
	<b>GEV No.</b>	550002	<b>Ref. No.</b> —
	tension strap H 10mm L 21mm W 10mm hole ø 6.5mm for heating element		

<b>1</b>			
<b>GEV No.</b>	420312	<b>Ref. No.</b>	0E5113
<b>description</b>	heating element 8000W 230V heating circuits 3 mounting ø 57.5mm L 455mm W 40mm H 42mm round flange connection male faston 6.3mm immersion heater tube ø 6.2mm thermostat sleeves ø 7mm number of thermostat sleeves 1 length thermostat sleeves 225mm thermostat sleeve eccentric, non clinging		

<b>1</b>			
<b>GEV No.</b>	420306	<b>Ref. No.</b>	0E5163
<b>description</b>	heating element 9000W 230V heating circuits 3 mounting ø 57.5mm L 450mm W 34mm H 60mm round flange ø57.5mm connection M5 immersion heater tube ø 6.5mm H1 36mm H2 24mm L1 50mm L2 400mm number of thermostat sleeves 0		
<b>accessories for</b>	420306		
	<b>GEV No.</b>	510409	<b>Ref. No.</b> 007029
	O-ring EPDM thickness 5.34mm ID ø 56.52mm Qty 1 pcs		

special flanges



1

<b>GEV No.</b>	415797	<b>Ref. No.</b>	OK0517
<b>description</b>	heating element 18000W 400V heating circuits 6 L 325mm W 240mm H 45mm tube ø 6.5mm connection cable cable length 1250mm immersion heater rectangular flange hole distance 62mm flange length 336mm flange width 126mm hole ø 10mm		
<b>accessories for</b>	415797		
	<b>GEV No.</b>	<b>Ref. No.</b>	<b>Ref. No.</b>
	510560	OK5577	
	gasket EPDM thickness 6mm ID ø 200mm dimensions 280x70mm Qty 1 pcs for heating element		





1

<b>GEV No.</b>	415799	<b>Ref. No.</b>	OH6153
<b>description</b>	heating element 25200W 400V heating circuits 6 L 470mm W 235mm H 90mm connection cable cable length 1500mm immersion heater special fixing hole distance 48/56mm hole ø 10mm		
<b>accessories for</b>	415799		
	<b>GEV No.</b>	<b>Ref. No.</b>	<b>Ref. No.</b>
	510560	OK5577	
	gasket EPDM thickness 6mm ID ø 200mm dimensions 280x70mm Qty 1 pcs for heating element		

3/4"





1

<b>GEV No.</b>	415580	<b>Ref. No.</b>	OG0334
<b>description</b>	heating element 5000W 400V heating circuits 1 L 404mm W 23mm H 80mm cable length 400mm connection length 85mm immersion heater flange with thread H1 52mm H2 28mm thread 3/4"		
<b>accessories for</b>	415580		
	<b>GEV No.</b>	<b>Ref. No.</b>	<b>Ref. No.</b>
	510403		—
	flat gasket fibre ED ø 36.5mm ID ø 27mm thickness 2mm Qty 1 pcs		
	<b>GEV No.</b>	<b>Ref. No.</b>	<b>Ref. No.</b>
	510421		—
	gasket copper ED ø 31.8mm ID ø 26.4mm thickness 2.2mm for thread 3/4"		
	<b>GEV No.</b>	<b>Ref. No.</b>	<b>Ref. No.</b>
	520234		—
	nut thread 3/4" H 5mm brass WS 30 Qty 1 pcs		



1

<b>GEV No.</b>	415010	<b>Ref. No.</b>	069671
<b>description</b>	heating element 2000W 230V heating circuits 1 L 260mm W 125mm H 20mm L1 110mm L2 150mm W1 42mm W2 83mm thread M10x1 mounting distance 70mm tube ø 6.5mm connection M4 immersion heater 2 hole fixing		
<b>spare parts for</b>	415010		
	<b>GEV No.</b>	<b>Ref. No.</b>	<b>Ref. No.</b>
	510416		—
	flat gasket fibre ED ø 19mm ID ø 10.5mm thickness 1.5mm for thread M10 Qty 1 pcs		
<b>accessories for</b>	415010		
	<b>GEV No.</b>	<b>Ref. No.</b>	<b>Ref. No.</b>
	504306	069438	
	gasket fibre ED ø 16mm ID ø 10mm thickness 2mm Qty 1 pcs		
	<b>GEV No.</b>	<b>Ref. No.</b>	<b>Ref. No.</b>
	510893		—
	O-ring EPDM thickness 2.62mm ID ø 9.92mm Qty 1 pcs		
	<b>GEV No.</b>	<b>Ref. No.</b>	<b>Ref. No.</b>
	520231		—
	nut thread M10x1 H 6mm WS 14 zinc-coated steel Qty 1 pcs		
	<b>GEV No.</b>	<b>Ref. No.</b>	<b>Ref. No.</b>
	521103		—
	nut thread M4 H 3mm WS 7 brass Qty 20 pcs		
	<b>GEV No.</b>	<b>Ref. No.</b>	<b>Ref. No.</b>
	521104		—
	washer ID ø 4.3mm ED ø 8mm thickness 0.5mm brass Qty 20 pcs for thread M4		
	<b>GEV No.</b>	<b>Ref. No.</b>	<b>Ref. No.</b>
	521129		—
	nut thread M10 H 6mm SS WS 17 Qty 1 pcs DIN/ISO DIN 439		
	<b>GEV No.</b>	<b>Ref. No.</b>	<b>Ref. No.</b>
	560111		—
	plain washer ID ø 4.3mm ED ø 9mm thickness 0.8mm SS Qty 20 pcs DIN 125A for thread M4		
	<b>GEV No.</b>	<b>Ref. No.</b>	<b>Ref. No.</b>
	560131		—
	hexagonal nut thread M4 H 3.2mm WS 7 SS DIN/ISO DIN 934 / ISO 4032/8673 Qty 20 pcs		



1













<b>GEV No.</b>	415073	<b>Ref. No.</b>	047507
<b>description</b>	heating element 2200W 220V heating circuits 1 L 403mm W 138mm H 22mm L1 124mm L2 279mm W1 27mm W2 84mm thread M14x1 mounting distance 80mm tube ø 8.5mm 2 hole fixing connection M5 immersion heater		
<b>accessories for</b>	415073		
	<b>GEV No.</b>	<b>Ref. No.</b>	<b>Ref. No.</b>
	510417		—
	flat gasket fibre ED ø 20mm ID ø 14mm thickness 2mm Qty 1 pcs		
	<b>GEV No.</b>	<b>Ref. No.</b>	<b>Ref. No.</b>
	520228		—
	tooth lock washer ID ø 15.3mm ED ø 24mm steel Qty 1 pcs for thread M14		
	<b>GEV No.</b>	<b>Ref. No.</b>	<b>Ref. No.</b>
	521133		—
	nut thread M14x1.5 H 6mm WS 19 zinc-coated steel Qty 1 pcs		
	<b>GEV No.</b>	<b>Ref. No.</b>	<b>Ref. No.</b>
	550261		—
	nut thread M14x1 H 4mm WS 19 SS Qty 1 pcs		

Table continues overleaf

<b>accessories for</b>	415073		
	GEV No.	550262	Ref. No. —
	flat gasket copper ED ø 20mm ID ø 14mm thickness 2mm		
	GEV No.	560112	Ref. No. —
	plain washer ID ø 5.3mm ED ø 10mm thickness 1mm SS Qty 20 pcs DIN 125A for thread M5		
	GEV No.	560132	Ref. No. —
	hexagonal nut thread M5 H 4mm WS 8 SS DIN/ISO DIN 934 / ISO 4032/8673 Qty 20 pcs		



<b>GEV No.</b>	415072	<b>Ref. No.</b>	048086
<b>description</b>	heating element 2200W 230V heating circuits 1 L 325mm W 83mm H 25mm thread M14x1 mounting distance 75mm tube ø 8.5mm connection male faston 6.3mm 2 hole fixing immersion heater		
<b>accessories for</b>	415072		
	GEV No.	510417	Ref. No. —
	flat gasket fibre ED ø 20mm ID ø 14mm thickness 2mm Qty 1 pcs		
	GEV No.	520228	Ref. No. —
	tooth lock washer ID ø 15.3mm ED ø 24mm steel Qty 1 pcs for thread M14		
	GEV No.	521133	Ref. No. —
	nut thread M14x1.5 H 6mm WS 19 zinc-coated steel Qty 1 pcs		
	GEV No.	550261	Ref. No. —
	nut thread M14x1 H 4mm WS 19 SS Qty 1 pcs		
	GEV No.	550262	Ref. No. —
	flat gasket copper ED ø 20mm ID ø 14mm thickness 2mm		



<b>GEV No.</b>	420142	<b>Ref. No.</b>	0KJ338
<b>description</b>	heating element 4000W 380V heating circuits 1 H 120mm tube ø 8.3mm connection M4 immersion heater 12 hole fixing for kettle W1 52mm H1 28mm H2 92mm thread M14x1.5 ø 79mm windings 7 mounting distance 44mm		

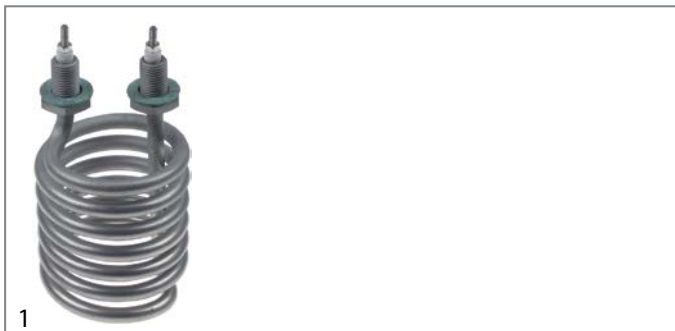

<b>GEV No.</b>	420141	<b>Ref. No.</b>	0K8600
<b>description</b>	heating element 5000W 230V heating circuits 1 L 116mm W 79mm tube ø 8.5mm connection M4 immersion heater 2 hole fixing for kettle W1 53mm H1 29mm H2 88mm thread M14x1.5 ø 79mm windings 7 mounting distance 45mm		

2 connections

angled

group 1



<b>GEV No.</b>	418007	<b>Ref. No.</b>	059680
<b>description</b>	heating element 1050W 230V heating circuits 1 L 425mm W 41.5mm H 92mm tube ø 8.5mm connection M5 dry heating element connection distance 33mm		



<b>GEV No.</b>	418008	<b>Ref. No.</b>	059679
<b>description</b>	heating element 1250W 230V heating circuits 1 L 485mm W 44mm H 95mm tube ø 8.7mm connection M5 connection length 22mm dry heating element connection distance 35mm		

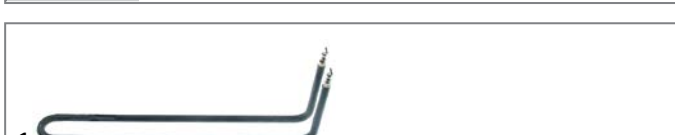

<b>GEV No.</b>	418006	<b>Ref. No.</b>	059681
<b>description</b>	heating element 750W 230V heating circuits 1 L 317mm W 41.5mm H 92mm tube ø 8.5mm connection M5 dry heating element connection distance 33mm		



heating elements for convection





1

<b>GEV No.</b>	415119	<b>Ref. No.</b>	0A2017
<b>description</b>	heating element 1600W 230V heating circuits 1 ID $\phi$ 179mm ED $\phi$ 197mm L 254mm H 30mm L1 51mm W1 31mm H1 9mm H2 21mm flange length 70mm flange width 22mm hole distance 56mm connection male faston 6.3mm connection length 41mm tube $\phi$ 6.3mm convection heating element hole $\phi$ 4mm rectangular flange		
<b>accessories for</b>	415119		
	<b>GEV No.</b>	510368	<b>Ref. No.</b> —
	gasket L 70mm W 23.5mm hole $\phi$ 5mm hole distance 56mm FIBER thickness 2mm for heating element		





1

<b>GEV No.</b>	415123	<b>Ref. No.</b>	0H6212
<b>description</b>	heating element 1750W 220V heating circuits 1 ID $\phi$ 186mm ED $\phi$ 199mm L 222mm H 29mm L1 14mm W1 30mm H1 9mm H2 20mm flange length 70mm flange width 22mm hole distance 56mm connection male faston 6.3mm tube $\phi$ 6.3mm convection heating element hole $\phi$ 5mm rectangular flange		
<b>accessories for</b>	415123		
	<b>GEV No.</b>	510368	<b>Ref. No.</b> —
	gasket L 70mm W 23.5mm hole $\phi$ 5mm hole distance 56mm FIBER thickness 2mm for heating element		





1

<b>GEV No.</b>	415118	<b>Ref. No.</b>	031485
<b>description</b>	heating element 2400W 230V heating circuits 1 ID $\phi$ 178mm ED $\phi$ 190mm L 221mm H 28mm L1 15mm W1 30mm H1 11mm H2 19mm flange length 100mm flange width 22mm hole distance 86mm connection male faston 6.3mm connection length 32mm tube $\phi$ 6.3mm convection heating element hole $\phi$ 5mm rectangular flange		
<b>accessories for</b>	415118		
	<b>GEV No.</b>	510368	<b>Ref. No.</b> —
	gasket L 70mm W 23.5mm hole $\phi$ 5mm hole distance 56mm FIBER thickness 2mm for heating element		





1

<b>GEV No.</b>	415117	<b>Ref. No.</b>	054843
<b>description</b>	heating element 2500W 220V heating circuits 1 ID $\phi$ 175mm ED $\phi$ 195mm L 245mm H 55mm L1 50mm W1 30mm H1 25mm H2 10mm flange length 70mm flange width 22mm hole distance 56mm connection male faston 6.3mm horizontal tube $\phi$ 6.5mm convection heating element hole $\phi$ 5mm rectangular flange		
<b>spare parts for</b>	415117		
	<b>GEV No.</b>	510368	<b>Ref. No.</b> —
	gasket L 70mm W 23.5mm hole $\phi$ 5mm hole distance 56mm FIBER thickness 2mm for heating element		
<b>accessories for</b>	415117		
	<b>GEV No.</b>	510426	<b>Ref. No.</b> 0H6829
	gasket L 72mm W 20mm hole distance 56mm silicone thickness 2mm for heating element		



1

<b>GEV No.</b>	415966	<b>Ref. No.</b>	004934
<b>description</b>	heating element 2500W 230V heating circuits 1 ID $\phi$ 176mm ED $\phi$ 188mm L 210mm H 28mm L1 22mm W1 30mm H1 3mm H2 25mm flange length 70mm flange width 22mm hole distance 56mm connection male faston 6.3mm tube $\phi$ 6.3mm convection heating element hole $\phi$ 5mm rectangular flange		
<b>spare parts for</b>	415966		
	<b>GEV No.</b>	510368	<b>Ref. No.</b> —
	gasket L 70mm W 23.5mm hole $\phi$ 5mm hole distance 56mm FIBER thickness 2mm for heating element		
<b>accessories for</b>	415966		
	<b>GEV No.</b>	510368	<b>Ref. No.</b> —
	gasket L 70mm W 23.5mm hole $\phi$ 5mm hole distance 56mm FIBER thickness 2mm for heating element		





1

<b>GEV No.</b>	415351	<b>Ref. No.</b>	056945
<b>description</b>	heating element 2500W 230V heating circuits 1 ID $\phi$ mm L 544mm L1 100mm W1 160mm flange length 70mm flange width 22mm hole distance 56mm ED $\phi$ mm connection male faston 6.3mm tube $\phi$ 8.5mm dry heating element hole $\phi$ 50mm rectangular flange L2 444mm W2 33mm W 350mm		





1

<b>GEV No.</b>	418083	<b>Ref. No.</b>	055503
<b>description</b>	heating element 3000W 230V heating circuits 1 ID ø 179mm ED ø 190mm L 245mm H 35mm L1 45mm W1 30mm H1 10mm H2 25mm flange length 70mm flange width 22mm hole distance 56mm connection male faston 6.3mm connection length 18mm tube ø 6.3mm convection heating element hole ø 5mm rectangular flange		
<b>accessories for</b>	418083		
	<b>GEV No.</b>	510368	<b>Ref. No.</b> —
	gasket L 70mm W 23.5mm hole ø 5mm hole distance 56mm FIBER thickness 2mm for heating element		



1

<b>GEV No.</b>	418150	<b>Ref. No.</b>	0C5362
<b>description</b>	heating element 3200W 400V heating circuits 2 ID ø 383mm ED ø 400mm L 536mm H 60mm L1 136mm W1 32mm H1 36mm H2 24mm flange length 80mm flange width 45mm hole distance 60mm connection male faston 6.3mm connection length 30mm tube ø 8.5mm convection heating element hole ø 6mm rectangular flange		
<b>accessories for</b>	418150		
	<b>GEV No.</b>	550257	<b>Ref. No.</b> 002689
	gasket L 137mm W 79mm thickness 3.5mm for heating element suitable for JUNO equiv. no. 02689		





1

<b>GEV No.</b>	415368	<b>Ref. No.</b>	056930
<b>description</b>	heating element 3750W 220V heating circuits 3 L 535mm H 34mm L1 95mm W1 157mm flange length 78mm flange width 50mm hole distance 60mm connection male faston 6.3mm connection length 97mm tube ø 8.5mm dry heating element hole ø 6mm rectangular flange L2 440mm W2 33mm W 348mm		





1

<b>GEV No.</b>	415657	<b>Ref. No.</b>	002757
<b>description</b>	heating element 4500W 230V heating circuits 3 L 534mm W 350mm H 70mm L1 96mm L2 438mm W1 160mm W2 33mm H1 37mm H2 33mm flange length 76mm flange width 50mm hole distance 60mm hole ø 6mm tube ø 8.5mm convection heating element connection male faston 6.3mm connection length 103mm rectangular flange		
<b>accessories for</b>	415657		
	<b>GEV No.</b>	550256	<b>Ref. No.</b> 055327
	gasket L 75mm W 50mm hole ø 5mm hole distance 59.5mm rubber thickness 3mm for heating element suitable for JUNO equiv. no. 55327		
	<b>GEV No.</b>	550257	<b>Ref. No.</b> 002689
	gasket L 137mm W 79mm thickness 3.5mm for heating element suitable for JUNO equiv. no. 02689		



1

<b>GEV No.</b>	415654	<b>Ref. No.</b>	002688
<b>description</b>	heating element 5666W 230V heating circuits 2 ID ø 465mm ED ø 480mm L 580mm H 65mm L1 90mm W1 32mm H1 34mm H2 31mm flange length 80mm flange width 45mm hole distance 56mm connection M5 connection length 108mm tube ø 8.5mm convection heating element hole ø 6mm rectangular flange		
<b>accessories for</b>	415654		
	<b>GEV No.</b>	550256	<b>Ref. No.</b> 055327
	gasket L 75mm W 50mm hole ø 5mm hole distance 59.5mm rubber thickness 3mm for heating element suitable for JUNO equiv. no. 55327		
	<b>GEV No.</b>	550257	<b>Ref. No.</b> 002689
	gasket L 137mm W 79mm thickness 3.5mm for heating element suitable for JUNO equiv. no. 02689		



1

<b>GEV No.</b>	415389	<b>Ref. No.</b>	058197
<b>description</b>	heating element 5666W 230V heating circuits 2 ID ø 470mm ED ø 487mm L 590mm H 66mm L1 105mm W1 33mm H1 37mm H2 29mm flange length 80mm flange width 45mm hole distance 60mm connection M5 tube ø 8.5mm convection heating element hole ø 6mm rectangular flange		
<b>accessories for</b>	415389		
	<b>GEV No.</b>	550256	<b>Ref. No.</b> 055327
	gasket L 75mm W 50mm hole ø 5mm hole distance 59.5mm rubber thickness 3mm for heating element suitable for JUNO equiv. no. 55327		







1

<b>GEV No.</b>	418151	<b>Ref. No.</b>	0C5364
<b>description</b>	heating element 5670W 400V heating circuits 2 ID ø 467mm ED ø 483mm L 585mm H 60mm L1 102mm W1 33mm H1 32mm H2 28mm flange length 80mm flange width 45mm hole distance 60mm connection male faston 6.3mm tube ø 8.5mm convection heating element hole ø 6mm rectangular flange		
<b>accessories for</b>	418151		
	<b>GEV No.</b>	550257	<b>Ref. No.</b> 002689
	gasket L 137mm W 79mm thickness 3.5mm for heating element suitable for JUNO equiv. no. 02689		

1

<b>GEV No.</b>	415656	<b>Ref. No.</b>	0A5330
<b>description</b>	heating element 8000W 400V heating circuits 2 ID ø 560mm ED ø 580mm L 630mm H 68mm L1 50mm W1 33mm H1 37mm H2 29mm flange length 80mm flange width 45mm hole distance 60mm connection M5 connection length 15mm tube ø 8.5mm convection heating element hole ø 6mm rectangular flange		
<b>accessories for</b>	415656		
	<b>GEV No.</b>	550256	<b>Ref. No.</b> 055327
	gasket L 75mm W 50mm hole ø 5mm hole distance 59.5mm rubber thickness 3mm for heating element suitable for JUNO equiv. no. 55327		
	<b>GEV No.</b>	550257	<b>Ref. No.</b> 002689
	gasket L 137mm W 79mm thickness 3.5mm for heating element suitable for JUNO equiv. no. 02689		

1

<b>GEV No.</b>	415393	<b>Ref. No.</b>	056970
<b>description</b>	heating element 8000W 230V heating circuits 2 L 150mm W 545mm H 134mm L1 33mm L2 117mm W1 29mm H1 19mm H2 115mm flange length 76mm flange width 50mm hole distance 60mm connection M5 tube ø 8.5mm convection heating element hole ø 6mm rectangular flange		

1

<b>GEV No.</b>	418152	<b>Ref. No.</b>	0C5365
<b>description</b>	heating element 8000W 400V heating circuits 2 ID ø 569mm ED ø 580mm L 700mm H 60mm L1 120mm W1 33mm H1 34mm H2 26mm flange length 80mm flange width 45mm hole distance 60mm connection male faston 6.3mm connection length 20mm tube ø 8.5mm dry heating element hole ø 6mm rectangular flange		
<b>accessories for</b>	418152		
	<b>GEV No.</b>	550257	<b>Ref. No.</b> 002689
	gasket L 137mm W 79mm thickness 3.5mm for heating element suitable for JUNO equiv. no. 02689		

1



<b>GEV No.</b>	415391	<b>Ref. No.</b>	056934
<b>description</b>	heating element 8000W 230V heating circuits 2 L 170mm W 505mm H 128mm L1 33mm L2 138mm W1 29mm H1 13mm H2 115mm flange length 76mm flange width 50mm hole distance 60mm connection M5 connection length 104mm tube ø 8.5mm convection heating element hole ø 6mm rectangular flange		

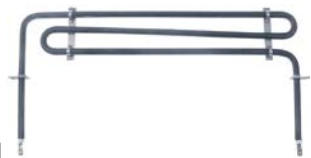

1

<b>GEV No.</b>	420117	<b>Ref. No.</b>	056973
<b>description</b>	heating element 8000W 415V heating circuits 2 L 170mm W 505mm H 133mm L1 32mm L2 138mm W1 29mm H1 33mm H2 100mm flange length 76mm flange width 50mm hole distance 60mm connection M5 connection length 102mm tube ø 8.5mm convection heating element hole ø 6mm rectangular flange		

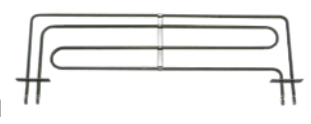

			
1			
<b>GEV No.</b>	420468	<b>Ref. No.</b>	0E5126
<b>description</b>	heating element 1375W 230V heating circuits 1 L 370mm W 87mm W2 56.5mm flange length 23mm flange width 13mm hole distance 382mm connection length 95mm connection F6.3 tube ø 8.5mm W1 30.5mm rectangular flange		

			
1			
<b>GEV No.</b>	415616	<b>Ref. No.</b>	0H6189
<b>description</b>	heating element 3000W 380V heating circuits 2 L 575mm W 150mm W2 125mm flange length 70mm flange width 22mm hole distance 28mm connection length 20mm connection male faston 6.3mm tube ø 6.3mm hole ø 4mm W1 25mm rectangular flange dry heating element		
<b>accessories for</b>	415616		
	<b>GEV No.</b>	510368	<b>Ref. No.</b> —
	gasket L 70mm W 23.5mm hole ø 5mm hole distance 56mm FIBER thickness 2mm for heating element		

			
1			
<b>GEV No.</b>	415806	<b>Ref. No.</b>	0H6176
<b>description</b>	heating element 5200W 230V heating circuits 2 L 240mm W 390mm H 30mm W2 50mm flange length 70mm flange width 22mm hole distance 56mm connection male faston 6.3mm tube ø 6.5mm hole ø 5mm W1 290mm rectangular flange convection heating element		
<b>accessories for</b>	415806		
	<b>GEV No.</b>	510368	<b>Ref. No.</b> —
	gasket L 70mm W 23.5mm hole ø 5mm hole distance 56mm FIBER thickness 2mm for heating element		

			
1			
<b>GEV No.</b>	418910	<b>Ref. No.</b>	032072
<b>description</b>	heating element 810W 240V heating circuits 1 L 250mm W 60.5mm connection length 42mm connection male faston 6.3mm tube ø 8.5mm thread M12x1 convection heating element mounting distance 52mm		

radiation heaters

			
1			
<b>GEV No.</b>	490153	<b>Ref. No.</b>	0C4077
<b>description</b>	radiation heater octagonal 3400W 230V L 300mm W 300mm heating circuits 2 H 30mm with heating coil energy regulation with temperature signalization connections 4+2 connection type cable cable length 900mm AD		

			
1			
<b>GEV No.</b>	416998	<b>Ref. No.</b>	004755
<b>description</b>	radiation heater rectangular 2700W 230V L 410mm W 165mm heating circuits 3 connections 3x 2 IRCA for fryer		

			
1			
<b>GEV No.</b>	416999	<b>Ref. No.</b>	005942
<b>description</b>	radiation heater rectangular 5000W 230V L 410mm W 280mm heating circuits 3 connections 3x 2 IRCA for fryer		

			
1			
<b>GEV No.</b>	418000	<b>Ref. No.</b>	006158
<b>description</b>	radiation heater rectangular 9000W 400V L 432mm W 340mm heating circuits 3 IRCA for fryer		

2-circuit

			
1			
<b>GEV No.</b>	490133	<b>Ref. No.</b>	059043
<b>description</b>	radiation heater ø 230mm 2100W 230V		

1

<b>GEV No.</b>	490028	<b>Ref. No.</b>	005008
<b>description</b>	radiation heater ø 230mm 2100W 230V heating circuits 2 energy regulation with temperature signalization partial power 650W with heating coil connections 3+2 connection type male faston 6.3mm EGO		



1

<b>GEV No.</b>	490134	<b>Ref. No.</b>	059432
<b>description</b>	radiation heater ø 230mm 2200W 230V heating circuits 2		



1

<b>GEV No.</b>	490044	<b>Ref. No.</b>	0A5299
<b>description</b>	radiation heater ø 230mm 2200W 230V heating circuits 2 energy regulation with temperature signalization partial power 750W with ribbon heater connections 3+2 connection type male faston 6.3mm EGO		

foil heating elements



1

<b>GEV No.</b>	418763	<b>Ref. No.</b>	032086
<b>description</b>	foil heating element L 290mm W 175mm 500W 230V t.max. 150°C with temperature limiter 140°C silicone cable length 1000mm switch-off temp. 140°C		



1

<b>GEV No.</b>	416371	<b>Ref. No.</b>	032094
<b>description</b>	foil heating element L 400mm W 290mm 1000W 230V t.max. 140°C with temperature limiter silicone cable length 2000mm thickness 1mm		

hot plates

square & rectangular

with radiused edge



1

<b>GEV No.</b>	490065	<b>Ref. No.</b>	0A2198
<b>description</b>	hot plate dimensions 220x220mm 2000W 230V with spill ring connection 4 screw clamps protector no square		



1

<b>GEV No.</b>	490066 <sup>1</sup>	<b>Ref. No.</b>	006220
<b>description</b>	hot plate dimensions 220x220mm 2600W 230V with spill ring connection 4 screw clamps protector yes square		

<sup>1</sup>incl. protector



1

<b>GEV No.</b>	490054 <sup>1</sup>	<b>Ref. No.</b>	0A2020
<b>description</b>	hot plate dimensions 300x300mm 2500W 230V with spill ring connection 4 screw clamps protector yes		

<sup>1</sup>incl. protector



1

<b>GEV No.</b>	490056 <sup>1</sup>	<b>Ref. No.</b>	052196 052198
<b>description</b>	hot plate dimensions 300x300mm 3000W 230V with spill ring connection 4 screw clamps protector yes square		

<sup>1</sup>incl. protector



1

<b>GEV No.</b>	490057 <sup>1</sup>	<b>Ref. No.</b>	OK4756
<b>description</b>	hot plate dimensions 300x300mm 3000W 400V with spill ring connection 4 screw clamps protector yes square		

<sup>1</sup>incl. protector



1

<b>GEV No.</b>	490071 <sup>1</sup>	<b>Ref. No.</b>	052199
<b>description</b>	hot plate dimensions 300x300mm 4000W 230V with spill ring connection 4 screw clamps protector yes square		

<sup>1</sup>incl. protector



1

<b>GEV No.</b>	490074 <sup>1</sup>	<b>Ref. No.</b>	052200
<b>description</b>	hot plate dimensions 300x300mm 4000W 400V with spill ring connection 4 screw clamps protector yes square		

<sup>1</sup>incl. protector

round

with radiused edge  
for domestic and commercial kitchens



1

<b>GEV No.</b>	490010	<b>Ref. No.</b>	058104
<b>description</b>	hot plate ø 145mm 1000W 230V connection 4 screw clamps with 8mm spill ring		



1

<b>GEV No.</b>	490012	<b>Ref. No.</b>	053406
<b>description</b>	hot plate ø 145mm 1500W 230V connection 4 screw clamps with 8mm spill ring		



1

<b>GEV No.</b>	490014	<b>Ref. No.</b>	0G6313
<b>description</b>	hot plate ø 180mm 1500W 230V connection 4 screw clamps with 8mm spill ring		

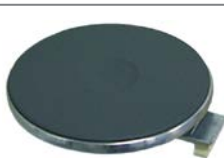

1

<b>GEV No.</b>	490015	<b>Ref. No.</b>	003930
<b>description</b>	hot plate ø 180mm 1500W 400V connection 4 screw clamps with 8mm spill ring		



1

<b>GEV No.</b>	490021	<b>Ref. No.</b>	003931
<b>description</b>	hot plate ø 220mm 2600W 400V connection 4 screw clamps with 8mm spill ring		



## energy regulators

### EGO

#### 1-circuit



1

<b>GEV No.</b>	380015	<b>Ref. No.</b>	0C1605
<b>description</b>	energy regulator 230V 13A single-circuit turn direction right shaft ø 6x4.6mm shaft L 23mm mounting thread M4 power release 6-100% no. 50.57021.010		

#### 2-circuit



1

<b>GEV No.</b>	380004	<b>Ref. No.</b>	059046
<b>description</b>	energy regulator 230V 13A dual circuit turn direction right shaft L 23mm no. 50.67021.590 with operation switch 2-pole		

## thermostats

### bi-metal thermostats

#### safety bi-metal thermostats



1

<b>GEV No.</b>	390199	<b>Ref. No.</b>	003329
<b>description</b>	bi-metal safety thermostat hole distance 24mm switch-off temp. 210°C 1NC 1-pole 16A connection F6.3		



1

<b>GEV No.</b>	390590	<b>Ref. No.</b>	0KK203
<b>description</b>	bi-metal safety thermostat hole distance 24mm switch-off temp.°C 1NC 1-poleAV connection plug 2 hole fixing		



1

<b>GEV No.</b>	390138	<b>Ref. No.</b>	048887
<b>description</b>	bi-metal safety thermostat hole distance mm switch-off temp. 112°C 1NC 1-pole 16A connection F6.3		

**accessories for** 390138

<b>GEV No.</b>	504736	<b>Ref. No.</b>	048987
----------------	--------	-----------------	--------



bracket for contact thermostat



bracket for contact thermostat mounting distance 24.5mm mounting ø 3.8



1

<b>GEV No.</b>	390526	<b>Ref. No.</b>	083113
<b>description</b>	bi-metal safety thermostat hole distance mm switch-off temp. 25°C 1NO 1-poleAV connection F6.3		

#### bi-metal thermostats



1

<b>GEV No.</b>	375666	<b>Ref. No.</b>	005203
<b>description</b>	bi-metal thermostat 1NO 1-pole 10A 250V connection F6.3 M4		



1

<b>GEV No.</b>	390101	<b>Ref. No.</b>	048487
<b>description</b>	bi-metal thermostat hole distance 38mm switch-off temp. 53°C 1CO 1-pole 16A connection F6.3 2 hole fixing		



1

<b>GEV No.</b>	390468	<b>Ref. No.</b>	048804
<b>description</b>	bi-metal thermostat hole distance 40mm switch-off temp. 60°C 1CO 1-pole 16A connection F6.3 2 hole fixing		

### control and safety thermostats

#### EGO

#### control thermostats

#### 55.10/19\_ series



1

<b>GEV No.</b>	375055	<b>Ref. No.</b>	0A2018
<b>description</b>	thermostat t.max. 110°C temperature range 30-110°C 1-pole 1CO 16A probe ø 6mm probe L 130mm capillary pipe 1500mm capillary pipe isolated mm gland nut shaft L 23mm shaft position upper rotation 318° 250V		



<b>GEV No.</b>	375488	<b>Ref. No.</b>	031480
<b>description</b>	thermostat t.max. 175°C temperature range 45-170°C 1-pole 1NO 16A probe ø 3mm probe L 219mm capillary pipe 900mm capillary pipe isolated 900mm gland nut shaft ø 6x4.6mm shaft L 23mm shaft position upper rotation 270° shaft flat upper		



<b>GEV No.</b>	375002	<b>Ref. No.</b>	004939
<b>description</b>	thermostat t.max. 320°C temperature range 55-320°C 1-pole 1NO 16A probe ø 3.1mm probe L 226mm capillary pipe 870mm capillary pipe isolated 850mm gland nut shaft L 23mm shaft position upper rotation 270°		



<b>GEV No.</b>	390156	<b>Ref. No.</b>	051360
<b>description</b>	thermostat t.max. 260°C temperature range 50-260°C 1-pole 1NO 16A probe ø 4mm probe L 115mm capillary pipe 1300mm capillary pipe isolated 1300mm gland nut shaft ø 6x4.6mm shaft L 23mm shaft position upper rotation 270°		



<b>GEV No.</b>	375661	<b>Ref. No.</b>	056701
<b>description</b>	thermostat t.max. 500°C temperature range 75-500°C 1-pole 1NO 16A probe ø 3.9mm probe L 228mm capillary pipe 1470mm capillary pipe isolated 960mm gland nut shaft ø 6x4.6mm shaft L 23mm shaft position upper rotation 270°		



<b>GEV No.</b>	375664	<b>Ref. No.</b>	054323
<b>description</b>	thermostat t.max. 287°C temperature range 60-287°C 1-pole 1NO 16A probe ø 3.1mm probe L 226mm capillary pipe 1470mm capillary pipe isolated 350mm gland nut shaft ø 6x4.6mm shaft L 23mm shaft position upper rotation 270°		

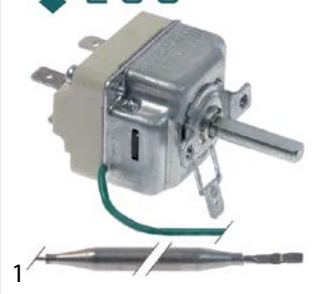

<b>GEV No.</b>	390040	<b>Ref. No.</b>	003262
<b>description</b>	thermostat t.max. 90°C temperature range 30-90°C 1-pole 1CO 16A probe ø 6mm probe L 130mm capillary pipe 2040mm capillary pipe isolated 1940mm gland nut shaft ø 6x4.6mm shaft L 23mm shaft position upper rotation 270° probe material SS		

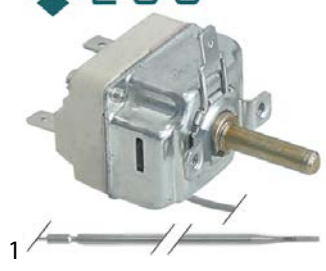

<b>GEV No.</b>	375667	<b>Ref. No.</b>	056384
<b>description</b>	thermostat t.max. 300°C temperature range 68-300°C 1-pole 1NO 16A probe ø 3.1mm probe L 226mm capillary pipe 980mm capillary pipe isolated 980mm gland nut shaft ø 6x4.6mm shaft L 23mm shaft position upper rotation 318°		

55.13\_series

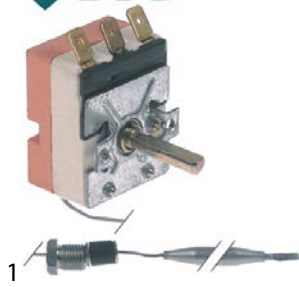

<b>GEV No.</b>	375871	<b>Ref. No.</b>	0E5032
<b>description</b>	thermostat t.max. 110°C temperature range 30-110°C 1-pole 1CO 16A probe ø 6mm probe L 113mm capillary pipe 2930mm capillary pipe isolatedmm gland nut M9x1 shaft ø 6x4.6mm shaft L 23mm shaft position upper rotation 270° H 40mm W 35mm D 30mm		



<b>GEV No.</b>	375492	<b>Ref. No.</b>	058163
<b>description</b>	thermostat t.max. 190°C temperature range 94-190°C 1-pole 1NO 16A probe ø 6mm probe L 94mm capillary pipe 1090mm capillary pipe isolated 960mm gland nut M10x1 shaft ø 6x4.6mm shaft L 23mm shaft position upper rotation 310° probe material SS		



<b>GEV No.</b>	390664	<b>Ref. No.</b>	0L2122
<b>description</b>	thermostat t.max. 83°C temperature range 29-83°C 1-pole 1CO 16A probe ø 6mm probe L 115mm capillary pipe 870mm capillary pipe isolatedmm gland nut shaft Lmm shaft position° shaft position rotation 260°		

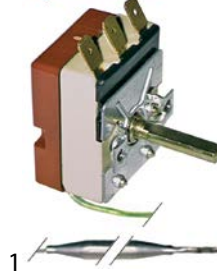

<b>GEV No.</b>	375006	<b>Ref. No.</b>	069422
<b>description</b>	thermostat t.max. 85°C temperature range 30-85°C 1-pole 1CO 16A probe ø 6mm probe L 92mm capillary pipe 3150mm capillary pipe isolated 300mm gland nut shaft L 23mm shaft position upper rotation 270° probe material SS		



<b>GEV No.</b>	390663	<b>Ref. No.</b>	049243
<b>description</b>	thermostat t.max. 91°C temperature range 29-91°C 1-pole 1CO 15A probe ø 6mm probe L 113mm capillary pipe 1470mm capillary pipe isolatedmm gland nut shaft Lmm rotation 260°		

55.17\_series

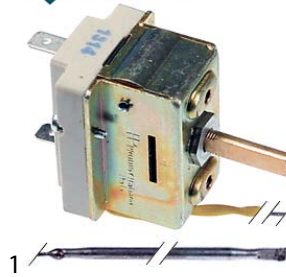

<b>GEV No.</b>	375665	<b>Ref. No.</b>	005207
<b>description</b>	thermostat t.max. 282°C temperature range 96-282°C 1-pole 1NO 16A probe ø 3.03mm probe L 196mm capillary pipe 1240mm capillary pipe isolated 350mm gland nut shaft ø 6x4.6mm shaft L 22mm shaft position left rotation 270°		

55.18\_series



<b>GEV No.</b>	375950	<b>Ref. No.</b>	0E3691 0KB677
<b>description</b>	thermostat t.max. 238°C temperature range 50-200°C 1-pole probe ø 3mm probe L 158mm capillary pipe 890mm capillary pipe isolated 760mm shaft ø 6x4.6mm shaft L 23mm shaft position upper rotation 270°		

55.34\_series

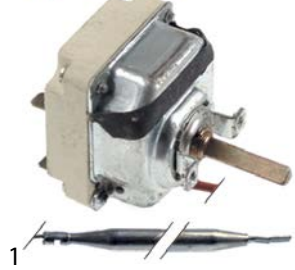

<b>GEV No.</b>	375671	<b>Ref. No.</b>	0A2237
<b>description</b>	thermostat t.max. 110°C temperature range 30-110°C 3-pole 3NO 16A probe ø 6mm probe L 131mm capillary pipe 1200mm capillary pipe isolated 600mm gland nut shaft ø 6x4.6mm shaft L 23mm shaft position upper rotation 318°		

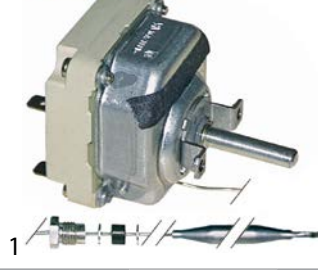

<b>GEV No.</b>	375143	<b>Ref. No.</b>	004911
<b>description</b>	thermostat t.max. 110°C temperature range 32-110°C 3-pole 3NO 16A probe ø 6mm probe L 138mm capillary pipe 1480mm capillary pipe isolated 1100mm gland nut M9x1 shaft ø 6x4.6mm shaft L 23mm shaft position upper rotation 270°		



<b>GEV No.</b>	375839	<b>Ref. No.</b>	051361
<b>description</b>	thermostat t.max. 185°C temperature range 60-185°C 3-pole 3NC 16A probe ø 4mm probe L 229mm capillary pipe 2600mm capillary pipe isolated 1000mm gland nut shaft ø 6x4.6mm shaft L 23mm shaft position upper rotation 270°		

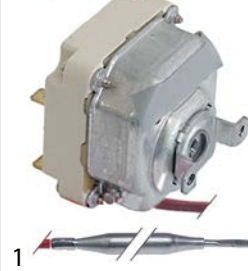

<b>GEV No.</b>	375675	<b>Ref. No.</b>	0C1000
<b>description</b>	thermostat t.max. 210°C temperature range fixed 210°C 2-pole 2NC 0.5A probe ø 6mm probe L 74mm capillary pipe 1250mm capillary pipe isolated 1100mm gland nut		

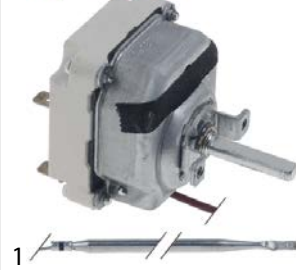

<b>GEV No.</b>	375559	<b>Ref. No.</b>	002402
<b>description</b>	thermostat t.max. 230°C temperature range 95-230°C 3-pole 3NO 16A probe ø 4mm probe L 128mm capillary pipe 1250mm capillary pipe isolated 1000mm gland nut shaft ø 6x4.6mm shaft L 23mm shaft position upper rotation 270°		

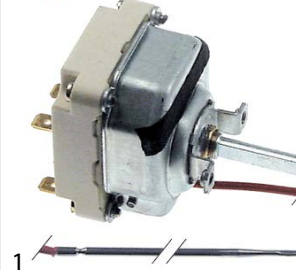

<b>GEV No.</b>	375587	<b>Ref. No.</b>	059235
<b>description</b>	thermostat t.max. 285°C temperature range 100-285°C 3-pole 3NO 16A probe ø 3mm probe L 219mm capillary pipe 1150mm capillary pipe isolated 1130mm gland nut shaft ø 6x4.6mm shaft L 23mm shaft position upper rotation 270°		





<b>GEV No.</b>	375574	<b>Ref. No.</b>	055996
<b>description</b>	thermostat t.max. 300°C temperature range 115-300°C 3-pole 3NO 16A probe ø 2.5mm probe L 322mm capillary pipe 1150mm capillary pipe isolated 1000mm gland nut shaft ø 6x4.6mm shaft L 23mm shaft position upper rotation 270°		



<b>GEV No.</b>	375565	<b>Ref. No.</b>	0C0270
<b>description</b>	thermostat t.max. 350°C temperature range fixed 350°C 3-pole 3NC 16A probe ø 3mm probe L 190mm capillary pipe 900mm capillary pipe isolated 900mm gland nut shaft Lmm		



<b>GEV No.</b>	375038	<b>Ref. No.</b>	0H6217
<b>description</b>	thermostat t.max. 300°C temperature range 50-300°C 3-pole 3NO 16A probe ø 6mm probe L 79mm capillary pipe 1740mm capillary pipe isolated 800mm gland nut shaft ø 6x4.6mm shaft L 23mm shaft position upper rotation 270°		
<b>accessories for</b>	375038		
		<b>GEV No.</b>	110123
		<b>Ref. No.</b>	—
	knob thermostat t.max. 300°C ø 50mm shaft ø 6x4.6mm shaft flat upper black temperature range 50-300°C rotation 270°		



<b>GEV No.</b>	375210	<b>Ref. No.</b>	049191
<b>description</b>	thermostat t.max. 90°C temperature range 38-90°C 3-pole 3CO 16A probe ø 6mm probe L 215mm capillary pipe 900mm capillary pipe isolated 900mm gland nut shaft Lmm rotation 270°		



<b>GEV No.</b>	375412	<b>Ref. No.</b>	0A2206
<b>description</b>	thermostat t.max. 320°C temperature range 50-320°C 3-pole 3NO 16A probe ø 3.1mm probe L 226mm capillary pipe 1480mm capillary pipe isolated 1400mm gland nut shaft ø 6x4.6mm shaft L 23mm shaft position upper rotation 318°		



<b>GEV No.</b>	375411	<b>Ref. No.</b>	052000
<b>description</b>	thermostat t.max. 93°C temperature range 30-93°C 3-pole 3NO 16A probe ø 6mm probe L 129mm capillary pipe 1480mm capillary pipe isolated 1100mm gland nut M10x1 shaft ø 6x4.6mm shaft L 23mm shaft position upper rotation 270°		

safety thermostats

55.10/19\_series

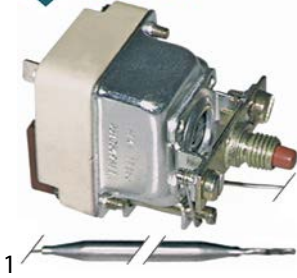

<b>GEV No.</b>	390062	<b>Ref. No.</b>	0A2011
<b>description</b>	safety thermostat switch-off temp. 235°C 1-pole 0.5A probe ø 6mm probe L 130mm capillary pipe 1800mm capillary pipe isolated 1500mm gland nut M9x1 probe SS		

<b>accessories for</b>	390062		
	GEV No.	551083	Ref. No.
			—
	cap for safety thermostat thread M8x1		

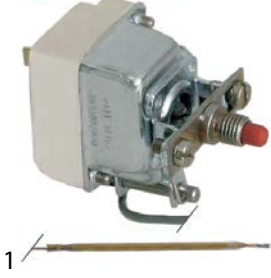

<b>GEV No.</b>	375191	<b>Ref. No.</b>	004108
<b>description</b>	safety thermostat switch-off temp. 500°C 1-pole 16A probe ø 3.9mm probe L 230mm capillary pipe 870mm capillary pipe isolated 660mm gland nut probe		

55.11\_series

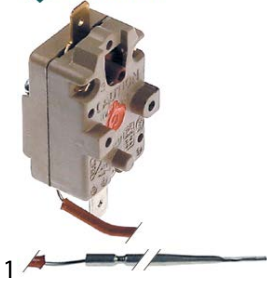

<b>GEV No.</b>	375767	<b>Ref. No.</b>	031482
<b>description</b>	safety thermostat switch-off temp. 170°C 1-pole 16A probe ø 3.1mm probe L 160mm capillary pipe 650mm capillary pipe isolated 600mm gland nut probe		

55.13\_series



<b>GEV No.</b>	375854	<b>Ref. No.</b>	0E5086
<b>description</b>	safety thermostat switch-off temp. 126°C 1-pole 16A probe ø 6mm probe L 129mm capillary pipe 1730mm capillary pipe isolated 800mm gland nut M9x1 shaft ø 6x4.6mm starting temperature 120°C probe		

55.31\_series



<b>GEV No.</b>	390165	<b>Ref. No.</b>	051644
<b>description</b>	safety thermostat switch-off temp. 140°C 3-pole 20A probe ø 6mm probe L 173mm capillary pipe 830mm capillary pipe isolated 800mm gland nut probe SS		

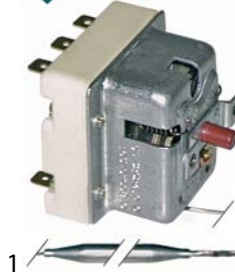

<b>GEV No.</b>	390045	<b>Ref. No.</b>	051637
<b>description</b>	safety thermostat switch-off temp. 160°C 3-pole 0.5A probe ø 6mm probe L 173mm capillary pipe 830mm capillary pipe isolated 800mm gland nut probe SS		



<b>GEV No.</b>	375573	<b>Ref. No.</b>	059552
<b>description</b>	safety thermostat switch-off temp. 225°C 3-pole 20A probe ø 6mm probe L 157mm capillary pipe 940mm capillary pipe isolated 800mm gland nut probe SS		



<b>GEV No.</b>	375588	<b>Ref. No.</b>	053183
<b>description</b>	safety thermostat switch-off temp. 285°C 3-pole 1x20/2x0.5A probe ø 6mm probe L 157mm capillary pipe 940mm capillary pipe isolated 940mm gland nut probe		



<b>GEV No.</b>	375108	<b>Ref. No.</b>	052331
<b>description</b>	safety thermostat switch-off temp. 250°C 3-pole 1x20/2x0.5A probe ø 6mm probe L 157mm capillary pipe 1230mm capillary pipe isolated 800mm gland nut probe SS		



<b>GEV No.</b>	375571	<b>Ref. No.</b>	051454
<b>description</b>	safety thermostat switch-off temp. 350°C 3-pole 20A probe ø 6mm probe L 157mm capillary pipe 940mm capillary pipe isolated 890mm gland nut probe SS		



<b>GEV No.</b>	390087	<b>Ref. No.</b>	051369
<b>description</b>	safety thermostat switch-off temp. 250°C 3-pole 20A probe ø 6mm probe L 239mm capillary pipe 2530mm capillary pipe isolated 1600/210/375mm gland nut probe SS		



<b>GEV No.</b>	375377	<b>Ref. No.</b>	051643
<b>description</b>	safety thermostat switch-off temp. 350°C 3-pole 3NC 1x20/2x0.5A probe ø 6mm probe L 157mm capillary pipe 1230mm capillary pipe isolated 1100mm gland nut probe		



<b>GEV No.</b>	375641	<b>Ref. No.</b>	054932
<b>description</b>	safety thermostat switch-off temp. 250°C 3-pole 20A probe ø 6mm probe L 239mm capillary pipe 2530mm capillary pipe isolated 1600/210mm gland nut probe SS		

55.32\_ series



<b>GEV No.</b>	390167	<b>Ref. No.</b>	059079
<b>description</b>	safety thermostat switch-off temp. 140°C 3-pole capillary pipe isolatedmm gland nut		



<b>GEV No.</b>	375170	<b>Ref. No.</b>	002711
<b>description</b>	safety thermostat switch-off temp. 150°C 1-pole 20A probe ø 6mm probe L 74mm capillary pipe 1700mm capillary pipe isolated 1100mm gland nut probe		



<b>GEV No.</b>	375586	<b>Ref. No.</b>	0A5435
<b>description</b>	safety thermostat switch-off temp. 245°C 1-pole 0.5A probe ø 6mm probe L 77mm capillary pipe 1290mm capillary pipe isolated 1100mm gland nut probe SS		



<b>GEV No.</b>	375657	<b>Ref. No.</b>	0C1147
<b>description</b>	safety thermostat switch-off temp. 150°C 2-pole 1x20/1x0.5A probe ø 6mm probe L 74mm capillary pipe 1700mm capillary pipe isolated 1100mm gland nut probe SS		



<b>GEV No.</b>	375585	<b>Ref. No.</b>	006282
<b>description</b>	safety thermostat switch-off temp. 245°C 3-pole 0.5A probe ø 6mm probe L 79mm capillary pipe 900mm capillary pipe isolated 900mm gland nut probe SS		



<b>GEV No.</b>	375577	<b>Ref. No.</b>	005295
<b>description</b>	safety thermostat switch-off temp. 170°C 3-pole 0.5A probe ø 6mm probe L 87mm capillary pipe 900mm capillary pipe isolated 800mm gland nut probe		



<b>GEV No.</b>	375578	<b>Ref. No.</b>	004472
<b>description</b>	safety thermostat switch-off temp. 245°C 3-pole 20A probe ø 6mm probe L 87mm capillary pipe 2700mm capillary pipe isolated 1600mm gland nut probe SS		

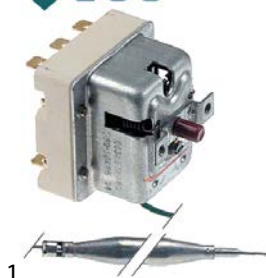

<b>GEV No.</b>	375558	<b>Ref. No.</b>	004742
<b>description</b>	safety thermostat switch-off temp. 170°C 3-pole 20A probe ø 6mm probe L 87mm capillary pipe 900mm capillary pipe isolated 800mm gland nut probe SS		



<b>GEV No.</b>	375580	<b>Ref. No.</b>	005941
<b>description</b>	safety thermostat switch-off temp. 250°C 3-pole 20A probe ø 6mm probe L 89mm capillary pipe 900mm capillary pipe isolated 900mm gland nut probe SS		



1 

<b>GEV No.</b>	375557	<b>Ref. No.</b>	006307
<b>description</b>	safety thermostat switch-off temp. 270°C 3-pole 20A probe ø 6mm probe L 79mm capillary pipe 900mm capillary pipe isolated 900mm gland nut probe SS		



1 

<b>GEV No.</b>	375579	<b>Ref. No.</b>	003594 053980
<b>description</b>	safety thermostat switch-off temp. 360°C 1-pole 0.5A probe ø 6mm probe L 74mm capillary pipe 1500mm capillary pipe isolated 1500mm gland nut probe		



1 

<b>GEV No.</b>	375659	<b>Ref. No.</b>	007042
<b>description</b>	safety thermostat switch-off temp. 338°C 2-pole 1x20/1x0.5A probe ø 6mm probe L 53mm capillary pipe 900mm capillary pipe isolated 900mm gland nut probe screw-in probe probe thread M10x1		



1 

<b>GEV No.</b>	375563	<b>Ref. No.</b>	004600
<b>description</b>	safety thermostat switch-off temp. 360°C 3-pole 1x20/2x0.5A probe ø 6mm probe L 79mm capillary pipe 1200mm capillary pipe isolated 1200mm gland nut probe SS		



1 

<b>GEV No.</b>	375789	<b>Ref. No.</b>	005680
<b>description</b>	safety thermostat switch-off temp. 338°C 2-pole 20A probe ø 11mm probe L 16mm capillary pipe 900mm capillary pipe isolated 900mm gland nut screw-in probe probe thread M14x1		



1 

<b>GEV No.</b>	390142	<b>Ref. No.</b>	004919
<b>description</b>	safety thermostat switch-off temp. 360°C 3-pole 20A probe ø 3.1mm probe L 188mm capillary pipe 1490mm capillary pipe isolated 800mm gland nut probe SS		



1 

<b>GEV No.</b>	375455	<b>Ref. No.</b>	002730
<b>description</b>	safety thermostat switch-off temp. 350°C 1-pole 16A probe ø 11mm probe L 16mm capillary pipe 900mm capillary pipe isolated 900mm gland nut probe screw-in probe probe thread M14x1		



1 

<b>GEV No.</b>	375562	<b>Ref. No.</b>	004269
<b>description</b>	safety thermostat switch-off temp. 360°C 3-pole 20A probe ø 4mm probe L 120mm capillary pipe 900mm capillary pipe isolated 900mm gland nut probe SS		



control thermostats with operation switch

55.10/19\_ series

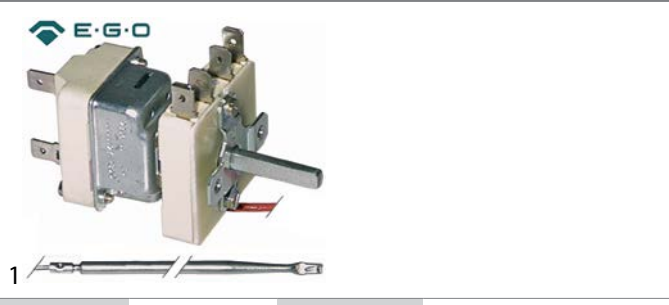

<b>GEV No.</b>	390052	<b>Ref. No.</b>	052330
<b>description</b>	thermostat t.max. 185°C temperature range 90-185°C 1-pole 1NO 15A probe ø 4mm probe L 229mm capillary pipe 2500mm capillary pipe isolated 1200/200mm gland nut shaft ø 6x4.6mm shaft L 23mm shaft position upper° rotation 270° outer switch 2NO		

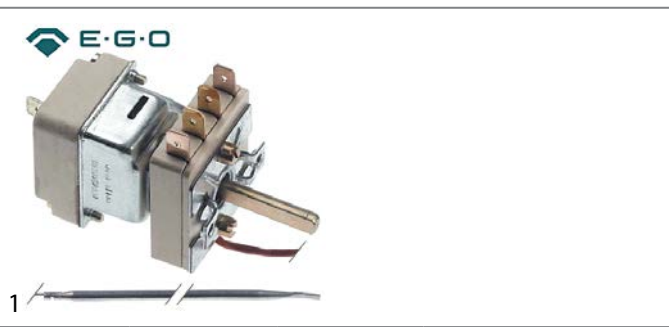

<b>GEV No.</b>	375581	<b>Ref. No.</b>	002109
<b>description</b>	thermostat t.max. 260°C temperature range 55-260°C 1-pole 1NO 16A probe ø 4mm probe L 116mm capillary pipe 1300mm capillary pipe isolated 1300mm gland nut shaft ø 6x4.6mm shaft L 23mm shaft position upper rotation 270° outer switch 2NO		

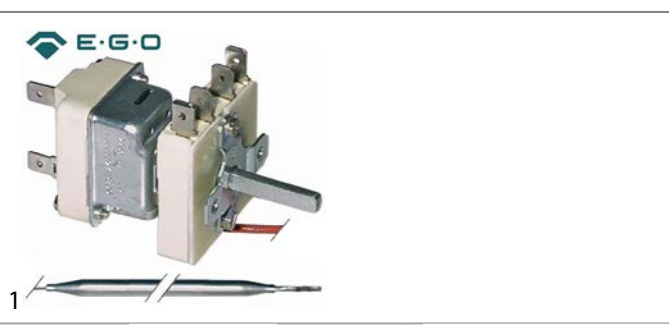



<b>GEV No.</b>	390039	<b>Ref. No.</b>	051142
<b>description</b>	thermostat t.max. 90°C temperature range 30-90°C 1-pole 1CO 16A probe ø 6mm probe L 173mm capillary pipe 980mm capillary pipe isolated 980mm gland nut shaft ø 6x4.6mm shaft L 23mm shaft position upper rotation 270° outer switch 2NO		
<b>accessories for</b>	390039		
	<b>GEV No.</b>	111934	<b>Ref. No.</b> —
	knob thermostat t.max. 90°C ø 50mm shaft ø 6x4.6mm shaft flat upper black temperature range 30-90°C rotation 270°		

IMIT / TEMPOMATIC / ARTERMO

control thermostats



<b>GEV No.</b>	390005	<b>Ref. No.</b>	069423
<b>description</b>	thermostat t.max. 85°C temperature range 25-85°C 1-pole 1CO 15A probe ø 11mm probe L 35mm capillary pipe 600mm capillary pipe isolated 600mm gland nut shaft ø 6x4.6mm shaft L 8mm shaft position upper° rotation 270° screw-in probe		
<b>accessories for</b>	390005		
	<b>GEV No.</b>	510417	<b>Ref. No.</b> —
	flat gasket fibre ED ø 20mm ID ø 14mm thickness 2mm Qty 1 pcs		
	<b>GEV No.</b>	550261	<b>Ref. No.</b> —
	nut thread M14x1 H 4mm WS 19 SS Qty 1 pcs		

refrigeration thermostats

universal without housing

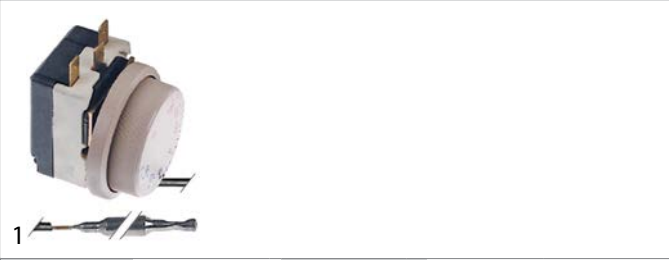

<b>GEV No.</b>	390534	<b>Ref. No.</b>	0A8246
<b>description</b>	thermostat temperature range -35 up to +35°C probe ø 6x110mm capillary pipe 1800mm PRODIGY		
<b>accessories for</b>	390534		
	<b>GEV No.</b>	110305	<b>Ref. No.</b> —
	knob thermostat t.max. 35°C temperature range -35 up to +35°C ø 45mm shaft ø 6x4.6mm shaft flat inclined rotation 270° white		

RANCO

K22 series

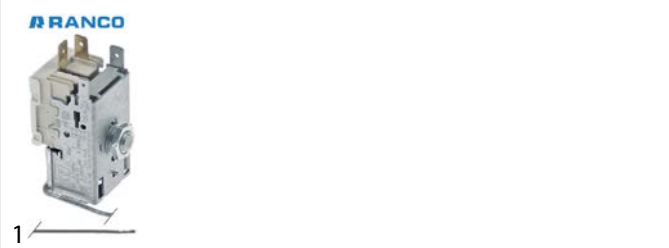

<b>GEV No.</b>	390539	<b>Ref. No.</b>	0A8963
<b>description</b>	thermostat RANCO type K22L3521 probe ømm probe Lmm capillary pipe 2000mm temperature range -2 up to +8°C		

**RANCO**



1

<b>GEV No.</b>	390223	<b>Ref. No.</b>	083697
<b>description</b>	thermostat RANCO type K22L2560 capillary pipe 2000mm probe $\varnothing$ 10x110mm		

**K50 series**

**RANCO**



1

<b>GEV No.</b>	390224	<b>Ref. No.</b>	0A8728
<b>description</b>	thermostat RANCO type K50L3199 capillary pipe 2000mm		

**RANCO**



1

<b>GEV No.</b>	390255	<b>Ref. No.</b>	083520
<b>description</b>	thermostat RANCO type K50P1115/012 capillary pipe 2000mm temperature range +1.5 up to +11°C		

**K52 series**

**RANCO**

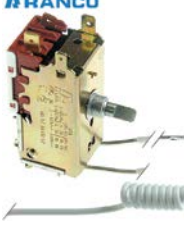

1

<b>GEV No.</b>	390214	<b>Ref. No.</b>	0A8653
<b>description</b>	thermostat RANCO type K52L4512 probe $\varnothing$ 11mm probe L 30mm capillary pipe 2100mm temperature range -6.4 up to +3.2°C		

**K55 series**

**RANCO**



1

<b>GEV No.</b>	390259	<b>Ref. No.</b>	082025
<b>description</b>	thermostat RANCO type K55L5026 probe $\varnothing$ mm probe Lmm capillary pipe 2000mm temperature range +0.5 up to +8.0°C		

**RANCO**



1

<b>GEV No.</b>	390251	<b>Ref. No.</b>	081689
<b>description</b>	thermostat RANCO type K55L5027 capillary pipe 2000mm temperature range -1.4 up to +5.4°C		

**RANCO**



1

<b>GEV No.</b>	390248	<b>Ref. No.</b>	083135
<b>description</b>	thermostat RANCO type K55L5079 capillary pipe 2000mm temperature range +2 up to +10°C		

**RANCO**



1

<b>GEV No.</b>	390217	<b>Ref. No.</b>	083147
<b>description</b>	thermostat RANCO type K55L5080 probe $\varnothing$ mm probe Lmm capillary pipe 2000mm temperature range -3 up to +10°C		

**RANCO**



1

<b>GEV No.</b>	390542	<b>Ref. No.</b>	087516
<b>description</b>	thermostat RANCO type K55P5851 probe $\varnothing$ 2mm probe Lmm capillary pipe 2500mm		

K61 series



<b>GEV No.</b>	390586	<b>Ref. No.</b>	086288
<b>description</b>	thermostat RANCO type K61L1504 probe ø 2mm probe Lmm capillary pipe 1800mm T war 11.5°C T cold 22°C		

accessories

fitting parts



<b>GEV No.</b>	504736	<b>Ref. No.</b>	048987
<b>description</b>	bracket for contact thermostat		

probe clips

clamps

for thermostat



<b>GEV No.</b>	550403	<b>Ref. No.</b>	056330
<b>description</b>	probe clip for pipe ø 8.5mm for probe ø 6mm Qty 1 pcs		



<b>GEV No.</b>	550401	<b>Ref. No.</b>	066823
<b>description</b>	probe clip for pipe ø 9mm for probe ø 6mm Qty 1 pcs		

spring clips

for safety thermostat



<b>GEV No.</b>	550005	<b>Ref. No.</b>	0H6907
<b>description</b>	probe clip for pipe ø 17x6mm for probe ø 6mm Qty 1 pcs for flat tube heating element		



<b>GEV No.</b>	550539	<b>Ref. No.</b>	004923
<b>description</b>	probe clip for pipe ø 8.5mm for probe ø 4mm Qty 1 pcs		

miscellaneous



<b>GEV No.</b>	504757	<b>Ref. No.</b>	0L0280
<b>description</b>	screw connection ID ø 10mm for probe		

capillary tube clips



<b>GEV No.</b>	550004	<b>Ref. No.</b>	0H6906
<b>description</b>	capillary tube clip for pipe ø 17x6mm for flat tube heating element		



<b>GEV No.</b>	550138	<b>Ref. No.</b>	052262
<b>description</b>	capillary tube clip for pipe ø 8.5mm for circular tube heating elements		

gland nut accessories

locking screws



<b>GEV No.</b>	504738	<b>Ref. No.</b>	067899
<b>description</b>	screw connection for probe thread M12x1 ID ø 6.3mm L 18mm		
<b>accessories for</b>	504738		



<b>GEV No.</b>	528485	<b>Ref. No.</b>	067898
<b>description</b>	O-ring EPDM thickness 1.78mm ID ø 6.07mm Qty 1 pcs		



<b>GEV No.</b>	550926	<b>Ref. No.</b>	059295
<b>description</b>	union screw thread M12x1 probe ø max. 4mm SS		



<b>GEV No.</b>	550925	<b>Ref. No.</b>	002076
<b>description</b>	union screw thread M12x1 probe ø max. 6mm SS		





connecting bows



1

<b>GEV No.</b>	550060	<b>Ref. No.</b>	054376
<b>description</b>	connecting bow long for thermostat Qty 1 pcs		



1

<b>GEV No.</b>	550059	<b>Ref. No.</b>	0A2205
<b>description</b>	connecting bow short for switch Qty 1 pcs		

switches and momentary switches

rocker/momentary rocker switches

27.8x25mm



1

<b>GEV No.</b>	347656 <sup>1</sup>	<b>Ref. No.</b>	085987
<b>description</b>	rocker switch mounting measurements 27.8x25mm green 2NO 250V 16A illuminated 0-I connection male faston 6.3mm		

<sup>1</sup>illuminated

30x22mm



1

<b>GEV No.</b>	301009	<b>Ref. No.</b>	082390
<b>description</b>	rocker switch mounting measurements 30x22mm white 2NO 250V 16A illuminated 0-I connection male faston 6.3mm ambient temperature max. 125/55°C protection IP65		
<b>accessories for</b>	301009		
	<b>GEV No.</b>	<b>Ref. No.</b>	002150
	protective cover internal size 30x22mm for rocker switch mounting measurementsmm		





1

<b>GEV No.</b>	301036	<b>Ref. No.</b>	002150
<b>description</b>	protective cover internal size 30x22mm for rocker switch mounting measurementsmm		



1

<b>GEV No.</b>	345711	<b>Ref. No.</b>	082473
<b>description</b>	rocker switch mounting measurements 30x22mm white 2CO 250V 16A I-II connection male faston 6.3mm ambient temperature max. 100/55°C protection IP40		
<b>accessories for</b>	345711		
	<b>GEV No.</b>	<b>Ref. No.</b>	002150
	protective cover internal size 30x22mm for rocker switch mounting measurementsmm		



1

<b>GEV No.</b>	345714	<b>Ref. No.</b>	082486
<b>description</b>	rocker switch mounting measurements 30x22mm green 2NO 250V 16A illuminated refrigeration connection male faston 6.3mm ambient temperature max. 85°C protection IP40		

blank





1

<b>GEV No.</b>	345390	<b>Ref. No.</b>	054547
<b>description</b>	momentary rocker switch mounting measurements 30x22mm red 1NC 230V 16A illuminated connection male faston 6.3mm ambient temperature max. 125/55°C protection IP65 with cover cap		
<b>accessories for</b>	345390		
	<b>GEV No.</b>	<b>Ref. No.</b>	002150
	protective cover internal size 30x22mm for rocker switch mounting measurementsmm		



1

<b>GEV No.</b>	346297	<b>Ref. No.</b>	056880
<b>description</b>	rocker switch mounting measurements 30x22mm orange 2NO 230V 16A illuminated connection male faston 6.3mm ambient temperature max. 125/55°C protection IP65		
<b>accessories for</b>	346297		
	<b>GEV No.</b>	<b>Ref. No.</b>	002150
	protective cover internal size 30x22mm for rocker switch mounting measurementsmm		



1

<b>GEV No.</b>	346298	<b>Ref. No.</b>	056879
<b>description</b>	rocker switch mounting measurements 30x22mm yellow 2NO 230V 16A illuminated II connection male faston 6.3mm ambient temperature max. 125/55°C protection IP65 with cover cap		
<b>accessories for</b>	346298		
	<b>GEV No.</b>	<b>Ref. No.</b>	002150
	protective cover internal size 30x22mm for rocker switch mounting measurementsmm		



labelled



1

<b>GEV No.</b>	300125	<b>Ref. No.</b>	053810
<b>description</b>	rocker switch mounting measurements 30x22mm green 2NO 230V 16A 0-I connection male faston 6.3mm ambient temperature max. 125/55°C protection IP65 with cover cap		
<b>accessories for</b>	300125		
	<b>GEV No.</b>	301036	<b>Ref. No.</b> 002150
	protective cover internal size 30x22mm for rocker switch mounting measurementsmm		

with symbol



1

<b>GEV No.</b>	346385	<b>Ref. No.</b>	054552
<b>description</b>	rocker switch mounting measurements 30x22mm green 2CO 230V 16A illuminated fan connection male faston 6.3mm ambient temperature max. 125/55°C protection IP65 with cover cap		
<b>accessories for</b>	346385		
	<b>GEV No.</b>	301036	<b>Ref. No.</b> 002150
	protective cover internal size 30x22mm for rocker switch mounting measurementsmm		



1

<b>GEV No.</b>	346386	<b>Ref. No.</b>	058808
<b>description</b>	rocker switch mounting measurements 30x22mm green 2CO 250V 16A illuminated I-II connection male faston 6.3mm ambient temperature max. 85°C protection IP65 with cover cap		
<b>accessories for</b>	346386		
	<b>GEV No.</b>	301036	<b>Ref. No.</b> 002150
	protective cover internal size 30x22mm for rocker switch mounting measurementsmm		



1

<b>GEV No.</b>	346384	<b>Ref. No.</b>	053837
<b>description</b>	rocker switch mounting measurements 30x22mm green 2NO 250V 16A illuminated I-II connection male faston 6.3mm ambient temperature max. 125/55°C protection IP65 with cover cap		
<b>accessories for</b>	346384		
	<b>GEV No.</b>	301036	<b>Ref. No.</b> 002150
	protective cover internal size 30x22mm for rocker switch mounting measurementsmm		



1

<b>GEV No.</b>	345713	<b>Ref. No.</b>	082391
<b>description</b>	rocker switch mounting measurements 30x22mm white/yellow 1NO/NO 250V 16A illuminated lighting, I-II connection male faston 6.3mm ambient temperature max. 100/55°C protection IP40		

## push/momentary push switches

## 30x22mm



1

<b>GEV No.</b>	301036	<b>Ref. No.</b>	002150
<b>description</b>	protective cover internal size 30x22mm for rocker switch mounting measurementsmm		

## ø16mm



1

<b>GEV No.</b>	346287 <sup>1</sup>	<b>Ref. No.</b>	002418
<b>description</b>	momentary push switch mounting ø 16mm red 1NO 250V 3A illuminated connection male faston 2.8mm ambient temperature max. 125/55°C protection IP65 with cover cap		

<sup>1</sup>illuminated

## ø25mm



1

<b>GEV No.</b>	345038	<b>Ref. No.</b>	053978
<b>description</b>	momentary push switch mounting ø 25mm black 2NO 250V 16A connection male faston 6.3mm ambient temperature max. 85°C protection IP40		





1

<b>GEV No.</b>	345161 <sup>1</sup>	<b>Ref. No.</b>	054518
<b>description</b>	push switch mounting ø 25mm green 2NO 250V 16A illuminated connection male faston 6.3mm ambient temperature max. 85°C protection IP40		

<sup>1</sup>illuminated



 <p>1</p>			
<b>GEV No.</b>	345715	<b>Ref. No.</b>	082328
<b>description</b>	push switch mounting $\varnothing$ 25mm white 2NO 250V 16A illuminated connection male faston 6.3mm ambient temperature max. 85°C protection IP40		

 <p>1</p>			
<b>GEV No.</b>	345039	<b>Ref. No.</b>	053979
<b>description</b>	protective cover round ED $\varnothing$ 33mm external size 23mm internal size 21mm H 12mm clear mounting $\varnothing$ 25mm		
<b>accessories for</b>	345039		
	<b>GEV No.</b>	345001	<b>Ref. No.</b>
			—
	 <p>momentary push switch mounting <math>\varnothing</math> 25mm yellow 1NO/indicator light 250V 16A cover connection male faston 6.3mm ambient temperature max. 85°C protection IP65</p>		

<h3>2 hole fixing</h3>			
 <p>1</p>			
<b>GEV No.</b>	345021	<b>Ref. No.</b>	046348
<b>description</b>	momentary push switch 2NO		

 <p>Image not available</p> <p>1</p>			
<b>GEV No.</b>	345999	<b>Ref. No.</b>	045165
<b>description</b>	push switch 2NO 250V 16A connection male faston 6.3mm protection IP40		

<h3>accessories</h3>			
<h4>fitting parts</h4>			
 <p>1</p>			
<b>GEV No.</b>	345998	<b>Ref. No.</b>	048575
<b>description</b>	fixing plate		

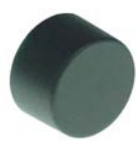
<h3>push buttons</h3>			
 <p>1</p>			
<b>GEV No.</b>	346311	<b>Ref. No.</b>	003768
<b>description</b>	push button		

 <p>1</p>			
<b>GEV No.</b>	345729	<b>Ref. No.</b>	083049
<b>description</b>	push button external size 23x23mm black		

<h3>element holders</h3>			
 <p>1</p>			
<b>GEV No.</b>	346310	<b>Ref. No.</b>	003767
<b>description</b>	element holder $\varnothing$ 24mm		

<h3>microswitches</h3>			
<h4>lever actuated</h4>			
 <p>1</p>			
<b>GEV No.</b>	345102	<b>Ref. No.</b>	0A8015
<b>description</b>	microswitch with lever 1NO connection cable		

 <p>1</p>			
<b>GEV No.</b>	346362	<b>Ref. No.</b>	0K2976
<b>description</b>	microswitch with lever connection cable		

 <p>1</p>			
<b>GEV No.</b>	346927	<b>Ref. No.</b>	0HA094
<b>description</b>	microswitch with lever 250V 10A 2CO connection male faston 6.3mm Lmm ambient temperature max. 125°C mounting distance 22mm double type VRSR01DA1 actuating force: 220g		





			
1			
<b>GEV No.</b>	345254	<b>Ref. No.</b>	046286
<b>description</b>	microswitch with lever 250V 16A 1CO connection male faston 6.3mm ambient temperature max. 120°C mounting distance 22mm actuating force: 60g lever length 58mm		

			
1			
<b>GEV No.</b>	345257	<b>Ref. No.</b>	069484
<b>description</b>	microswitch with lever 250V 16A 1CO connection male faston 6.3mm L 29mm L1 33mm ambient temperature max. 120°C mounting distance 22mm actuating force: 130g lever length 31.5mm		

			
1			
<b>GEV No.</b>	345107	<b>Ref. No.</b>	047485
<b>description</b>	microswitch with lever 250V 16A 1CO connection male faston 6.3mm L 98mm ambient temperature max. 125°C mounting distance 22mm actuating force: 30g lever length 90mm		

			
1			
<b>GEV No.</b>	346072	<b>Ref. No.</b>	0E0209
<b>description</b>	microswitch with lever 250V 6A 1CO connection male faston 6.3mm ambient temperature max. 85°C lever length 71mm		

			
1			
<b>GEV No.</b>	347007	<b>Ref. No.</b>	046322
<b>description</b>	microswitch with lever 250V 16A 1NO connection male faston 6.3mm ambient temperature max. 85°C lever length 55mm		

roller-lever actuated			
heavy duty version			
			
1			
<b>GEV No.</b>	346979	<b>Ref. No.</b>	0L1942
<b>description</b>	microswitch with handle with a switch 250V 5A 1CO connection male faston 6.3mm L 25mm L1 49mm ambient temperature max. 85°C mounting distance 22mm type MF45 actuating force: 150g lever length 25mm		

non-standard			
			
1			
<b>GEV No.</b>	347008	<b>Ref. No.</b>	0E5629
<b>description</b>	microswitch with handle with a switch 250V 5A 1CO connection cable ambient temperature max. 85°C lever length 20mm		

pin-plunger actuated			
M10			
			
1			
<b>GEV No.</b>	345032	<b>Ref. No.</b>	0K1395
<b>description</b>	microswitch with plunger thread M10x1 thread L 12mm 250V 16A 1CO connection male faston 6.3mm stroke 7mm mounting distance 22mm L 28mm ambient temperature max. 125°C type SP9603 actuating force: 180g		

			
1			
<b>GEV No.</b>	347004	<b>Ref. No.</b>	087151
<b>description</b>	microswitch with plunger thread M10x1 thread L 16mm 250V 10A 1NO connection male faston 6.3mm stroke 8mm mounting distance 22mm ambient temperature max. 85°C actuating force: 160g		

with push button			
switches with snap-fit			
			
1			
<b>GEV No.</b>	345249	<b>Ref. No.</b>	084403
<b>description</b>	microswitch with push button 250V 0.25A 1NO connection male faston 6.3mm L 26x12mm ambient temperature max. 85°C actuating force: 500g		

			
1			
<b>GEV No.</b>	346772	<b>Ref. No.</b>	087485
<b>description</b>	microswitch with push button 250V 5A 1CO connection male faston 4.8mm L 24x27mm ambient temperature max. 85°C actuating force: 160g		



non-standard



1			
<b>GEV No.</b>	345777	<b>Ref. No.</b>	004288
<b>description</b>	microswitch		



1			
<b>GEV No.</b>	301207	<b>Ref. No.</b>	004241
<b>description</b>	microswitch operation switch mounting distance 24mm 250V 0.5A NO connection male faston 4.8mm type 209 actuating force: 400g		



1			
<b>GEV No.</b>	345724	<b>Ref. No.</b>	082919
<b>description</b>	cap size 23x23mm black MIN/MED/MAX		



1			
<b>GEV No.</b>	345604	<b>Ref. No.</b>	083047
<b>description</b>	element holder single mounting measurements 28.5x28.5mm black for push buttons 23x23mm		

position switches

PIZZATO

FR series



1			
<b>GEV No.</b>	345144	<b>Ref. No.</b>	046884
<b>description</b>	position switch plastic 1NC/1NO 400V 3A L 92mm W 31mm H 31mm protection IP67 actuating force: 360g screw connection PG13.5 mounting distance 22mm screw		



1			
<b>GEV No.</b>	345603	<b>Ref. No.</b>	083048
<b>description</b>	element holder triple mounting measurements 28.5x77.5mm black for push buttons 23x23mm		

TELEMECANIQUE (EFA)



1			
<b>GEV No.</b>	345823	<b>Ref. No.</b>	048159
<b>description</b>	position switch		



1			
<b>GEV No.</b>	345601	<b>Ref. No.</b>	0A8268
<b>description</b>	indicator lamp holder V ø 11mm		

system switches (ROLD)



1			
<b>GEV No.</b>	345723	<b>Ref. No.</b>	082916
<b>description</b>	adjusting screw		



1			
<b>GEV No.</b>	345733	<b>Ref. No.</b>	0A8267
<b>description</b>	indicator light lens yellow defrosting		



1			
<b>GEV No.</b>	345721	<b>Ref. No.</b>	083050
<b>description</b>	blank cap holder		



1			
<b>GEV No.</b>	345832	<b>Ref. No.</b>	049068
<b>description</b>	momentary switch unit 1CO 250V 16A connection male faston 6.3mm		



1

<b>GEV No.</b>	345825	<b>Ref. No.</b>	049315
<b>description</b>	momentary switch unit 1NO 250V 16A connection male faston 6.3mm		



1

<b>GEV No.</b>	345734	<b>Ref. No.</b>	0A8264
<b>description</b>	push button 230V green illuminated ømm		



1

<b>GEV No.</b>	345739	<b>Ref. No.</b>	083202
<b>description</b>	push button L 25mm W 19.5mm black		



1

<b>GEV No.</b>	345737	<b>Ref. No.</b>	083200
<b>description</b>	push button L 25mm W 19.5mm black 0-1		



1

<b>GEV No.</b>	345740	<b>Ref. No.</b>	083209
<b>description</b>	push button L 25mm W 19.5mm black light		



1

<b>GEV No.</b>	345746	<b>Ref. No.</b>	0A8271
<b>description</b>	push button L 25mm W 19.5mm black light		



1

<b>GEV No.</b>	345738	<b>Ref. No.</b>	083201
<b>description</b>	push button L 25mm W 19.5mm black moisture		



1

<b>GEV No.</b>	345732	<b>Ref. No.</b>	0A8269
<b>description</b>	push button L 25mm W 19.5mm black ventilation		



1

<b>GEV No.</b>	345833	<b>Ref. No.</b>	049062
<b>description</b>	push button ø 23mm grey		



1

<b>GEV No.</b>	345829	<b>Ref. No.</b>	049325
<b>description</b>	push button ø 23mm grey drain pump		



1

<b>GEV No.</b>	345827	<b>Ref. No.</b>	049317
<b>description</b>	push button ø 23mm grey Sinus		





1

<b>GEV No.</b>	345834	<b>Ref. No.</b>	049065
<b>description</b>	push button ø 23mm yellow		





			
1			
<b>GEV No.</b>	345828	<b>Ref. No.</b>	049318
<b>description</b>	push button ø 23mm yellow start / I		

			
1			
<b>GEV No.</b>	345727	<b>Ref. No.</b>	0A8691
<b>description</b>	push button size 23x23mm black 0-1 with lens		

			
1			
<b>GEV No.</b>	345726	<b>Ref. No.</b>	082937
<b>description</b>	push button size 23x23mm black light with lens		

			
1			
<b>GEV No.</b>	345725	<b>Ref. No.</b>	082901
<b>description</b>	push button size 23x23mm black moisture with lens		

			
1			
<b>GEV No.</b>	345745	<b>Ref. No.</b>	0A8747
<b>description</b>	push button size 23x23mm black ventilation with lens		

			
1			
<b>GEV No.</b>	345731	<b>Ref. No.</b>	0A8272
<b>description</b>	rotary disc red/black disc ø 16.9mm		

			
1			
<b>GEV No.</b>	345719	<b>Ref. No.</b>	0A8273
<b>description</b>	switch 1CO 250V 16A connection male faston 6.3mm		

			
1			
<b>GEV No.</b>	345722	<b>Ref. No.</b>	0A8274
<b>description</b>	switch 1NO 250V 16A connection male faston 6.3mm		

			
1			
<b>GEV No.</b>	345651	<b>Ref. No.</b>	003766
<b>description</b>	switch 2CO 250V 16A connection male faston 6.3mm		

			
1			
<b>GEV No.</b>	345826	<b>Ref. No.</b>	049326
<b>description</b>	switch 2CO 250V 16A connection male faston 6.3mm		

			
1			
<b>GEV No.</b>	345831	<b>Ref. No.</b>	049063
<b>description</b>	switch 2CO 250V 16A connection male faston 6.3mm		

			
1			
<b>GEV No.</b>	345720	<b>Ref. No.</b>	0A8754
<b>description</b>	switch 2NO 250V 16A connection male faston 6.3mm		



1

<b>GEV No.</b>	345824	<b>Ref. No.</b>	049316
<b>description</b>	switch 2NO 250V 16A connection male faston 6.3mm		

float switches

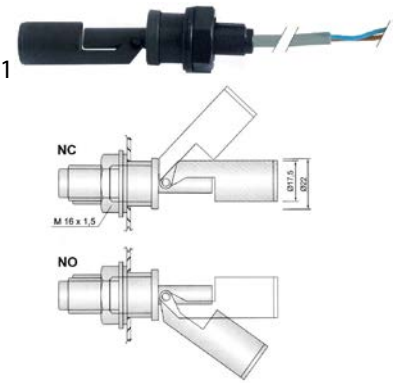

1

<b>GEV No.</b>	345822	<b>Ref. No.</b>	049478
<b>description</b>	float switch thread M16x1.5 1NO or 1NC ø 17.4mm L 98mm mounting ø 16mm 250V 0.5A cable cable length 2000mm		

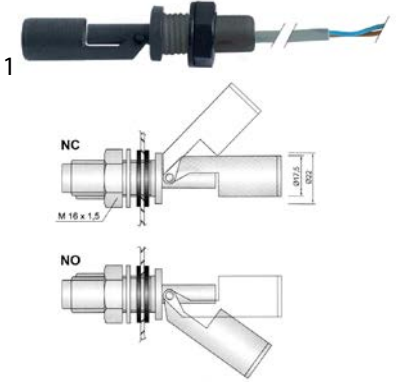

1

<b>GEV No.</b>	345484	<b>Ref. No.</b>	0E5808
<b>description</b>	float switch thread M16x1.5 1NO or 1NC ø 17.5mm L 92mm mounting ø 16mm 250V 1A cable cable length 2000mm		

cam switches

on/off

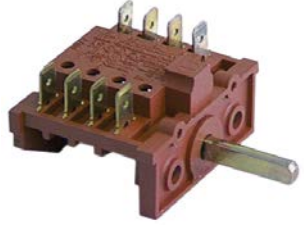

1

<b>GEV No.</b>	301087	<b>Ref. No.</b>	047498
<b>description</b>	cam switch 2 operating positions 2NO sequence 0-1 10A shaft ø 6x4.6mm shaft L 23mm connection male faston 6.3mm ON-OFF plastic		

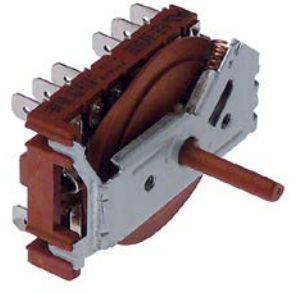

1

<b>GEV No.</b>	300218	<b>Ref. No.</b>	0E5222
<b>description</b>	cam switch 2 operating positions 6NO sequence 0-1 16A shaft ø 6x4.6mm shaft L 23mm connection male faston 6.3mm plastic		



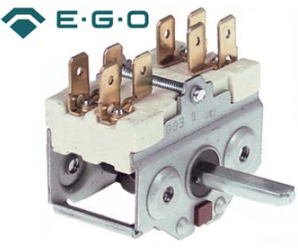





1

<b>GEV No.</b>	300074	<b>Ref. No.</b>	0A2162
<b>description</b>	cam switch 4 operating positions 2NO sequence 0-1-0-1 16A shaft ø 6x4.6mm shaft L 23mm connection male faston 6.3mm ceramic		



1

<b>GEV No.</b>	300020	<b>Ref. No.</b>	028390
<b>description</b>	cam switch 4 operating positions 2NO sequence 0-1-0-1 16A shaft ø 6x4.6mm shaft L 23mm connection screw ceramic		
<b>accessories for</b>	300020		
	<b>GEV No.</b>	110135	<b>Ref. No.</b> —
	rosette knob up to ø 52mm		
	<b>GEV No.</b>	110231	<b>Ref. No.</b> —
	knob switch 0-1-0-1 t.max.°C°C ø 50mm shaft ø 6x4.6mm shaft flat upper black		



1

<b>GEV No.</b>	300017	<b>Ref. No.</b>	0A2241
<b>description</b>	cam switch 4 operating positions 4NO sequence 0-1-0-1 16A shaft ø 6x4.6mm shaft L 23mm connection male faston 6.3mm ceramic		



1

<b>GEV No.</b>	300102	<b>Ref. No.</b>	050857
<b>description</b>	cam switch 4 operating positions 4NO sequence 0-1-0-1 32A shaft ø 6x4.6mm shaft L 23mm connection screw ceramic		

### 5-position



1

<b>GEV No.</b>	300075	<b>Ref. No.</b>	025300
<b>description</b>	cam switch 5 operating positions 2NO/2CO sequence 0-1-2-3-4 32A shaft ø 6x4.6mm shaft L 23mm connection screw 5-position ceramic		

### 7-position





1

<b>GEV No.</b>	300004	<b>Ref. No.</b>	0K6627
<b>description</b>	cam switch 7 operating positions 1NO/2CO sequence 0-1-2-3-4-5-6 16A shaft ø 6x4.6mm shaft L 23mm connection male faston 6.3mm 7-position ceramic		



1

<b>GEV No.</b>	300025	<b>Ref. No.</b>	0A2021
<b>description</b>	cam switch 7 operating positions 1NO/2CO sequence 0-1-2-3-4-5-6 16A shaft ø 6x4.6mm shaft L 23mm connection screw 7-position ceramic		
<b>accessories for</b>	300025		
	<b>GEV No.</b>	112172	<b>Ref. No.</b> —
	knob universal ø 70mm black without adaptor/dial plate		
	<b>GEV No.</b>	112213	<b>Ref. No.</b> —
	knob dial plate silver switch 7-position t.max.°C°C ED ø 63mm ID ø 45.5mm		
	<b>GEV No.</b>	112311	<b>Ref. No.</b> —
	knob adapter shaft ø 6x4.6mm L 0mm with spring		



1

<b>GEV No.</b>	300106	<b>Ref. No.</b>	0A2022
<b>description</b>	cam switch 7 operating positions 1NO/2CO sequence 0-1-2-3-4-5-6 32A shaft ø 6x4.6mm shaft L 23mm connection screw 7-position shaft flat upper		

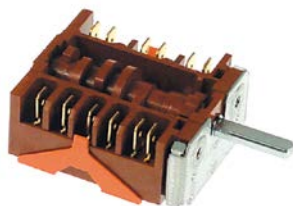

1

<b>GEV No.</b>	300177	<b>Ref. No.</b>	053408 059238
<b>description</b>	cam switch 7 operating positions 6NO sequence 0-1-2-3-4-5-6 16A shaft ø 6x4.6mm shaft L 23mm connection male faston 6.3mm 7-position		

## 3 operating positions

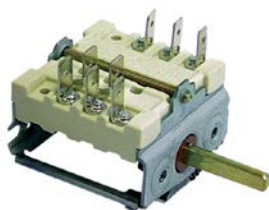

1

<b>GEV No.</b>	345171	<b>Ref. No.</b>	048271
<b>description</b>	cam switch 3 operating positions 3NO sequence 0-1-2 16A shaft ø 6x4.6mm shaft L 26mm connection male faston 6.3mm ceramic		

**accessories for** 345171

<b>GEV No.</b>	112340	<b>Ref. No.</b>	048340
<b>description</b>	knob switch zero mark t.max.°C temperature range°C ø 40mm shaft ø 6x4.6mm shaft flat left black		

## 4 operating positions

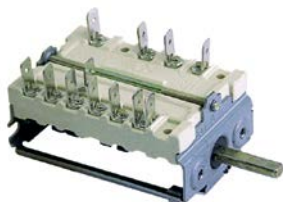

1

<b>GEV No.</b>	300010	<b>Ref. No.</b>	057934
<b>description</b>	cam switch 4 operating positions 2NO/2CO sequence 0-1-2-3 16A shaft ø 6x4.6mm shaft L 23mm connection male faston 6.3mm ceramic		



1

<b>GEV No.</b>	301216	<b>Ref. No.</b>	059544
<b>description</b>	cam switch 4 operating positions 5NO sequence 0-1-2-3 16A shaft ø 6x4.6mm shaft L 23mm connection male faston 6.3mm		



1

<b>GEV No.</b>	301186	<b>Ref. No.</b>	049144
<b>description</b>	cam switch 4 operating positions 7NO sequence 1-0-2-3 16A shaft ø 6x4.6mm shaft L 23mm connection male faston 6.3mm plastic		

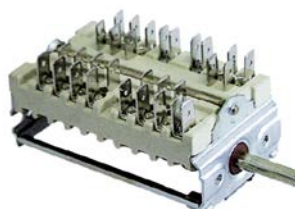

1

<b>GEV No.</b>	301090	<b>Ref. No.</b>	053866
<b>description</b>	cam switch 4 operating positions sequence 0-1-2-3 shaft ø 6x4.6mm connection male faston 7-pole		

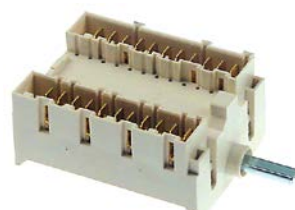

1

<b>GEV No.</b>	301215	<b>Ref. No.</b>	0C0320
<b>description</b>	cam switch 4 operating positions shaft ø 6x4.6mm connection male faston 11-pole		

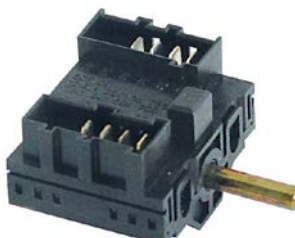

1

<b>GEV No.</b>	301187	<b>Ref. No.</b>	049145
<b>description</b>	cam switch 4 operating positions shaft ø 6x4.6mm connection male faston 4-pole		



5 operating positions

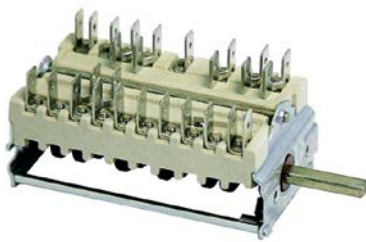

1			
<b>GEV No.</b>	300009	<b>Ref. No.</b>	051647
<b>description</b>	cam switch 5 operating positions changeover switch sequence 0-1-2-3-4 16A shaft ø 6x4.6mm connection male faston 8-pole		

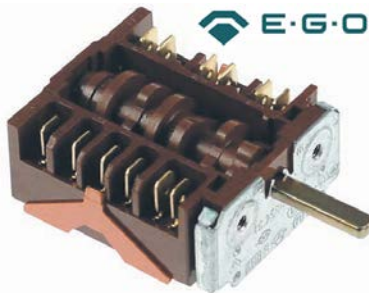

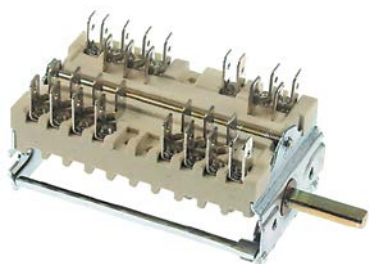

1			
<b>GEV No.</b>	301229	<b>Ref. No.</b>	005213
<b>description</b>	cam switch 5 operating positions sequence 0-1-2-3-4 shaft ø 6x4.6mm connection male faston 3-pole		

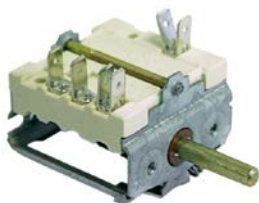

1			
<b>GEV No.</b>	301211	<b>Ref. No.</b>	004268
<b>description</b>	cam switch 5 operating positions sequence 0-1-2-3-4 shaft ø 6x4.6mm connection male faston 7-pole		

6 operating positions



1			
<b>GEV No.</b>	345170	<b>Ref. No.</b>	048270
<b>description</b>	cam switch 6 operating positions 1CO sequence 0-1-2-3-4-5 16A shaft ø 6x4.6mm shaft L 23mm connection male faston 6.3mm ceramic		
<b>accessories for</b>	345170		
	<b>GEV No.</b>	112340	<b>Ref. No.</b> 048340
	knob switch zero mark t.max.°C temperature range°C ø 40mm shaft ø 6x4.6mm shaft flat left black		

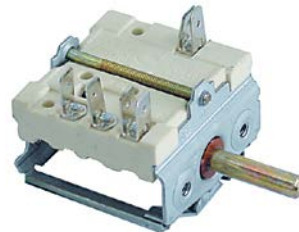

1			
<b>GEV No.</b>	301184	<b>Ref. No.</b>	048286
<b>description</b>	cam switch 6 operating positions programme shaft ø 6x4.6mm connection male faston 1-pole		

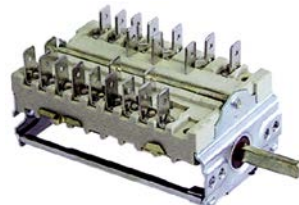

1			
<b>GEV No.</b>	301092	<b>Ref. No.</b>	058806
<b>description</b>	cam switch 6 operating positions selection/ program shaft ø 6x4.6mm connection male faston 7-pole		

7 operating positions



1			
<b>GEV No.</b>	301210	<b>Ref. No.</b>	004741
<b>description</b>	cam switch 7 operating positions 7NO sequence 0-1-2-3-4-5-6 16A shaft ø 6x4.6mm shaft L 23mm connection male faston 6.3mm plastic		

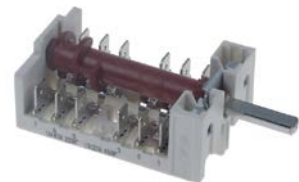

1			
<b>GEV No.</b>	300233	<b>Ref. No.</b>	002661
<b>description</b>	cam switch 7 operating positions shaft ø 6x4.6mm shaft L 23mm 5-pole		

8 operating positions

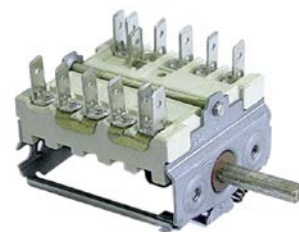

1			
<b>GEV No.</b>	301094	<b>Ref. No.</b>	055017
<b>description</b>	cam switch 8 operating positions 7NO sequence 0-1-2-3-4-5-6-7 16A shaft ø 6x4.6mm shaft L 23mm connection male faston 6.3mm ceramic		

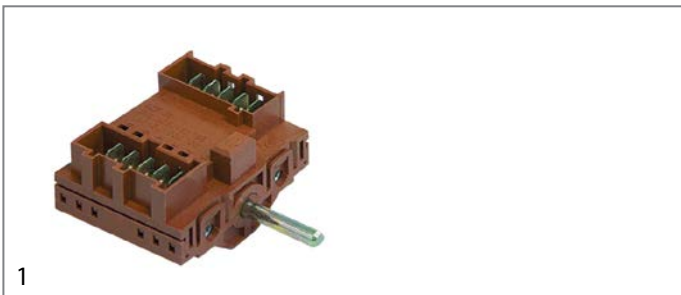

1	<b>GEV No.</b>	345169	<b>Ref. No.</b>	048829
	<b>description</b>	cam switch 8 operating positions connection male faston 5-pole		
	<b>accessories for</b>	345169		
	<b>GEV No.</b>	110907	<b>Ref. No.</b>	048830
	knob switch zero mark ø 44mm shaft ø 6x4.6mm shaft flat left black			

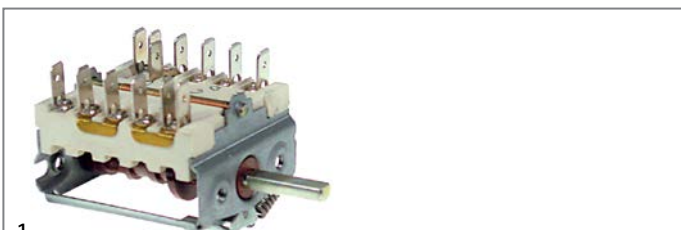

1	<b>GEV No.</b>	301238	<b>Ref. No.</b>	003761
	<b>description</b>	cam switch 8 operating positions shaft ø 6x4.6mm connection male faston 4-pole		

operation switches



1	<b>GEV No.</b>	300002	<b>Ref. No.</b>	0A2134
	<b>description</b>	cam switch 2 operating positions 4NO 16A sequence 0-1 shaft ø 6x4.6mm shaft L 23mm connection male faston 6.3mm ceramic		



1	<b>GEV No.</b>	300080	<b>Ref. No.</b>	026945
	<b>description</b>	cam switch 2 operating positions 4NO 16A sequence 0-1 shaft ø 6x4.6mm shaft L 23mm connection screw operation switch ceramic ambient temperature max. 150°C		
	<b>accessories for</b>	300080		
	<b>GEV No.</b>	551456	<b>Ref. No.</b>	—
	gasket for switch ED ø 14mm ID ø 2.5mm thickness 3.5mm white			

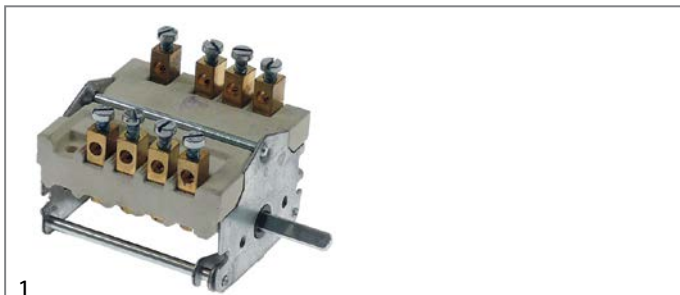

1	<b>GEV No.</b>	300180	<b>Ref. No.</b>	006649
	<b>description</b>	cam switch 2 operating positions operation switch 32A sequence 0-1 shaft ø 6x4.6mm shaft L 23mm connection screw ceramic		

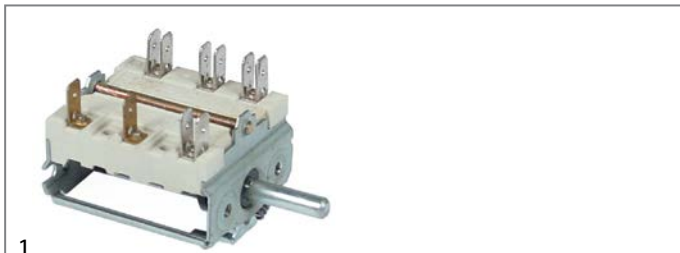

1	<b>GEV No.</b>	301142	<b>Ref. No.</b>	055473
	<b>description</b>	cam switch 2 operating positions operation switch sequence 1-2 shaft ø 6x4.6mm connection male faston 3-pole ambient temperature max. 270°C		



1	<b>GEV No.</b>	301095	<b>Ref. No.</b>	054324
	<b>description</b>	cam switch 4 operating positions operation switch sequence 0-1-2-3 shaft ø 6x4.6mm connection male faston 3-pole ambient temperature max. 270°C		

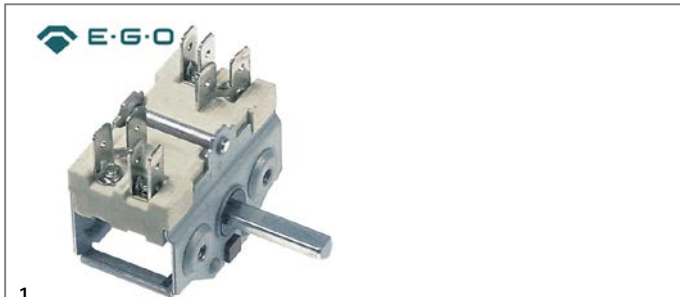

1	<b>GEV No.</b>	300200	<b>Ref. No.</b>	054375
	<b>description</b>	operation switch 2 operating positions 2NO 16A sequence 0-1 shaft ø 6x4.6mm shaft L 23mm connection male faston 6.3mm operation switch ceramic		



miscellaneous



1			
<b>GEV No.</b>	300221	<b>Ref. No.</b>	0E5131
<b>description</b>	cam switch 2 operating positions 4NO sequence 1-2 16A shaft $\varnothing$ 6x4.6mm shaft L 23mm connection male faston 6.3mm plastic		



1			
<b>GEV No.</b>	301299	<b>Ref. No.</b>	0C6245
<b>description</b>	cam switch 8 operating positions 5NO sequence 0-1-2-3-4-5-6-7 16A shaft $\varnothing$ 6x4.6mm shaft L 23mm connection male faston 6.3mm plastic		

rotary switches

BREMAS

A1600 series



1			
<b>GEV No.</b>	301182	<b>Ref. No.</b>	046649
<b>description</b>	rotary switch 4 0-1-2-3 sets of contacts 13 type SCH.0713/6194 600V 20A shaft $\varnothing$ 4x5mm shaft L 25mm square connection male faston 6.3mm		

miscellaneous



1			
<b>GEV No.</b>	300327	<b>Ref. No.</b>	046879
<b>description</b>	rotary switch		

GOTTAK



1			
<b>GEV No.</b>	300219	<b>Ref. No.</b>	0E5132
<b>description</b>	switch 3 operating positions 3NO sequence 0-1 momentary switch 16A shaft $\varnothing$ 6x4.6mm shaft L 23mm connection male faston 6.3mm plastic		

magnetic switches

29x19mm

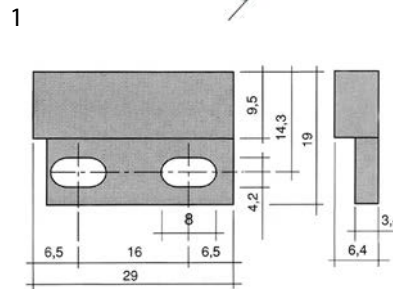

1			
<b>GEV No.</b>	345117	<b>Ref. No.</b>	048392
<b>description</b>	magnetic switch L 28.5mm W 19mm 1NO 250V 0.04A P max. 10W connection cable cable length 1000mm		

35x22mm

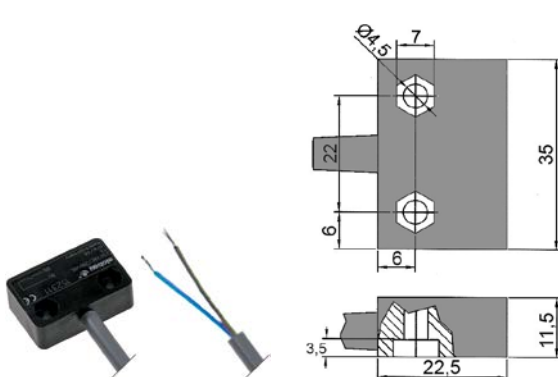

1			
<b>GEV No.</b>	347003	<b>Ref. No.</b>	0K7171
<b>description</b>	magnetic switch L 35mm W 22mm 1NO 230V 1A 60W		

36x13mm

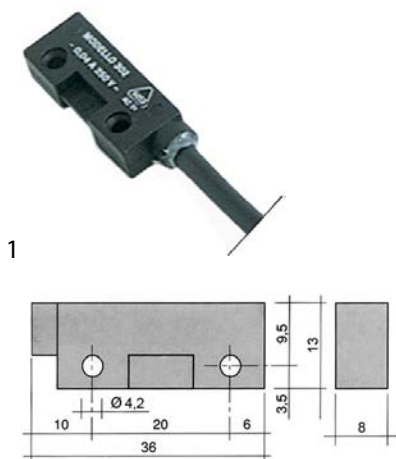

<b>GEV No.</b>	345820 <sup>1</sup>	<b>Ref. No.</b>	049226
<b>description</b>	magnetic switch L 36mm W 13mm 1NO 250V 1A P max. 50W connection plug cable length 290mm		

<sup>1</sup>with coded connector

36x26mm

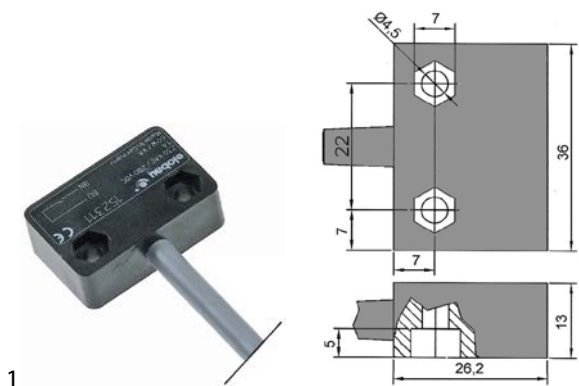

<b>GEV No.</b>	346999	<b>Ref. No.</b>	049969
<b>description</b>	magnetic switch L 36mm W 26mm 1NC 230V 3A P max. 60W connection cable length 2000mm polarised		
<b>accessories for</b>	346999		
	<b>GEV No.</b>	<b>Ref. No.</b>	088361
	magnet ømm L 23mm H 18mm W 16mm ID ømm ED ømm M5		

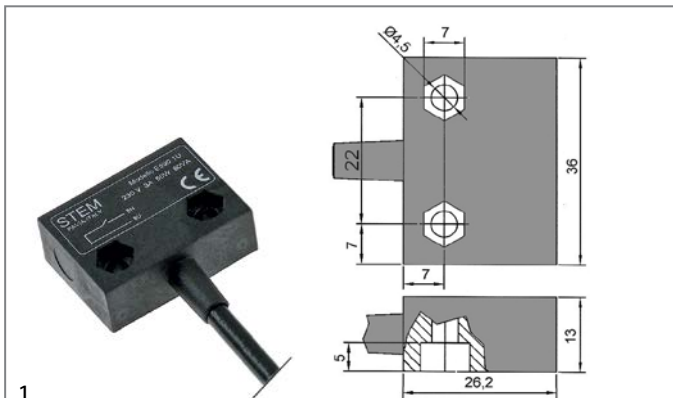

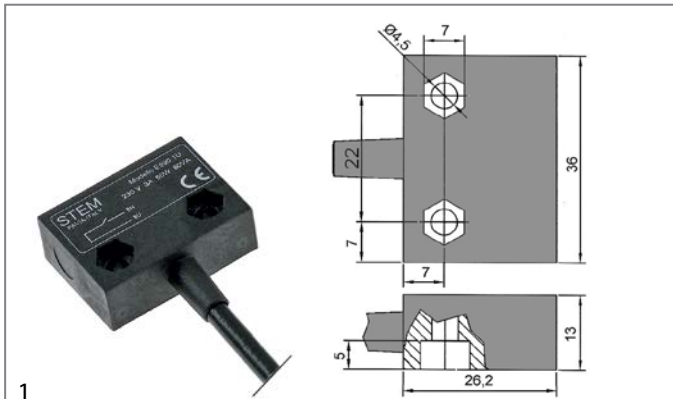

<b>GEV No.</b>	346998	<b>Ref. No.</b>	049966
<b>description</b>	magnetic switch L 36mm W 26mm 1NO 230V 3A P max. 60W connection cable length 2000mm		
<b>accessories for</b>	346998		
	<b>GEV No.</b>	<b>Ref. No.</b>	088361
	magnet ømm L 23mm H 18mm W 16mm ID ømm ED ømm M5		

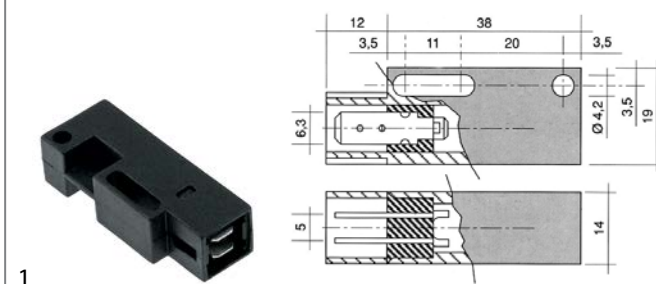

<b>GEV No.</b>	347000	<b>Ref. No.</b>	049967
<b>description</b>	magnetic switch L 36mm W 26mm 1NO 230V 3A P max. 60W connection cable length 5500mm		

50x19mm



<b>GEV No.</b>	345821	<b>Ref. No.</b>	049621
<b>description</b>	magnetic switch L 50mm W 19mm 1NO 250V 1A P max. 50W connection male faston 6.3mm		
<b>accessories for</b>	345821		
	<b>GEV No.</b>	<b>Ref. No.</b>	049627
	magnet ømm L 63mm H 10.7mm W 18.8mm hole distance 52mm M2 hole ø 2mm		





ø 6mm			
1 			
<b>GEV No.</b>	345818	<b>Ref. No.</b>	048893
<b>description</b>	magnetic switch 250V 0.01A connection cable		

1 			
<b>GEV No.</b>	345819 <sup>1</sup>	<b>Ref. No.</b>	048831
<b>description</b>	magnetic switch 250V 1A P max. 50W probe L 29mm 1NO connection plug cable length 300mm		

<sup>1</sup>with coded connector

1 			
<b>GEV No.</b>	345146	<b>Ref. No.</b>	048486
<b>description</b>	magnetic switch 250V 1A P max. 50W probe L 29mm 1NO connection plug cable length 980mm		



ø 9mm			
1 			
<b>GEV No.</b>	347190	<b>Ref. No.</b>	049970
<b>description</b>	magnetic switch 150V 0.5A P max. 10W probe L 30mm 1NC connection cable length 1500mm		

M10x1			
1 			
<b>GEV No.</b>	346376	<b>Ref. No.</b>	056468
<b>description</b>	magnetic switch thread M10x1 L 40mm 1NO 250V 1A connection cable 50W		

accessories

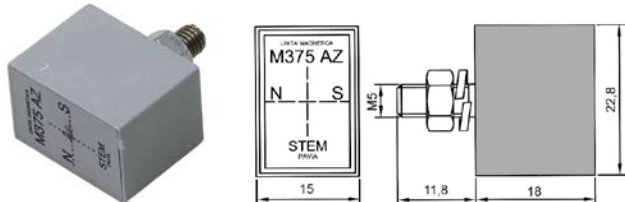
magnets			
1 			
<b>GEV No.</b>	347002	<b>Ref. No.</b>	048667
<b>description</b>	magnet ø 6mm L 30mm Hmm Wmm ED ø 6mm		

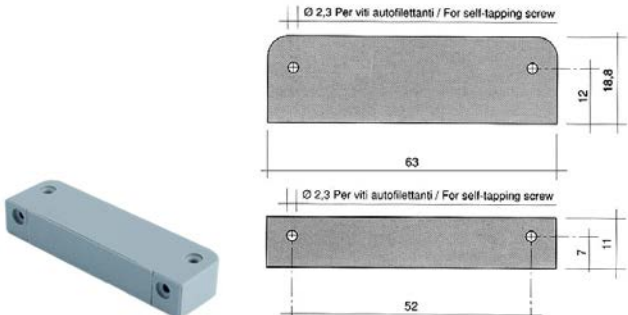
1 			
<b>GEV No.</b>	347001	<b>Ref. No.</b>	088361
<b>description</b>	magnet ømm L 23mm H 18mm W 16mm ID ømm ED ømm M5		

1 				
<b>GEV No.</b>	519049	<b>Ref. No.</b>	049627	
<b>description</b>	magnet ømm L 63mm H 10.7mm W 18.8mm hole distance 52mm M2 hole ø 2mm			
<b>accessories for</b>	519049			
	<b>GEV No.</b>	560095	<b>Ref. No.</b>	—
	sheet metal screws ø 2.9mm L 9.5mm SS Qty 20 pcs DIN 7981/ISO 7049 head ø 5.6mm oval head			



## control equipment

## MOELLER/EATON

## switches (complete)

## push/momentary push switches



1

<b>GEV No.</b>	346366	<b>Ref. No.</b>	0A2232
<b>description</b>	momentary push switch mounting measurements ø22mm black 1NO/1CO arrow momentary		



1

<b>GEV No.</b>	346340	<b>Ref. No.</b>	0A2196
<b>description</b>	switch mounting measurements ø22mm red complete EMERGENCY SHUT-DOWN		

## SCHLEGEL

## symbol plates



1

<b>GEV No.</b>	345752	<b>Ref. No.</b>	0H6290
<b>description</b>	symbol plate white operating temperature		

## GEV special

## ø16mm

## push buttons



1

<b>GEV No.</b>	345754	<b>Ref. No.</b>	005139
<b>description</b>	push button square clear ø 16mm		



1

<b>GEV No.</b>	345751	<b>Ref. No.</b>	005138
<b>description</b>	contact block 2NO/2NC		

## switches



1

<b>GEV No.</b>	345753	<b>Ref. No.</b>	005137
<b>description</b>	switch mounting measurements ø16mm latching		



1

<b>GEV No.</b>	345755	<b>Ref. No.</b>	0K1005
<b>description</b>	switch mounting measurements ø16mm momentary		

## ø22mm

## key lock switches



1

<b>GEV No.</b>	345244	<b>Ref. No.</b>	0H6694
<b>description</b>	key lock switch mounting measurements ø22mm latching sequence 0-1		

## rotary switches



1

<b>GEV No.</b>	345263	<b>Ref. No.</b>	0K2156
<b>description</b>	rotary selector mounting measurements ø22mm black momentary sequence 0-1		

## switch blocks



1

<b>GEV No.</b>	345261	<b>Ref. No.</b>	0H6693
<b>description</b>	contact block 2NO 660V max. 16(4)A connection screw		





SIEMENS

3SB series ø22mm new

signal element



1

**GEV No.** 347897 **Ref. No.** 075605

**description** signal element mounting measurements ø22mm green

TELEMECANIQUE (EFA)

XB2 series

switches (complete)



1

**GEV No.** 346575 **Ref. No.** 0H6687

**description** momentary push switch mounting measurements ø22mm green 1NC/1NO

lamps

indicator lights

indicator lights 2-piece (lens and indicator lamp)

indicator light lenses

ø 6mm (type SQ-20)



1

**GEV No.** 359803 **Ref. No.** 054151

**description** indicator light lens green Qty 1 pcs ø 6mm



1

**GEV No.** 359804 **Ref. No.** 053812

**description** indicator light lens yellow Qty 1 pcs ø 6mm

ø10mm (type SRZ-3)



1

**GEV No.** 359123 **Ref. No.** 004896

**description** indicator light housings mounting measurements ø10mm green round Qty 1 pcs

**accessories for** 359123

**GEV No.** 359132 **Ref. No.** 004895

**description** indicator lamp green 250V connection male faston 6.3mm protection IP54 ambient temperature max. 85°C



1

**GEV No.** 359124 **Ref. No.** 004928

**description** indicator light housings mounting measurements ø10mm yellow round Qty 1 pcs

**accessories for** 359124

**GEV No.** 359132 **Ref. No.** 004895

**description** indicator lamp green 250V connection male faston 6.3mm protection IP54 ambient temperature max. 85°C

ø12mm (type SDK-3)



1

**GEV No.** 359792 **Ref. No.** 047750

**description** indicator light housings mounting measurements ø12mm blue Qty 1 pcs

ø13mm (type SFK-3)



1

**GEV No.** 359225 **Ref. No.** 046289

**description** indicator light housings mounting measurements ø13mm clear Qty 1 pcs



1

**GEV No.** 359126 **Ref. No.** 075096

**description** indicator light housings mounting measurements ø13mm green Qty 1 pcs



1

**GEV No.** 359128 **Ref. No.** 075097

**description** indicator light housings mounting measurements ø13mm red round Qty 1 pcs



1

**GEV No.** 359127 **Ref. No.** 075095

**description** indicator light housings mounting measurements ø13mm yellow Qty 1 pcs



## indicator lamps for socket type SQ



<b>GEV No.</b>	359109	<b>Ref. No.</b>	054150
----------------	--------	-----------------	--------

<b>description</b>	indicator lamp 230V green connection male faston 6.3mm no lens ø 6mm		
--------------------	--	--	--

<b>accessories for</b>	359109		
------------------------	--------	--	--



<b>GEV No.</b>	359806	<b>Ref. No.</b>	—
----------------	--------	-----------------	---

indicator light lens clear Qty 1 pcs ø 6mm



<b>GEV No.</b>	359110	<b>Ref. No.</b>	053811
----------------	--------	-----------------	--------

<b>description</b>	indicator lamp 230V white connection male faston 6.3mm no lens ø 6mm		
--------------------	--	--	--

## indicator lamps for socket type SRZ / SDK / SDY / SFK



<b>GEV No.</b>	359130	<b>Ref. No.</b>	046241 048488
----------------	--------	-----------------	------------------

<b>description</b>	indicator lamp 230V clear connection male faston 6.3mm ø 8mm		
--------------------	--	--	--



<b>GEV No.</b>	359132	<b>Ref. No.</b>	004895
----------------	--------	-----------------	--------

<b>description</b>	indicator lamp green 250V connection male faston 6.3mm protection IP54 ambient temperature max. 85°C		
--------------------	--	--	--

indicator lights 3-piece (housing, lens and bulb)  
lamps

## neon light bulbs



<b>GEV No.</b>	359603	<b>Ref. No.</b>	0H7037
----------------	--------	-----------------	--------

<b>description</b>	neon light bulb socket E14 380V clear ø 14mm L 30mm		
--------------------	---	--	--

## indicator lights (complete)

## ø 6mm



<b>GEV No.</b>	345836	<b>Ref. No.</b>	049064
----------------	--------	-----------------	--------

<b>description</b>	indicator light ø 6mm 230V green cable length 250mm		
--------------------	---	--	--

## ø10mm

## with screw socket



<b>GEV No.</b>	359378	<b>Ref. No.</b>	0A2224
----------------	--------	-----------------	--------

<b>description</b>	indicator light ø 10mm 230V green connection male faston 6.3mm socket screw base		
--------------------	--	--	--



<b>GEV No.</b>	359379	<b>Ref. No.</b>	0A2225
----------------	--------	-----------------	--------

<b>description</b>	indicator light ø 10mm 230V yellow connection male faston 6.3mm socket screw base		
--------------------	---	--	--

## with plug-in socket



<b>GEV No.</b>	359138	<b>Ref. No.</b>	0C4181
----------------	--------	-----------------	--------

<b>description</b>	indicator light ø 10mm red 230V connection male faston 6.3mm Qty 1 pcs		
--------------------	--	--	--



<b>GEV No.</b>	359140	<b>Ref. No.</b>	005215
----------------	--------	-----------------	--------

<b>description</b>	indicator light ø 10mm yellow 230V connection male faston 6.3mm Qty 1 pcs		
--------------------	---	--	--

## ø13mm

## with screw socket



<b>GEV No.</b>	359144	<b>Ref. No.</b>	005012
----------------	--------	-----------------	--------

<b>description</b>	indicator light ø 13mm 230V red		
--------------------	---------------------------------	--	--

<b>accessories for</b>	359144		
------------------------	--------	--	--



<b>GEV No.</b>	510302	<b>Ref. No.</b>	047986
----------------	--------	-----------------	--------

O-ring EPDM ID ø 12.42mm thickness 1.78mm Qty 1 pcs			
---	--	--	--



<b>GEV No.</b>	511505	<b>Ref. No.</b>	—
----------------	--------	-----------------	---

O-ring EPDM thickness 1.78mm ID ø 12.42mm Qty 10 pcs			
--	--	--	--

## with plug-in socket



<b>GEV No.</b>	359364	<b>Ref. No.</b>	005010
----------------	--------	-----------------	--------

<b>description</b>	indicator light ø 13mm green 230V		
--------------------	-----------------------------------	--	--





			
<b>GEV No.</b>	359365	<b>Ref. No.</b>	005011
<b>description</b>	indicator light ø 13mm yellow 230V		

ø14mm  
with plug-in socket

			
<b>GEV No.</b>	359151	<b>Ref. No.</b>	053154
<b>description</b>	indicator light ø 14mm green 400V connection male faston 6.3mm temp.-resist. 120°C		

			
<b>GEV No.</b>	359150	<b>Ref. No.</b>	053153
<b>description</b>	indicator light ø 14mm red 400V connection male faston 6.3mm temp.-resist. 105°C square		

			
<b>GEV No.</b>	359152	<b>Ref. No.</b>	053155
<b>description</b>	indicator light ø 14mm yellow 400V connection male faston 6.3mm temp.-resist. 105°C square		

<p>28.5x28.5mm</p> 			
<b>GEV No.</b>	345728	<b>Ref. No.</b>	0A8692
<b>description</b>	indicator light lens 23x23 orange defrost		

<p>31x10mm</p> 			
<b>GEV No.</b>	359306	<b>Ref. No.</b>	0H6581
<b>description</b>	indicator light mounting measurements 31x10mm 230V white/red/green		

<p>33x10mm</p> 			
<b>GEV No.</b>	359842	<b>Ref. No.</b>	056501
<b>description</b>	indicator light mounting measurements 33x10mm 24V white		

<p>miscellaneous</p> 			
<b>GEV No.</b>	359006	<b>Ref. No.</b>	0K3776
<b>description</b>	indicator light white 230V		

<p>blank elements</p> 			
<b>GEV No.</b>	359844	<b>Ref. No.</b>	0C3049
<b>description</b>	indicator light lens red ø 6mm		

			
<b>GEV No.</b>	359845	<b>Ref. No.</b>	005211
<b>description</b>	indicator light lens yellow ø 6mm		

screw-on/push-on fit

<p>neon light bulbs</p> 			
<b>GEV No.</b>	359603	<b>Ref. No.</b>	0H7037
<b>description</b>	neon light bulb socket E14 380V clear ø 14mm L 30mm		

<p>light bulbs</p> <p>for ovens</p> 			
<b>GEV No.</b>	359612	<b>Ref. No.</b>	054840
<b>description</b>	light bulb t.max. 300°C socket E14 25W 230V ø 25mm L 56mm lens L 30mm for oven lamp type Philips		

halogen lamp

for socket G4 / G6.35 / G9



<b>GEV No.</b>	357191	<b>Ref. No.</b>	0C4396
<b>description</b>	halogen lamp socket G4 12V 10W temp.-resist. 300°C OSRAM HALOSTAR OVEN		

oven lamps

universal oven lamps

mounting diameter 28.5mm







<b>GEV No.</b>	359317	<b>Ref. No.</b>	0H7040
<b>description</b>	oven lamp mounting ø 28.5mm 12V 5W socket G4 temp.-resist. 300°C cable length 300mm		
<b>spare parts for</b>	359317		
	<b>GEV No.</b>	359308	<b>Ref. No.</b> 0H6582
	oven lamp glass		





<b>GEV No.</b>	359308	<b>Ref. No.</b>	0H6582
<b>description</b>	oven lamp glass		

mounting diameter 35.5mm



<b>GEV No.</b>	359701	<b>Ref. No.</b>	002625
<b>description</b>	lamp socket socket E14 220-230V mounting ø 35.5mm connection male faston 6.3mm 15W		
<b>accessories for</b>	359701		
	<b>GEV No.</b>	359705	<b>Ref. No.</b> —
	oven lamp glass thr.ø 33.5mm ø 52mm hard glas temp.-resist. 350°C		
	<b>GEV No.</b>	359709	<b>Ref. No.</b> —
	oven lamp glass thr.ø 33.5mm ø 42mm hard glas temp.-resist. 350°C		
	<b>GEV No.</b>	359721	<b>Ref. No.</b> —
	gasket silicone ED ø 48mm ID ø 39.5mm thickness 5mm Qty 1 pcs		
	<b>GEV No.</b>	359942	<b>Ref. No.</b> —
	oven lamp glass thr.ø 33.5mm ø 41mm hard glas temp.-resist. 350°C		





<b>GEV No.</b>	359841	<b>Ref. No.</b>	007105
<b>description</b>	lamp socket socket G4 mounting ø 35.5mm connection cable 3500mm		
<b>accessories for</b>	359841		
	<b>GEV No.</b>	359763	<b>Ref. No.</b> 002626
	frame without socket		
	<b>GEV No.</b>	359764	<b>Ref. No.</b> 002627
	lamp glass ø 44mm		
	<b>GEV No.</b>	359765	<b>Ref. No.</b> 002628
	lamp holder ID ø 38mm ED ø 76mm		





<b>GEV No.</b>	359762	<b>Ref. No.</b>	0C1555
<b>description</b>	lamp socket socket G4 mounting ø 35.5mm connection cable 450mm		











mounting diameter 47.8mm













<b>GEV No.</b>	357187	<b>Ref. No.</b>	056708
<b>description</b>	oven lamp mounting ø 47.8mm 230V 15W socket E14 temp.-resist. 300°C connection male faston 6.3mm hard glas		
<b>spare parts for</b>	357187		
	<b>GEV No.</b>	359610	<b>Ref. No.</b> —
	light bulb t.max. 300°C socket E14 15W 230V ø 22mm L 47mm lens L 20mm for oven lamp type Philips		
	<b>GEV No.</b>	359725	<b>Ref. No.</b> —
	oven lamp glass thread ø 44mm H 43mm ø 54mm hard glas temp.-resist. 350°C		

55x70mm			
			
1			
<b>GEV No.</b>	359298	<b>Ref. No.</b>	0K3363
<b>description</b>	lamp socket 230V 25W socket E14 mounting measurements 70x55mm connection male faston 6.3mm		
<b>accessories for</b>	359298		
	<b>GEV No.</b>	359937	<b>Ref. No.</b> —
lamp glass L 80mm W 65mm mounting measurements 52x67mm			

			
1			
<b>GEV No.</b>	359375	<b>Ref. No.</b>	003956
<b>description</b>	lamp socket complete without lamp socket E14 mounting measurements 55x70mm		

55x100mm			
			
1			
<b>GEV No.</b>	359698	<b>Ref. No.</b>	054991
<b>description</b>	lamp socket L 100mm W 55mm socket E14 connection male faston 6.3mm		
<b>spare parts for</b>	359698		
	<b>GEV No.</b>	358119	<b>Ref. No.</b> —
frame L 118mm W 72mm mounting distance 143mm for bulb socket			
	<b>GEV No.</b>	358122	<b>Ref. No.</b> —
gasket L 112mm W 68mm silicone thickness 3mm for bulb socket			
	<b>GEV No.</b>	358123	<b>Ref. No.</b> —
lamp glass L 112mm W 68mm			
	<b>GEV No.</b>	359612	<b>Ref. No.</b> 054840
light bulb t.max. 300°C socket E14 25W 230V ø 25mm L 56mm lens L 30mm for oven lamp type Philips			
	<b>GEV No.</b>	359714	<b>Ref. No.</b> 055022
gasket for bulb socket			
	<b>GEV No.</b>	359715	<b>Ref. No.</b> —
lamp glass L 110mm W 65mm thickness 5mm			
	<b>GEV No.</b>	359716	<b>Ref. No.</b> —
frame for bulb socket			
<b>accessories for</b>	359698		
	<b>GEV No.</b>	359612	<b>Ref. No.</b> 054840
light bulb t.max. 300°C socket E14 25W 230V ø 25mm L 56mm lens L 30mm for oven lamp type Philips			
	<b>GEV No.</b>	359938	<b>Ref. No.</b> —
borosilicate glass L 115mm W 69mm			

			
1			
<b>GEV No.</b>	359714	<b>Ref. No.</b>	055022
<b>description</b>	gasket for bulb socket		

			
1			
<b>GEV No.</b>	359698	<b>Ref. No.</b>	054991
<b>description</b>	lamp socket L 100mm W 55mm socket E14 connection male faston 6.3mm		
<b>spare parts for</b>	359698		
	<b>GEV No.</b>	358119	<b>Ref. No.</b> —
frame L 118mm W 72mm mounting distance 143mm for bulb socket			
	<b>GEV No.</b>	358122	<b>Ref. No.</b> —
gasket L 112mm W 68mm silicone thickness 3mm for bulb socket			
	<b>GEV No.</b>	358123	<b>Ref. No.</b> —
lamp glass L 112mm W 68mm			
	<b>GEV No.</b>	359612	<b>Ref. No.</b> 054840
light bulb t.max. 300°C socket E14 25W 230V ø 25mm L 56mm lens L 30mm for oven lamp type Philips			
	<b>GEV No.</b>	359714	<b>Ref. No.</b> 055022
gasket for bulb socket			
	<b>GEV No.</b>	359715	<b>Ref. No.</b> —
lamp glass L 110mm W 65mm thickness 5mm			
	<b>GEV No.</b>	359716	<b>Ref. No.</b> —
frame for bulb socket			
<b>accessories for</b>	359698		
	<b>GEV No.</b>	359612	<b>Ref. No.</b> 054840
light bulb t.max. 300°C socket E14 25W 230V ø 25mm L 56mm lens L 30mm for oven lamp type Philips			
	<b>GEV No.</b>	359938	<b>Ref. No.</b> —
borosilicate glass L 115mm W 69mm			

**lamps**

**light bulbs**



<b>GEV No.</b>	359612	<b>Ref. No.</b>	054840
<b>description</b>	light bulb t.max. 300°C socket E14 25W 230V ø 25mm L 56mm lens L 30mm for oven lamp type Philips		

**halogen lamps**

for socket G4 / G6.35 / G9



<b>GEV No.</b>	357191	<b>Ref. No.</b>	0C4396
<b>description</b>	halogen lamp socket G4 12V 10W temp.-resist. 300°C OSRAM HALOSTAR OVEN		

**sockets**

**E14**



<b>GEV No.</b>	359307	<b>Ref. No.</b>	0K2016
<b>description</b>	lamp socket socket E14 L 28mm with 2 hole fixing		

**residual heat indicators**



<b>GEV No.</b>	359326	<b>Ref. No.</b>	059047
<b>description</b>	residual heat indicator 4-fold		

**timers**

**programme timers**



<b>GEV No.</b>	360280	<b>Ref. No.</b>	046621
<b>description</b>	timer		



<b>GEV No.</b>	360283	<b>Ref. No.</b>	068671
<b>description</b>	timer		



<b>GEV No.</b>	360005	<b>Ref. No.</b>	069420
<b>description</b>	timer BIGATTI D94 engines 1 chambers 1 operation time 20min 230V shaft ømm shaft Lmm manif. no. WE006 motor type 82354021L		



<b>GEV No.</b>	360508	<b>Ref. No.</b>	0KU798
<b>description</b>	timer BIGATTI engines 1 chambers 2 operation time 60min 230V 50/60Hz shaft ø 6x5mm shaft L 19.5mm manif. no. D94.04 / CCS011 motor type UDS11UD5RKZ253 for oven		





1

<b>GEV No.</b>	360349	<b>Ref. No.</b>	069926
<b>description</b>	timer CDC 11803 engines 1 chambers 3 operation time 150s 230V shaft ømm shaft Lmm manif. no. 11803F1BEE000.0010 motor type M48R ATS type 11803F1 / 238046		
<b>spare parts for</b>	360349		
	<b>GEV No.</b>	360673	<b>Ref. No.</b> —
	motor kit pinion ø 6.8mm teeth 15 230V voltage AC 50/60Hz turn direction clockwise motor ø 48mm H 18.5mm motor type UDS-40NE1RNZ165 cable length 150mm with holder		





1

<b>GEV No.</b>	360277	<b>Ref. No.</b>	049251
<b>description</b>	timer FIBER P25 engines 1 chambers 4 operation time 22.5min 230V shaft ømm shaft Lmm manif. no. P255J04L2F9 motor type M51BJ0R6400		
<b>spare parts for</b>	360277		
	<b>GEV No.</b>	360673	<b>Ref. No.</b> —
	motor kit pinion ø 6.8mm teeth 15 230V voltage AC 50/60Hz turn direction clockwise motor ø 48mm H 18.5mm motor type UDS-40NE1RNZ165 cable length 150mm with holder		





1

<b>GEV No.</b>	360334	<b>Ref. No.</b>	003833
<b>description</b>	timer FIBER P04 engines 1 chambers 2 operation time 120min 230V shaft ø 6x4.6mm shaft L 20mm manif. no. P045J02W401 motor type M51BJ0R6400 impulse electric		
<b>spare parts for</b>	360334		
	<b>GEV No.</b>	360673	<b>Ref. No.</b> —
	motor kit pinion ø 6.8mm teeth 15 230V voltage AC 50/60Hz turn direction clockwise motor ø 48mm H 18.5mm motor type UDS-40NE1RNZ165 cable length 150mm with holder		





1

<b>GEV No.</b>	360073	<b>Ref. No.</b>	048647
<b>description</b>	timer FIBER P25 engines 2 chambers 5 operation time 6s / 2min 230V shaft ømm shaft Lmm manif. no. P255J05JD84 motor type M51B-J0R6400 / M51BJ0L6400		
<b>spare parts for</b>	360073		
	<b>GEV No.</b>	360673	<b>Ref. No.</b> —
	motor kit pinion ø 6.8mm teeth 15 230V voltage AC 50/60Hz turn direction clockwise motor ø 48mm H 18.5mm motor type UDS-40NE1RNZ165 cable length 150mm with holder		
	<b>GEV No.</b>	360674	<b>Ref. No.</b> —
	motor kit pinion ø 6.8mm teeth 15 230V voltage AC 50/60Hz turn direction counterclockwise motor ø 48mm H 18.5mm motor type UDS40NE1RNZ165 cable length 150mm with holder		





1

<b>GEV No.</b>	360024	<b>Ref. No.</b>	069926 (old version)
<b>description</b>	timer FIBER P25 engines 1 chambers 3 operation time 2min 230V shaft ømm shaft Lmm manif. no. P255J03H3N6 motor type M51B-J0L6400		
<b>spare parts for</b>	360024		
	<b>GEV No.</b>	360674	<b>Ref. No.</b> —
	motor kit pinion ø 6.8mm teeth 15 230V voltage AC 50/60Hz turn direction counterclockwise motor ø 48mm H 18.5mm motor type UDS40NE1RNZ165 cable length 150mm with holder		



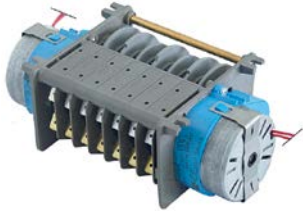

1

<b>GEV No.</b>	360071	<b>Ref. No.</b>	048303
<b>description</b>	timer FIBER P25 engines 2 chambers 5 operation time 6s / 3min 230V shaft ømm shaft Lmm manif. no. P255J05JB62 motor type M51B-J0R6400 / M51BJ0L6400		
<b>spare parts for</b>	360071		
	<b>GEV No.</b>	360673	<b>Ref. No.</b> —
	motor kit pinion ø 6.8mm teeth 15 230V voltage AC 50/60Hz turn direction clockwise motor ø 48mm H 18.5mm motor type UDS-40NE1RNZ165 cable length 150mm with holder		
	<b>GEV No.</b>	360674	<b>Ref. No.</b> —
	motor kit pinion ø 6.8mm teeth 15 230V voltage AC 50/60Hz turn direction counterclockwise motor ø 48mm H 18.5mm motor type UDS40NE1RNZ165 cable length 150mm with holder		



1

<b>GEV No.</b>	360278	<b>Ref. No.</b>	049256
<b>description</b>	timer FIBER P25 engines 2 chambers 7 operation time 6s / 6min 230V shaft ømm shaft Lmm manuf. no. P255J07JFK4 motor type M51B-J0R6400 / M51BJ0L6400		
<b>spare parts for</b>	360278		
	<b>GEV No.</b>	360673	<b>Ref. No.</b> —
	motor kit pinion ø 6.8mm teeth 15 230V voltage AC 50/60Hz turn direction clockwise motor ø 48mm H 18.5mm motor type UDS-40NE1RNZ165 cable length 150mm with holder		
	<b>GEV No.</b>	360674	<b>Ref. No.</b> —
	motor kit pinion ø 6.8mm teeth 15 230V voltage AC 50/60Hz turn direction counterclockwise motor ø 48mm H 18.5mm motor type UDS40NE1RNZ165 cable length 150mm with holder		



1

<b>GEV No.</b>	360456	<b>Ref. No.</b>	045909
<b>description</b>	timer FIBER P34 engines 1 chambers 2 operation time 36min 230V shaft ø 5X3mm shaft L 22mm manuf. no. P345J02L867 motor type M51BJ0L6400		

mechanical timers



1

<b>GEV No.</b>	350061	<b>Ref. No.</b>	0C6345
<b>description</b>	timer DTJ with bell 2-pole operation time 120min impulse mechanical 2NO at 250V 16A permanent position yes shaft ø 6x4.6mm shaft 6x4.6mm shaft L 24mm mounting distance 28mm connection lateral		



1

<b>GEV No.</b>	350141	<b>Ref. No.</b>	0K6863
<b>description</b>	timer TF 2-pole operation time 120min 2NO at 250V 16A permanent position no shaft ø 6x4.6mm shaft L 23mm mounting distance 28mm mounting thread M3 ambient temperature max. 80°C		

defrost timers

BIGATTI



1

<b>GEV No.</b>	360188	<b>Ref. No.</b>	0A8781
<b>description</b>	defrost timer BIGATTI type D94.00 defrosting interval 2x per 24h defrosting time 60smin fan delaymin 230V		



1

<b>GEV No.</b>	360058	<b>Ref. No.</b>	081983
<b>description</b>	defrost timer type SB3.82 defrosting interval 1-12x in 24h defrosting time 2-54min fan delay 0-15min 230V defr. funct. 1-12x per 24h		

miscellaneous



1

<b>GEV No.</b>	379008	<b>Ref. No.</b>	082485
<b>description</b>	defrost timer ELIWELL type EWTS70 12V AC/DCV mounting measurements 71x29mm front measurements 74x32mm built-in depth 60mm		
<b>accessories for</b>	379008		
	<b>GEV No.</b>	379054	<b>Ref. No.</b> 083833
	transformer primary 230VAC secondary 12VAC 3VA secondary 0.25A H 40mm L 45mm W 50mm connection screw 50/60Hz type 153/M		



1

<b>GEV No.</b>	360187	<b>Ref. No.</b>	084986
<b>description</b>	defrost timer type RZ-2001-21 defrosting interval 4H defrosting time 15min fan delay 5min 230V 50Hz defr. funct. 4x per 24h		





## alarm devices

### alarm units

			
1			
<b>GEV No.</b>	350056	<b>Ref. No.</b>	055368
<b>description</b>	alarm device 220-240VAC ømm H 25mm wall-mounted version mounting distance mm 83dB protection IPx0		

### buzzers

			
1			
<b>GEV No.</b>	350085	<b>Ref. No.</b>	0G1993
<b>description</b>	buzzer connection plug-in connection		

## contactors

### BENEDIKT & JÄGER

#### power contactors

			
1			
<b>GEV No.</b>	380672	<b>Ref. No.</b>	0H7049
<b>description</b>	power contactor resistive load 25A 230VAC (AC3/400V) 10A/4kW main contacts 3NO auxiliary contacts 1NC connection screw connection type K2-09A01230		

			
1			
<b>GEV No.</b>	380773	<b>Ref. No.</b>	0L0285
<b>description</b>	power contactor resistive load 25A 230VAC (AC3/400V) 10A/4kW main contacts 3NO auxiliary contacts 1NC connection screw connection type K3-10A01230		

			
1			
<b>GEV No.</b>	380772	<b>Ref. No.</b>	088477
<b>description</b>	power contactor resistive load 25A 230VAC (AC3/400V) 10A/4kW main contacts 3NO auxiliary contacts 1NO connection screw connection type K3-10A10230		

			
1			
<b>GEV No.</b>	380675	<b>Ref. No.</b>	0K3383
<b>description</b>	power contactor resistive load 25A 230VAC (AC3/400V) 12A/5.5kW main contacts 3NO auxiliary contacts 1NC connection screw connection type K2-12A01230		

			
1			
<b>GEV No.</b>	380679	<b>Ref. No.</b>	003598
<b>description</b>	power contactor resistive load 25A 230VAC (AC3/400V) 12A/5.5kW main contacts 3NO auxiliary contacts 1NO connection screw connection type K2-12A01230		

			
1			
<b>GEV No.</b>	380674	<b>Ref. No.</b>	0H7051
<b>description</b>	power contactor resistive load 25A 230VAC (AC3/400V) 12A/5.5kW main contacts 4NO connection screw connection type K2-12A0040230		



1

<b>GEV No.</b>	381079	<b>Ref. No.</b>	004012
<b>description</b>	power contactor resistive load 25A 230VAC (AC3/400V) 16A/7.5kW main contacts 3NO auxiliary contacts 1NO connection screw connection type K2-16A10230		



1

<b>GEV No.</b>	380637	<b>Ref. No.</b>	054928
<b>description</b>	power contactor resistive load 45A 230VAC main contacts 3NO auxiliary contacts 1NO connection screw type K2-23A10 230		



1

<b>GEV No.</b>	380959	<b>Ref. No.</b>	058670
<b>description</b>	power contactor resistive load 25A 24VAC (AC3/400V) 10A/4kW main contacts 3NO auxiliary contacts 1NO connection screw connection type K3-10ND10 24		



1

<b>GEV No.</b>	381173	<b>Ref. No.</b>	0C9763
<b>description</b>	power contactor resistive load 50A 230VAC (AC3/400V) 24A/11kW main contacts 3NO auxiliary contacts 1NO connection torx type K3-24B00 50/60Hz		



1

<b>GEV No.</b>	380774	<b>Ref. No.</b>	006879
<b>description</b>	power contactor resistive load 32A 230VAC (AC3/400V) 18A/7.5kW main contacts 3NO auxiliary contacts 1NO connection screw connection type K3-18ND10		



1

<b>GEV No.</b>	381085	<b>Ref. No.</b>	0L0355
<b>description</b>	power contactor resistive load 50A 230VAC (AC3/400V) 24A/11kW main contacts 3NO auxiliary contacts connection screw connection type K3-24A00230		



1

<b>GEV No.</b>	380673	<b>Ref. No.</b>	0K3384
<b>description</b>	power contactor resistive load 45A 230VAC (AC3/400V) 11kW		



1

<b>GEV No.</b>	380775	<b>Ref. No.</b>	007080
<b>description</b>	power contactor resistive load 65A 230VAC (AC3/400V) 32A/15kW main contacts 3NO auxiliary contacts connection screw connection type K3-32A00230		

1

<b>GEV No.</b>	380776	<b>Ref. No.</b>	007104
<b>description</b>	power contactor resistive load 80A 230VAC (AC3/400V) 40A/18.5kW main contacts 3NO auxiliary contacts connection screw connection type K3-40A00230 contacts		



1

<b>GEV No.</b>	380676	<b>Ref. No.</b>	OTRA70
<b>description</b>	power contactor resistive load 80A 230VAC (AC3/400V) 45A/20kW main contacts 3NO connection screw connection type K2-45A00230		

auxiliary contacts



1

<b>GEV No.</b>	380677	<b>Ref. No.</b>	047046
<b>description</b>	auxiliary contact contacts 1NC AC15 10A for contactors K2/K3 connection screw type HN01 AC1 25A		



1

<b>GEV No.</b>	380678	<b>Ref. No.</b>	046995
<b>description</b>	auxiliary contact contacts 1NO AC15 10A for contactors K2/K3 connection screw type HN10 AC1 25A		



1

<b>GEV No.</b>	380781	<b>Ref. No.</b>	048497
<b>description</b>	auxiliary contact contacts 1NO AC15 6A for contactors K2/K5 connection screw type HA10 AC1 25A		

ISKRA (FANAL)

power contactors



1

<b>GEV No.</b>	380204	<b>Ref. No.</b>	003027
<b>description</b>	power contactor resistive load 25A 230VAC (AC3/400V) 9A/4kW main contacts 3NO auxiliary contacts 1NO connection screw connection type Fanal DSL9 10 type ISKRA KNL9 10		

ABL SURSUM

motor protection circuit breakers



1

<b>GEV No.</b>	380303	<b>Ref. No.</b>	083472
<b>description</b>	motor protection circuit breaker type Mbs25-063 setting range 4-6.3A (AC3/400V) 3kW		

miscellaneous

power contactors



1

<b>GEV No.</b>	380391	<b>Ref. No.</b>	003305
<b>description</b>	power contactor 230V resistive load 110A (AC3/400V) 55/30kW main contacts 3NO connection screw		



## solid state relays

### CRYDOM



1

<b>GEV No.</b>	403038	<b>Ref. No.</b>	0K5070
<b>description</b>	solid state relay CRYDOM 1 phase 50A 480V 4-32VDC L 57mm W 45mm screw type CWD4850P		

## relays

### power relays

#### with DIN rail mounting

##### upper



1

<b>GEV No.</b>	380183	<b>Ref. No.</b>	048438	
<b>description</b>	power relays FINDER 230VAC 12A 2CO connection male faston 4.8mm DIN rail manuf. no. 56.32.8.230.0007			
<b>accessories for</b>	380183			
	<b>GEV No.</b>	380476	<b>Ref. No.</b>	—
	relay socket dimensions 78x27x33.5mm 250V voltage AC 10A FINDER manuf. no. 96.72			



1

<b>GEV No.</b>	380196	<b>Ref. No.</b>	048611
<b>description</b>	power relays FINDER 230VAC 12A 4CO connection male faston 4.8mm DIN rail manuf. no. 56.34.8.230.0007		

#### with flange mounting



1

<b>GEV No.</b>	380921	<b>Ref. No.</b>	085092
<b>description</b>	plug-in relay 230VAC 16A 2CO connection male faston screw mounting		



1

<b>GEV No.</b>	380131	<b>Ref. No.</b>	046001
<b>description</b>	power relays Italiana Relè 230VAC 16A 3CO connection male faston 6.3mm screw mounting manuf. no. B2-3-230AC		



1

<b>GEV No.</b>	380130	<b>Ref. No.</b>	046380
<b>description</b>	power relays Italiana Relè 230VAC 16A 3NO connection male faston 6.3mm screw mounting manuf. no. B1-3-230AC		

#### with bracket mounting



1

<b>GEV No.</b>	380626	<b>Ref. No.</b>	083215
<b>description</b>	power relays FINDER 230VAC 10A 2CO connection male faston 4.8mm bracket mounting manuf. no. 62.62.8.230.0000		

1

<b>GEV No.</b>	380312	<b>Ref. No.</b>	056466
<b>description</b>	power relays FINDER 230VAC 10A 3CO connection male faston 4.8mm bracket mounting dimensions 52x32.2x36.5mm manuf. no. 60.63.8.230.0000		



1

<b>GEV No.</b>	380702	<b>Ref. No.</b>	005033
<b>description</b>	power relays FINDER 230VAC 16A 3NO connection male faston 6.3mm flange dimensions 36x38x68mm manuf. no. 62.83.8.230.0300 230V		



1

<b>GEV No.</b>	380636	<b>Ref. No.</b>	056510
<b>description</b>	power relays FINDER 24VAC 10A 3CO connection male faston 4.8mm bracket mounting manuf. no. 60.63.8.024.0000		

with special fixing



1

<b>GEV No.</b>	380318	<b>Ref. No.</b>	048888
<b>description</b>	power relays SCHRACK 230VAC 16A 2NO connection coded plug manuf. no. 0419 120301 00 2-pole		

with male contacts

female contact 4.8mm

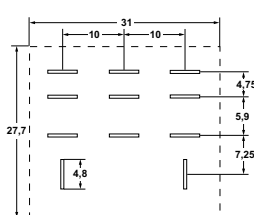

1

<b>GEV No.</b>	380854	<b>Ref. No.</b>	0E5170
<b>description</b>	power relays FINDER 24VAC 16A 3CO connection F4.8 raster size 10mm plug-in connection manuf. no. 62.33.8.024.0000 250V connection 4.8mm		

plug-in/print relays

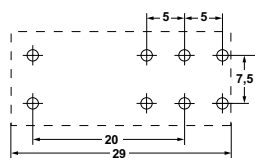
1

<b>GEV No.</b>	380333	<b>Ref. No.</b>	0E5849	
<b>description</b>	print relay 230VAC 2CO at 250V 8A connection pins raster size 5mm FINDER manuf. no. 40.52.8.230.0000 95.65/95.75			
<b>accessories for</b>	380333			
	<b>GEV No.</b>	380340	<b>Ref. No.</b>	—
	relay socket dimensions 62x36x15mm 250V voltage AC 10A Italiana Relè manuf. no. ZMEM/5			
	<b>GEV No.</b>	380505	<b>Ref. No.</b>	—
	relay socket 2CO 40.52 dimensions 81.9x15.5x75mm 250V voltage AC 10A FINDER manuf. no. 95.95.3			
	<b>GEV No.</b>	381181	<b>Ref. No.</b>	—
	relay socket 2-pole 40.51/40.52/40.61 connection screw clamp dimensions 15.8x78.6mm 250V voltage AC 10A FINDER manuf. no. 95.75			

1

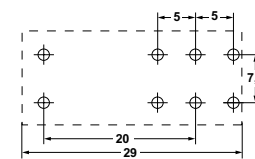
<b>GEV No.</b>	380853	<b>Ref. No.</b>	0E5172
<b>description</b>	print relay 24VAC 1CO at 250V 16A connection pins raster size 5mm FINDER manuf. no. 40.61.8.024.0000 95.65/95.75		



## relay sockets



1

<b>GEV No.</b>	380136	<b>Ref. No.</b>	049236
----------------	--------	-----------------	--------

<b>description</b>	relay socket 11-pole connection plug-in connection round 11-pole dimensions 65x28x40mm 250V voltage AC 10A Italiana Relè manuf. no. ZVE11
--------------------	---

<b>accessories for</b>	380136
------------------------	--------

<b>GEV No.</b>	380805	<b>Ref. No.</b>	—
----------------	--------	-----------------	---



support bracket

## level relays

## GICAR



1

<b>GEV No.</b>	400018	<b>Ref. No.</b>	055458
----------------	--------	-----------------	--------

<b>description</b>	level relay 230V voltage AC connection F6.3 type RL30/3ES/F/G
--------------------	---

## miscellaneous



1

<b>GEV No.</b>	401638	<b>Ref. No.</b>	056496
----------------	--------	-----------------	--------

<b>description</b>	level relay 24V type RL30/3ES/F/G
--------------------	-----------------------------------

## time relays

## time relays



1

<b>GEV No.</b>	380380	<b>Ref. No.</b>	006156
----------------	--------	-----------------	--------

<b>description</b>	time relay FIBER T45Sc25 time range 0s-120h 24VAC 5A mounting measurements 45x45mm connection plug-in connection round 8-pole
--------------------	---



1

<b>GEV No.</b>	380622	<b>Ref. No.</b>	049235
----------------	--------	-----------------	--------

<b>description</b>	time relay FINDER 88.02.0.230.0002 time range 0.05s-100h 24-230V AC/DC 2x8A mounting measurements 45x45mm
--------------------	---

<b>accessories for</b>	380622
------------------------	--------



<b>GEV No.</b>	380667	<b>Ref. No.</b>	—
<b>description</b>	relay socket 11-pole dimensions 56x43x31mm 250V voltage AC 10A FINDER manuf. no. 90.27		



1

<b>GEV No.</b>	360407	<b>Ref. No.</b>	075659
----------------	--------	-----------------	--------

<b>description</b>	timer FINDER T23522203F0 time range 0.5s-120h 24VAC 2x6A mounting measurements 45x70mm 2CO
--------------------	--

## transformers

## open transformers

## with clamp terminal



1

<b>GEV No.</b>	401266	<b>Ref. No.</b>	056512
----------------	--------	-----------------	--------

<b>description</b>	transformer primary 230V secondary 12/24V 100VA
--------------------	---



toroidal core transformers

1



<b>GEV No.</b>	401663	<b>Ref. No.</b>	OL0174
<b>description</b>	transformer primary 230V secondary 12V 25VA		

1



<b>GEV No.</b>	379395	<b>Ref. No.</b>	006159
<b>description</b>	transformer primary 240V secondary 24V 200VA		

encapsulated transformers

with screw connection

1



<b>GEV No.</b>	401665	<b>Ref. No.</b>	OL1158
<b>description</b>	transformer primary 230/400V secondary 24-48V 400VA connection screw 50-60Hz		

PMA

1



<b>GEV No.</b>	401267	<b>Ref. No.</b>	007045
<b>description</b>	transformer primary 230V secondary 12/24V 60/40VA secondary 5/1.7A connection screw 50Hz		

1



<b>GEV No.</b>	379054	<b>Ref. No.</b>	083833
<b>description</b>	transformer primary 230VAC secondary 12VAC 3VA secondary 0.25A H 40mm L 45mm W 50mm connection screw 50/60Hz type 153/M		

for lighting

1



<b>GEV No.</b>	401547	<b>Ref. No.</b>	002856
<b>description</b>	transformer primary 230V secondary 11.5V 50W		

miscellaneous

1



<b>GEV No.</b>	403448	<b>Ref. No.</b>	083389
<b>description</b>	transformer for blast chiller suitable for ZANUSSI		

electronic controllers

ELIWELL

universal controllers

built-in version

1



<b>GEV No.</b>	379559	<b>Ref. No.</b>	050989	
<b>description</b>	electronic controller ELIWELL type IC901 mounting measurements 71x29mm 12V voltage AC/DC NTC/PTC relay outputs 1 relay refrigeration front measurements 74x32mm built-in depth 60mm protection IP65 accuracy superior to 0.5% from final value% defr. funct. no -55 up to +150°C display 2½ digit Templn1 yes 15A			
<b>accessories for</b>	379559			
	<b>GEV No.</b>	379053	<b>Ref. No.</b>	—
	temperature probe PTC 1kOhm cable PVC probe -50 up to +150°C cable -10 up to 100°C probe ø6x30mm cable length 3m without screw connection 2-wire			

Table continues overleaf



<b>accessories for</b>	379559			
	GEV No.	379064	Ref. No.	0D6591 710A9600
	temperature probe PTC 1kOhm cable silicone probe -50 up to +150°C cable -50 up to +180°C probe ø6x40mm cable length 3m without screw connection 2-wire			
	GEV No.	379161	Ref. No.	0A9498
	temperature probe NTC 10kOhm cable thermoplastic probe -40 up to +110°C cable -40 up to +110°C probe ø6x14mm cable length 3m without screw connection 2-wire			
	GEV No.	379782	Ref. No.	—
	temperature probe PTC 1kOhm cable thermoplastic probe -50 up to +150°C cable -40 up to +110°C probe ø6x14mm cable length 3m 2-wire resistor 1kOhm			



1

<b>GEV No.</b>	379562	<b>Ref. No.</b>	091357	
<b>description</b>	electronic controller ELIWELL type IC902 mounting measurements 71x29mm 12V voltage AC/DC NTC/PTC relay outputs 1 relay front measurements 74x32mm built-in depth 61 mm protection IP65 accuracy superior to 0.5% from final value% defr. funct. no -55 up to +150°C display 2½ digit TempIn1 yes 8A			
<b>accessories for</b>	379562			
	GEV No.	379052	Ref. No.	—
	temperature probe PTC 1kOhm cable silicone probe -50 up to +150°C cable -50 up to +180°C probe ø6x40mm cable length 1.5m without screw connection 2-wire			
	GEV No.	379064	Ref. No.	0D6591 710A9600
	temperature probe PTC 1kOhm cable silicone probe -50 up to +150°C cable -50 up to +180°C probe ø6x40mm cable length 3m without screw connection 2-wire			
	GEV No.	379161	Ref. No.	0A9498
	temperature probe NTC 10kOhm cable thermoplastic probe -40 up to +110°C cable -40 up to +110°C probe ø6x14mm cable length 3m without screw connection 2-wire			
	GEV No.	379782	Ref. No.	—
	temperature probe PTC 1kOhm cable thermoplastic probe -50 up to +150°C cable -40 up to +110°C probe ø6x14mm cable length 3m 2-wire resistor 1kOhm			





1

<b>GEV No.</b>	379714	<b>Ref. No.</b>	0C3100	
<b>description</b>	electronic controller ELIWELL type IC912 model IC11J00THD701 mounting measurements 71x29mm 230V voltage AC TC-J (TC-K - Pt100) relay outputs 1 relay CO-8A(3) TC-J (TC-K - Pt100) front measurements 74x32mm protection IP65 -150 to 1350°C display 3½ digits			
<b>accessories for</b>	379714			
	GEV No.	378074	Ref. No.	—
	temperature probe thermocouple J (Fe-CuNi) cable Vetrotex probe -50 up to +750°C cable -50 up to +350°C probe ø3x100mm cable length 3m without screw connection 2-wire			

<b>accessories for</b>	379714			
	GEV No.	378075	Ref. No.	—
	temperature probe thermocouple K (NiCr-Ni) cable Vetrotex probe -50 up to 1150°C cable -50 up to +350°C probe ø4.5x150mm cable length 3m without screw connection 2-wire			
	GEV No.	379051	Ref. No.	—
	temperature probe thermocouple J (Fe-CuNi) cable Vetrotex probe -50 up to +750°C cable -50 up to +350°C probe ø6x100mm cable length 3m without screw connection cable colours red/blue 2-wire			
	GEV No.	379062	Ref. No.	—
	temperature probe thermocouple J (Fe-CuNi) cable Vetrotex probe -50 up to +750°C cable -50 up to +350°C probe ø6x50mm cable length 3m without screw connection 2-wire			



1

<b>GEV No.</b>	379567	<b>Ref. No.</b>	0C3421	
<b>description</b>	electronic controller ELIWELL type ICPlus902 model ICP11J0550000 mounting measurements 71x29mm 24V voltage AC Pt100/TC (J,K) relay outputs 1 CO-8A(3) Pt100/TC (J,K) built-in depth 60mm defr. funct. -150 to 1350°C display 3½ digits			
<b>accessories for</b>	379567			
	GEV No.	378064	Ref. No.	—
	alarm device AKO type AKO-520631 mounting measurements 214x214mm 230V voltage AC relay outputs 1 CO-8A(4) up to 1 front measurements 222x222mm protection accuracy% yes yes			
	GEV No.	378075	Ref. No.	—
	temperature probe thermocouple K (NiCr-Ni) cable Vetrotex probe -50 up to 1150°C cable -50 up to +350°C probe ø4.5x150mm cable length 3m without screw connection 2-wire			
	GEV No.	379050	Ref. No.	—
	temperature probe Pt100 cable Vetrotex probe -200 up to +600°C cable -50 up to +350°C probe ø6x100mm cable length 2.7m without screw connection 3-wire			
	GEV No.	379062	Ref. No.	—
	temperature probe thermocouple J (Fe-CuNi) cable Vetrotex probe -50 up to +750°C cable -50 up to +350°C probe ø6x50mm cable length 3m without screw connection 2-wire			
	GEV No.	379131	Ref. No.	—
	temperature probe Pt100 cable Vetrotex probe -200 up to +600°C cable -50 up to +350°C probe ø6x85mm cable length 3m without screw connection 3-wire resistance at 0°C 100Ohm			
	GEV No.	400583	Ref. No.	—
	transformer primary 230VAC secondary 24VAC 10VA secondary 0.4A connection screw 50Hz			





refrigeration controllers

built-in version



1	<b>GEV No.</b>	379025	<b>Ref. No.</b>	050786
<b>description</b>	electronic controller ELIWELL type ID961LX mounting measurements 71x29mm 230V voltage AC NTC/PTC relay outputs 1 front measurements 76.2x35mm protection IP65 -55 up to +150°C display 3½ digits			



1	<b>GEV No.</b>	378135	<b>Ref. No.</b>	087780
<b>description</b>	electronic controller ELIWELL type ID974 mounting measurements 71x29mm 12V voltage AC/DC NTC/PTC relay outputs 3 relays -50 up to +150°C display 3½ digits RoomTempIN yes DEF Probe yes DEF Relay 8A fan relay 8A compressor relay 15A			
<b>accessories for</b>	378135			
	<b>GEV No.</b>	379053	<b>Ref. No.</b>	—
	temperature probe PTC 1kOhm cable PVC probe -50 up to +150°C cable -10 up to 100°C probe ø6x30mm cable length 3m without screw connection 2-wire			
	<b>GEV No.</b>	379064	<b>Ref. No.</b>	0D6591 710A9600
	temperature probe PTC 1kOhm cable silicone probe -50 up to +150°C cable -50 up to +180°C probe ø6x40mm cable length 3m without screw connection 2-wire			
	<b>GEV No.</b>	379161	<b>Ref. No.</b>	0A9498
	temperature probe NTC 10kOhm cable thermoplastic probe -40 up to +110°C cable -40 up to +110°C probe ø6x14mm cable length 3m without screw connection 2-wire			
	<b>GEV No.</b>	379782	<b>Ref. No.</b>	—
	temperature probe PTC 1kOhm cable thermoplastic probe -50 up to +150°C cable -40 up to +110°C probe ø6x14mm cable length 3m 2-wire resistor 1kOhm			

accessories

load modules



1	<b>GEV No.</b>	379056	<b>Ref. No.</b>	083196
<b>description</b>	load module ELIWELL type EWDR Slave 230V voltage AC			

SHANGFANG

accessories



1	<b>GEV No.</b>	379054	<b>Ref. No.</b>	083833
<b>description</b>	transformer primary 230VAC secondary 12VAC 3VA secondary 0.25A H 40mm L 45mm W 50mm connection screw 50/60Hz type 153/M			

miscellaneous

electronic thermometers



1	<b>GEV No.</b>	379022	<b>Ref. No.</b>	082875
<b>description</b>	thermometer mounting measurements 28.5x70.5mm -55 up to +99°C type EWTM 101			

speed controllers



1	<b>GEV No.</b>	402957	<b>Ref. No.</b>	032279
<b>description</b>	speed controller voltage input 230V voltage output 46-184V/115-230VV 1200W max. 10A load current 6A wall-mounted version length external size 135mm width external size 74mm D 72mm for range hoods			



			
1			
<b>GEV No.</b>	402956	<b>Ref. No.</b>	032986
<b>description</b>	speed controller voltage input 230V vottage output min. 69-138/max. 110-230VV 1800W max. 13A load current 8A wall-mounted version length external size 170mm width external size 105mm D 82mm for range hoods		

program switches

			
1			
<b>GEV No.</b>	400992	<b>Ref. No.</b>	006966
<b>description</b>	electronic controller CROUZET relay outputs 4 relays 100-240V ACV		

probes  
universal probes

temperature probes

			
1			
<b>GEV No.</b>	379161	<b>Ref. No.</b>	0A9498
<b>description</b>	temperature probe NTC 10kOhm cable thermoplastic probe -40 up to +110°C cable -40 up to +110°C probe ø6x14mm cable length 3m without screw connection 2-wire		

			
1			
<b>GEV No.</b>	379064	<b>Ref. No.</b>	0D6591 710A9600
<b>description</b>	temperature probe PTC 1kOhm cable silicone probe -50 up to +150°C cable -50 up to +180°C probe ø6x40mm cable length 3m without screw connection 2-wire		

			
1			
<b>GEV No.</b>	379693	<b>Ref. No.</b>	004116
<b>description</b>	temperature probe thermocouple J (Fe-CuNi) cable Vetrotex probe 0 up to +350°C cable°C probe ø6x100mm cable length 1.35m without screw connection cable colours red/blue 2-wire		

producer-specific probes

probes

			
1			
<b>GEV No.</b>	400714	<b>Ref. No.</b>	087346
<b>description</b>	temperature probe NTC 100kOhm cable PVC probe -40 up to +125°C cable -10 up to 100°C connection male faston thread probe ø7x25mm cable length 3m		

			
1			
<b>GEV No.</b>	402201	<b>Ref. No.</b>	092175
<b>description</b>	temperature probe NTC 10kOhm cable PVC probe -40 up to +110°C cable -10 up to 100°C connection 2-wire thread probe ø6x20mm cable length 3m		

			
1			
<b>GEV No.</b>	379633	<b>Ref. No.</b>	092176
<b>description</b>	temperature probe NTC 10kOhm cable PVC probe -40 up to +110°C cable -10 up to 100°C connection 2-wire thread probe ø6x20mm cable length 4m		

			
1			
<b>GEV No.</b>	402199	<b>Ref. No.</b>	092184
<b>description</b>	temperature probe NTC 10kOhm cable PVC probe -40 up to +110°C cable -10 up to 100°C connection plug thread probe ø6x20mm cable length 1.5m		

			
1			
<b>GEV No.</b>	402155	<b>Ref. No.</b>	092177
<b>description</b>	temperature probe NTC 10kOhm cable PVC probe -40 up to +110°C cable -10 up to 100°C connection plug thread probe ø6x20mm cable length 2m		

			
1			
<b>GEV No.</b>	402200	<b>Ref. No.</b>	092174
<b>description</b>	temperature probe NTC 10kOhm cable silicone probe -40 up to +110°C cable -50 up to +180°C connection 2-wire thread probe ø6x200mm cable length 2m		

			
1			
<b>GEV No.</b>	379918	<b>Ref. No.</b>	006609
<b>description</b>	temperature probe NTC 200kOhm cable PTFE probe -40 up to +125°C cable -40 up to +250°C connection plug thread probe ø4x40mm cable length 1m		

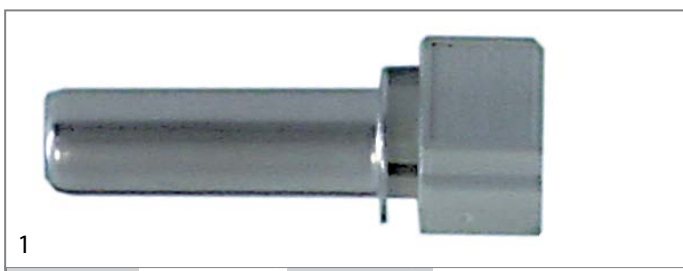

1			
<b>GEV No.</b>	379902	<b>Ref. No.</b>	049643
<b>description</b>	temperature probe NTC 4.8kOhm cable probe -10 up to 100°C cable°C connection male faston 6.3mm thread probe ø10x30mm cable lengthm		

<b>accessories for</b>	379902		
------------------------	--------	--	--

	<b>GEV No.</b>	504574	<b>Ref. No.</b>	046376
	O-ring EPDM thickness 1.78mm ID ø 9.25mm Qty 1 pcs			

	<b>GEV No.</b>	504757	<b>Ref. No.</b>	0L0280
	screw connection ID ø 10mm for probe			

<b>GEV No.</b>	379901	<b>Ref. No.</b>	049884
<b>description</b>	temperature probe NTC 4.8kOhm cable PVC probe -40 up to +110°C cable -10 up to 100°C connection male faston 6.3mm thread probe ø6x50mm cable length 0.1m		

<b>GEV No.</b>	379924	<b>Ref. No.</b>	006155
<b>description</b>	temperature probe Pt100 cable PTFE probe -100 up to 450°C cable -40 up to +250°C connection 1-wire thread probe ø4x40mm cable length 1.5m		

<b>GEV No.</b>	379921	<b>Ref. No.</b>	058953
<b>description</b>	temperature probe Pt100 cable PTFE probe -100 up to 450°C cable -40 up to +250°C connection 3-wire thread M8 probe ø4x20mm cable length 1.5m		

<b>GEV No.</b>	379719	<b>Ref. No.</b>	0H2430 0K8027
<b>description</b>	temperature probe Pt100 cable PTFE probe -100 up to 450°C cable -40 up to +250°C connection bullet receptacle ø2mm thread M8x1.25 probe ø3x90mm cable length 1m		

<b>GEV No.</b>	379144	<b>Ref. No.</b>	0H6481
<b>description</b>	temperature probe Pt100 cable silicone probe -100 up to 450°C cable -50 up to +180°C connection 2-wire thread probe ø3/3.5x40/180mm cable length 1.9m		

<b>GEV No.</b>	379107	<b>Ref. No.</b>	058669
<b>description</b>	temperature probe Pt100 probe -100 up to 450°C cable -40 up to +250°C connection 2-wire thread probe ø5x50mm cable length 1.4m		

<b>GEV No.</b>	379404	<b>Ref. No.</b>	0K8490
<b>description</b>	temperature probe Pt1000 cable glass fibre probe -70 up to +500°C cable -50 up to +350°C connection male faston thread probe ø4x60mm cable length 1.6m		

<b>GEV No.</b>	378335	<b>Ref. No.</b>	710E5990
<b>description</b>	temperature probe Pt1000 cable silicone probe -50 up to +200°C cable -50 up to +180°C connection coded plug thread probe ø6x50mm cable length 6m		

<b>GEV No.</b>	379100	<b>Ref. No.</b>	0C5342
<b>description</b>	temperature probe Pt1000 cable silicone probe -70 up to +500°C cable -50 up to +180°C connection male faston 4.8mm thread probe ø4x235mm cable length 1.8m		

<b>accessories for</b>	379100		
	<b>GEV No.</b>	693745	<b>Ref. No.</b> 002624
	<b>GEV No.</b>	697993	<b>Ref. No.</b> —

<b>GEV No.</b>	402006	<b>Ref. No.</b>	086369
<b>description</b>	temperature probe PTC 2kOhm cable PVC probe -50 up to +150°C cable -10 up to 100°C connection plug thread probe ø5x60mm cable length 1.5m		

<b>GEV No.</b>	402005	<b>Ref. No.</b>	086344
<b>description</b>	temperature probe PTC 2kOhm cable TPE probe -50 up to +150°C cable -40 up to +110°C connection plug thread probe ø6x50mm cable length 1.6m		

<b>GEV No.</b>	379717	<b>Ref. No.</b>	0C0326 0C6539
<b>description</b>	temperature probe thermocouple K (NiCr-Ni) cable PTFE probe -50 up to 1150°C cable -40 up to +250°C connection plug thread probe ø4x70mm cable length 1.1m		

<b>GEV No.</b>	379715	<b>Ref. No.</b>	0C0324 0C6538
<b>description</b>	temperature probe thermocouple K (NiCr-Ni) cable PVC probe -50 up to 1150°C cable -10 up to 100°C connection plug thread probe ø4x70mm cable length 0.5m		

<b>GEV No.</b>	379716	<b>Ref. No.</b>	0C0325
<b>description</b>	temperature probe thermocouple K (NiCr-Ni) cable PVC probe -50 up to 1150°C cable -10 up to 100°C connection plug thread probe ø4x70mm cable length 0.85m		

<b>GEV No.</b>	379889	<b>Ref. No.</b>	0C3457
<b>description</b>	temperature probe thermocouple K (NiCr-Ni) cable PVC probe -50 up to 1150°C cable -10 up to 100°C connection plug thread probe ø4x70mm cable length 2m		





			
<b>GEV No.</b>	379098	<b>Ref. No.</b>	OK5623
<b>description</b>	temperature probe thermocouple K (NiCr-Ni) cable Vetrotex probe -50 up to 1150°C cable -50 up to +350°C connection 2-wire thread M6/M10 probe ø6x20mm cable length 2.1m		

			
<b>GEV No.</b>	379145	<b>Ref. No.</b>	0H6269
<b>description</b>	temperature probe thermocouple K (NiCr-Ni) cable Vetrotex probe -50 up to 1150°C cable -50 up to +350°C connection 2-wire thread probe ø3x100mm cable length 2m		

			
<b>GEV No.</b>	379713	<b>Ref. No.</b>	004209 0C3567
<b>description</b>	temperature probe thermocouple K (NiCr-Ni) cable Vetrotex probe -50 up to 1150°C cable -50 up to +350°C connection 2-wire thread probe ø3x200mm cable length 1.5m		

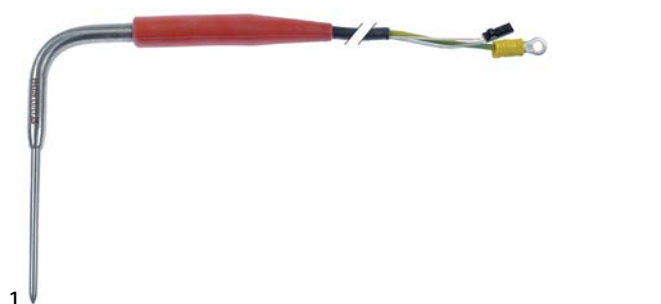
core probes

			
<b>GEV No.</b>	401944	<b>Ref. No.</b>	092704
<b>description</b>	core temperature probe NTC 10kOhm cable silicone probe -40 up to +120°C cable -50 up to +180°C connection plug probe ø5x80mm thread cable length 3m handle ø 10mm handle length 100mm L1 150mm L2 70mm		

			
<b>GEV No.</b>	379037	<b>Ref. No.</b>	059002
<b>description</b>	core temperature probe Pt100 cable SS corrugated hose probe -40 up to +250°C cable -40 up to +250°C connection 2-wire probe ø4x100mm thread M12 cable length 2.2m handle ø 9mm handle length 90mm		

			
<b>GEV No.</b>	379961	<b>Ref. No.</b>	002330
<b>description</b>	core temperature probe Pt100 cable SS corrugated hose probe -40 up to +250°C cable -40 up to +250°C connection 2-wire probe ø4x100mm thread M12 cable length 2.8m handle ø 9mm handle length 80mm		

			
<b>GEV No.</b>	379721	<b>Ref. No.</b>	0E3423 0H2363 0H2364 0K7782 0K7784 0K7785 0K8594
<b>description</b>	core temperature probe Pt100 cable SS corrugated hose probe -40 up to +250°C cable -40 up to +250°C connection bullet receptacle ø2mm probe ø4x100mm thread M16x1 cable length 3.9m handle ø 10mm handle length 45mm		

			
<b>GEV No.</b>	379095	<b>Ref. No.</b>	055472
<b>description</b>	core temperature probe Pt100 cable SS corrugated hose probe -40 up to +250°C cable -40 up to +250°C connection coded plug probe ø4x100mm thread M12 cable length 1.45m handle ø 9mm handle length 85mm		

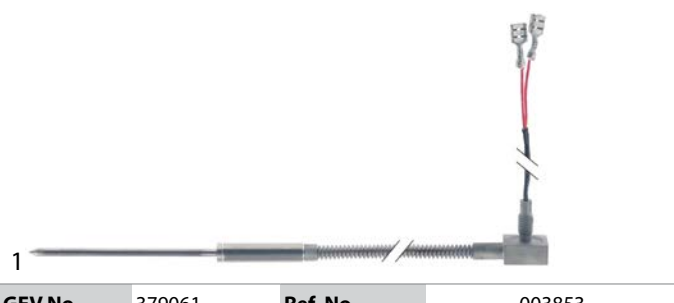
			
<b>GEV No.</b>	379061	<b>Ref. No.</b>	003853
<b>description</b>	core temperature probe Pt1000 cable SS corrugated hose probe -40 up to +250°C cable -40 up to +250°C connection 2-wire probe ø4x100mm thread M8 cable length 2.5m handle ø 10mm handle length 45mm		

			
<b>GEV No.</b>	379060	<b>Ref. No.</b>	002673
<b>description</b>	core temperature probe Pt1000 cable SS corrugated hose probe -40 up to +250°C cable -40 up to +250°C connection 2-wire probe ø4x100mm thread M8 cable length 2m handle ø 10mm handle length 45mm		

			
<b>GEV No.</b>	379406	<b>Ref. No.</b>	006192
<b>description</b>	core temperature probe Pt1000 cable SS corrugated hose probe -40 up to +250°C cable -40 up to +250°C connection 2-wire probe ø4x100mm thread M8 cable length 2m handle ø 10mm handle length 50mm		

1

<b>GEV No.</b>	379976	<b>Ref. No.</b>	002821
<b>description</b>	core temperature probe Pt1000 cable SS corrugated hose probe -40 up to +250°C cable -40 up to +250°C connection male faston 6.3mm probe ø4x100mm thread M8 cable length 3.1m handle ø 9mm handle length 50/55mm		



1

<b>GEV No.</b>	379977	<b>Ref. No.</b>	006174
<b>description</b>	core temperature probe Pt1000 cable SS corrugated hose probe -40 up to +250°C cable -40 up to +250°C connection male faston probe ø4x100mm thread cable length 2.6m handle ø 10mm handle length 50mm		



1

<b>GEV No.</b>	379964	<b>Ref. No.</b>	006525
<b>description</b>	core temperature probe Pt1000 cable SS corrugated hose probe -40 up to +250°C cable -40 up to +250°C connection male faston probe ø5.5x110mm thread cable length 2.5m handle ø 10mm handle length 100mm		



1

<b>GEV No.</b>	379965	<b>Ref. No.</b>	006526
<b>description</b>	core temperature probe Pt1000 cable SS corrugated hose probe -40 up to +250°C cable -40 up to +250°C connection male faston probe ø5x100mm thread cable length 2.6m handle ø 10mm handle length 100mm		



1

<b>GEV No.</b>	379954	<b>Ref. No.</b>	006527
<b>description</b>	core temperature probe Pt1000 cable SS corrugated hose probe -40 up to +250°C cable -40 up to +250°C connection plug probe ø5x100mm thread M8 cable length 3.2m handle ø 9mm handle length 50/50mm		



1

<b>GEV No.</b>	379620	<b>Ref. No.</b>	088044
<b>description</b>	core temperature probe PTC 1kOhm cable silicone probe -40 up to +120°C cable -50 up to +180°C connection 2-wire probe ø4.5x80mm thread cable length 4m handle ø 10mm handle length 120mm L1 150mm L2 60mm		

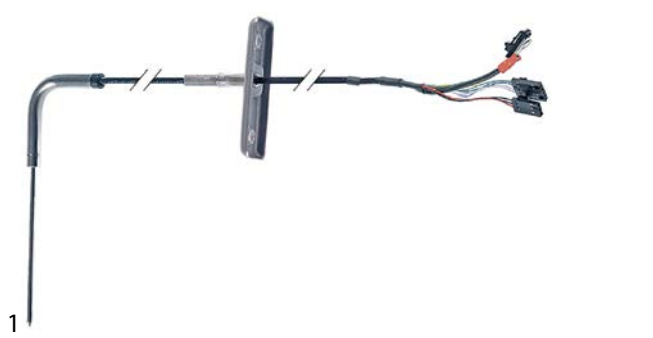

1

<b>GEV No.</b>	381513	<b>Ref. No.</b>	0C4240 0CB214
<b>description</b>	core temperature probe thermocouple K (NiCr-Ni) cable PTFE probe -40 up to +250°C cable -40 up to +250°C connection plug probe ø3.5x100mm thread cable length 2.2m handle ø 9mm handle length 45/50mm		

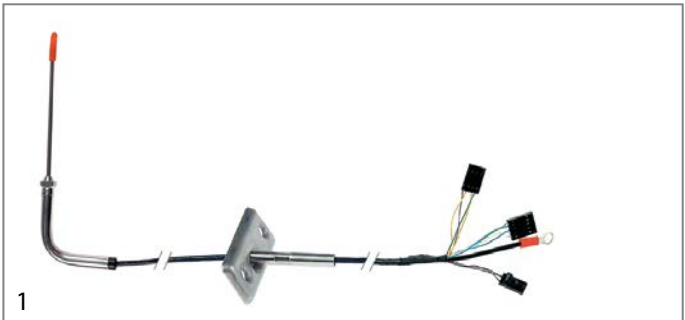

1

<b>GEV No.</b>	379956	<b>Ref. No.</b>	006982
<b>description</b>	core temperature probe thermocouple K (NiCr-Ni) cable PTFE probe -40 up to +250°C cable -40 up to +250°C connection plug probe ø3.5x100mm thread cable length 2.5m handle ø 9mm handle length 45/50mm		



1

<b>GEV No.</b>	379958	<b>Ref. No.</b>	006983
<b>description</b>	core temperature probe thermocouple K (NiCr-Ni) cable PTFE probe -40 up to +250°C cable -40 up to +250°C connection plug probe ø3.5x100mm thread cable length 2.5m handle ø 9mm handle length 45/50mm		

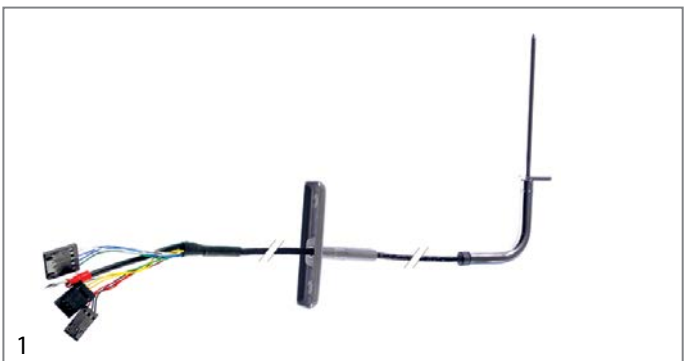

1

<b>GEV No.</b>	379969	<b>Ref. No.</b>	0C1164
<b>description</b>	core temperature probe thermocouple K (NiCr-Ni) cable PTFE probe -40 up to +250°C cable -40 up to +250°C connection plug probe ø3.5x100mm thread cable length 2.5m handle ø 9mm handle length 45/50mm		

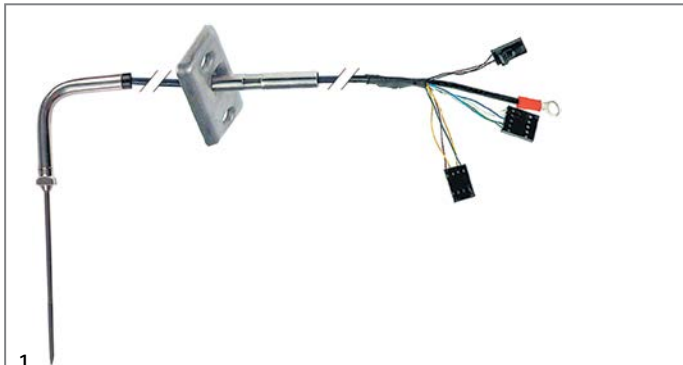

1

<b>GEV No.</b>	379955	<b>Ref. No.</b>	007109
<b>description</b>	core temperature probe thermocouple K (NiCr-Ni) cable PTFE probe -40 up to +250°C cable -40 up to +250°C connection plug probe ø3.5x100mm thread cable length 2.6m handle ø 9mm handle length 45/50mm		

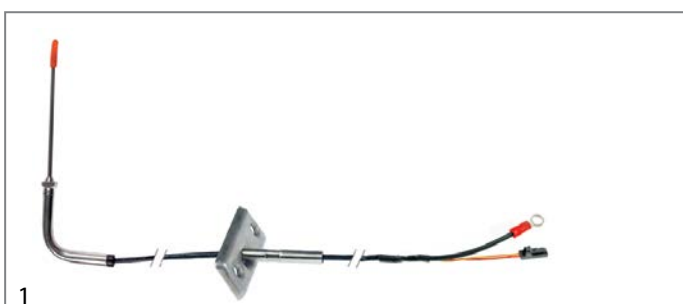

1

<b>GEV No.</b>	379957	<b>Ref. No.</b>	007063
<b>description</b>	core temperature probe thermocouple K (NiCr-Ni) cable PTFE probe -40 up to +250°C cable -40 up to +250°C connection plug probe ø3.5x100mm thread cable length 2.6m handle ø 9mm handle length 45/50mm		

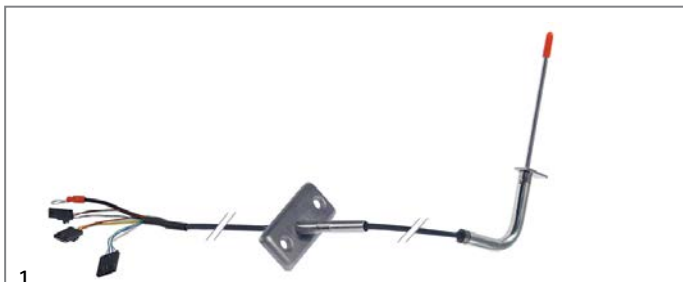

1

<b>GEV No.</b>	379960	<b>Ref. No.</b>	0C0956
<b>description</b>	core temperature probe thermocouple K (NiCr-Ni) cable PTFE probe -40 up to +250°C cable -40 up to +250°C connection plug probe ø3.5x100mm thread cable length 2.6m handle ø 9mm handle length 45/50mm		

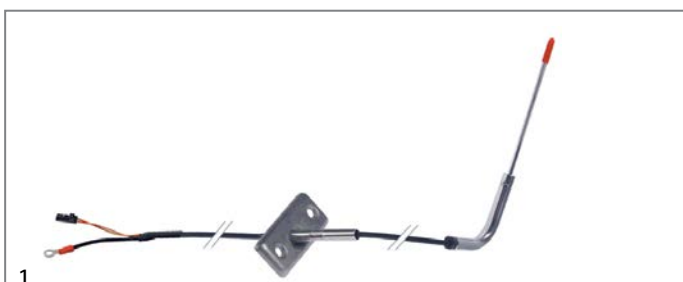

1

<b>GEV No.</b>	379959	<b>Ref. No.</b>	0C1383
<b>description</b>	core temperature probe thermocouple K (NiCr-Ni) cable PTFE probe -40 up to +250°C cable -40 up to +250°C connection plug probe ø3.5x100mm thread cable length 3.2m handle ø 9mm handle length 45/50mm		

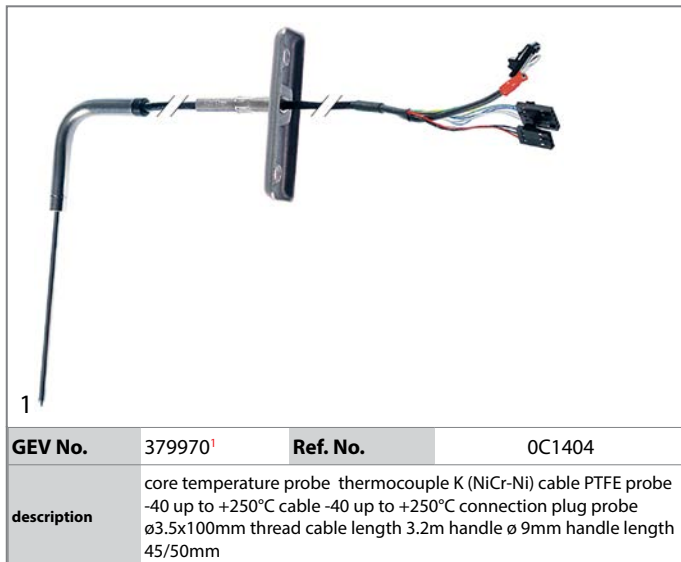

1			
<b>GEV No.</b>	379970 <sup>1</sup>	<b>Ref. No.</b>	0C1404
<b>description</b>	core temperature probe thermocouple K (NiCr-Ni) cable PTFE probe -40 up to +250°C cable -40 up to +250°C connection plug probe ø3.5x100mm thread cable length 3.2m handle ø 9mm handle length 45/50mm		

<sup>1</sup> multipoint probe



1			
<b>GEV No.</b>	379967	<b>Ref. No.</b>	0C0225
<b>description</b>	core temperature probe thermocouple K (NiCr-Ni) cable PTFE probe -40 up to +250°C cable -40 up to +250°C connection plug probe ø3.5x90mm thread cable length 3.1m handle ø 9mm handle length 45/50mm		

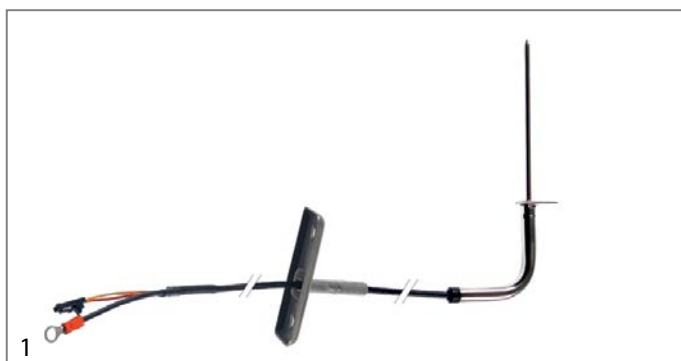

1			
<b>GEV No.</b>	379968	<b>Ref. No.</b>	0C1146
<b>description</b>	core temperature probe thermocouple K (NiCr-Ni) cable PTFE probe -50 up to +250°C cable -50 up to +250°C connection plug probe ø3.5x100mm thread cable length 3.9m handle ø 9mm handle length 45/50mm		

1			
<b>GEV No.</b>	378185	<b>Ref. No.</b>	083582
<b>description</b>	temperature probe PTC 1kOhm cable silicone probe -50 up to +150°C cable -50 up to +180°C connection 2-wire probe ø5x100mm thread cable length 3m handle ø 13.5mm handle length 90mm -40 up to +150°C		

sensors

1			
<b>GEV No.</b>	379966	<b>Ref. No.</b>	006995 0C6465
<b>description</b>	lambda sensor probe ø 12mm 5-pole probe L 50mm		
<b>accessories for</b>	379966		
	<b>GEV No.</b>	101248	<b>Ref. No.</b> 050682
	<b>GEV No.</b>	101251	<b>Ref. No.</b> —

1			
<b>GEV No.</b>	401664	<b>Ref. No.</b>	0L0456
<b>description</b>	sensor L 50mm thread M12x1 cable length 2000m		

accessories

fasteners

1			
	<b>GEV No.</b>	693748	<b>Ref. No.</b> 002674
<b>description</b>	bracket for core temperature probe		

miscellaneous

1			
	<b>GEV No.</b>	550924	<b>Ref. No.</b> 002075
<b>description</b>	gasket for probe ID ø 6mm EPDM		



# electronics

## rectifiers

electric components



1

<b>GEV No.</b>	401257	<b>Ref. No.</b>	002715
<b>description</b>	plug with rectifier		

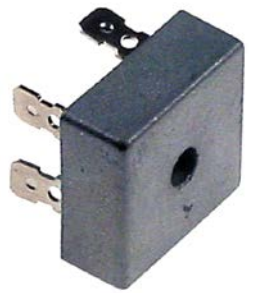

1

<b>GEV No.</b>	379396	<b>Ref. No.</b>	006147
<b>description</b>	rectifier		

## PCBs



1

<b>GEV No.</b>	400179	<b>Ref. No.</b>	0C3758
<b>description</b>	control PCB combi-steamer FCV/G 101/1 102/1		



1

<b>GEV No.</b>	400188	<b>Ref. No.</b>	002725
<b>description</b>	control PCB combi-steamer FCV/G 101/1 102/1		



1

<b>GEV No.</b>	400184	<b>Ref. No.</b>	0C3765
<b>description</b>	control PCB with keypad		



1

<b>GEV No.</b>	400741	<b>Ref. No.</b>	0C6364
<b>description</b>	keypad PCB		



1

<b>GEV No.</b>	400916	<b>Ref. No.</b>	0L0552
<b>description</b>	keypad PCB		



1

<b>GEV No.</b>	401667	<b>Ref. No.</b>	0C3759
<b>description</b>	keypad PCB		



1

<b>GEV No.</b>	401742	<b>Ref. No.</b>	087338
<b>description</b>	keypad PCB		

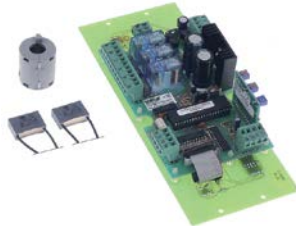



1

<b>GEV No.</b>	401743	<b>Ref. No.</b>	084714
<b>description</b>	keypad PCB		



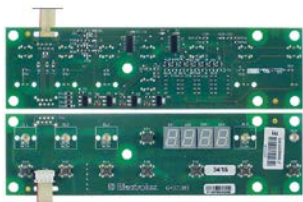

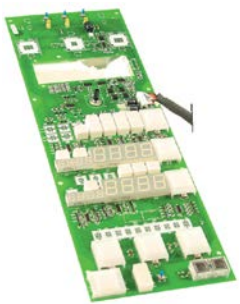

			
1			
<b>GEV No.</b>	401745	<b>Ref. No.</b>	087481
<b>description</b>	keypad PCB		

			
1			
<b>GEV No.</b>	400747	<b>Ref. No.</b>	0C0043
<b>description</b>	keypad PCB combi-steamer FCZ06/10/20		

			
1			
<b>GEV No.</b>	400749	<b>Ref. No.</b>	0C0041
<b>description</b>	keypad PCB combi-steamer FCZ06/10/20		

			
1			
<b>GEV No.</b>	400923	<b>Ref. No.</b>	0L1627
<b>description</b>	keypad PCB dishwasher LS14/ET12		

			
1			
<b>GEV No.</b>	401753	<b>Ref. No.</b>	085925
<b>description</b>	keypad PCB for HACCP with main PCB		

			
1			
<b>GEV No.</b>	404003	<b>Ref. No.</b>	0C0025
<b>description</b>	keypad PCB for induction device		

			
1			
<b>GEV No.</b>	400996	<b>Ref. No.</b>	0C6362
<b>description</b>	main PCB		

			
1			
<b>GEV No.</b>	401586	<b>Ref. No.</b>	006673
<b>description</b>	main PCB		

			
1			
<b>GEV No.</b>	400189	<b>Ref. No.</b>	006674
<b>description</b>	main PCB combi-steamer 260200-245		



1

<b>GEV No.</b>	403025	<b>Ref. No.</b>	0C4347
<b>description</b>	main PCB combi-steamer COP35 LIV. ACTIVE L 334mm W 110mm 230V		



1

<b>GEV No.</b>	400752	<b>Ref. No.</b>	0C1071
<b>description</b>	PCB		



1

<b>GEV No.</b>	401637	<b>Ref. No.</b>	0L1811
<b>description</b>	main PCB dishwasher		



1

<b>GEV No.</b>	400929	<b>Ref. No.</b>	048926
<b>description</b>	PCB		



1

<b>GEV No.</b>	400205	<b>Ref. No.</b>	0A8287
<b>description</b>	PCB		



1

<b>GEV No.</b>	400930	<b>Ref. No.</b>	049150
<b>description</b>	PCB		



1

<b>GEV No.</b>	400931	<b>Ref. No.</b>	049141
<b>description</b>	PCB		



1

<b>GEV No.</b>	400744	<b>Ref. No.</b>	003763
<b>description</b>	PCB		



1

<b>GEV No.</b>	400932	<b>Ref. No.</b>	049147
<b>description</b>	PCB		



1

<b>GEV No.</b>	401130	<b>Ref. No.</b>	003689
<b>description</b>	PCB		





1

<b>GEV No.</b>	401343	<b>Ref. No.</b>	059033
<b>description</b>	PCB		



1

<b>GEV No.</b>	401744	<b>Ref. No.</b>	092562
<b>description</b>	PCB		
<b>accessories for</b>	401744		
	<b>GEV No.</b>	403477	<b>Ref. No.</b>
			—
	cable harness L 800mm suitable for ELECTROLUX, ZANUSSI connection coded plug		



1

<b>GEV No.</b>	400187	<b>Ref. No.</b>	002666
<b>description</b>	PCB combi-steamer FCV/G 101/1 102/1		



1

<b>GEV No.</b>	400751	<b>Ref. No.</b>	007047
<b>description</b>	PCB combi-steamer FCZ06/10/20 level A		



1

<b>GEV No.</b>	360275	<b>Ref. No.</b>	049411
<b>description</b>	PCB dishwasher LS 32/60 + WT 302/60		



1

<b>GEV No.</b>	360276	<b>Ref. No.</b>	049412
<b>description</b>	PCB dishwasher LS 33/60 + WT 303/60		



1

<b>GEV No.</b>	400928	<b>Ref. No.</b>	048833
<b>description</b>	PCB dishwasher LS61-LS62		



1

<b>GEV No.</b>	400917	<b>Ref. No.</b>	0L1810
<b>description</b>	PCB dishwasher WT 4		



1

<b>GEV No.</b>	402003	<b>Ref. No.</b>	086368
<b>description</b>	PCB ice maker AC045/055		



1

<b>GEV No.</b>	404002	<b>Ref. No.</b>	0C0028
<b>description</b>	PCB induction device frequency transformation		



central units



1

<b>GEV No.</b>	401617	<b>Ref. No.</b>	0C3757
<b>description</b>	power PCB combi-steamer FCV 6GL		



1

<b>GEV No.</b>	400748	<b>Ref. No.</b>	0C3761
<b>description</b>	power PCB combi-steamer FCV/G 101/1 102/1		



1

<b>GEV No.</b>	401572	<b>Ref. No.</b>	0C3762
<b>description</b>	power PCB combi-steamer FCV/G 101/1 102/1		



1

<b>GEV No.</b>	400750	<b>Ref. No.</b>	0C0042
<b>description</b>	power PCB combi-steamer FCZ06/10/20		



1

<b>GEV No.</b>	401841	<b>Ref. No.</b>	086597
<b>description</b>	control box for ice-cube maker 24V 50-60Hz		



1

<b>GEV No.</b>	402042	<b>Ref. No.</b>	086294
<b>description</b>	control box suitable for SFT 012		

keypads

front foils



1

<b>GEV No.</b>	401131	<b>Ref. No.</b>	003714
<b>description</b>	front foil		



1

<b>GEV No.</b>	401132	<b>Ref. No.</b>	003838
<b>description</b>	front foil		



1

<b>GEV No.</b>	401212	<b>Ref. No.</b>	003834
<b>description</b>	front foil		



1

<b>GEV No.</b>	401216	<b>Ref. No.</b>	003835
<b>description</b>	front foil		





1

<b>GEV No.</b>	401248	<b>Ref. No.</b>	002831
<b>description</b>	front foil		



1 			
<b>GEV No.</b>	401250	<b>Ref. No.</b>	003832
<b>description</b>	front foil		

1 			
<b>GEV No.</b>	401251	<b>Ref. No.</b>	006529
<b>description</b>	keypad foil		

1 			
<b>GEV No.</b>	401211	<b>Ref. No.</b>	007057
<b>description</b>	keypad foil		

1 			
<b>GEV No.</b>	401354	<b>Ref. No.</b>	0K2637
<b>description</b>	keypad foil		

1 			
<b>GEV No.</b>	401213	<b>Ref. No.</b>	003664
<b>description</b>	keypad foil		

1 			
<b>GEV No.</b>	401541	<b>Ref. No.</b>	006054
<b>description</b>	keypad foil		

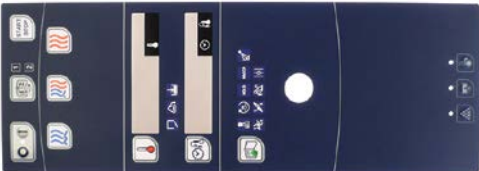
1 			
<b>GEV No.</b>	401214	<b>Ref. No.</b>	007058
<b>description</b>	keypad foil		

1 			
<b>GEV No.</b>	401543	<b>Ref. No.</b>	005417
<b>description</b>	keypad foil		

1 			
<b>GEV No.</b>	401215	<b>Ref. No.</b>	056680
<b>description</b>	keypad foil		

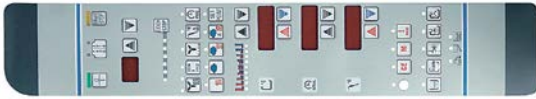
1 			
<b>GEV No.</b>	401545	<b>Ref. No.</b>	005418
<b>description</b>	keypad foil		

1 			
<b>GEV No.</b>	401217	<b>Ref. No.</b>	059288
<b>description</b>	keypad foil		

1 			
<b>GEV No.</b>	401579	<b>Ref. No.</b>	005449
<b>description</b>	keypad foil		

1 			
<b>GEV No.</b>	401247	<b>Ref. No.</b>	002719
<b>description</b>	keypad foil		

1 			
<b>GEV No.</b>	404004	<b>Ref. No.</b>	0C0026
<b>description</b>	keypad foil		

1 			
<b>GEV No.</b>	401249	<b>Ref. No.</b>	005623
<b>description</b>	keypad foil		

1 			
<b>GEV No.</b>	404005	<b>Ref. No.</b>	0C0038
<b>description</b>	keypad foil		



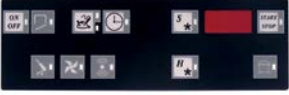

1 			
<b>GEV No.</b>	401754	<b>Ref. No.</b>	087198
<b>description</b>	keypad foil blast chiller suitable for ZANUSSI L 237mm W 74mm buttons 11		

1 			
<b>GEV No.</b>	401746	<b>Ref. No.</b>	085793
<b>description</b>	keypad foil blast chiller suitable for ZANUSSI L 238mm W 75mm buttons 11		

1 			
<b>GEV No.</b>	400994	<b>Ref. No.</b>	006608
<b>description</b>	keypad foil for fryer		

1 			
<b>GEV No.</b>	400998	<b>Ref. No.</b>	0C1015
<b>description</b>	keypad foil for fryer		

1 			
<b>GEV No.</b>	400999	<b>Ref. No.</b>	0C1016
<b>description</b>	keypad foil for fryer		

1 			
<b>GEV No.</b>	403054	<b>Ref. No.</b>	0L0005
<b>description</b>	keypad foil LS14AU L 190mm W 120mm buttons 7		

## membrane keypads

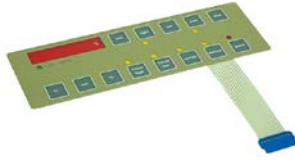
1 			
<b>GEV No.</b>	400204	<b>Ref. No.</b>	0A8798
<b>description</b>	membrane keypad		

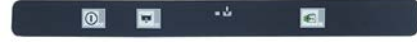
1 			
<b>GEV No.</b>	400915	<b>Ref. No.</b>	049956
<b>description</b>	membrane keypad		

1 			
<b>GEV No.</b>	400918	<b>Ref. No.</b>	049920
<b>description</b>	membrane keypad		

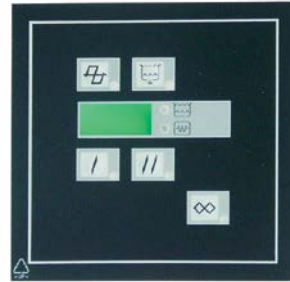
1 			
<b>GEV No.</b>	400924	<b>Ref. No.</b>	049605
<b>description</b>	membrane keypad		

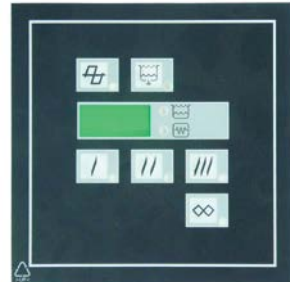
1 			
<b>GEV No.</b>	400925	<b>Ref. No.</b>	049606
<b>description</b>	membrane keypad		

1 			
<b>GEV No.</b>	400926	<b>Ref. No.</b>	049604
<b>description</b>	membrane keypad		



1 

<b>GEV No.</b>	400921	<b>Ref. No.</b>	0L0008
<b>description</b>	membrane keypad buttons 5 suitable for LS10 L 190mm W 120mm		

1 

<b>GEV No.</b>	400922	<b>Ref. No.</b>	0L0001
<b>description</b>	membrane keypad buttons 6 suitable for LS14 L 190mm W 120mm		

**control panel**

1 

<b>GEV No.</b>	111657	<b>Ref. No.</b>	052272
<b>description</b>	control panel		

1 

<b>GEV No.</b>	111668	<b>Ref. No.</b>	051280
<b>description</b>	control panel ignition		

1 

<b>GEV No.</b>	504731	<b>Ref. No.</b>	048274
<b>description</b>	gasket L 310mm suitable for ZANUSSI equiv. no. 048274 external weith 160mm		

1 

<b>GEV No.</b>	504714	<b>Ref. No.</b>	049061
<b>description</b>	switch panel		

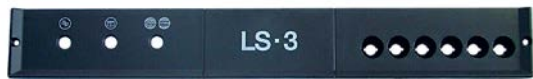
1 

<b>GEV No.</b>	504716	<b>Ref. No.</b>	049313
<b>description</b>	switch panel		

1 

<b>GEV No.</b>	504718	<b>Ref. No.</b>	048903
<b>description</b>	switch panel		

1 

<b>GEV No.</b>	504720	<b>Ref. No.</b>	047633
<b>description</b>	switch panel		

1 

<b>GEV No.</b>	504722	<b>Ref. No.</b>	046732
<b>description</b>	switch panel		

1 

<b>GEV No.</b>	504723	<b>Ref. No.</b>	048648
<b>description</b>	switch panel		

1 

<b>GEV No.</b>	504724	<b>Ref. No.</b>	049151
<b>description</b>	switch panel		



1

<b>GEV No.</b>	504726	<b>Ref. No.</b>	048590
<b>description</b>	switch panel		



1

<b>GEV No.</b>	504727	<b>Ref. No.</b>	049143
<b>description</b>	switch panel		



1

<b>GEV No.</b>	504729	<b>Ref. No.</b>	048598
<b>description</b>	switch panel		



1

<b>GEV No.</b>	504717	<b>Ref. No.</b>	048827
<b>description</b>	switch panel warewashing LS 60/61		

### accessories

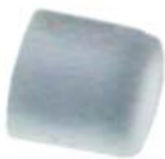

1

<b>GEV No.</b>	400997	<b>Ref. No.</b>	002670
<b>description</b>	push button		

## solenoid valves

### solenoid valves (water)

#### ELBI



1

<b>GEV No.</b>	373012	<b>Ref. No.</b>	048817
<b>description</b>	solenoid valve single angled 230VAC inlet 3/4" outlet 13.5mm input 20l/min t.max. 90°C duty cycle 100% ELBI flow regulating valve inlet orange		



1

<b>GEV No.</b>	370253	<b>Ref. No.</b>	049334
<b>description</b>	solenoid valve single angled 230VAC inlet 3/4" outlet 14mm input 3.5l/min t.max. 90°C ELBI plastic flow regulating valve inlet orange		



1

<b>GEV No.</b>	373020	<b>Ref. No.</b>	049056
<b>description</b>	solenoid valve double angled 230VAC inlet 3/4" outlet 14mm input 10l/min DN10 t.max. 90°C duty cycle 100% ELBI flow regulating valve inlet white		

#### INTERELEKTRIK

medium temperature: 90°C 90°C 60°C  
 ambient temperature: 60°C 25°C 60°C  
 duty cycle: 40% 100% 100%

#### with reducers



1

<b>GEV No.</b>	370659	<b>Ref. No.</b>	0G1981
<b>description</b>	solenoid valve double straight 230VAC inlet 3/4" outlet 11.5mm t.max. 90°C INTERELEKTRIK plastic flow regulating valve inlet white		







ROBERTSHAW/INVENSYS

medium temperature: 90°C 90°C 60°C  
 ambient temperature: 60°C 25°C 60°C  
 duty cycle: 40% 100% 100%

solenoid valves with reducers

single

			
1			
<b>GEV No.</b>	370554	<b>Ref. No.</b>	049452
<b>description</b>	solenoid valve single angled 230VAC inlet 3/4" outlet 14.5mm input 5.5l/min t.max. 90°C plastic		

			
1			
<b>GEV No.</b>	370254	<b>Ref. No.</b>	049626
<b>description</b>	solenoid valve single angled 230VAC inlet 3/4" outlet 14mm input 12l/min t.max. 90°C EATON (INVENSYS) plastic flow regulating valve inlet grey		

3-fold

			
1			
<b>GEV No.</b>	370345	<b>Ref. No.</b>	002859 0C1934
<b>description</b>	solenoid valve triple straight 230VAC inlet 3/4" outlet 11.5mm t.max. 90°C EATON (INVENSYS) plastic output B 0.25l/min output C 1.2l/min flow regulating valve outlet B white flow regulating valve outlet C blue		

with coded terminal

			
1			
<b>GEV No.</b>	370355	<b>Ref. No.</b>	0C1933
<b>description</b>	solenoid valve single angled 230VAC inlet 3/4" outlet 11.5mm DN10 EATON (INVENSYS)		

RPE

special outlet

			
1			
<b>GEV No.</b>	370453	<b>Ref. No.</b>	0H9328
<b>description</b>	solenoid valve single angled 230VAC inlet 11.5mm outlet 11.5mm RPE		

TP

















			
1			
<b>GEV No.</b>	370021	<b>Ref. No.</b>	069463
<b>description</b>	solenoid valve double straight 230VAC inlet 3/4" outlet 11.5mm DN10 TP flow regulating valve inlet white		
<b>spare parts for</b>	370021		
	<b>GEV No.</b>	371013	<b>Ref. No.</b> —
	solenoid coil TP 230VAC 50/60Hz		
<b>accessories for</b>	370021		
	<b>GEV No.</b>	371220	<b>Ref. No.</b> —
	reducer TP flow rate 3l/min red tolerance ±15%		
	<b>GEV No.</b>	371221	<b>Ref. No.</b> —
	reducer TP flow rate 5.5l/min yellow tolerance ±15%		
	<b>GEV No.</b>	371222	<b>Ref. No.</b> —
	reducer TP flow rate 6l/min grey tolerance ±15%		
	<b>GEV No.</b>	371223	<b>Ref. No.</b> —
	reducer TP flow rate 10l/min white tolerance ±15%		
	<b>GEV No.</b>	371224	<b>Ref. No.</b> —
	reducer TP flow rate 12l/min bronze tolerance ±15%		
	<b>GEV No.</b>	371225	<b>Ref. No.</b> —
	reducer TP flow rate 16l/min light brown tolerance ±15%		
	<b>GEV No.</b>	371226	<b>Ref. No.</b> —
	reducer TP flow rate 20l/min red tolerance ±15%		
	<b>GEV No.</b>	371230	<b>Ref. No.</b> —
	reducer TP flow rate 0.25l/min red tolerance ±25%		
	<b>GEV No.</b>	371231	<b>Ref. No.</b> —
	reducer TP flow rate 0.35l/min violet tolerance ±25%		
	<b>GEV No.</b>	371232	<b>Ref. No.</b> —
	reducer TP flow rate 0.5l/min orange tolerance ±25%		

Table continues overleaf

accessories for 370021				
GEV No.	371233	Ref. No.	—	
			reducer TP flow rate 0.8l/min white tolerance ±25%	
			reducer TP flow rate 1l/min light blue tolerance ±25%	
			reducer TP flow rate 1.2l/min brown tolerance ±25%	
			reducer TP flow rate 1.5l/min light brown tolerance ±25%	
			reducer TP flow rate 2.5l/min yellow tolerance ±25%	
			reducer TP flow rate 3.4l/min dark green tolerance ±25%	
			reducer TP flow rate 5l/min black tolerance ±25%	
			reducer TP flow rate 8l/min blue tolerance ±20%	

				
<b>GEV No.</b>	370655	<b>Ref. No.</b>	047533	
<b>description</b>	solenoid valve single straight 230VAC inlet 3/4" outlet 11.5mm DN10 TP plastic flow regulating valve inlet pink 8VA			

				
<b>GEV No.</b>	370029	<b>Ref. No.</b>	058996	
<b>description</b>	solenoid valve single straight 24VAC inlet 3/4" outlet 11.5mm DN10 TP flow regulating valve inlet white			

<b>spare parts for 370029</b>				
	GEV No.	371035	Ref. No.	—
solenoid coil 24VAC				
<b>accessories for 370029</b>				
	GEV No.	371220	Ref. No.	—
reducer TP flow rate 3l/min red tolerance ±15%				
	GEV No.	371221	Ref. No.	—
reducer TP flow rate 5.5l/min yellow tolerance ±15%				
	GEV No.	371222	Ref. No.	—
reducer TP flow rate 6l/min grey tolerance ±15%				

accessories for 370029				
GEV No.	371223	Ref. No.	—	
			reducer TP flow rate 10l/min white tolerance ±15%	
			reducer TP flow rate 12l/min bronze tolerance ±15%	
			reducer TP flow rate 16l/min light brown tolerance ±15%	
			reducer TP flow rate 20l/min red tolerance ±15%	
			reducer TP flow rate 0.25l/min red tolerance ±25%	
			reducer TP flow rate 0.35l/min violet tolerance ±25%	
			reducer TP flow rate 0.5l/min orange tolerance ±25%	
			reducer TP flow rate 0.8l/min white tolerance ±25%	
			reducer TP flow rate 1l/min light blue tolerance ±25%	
			reducer TP flow rate 1.2l/min brown tolerance ±25%	
			reducer TP flow rate 1.5l/min light brown tolerance ±25%	
			reducer TP flow rate 2.5l/min yellow tolerance ±25%	
			reducer TP flow rate 3.4l/min dark green tolerance ±25%	
			reducer TP flow rate 5l/min black tolerance ±25%	
			reducer TP flow rate 8l/min blue tolerance ±20%	



				
<b>GEV No.</b>	370025	<b>Ref. No.</b>	069464	
<b>description</b>	solenoid valve triple straight 230VAC inlet 3/4" outlet 11.5mm DN10 TP			
<b>spare parts for 370025</b>				
	GEV No.	371013	Ref. No.	—
solenoid coil TP 230VAC 50/60Hz				

Table continues overleaf





accessories for		370025		
GEV No.		371220	Ref. No.	—
	reducer TP flow rate 3l/min red tolerance ±15%			
	reducer TP flow rate 5.5l/min yellow tolerance ±15%			
	reducer TP flow rate 6l/min grey tolerance ±15%			
	reducer TP flow rate 10l/min white tolerance ±15%			
	reducer TP flow rate 12l/min bronze tolerance ±15%			
	reducer TP flow rate 16l/min light brown tolerance ±15%			
	reducer TP flow rate 20l/min red tolerance ±15%			
	reducer TP flow rate 0.25l/min red tolerance ±25%			
	reducer TP flow rate 0.35l/min violet tolerance ±25%			
	reducer TP flow rate 0.5l/min orange tolerance ±25%			
	reducer TP flow rate 0.8l/min white tolerance ±25%			
	reducer TP flow rate 1l/min light blue tolerance ±25%			
	reducer TP flow rate 1.2l/min brown tolerance ±25%			
	reducer TP flow rate 1.5l/min light brown tolerance ±25%			
	reducer TP flow rate 2.5l/min yellow tolerance ±25%			
	reducer TP flow rate 3.4l/min dark green tolerance ±25%			
	reducer TP flow rate 5l/min black tolerance ±25%			
	reducer TP flow rate 8l/min blue tolerance ±20%			

accessories for		370015		
GEV No.		371220	Ref. No.	—
	reducer TP flow rate 3l/min red tolerance ±15%			
	reducer TP flow rate 5.5l/min yellow tolerance ±15%			
	reducer TP flow rate 6l/min grey tolerance ±15%			
	reducer TP flow rate 10l/min white tolerance ±15%			
	reducer TP flow rate 12l/min bronze tolerance ±15%			
	reducer TP flow rate 16l/min light brown tolerance ±15%			
	reducer TP flow rate 20l/min red tolerance ±15%			
	reducer TP flow rate 0.25l/min red tolerance ±25%			
	reducer TP flow rate 0.35l/min violet tolerance ±25%			
	reducer TP flow rate 0.5l/min orange tolerance ±25%			
	reducer TP flow rate 0.8l/min white tolerance ±25%			
	reducer TP flow rate 1l/min light blue tolerance ±25%			
	reducer TP flow rate 1.2l/min brown tolerance ±25%			
	reducer TP flow rate 1.5l/min light brown tolerance ±25%			
	reducer TP flow rate 2.5l/min yellow tolerance ±25%			
	reducer TP flow rate 3.4l/min dark green tolerance ±25%			

Table continues overleaf



accessories for		370015		
GEV No.		371239	Ref. No.	—
	reducer TP flow rate 5l/min black tolerance $\pm 25\%$			
GEV No.		371240	Ref. No.	—
	reducer TP flow rate 8l/min blue tolerance $\pm 20\%$			

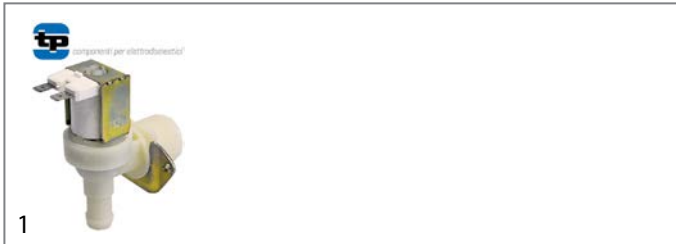

GEV No.	370016	Ref. No.	048178
<b>description</b>	solenoid valve single angled 230VAC inlet 3/4" outlet 14mm DN10 TP		

spare parts for		370016		
GEV No.		371013	Ref. No.	—
	solenoid coil TP 230VAC 50/60Hz			

accessories for		370016		
GEV No.		371220	Ref. No.	—
	reducer TP flow rate 3l/min red tolerance $\pm 15\%$			
GEV No.		371221	Ref. No.	—
	reducer TP flow rate 5.5l/min yellow tolerance $\pm 15\%$			
GEV No.		371222	Ref. No.	—
	reducer TP flow rate 6l/min grey tolerance $\pm 15\%$			
GEV No.		371223	Ref. No.	—
	reducer TP flow rate 10l/min white tolerance $\pm 15\%$			
GEV No.		371224	Ref. No.	—
	reducer TP flow rate 12l/min bronze tolerance $\pm 15\%$			
GEV No.		371225	Ref. No.	—
	reducer TP flow rate 16l/min light brown tolerance $\pm 15\%$			
GEV No.		371226	Ref. No.	—
	reducer TP flow rate 20l/min red tolerance $\pm 15\%$			
GEV No.		371230	Ref. No.	—
	reducer TP flow rate 0.25l/min red tolerance $\pm 25\%$			
GEV No.		371231	Ref. No.	—
	reducer TP flow rate 0.35l/min violet tolerance $\pm 25\%$			
GEV No.		371232	Ref. No.	—
	reducer TP flow rate 0.5l/min orange tolerance $\pm 25\%$			
GEV No.		371233	Ref. No.	—
	reducer TP flow rate 0.8l/min white tolerance $\pm 25\%$			
GEV No.		371234	Ref. No.	—
	reducer TP flow rate 1l/min light blue tolerance $\pm 25\%$			
GEV No.		371235	Ref. No.	—
	reducer TP flow rate 1.2l/min brown tolerance $\pm 25\%$			

accessories for		370016		
GEV No.		371236	Ref. No.	—
	reducer TP flow rate 1.5l/min light brown tolerance $\pm 25\%$			
GEV No.		371237	Ref. No.	—
	reducer TP flow rate 2.5l/min yellow tolerance $\pm 25\%$			
GEV No.		371238	Ref. No.	—
	reducer TP flow rate 3.4l/min dark green tolerance $\pm 25\%$			
GEV No.		371239	Ref. No.	—
	reducer TP flow rate 5l/min black tolerance $\pm 25\%$			
GEV No.		371240	Ref. No.	—
	reducer TP flow rate 8l/min blue tolerance $\pm 20\%$			
GEV No.		503139	Ref. No.	—
	solenoid valve filter $\varnothing$ 19.5mm H 16mm			

## solenoid valves with reducers

	1		
GEV No.	370336	Ref. No.	OC0561
<b>description</b>	solenoid valve double angled 230VAC inlet 3/4" plastic outlet 11.5mm		

	1		
GEV No.	370337	Ref. No.	056872
<b>description</b>	solenoid valve double angled 230VAC inlet 3/4" plastic outlet 11.5mm output A 8l/min output B 0.6l/min flow regulating valve outlet A dark blue flow regulating valve outlet B orange		

	1		
GEV No.	370343	Ref. No.	055444
<b>description</b>	solenoid valve double angled 230VAC inlet 3/4" t.max. 90°C TP plastic outlet 11.5mm output B 1l/min flow regulating valve outlet B light blue		





			
1			
<b>GEV No.</b>	370657	<b>Ref. No.</b>	056894
<b>description</b>	solenoid valve double angled 230VAC inlet 3/4" TP plastic outlet 11.5mm output A 1l/min output B 8l/min flow regulating valve outlet A dark blue flow regulating valve outlet B light blue		

			
1			
<b>GEV No.</b>	370344	<b>Ref. No.</b>	002712
<b>description</b>	solenoid valve triple angled 230VAC inlet 3/4" outlet 11.5mm t.max. 90°C TP plastic output B 0.25l/min output C 1l/min flow regulating valve outlet B red flow regulating valve outlet C light blue		

			
1			
<b>GEV No.</b>	370342	<b>Ref. No.</b>	047579
<b>description</b>	solenoid valve double straight 230VAC inlet 3/4" input 16l/min t.max. 90°C TP plastic flow regulating valve inlet light brown outlet 11.5mm output B 0.25l/min flow regulating valve outlet B red		

			
1			
<b>GEV No.</b>	370347	<b>Ref. No.</b>	0A2415
<b>description</b>	solenoid valve triple angled 24V inlet 3/4" outlet 11.5mm plastic output C 1l/min		

			
1			
<b>GEV No.</b>	370660	<b>Ref. No.</b>	0K8195
<b>description</b>	solenoid valve double straight 230VAC inlet 3/4" input 5.5l/min 10 t. max. 90°C TP plastic flow regulating valve inlet yellow outlet 11.5mm output B 0.25l/min flow regulating valve outlet B red		

			
1			
<b>GEV No.</b>	370658	<b>Ref. No.</b>	0K8035
<b>description</b>	solenoid valve triple straight 230VAC inlet 3/4" outlet 11.5mm input 5.5l/min 10 t.max. 90°C TP plastic flow regulating valve inlet yellow output A 1l/min output C 0.25l/min flow regulating valve outlet A light blue flow regulating valve outlet C red		

			
1			
<b>GEV No.</b>	370656	<b>Ref. No.</b>	047756
<b>description</b>	solenoid valve single straight 230VAC inlet 3/4" outlet 11.5mm 10 TP plastic flow regulating valve inlet green		

			
1			
<b>GEV No.</b>	370375	<b>Ref. No.</b>	0F0001
<b>description</b>	solenoid valve triple straight 230VAC inlet 3/4" outlet 11.5mm t.max. 90°C TP plastic output A 2.5l/min output C 0.25l/min flow regulating valve outlet A yellow flow regulating valve outlet C red		

			
1			
<b>GEV No.</b>	370341	<b>Ref. No.</b>	002753
<b>description</b>	solenoid valve single straight 230VAC inlet 3/4" outlet 11.5mm output 1l/min t.max. 90°C TP plastic flow regulating valve outlet light blue output A 1l/min		

metal			
ASCO			
2-way			
 <p>Image not available</p>			
1			
<b>GEV No.</b>	370470	<b>Ref. No.</b>	053933
<b>description</b>	solenoid valve 2-ways 24 V inlet 1/2" outlet 1/2" connection 1/2" slide-on receptacle DIN -20° up to 85°C Asco membranes NBR (water) brass		

CEME

solenoid valves



<b>GEV No.</b>	370348	<b>Ref. No.</b>	007015
<b>description</b>	solenoid valve 2-ways 230VAC connection 1/2" L 60mm t.max. 90°C membranes NBR p max 10bar p min 0.25bar brass		





<b>GEV No.</b>	370350	<b>Ref. No.</b>	007017
<b>description</b>	solenoid valve SS 230V inlet 6.5mm outlet 6.5mm -10 up to 140°C hose ø 6mm combi-steamer body SS 50Hz		

ODE

2-way





<b>GEV No.</b>	370356	<b>Ref. No.</b>	0C1121
<b>description</b>	solenoid valve 2-ways 230VAC inlet 3/4" outlet 3/4" connection 3/4" L 104mm DN 19mm slide-on receptacle DIN -10 up to +90°C ODE type series 21W3 coil type BDA membranes NBR (water) p max 16bar p min 0.2bar		
<b>spare parts for</b>	370356		
	<b>GEV No.</b>	371150	<b>Ref. No.</b> —
	solenoid coil ODE 230VAC 16VA coil type BDV seat ø 13.5mm 750Ohm		
<b>accessories for</b>	370356		
	<b>GEV No.</b>	371090	<b>Ref. No.</b> —
	power socket plug type DIN 43650A screw		

solenoid valves steam (water)

21A series



<b>GEV No.</b>	370349 <sup>1</sup>	<b>Ref. No.</b>	007016
<b>description</b>	solenoid valve stainless steel 230VAC connection 1/4" L 40mm 2-way DN 5.5mm slide-on receptacle DIN -10 up to 140°C ODE type series 21A coil type BDA membranes FKM (water/steam) p max 3.5bar		
<b>spare parts for</b>	370349		
	<b>GEV No.</b>	371150	<b>Ref. No.</b> —
	solenoid coil ODE 230VAC 16VA coil type BDV seat ø 13.5mm 750Ohm		
<b>accessories for</b>	370349		
	<b>GEV No.</b>	371090	<b>Ref. No.</b> —
	power socket plug type DIN 43650A screw		

<sup>1</sup>SS housing

PARKER

spare parts and accessories

solenoid coils



<b>GEV No.</b>	371098	<b>Ref. No.</b>	086051
<b>description</b>	solenoid coil 220-230VAC 50/60Hz seat ø 14mm cable length 1000mm 14W		

SIRAI

2-way



L180-B series





<b>GEV No.</b>	370391	<b>Ref. No.</b>	003778
<b>description</b>	solenoid valve 2-ways 24VAC connection 3/4" L 79mm DN 18mm -10 up to +90°C coil type Z610A membranes NBR (water) p max 12bar p min 0.35bar		
<b>accessories for</b>	370391		
	<b>GEV No.</b>	371091	<b>Ref. No.</b> —
	power socket plug type DIN 43650B cable lengthmm small		





solenoid valves steam (water)			
2-way			
L145-R series			
 <p>1</p>			
<b>GEV No.</b>	370311	<b>Ref. No.</b>	068465
<b>description</b>	solenoid valve 2-ways 24VAC connection 1" L 105mm DN 18.5mm slide-on receptacle DIN -60 up to +170°C SIRAI type series L145-R coil type Z534A membranes PTFE (steam) p max 6bar p min 0.4bar		
<b>spare parts for</b>	370311		
	<b>GEV No.</b>	371068	<b>Ref. No.</b> —
	solenoid coil 24VAC 14VA SIRAI coil type Z534A seat ø 12mm		
	<b>GEV No.</b>	371166	<b>Ref. No.</b> —
	membrane connection 1" series L145-R membrane type PTFE		
<b>accessories for</b>	370311		
	<b>GEV No.</b>	371090	<b>Ref. No.</b> —
	power socket plug type DIN 43650A screw		

solenoid valves (various)			
 <p>1</p>			
<b>GEV No.</b>	370378	<b>Ref. No.</b>	0C2390
<b>description</b>	solenoid valve 230VAC inlet 1/2" outlet 1,1-4,5mm SIRAI coil type ZA34A 230V brass		
<b>spare parts for</b>	370378		
	<b>GEV No.</b>	371150	<b>Ref. No.</b> —
	solenoid coil ODE 230VAC 16VA coil type BDV seat ø 13.5mm 750Ohm		
	<b>GEV No.</b>	371176	<b>Ref. No.</b> —
	solenoid coil 230VAC 14VA SIRAI coil type ZA34A seat ø 14mm		

solenoid valves (gas)			
BRAHMA			
solenoid valves			
 <p>1</p>			
<b>GEV No.</b>	101948 <sup>1</sup>	<b>Ref. No.</b>	059509
<b>description</b>	solenoid valve 230VAC DN 15mm connection 1/2" L 72mm BRAHMA coil type 18811003 p max 0.5bar reg. no. 63AQ0626		
<b>spare parts for</b>	101948		
	<b>GEV No.</b>	101968	<b>Ref. No.</b> 005548
	solenoid valve 230VAC 20VA seat ø 17mm coil type 13902001 BRAHMA		

<sup>1</sup>aluminium housing

spare parts and accessories			
solenoid coils			
 <p>1</p>			
<b>GEV No.</b>	101968	<b>Ref. No.</b>	005548
<b>description</b>	solenoid valve 230VAC 20VA seat ø 17mm coil type 13902001 BRAHMA		

solenoid valves (refrigeration)			
PARKER			
valve bodies			
 <p>1</p>			
<b>GEV No.</b>	370536	<b>Ref. No.</b>	OKM756
<b>description</b>	solenoid valve body p max 35bar connection 3/8" US PARKER for ice maker tube ø 10mm hot gas		
<b>accessories for</b>	370536		
	<b>GEV No.</b>	371098	<b>Ref. No.</b> 086051
	solenoid coil 220-230VAC 50/60Hz seat ø 14mm cable length 1000mm 14W		



## ball valves electric

			
1			
<b>GEV No.</b>	401140	<b>Ref. No.</b>	005026
<b>description</b>	ball valve inlet 1" IT outlet 1" IT with plug 230V L 152mm 50/60Hz closed off-current mode of operation electric connection cable 200mm size DN25		

			
1			
<b>GEV No.</b>	401139	<b>Ref. No.</b>	0C0882
<b>description</b>	ball valve inlet 3/4" IT outlet 3/4" IT with plug 230V L 65mm 50/60Hz closed off-current mode of operation electric connection cable 200mm		

## pressure switches

### for warewashing

ø 58mm with male faston 6.3mm

with connection horizontal

			
1			
<b>GEV No.</b>	541008	<b>Ref. No.</b>	046601
<b>description</b>	pressure control pressure range 105/60mbar connection 6mm ø 58mm pressure connection horizontal warewashing		

			
1			
<b>GEV No.</b>	541009	<b>Ref. No.</b>	046653
<b>description</b>	pressure control pressure range 160/80mbar connection 6mm ø 58mm pressure connection horizontal warewashing		

			
1			
<b>GEV No.</b>	541179	<b>Ref. No.</b>	048267
<b>description</b>	pressure control pressure range 240/130mbar connection 6mm ø 58mm pressure connection horizontal warewashing pressure connection ø 6mm		

			
1			
<b>GEV No.</b>	541005	<b>Ref. No.</b>	046444
<b>description</b>	pressure control pressure range 50/10mbar connection 6mm ø 58mm pressure connection horizontal warewashing		

			
1			
<b>GEV No.</b>	541003	<b>Ref. No.</b>	069434
<b>description</b>	pressure control pressure range 55/35mbar connection 6mm ø 58mm pressure connection horizontal warewashing pressure connection ø 6mm		

			
1			
<b>GEV No.</b>	541006	<b>Ref. No.</b>	049485
<b>description</b>	pressure control pressure range 60/20mbar connection 6mm ø 58mm pressure connection horizontal warewashing pressure connection ø 6mm		

### ø 58mm with coded plug

			
1			
<b>GEV No.</b>	541171	<b>Ref. No.</b>	049058
<b>description</b>	pressure control pressure range 110/55mbar connection 6mm ø 58mm pressure connection horizontal warewashing suitable for ZANUSSI pressure connection ø 6mm		





1

<b>GEV No.</b>	541178	<b>Ref. No.</b>	049620
<b>description</b>	pressure control pressure range 250/130 390mbar connection 6mm ø 58mm pressure connection horizontal warewashing suitable for ZANUSSI pressure connection ø 6mm		



1

<b>GEV No.</b>	541175	<b>Ref. No.</b>	049881
<b>description</b>	pressure control pressure range 60/20-110mbar connection 6mm ø 58mm pressure connection horizontal warewashing suitable for ZANUSSI pressure connection ø 6mm		

ø 84mm with coded plug



1

<b>GEV No.</b>	541177	<b>Ref. No.</b>	049081
<b>description</b>	pressure control 2 pressure ranges pressure range 110/55 165/135mbar connection 6mm ø 84mm pressure connection horizontal warewashing suitable for ZANUSSI pressure connection ø 6mm		



1

<b>GEV No.</b>	541523	<b>Ref. No.</b>	0E3731
<b>description</b>	pressure control 2 pressure ranges pressure range 40/15 55/35mbar connection 6mm ø 84mm pressure connection horizontal pressure connection ø 6mm		

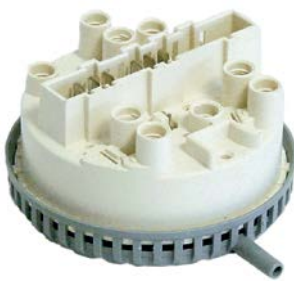

1

<b>GEV No.</b>	541176	<b>Ref. No.</b>	049361
<b>description</b>	pressure control 2 pressure ranges pressure range 60/20 110/80mbar connection 6mm ø 84mm pressure connection horizontal warewashing suitable for ZANUSSI		



1

<b>GEV No.</b>	541173	<b>Ref. No.</b>	048826
<b>description</b>	pressure control pressure range 2 pointsmbar connection coded plug ø 84mm pressure connection horizontal warewashing pressure connection ø 6mm		



1

<b>GEV No.</b>	541174	<b>Ref. No.</b>	049142
<b>description</b>	pressure control pressure range 2 pointsmbar connection coded plug ø 84mm pressure connection horizontal warewashing pressure connection ø 6mm		

for gas equipment



1

<b>GEV No.</b>	541073	<b>Ref. No.</b>	002635
<b>description</b>	pressure control ø 45mm pressure range adjustable 5-20mbar pressure connection vertical gas technology connection 1/4" pressure connection ø 1/4"mm		

1

<b>GEV No.</b>	541867	<b>Ref. No.</b>	003772
<b>description</b>	pressure control ø 80mm reset pressure 0.42bar triggering pressure 0.78mbar connection 7.5/10.5mm 250V voltage AC 1CO pressure connection ø 7.5-10.5mm		



1

<b>GEV No.</b>	541446	<b>Ref. No.</b>	005029
<b>description</b>	pressure control pressure range 10-50mbar connection 1/4"		



1

<b>GEV No.</b>	541352	<b>Ref. No.</b>	005746
<b>description</b>	pressure control triggering pressure 1.5mbar reset pressure 1.2mbar pressure range 1.5/1.2mbar pressure connection horizontal gas technology connection 6mm suitable for ZANUSSI		

for steam control



1

<b>GEV No.</b>	541350	<b>Ref. No.</b>	0A2480
<b>description</b>	pressure control pressure range adjustable 0.3-0.8bar connection 1/4" CO 250V 10A ambient temperature max. 60°C pressure connection 1/4"		

for combi-steamers



1

<b>GEV No.</b>	541335	<b>Ref. No.</b>	054540
<b>description</b>	pressure control		



1

<b>GEV No.</b>	541349	<b>Ref. No.</b>	055052
<b>description</b>	pressure control		

for refrigeration

RANCO

DWFK series



1

<b>GEV No.</b>	541451	<b>Ref. No.</b>	085088
<b>description</b>	pressure control RANCO high pressure		

JOHNSON CONTROLS



1

<b>GEV No.</b>	541116	<b>Ref. No.</b>	086039
<b>description</b>	pressure control HD switch pressure 10bar reset automatic switching diff. 1.1bar pressure range 7-29bar p max 38bar refrigeration type P20EA-9950C connection soldering connection 6.35mm CO JOHNSON CONTROLS pressure connection soldering connection 6.35mm		

electrodes



1

<b>GEV No.</b>	401264	<b>Ref. No.</b>	007033
<b>description</b>	level electrode 1/4" total length 103mm probe L 76mm insulated probe length 71mm PTFE insulated connection angled, male faston 6.3mm stainless steel ø 2.5mm		





1

<b>GEV No.</b>	401258	<b>Ref. No.</b>	0A2838
<b>description</b>	level electrode 1/4" total length 120mm probe L 94mm insulated probe length 90mm PTFE insulated connection angled, male faston 6.3mm stainless steel ø 2.5mm		

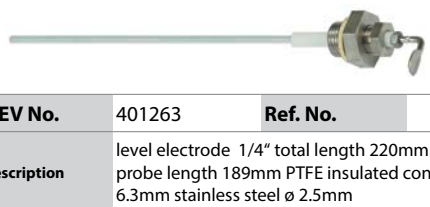

			
1			
<b>GEV No.</b>	400121	<b>Ref. No.</b>	055346
<b>description</b>	level electrode 1/4" total length 220mm probe L 195mm insulated probe length 189mm PTFE insulated connection angled, male faston 6.3mm stainless steel		

			
1			
<b>GEV No.</b>	401263	<b>Ref. No.</b>	0C1105
<b>description</b>	level electrode 1/4" total length 240mm probe L 216mm insulated probe length 210mm PTFE insulated connection angled, male faston 6.3mm stainless steel ø 2.5mm		

			
1			
<b>GEV No.</b>	401355	<b>Ref. No.</b>	0C1086
<b>description</b>	level electrode 1/4" total length 130mm probe L 102mm insulated probe length 98mm PTFE insulated connection angled, male faston 6.3mm stainless steel		

			
1			
<b>GEV No.</b>	401265	<b>Ref. No.</b>	005879
<b>description</b>	level electrode 1/4" total length 240mm probe L 216mm insulated probe length 210mm PTFE insulated connection angled, male faston 6.3mm stainless steel ø 2.5mm		

			
1			
<b>GEV No.</b>	401261	<b>Ref. No.</b>	003878
<b>description</b>	level electrode 1/4" total length 138mm probe L 112mm insulated probe length 108mm PTFE insulated connection angled, male faston 6.3mm stainless steel ø 2.5mm		

			
1			
<b>GEV No.</b>	401255	<b>Ref. No.</b>	005765
<b>description</b>	level electrode 1/4" total length 64mm probe L 37mm insulated probe length 33mm PTFE insulated connection angled, male faston 6.3mm ø 2.5mm marking L		

			
1			
<b>GEV No.</b>	401345	<b>Ref. No.</b>	0C1201
<b>description</b>	level electrode 1/4" total length 142mm probe L 116mm insulated probe length 112mm PTFE insulated connection angled, male faston 6.3mm stainless steel ø 2.5mm		

			
1			
<b>GEV No.</b>	401254	<b>Ref. No.</b>	005766
<b>description</b>	level electrode 1/4" total length 74mm probe L 47mm insulated probe length 41mm PTFE insulated connection angled, male faston 6.3mm stainless steel ø 2.5mm marking S		

			
1			
<b>GEV No.</b>	401259	<b>Ref. No.</b>	053909
<b>description</b>	level electrode 1/4" total length 155mm probe L 128mm insulated probe length 124mm PTFE insulated connection angled, male faston 6.3mm stainless steel ø 2.5mm		

			
1			
<b>GEV No.</b>	400120	<b>Ref. No.</b>	056449
<b>description</b>	level electrode 1/4" total length 83mm probe L 62mm insulated probe length 57mm PTFE insulated connection angled, male faston 6.3mm stainless steel ø 2.5mm		

			
1			
<b>GEV No.</b>	401262	<b>Ref. No.</b>	0C1055
<b>description</b>	level electrode 1/4" total length 159mm probe L 130mm insulated probe length 126mm PTFE insulated connection angled, male faston 6.3mm stainless steel ø 2.5mm		



compressors

ACC/ZEL

R134A

HMBP monophase

High/Medium evaporation temperature above -20/-15 °C

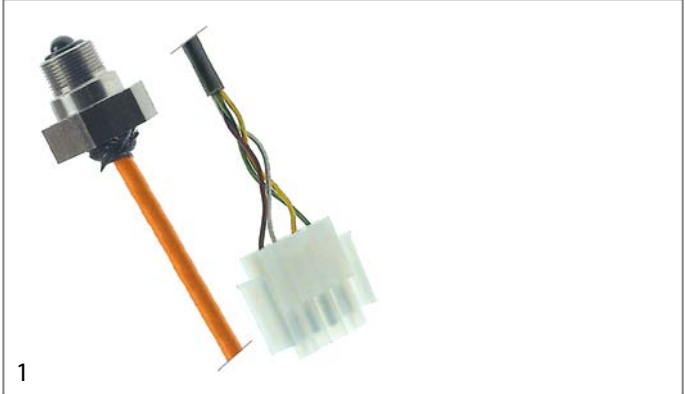

1	<b>GEV No.</b>	361642	<b>Ref. No.</b>	0C5350
	<b>description</b>	level electrode M16x1 probe L 14mm insulated probe length 0mm cable length 1000mm		



1	<b>GEV No.</b>	400124	<b>Ref. No.</b>	002694
	<b>description</b>	level electrode push-in total length 128mm probe L 103mm insulated probe length 93mm PTFE insulated connection F6.3 ø 2.5mm		



1	<b>GEV No.</b>	401548	<b>Ref. No.</b>	005235
	<b>description</b>	level electrode push-in total length 175mm probe L 151mm insulated probe length 142mm PTFE insulated connection F6.3 ø 2.5mm		

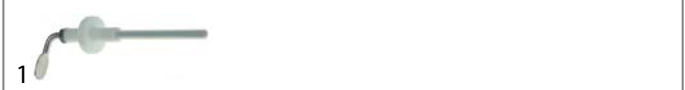

1	<b>GEV No.</b>	401260	<b>Ref. No.</b>	002632
	<b>description</b>	level electrode total length 75mm probe L 50mm insulated probe length 46mm PTFE insulated connection angled, male faston 6.3mm ø 2.5mm		



1	<b>GEV No.</b>	400123	<b>Ref. No.</b>	002633
	<b>description</b>	spacer piece for level electrode		

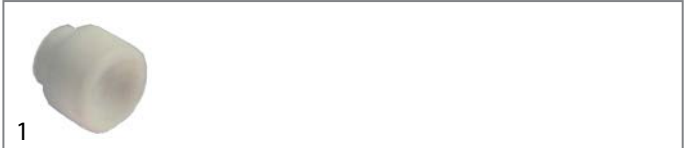

1	<b>GEV No.</b>	693744	<b>Ref. No.</b>	055435
	<b>description</b>	spacer piece for level electrode size 5mm		



1	<b>GEV No.</b>	693743	<b>Ref. No.</b>	055347
	<b>description</b>	spacer piece for level electrode size 9mm		



1	<b>GEV No.</b>	605007	<b>Ref. No.</b>	085876
	<b>description</b>	compressor coolant R134a type GL60TB 220-240V 50Hz HMBP fully hermetic 9.5kg 1/5HP power input 437W cylinder capacity 5.7cm <sup>3</sup> CSIR H 175.5mm 95W 128W 170W 222W 284W 355W 437W 528W test method ASHRAE ambient temperature max. 43°C		



1	<b>GEV No.</b>	605009	<b>Ref. No.</b>	083718
	<b>description</b>	compressor coolant R134a type GL90TB 220-240V 50Hz HMBP fully hermetic 10.8kg 1/4HP power input 293W cylinder capacity 8.8cm <sup>3</sup> CSIR H 175.5mmW 143W 194W 259W 339W 432W 539W 661W 796W test method ASHRAE		



1	<b>GEV No.</b>	605010	<b>Ref. No.</b>	083752
	<b>description</b>	compressor coolant R134a type GP12TB 220-240V 50Hz HMBP fully hermetic 11.2kg 3/8HP power input 661W cylinder capacity 12cm <sup>3</sup> CSIR H 203.6mmW 143W 194W 259W 339W 432W 539W 661W 796W test method ASHRAE ambient temperature max. 43°C		

1

<b>GEV No.</b>	605011	<b>Ref. No.</b>	083728
<b>description</b>	compressor coolant R134a type GP14TB 220-240V 50Hz HMBP fully hermetic 11.5kg 3/8HP power input 566W cylinder capacity 14cm <sup>3</sup> CSIR H 203.6mm 191W 271W 373W 497W 643W 810W 999W 1209W test method ASHRAE ambient temperature max. 43°C		

EMBRACO / ASPERA

R134A

HBP monophase

High evaporation temperature above -15°C



1

<b>GEV No.</b>	605115	<b>Ref. No.</b>	0TTP29
<b>description</b>	compressor coolant R134a type T6217Z 220-240V 50Hz HBP fully hermetic 16.8kg 1/2HP cylinder capacity 22.4cm <sup>3</sup> CSIR H 225mmWWW 718W 973W 1275W 1624W 2020W 2464W test method ASHRAE		

L'UNITE HERMETIQUE / TECUMSEH

R404A

HMBP monophase

High/Medium evaporation temperature above -20/-15 °C



Image not available

1

<b>GEV No.</b>	605218	<b>Ref. No.</b>	0T4121
<b>description</b>	compressor coolant R404a/R507 type CAE9460Z-F 220-240V 50Hz HMBP 13.6kg 1/2HP cylinder capacity 11.3cm <sup>3</sup> CSR H 212mmWWW 711W 908W 1141W 1545WW		

evaporation and condensing trays

condensing trays heated

universal

heating cartridges



<b>GEV No.</b>	417227	<b>Ref. No.</b>	083814
<b>description</b>	heating cartridge 90W 230V ø 12mm L 124mm thread 3/8" cable length 4000mm Hmm Wmm condensate evaporation		

fans

axial fans

ebm-papst



1



<b>GEV No.</b>	601715 <sup>1</sup>	<b>Ref. No.</b>	002690
<b>description</b>	axial fan L 119mm W 119mm H 38mm 230VAC 50Hz 18W bearing ball bearing manuf. no. 4656ZW metal connection cable 310mm ebm-papst fan wheel ø 110mm temp.-resist. 75°C		

<sup>1</sup>with ball bearings

import



1

<b>GEV No.</b>	601080 <sup>1</sup>	<b>Ref. No.</b>	0C4423	
<b>description</b>	axial fan L 119mm W 119mm H 38mm 230VAC 50/60Hz 23/20W bearing ball bearing connection male faston 2.8mm metal ADDA fan wheel ø 110mm temp.-resist. 70°C			
<b>accessories for</b>	601080			
	<b>GEV No.</b>	550898	<b>Ref. No.</b>	—
	connecting cable cable length 2000mm connection F 2.8 connection distance 7.9mm for axial flow fan			
	<b>GEV No.</b>	692519	<b>Ref. No.</b>	—
	guard L 120mm W 120mm plastic			

<sup>1</sup>with ball bearings



1

<b>GEV No.</b>	601130 <sup>1</sup>	<b>Ref. No.</b>	006125
<b>description</b>	axial fan L 80mm W 80mm H 25mm 230VAC 50/60Hz 13/14W bearing ball bearing connection male faston 2.8mm metal ADDA fan wheel ø 75mm temp.-resist. 70°C airflow 30.6m³/h		
<b>accessories for</b>	601130		
	<b>GEV No.</b>	550898	<b>Ref. No.</b> —
	connecting cable cable length 2000mm connection F 2.8 connection distance 7.9mm for axial flow fan		

<sup>1</sup>with ball bearings

## refrigeration fans

### refrigeration motors universal

ELCO

N series - standard



1

<b>GEV No.</b>	601444	<b>Ref. No.</b>	087168
<b>description</b>	fan motor 25W 230V 50Hz W 83mm cable length 2000mm 1300/1550rpm VNT25-40/003		

### IMPORT

#### multi fit fan motors



1

<b>GEV No.</b>	601022	<b>Ref. No.</b>	0A8789
<b>description</b>	fan motor 10W 230V 50-60Hz L1 44mm L2 54mm L3 85mm W 84mm cable length 500mm 1300rpm YZF10-20-18/26 5 mounting options bearing slide bearing		



1

<b>GEV No.</b>	601023	<b>Ref. No.</b>	0A8419
<b>description</b>	fan motor 16W 230V 50-60Hz L1 45mm L2 61mm L3 92mm W 84mm cable length 500mm 1300rpm YZF16-25-18/26 5 mounting options bearing slide bearing		



1

<b>GEV No.</b>	601024	<b>Ref. No.</b>	081394
<b>description</b>	fan motor 25W 230V 50-60Hz L1 49mm L2 80mm L3 112mm W 84mm cable length 500mm 1300rpm YZF25-40-18/26 5 mounting options bearing slide bearing shaft ø 8mm		



1

<b>GEV No.</b>	601020	<b>Ref. No.</b>	0A8400
<b>description</b>	fan motor 5W 230V 50-60Hz L1 44mm L2 48mm L3 79mm W 84mm cable length 500mm 1300rpm YZF5-13-18/26 5 mounting options bearing slide bearing		

accessories

fan wheels

aluminium



<b>GEV No.</b>	601172	<b>Ref. No.</b>	082230
<b>description</b>	fan wheel sucking ø 230mm fan wheel mounting 25.4mm blade angle 34° W 50mm aluminium		

miscellaneous



<b>GEV No.</b>	601119	<b>Ref. No.</b>	0A9308
<b>description</b>	fan 230V 50/60Hz 2W ø 100mm type C09R1731 fan wheel ø 100mm connection male faston 6.3mm shaft L 23mm		

cold air circulating fans (complete)

ebm-papst

R2E series



<b>GEV No.</b>	601536	<b>Ref. No.</b>	0E5666
<b>description</b>	fan R2E190-A026-73 fan wheel ø 190mm blades 6 230V 50/60Hz 58/75W ø 190mm H 70mm 2700rpm cable length 450mm rotation direction right ebm-papst sucking suitable capacitor 2µF		

<b>spare parts for</b>	601536		
<b>GEV No.</b>	365170	<b>Ref. No.</b>	—
<b>description</b>	capacitor capacity 2µF 425V tolerance 5% 50/60Hz ambient temperature max. -25 to +85°C ø 25mm L 49mm M8 plastic connection cable 250mm 416.17.74 protection		

cross flow fans

ebm-papst



<b>GEV No.</b>	601505	<b>Ref. No.</b>	0K5059
<b>description</b>	cross flow fan QLN65/2400A17-3030L roller ø 65mm roller length 240mm laminated core thickness 29mm motor position right 230V/50Hz 22W refrigeration bearing silicone connection F 6.3 0 up to +60°C 230V throughput 200m³/h 50Hz		

ZIEHL-ABEGG

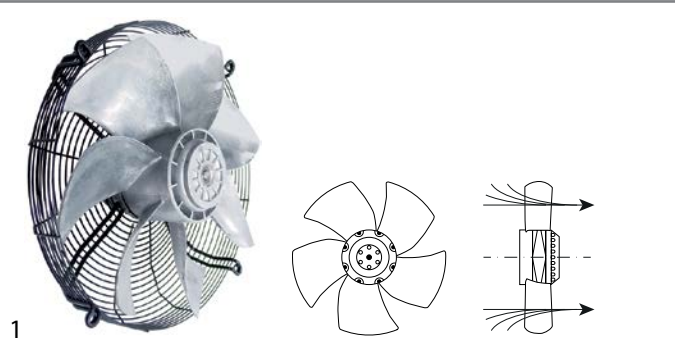

<b>GEV No.</b>	500881	<b>Ref. No.</b>	084914
<b>description</b>	fan fan wheel ø 450mm 400V 50/60Hz 410/540W ø 475mm mounting distance 515mm 1340/1560rpm cable lengthmm ZIEHL-ABEGG FE045-VDK.4F.3 blowing		

COPREL

with standard coil



<b>GEV No.</b>	601101	<b>Ref. No.</b>	083737
<b>description</b>	cross flow fan COPREL TFL(FN) roller ø 60mm roller length 300mm laminated core thickness 30mm motor position left 230V/50Hz 43W refrigeration bearing rubber connection male faston 6.3mm coil type airflow 268m³/h -10 up to +60°C		



1

<b>GEV No.</b>	601102	<b>Ref. No.</b>	082730
<b>description</b>	cross flow fan TFL 45 roller $\phi$ 45mm roller length 300mm motor position left 230V/50Hz 35W refrigeration bearing rubber connection male faston 6.3mm airflow 268m <sup>3</sup> /h -10 up to +60°C 230V 50Hz		



1

<b>GEV No.</b>	601452	<b>Ref. No.</b>	0A2272 0A3008
<b>description</b>	cross flow fan TFL 180 roller $\phi$ 60mm roller length 180mm laminated core thickness 20mm motor position left 230V/50Hz 19W universal bearing silicone connection male faston 6.3mm airflow 100m <sup>3</sup> /h -30 up to +100°C 230V 50Hz		



1

<b>GEV No.</b>	601453	<b>Ref. No.</b>	005204
<b>description</b>	cross flow fan TFR 180 roller $\phi$ 60mm roller length 180mm laminated core thickness 16mm motor position right 230V/50-60Hz 17W universal bearing silicone connection male faston 6.3mm airflow 100m <sup>3</sup> /h -30 up to +100°C 230V 50Hz		
<b>accessories for</b>	601453		
	<b>GEV No.</b>	415114	<b>Ref. No.</b> —
	heater battery mounting distance 185mm W 40mm H 35mm 2000W 230V temperature restriction 105°C heating circuits 2 connection cable cable length 150mm L 192mm for cross flow fan		

with moulded coils



1

<b>GEV No.</b>	601456	<b>Ref. No.</b>	0A8087
<b>description</b>	cross flow fan roller $\phi$ 45mm roller length 180mm laminated core thickness 15mm motor position right 230V/50Hz 26W universal bearing silicone connection male faston 6.3mm -30 up to +100°C 230V 50/60Hz		

double fans



1

<b>GEV No.</b>	601455	<b>Ref. No.</b>	0K4850
<b>description</b>	cross flow fan roller $\phi$ 60mm roller length 2x180mm laminated core thickness 35mm motor position centre 230V/50Hz 30W universal bearing silicone connection F 6.3 airflow 280m <sup>3</sup> /h -30 up to +100°C total length 470mm		

hot air motors



1

<b>GEV No.</b>	511313	<b>Ref. No.</b>	005132
<b>description</b>	centring piece for fan motor		



1

<b>GEV No.</b>	511302	<b>Ref. No.</b>	0H6643
<b>description</b>	engine shaft gasket ID $\phi$ 16mm ED $\phi$ 40mm for 55/56 series		



1

<b>GEV No.</b>	601040	<b>Ref. No.</b>	054829
<b>description</b>	fan motor		



1

<b>GEV No.</b>	500103	<b>Ref. No.</b>	0H6929
<b>description</b>	fan motor 220-240/380-415V 3 phase 50/60Hz 0.25kW 1400rpm speeds 1 L1 150mm L2 32mm L3 40mm $\phi$ 125mm M10R IT at 50Hz 1400rpm at 60Hz 1700rpm type L7Aw4D-099 no. X3 D1 $\phi$ 17mm D2 $\phi$ 14mm		







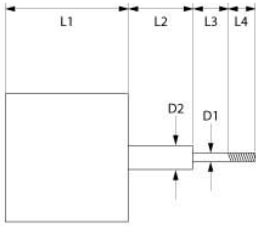

1

<b>GEV No.</b>	601041	<b>Ref. No.</b>	054836
<b>description</b>	fan motor 220-240/380-415V 3 phase 50Hz 0.19kW 1350rpm 1/0.58A		

1

<b>GEV No.</b>	601449	<b>Ref. No.</b>	058667	
<b>description</b>	fan motor 220-240/380-415V 3 phase 50Hz 0.19kW 1350rpm speeds 1 L1 105mm L2 74mm L3 35mm L4 12mm D1 $\varnothing$ 9x10mm D2 $\varnothing$ 12mm M6R IT 0.58/1A type FIR1092 no. 1092 shaft flat length 9mm			
<b>accessories for</b>	601449			
	<b>GEV No.</b>	693846	<b>Ref. No.</b>	058731
	spacer piece for fan motor			
	<b>GEV No.</b>	693847	<b>Ref. No.</b>	058729
	fixing plate for hot air motors ED $\varnothing$ 230mm H 2.5mm ID $\varnothing$ 16mm			
	<b>GEV No.</b>	694297	<b>Ref. No.</b>	058957
	flange for hot air motors ED $\varnothing$ 270mm H 3.5mm ID $\varnothing$ 16mm			

1

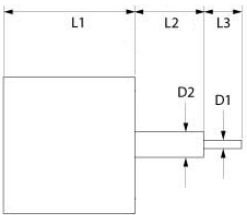
<b>GEV No.</b>	601378	<b>Ref. No.</b>	058607
<b>description</b>	fan motor 220-240/380-415V 3 phase 50Hz 0.35kW 1350rpm speeds 1 L1 143mm L2 91mm L3 34mm D1 $\varnothing$ 10mm D2 $\varnothing$ 16mm M6R IT 1.8/1A number of pole pairs 4 at 50Hz 1350rpm type FIR1093/V		

1

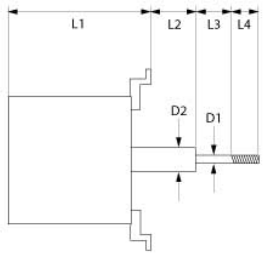
<b>GEV No.</b>	500815	<b>Ref. No.</b>	058994
<b>description</b>	fan motor 220-240V 1 phase 50Hz 0.07/0.2kW 950/1350rpm speeds 2 L1 140mm L2 70mm L3 35mm L4 22mm D1 $\varnothing$ 9/10mm D2 $\varnothing$ 12mm 2 speeds M6R IT 0.55/0.70A at 50Hz 230V at 50Hz 950/1350rpm suitable capacitor 10 $\mu$ F 4P/6P type LM/FB80 no. 386328 shaft flat length 14mm		

1

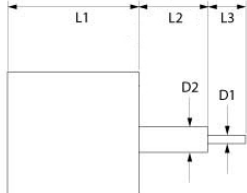
<b>GEV No.</b>	601360	<b>Ref. No.</b>	058587
<b>description</b>	fan motor 220V 1 phase 50Hz 0.1kW 1350rpm speeds 1 L1 105mm L2 66mm L3 35mm D1 $\varnothing$ 10mm D2 $\varnothing$ 12mm M6R IT 0.9A number of pole pairs 4 suitable capacitor 4 $\mu$ F/450V at 50Hz 1350rpm type FIR1092/M		



1

<b>GEV No.</b>	500814	<b>Ref. No.</b>	005750
<b>description</b>	fan motor 230V 1 phase 50/60Hz 0.19kW 1400/1700rpm speeds 1 L1 145mm L2 51mm L3 35mm D1 $\varnothing$ 10mm D2 $\varnothing$ 16mm M6R IT 1.3A at 50Hz 1400rpm at 60Hz 1700rpm suitable capacitor 10 $\mu$ F shaft flat length 12mm		

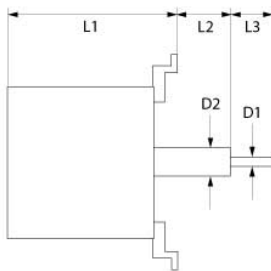
1

<b>GEV No.</b>	500141	<b>Ref. No.</b>	0F0007
<b>description</b>	fan motor 230V 1 phase 50/60Hz 0.19kW 1450/1750rpm speeds 1 L1 150mm L2 52mm L3 35mm D1 $\varnothing$ 9/10mm D2 $\varnothing$ 14mm M6R IT 1.3A Cos(fi) 0.91 at 50Hz 1450rpm at 60Hz 1750rpm type LM80/4 no. 596477 shaft flat length 12mm		

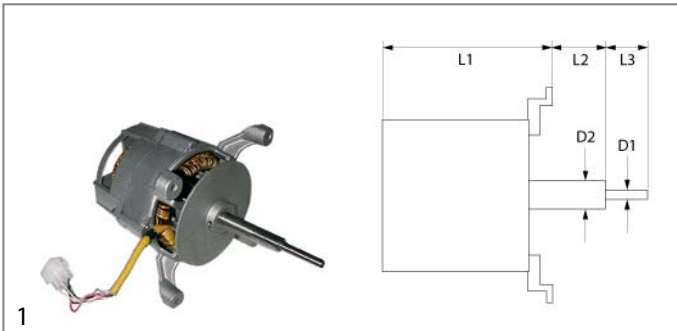

1

<b>GEV No.</b>	500143	<b>Ref. No.</b>	002739
<b>description</b>	fan motor 230V 1 phase 50/60Hz 0.35kW 1400/1700rpm speeds 1 L1 165mm L2 91mm L3 35mm D1 ø 9/10mm D2 ø 16mm M6R IT 2.7A Cos(fi) 0.9 at 50Hz 230V at 60Hz 230V at 50Hz 1400rpm at 60Hz 1700rpm suitable capacitor 16µF/450V type LM80/4 no. 556749 shaft flat length 13mm		



1

<b>GEV No.</b>	500653	<b>Ref. No.</b>	005748
<b>description</b>	fan motor 230V 1 phase 50Hz 0.06/0.19kW 930/1425rpm speeds 2 L1 150mm L2 52mm L3 35mm D1 ø 10mm D2 ø 16mm M6R IT 1.3/0.8A power input 0.19W at 50Hz 930/1425rpm suitable capacitor 10µF shaft flat length 12mm		

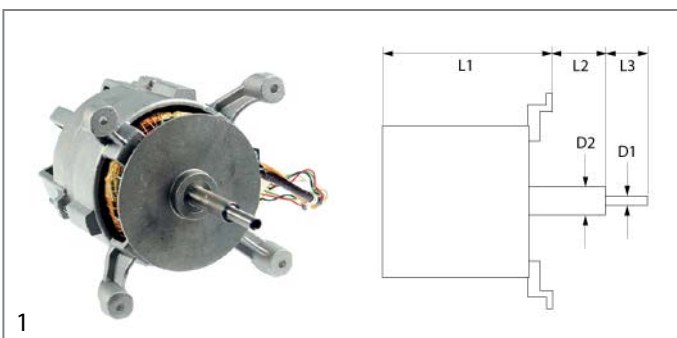

1

<b>GEV No.</b>	601222	<b>Ref. No.</b>	006998
<b>description</b>	fan motor 230V 1 phase 50Hz 0.06/0.19kW 890/1395rpm speeds 2 L1 165mm L2 49mm L3 35mm D1 ø 10mm D2 ø 16mm M6R IT 1.6/1.4A Cos(fi) 0.85 at 50Hz 230V at 60Hz 230V at 50Hz 890/1395rpm at 60Hz 950/1695rpm suitable capacitor 12.5µF/450V 4P/6P type LM/FB80 no. 496040 shaft flat length 13mm		

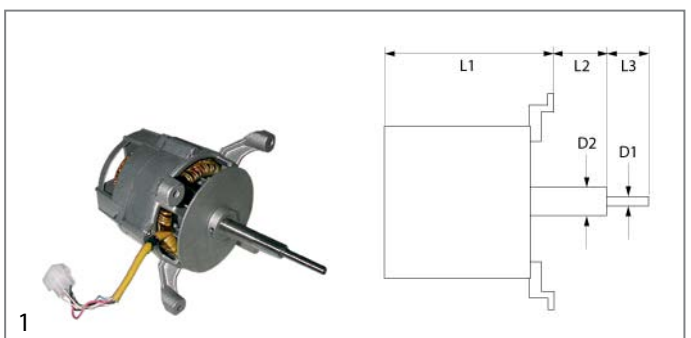

1

<b>GEV No.</b>	500144	<b>Ref. No.</b>	002748
<b>description</b>	fan motor 230V 1 phase 50Hz 0.11/0.35kW 900/1400rpm speeds 2 L1 165mm L2 91mm L3 35mm D1 ø 9/10mm D2 ø 16mm M6R IT 2.7/1.3A at 50Hz 230V at 60Hz 230V at 50Hz 900/1400rpm at 60Hz 1080/1680rpm suitable capacitor 16µF/450V 4P/6P type LM/FB80 no. 358008 shaft flat length 12mm		

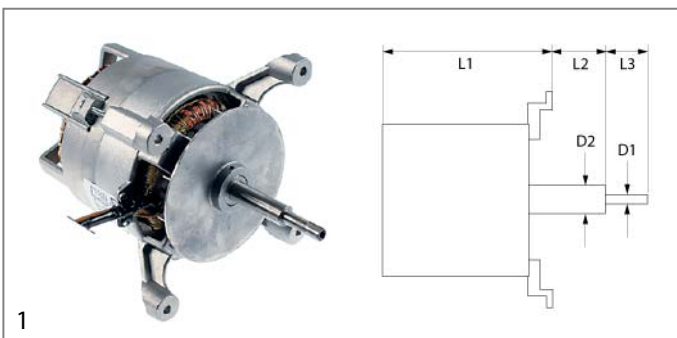

1

<b>GEV No.</b>	500142	<b>Ref. No.</b>	005028
<b>description</b>	fan motor 230V 1 phase 50Hz 0.06/0.19kW 930/1380rpm speeds 2 L1 160mm L2 52mm L3 35mm D1 ø 9/10mm D2 ø 16mm M6R IT 1.5/0.7A Cos(fi) 0.9 at 50Hz 930/1380rpm at 60Hz 1100/1700rpm suitable capacitor 12.5µF/400V 4P/6P type LM/FB80 no. 552059 shaft flat length 12mm		

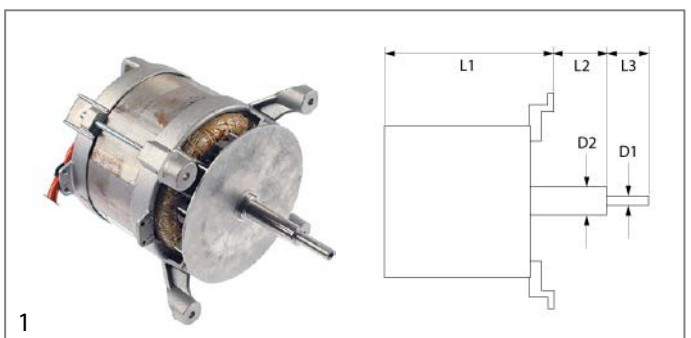

1

<b>GEV No.</b>	500816	<b>Ref. No.</b>	0C1171 0C6563
<b>description</b>	fan motor 230V 1 phase 50Hz 0.22/0.75kW 955/1460rpm speeds 2 L1 175mm L2 52mm L3 32mm D1 ø 10mm D2 ø 16mm M6R IT 1.0/2.4A number of pole pairs 4P/6P Cos(fi) 0.84 at 50Hz 230V at 60Hz 230V at 50Hz 955/1460rpm at 60Hz 1145/1750rpm suitable capacitor 31.5/16µF 4P/6P type LM/FB 100L no. 494886 shaft flat length 13mm		



1

<b>GEV No.</b>	500108	<b>Ref. No.</b>	0H6930
<b>description</b>	fan motor 380-415V 3 phase 50/60Hz 0.03/0.2kWrpm speeds 2 L1 155mm L2 30mm L3 31mm M10R IT Y/YY type L7mw84D-097 no. V5 D1 ø 17mm D2 ø 13mm		

1

<b>GEV No.</b>	601220	<b>Ref. No.</b>	0C6462
<b>description</b>	fan wheel D1 ø 280mm H1 100mm blades 6 D2 ø 10mm D3 ø 10mm H2 37mm H3 22mm		

1

<b>GEV No.</b>	602139	<b>Ref. No.</b>	0H6932
<b>description</b>	fan motor 440-480V 3 phase 60Hz 0.37kW 1600rpm L1 185mm L2 26mm L3 50mm type L9Cw4D-157 D1 ø 25mm D2 ø 20mm		
<b>accessories for</b>	602139		
	<b>GEV No.</b>	510574	<b>Ref. No.</b> —
	shaft sealing type 20 for fan motor		

1

<b>GEV No.</b>	601371	<b>Ref. No.</b>	002871 0C8325
<b>description</b>	fan wheel D1 ø 280mm H1 100mm blades 6 D2 ø 10mm D3 ø 10mm H2 37mm H3 23mm		

1

<b>GEV No.</b>	601235	<b>Ref. No.</b>	055422
<b>description</b>	fan wheel D1 ø 280mm H1 100mm blades 6 D2 ø 10mm D3 ø 10mm H2 37mm H3 10mm		

1

<b>GEV No.</b>	601236	<b>Ref. No.</b>	007000 0C7029
<b>description</b>	fan wheel D1 ø 280mm H1 130mm blades 10 D2 ø 10mm D3 ø 10mm H2 38mm H3 23mm		

1

<b>GEV No.</b>	601233	<b>Ref. No.</b>	0C6463
<b>description</b>	fan wheel D1 ø 350mm H1 135mm blades 6 D2 ø 10mm D3 ø 10mm H2 37.5mm		



1

<b>GEV No.</b>	601197	<b>Ref. No.</b>	054890
<b>description</b>	fan wheel D1 ø 350mm H1 135mm blades 6 D2 ø 9.5mm D3 ø 9.5mm H2 38mm H3 20mm		



1

<b>GEV No.</b>	601234	<b>Ref. No.</b>	0C6464
<b>description</b>	fan wheel D1 ø 380mm H1 170mm blades 12 D2 ø 10mm D3 ø 10mm H2 38mm H3 19mm		



1

<b>GEV No.</b>	601218	<b>Ref. No.</b>	055378
<b>description</b>	fan wheel D1 ø 440mm H1 152mm blades 6 D2 ø 10mm D3 ø 10mm H2 37mm H3 31mm		



1

<b>GEV No.</b>	601232	<b>Ref. No.</b>	003715
<b>description</b>	fan wheel D1 ø 440mm H1 155mm blades 6 D2 ø 10mm D3 ø 16mm H2 51mm H3 39mm		



1

<b>GEV No.</b>	693847	<b>Ref. No.</b>	058729
<b>description</b>	fixing plate for hot air motors ED ø 230mm H 2.5mm ID ø 16mm		



1

<b>GEV No.</b>	694297	<b>Ref. No.</b>	058957
<b>description</b>	flange for hot air motors ED ø 270mm H 3.5mm ID ø 16mm		



1

<b>GEV No.</b>	693410	<b>Ref. No.</b>	055339
<b>description</b>	gasket for hot air motors		



1

<b>GEV No.</b>	693411	<b>Ref. No.</b>	055377
<b>description</b>	gasket for hot air motors		



1

<b>GEV No.</b>	511300	<b>Ref. No.</b>	002873
<b>description</b>	O-ring Viton thickness 3.53mm ID ø 28.17mm for 57 series for motor shaft		



1

<b>GEV No.</b>	511301	<b>Ref. No.</b>	002699
<b>description</b>	shaft seal ID ø 16mm ED ø 38mm thickness 18mm		

hot air fans

ebm-papst

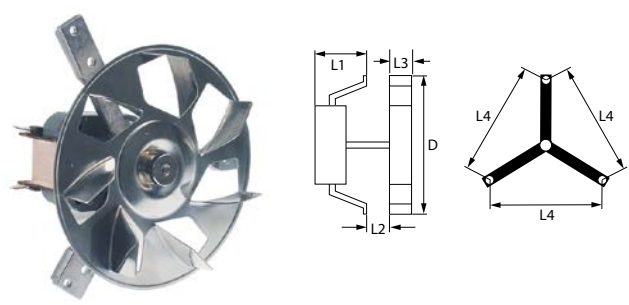



1

<b>GEV No.</b>	601198	<b>Ref. No.</b>	054842
<b>description</b>	hot air fan 230V 38W L1 65mm L2 20mm L3 25mm L4 130mm fan wheel ø 153mm type RRC140/0024A18 ebm-papst		

miscellaneous



1

<b>GEV No.</b>	601011	<b>Ref. No.</b>	031484
<b>description</b>	hot air fan 220-240V 40W 50/60Hz L1 65mm L2 15mm L3 25mm L4 87mm fan wheel ø 150mm FIME type C25R8023CLH		
<b>accessories for</b>	601011		
	<b>GEV No.</b>	550879	<b>Ref. No.</b> —
	insulation ø 130mm thickness 3mm hole ø 20mm for hot air fan		
	<b>GEV No.</b>	601260	<b>Ref. No.</b> —
	nut thread M6L IT for hot air fan		

1

<b>GEV No.</b>	601199	<b>Ref. No.</b>	005202
<b>description</b>	hot air fan 220-240V 24-28W L1 60mm L2 25mm L3mm L4 87mm fan wheel ømm PLASET type M0850		

1

<b>GEV No.</b>	601201	<b>Ref. No.</b>	054314
<b>description</b>	hot air fan 230V 26W fan wheel ø 150mm		

accessories

fan wheels for hot air fans

1

<b>GEV No.</b>	601200	<b>Ref. No.</b>	005221
<b>description</b>	fan wheel ø 150mm W 20mm shaft intake ø 6x5mm zinc-plated blades 7		

radial fans

1

<b>GEV No.</b>	601238	<b>Ref. No.</b>	002639
<b>description</b>	radial fan 230V voltage AC 50Hz 40W H1 205mm L1 205mm D1 ø 150mm W1 103mm W2 32mm H2 83mm W3 34mm H3 86mm		



1

<b>GEV No.</b>	500817	<b>Ref. No.</b>	OC1112
<b>description</b>	radial fan 24V voltage DC 50Hz 55W H1 180mm L1 180mm D1 ø 50mm W1 112mm W2 40mm H2 45mm W3 83mm H3 83mm		

extractor fans

speed controllers



1

<b>GEV No.</b>	402957	<b>Ref. No.</b>	032279
<b>description</b>	speed controller voltage input 230V voltage output 46-184V/115-230VV 1200W max. 10A load current 6A wall-mounted version length external size 135mm width external size 74mm D 72mm for range hoods		



1

<b>GEV No.</b>	402956	<b>Ref. No.</b>	032986
<b>description</b>	speed controller voltage input 230V voltage output min. 69-138/max. 110-230VV 1800W max. 13A load current 8A wall-mounted version length external size 170mm width external size 105mm D 82mm for range hoods		

accessories universal



1

<b>GEV No.</b>	693846	<b>Ref. No.</b>	058731
<b>description</b>	spacer piece for fan motor		

motors

gear motors

for ovens

for flues



1

<b>GEV No.</b>	360342	<b>Ref. No.</b>	OC0883
<b>description</b>	gear motor FIBER type P245J01C620 230V voltage AC 50/60Hz 2rpm shaft ø 6mm L 76mm W 55mm H 48mm motor type M51BJOR0000		

motors

for tilting bratt pans



1

<b>GEV No.</b>	500823	<b>Ref. No.</b>	052802
<b>description</b>	motor 170W 230V 50Hz 1 phase shaft ø 17mm shaft length 60mm 320/2800rpm type 20571252 ø 160mm H 235mm mounting distance 145mm capacitor 16µF SOLE 0.17kW		

for microwaves



1

<b>GEV No.</b>	500628	<b>Ref. No.</b>	002794
<b>description</b>	motor 20W 230V 50Hz shaft ø 9mm shaft length 12mm flange ø 73mm 1400rpm type M81A25G4GE H 80mm L 95mm W 80mm capacitor 1.5µF PANASONIC 0.02kW		

spindle motors

MECVEL



<b>GEV No.</b>	500621	<b>Ref. No.</b>	006690
<b>description</b>	spindle motor type PP041.0012 24V voltage DC shaft ø 16mm for pasta cooker L 255mm W 60mm H 135mm MECVEL		





pumps

wash and rinse pumps





ALBA (C&A)

pumps



<b>GEV No.</b>	500129	<b>Ref. No.</b>	0L0406
<b>description</b>	pump inlet ø 32mm outlet ø 30mm type C6300 230V 50Hz 1 phase 0.28kW 0.38HP L 200mm rotation direction left capacitor 6.3µF auxiliary pressure connection 13mm supporting pressure closed ALBA PUMPS (C&A)		
<b>spare parts for</b>	500129		
	<b>GEV No.</b>	365012	<b>Ref. No.</b> —
	operating capacitor capacity 6.3µF 450V tolerance 5% 50Hz ambient temperature max. -25 to +85°C ø 30mm L 61mm M8 plastic connection male faston 6.3mm protection		
	<b>GEV No.</b>	510695	<b>Ref. No.</b> —
	mechanical shaft seal height counter ring 5.5mm ID ø 11mm		
	<b>GEV No.</b>	521227	<b>Ref. No.</b> 049187
	impellor ø 78mm H 24mm rotation direction left thread M6R shaft ø 11mm shaft length 28mm		
	<b>GEV No.</b>	521522	<b>Ref. No.</b> 049186
	pump cover ALBA PUMPS (C&A) inlet ø 32mm outlet ø 30mm auxiliary pressure connection 13mm supporting pressure closed turn direction left ø 106mm ID ø 82mm inner height 31mm		
	<b>GEV No.</b>	521705	<b>Ref. No.</b> —
	pump cover gasket EPDM thickness 2mm ID ø 80mm Qty 1 pcs		



<b>GEV No.</b>	500113	<b>Ref. No.</b>	048304
<b>description</b>	pump inlet ø 45mm outlet ø 40mm type C3100 400V 50Hz 3 phase 0.75kW 1HP L 215mm rotation direction right ALBA PUMPS (C&A)		
<b>spare parts for</b>	500113		
	<b>GEV No.</b>	504320	<b>Ref. No.</b> —
	pump cover gasket ID ø 160.75mm thickness 3.53mm EPDM Qty 1 pcs		
	<b>GEV No.</b>	510693	<b>Ref. No.</b> —
	mechanical shaft seal for shaft ø 12mm slide ring ext. ø 24mm slide ring H 15.5mm slide ring int. ø 11mm counter ring mounting ø 24mm height counter ring 8mm counter ring int. ø 13.5mm		
	<b>GEV No.</b>	521238	<b>Ref. No.</b> —
	impellor ø 103mm H 32mm rotation direction right thread M7L seat ø 9.2mm blades 6		
	<b>GEV No.</b>	521531	<b>Ref. No.</b> —
	pump cover ALBA PUMPS (C&A) inlet ø 45mm outlet ø 40mm turn direction right ø 153mm ID ø 127mm inner height 24mm		
	<b>GEV No.</b>	521709	<b>Ref. No.</b> 048984
	O-ring EPDM thickness 3mm ID ø 126mm Qty 1 pcs		

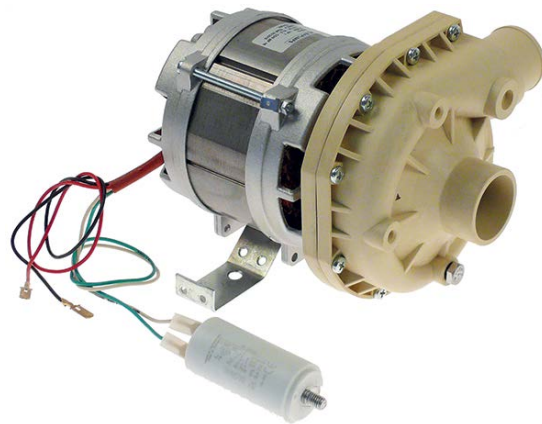





<b>GEV No.</b>	500114	<b>Ref. No.</b>	048885
<b>description</b>	pump inlet ø 45mm outlet ø 40mm type C5800/2013 230V 50Hz 1 phase 0.75kW 1HP L 225mm rotation direction right capacitor 16µF ALBA PUMPS (C&A)		
<b>spare parts for</b>	500114		
	<b>GEV No.</b>	365021	<b>Ref. No.</b> 0A2914
	operating capacitor capacity 16µF 425V tolerance 5% 50/60Hz ambient temperature max. -25 to +85°C ø 35mm L 73mm single M8 plastic connection male faston 6.3mm 416.10.99 protection		
	<b>GEV No.</b>	509021	<b>Ref. No.</b> —
	impellor ø 102mm H 32mm shaft intake ø 9/8mm rotation direction right		







Table continues overleaf



<b>spare parts for</b> 500114			
	GEV No.	510693	Ref. No. —
mechanical shaft seal for shaft $\varnothing$ 12mm slide ring ext. $\varnothing$ 24mm slide ring H 15.5mm slide ring int. $\varnothing$ 11mm counter ring mounting $\varnothing$ 24mm height counter ring 8mm counter ring int. $\varnothing$ 13.5mm			
	GEV No.	521531	Ref. No. —
pump cover ALBA PUMPS (C&A) inlet $\varnothing$ 45mm outlet $\varnothing$ 40mm turn direction right $\varnothing$ 153mm ID $\varnothing$ 127mm inner height 24mm			
	GEV No.	521709	Ref. No. 048984
O-ring EPDM thickness 3mm ID $\varnothing$ 126mm Qty 1 pcs			



1





<b>GEV No.</b>	500090	<b>Ref. No.</b>	046370
<b>description</b>	pump inlet $\varnothing$ 45mm outlet $\varnothing$ 40mm type C5803 230V 50Hz 1 phase 0.55kW 0.75HP L 210mm rotation direction right capacitor 12.5 $\mu$ F ALBA PUMPS (C&A)		
<b>spare parts for</b> 500090			
	GEV No.	365014	Ref. No. —
operating capacitor capacity 12.5 $\mu$ F 450V tolerance 5%Hz ambient temperature max. -25 to +85°C $\varnothing$ 35mm L 70mm M8 plastic connection male faston 6.3mm 45S.C3DS.12.5 protection			
	GEV No.	504320	Ref. No. —
pump cover gasket ID $\varnothing$ 160.75mm thickness 3.53mm EPDM Qty 1 pcs			
	GEV No.	509021	Ref. No. —
impellor $\varnothing$ 102mm H 32mm shaft intake $\varnothing$ 9/8mm rotation direction right			
	GEV No.	510692	Ref. No. —
mechanical shaft seal for shaft $\varnothing$ 11mm slide ring ext. $\varnothing$ 24mm slide ring H 13mm counter ring mounting $\varnothing$ 26mm height counter ring 8mm counter ring int. $\varnothing$ 14mm			
	GEV No.	521531	Ref. No. —
pump cover ALBA PUMPS (C&A) inlet $\varnothing$ 45mm outlet $\varnothing$ 40mm turn direction right $\varnothing$ 153mm ID $\varnothing$ 127mm inner height 24mm			
	GEV No.	521709	Ref. No. 048984
O-ring EPDM thickness 3mm ID $\varnothing$ 126mm Qty 1 pcs			

## FIR

## pumps



1

<b>GEV No.</b>	500394	<b>Ref. No.</b>	049310
<b>description</b>	pump inlet $\varnothing$ 28mm outlet $\varnothing$ 26mm type 4213.1500 230V 50Hz 1 phase 0.28kW 0.38HP L 195mm rotation direction left capacitor 6.3 $\mu$ F FIR		
<b>spare parts for</b> 500394			
	GEV No.	510384	Ref. No. —
pump cover inlet $\varnothing$ 28mm outlet $\varnothing$ 26mm $\varnothing$ 100mm ID $\varnothing$ 76mm			
	GEV No.	510532	Ref. No. —
impellor $\varnothing$ 72mm H 22mm shaft $\varnothing$ 11mm shaft length 32mm blades 3			
	GEV No.	510695	Ref. No. —
mechanical shaft seal height counter ring 5.5mm ID $\varnothing$ 11mm			
	GEV No.	521703	Ref. No. —
pump cover gasket EPDM thickness 2.5mm ID $\varnothing$ 75mm Qty 1 pcs			
<b>accessories for</b> 500394			
	GEV No.	365012	Ref. No. —
operating capacitor capacity 6.3 $\mu$ F 450V tolerance 5% 50Hz ambient temperature max. -25 to +85°C $\varnothing$ 30mm L 61mm M8 plastic connection male faston 6.3mm protection			





1





<b>GEV No.</b>	500598	<b>Ref. No.</b>	0L1079
<b>description</b>	pump inlet ø 30mm outlet ø 26mm type 5213E2450 230V 50Hz 1 phase 0.22kW 0.1HP L 190mm rotation direction left capacitor 5µF FIR		
<b>spare parts for</b>	500598		
	<b>GEV No.</b>	365017	<b>Ref. No.</b> —
	operating capacitor capacity 5µF 450V tolerance 5% 50/60Hz ambient temperature max. -25 to +85°C ø 28mm L 54mm M8 plastic connection male faston 6.3mm 16.10.08 protection		
	<b>GEV No.</b>	502265	<b>Ref. No.</b> —
	pump cover inlet ø 30mm outlet ø 26mm ID ø 89mm inner height 35mm		
	<b>GEV No.</b>	510695	<b>Ref. No.</b> —
	mechanical shaft seal height counter ring 5.5mm ID ø 11mm		
	<b>GEV No.</b>	521203	<b>Ref. No.</b> —
	impellor ø 72mm H 18mm thread M7 shaft ø 11mm shaft length 32mm blades 3		
	<b>GEV No.</b>	532718	<b>Ref. No.</b> —
	O-ring EPDM thickness 4mm ID ø 80mm Qty 1 pcs		
	<b>GEV No.</b>	699372	<b>Ref. No.</b> —
	flange for pump with cover type 5213 L 103mm W 103mm H 69mm		



1





<b>GEV No.</b>	500396	<b>Ref. No.</b>	049876
<b>description</b>	pump inlet ø 45mm outlet ø 40mm type B257.1700 230V 50Hz 1 phase 0.75kW 1HP L 220mm rotation direction right capacitor 16µF FIR		
<b>spare parts for</b>	500396		
	<b>GEV No.</b>	365021	<b>Ref. No.</b> 0A2914
	operating capacitor capacity 16µF 425V tolerance 5% 50/60Hz ambient temperature max. -25 to +85°C ø 35mm L 73mm single M8 plastic connection male faston 6.3mm 416.10.99 protection		

**spare parts for** 500396

	<b>GEV No.</b>	510508	<b>Ref. No.</b>	—
	pump cover FIR inlet ø 45mm outlet ø 40mm pump type PU 0.5/3911 turn direction right ø 160mm ID ø 125mm inner height 25mm			
	<b>GEV No.</b>	510692	<b>Ref. No.</b>	—
	mechanical shaft seal for shaft ø 11mm slide ring ext. ø 24mm slide ring H 13mm counter ring mounting ø 26mm height counter ring 8mm counter ring int. ø 14mm			
	<b>GEV No.</b>	521001	<b>Ref. No.</b>	—
	impellor ø 91mm H 30mm pump type B267.4050 rotation direction right			
	<b>GEV No.</b>	521702	<b>Ref. No.</b>	048630
	pump cover gasket thickness 3.5x4.5mm Qty 1 pcs			



1

<b>GEV No.</b>	499139	<b>Ref. No.</b>	049669
<b>description</b>	pump inlet ø 62mm outlet ø 62mm type 2275.2722 230/400V 50Hz 3 phase 2.6kW L 400mm rotation direction right FIR		
<b>spare parts for</b>	499139		
	<b>GEV No.</b>	510687	<b>Ref. No.</b> —
	mechanical shaft seal for shaft ø 18mm height counter ring 8mm ID ø 17mm ED ø 39mm H 15mm mounting ø 42mm int. ø 121mm		
	<b>GEV No.</b>	521026	<b>Ref. No.</b> —
	pump cover gasket ID ø 182.5mm thickness 5x4.5mm		
	<b>GEV No.</b>	521028	<b>Ref. No.</b> —
	pump cover FIR inlet ø 62mm outlet ø 62mm turn direction right ø 215mm ID ø 175mm inner height 40mm		
	<b>GEV No.</b>	521277	<b>Ref. No.</b> —
	impellor ø 135mm H 39mm pump type Fir 2275 - 3.6HP thread M14L		
	<b>GEV No.</b>	524676	<b>Ref. No.</b> —
	fan wheel ø 160mm shaft intake ø 24mm plastic blades 12 W 30mm		



1

<b>GEV No.</b>	500986	<b>Ref. No.</b>	0L0039
<b>description</b>	pump inlet ø 62mm outlet ø 62mm type 4290.2700 220-240/380-415V 50Hz 3 phase 1.5kW 2HP L 350mm rotation direction right FIR		
<b>spare parts for</b>	500986		
	<b>GEV No.</b>	510687	<b>Ref. No.</b> —
	mechanical shaft seal for shaft ø 18mm height counter ring 8mm ID ø 17mm ED ø 39mm H 15mm mounting ø 42mm int. ø 1 21mm		
	<b>GEV No.</b>	521017	<b>Ref. No.</b> —
	impeller ø 120mm H 35mm rotation direction right thread M14L seat ø 18mm blades 6		
	<b>GEV No.</b>	521026	<b>Ref. No.</b> —
	pump cover gasket ID ø 182.5mm thickness 5x4.5mm		
	<b>GEV No.</b>	521028	<b>Ref. No.</b> —
	pump cover FIR inlet ø 62mm outlet ø 62mm turn direction right ø 215mm ID ø 175mm inner height 40mm		
	<b>GEV No.</b>	521039	<b>Ref. No.</b> —
	fanwheel cover ID ø 156mm ED ø 161mm H 76mm for wash pump		





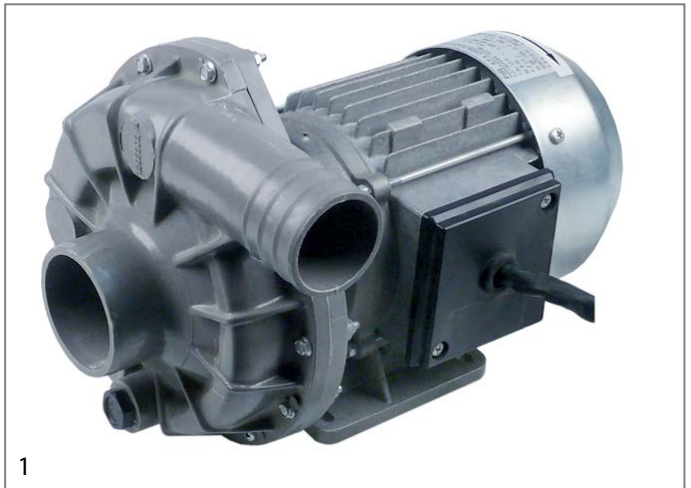

1

<b>GEV No.</b>	500985	<b>Ref. No.</b>	0L0437
<b>description</b>	pump inlet ø 62mm outlet ø 64mm type 4290.2700 220-240/380-415V 50Hz 3 phase 1.5kW 2HP L 350mm rotation direction right FIR installation kit inclusive		



1

<b>GEV No.</b>	500112	<b>Ref. No.</b>	046574
<b>description</b>	pump inlet ø 63mm outlet ø 47mm 230/400V 50Hz 3 phase 0.55kW 0.75HP L 305mm rotation direction right FIR		
<b>spare parts for</b>	500112		
	<b>GEV No.</b>	510601	<b>Ref. No.</b> 048464
	impeller ø 103mm H 25mm rotation direction right thread M8L seat ø 12.2mm blades 6		
	<b>GEV No.</b>	510693	<b>Ref. No.</b> —
	mechanical shaft seal for shaft ø 12mm slide ring ext. ø 24mm slide ring H 15.5mm slide ring int. ø 11mm counter ring mounting ø 24mm height counter ring 8mm counter ring int. ø 13.5mm		
	<b>GEV No.</b>	521513	<b>Ref. No.</b> —
	pump cover FIR inlet ø 63mm outlet ø 47mm turn direction right ID ø 150mm inner height 32mm		
	<b>GEV No.</b>	524416	<b>Ref. No.</b> —
	pump cover gasket thickness 4x4mm Qty 1 pcs		



1







<b>GEV No.</b>	500056	<b>Ref. No.</b>	047195
<b>description</b>	pump inlet ø 63mm outlet ø 47mm type 1211.2706 230/400V 50Hz 3 phase 0.55kW 0.75HP L 305mm rotation direction right FIR		
<b>spare parts for</b>	500056		
	<b>GEV No.</b>	510601	<b>Ref. No.</b> 048464
	impeller ø 103mm H 25mm rotation direction right thread M8L seat ø 12.2mm blades 6		
	<b>GEV No.</b>	510693	<b>Ref. No.</b> —
	mechanical shaft seal for shaft ø 12mm slide ring ext. ø 24mm slide ring H 15.5mm slide ring int. ø 11mm counter ring mounting ø 24mm height counter ring 8mm counter ring int. ø 13.5mm		
	<b>GEV No.</b>	521513	<b>Ref. No.</b> —
	pump cover FIR inlet ø 63mm outlet ø 47mm turn direction right ID ø 150mm inner height 32mm		



Table continues overleaf



<b>spare parts for</b> 500056			
	GEV No.	524416	Ref. No. —
pump cover gasket thickness 4x4mm Qty 1 pcs			

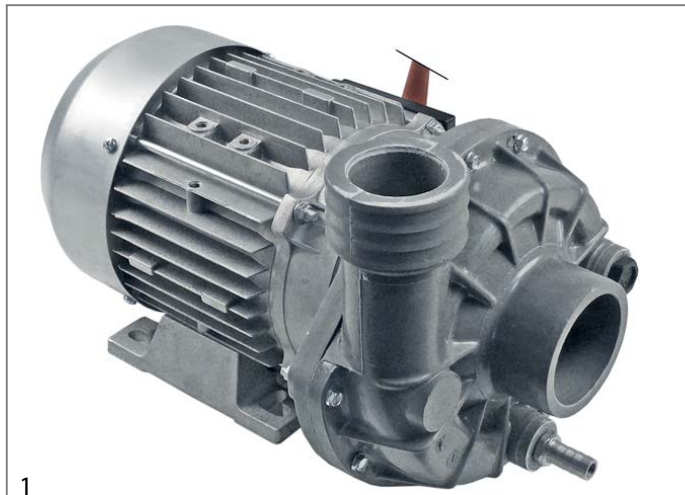

<b>1</b>			
<b>GEV No.</b>	500397	<b>Ref. No.</b>	047708
<b>description</b>	pump inlet ø 70mm outlet ø 60mm type 2254.1000 230/400V 50Hz 3 phase 1.1kW 1.5HP L 320mm rotation direction right FIR		
<b>spare parts for</b> 500397			
	GEV No.	510693	Ref. No. —
mechanical shaft seal for shaft ø 12mm slide ring ext. ø 24mm slide ring H 15.5mm slide ring int. ø 11mm counter ring mounting ø 24mm height counter ring 8mm counter ring int. ø 13.5mm			
	GEV No.	521515	Ref. No. 0L0496
pump cover inlet ø 70mm outlet ø 60mm			
	GEV No.	524416	Ref. No. —
pump cover gasket thickness 4x4mm Qty 1 pcs			





<b>1</b>			
<b>GEV No.</b>	500115	<b>Ref. No.</b>	048216
<b>description</b>	pump inlet ø 70mm outlet ø 60mm type 2254.2561 230/400V 50Hz 3 phase 1.5kW 2HP L 325mm rotation direction right FIR		
<b>spare parts for</b> 500115			
	GEV No.	504313	Ref. No. —
hose connector thread M12x1.75 grommet ø 11.3mm grommet length 23mm WS 17 total length 43mm thread L 15mm stainless steel IT M8x1.25			
	GEV No.	510693	Ref. No. —
mechanical shaft seal for shaft ø 12mm slide ring ext. ø 24mm slide ring H 15.5mm slide ring int. ø 11mm counter ring mounting ø 24mm height counter ring 8mm counter ring int. ø 13.5mm			
	GEV No.	521014	Ref. No. 048624
impeller ø 110mm H 32mm rotation direction right thread M8L shaft ø 28mm shaft length 3mm seat ø 12.2mm blades 6			

<b>spare parts for</b> 500115			
	GEV No.	521515	Ref. No. 0L0496
pump cover inlet ø 70mm outlet ø 60mm			
	GEV No.	524416	Ref. No. —
pump cover gasket thickness 4x4mm Qty 1 pcs			



LGB



<b>1</b>			
<b>GEV No.</b>	500466	<b>Ref. No.</b>	0L0571
<b>description</b>	pump inlet ø 28mm outlet ø 28mm type ZFC1121DX 230V 50Hz 1 phase 0.35kW 0.47HP L 200mm rotation direction left capacitor 6.3µF LGB		
<b>spare parts for</b> 500466			
	GEV No.	365012	Ref. No. —
operating capacitor capacity 6.3µF 450V tolerance 5% 50Hz ambient temperature max. -25 to +85°C ø 30mm L 61mm M8 plastic connection male faston 6.3mm protection			
	GEV No.	510703	Ref. No. —
mechanical shaft seal for shaft ø 13mm slide ring H 13mm height counter ring 5.5mm ED ø 26mm			
	GEV No.	521007	Ref. No. —
pump cover LGB inlet ø 28mm outlet ø 26mm turn direction left			
	GEV No.	521008	Ref. No. —
impeller ø 72mm H 22mm rotation direction left thread M7R shaft ø 13mm shaft length 12mm			
	GEV No.	528800	Ref. No. —
O-ring EPDM thickness 2.62mm ID ø 75.87mm Qty 1 pcs			





1

<b>GEV No.</b>	500943	<b>Ref. No.</b>	0L0092
<b>description</b>	pump inlet ø 62mm outlet ø 50mm type ZF522VSX 230V 50Hz 1 phase 0.7kW 0.95HP L 250mm rotation direction right capacitor 16µF LGB		
<b>spare parts for</b>	500943		
	<b>GEV No.</b>	365021	<b>Ref. No.</b> 0A2914
	operating capacitor capacity 16µF 425V tolerance 5% 50/60Hz ambient temperature max. -25 to +85°C ø 35mm L 73mm single M8 plastic connection male faston 6.3mm 416.10.99 protection		
	<b>GEV No.</b>	510551	<b>Ref. No.</b> 0L0338
	pump cover gasket ID ø 158.3mm pump type 1214/1293/1225/2243/1226/1204/3473/1241 thickness 3.53mm EPDM Qty 1 pcs		
	<b>GEV No.</b>	510694	<b>Ref. No.</b> —
	mechanical shaft seal for shaft ø 13mm height counter ring 8mm ID ø 11.5mm H 16mm mounting ø 24/26mm int. ø 1 14mm		
	<b>GEV No.</b>	521239	<b>Ref. No.</b> —
	impellor ø 110mm H 26mm rotation direction right thread M8L shaft ø 19.5mm shaft length 17mm seat ø 8.2mm blades 6		
	<b>GEV No.</b>	521536	<b>Ref. No.</b> —
	pump cover ALBA / LGB inlet ø 62mm outlet ø 50mm auxiliary pressure connection 12mm supporting pressure closed turn direction right ø 180mm ID ø 150mm inner height 38mm		



1

<b>GEV No.</b>	500468	<b>Ref. No.</b>	0L0564
<b>description</b>	pump inlet ø 63mm outlet ø 48mm type ZF523VSX 230/400V 50Hz 3 phase 1kW 1.36HP L 280mm rotation direction right LGB		
<b>spare parts for</b>	500468		
	<b>GEV No.</b>	510551	<b>Ref. No.</b> 0L0338
	pump cover gasket ID ø 158.3mm pump type 1214/1293/1225/2243/1226/1204/3473/1241 thickness 3.53mm EPDM Qty 1 pcs		
	<b>GEV No.</b>	510693	<b>Ref. No.</b> —
	mechanical shaft seal for shaft ø 12mm slide ring ext. ø 24mm slide ring H 15.5mm slide ring int. ø 11mm counter ring mounting ø 24mm height counter ring 8mm counter ring int. ø 13.5mm		
	<b>GEV No.</b>	521058	<b>Ref. No.</b> —
	fanwheel cover suitable for LGB ID ø 138mm ED ø 142mm H 59mm plastic		
	<b>GEV No.</b>	521097	<b>Ref. No.</b> —
	impellor ø 100mm H 31mm thread M8L shaft ø 20mm shaft length 14mm		
	<b>GEV No.</b>	521536	<b>Ref. No.</b> —
	pump cover ALBA / LGB inlet ø 62mm outlet ø 50mm auxiliary pressure connection 12mm supporting pressure closed turn direction right ø 180mm ID ø 150mm inner height 38mm		



OLYMPIA

pumps



1			
<b>GEV No.</b>	500003	<b>Ref. No.</b>	069540
<b>description</b>	pump inlet ø 45mm outlet ø 32mm type T30 230V 50Hz 1 phase 0.29kW 0.39HP L 190mm rotation direction right capacitor 8µF OLYMPIA		
<b>spare parts for</b>	500003		
	<b>GEV No.</b>	365013	<b>Ref. No.</b> 049126
	operating capacitor capacity 8µF 400V tolerance 5%Hz ambient temperature max. -25 to +85°C ø 31.5mm L 55mm M8 plastic connection male faston 6.3mm protection		
	<b>GEV No.</b>	510512	<b>Ref. No.</b> —
	pump cover OLYMPIA inlet ø 45mm outlet ø 31mm outlet 2 ø 24 turn direction right ø 130mm ID ø 124mm inner height 20mm		
	<b>GEV No.</b>	510554	<b>Ref. No.</b> —
	O-ring EPDM thickness 2mm ID ø 120mm Qty 1 pcs		
	<b>GEV No.</b>	510615	<b>Ref. No.</b> 069545
	impellor ø 90mm H 22mm rotation direction right thread M10L blades 4		
	<b>GEV No.</b>	510693	<b>Ref. No.</b> —
	mechanical shaft seal for shaft ø 12mm slide ring ext. ø 24mm slide ring H 15.5mm slide ring int. ø 11mm counter ring mounting ø 24mm height counter ring 8mm counter ring int. ø 13.5mm		

<b>spare parts for</b>	500395		
	<b>GEV No.</b>	698400	<b>Ref. No.</b> —
	pump cover gasket pump type PS46 thickness 2mm ID ø 66mm Qty 1 pcs		

drain pumps

ASKOLL



1			
<b>GEV No.</b>	499212	<b>Ref. No.</b>	0L0692
<b>description</b>	drain pump inlet ø 35mm outlet ø 30mm 220-240V 30W 50Hz ASKOLL type M 87 with thermal fuse		

HANNING



1			
<b>GEV No.</b>	502286	<b>Ref. No.</b>	0L0527 0L0693 0L2133 0L2657
<b>description</b>	drain pump 32W 200-400V inlet ø 35mm outlet ø 30mm 50/60Hz HANNING type DP025-275		

booster pumps I



1			
<b>GEV No.</b>	500395	<b>Ref. No.</b>	048910
<b>description</b>	pump inlet ø 3/8" IT outlet ø 3/8" IT type PS45DX 230V 50Hz 0.35kW capacitor 8µF LGB		
<b>spare parts for</b>	500395		
	<b>GEV No.</b>	365013	<b>Ref. No.</b> 049126
	operating capacitor capacity 8µF 400V tolerance 5%Hz ambient temperature max. -25 to +85°C ø 31.5mm L 55mm M8 plastic connection male faston 6.3mm protection		

PLASET



1			
<b>GEV No.</b>	500207	<b>Ref. No.</b>	046647
<b>description</b>	drain pump inlet ø 25mm outlet ø 22mm 230V 90W 50Hz PLASET type 8411		



1

<b>GEV No.</b>	500206	<b>Ref. No.</b>	047562
<b>description</b>	drain pump with auxiliary pressure connection inlet ø 25mm outlet ø 22mm 230V 90W 50Hz PLASET type 8411		

vibration pumps





1

<b>GEV No.</b>	500566	<b>Ref. No.</b>	0C2341
<b>description</b>	vibration pump 230V 32W 50Hz inlet ø 7 outlet ø 1/8" IT CEME type E512/A32		
<b>accessories for</b>	500566		
	<b>GEV No.</b>	510303	<b>Ref. No.</b> —
	O-ring EPDM thickness 1.78mm ID ø 6.75mm Qty 1 pcs		
	<b>GEV No.</b>	520512	<b>Ref. No.</b> —
	reducer WS 17 IT 1/4" ET 1/8" total length 28mm		
	<b>GEV No.</b>	542346	<b>Ref. No.</b> —
	hose connector thread 1/4" with O-ring hose ø 5mm stainless steel Qty 1 pcs		

pumps for ice machines



1

<b>GEV No.</b>	500165	<b>Ref. No.</b>	085322
<b>description</b>	pump REBO type 63/35 120W 230V 50/60Hz inlet ø 28mm outlet ø 26mm L 180mm rotation direction right for ice-cube maker capacitor 5µF		
<b>spare parts for</b>	500165		
	<b>GEV No.</b>	365017	<b>Ref. No.</b> —
	operating capacitor capacity 5µF 450V tolerance 5% 50/60Hz ambient temperature max. -25 to +85°C ø 28mm L 54mm M8 plastic connection male faston 6.3mm 16.10.08 protection		
	<b>GEV No.</b>	601412	<b>Ref. No.</b> —
	fan wheel sucking ø 154mm fan wheel mounting 25.4mm blade angle 28° W 34mm plastic		
	<b>GEV No.</b>	601413	<b>Ref. No.</b> —
	fixing plate suitable for fanwheel ED ø 32mm shaft ø 7 mounting distance 26mm		



1

<b>GEV No.</b>	500761	<b>Ref. No.</b>	086389
<b>description</b>	pump REBO type MH30F1 30W 230V 50Hz outlet ø 13mm L 135mm rotation direction right for ice maker		

condensators & interference suppression filters

starting capacitors



1

<b>GEV No.</b>	365095	<b>Ref. No.</b>	086359 0A8764
<b>description</b>	starting capacitor 43µF 330V 50/60Hz duty cycle 3 60A1D-330043NXET ø 36mm L 80mm M8 plastic connection cable 350mm 04P.5523CM		

operating capacitors

plastic



1

<b>GEV No.</b>	365021	<b>Ref. No.</b>	0A2914
<b>description</b>	operating capacitor capacity 16µF 425V tolerance 5% 50/60Hz ambient temperature max. -25 to +85°C ø 35mm L 73mm single M8 plastic connection male faston 6.3mm 416.10.99 protection		



1

<b>GEV No.</b>	365013	<b>Ref. No.</b>	049126
<b>description</b>	operating capacitor capacity 8µF 400V tolerance 5%Hz ambient temperature max. -25 to +85°C ø 31.5mm L 55mm M8 plastic connection male faston 6.3mm protection		



metal

			
1			
<b>GEV No.</b>	365139	<b>Ref. No.</b>	056148
<b>description</b>	operating capacitor capacity 10µF 450V tolerance 5% 60Hz ambient temperature max. -25 up to +70°C ø 40mm L 83mm M8 aluminium connection male faston 6.3mm C.87.8BF2 MKP protection		

			
1			
<b>GEV No.</b>	365140	<b>Ref. No.</b>	047541
<b>description</b>	operating capacitor capacity 12.5µF 450V tolerance 5% 60Hz ambient temperature max. -25 up to +70°C ø 40mm L 83mm M8 aluminium connection male faston 6.3mm C.87.8BF2 MKP protection		

filters

interference suppression filters

			
1			
<b>GEV No.</b>	365046	<b>Ref. No.</b>	046217
<b>description</b>	interference suppression filter type 10S7E-G1474253105-Q 115/250V 50/60Hz conductor 2 with E connection male faston 6.3mm L 40mm ø 40mm Hmm Wmm M8 plastic Qty 1 pcs		

			
1			
<b>GEV No.</b>	365050	<b>Ref. No.</b>	049303
<b>description</b>	interference suppression filter type 411.13.5901D 250V 50Hz conductor 4 plug connection male faston 6.3mm L 50mm ø 38mm Hmm Wmm plug plastic Qty 1 pcs		

fuses

fine fuses

			
1			
<b>GEV No.</b>	358610	<b>Ref. No.</b>	058869
<b>description</b>	fine fuse size ø5x20mm 10A fast-acting rated 250V Qty 10 pcs		

			
1			
<b>GEV No.</b>	358611	<b>Ref. No.</b>	005136
<b>description</b>	fine fuse size ø5x20mm 16A fast-acting rated 250V Qty 10 pcs		

			
1			
<b>GEV No.</b>	358677	<b>Ref. No.</b>	057783
<b>description</b>	fine fuse size ø5x20mm 4A fast-acting rated 250V Qty 10 pcs		

			
1			
<b>GEV No.</b>	358594	<b>Ref. No.</b>	002820
<b>description</b>	fine fuse size ø5x20mm 0.16A slow-acting rated 250V Qty 10 pcs		

			
1			
<b>GEV No.</b>	358596	<b>Ref. No.</b>	002920
<b>description</b>	fine fuse size ø5x20mm 0.25A slow-acting rated 250V Qty 10 pcs		

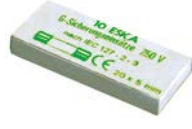
			
1			
<b>GEV No.</b>	358703	<b>Ref. No.</b>	002750
<b>description</b>	fine fuse size ø5x20mm 0.4A slow-acting rated 250V Qty 10 pcs		

fine fuse holders

			
1			
<b>GEV No.</b>	358396	<b>Ref. No.</b>	056582
<b>description</b>	fuse holder suitable fuse ø5x20mm ø 15mm mounting ø 12.5mm 16A rated 250V L 46mm connection male faston 4.8mm		

overload switches

			
1			
<b>GEV No.</b>	358523	<b>Ref. No.</b>	0H6104
<b>description</b>	overload switch drop-away current 0.6A		



## electric accessories

## cables

## cable harnesses



<b>GEV No.</b>	401849	<b>Ref. No.</b>	002763
<b>description</b>	connecting cable		

## terminals and connectors

## not insulated

## bullet connectors



<b>GEV No.</b>	550334	<b>Ref. No.</b>	0H7029
<b>description</b>	plug connector size 3.5mm 0.25-1.5mm <sup>2</sup> Cu gal Sn t.max. 125°C Qty 1 pcs		

## plug connectors



<b>GEV No.</b>	550328	<b>Ref. No.</b>	0H7030
<b>description</b>	female bullet ø 3.5mm		



<b>GEV No.</b>	550330	<b>Ref. No.</b>	0H7027
<b>description</b>	plug connector 12-pole		



<b>GEV No.</b>	550333	<b>Ref. No.</b>	0H7028
<b>description</b>	plug connector 12-pole		



<b>GEV No.</b>	550334	<b>Ref. No.</b>	0H7029
<b>description</b>	plug connector size 3.5mm 0.25-1.5mm <sup>2</sup> Cu gal Sn t.max. 125°C Qty 1 pcs		

## terminals

## connection terminals with screw/faston connections



<b>GEV No.</b>	550278	<b>Ref. No.</b>	046357
<b>description</b>	power terminal block 3-pole max. 40A max 400V connection ø6mm <sup>2</sup> / F6.3 temp.-resist. 150°C cross section 6mm <sup>2</sup>		



<b>GEV No.</b>	550411	<b>Ref. No.</b>	046347
<b>description</b>	power terminal block 6-pole max. 40A max 450V connection ø6mm <sup>2</sup> / F6.3 temp.-resist. 150°C cross section 6mm <sup>2</sup>		

## rail-mounted terminals

## rail-mounted terminal blocks



<b>GEV No.</b>	550598	<b>Ref. No.</b>	058875
<b>description</b>	rail-mounted terminal block 5-pole contacts 3P+N+E cross section 1.0-10mm <sup>2</sup>		



<b>GEV No.</b>	550599	<b>Ref. No.</b>	059239
<b>description</b>	rail-mounted terminal block 5-pole contacts 3P+N+E cross section 1.0-10mm <sup>2</sup>		

## electronic components

## resistors



<b>GEV No.</b>	359929	<b>Ref. No.</b>	058872
<b>description</b>	resistor 100Ohm		









gas taps

PEL

20N series



1

<b>GEV No.</b>	101398	<b>Ref. No.</b>	054166
<b>description</b>	gas tap PEL type 20N gas inlet M16x1.5 (tube ø 10mm) bypass nozzle ø 0.35mm gas outlet M16x1.5 (tube ø 10/8mm) thermocouple connection pilot connection M10x1 shaft ø 8x6.5mm shaft L 22/15mm shaft flat upper		
<b>spare parts for</b>	101398		
	GEV No. 100408	Ref. No.	—
	bypass nozzle type PEL20/21 bore ø 0.35mm thread M5x0.5		
	GEV No. 101205	Ref. No.	—
	gas tap front part shaft ø 8x6.5mm shaft L 22/15mm shaft flat upper/lower suitable for PEL20		
<b>accessories for</b>	101398		
	GEV No. 101278	Ref. No.	060325
	olive for pipe ø 10mm Qty 1 pcs		
	GEV No. 101300	Ref. No.	—
	union nut thread M16x1.5 tube ø 10mm		
	GEV No. 101450	Ref. No.	—
	olive for pipe ø 8mm L 12.7mm Qty 1 pcs ED ø 10mm		
	GEV No. 101451	Ref. No.	—
	union nut thread M16x1.5 tube ø 8mm		
	GEV No. 110081	Ref. No.	—
	knob ø 70mm shaft ø 8x6.5mm shaft flat universal		
	GEV No. 110083	Ref. No.	—
	knob dial plate gas tap without ignition flame silver		

20S series



1

<b>GEV No.</b>	101094	<b>Ref. No.</b>	054109
<b>description</b>	gas tap PEL type 20S gas inlet M16x1.5 (tube ø 10mm) bypass nozzle ø 0.35mm gas outlet M16x1.5 (tube ø 10/8mm) thermocouple connection M8x1 pilot connection shaft ø 8x6.5mm shaft L 22/15mm shaft flat lower		
<b>spare parts for</b>	101094		
	GEV No. 100408	Ref. No.	—
	bypass nozzle type PEL20/21 bore ø 0.35mm thread M5x0.5		



<b>spare parts for</b>	101094		
	GEV No. 101060	Ref. No.	056595
	magnet unit standard L 39mm D1 ø 15.4mm D2 ø 11mm suitable for PEL20-21/JUNKERS/EGA		
	GEV No. 101205	Ref. No.	—
	gas tap front part shaft ø 8x6.5mm shaft L 22/15mm shaft flat upper/lower suitable for PEL20		
	GEV No. 101230	Ref. No.	—
	thermocouple nut T1: M8x1 T2: M18x1 aluminium		
<b>accessories for</b>	101094		
	GEV No. 101278	Ref. No.	060325
	olive for pipe ø 10mm Qty 1 pcs		
	GEV No. 101300	Ref. No.	—
	union nut thread M16x1.5 tube ø 10mm		
	GEV No. 101450	Ref. No.	—
	olive for pipe ø 8mm L 12.7mm Qty 1 pcs ED ø 10mm		
	GEV No. 101451	Ref. No.	—
	union nut thread M16x1.5 tube ø 8mm		
	GEV No. 110081	Ref. No.	—
	knob ø 70mm shaft ø 8x6.5mm shaft flat universal		
	GEV No. 110083	Ref. No.	—
	knob dial plate gas tap without ignition flame silver		



1



<b>GEV No.</b>	101958	<b>Ref. No.</b>	004237
<b>description</b>	gas tap PEL type 20S gas inlet M16x1.5 (tube ø 10mm) bypass nozzle ø 0.35mm gas outlet M16x1.5 (tube ø 10/8mm) thermocouple connection M8x1 pilot connection shaft ø 8x6.5mm shaft L 40/15mm shaft flat upper without ignition flame connection		
<b>spare parts for</b>	101958		
	GEV No. 101060	Ref. No.	056595
	magnet unit standard L 39mm D1 ø 15.4mm D2 ø 11mm suitable for PEL20-21/JUNKERS/EGA		
	GEV No. 101230	Ref. No.	—
	thermocouple nut T1: M8x1 T2: M18x1 aluminium		
	GEV No. 101876	Ref. No.	—
	gas tap front part shaft ø 8x6.5mm shaft L 39/15mm shaft flat right/left suitable for PEL20		
<b>accessories for</b>	101958		
	GEV No. 101278	Ref. No.	060325
	olive for pipe ø 10mm Qty 1 pcs		
	GEV No. 101300	Ref. No.	—
	union nut thread M16x1.5 tube ø 10mm		
	GEV No. 101450	Ref. No.	—
	olive for pipe ø 8mm L 12.7mm Qty 1 pcs ED ø 10mm		

Table continues overleaf

<b>accessories for</b> 101958				
	GEV No.	101451	Ref. No.	—
union nut thread M16x1.5 tube ø 8mm				
	GEV No.	110081	Ref. No.	—
knob ø 70mm shaft ø 8x6.5mm shaft flat universal				
	GEV No.	110083	Ref. No.	—
knob dial plate gas tap without ignition flame silver				

21S series

				
1				
<b>GEV No.</b>	101095	<b>Ref. No.</b>	059460	
<b>description</b>	gas tap PEL type 21S gas inlet M16x1.5 (tube ø 10mm) bypass nozzle ø 0.35mm gas outlet M16x1.5 (tube ø 10/8mm) thermocouple connection M8x1 pilot connection M10x1 shaft ø 8x6.5mm shaft L 22/15mm shaft flat lower			
<b>spare parts for</b>	101095			
	GEV No.	100408	Ref. No.	—
bypass nozzle type PEL20/21 bore ø 0.35mm thread M5x0.5				
	GEV No.	101060	Ref. No.	056595
magnet unit standard L 39mm D1 ø 15.4mm D2 ø 11mm suitable for PEL20-21/JUNKERS/EGA				
	GEV No.	101206	Ref. No.	—
gas tap front part shaft ø 8x6.5mm shaft L 22/15mm shaft flat upper/lower suitable for PEL21				
	GEV No.	101230	Ref. No.	—
thermocouple nut T1: M8x1 T2: M18x1 aluminium				
<b>accessories for</b>	101095			
	GEV No.	100908	Ref. No.	052125
union screw thread M10x1 for pipe ø 4mm Qty 1 pcs				
	GEV No.	100909	Ref. No.	—
union screw thread M10x1 for pipe ø 6mm Qty 1 pcs				
	GEV No.	101246	Ref. No.	052127
olive for pipe ø 4mm Qty 1 pcs				
	GEV No.	101278	Ref. No.	060325
olive for pipe ø 10mm Qty 1 pcs				
	GEV No.	101286	Ref. No.	—
olive ID ø 6mm Qty 1 pcs				
	GEV No.	101300	Ref. No.	—
union nut thread M16x1.5 tube ø 10mm				
	GEV No.	101450	Ref. No.	—
olive for pipe ø 8mm L 12.7mm Qty 1 pcs ED ø 10mm				
	GEV No.	101451	Ref. No.	—
union nut thread M16x1.5 tube ø 8mm				

<b>accessories for</b> 101095				
	GEV No.	110081	Ref. No.	—
knob ø 70mm shaft ø 8x6.5mm shaft flat universal				
	GEV No.	112206	Ref. No.	—
knob dial plate silver gas tap PEL21/22/23 t.max.°C ED ø 63mm ID ø 45.5mm				



				
1				
<b>GEV No.</b>	101397	<b>Ref. No.</b>	004961	
<b>description</b>	gas tap PEL type 21S gas inlet M16x1.5 (tube ø 10mm) bypass nozzle ø 0.35mm gas outlet M16x1.5 (tube ø 10/8mm) thermocouple connection M9x1 pilot connection M10x1 shaft ø 8x6.5mm shaft L 22/15mm shaft flat lower			
<b>spare parts for</b>	101397			
	GEV No.	100408	Ref. No.	—
bypass nozzle type PEL20/21 bore ø 0.35mm thread M5x0.5				
	GEV No.	101060	Ref. No.	056595
magnet unit standard L 39mm D1 ø 15.4mm D2 ø 11mm suitable for PEL20-21/JUNKERS/EGA				
	GEV No.	101206	Ref. No.	—
gas tap front part shaft ø 8x6.5mm shaft L 22/15mm shaft flat upper/lower suitable for PEL21				
	GEV No.	101231	Ref. No.	—
thermocouple nut T1: M9x1 T2: M18x1				
<b>accessories for</b>	101397			
	GEV No.	100908	Ref. No.	052125
union screw thread M10x1 for pipe ø 4mm Qty 1 pcs				
	GEV No.	100909	Ref. No.	—
union screw thread M10x1 for pipe ø 6mm Qty 1 pcs				
	GEV No.	101246	Ref. No.	052127
olive for pipe ø 4mm Qty 1 pcs				
	GEV No.	101278	Ref. No.	060325
olive for pipe ø 10mm Qty 1 pcs				
	GEV No.	101286	Ref. No.	—
olive ID ø 6mm Qty 1 pcs				
	GEV No.	101300	Ref. No.	—
union nut thread M16x1.5 tube ø 10mm				
	GEV No.	101450	Ref. No.	—
olive for pipe ø 8mm L 12.7mm Qty 1 pcs ED ø 10mm				
	GEV No.	101451	Ref. No.	—
union nut thread M16x1.5 tube ø 8mm				
	GEV No.	110081	Ref. No.	—
knob ø 70mm shaft ø 8x6.5mm shaft flat universal				

Table continues overleaf







<b>accessories for</b>	101397			
	GEV No.	112206	Ref. No.	—
	knob dial plate silver gas tap PEL21/22/23 t.max.°C ED ø 63mm ID ø 45.5mm			



<b>GEV No.</b>	101897	<b>Ref. No.</b>	0C0205	
----------------	--------	-----------------	--------	--

<b>description</b>	gas tap PEL type 21S gas inlet pipe flange ø21mm bypass nozzle ø 0.35mm gas outlet M16x1.5 (tube ø 10/8mm) thermocouple connection M8x1 pilot connection M10x1 shaft ø 8x6.5mm shaft L 32/25mm shaft flat upper			
--------------------	---	--	--	--

<b>spare parts for</b>	101897			
------------------------	--------	--	--	--

	GEV No.	101060	Ref. No.	056595
	magnet unit standard L 39mm D1 ø 15.4mm D2 ø 11mm suitable for PEL20-21/JUNKERS/EGA			
	GEV No.	101230	Ref. No.	—
	thermocouple nut T1: M8x1 T2: M18x1 aluminium			
	GEV No.	101875	Ref. No.	—
	gas tap front part shaft ø 8x6.5mm shaft L 32/25mm shaft flat upper/lower type PEL21			
	GEV No.	528347	Ref. No.	—
	O-ring Viton thickness 1.78mm ID ø 2.9mm Qty 1 pcs			

<b>accessories for</b>	101897			
------------------------	--------	--	--	--

	GEV No.	100908	Ref. No.	052125
	union screw thread M10x1 for pipe ø 4mm Qty 1 pcs			
	GEV No.	100909	Ref. No.	—
	union screw thread M10x1 for pipe ø 6mm Qty 1 pcs			
	GEV No.	101246	Ref. No.	052127
	olive for pipe ø 4mm Qty 1 pcs			
	GEV No.	101278	Ref. No.	060325
	olive for pipe ø 10mm Qty 1 pcs			
	GEV No.	101286	Ref. No.	—
	olive ID ø 6mm Qty 1 pcs			
	GEV No.	101300	Ref. No.	—
	union nut thread M16x1.5 tube ø 10mm			
	GEV No.	110081	Ref. No.	—
	knob ø 70mm shaft ø 8x6.5mm shaft flat universal			
	GEV No.	112206	Ref. No.	—
	knob dial plate silver gas tap PEL21/22/23 t.max.°C ED ø 63mm ID ø 45.5mm			





22N/V series



<b>GEV No.</b>	101690	<b>Ref. No.</b>	052145	
----------------	--------	-----------------	--------	--

<b>description</b>	gas tap PEL type 22N/V gas inlet M20x1.5 (tube ø 12mm) bypass nozzle ø 0.35mm gas outlet M20x1.5 (tube ø 12/10mm) thermocouple connection pilot connection M10x1 shaft ø 10x8mm shaft L 25/17mm shaft flat lower			
--------------------	--	--	--	--



<b>spare parts for</b>	101690			
------------------------	--------	--	--	--

	GEV No.	100259	Ref. No.	—
	bypass nozzle type PEL22 bore ø 0.35mm thread M6x0.5			
	GEV No.	101201	Ref. No.	—
	gas tap front part shaft ø 10x8mm shaft L 25/17mm shaft flat upper/lower suitable for PEL22			
	GEV No.	101241	Ref. No.	—
	gas connection thread M20x1.5 tube ø 12/10mm for PEL gas taps vertical			
	GEV No.	101460	Ref. No.	—
	O-ring ø 12.37mm D1 ø 2.62mm suitable for PEL22			
	GEV No.	101461	Ref. No.	—
	screw kit suitable for PEL22 Qty 4 pcs			

<b>accessories for</b>	101690			
------------------------	--------	--	--	--

	GEV No.	100908	Ref. No.	052125
	union screw thread M10x1 for pipe ø 4mm Qty 1 pcs			
	GEV No.	100909	Ref. No.	—
	union screw thread M10x1 for pipe ø 6mm Qty 1 pcs			
	GEV No.	101240	Ref. No.	—
	gas connection thread M20x1.5 tube ø 12/10mm for PEL gas taps with gasket and screws horizontal			
	GEV No.	101246	Ref. No.	052127
	olive for pipe ø 4mm Qty 1 pcs			
	GEV No.	101248	Ref. No.	050682
	olive for pipe ø 12mm Qty 1 pcs suitable for PEL			
	GEV No.	101249	Ref. No.	—
	olive for pipe ø 10mm Qty 1 pcs			
	GEV No.	101250	Ref. No.	—
	union nut thread M20x1.5 for pipe ø 10mm			
	GEV No.	101251	Ref. No.	—
	union nut thread M20x1.5 for pipe ø 12mm			
	GEV No.	101286	Ref. No.	—
	olive ID ø 6mm Qty 1 pcs			

Table continues overleaf







<b>accessories for</b>	101690			
	GEV No.	110080	Ref. No.	—
	knob ø 70mm shaft ø 10x8mm shaft flat universal			
	GEV No.	112206	Ref. No.	—
	knob dial plate silver gas tap PEL21/22/23 t.max.°C ED ø 63mm ID ø 45.5mm			





22S/O series



<b>GEV No.</b>	101086	<b>Ref. No.</b>	050595	
<b>description</b>	gas tap PEL type 22S/O gas inlet M20x1.5 (tube ø 12mm) bypass nozzle ø 0.35mm gas outlet M20x1.5 (tube ø 12/10mm) thermocouple connection M9x1 pilot connection M10x1 shaft ø 10x8mm shaft L 25/17mm shaft flat lower			

<b>spare parts for</b>	101086			
	GEV No.	100259	Ref. No.	—
	bypass nozzle type PEL22 bore ø 0.35mm thread M6x0.5			
	GEV No.	101058	Ref. No.	056594
	magnet unit L 39mm D1 ø 15.4mm D2 ø 13.5mm suitable for PEL22/EGA24197 standard			
	GEV No.	101201	Ref. No.	—
	gas tap front part shaft ø 10x8mm shaft L 25/17mm shaft flat upper/lower suitable for PEL22			
	GEV No.	101231	Ref. No.	—
	thermocouple nut T1: M9x1 T2: M18x1			
	GEV No.	101240	Ref. No.	—
	gas connection thread M20x1.5 tube ø 12/10mm for PEL gas taps with gasket and screws horizontal			
	GEV No.	101460	Ref. No.	—
	O-ring ø 12.37mm D1 ø 2.62mm suitable for PEL22			
	GEV No.	101461	Ref. No.	—
	screw kit suitable for PEL22 Qty 4 pcs			

<b>accessories for</b>	101086			
	GEV No.	100908	Ref. No.	052125
	union screw thread M10x1 for pipe ø 4mm Qty 1 pcs			
	GEV No.	100909	Ref. No.	—
	union screw thread M10x1 for pipe ø 6mm Qty 1 pcs			
	GEV No.	101241	Ref. No.	—
	gas connection thread M20x1.5 tube ø 12/10mm for PEL gas taps vertical			
	GEV No.	101246	Ref. No.	052127
	olive for pipe ø 4mm Qty 1 pcs			
	GEV No.	101248	Ref. No.	050682
	olive for pipe ø 12mm Qty 1 pcs suitable for PEL			
	GEV No.	101249	Ref. No.	—
	olive for pipe ø 10mm Qty 1 pcs			

<b>accessories for</b>	101086			
	GEV No.	101250	Ref. No.	—
	union nut thread M20x1.5 for pipe ø 10mm			
	GEV No.	101251	Ref. No.	—
	union nut thread M20x1.5 for pipe ø 12mm			
	GEV No.	101286	Ref. No.	—
	olive ID ø 6mm Qty 1 pcs			
	GEV No.	110080	Ref. No.	—
	knob ø 70mm shaft ø 10x8mm shaft flat universal			
	GEV No.	112206	Ref. No.	—
	knob dial plate silver gas tap PEL21/22/23 t.max.°C ED ø 63mm ID ø 45.5mm			

22S/V series



<b>GEV No.</b>	101457	<b>Ref. No.</b>	050704	
<b>description</b>	gas tap alternatives to JUNKERS type CH110 gas inlet M20x1.5 (tube ø 12mm) bypass nozzle ø 0.35mm gas outlet M20x1.5 (tube ø 12/10mm) thermocouple connection M8x1 pilot connection M10x1 shaft ø 10mm shaft L 25mm shaft flat with pipe outlet			

<b>spare parts for</b>	101457			
	GEV No.	100259	Ref. No.	—
	bypass nozzle type PEL22 bore ø 0.35mm thread M6x0.5			
	GEV No.	100908	Ref. No.	052125
	union screw thread M10x1 for pipe ø 4mm Qty 1 pcs			
	GEV No.	101058	Ref. No.	056594
	magnet unit L 39mm D1 ø 15.4mm D2 ø 13.5mm suitable for PEL22/EGA24197 standard			
	GEV No.	101200	Ref. No.	—
	gas tap front part shaft ø 10mm shaft L 25mm shaft flat suitable for 22S/O			
	GEV No.	101230	Ref. No.	—
	thermocouple nut T1: M8x1 T2: M18x1 aluminium			
	GEV No.	101241	Ref. No.	—
	gas connection thread M20x1.5 tube ø 12/10mm for PEL gas taps vertical			
	GEV No.	101246	Ref. No.	052127
	olive for pipe ø 4mm Qty 1 pcs			
	GEV No.	101460	Ref. No.	—
	O-ring ø 12.37mm D1 ø 2.62mm suitable for PEL22			
	GEV No.	101461	Ref. No.	—
	screw kit suitable for PEL22 Qty 4 pcs			

Table continues overleaf



accessories for		101457	
	GEV No.	100945	Ref. No. —
	roll pin ø 3.2mm L 10mm		
	GEV No.	101218	Ref. No. —
	shaft extension JUNKERS		
	GEV No.	101219	Ref. No. —
	shaft extension L 25mm JUNKERS		
	GEV No.	101231	Ref. No. —
	thermocouple nut T1: M9x1 T2: M18x1		
	GEV No.	101248	Ref. No. 050682
	olive for pipe ø 12mm Qty 1 pcs suitable for PEL		
	GEV No.	101249	Ref. No. —
	olive for pipe ø 10mm Qty 1 pcs		
	GEV No.	101250	Ref. No. —
	union nut thread M20x1.5 for pipe ø 10mm		
	GEV No.	101251	Ref. No. —
	union nut thread M20x1.5 for pipe ø 12mm		
	GEV No.	101290	Ref. No. —
	thermocouple nut T1: M10x1 T2: M18x1 suitable for PEL20/21		
	GEV No.	110064	Ref. No. —
	knob		
	GEV No.	110066	Ref. No. —
	knob screw		
	GEV No.	550396	Ref. No. —
	shaft extension L 25mm JUNKERS		

1			
<b>GEV No.</b>	101087	<b>Ref. No.</b>	053192
<b>description</b>	gas tap PEL type 22S/V gas inlet M20x1.5 (tube ø 12mm) bypass nozzle ø 0.35mm gas outlet M20x1.5 (tube ø 12/10mm) thermocouple connection M9x1 pilot connection M10x1 shaft ø 10x8mm shaft L 25/17mm shaft flat upper		
<b>spare parts for</b>	101087		
	GEV No.	100259	Ref. No. —
	bypass nozzle type PEL22 bore ø 0.35mm thread M6x0.5		
	GEV No.	101058	Ref. No. 056594
	magnet unit L 39mm D1 ø 15.4mm D2 ø 13.5mm suitable for PEL22/EGA24197 standard		
	GEV No.	101201	Ref. No. —
	gas tap front part shaft ø 10x8mm shaft L 25/17mm shaft flat upper/lower suitable for PEL22		
	GEV No.	101231	Ref. No. —
	thermocouple nut T1: M9x1 T2: M18x1		

spare parts for		101087	
	GEV No.	101241	Ref. No. —
	gas connection thread M20x1.5 tube ø 12/10mm for PEL gas taps vertical		
	GEV No.	101460	Ref. No. —
	O-ring ø 12.37mm D1 ø 2.62mm suitable for PEL22		
	GEV No.	101461	Ref. No. —
	screw kit suitable for PEL22 Qty 4 pcs		
<b>accessories for</b>	101087		
	GEV No.	100908	Ref. No. 052125
	union screw thread M10x1 for pipe ø 4mm Qty 1 pcs		
	GEV No.	100909	Ref. No. —
	union screw thread M10x1 for pipe ø 6mm Qty 1 pcs		
	GEV No.	101240	Ref. No. —
	gas connection thread M20x1.5 tube ø 12/10mm for PEL gas taps with gasket and screws horizontal		
	GEV No.	101246	Ref. No. 052127
	olive for pipe ø 4mm Qty 1 pcs		
	GEV No.	101248	Ref. No. 050682
	olive for pipe ø 12mm Qty 1 pcs suitable for PEL		
	GEV No.	101249	Ref. No. —
	olive for pipe ø 10mm Qty 1 pcs		
	GEV No.	101250	Ref. No. —
	union nut thread M20x1.5 for pipe ø 10mm		
	GEV No.	101251	Ref. No. —
	union nut thread M20x1.5 for pipe ø 12mm		
	GEV No.	101286	Ref. No. —
	olive ID ø 6mm Qty 1 pcs		
	GEV No.	110080	Ref. No. —
	knob ø 70mm shaft ø 10x8mm shaft flat universal		
	GEV No.	112206	Ref. No. —
	knob dial plate silver gas tap PEL21/22/23 t.max.°C ED ø 63mm ID ø 45.5mm		

1			
<b>GEV No.</b>	101981	<b>Ref. No.</b>	0C0489
<b>description</b>	gas tap PEL type 22S/V gas inlet M20x1.5 (tube ø 12mm) bypass nozzle ø 0mm gas outlet M20x1.5 (tube ø 12/10mm) thermocouple connection M9x1 pilot connection M10x1 shaft ø 10x8mm shaft L 34/26mm shaft flat upper		
<b>spare parts for</b>	101981		
	GEV No.	101058	Ref. No. 056594
	magnet unit L 39mm D1 ø 15.4mm D2 ø 13.5mm suitable for PEL22/EGA24197 standard		

Table continues overleaf



spare parts for		101981	
	GEV No.	101231	Ref. No. —
	thermocouple nut T1: M9x1 T2: M18x1		
	GEV No.	101241	Ref. No. —
	gas connection thread M20x1.5 tube ø 12/10mm for PEL gas taps vertical		
	GEV No.	101449	Ref. No. —
	gas tap front part shaft ø 8x10mm shaft L 35/17mm shaft flat upper/lower suitable for PEL22		
	GEV No.	101460	Ref. No. —
	O-ring ø 12.37mm D1 ø 2.62mm suitable for PEL22		
	GEV No.	101461	Ref. No. —
	screw kit suitable for PEL22 Qty 4 pcs		
	GEV No.	101873	Ref. No. —
	gas tap front part shaft ø 10x8mm shaft L 34/26mm shaft flat upper/lower suitable for PEL22		
accessories for		101981	
	GEV No.	100908	Ref. No. 052125
	union screw thread M10x1 for pipe ø 4mm Qty 1 pcs		
	GEV No.	100909	Ref. No. —
	union screw thread M10x1 for pipe ø 6mm Qty 1 pcs		
	GEV No.	101246	Ref. No. 052127
	olive for pipe ø 4mm Qty 1 pcs		
	GEV No.	101248	Ref. No. 050682
	olive for pipe ø 12mm Qty 1 pcs suitable for PEL		
	GEV No.	101249	Ref. No. —
	olive for pipe ø 10mm Qty 1 pcs		
	GEV No.	101250	Ref. No. —
	union nut thread M20x1.5 for pipe ø 10mm		
	GEV No.	101251	Ref. No. —
	union nut thread M20x1.5 for pipe ø 12mm		
	GEV No.	101286	Ref. No. —
	olive ID ø 6mm Qty 1 pcs		
	GEV No.	110080	Ref. No. —
	knob ø 70mm shaft ø 10x8mm shaft flat universal		
	GEV No.	112206	Ref. No. —
	knob dial plate silver gas tap PEL21/22/23 t.max.°C ED ø 63mm ID ø 45.5mm		



## 23S/O series



1	GEV No.	101092	Ref. No.	0A2146
<b>description</b>	gas tap PEL type 23S/O gas inlet M28x1.5 (tube ø 20mm) bypass nozzle ø 0.35mm gas outlet M24x1.5 (tube ø 16mm) thermocouple connection M10x1 pilot connection M10x1 shaft ø 10x8mm shaft L 25/17mm shaft flat upper			
spare parts for		101092		
	GEV No.	100455	Ref. No. —	
	bypass nozzle type PEL23/24 bore ø 0.35mm thread M8x0.5			
	GEV No.	101059	Ref. No. —	
	magnet unit T1: M10x1 T2: M22x1 L 46mm ø 18mm suitable for PEL23S M10x1			
	GEV No.	101204	Ref. No. —	
	gas tap front part shaft ø 10x8mm shaft L 25/17mm shaft flat upper/lower suitable for PEL23S			
	GEV No.	101244	Ref. No. —	
	gas connection thread M24x1.5 tube ø 12/16mm horizontal for PEL gas taps			
	GEV No.	101463	Ref. No. —	
	screw suitable for PEL23S Qty 4 pcs			
	GEV No.	528455	Ref. No. —	
	O-ring Viton thickness 2.62mm ID ø 18.72mm Qty 1 pcs			
accessories for		101092		
	GEV No.	100908	Ref. No. 052125	
	union screw thread M10x1 for pipe ø 4mm Qty 1 pcs			
	GEV No.	100909	Ref. No. —	
	union screw thread M10x1 for pipe ø 6mm Qty 1 pcs			
	GEV No.	101246	Ref. No. 052127	
	olive for pipe ø 4mm Qty 1 pcs			
	GEV No.	101252	Ref. No. —	
	union nut thread M24x1.5 for pipe ø 12mm			
	GEV No.	101253	Ref. No. —	
	union nut thread M24x1.5 PEL for pipe ø 16mm			
	GEV No.	101254	Ref. No. —	
	union nut thread M28x1.5 tube ø 20mm			
	GEV No.	101255	Ref. No. —	
	olive for pipe ø 12mm Qty 1 pcs			
	GEV No.	101256	Ref. No. 054817	
	olive for pipe ø 16mm Qty 1 pcs			
	GEV No.	101257	Ref. No. —	
	olive for pipe ø 20mm Qty 1 pcs			

Table continues overleaf



accessories for		101092		
GEV No.	Ref. No.	GEV No.	Ref. No.	—
	101286	101286	Ref. No.	—
olive ID ø 6mm Qty 1 pcs				
	110080	110080	Ref. No.	—
knob ø 70mm shaft ø 10x8mm shaft flat universal				
	112206	112206	Ref. No.	—
knob dial plate silver gas tap PEL21/22/23 t.max.°C ED ø 63mm ID ø 45.5mm				



1

GEV No.	Ref. No.	GEV No.	Ref. No.	054811
101091	054811	101091	Ref. No.	054811

**description** gas tap PEL type 23S/O gas inlet M28x1.5 (tube ø 20mm) bypass nozzle ø 0.35mm gas outlet M24x1.5 (tube ø 16mm) thermocouple connection M9x1 pilot connection M10x1 shaft ø 10x8mm shaft L 35/19mm shaft flat upper

**spare parts for** 101091

GEV No.	Ref. No.	GEV No.	Ref. No.	—
	100455	100455	Ref. No.	—

bypass nozzle type PEL23/24 bore ø 0.35mm thread M8x0.5

GEV No.	Ref. No.	GEV No.	Ref. No.	056596
	101045	101045	Ref. No.	056596

magnet unit T1: M9x1 T2: M22x1 L 46mm ø 18mm suitable for PEL23S M9x1

GEV No.	Ref. No.	GEV No.	Ref. No.	—
	101244	101244	Ref. No.	—

gas connection thread M24x1.5 tube ø 12/16mm horizontal for PEL gas taps

GEV No.	Ref. No.	GEV No.	Ref. No.	—
	101336	101336	Ref. No.	—

gas tap front part shaft ø 10x8mm shaft L 35/17mm shaft flat upper/lower suitable for PEL23S

GEV No.	Ref. No.	GEV No.	Ref. No.	—
	101463	101463	Ref. No.	—

screw suitable for PEL23S Qty 4 pcs

GEV No.	Ref. No.	GEV No.	Ref. No.	—
	528455	528455	Ref. No.	—

O-ring Viton thickness 2.62mm ID ø 18.72mm Qty 1 pcs

**accessories for** 101091

GEV No.	Ref. No.	GEV No.	Ref. No.	052125
	100908	100908	Ref. No.	052125

union screw thread M10x1 for pipe ø 4mm Qty 1 pcs

GEV No.	Ref. No.	GEV No.	Ref. No.	—
	100909	100909	Ref. No.	—

union screw thread M10x1 for pipe ø 6mm Qty 1 pcs

GEV No.	Ref. No.	GEV No.	Ref. No.	052127
	101246	101246	Ref. No.	052127

olive for pipe ø 4mm Qty 1 pcs

GEV No.	Ref. No.	GEV No.	Ref. No.	—
	101252	101252	Ref. No.	—







union nut thread M24x1.5 for pipe ø 12mm

GEV No.	Ref. No.	GEV No.	Ref. No.	—
	101253	101253	Ref. No.	—

union nut thread M24x1.5 PEL for pipe ø 16mm

GEV No.	Ref. No.	GEV No.	Ref. No.	—
	101254	101254	Ref. No.	—

union nut thread M28x1.5 tube ø 20mm

accessories for		101091		
GEV No.	Ref. No.	GEV No.	Ref. No.	—
	101255	101255	Ref. No.	—
olive for pipe ø 12mm Qty 1 pcs				
	101256	101256	Ref. No.	054817
olive for pipe ø 16mm Qty 1 pcs				
	101257	101257	Ref. No.	—
olive for pipe ø 20mm Qty 1 pcs				
	101286	101286	Ref. No.	—
olive ID ø 6mm Qty 1 pcs				
	110080	110080	Ref. No.	—
knob ø 70mm shaft ø 10x8mm shaft flat universal				
	112206	112206	Ref. No.	—
knob dial plate silver gas tap PEL21/22/23 t.max.°C ED ø 63mm ID ø 45.5mm				

alternatives to JUNKERS



1

GEV No.	Ref. No.	GEV No.	Ref. No.	050704
101457	050704	101457	Ref. No.	050704

**description** gas tap alternatives to JUNKERS type CH110 gas inlet M20x1.5 (tube ø 12mm) bypass nozzle ø 0.35mm gas outlet M20x1.5 (tube ø 12/10mm) thermocouple connection M8x1 pilot connection M10x1 shaft ø 10mm shaft L 25mm shaft flat with pipe outlet

**spare parts for** 101457

GEV No.	Ref. No.	GEV No.	Ref. No.	—
	100259	100259	Ref. No.	—

bypass nozzle type PEL22 bore ø 0.35mm thread M6x0.5

GEV No.	Ref. No.	GEV No.	Ref. No.	052125
	100908	100908	Ref. No.	052125

union screw thread M10x1 for pipe ø 4mm Qty 1 pcs

GEV No.	Ref. No.	GEV No.	Ref. No.	056594
	101058	101058	Ref. No.	056594

magnet unit L 39mm D1 ø 15.4mm D2 ø 13.5mm suitable for PEL22/EGA24197 standard

GEV No.	Ref. No.	GEV No.	Ref. No.	—
	101200	101200	Ref. No.	—

gas tap front part shaft ø 10mm shaft L 25mm shaft flat suitable for 22S/O

GEV No.	Ref. No.	GEV No.	Ref. No.	—
	101230	101230	Ref. No.	—

thermocouple nut T1: M8x1 T2: M18x1 aluminium

GEV No.	Ref. No.	GEV No.	Ref. No.	—
	101241	101241	Ref. No.	—

gas connection thread M20x1.5 tube ø 12/10mm for PEL gas taps vertical

GEV No.	Ref. No.	GEV No.	Ref. No.	052127
	101246	101246	Ref. No.	052127

olive for pipe ø 4mm Qty 1 pcs

GEV No.	Ref. No.	GEV No.	Ref. No.	—
	101460	101460	Ref. No.	—



O-ring ø 12.37mm D1 ø 2.62mm suitable for PEL22





Table continues overleaf



<b>spare parts for</b> 101457			
	GEV No.	101461	Ref. No. —
screw kit suitable for PEL22 Qty 4 pcs			
<b>accessories for</b> 101457			
	GEV No.	100945	Ref. No. —
roll pin ø 3.2mm L 10mm			
	GEV No.	101218	Ref. No. —
shaft extension JUNKERS			
	GEV No.	101219	Ref. No. —
shaft extension L 25mm JUNKERS			
	GEV No.	101231	Ref. No. —
thermocouple nut T1: M9x1 T2: M18x1			
	GEV No.	101248	Ref. No. 050682
olive for pipe ø 12mm Qty 1 pcs suitable for PEL			
	GEV No.	101249	Ref. No. —
olive for pipe ø 10mm Qty 1 pcs			
	GEV No.	101250	Ref. No. —
union nut thread M20x1.5 for pipe ø 10mm			
	GEV No.	101251	Ref. No. —
union nut thread M20x1.5 for pipe ø 12mm			
	GEV No.	101290	Ref. No. —
thermocouple nut T1: M10x1 T2: M18x1 suitable for PEL20/21			
	GEV No.	110064	Ref. No. —
knob			
	GEV No.	110066	Ref. No. —
knob screw			
	GEV No.	550396	Ref. No. —
shaft extension L 25mm JUNKERS			

## SABAF

			
1			
<b>GEV No.</b>	101396	<b>Ref. No.</b>	004956
<b>description</b>	gas tap SABAF type 10 gas inlet pipe flange ø16mm bypass nozzle ø 0mm gas outlet 1/4" (tube ø 8mm) front fixing thermocouple connection M8x1 shaft ø 8x6.5mm shaft L 26/12mm shaft flat lower		
<b>spare parts for</b> 101396			
	GEV No.	101376	Ref. No. —
gasket ID ø 8mm ED ø 12mm H 3/5mm			
	GEV No.	101751	Ref. No. —
bracket			

<b>spare parts for</b> 101396			
	GEV No.	106724	Ref. No. —
magnet unit L 30mm D1 ø 12.5mm D2 ø 8.5mm suitable for SABAF			
<b>accessories for</b> 101396			
	GEV No.	101277	Ref. No. —
olive ID ø 8mm Qty 1 pcs			
	GEV No.	101751	Ref. No. —
bracket			
	GEV No.	520656	Ref. No. —
union nut thread 1/4" tube ø 6/8mm			
	GEV No.	560082	Ref. No. —
hexagonal screw thread M4 thread L 16mm SS WS 7 Qty 20 pcs DIN 933 / ISO 4017			

## gas thermostats













### SIT

#### 630 Eurosit series

			
1			
<b>GEV No.</b>	101992	<b>Ref. No.</b>	003334
<b>description</b>	gas thermostat type 630 Eurosit series t.max. 190°C 110-190°C gas inlet 3/8" gas outlet 3/8" thermocouple connection M9x1 pilot connection M10x1 probe ø 4mm probe L 202mm capillary pipe 1050mm SIT		
<b>accessories for</b> 101992			
	GEV No.	100904	Ref. No. 052833
locking screw M10x1 for pipe ø 4mm Qty 1 pcs			
	GEV No.	100905	Ref. No. —
locking screw M10x1 for pipe ø 6mm Qty 1 pcs			
	GEV No.	101273	Ref. No. —
olive for pipe ø 12mm L 9.5mm brass Qty 1 pcs suitable for universal			
	GEV No.	101276	Ref. No. —
union screw thread 3/8" tube ø 12mm Qty 1 pcs			
	GEV No.	101333	Ref. No. —
plug thread 3/8" with O-ring			
	GEV No.	510655	Ref. No. —
gasket silicone ø 7.8mm L 5mm blue Shore 55° Qty 10 pcs			





			
<b>GEV No.</b>	101915	<b>Ref. No.</b>	002096 0C6235
<b>description</b>	gas thermostat type 630 Eurosit series t.max. 320°C 80-320°C gas inlet 3/8" gas outlet 3/8" thermocouple connection M9x1 pilot connection M10x1 probe ø 4mm probe L 72mm capillary pipe 1050mm SIT		
<b>accessories for</b>	101915		
	<b>GEV No.</b>	100825	<b>Ref. No.</b> —
	gas tap spindle shaft ø 8x6.5mm shaft L 22/14mm suitable for EUROSIT		
	<b>GEV No.</b>	100904	<b>Ref. No.</b> 052833
	locking screw M10x1 for pipe ø 4mm Qty 1 pcs		
	<b>GEV No.</b>	100905	<b>Ref. No.</b> —
	locking screw M10x1 for pipe ø 6mm Qty 1 pcs		
	<b>GEV No.</b>	100949	<b>Ref. No.</b> —
	gasket suitable for 630 Eurosit series		
	<b>GEV No.</b>	101273	<b>Ref. No.</b> —
	olive for pipe ø 12mm L 9.5mm brass Qty 1 pcs suitable for universal		
	<b>GEV No.</b>	101276	<b>Ref. No.</b> —
	union screw thread 3/8" tube ø 12mm Qty 1 pcs		
	<b>GEV No.</b>	101333	<b>Ref. No.</b> —
	plug thread 3/8" with O-ring		
	<b>GEV No.</b>	101390	<b>Ref. No.</b> —
	gas tap spindle shaft ø 6x4.6mm shaft L 32/15mm gas tap with ignition flame suitable for ZANUSSI, MARENO for gas thermostat EUROSIT		
	<b>GEV No.</b>	101392	<b>Ref. No.</b> 058773
	adapter suitable for 630 Eurosit series		
	<b>GEV No.</b>	110357	<b>Ref. No.</b> 002130
	gas tap spindle shaft ø 8x6.5mm shaft L 36/12mm suitable for 630 Eurosit series		
	<b>GEV No.</b>	110358	<b>Ref. No.</b> 003391
	adapter shaft ø 10x8mm shaft L 29/18mm suitable for 630 Eurosit series		























<b>710 Minisit series</b>			
			
<b>GEV No.</b>	101135	<b>Ref. No.</b>	056688
<b>description</b>	gas thermostat SIT type MINISIT 710 t.max. 190°C 110-190°C gas inlet 1/2" gas outlet 3/8" thermocouple connection M9x1 pilot connection M10x1 probe ø 6mm probe L 102mm capillary pipe 1050mm probe type type A3 pressure controller no pressure regulator mbar gland nut		
<b>spare parts for</b>	101135		
	<b>GEV No.</b>	101053	<b>Ref. No.</b> 056587
	magnet unit T1: M9x1 T2: M24x1 L 45mm ø 17mm suitable for Minisit		
	<b>GEV No.</b>	102118	<b>Ref. No.</b> —
	probe 110-190°C probe ø 6mm probe L 102mm capillary pipe 1050mm t.max. 190°C fryer probe type type A3 suitable for MINISIT 710		
<b>accessories for</b>	101135		
	<b>GEV No.</b>	100809	<b>Ref. No.</b> —
	O-ring EPDM thickness 2mm ID ø 21mm Qty 1 pcs		
	<b>GEV No.</b>	100820	<b>Ref. No.</b> —
	gland duct ET M14x1.5 IT M10x0.75 probe ø max. 6.5mm WS 22		
	<b>GEV No.</b>	100904	<b>Ref. No.</b> 052833
	locking screw M10x1 for pipe ø 4mm Qty 1 pcs		
	<b>GEV No.</b>	100905	<b>Ref. No.</b> —
	locking screw M10x1 for pipe ø 6mm Qty 1 pcs		
	<b>GEV No.</b>	101054	<b>Ref. No.</b> —
	magnet unit T1: M10x1 T2: M24x1 L 45mm ø 17mm suitable for Minisit		
	<b>GEV No.</b>	101136	<b>Ref. No.</b> 054269
	piezoelectric igniter suitable for Minisit with cover cap ømm connection F6.3x0.8		
	<b>GEV No.</b>	101137	<b>Ref. No.</b> 056577
	cover cap without piezoelectric igniter		
	<b>GEV No.</b>	101267	<b>Ref. No.</b> —
	reducer IT 3/8" ET 1/2" L 21mm		
	<b>GEV No.</b>	101268	<b>Ref. No.</b> —
	gas connection thread 3/8" angled with O-ring MINISIT 710		
	<b>GEV No.</b>	101269	<b>Ref. No.</b> —
	gas connection thread 1/2" angled with O-ring MINISIT 710		
	<b>GEV No.</b>	101270	<b>Ref. No.</b> —
	screw connection IT 3/8" ET 3/8" L 28mm		
	<b>GEV No.</b>	101272	<b>Ref. No.</b> —
	screw connection IT 1/2" ET 3/8" L 57mm		

Table continues overleaf

accessories for		101135		
GEV No.	101273	Ref. No.	—	
	olive for pipe ø 12mm L 9.5mm brass Qty 1 pcs suitable for universal			
GEV No.	101274	Ref. No.	—	
	olive for pipe ø 16mm Qty 1 pcs			
GEV No.	101275	Ref. No.	—	
	union screw thread 1/2" for pipe ø 16mm Qty 1 pcs			
GEV No.	101276	Ref. No.	—	
	union screw thread 3/8" tube ø 12mm Qty 1 pcs			
GEV No.	110068	Ref. No.	054268	
	knob suitable for Minisit ø 37mm			

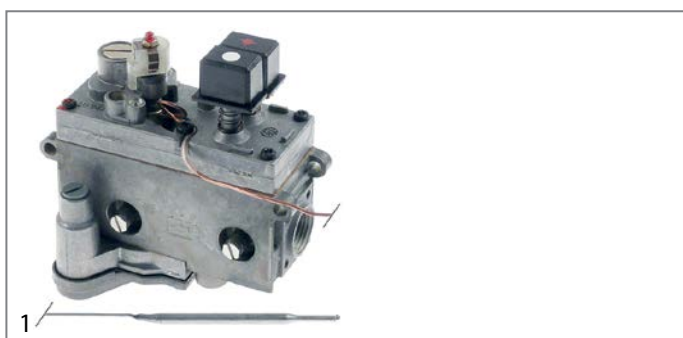

GEV No.	101437	Ref. No.	052685	
<b>description</b>	gas thermostat SIT type MINISIT 710 t.max. 190°C 110-190°C gas inlet 1/2" gas outlet 3/8" thermocouple connection M9x1 pilot connection M10x1 probe ø 6mm probe L 102mm capillary pipe 1050mm probe type type A3 pressure controller yes pressure regulator 3-18mbar gland nut			



spare parts for		101437		
	GEV No.	101053	Ref. No.	056587
magnet unit T1: M9x1 T2: M24x1 L 45mm ø 17mm suitable for Minisit				
	GEV No.	102118	Ref. No.	—
probe 110-190°C probe ø 6mm probe L 102mm capillary pipe 1050mm t.max. 190°C fryer probe type type A3 suitable for MINISIT 710				

accessories for		101437		
	GEV No.	100809	Ref. No.	—
O-ring EPDM thickness 2mm ID ø 21mm Qty 1 pcs				
	GEV No.	100820	Ref. No.	—
gland duct ET M14x1.5 IT M10x0.75 probe ø max. 6.5mm WS 22				
	GEV No.	100904	Ref. No.	052833
locking screw M10x1 for pipe ø 4mm Qty 1 pcs				
	GEV No.	100905	Ref. No.	—
locking screw M10x1 for pipe ø 6mm Qty 1 pcs				
	GEV No.	101054	Ref. No.	—
magnet unit T1: M10x1 T2: M24x1 L 45mm ø 17mm suitable for Minisit				
	GEV No.	101136	Ref. No.	054269
piezoelectric igniter suitable for Minisit with cover cap ømm connection F6.3x0.8				
	GEV No.	101137	Ref. No.	056577
cover cap without piezoelectric igniter				

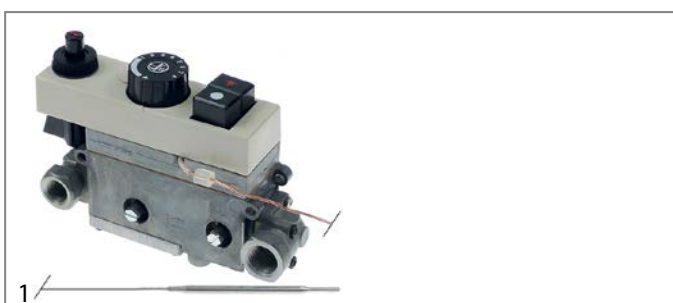
accessories for		101437		
	GEV No.	101267	Ref. No.	—
reducer IT 3/8" ET 1/2" L 21mm				
	GEV No.	101268	Ref. No.	—
gas connection thread 3/8" angled with O-ring MINISIT 710				
	GEV No.	101269	Ref. No.	—
gas connection thread 1/2" angled with O-ring MINISIT 710				
	GEV No.	101270	Ref. No.	—
screw connection IT 3/8" ET 3/8" L 28mm				
	GEV No.	101272	Ref. No.	—
screw connection IT 1/2" ET 3/8" L 57mm				
	GEV No.	101273	Ref. No.	—
olive for pipe ø 12mm L 9.5mm brass Qty 1 pcs suitable for universal				
	GEV No.	101274	Ref. No.	—
olive for pipe ø 16mm Qty 1 pcs				
	GEV No.	101275	Ref. No.	—
union screw thread 1/2" for pipe ø 16mm Qty 1 pcs				
	GEV No.	101276	Ref. No.	—
union screw thread 3/8" tube ø 12mm Qty 1 pcs				
	GEV No.	110068	Ref. No.	054268
knob suitable for Minisit ø 37mm				



GEV No.	103327	Ref. No.	053368	
<b>description</b>	gas thermostat SIT type MINISIT 710 t.max. 190°C 50-190°C gas inlet 1/2" gas outlet 3/8" thermocouple connection M9x1 pilot connection M10x1 probe ø 5mm probe L 98mm capillary pipe 1200mm probe type type A2 pressure controller no pressure regulator mbar gland nut			

spare parts for		103327		
	GEV No.	101053	Ref. No.	056587
magnet unit T1: M9x1 T2: M24x1 L 45mm ø 17mm suitable for Minisit				
	GEV No.	102103	Ref. No.	—
probe 60-200°C probe ø 5mm probe L 98mm capillary pipe 1050mm t.max. 200°C fryer probe type type A2 suitable for MINISIT 710				



accessories for		103327		
	GEV No.	100809	Ref. No.	—
O-ring EPDM thickness 2mm ID ø 21mm Qty 1 pcs				
	GEV No.	100820	Ref. No.	—
gland duct ET M14x1.5 IT M10x0.75 probe ø max. 6.5mm WS 22				





Table continues overleaf



accessories for		103327	
	GEV No.	100904	Ref. No. 052833
locking screw M10x1 for pipe ø 4mm Qty 1 pcs			
	GEV No.	100905	Ref. No. —
locking screw M10x1 for pipe ø 6mm Qty 1 pcs			
	GEV No.	101054	Ref. No. —
magnet unit T1: M10x1 T2: M24x1 L 45mm ø 17mm suitable for Minisit			
	GEV No.	101136	Ref. No. 054269
piezoelectric igniter suitable for Minisit with cover cap ømm connection F6.3x0.8			
	GEV No.	101137	Ref. No. 056577
cover cap without piezoelectric igniter			
	GEV No.	101267	Ref. No. —
reducer IT 3/8" ET 1/2" L 21mm			
	GEV No.	101268	Ref. No. —
gas connection thread 3/8" angled with O-ring MINISIT 710			
	GEV No.	101269	Ref. No. —
gas connection thread 1/2" angled with O-ring MINISIT 710			
	GEV No.	101270	Ref. No. —
screw connection IT 3/8" ET 3/8" L 28mm			
	GEV No.	101272	Ref. No. —
screw connection IT 1/2" ET 3/8" L 57mm			
	GEV No.	101273	Ref. No. —
olive for pipe ø 12mm L 9.5mm brass Qty 1 pcs suitable for universal			
	GEV No.	101274	Ref. No. —
olive for pipe ø 16mm Qty 1 pcs			
	GEV No.	101275	Ref. No. —
union screw thread 1/2" for pipe ø 16mm Qty 1 pcs			
	GEV No.	101276	Ref. No. —
union screw thread 3/8" tube ø 12mm Qty 1 pcs			
	GEV No.	110068	Ref. No. 054268
knob suitable for Minisit ø 37mm			



1 /			
GEV No.	101435	Ref. No.	052068
description	gas thermostat SIT type MINISIT 710 t.max. 340°C 100-340°C gas inlet 1/2" gas outlet 3/8" thermocouple connection M9x1 pilot connection M10x1 probe ø 4mm probe L 72mm capillary pipe 1050mm probe type type C1 pressure controller no pressure regulator bar gland nut		
spare parts for	101435		
	GEV No.	101053	Ref. No. 056587
magnet unit T1: M9x1 T2: M24x1 L 45mm ø 17mm suitable for Minisit			
	GEV No.	102107	Ref. No. —
probe 100-340°C probe ø 4mm probe L 72mm capillary pipe 1050mm t.max. 340°C oven/grill probe type type C1 suitable for MINISIT 710			
accessories for	101435		
	GEV No.	100809	Ref. No. —
O-ring EPDM thickness 2mm ID ø 21mm Qty 1 pcs			
	GEV No.	100904	Ref. No. 052833
locking screw M10x1 for pipe ø 4mm Qty 1 pcs			
	GEV No.	100905	Ref. No. —
locking screw M10x1 for pipe ø 6mm Qty 1 pcs			
	GEV No.	101054	Ref. No. —
magnet unit T1: M10x1 T2: M24x1 L 45mm ø 17mm suitable for Minisit			
	GEV No.	101136	Ref. No. 054269
piezoelectric igniter suitable for Minisit with cover cap ømm connection F6.3x0.8			
	GEV No.	101137	Ref. No. 056577
cover cap without piezoelectric igniter			
	GEV No.	101267	Ref. No. —
reducer IT 3/8" ET 1/2" L 21mm			
	GEV No.	101268	Ref. No. —
gas connection thread 3/8" angled with O-ring MINISIT 710			
	GEV No.	101269	Ref. No. —
gas connection thread 1/2" angled with O-ring MINISIT 710			
	GEV No.	101270	Ref. No. —
screw connection IT 3/8" ET 3/8" L 28mm			
	GEV No.	101272	Ref. No. —
screw connection IT 1/2" ET 3/8" L 57mm			
	GEV No.	101273	Ref. No. —
olive for pipe ø 12mm L 9.5mm brass Qty 1 pcs suitable for universal			

Table continues overleaf

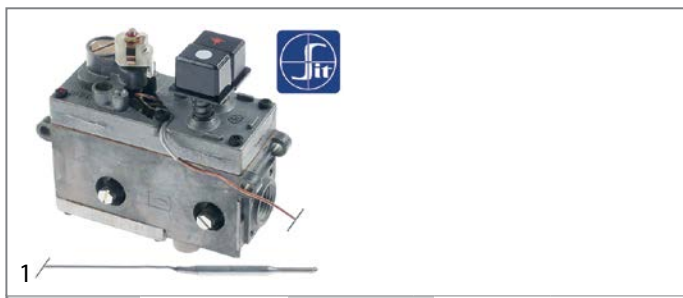
accessories for 101435				
	GEV No.	101274	Ref. No.	—
olive for pipe ø 16mm Qty 1 pcs				
	GEV No.	101275	Ref. No.	—
union screw thread 1/2" for pipe ø 16mm Qty 1 pcs				
	GEV No.	101276	Ref. No.	—
union screw thread 3/8" tube ø 12mm Qty 1 pcs				
	GEV No.	110068	Ref. No.	054268
knob suitable for Minisit ø 37mm				



GEV No.	101132	Ref. No.	056833	
<b>description</b>	gas thermostat SIT type MINISIT 710 t.max. 340°C 100-340°C gas inlet 1/2" gas outlet 3/8" thermocouple connection M9x1 pilot connection M10x1 probe ø 5mm probe L 68mm capillary pipe 1050mm probe type type B1 pressure controller no pressure regulator mbar gland nut ignition gas no			



spare parts for 101132				
	GEV No.	101053	Ref. No.	056587
magnet unit T1: M9x1 T2: M24x1 L 45mm ø 17mm suitable for Minisit				
	GEV No.	102102	Ref. No.	—
probe 100-340°C probe ø 5mm probe L 68mm capillary pipe 1750mm t.max. 340°C oven/grill probe type type B1 suitable for MINISIT 710				

accessories for 101132				
	GEV No.	100809	Ref. No.	—
O-ring EPDM thickness 2mm ID ø 21mm Qty 1 pcs				
	GEV No.	100904	Ref. No.	052833
locking screw M10x1 for pipe ø 4mm Qty 1 pcs				
	GEV No.	100905	Ref. No.	—
locking screw M10x1 for pipe ø 6mm Qty 1 pcs				
	GEV No.	101054	Ref. No.	—
magnet unit T1: M10x1 T2: M24x1 L 45mm ø 17mm suitable for Minisit				
	GEV No.	101136	Ref. No.	054269
piezoelectric igniter suitable for Minisit with cover cap ømm connection F6.3x0.8				
	GEV No.	101137	Ref. No.	056577
cover cap without piezoelectric igniter				
	GEV No.	101267	Ref. No.	—
reducer IT 3/8" ET 1/2" L 21mm				
	GEV No.	101268	Ref. No.	—
gas connection thread 3/8" angled with O-ring MINISIT 710				

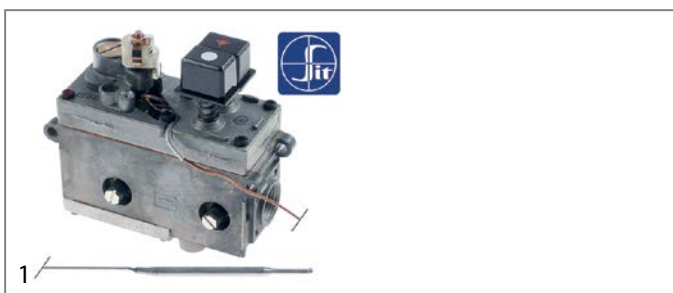
accessories for 101132				
	GEV No.	101269	Ref. No.	—
gas connection thread 1/2" angled with O-ring MINISIT 710				
	GEV No.	101270	Ref. No.	—
screw connection IT 3/8" ET 3/8" L 28mm				
	GEV No.	101272	Ref. No.	—
screw connection IT 1/2" ET 3/8" L 57mm				
	GEV No.	101273	Ref. No.	—
olive for pipe ø 12mm L 9.5mm brass Qty 1 pcs suitable for universal				
	GEV No.	101274	Ref. No.	—
olive for pipe ø 16mm Qty 1 pcs				
	GEV No.	101275	Ref. No.	—
union screw thread 1/2" for pipe ø 16mm Qty 1 pcs				
	GEV No.	101276	Ref. No.	—
union screw thread 3/8" tube ø 12mm Qty 1 pcs				
	GEV No.	110068	Ref. No.	054268
knob suitable for Minisit ø 37mm				



GEV No.	101131	Ref. No.	054267	
<b>description</b>	gas thermostat without cap, button and angle SIT type MINISIT 710 t.max. 190°C 50-190°C gas inlet 1/2" gas outlet 3/8" thermocouple connection M9x1 pilot connection M10x1 probe ø 5mm probe L 98mm capillary pipe 1200mm probe type type A2 pressure controller no pressure regulator mbar gland nut			

spare parts for 101131				
	GEV No.	101053	Ref. No.	056587
magnet unit T1: M9x1 T2: M24x1 L 45mm ø 17mm suitable for Minisit				
	GEV No.	102103	Ref. No.	—
probe 60-200°C probe ø 5mm probe L 98mm capillary pipe 1050mm t.max. 200°C fryer probe type type A2 suitable for MINISIT 710				





accessories for 101131				
	GEV No.	100809	Ref. No.	—
O-ring EPDM thickness 2mm ID ø 21mm Qty 1 pcs				
	GEV No.	100820	Ref. No.	—
gland duct ET M14x1.5 IT M10x0.75 probe ø max. 6.5mm WS 22				
	GEV No.	100904	Ref. No.	052833
locking screw M10x1 for pipe ø 4mm Qty 1 pcs				
	GEV No.	100905	Ref. No.	—
locking screw M10x1 for pipe ø 6mm Qty 1 pcs				

Table continues overleaf



accessories for		101131	
	GEV No.	101054	Ref. No. —
	magnet unit T1: M10x1 T2: M24x1 L 45mm ø 17mm suitable for Minisit		
	GEV No.	101136	Ref. No. 054269
	piezoelectric igniter suitable for Minisit with cover cap ømm connection F6.3x0.8		
	GEV No.	101137	Ref. No. 056577
	cover cap without piezoelectric igniter		
	GEV No.	101267	Ref. No. —
	reducer IT 3/8" ET 1/2" L 21mm		
	GEV No.	101268	Ref. No. —
	gas connection thread 3/8" angled with O-ring MINISIT 710		
	GEV No.	101269	Ref. No. —
	gas connection thread 1/2" angled with O-ring MINISIT 710		
	GEV No.	101270	Ref. No. —
	screw connection IT 3/8" ET 3/8" L 28mm		
	GEV No.	101272	Ref. No. —
	screw connection IT 1/2" ET 3/8" L 57mm		
	GEV No.	101273	Ref. No. —
	olive for pipe ø 12mm L 9.5mm brass Qty 1 pcs suitable for universal		
	GEV No.	101274	Ref. No. —
	olive for pipe ø 16mm Qty 1 pcs		
	GEV No.	101275	Ref. No. —
	union screw thread 1/2" for pipe ø 16mm Qty 1 pcs		
	GEV No.	101276	Ref. No. —
	union screw thread 3/8" tube ø 12mm Qty 1 pcs		
	GEV No.	110068	Ref. No. 054268
	knob suitable for Minisit ø 37mm		

accessories





probes













	1		
GEV No.	102100	Ref. No.	056646
description	probe 30-100°C probe ø 5mm probe L 122mm capillary pipe 1050mm t.max. 100°C bain marie probe type type A1 suitable for MINISIT 710		









MERTIK

	1		
GEV No.	101966	Ref. No.	0C0444
description	gas thermostat MERTIK t.max. 110°C 30-110°C gas inlet lateral 3/8" gas outlet lateral 3/8" thermocouple connection M9x1 capillary pipe 720mm probe ø 6mm probe L 80mm		
spare parts for	101966		
	GEV No.	106221	Ref. No. —
	magnet unit L 32mm D1 ø 19mm D2 ø 14mm suitable for MERTIK		
accessories for	101966		
	GEV No.	100015	Ref. No. —
	ignition cable cable length 600mm connection ø2.4mm / ø2.4mm		
	GEV No.	100018	Ref. No. 004943
	ignition cable cable length 600mm connection ø2.4mm / ø4mm permanent temperature 200°C		
	GEV No.	100179	Ref. No. —
	ignition cable cable length 1200mm connection F2.8mm / ø2.4mm		
	GEV No.	100193	Ref. No. —
	ignition cable cable length 1200mm connection ø2.4mm / ø4mm		
	GEV No.	100197	Ref. No. —
	ignition cable cable length 600mm connection F2.8mm / ø2.4mm		
	GEV No.	100904	Ref. No. 052833
	locking screw M10x1 for pipe ø 4mm Qty 1 pcs		
	GEV No.	101273	Ref. No. —
	olive for pipe ø 12mm L 9.5mm brass Qty 1 pcs suitable for universal		
	GEV No.	101276	Ref. No. —
	union screw thread 3/8" tube ø 12mm Qty 1 pcs		
	GEV No.	102180	Ref. No. —
	ignition cable cable length 1200mm connection ø2.4mm / ø2.4mm		
	GEV No.	106701	Ref. No. 0C5400
	knob adapter thickness 14mm ED ø 26mm shaft 8x6.5mm plastic		
	GEV No.	106718	Ref. No. —
	union screw for gas thermostat MERTIK M9x1 for thermocouple ET M22x1		
	GEV No.	112387	Ref. No. —
	knob dial plate universal red		
	GEV No.	112388	Ref. No. —
	knob dial plate universal silver		
	GEV No.	112598	Ref. No. —
	knob dial plate MERTIK gas regulator (piezoelectric igniter) silver		
	GEV No.	112599	Ref. No. —
	knob dial plate MERTIK gas regulator (piezoelectric igniter) red		

Table continues overleaf

accessories for		101966	
	GEV No.	112601	Ref. No. —
knob dial plate silver gas thermostat MERTIK 1-8 t.max.°C ED ø 59mm ID ø 45.5mm			
	GEV No.	112602	Ref. No. —
knob dial plate red gas thermostat MERTIK 1-8 t.max.°C ED ø 59mm ID ø 45.5mm			
	GEV No.	112949	Ref. No. —
knob MERTIK gas regulator ø 62mm shaft flat upper black special fixing shaft 8x6.5			
	GEV No.	112950	Ref. No. —
knob MERTIK gas regulator ø 32mm black for piezoelectric igniter			

			
<b>1</b>	<b>GEV No.</b>	<b>101957</b>	<b>Ref. No.</b> 006692
<b>description</b>	gas thermostat MERTIK t.max. 340°C 100-340°C gas inlet bottom 3/8" gas outlet lateral 3/8" thermocouple connection M9x1 capillary pipe 720mm probe ø 4mm probe L 68mm		
<b>spare parts for</b>	101957		
	GEV No.	106221	Ref. No. —
magnet unit L 32mm D1 ø 19mm D2 ø 14mm suitable for MERTIK			
<b>accessories for</b>	101957		
	GEV No.	100015	Ref. No. —
ignition cable cable length 600mm connection ø2.4mm / ø2.4mm			
	GEV No.	100018	Ref. No. 004943
ignition cable cable length 600mm connection ø2.4mm / ø4mm permanent temperature 200°C			
	GEV No.	100179	Ref. No. —
ignition cable cable length 1200mm connection F2.8mm / ø2.4mm			
	GEV No.	100193	Ref. No. —
ignition cable cable length 1200mm connection ø2.4mm / ø4mm			
	GEV No.	100197	Ref. No. —
ignition cable cable length 600mm connection F2.8mm / ø2.4mm			
	GEV No.	100904	Ref. No. 052833
locking screw M10x1 for pipe ø 4mm Qty 1 pcs			
	GEV No.	101273	Ref. No. —
olive for pipe ø 12mm L 9.5mm brass Qty 1 pcs suitable for universal			
	GEV No.	101276	Ref. No. —
union screw thread 3/8" tube ø 12mm Qty 1 pcs			
	GEV No.	102180	Ref. No. —
ignition cable cable length 1200mm connection ø2.4mm / ø2.4mm			
	GEV No.	106701	Ref. No. 0C5400
knob adapter thickness 14mm ED ø 26mm shaft 8x6.5mm plastic			
	GEV No.	106718	Ref. No. —
union screw for gas thermostat MERTIK M9x1 for thermocouple ET M22x1			

accessories for		101957	
	GEV No.	112387	Ref. No. —
knob dial plate universal red			
	GEV No.	112388	Ref. No. —
knob dial plate universal silver			
	GEV No.	112598	Ref. No. —
knob dial plate MERTIK gas regulator (piezoelectric igniter) silver			
	GEV No.	112599	Ref. No. —
knob dial plate MERTIK gas regulator (piezoelectric igniter) red			
	GEV No.	112601	Ref. No. —
knob dial plate silver gas thermostat MERTIK 1-8 t.max.°C ED ø 59mm ID ø 45.5mm			
	GEV No.	112602	Ref. No. —
knob dial plate red gas thermostat MERTIK 1-8 t.max.°C ED ø 59mm ID ø 45.5mm			
	GEV No.	112949	Ref. No. —
knob MERTIK gas regulator ø 62mm shaft flat upper black special fixing shaft 8x6.5			
	GEV No.	112950	Ref. No. —
knob MERTIK gas regulator ø 32mm black for piezoelectric igniter			

























			
<b>1</b>	<b>GEV No.</b>	<b>101959</b>	<b>Ref. No.</b> 006460
<b>description</b>	gas thermostat MERTIK t.max. 340°C 100-340°C gas inlet bottom 3/8" gas outlet lateral 3/8" thermocouple connection M9x1 capillary pipe 720mm probe ø 4mm probe L 68mm pressure regulator 2.5-20mbar		
<b>spare parts for</b>	101959		
	GEV No.	106221	Ref. No. —
magnet unit L 32mm D1 ø 19mm D2 ø 14mm suitable for MERTIK			
<b>accessories for</b>	101959		
	GEV No.	100015	Ref. No. —
ignition cable cable length 600mm connection ø2.4mm / ø2.4mm			
	GEV No.	100018	Ref. No. 004943
ignition cable cable length 600mm connection ø2.4mm / ø4mm permanent temperature 200°C			
	GEV No.	100179	Ref. No. —
ignition cable cable length 1200mm connection F2.8mm / ø2.4mm			
	GEV No.	100193	Ref. No. —
ignition cable cable length 1200mm connection ø2.4mm / ø4mm			
	GEV No.	100197	Ref. No. —
ignition cable cable length 600mm connection F2.8mm / ø2.4mm			
	GEV No.	100904	Ref. No. 052833
locking screw M10x1 for pipe ø 4mm Qty 1 pcs			
	GEV No.	101273	Ref. No. —
olive for pipe ø 12mm L 9.5mm brass Qty 1 pcs suitable for universal			

Table continues overleaf







accessories for		101959		
	GEV No.	101276	Ref. No.	—
	union screw thread 3/8" tube ø 12mm Qty 1 pcs			
	GEV No.	102180	Ref. No.	—
	ignition cable cable length 1200mm connection ø2.4mm / ø2.4mm			
	GEV No.	106701	Ref. No.	0C5400
	knob adapter thickness 14mm ED ø 26mm shaft 8x6.5mm plastic			
	GEV No.	106718	Ref. No.	—
	union screw for gas thermostat MERTIK M9x1 for thermocouple ET M22x1			
	GEV No.	112387	Ref. No.	—
	knob dial plate universal red			
	GEV No.	112388	Ref. No.	—
	knob dial plate universal silver			
	GEV No.	112556	Ref. No.	—
	knob switch zero mark t.max.°C temperature range°C ø 46mm shaft MERTIK shaft ømm shaft flat			
	GEV No.	112598	Ref. No.	—
	knob dial plate MERTIK gas regulator (piezoelectric igniter) silver			
	GEV No.	112599	Ref. No.	—
	knob dial plate MERTIK gas regulator (piezoelectric igniter) red			
	GEV No.	112601	Ref. No.	—
	knob dial plate silver gas thermostat MERTIK 1-8 t.max.°C ED ø 59mm ID ø 45.5mm			
	GEV No.	112602	Ref. No.	—
	knob dial plate red gas thermostat MERTIK 1-8 t.max.°C ED ø 59mm ID ø 45.5mm			
	GEV No.	112949	Ref. No.	—
	knob MERTIK gas regulator ø 62mm shaft flat upper black special fixing shaft 8x6.5			
	GEV No.	112950	Ref. No.	—
	knob MERTIK gas regulator ø 32mm black for piezoelectric igniter			

				
1				
<b>GEV No.</b>	106814	<b>Ref. No.</b>	0C5246	
<b>description</b>	gas thermostat MERTIK type GV30T-C3A7A2K0-012 t.max. 340°C 100-340°C gas inlet bottom 3/8" gas inlet lateral gas outlet bottom gas outlet lateral 3/8" thermocouple connection M9x1 pilot connection M10x1 capillary pipe 720mm probe ø 4mm probe L 68mm shaft ø 8x6.5mm shaft L 13mm cable length 900mm gland nut			
<b>spare parts for</b>	106814			
	GEV No.	106221	Ref. No.	—
	magnet unit L 32mm D1 ø 19mm D2 ø 14mm suitable for MERTIK			

accessories for		106814		
	GEV No.	100015	Ref. No.	—
	ignition cable cable length 600mm connection ø2.4mm / ø2.4mm			
	GEV No.	100018	Ref. No.	004943
	ignition cable cable length 600mm connection ø2.4mm / ø4mm permanent temperature 200°C			
	GEV No.	100179	Ref. No.	—
	ignition cable cable length 1200mm connection F2.8mm / ø2.4mm			
	GEV No.	100193	Ref. No.	—
	ignition cable cable length 1200mm connection ø2.4mm / ø4mm			
	GEV No.	100197	Ref. No.	—
	ignition cable cable length 600mm connection F2.8mm / ø2.4mm			
	GEV No.	100904	Ref. No.	052833
	locking screw M10x1 for pipe ø 4mm Qty 1 pcs			
	GEV No.	101273	Ref. No.	—
	olive for pipe ø 12mm L 9.5mm brass Qty 1 pcs suitable for universal			
	GEV No.	101276	Ref. No.	—
	union screw thread 3/8" tube ø 12mm Qty 1 pcs			
	GEV No.	102180	Ref. No.	—
	ignition cable cable length 1200mm connection ø2.4mm / ø2.4mm			
	GEV No.	106701	Ref. No.	0C5400
	knob adapter thickness 14mm ED ø 26mm shaft 8x6.5mm plastic			
	GEV No.	106718	Ref. No.	—
	union screw for gas thermostat MERTIK M9x1 for thermocouple ET M22x1			
	GEV No.	112387	Ref. No.	—
	knob dial plate universal red			
	GEV No.	112388	Ref. No.	—
	knob dial plate universal silver			
	GEV No.	112598	Ref. No.	—
	knob dial plate MERTIK gas regulator (piezoelectric igniter) silver			
	GEV No.	112599	Ref. No.	—
	knob dial plate MERTIK gas regulator (piezoelectric igniter) red			
	GEV No.	112601	Ref. No.	—
	knob dial plate silver gas thermostat MERTIK 1-8 t.max.°C ED ø 59mm ID ø 45.5mm			
	GEV No.	112602	Ref. No.	—
	knob dial plate red gas thermostat MERTIK 1-8 t.max.°C ED ø 59mm ID ø 45.5mm			
	GEV No.	112949	Ref. No.	—
	knob MERTIK gas regulator ø 62mm shaft flat upper black special fixing shaft 8x6.5			
	GEV No.	112950	Ref. No.	—
	knob MERTIK gas regulator ø 32mm black for piezoelectric igniter			

			
<b>1</b>			
<b>GEV No.</b>	101979	<b>Ref. No.</b>	006574
<b>description</b>	gas thermostat MERTIK type GV31T t.max. 190°C 110-190°C gas inlet bottom 3/8" gas inlet lateral 3/8" gas outlet bottom 3/8" gas outlet lateral 3/8" thermocouple connection M9x1 capillary pipe 720mm probe ø 4mm probe L 160mm pressure regulator 5-40mbar		
<b>spare parts for</b>	101979		
	<b>GEV No.</b>	106221	<b>Ref. No.</b> —
	magnet unit L 32mm D1 ø 19mm D2 ø 14mm suitable for MERTIK		
<b>accessories for</b>	101979		
	<b>GEV No.</b>	100015	<b>Ref. No.</b> —
	ignition cable cable length 600mm connection ø2.4mm / ø2.4mm		
	<b>GEV No.</b>	100018	<b>Ref. No.</b> 004943
	ignition cable cable length 600mm connection ø2.4mm / ø4mm permanent temperature 200°C		
	<b>GEV No.</b>	100179	<b>Ref. No.</b> —
	ignition cable cable length 1200mm connection F2.8mm / ø2.4mm		
	<b>GEV No.</b>	100193	<b>Ref. No.</b> —
	ignition cable cable length 1200mm connection ø2.4mm / ø4mm		
	<b>GEV No.</b>	100197	<b>Ref. No.</b> —
	ignition cable cable length 600mm connection F2.8mm / ø2.4mm		
	<b>GEV No.</b>	100904	<b>Ref. No.</b> 052833
	locking screw M10x1 for pipe ø 4mm Qty 1 pcs		
	<b>GEV No.</b>	101273	<b>Ref. No.</b> —
	olive for pipe ø 12mm L 9.5mm brass Qty 1 pcs suitable for universal		
	<b>GEV No.</b>	101276	<b>Ref. No.</b> —
	union screw thread 3/8" tube ø 12mm Qty 1 pcs		
	<b>GEV No.</b>	102180	<b>Ref. No.</b> —
	ignition cable cable length 1200mm connection ø2.4mm / ø2.4mm		
	<b>GEV No.</b>	106701	<b>Ref. No.</b> 0C5400
	knob adapter thickness 14mm ED ø 26mm shaft 8x6.5mm plastic		
	<b>GEV No.</b>	106718	<b>Ref. No.</b> —
	union screw for gas thermostat MERTIK M9x1 for thermocouple ET M22x1		
	<b>GEV No.</b>	112387	<b>Ref. No.</b> —
	knob dial plate universal red		
	<b>GEV No.</b>	112388	<b>Ref. No.</b> —
	knob dial plate universal silver		
	<b>GEV No.</b>	112598	<b>Ref. No.</b> —
	knob dial plate MERTIK gas regulator (piezoelectric igniter) silver		

<b>accessories for</b>	101979		
	<b>GEV No.</b>	112599	<b>Ref. No.</b> —
	knob dial plate MERTIK gas regulator (piezoelectric igniter) red		
	<b>GEV No.</b>	112601	<b>Ref. No.</b> —
	knob dial plate silver gas thermostat MERTIK 1-8 t.max.°C ED ø 59mm ID ø 45.5mm		
	<b>GEV No.</b>	112602	<b>Ref. No.</b> —
	knob dial plate red gas thermostat MERTIK 1-8 t.max.°C ED ø 59mm ID ø 45.5mm		
	<b>GEV No.</b>	112949	<b>Ref. No.</b> —
	knob MERTIK gas regulator ø 62mm shaft flat upper black special fixing shaft 8x6.5		
	<b>GEV No.</b>	112950	<b>Ref. No.</b> —
	knob MERTIK gas regulator ø 32mm black for piezoelectric igniter		















			
<b>1</b>			
<b>GEV No.</b>	101960	<b>Ref. No.</b>	0C0209
<b>description</b>	gas thermostat MERTIK type GV31T t.max. 340°C 100-340°C gas inlet bottom 3/8" gas outlet bottom 3/8" thermocouple connection M9x1 capillary pipe 720mm probe ø 4mm probe L 72mm		
<b>spare parts for</b>	101960		
	<b>GEV No.</b>	106221	<b>Ref. No.</b> —
	magnet unit L 32mm D1 ø 19mm D2 ø 14mm suitable for MERTIK		
<b>accessories for</b>	101960		
	<b>GEV No.</b>	100015	<b>Ref. No.</b> —
	ignition cable cable length 600mm connection ø2.4mm / ø2.4mm		
	<b>GEV No.</b>	100018	<b>Ref. No.</b> 004943
	ignition cable cable length 600mm connection ø2.4mm / ø4mm permanent temperature 200°C		
	<b>GEV No.</b>	100179	<b>Ref. No.</b> —
	ignition cable cable length 1200mm connection F2.8mm / ø2.4mm		
	<b>GEV No.</b>	100193	<b>Ref. No.</b> —
	ignition cable cable length 1200mm connection ø2.4mm / ø4mm		
	<b>GEV No.</b>	100197	<b>Ref. No.</b> —
	ignition cable cable length 600mm connection F2.8mm / ø2.4mm		
	<b>GEV No.</b>	100904	<b>Ref. No.</b> 052833
	locking screw M10x1 for pipe ø 4mm Qty 1 pcs		
	<b>GEV No.</b>	100908	<b>Ref. No.</b> 052125
	union screw thread M10x1 for pipe ø 4mm Qty 1 pcs		
	<b>GEV No.</b>	101246	<b>Ref. No.</b> 052127
	olive for pipe ø 4mm Qty 1 pcs		

Table continues overleaf



































accessories for		101960	
	GEV No.	101248	Ref. No. 050682
	olive for pipe ø 12mm Qty 1 pcs suitable for PEL		
	GEV No.	101273	Ref. No. —
	olive for pipe ø 12mm L 9.5mm brass Qty 1 pcs suitable for universal		
	GEV No.	101276	Ref. No. —
	union screw thread 3/8" tube ø 12mm Qty 1 pcs		
	GEV No.	101278	Ref. No. 060325
	olive for pipe ø 10mm Qty 1 pcs		
	GEV No.	102180	Ref. No. —
	ignition cable cable length 1200mm connection ø2.4mm / ø2.4mm		
	GEV No.	106701	Ref. No. 0C5400
	knob adapter thickness 14mm ED ø 26mm shaft 8x6.5mm plastic		
	GEV No.	106718	Ref. No. —
	union screw for gas thermostat MERTIK M9x1 for thermocouple ET M22x1		
	GEV No.	112387	Ref. No. —
	knob dial plate universal red		
	GEV No.	112388	Ref. No. —
	knob dial plate universal silver		
	GEV No.	112598	Ref. No. —
	knob dial plate MERTIK gas regulator (piezoelectric igniter) silver		
	GEV No.	112599	Ref. No. —
	knob dial plate MERTIK gas regulator (piezoelectric igniter) red		
	GEV No.	112601	Ref. No. —
	knob dial plate silver gas thermostat MERTIK 1-8 t.max.°C ED ø 59mm ID ø 45.5mm		
	GEV No.	112602	Ref. No. —
	knob dial plate red gas thermostat MERTIK 1-8 t.max.°C ED ø 59mm ID ø 45.5mm		
	GEV No.	112949	Ref. No. —
	knob MERTIK gas regulator ø 62mm shaft flat upper black special fixing shaft 8x6.5		
	GEV No.	112950	Ref. No. —
	knob MERTIK gas regulator ø 32mm black for piezoelectric igniter		

			
<b>GEV No.</b>	106813	<b>Ref. No.</b>	0C5247
<b>description</b>	gas thermostat MERTIK type GV31T-C1A7AGK0-003 t.max. 340°C 100-340°C gas inlet bottom 3/8" gas inlet lateral gas outlet bottom 3/8" gas outlet lateral thermocouple connection M9x1 pilot connection M10x1 capillary pipe 720mm probe ø 4mm probe L 68mm cable length 1300mm gland nut		
<b>spare parts for</b>	106813		
	GEV No.	106221	Ref. No. —
	magnet unit L 32mm D1 ø 19mm D2 ø 14mm suitable for MERTIK		

accessories for		106813	
	GEV No.	100015	Ref. No. —
	ignition cable cable length 600mm connection ø2.4mm / ø2.4mm		
	GEV No.	100018	Ref. No. 004943
	ignition cable cable length 600mm connection ø2.4mm / ø4mm permanent temperature 200°C		
	GEV No.	100179	Ref. No. —
	ignition cable cable length 1200mm connection F2.8mm / ø2.4mm		
	GEV No.	100193	Ref. No. —
	ignition cable cable length 1200mm connection ø2.4mm / ø4mm		
	GEV No.	100197	Ref. No. —
	ignition cable cable length 600mm connection F2.8mm / ø2.4mm		
	GEV No.	100904	Ref. No. 052833
	locking screw M10x1 for pipe ø 4mm Qty 1 pcs		
	GEV No.	101273	Ref. No. —
	olive for pipe ø 12mm L 9.5mm brass Qty 1 pcs suitable for universal		
	GEV No.	101276	Ref. No. —
	union screw thread 3/8" tube ø 12mm Qty 1 pcs		
	GEV No.	102180	Ref. No. —
	ignition cable cable length 1200mm connection ø2.4mm / ø2.4mm		
	GEV No.	106701	Ref. No. 0C5400
	knob adapter thickness 14mm ED ø 26mm shaft 8x6.5mm plastic		
	GEV No.	106718	Ref. No. —
	union screw for gas thermostat MERTIK M9x1 for thermocouple ET M22x1		
	GEV No.	112387	Ref. No. —
	knob dial plate universal red		
	GEV No.	112388	Ref. No. —
	knob dial plate universal silver		
	GEV No.	112598	Ref. No. —
	knob dial plate MERTIK gas regulator (piezoelectric igniter) silver		
	GEV No.	112599	Ref. No. —
	knob dial plate MERTIK gas regulator (piezoelectric igniter) red		
	GEV No.	112601	Ref. No. —
	knob dial plate silver gas thermostat MERTIK 1-8 t.max.°C ED ø 59mm ID ø 45.5mm		
	GEV No.	112602	Ref. No. —
	knob dial plate red gas thermostat MERTIK 1-8 t.max.°C ED ø 59mm ID ø 45.5mm		
	GEV No.	112949	Ref. No. —
	knob MERTIK gas regulator ø 62mm shaft flat upper black special fixing shaft 8x6.5		
	GEV No.	112950	Ref. No. —
	knob MERTIK gas regulator ø 32mm black for piezoelectric igniter		

			
<b>GEV No.</b>	106700	<b>Ref. No.</b>	0C5248
<b>description</b>	gas thermostat MERTIK type GV31T-C5AXE2K0 t.max. 190°C 110-190°C gas inlet bottom 3/8" gas inlet lateral 3/8" gas outlet bottom 3/8" gas outlet lateral 3/8" thermocouple connection M9x1 pilot connection M10x1 capillary pipe 720mm probe ø 4mm probe L 165mm shaft ø 8x6.5mm shaft L 13mm cable length 900mm		
<b>spare parts for</b>	106700		
	<b>GEV No.</b>	106221	<b>Ref. No.</b> —
	magnet unit L 32mm D1 ø 19mm D2 ø 14mm suitable for MERTIK		
<b>accessories for</b>	106700		
	<b>GEV No.</b>	100015	<b>Ref. No.</b> —
	ignition cable cable length 600mm connection ø2.4mm / ø2.4mm		
	<b>GEV No.</b>	100018	<b>Ref. No.</b> 004943
	ignition cable cable length 600mm connection ø2.4mm / ø4mm permanent temperature 200°C		
	<b>GEV No.</b>	100179	<b>Ref. No.</b> —
	ignition cable cable length 1200mm connection F2.8mm / ø2.4mm		
	<b>GEV No.</b>	100193	<b>Ref. No.</b> —
	ignition cable cable length 1200mm connection ø2.4mm / ø4mm		
	<b>GEV No.</b>	100197	<b>Ref. No.</b> —
	ignition cable cable length 600mm connection F2.8mm / ø2.4mm		
	<b>GEV No.</b>	100904	<b>Ref. No.</b> 052833
	locking screw M10x1 for pipe ø 4mm Qty 1 pcs		
	<b>GEV No.</b>	101273	<b>Ref. No.</b> —
	olive for pipe ø 12mm L 9.5mm brass Qty 1 pcs suitable for universal		
	<b>GEV No.</b>	101276	<b>Ref. No.</b> —
	union screw thread 3/8" tube ø 12mm Qty 1 pcs		
	<b>GEV No.</b>	102180	<b>Ref. No.</b> —
	ignition cable cable length 1200mm connection ø2.4mm / ø2.4mm		
	<b>GEV No.</b>	106701	<b>Ref. No.</b> 0C5400
	knob adapter thickness 14mm ED ø 26mm shaft 8x6.5mm plastic		
	<b>GEV No.</b>	106702	<b>Ref. No.</b> 0C0625
	plug thread 3/8" with O-ring L 12mm WS 8 brass suitable for MERTIK		
	<b>GEV No.</b>	106718	<b>Ref. No.</b> —
	union screw for gas thermostat MERTIK M9x1 for thermocouple ET M22x1		
	<b>GEV No.</b>	112387	<b>Ref. No.</b> —
	knob dial plate universal red		





<b>accessories for</b>	106700		
	<b>GEV No.</b>	112388	<b>Ref. No.</b> —
	knob dial plate universal silver		
	<b>GEV No.</b>	112598	<b>Ref. No.</b> —
	knob dial plate MERTIK gas regulator (piezoelectric igniter) silver		
	<b>GEV No.</b>	112599	<b>Ref. No.</b> —
	knob dial plate MERTIK gas regulator (piezoelectric igniter) red		
	<b>GEV No.</b>	112601	<b>Ref. No.</b> —
	knob dial plate silver gas thermostat MERTIK 1-8 t.max.°C ED ø 59mm ID ø 45.5mm		
	<b>GEV No.</b>	112602	<b>Ref. No.</b> —
	knob dial plate red gas thermostat MERTIK 1-8 t.max.°C ED ø 59mm ID ø 45.5mm		
	<b>GEV No.</b>	112949	<b>Ref. No.</b> —
	knob MERTIK gas regulator ø 62mm shaft flat upper black special fixing shaft 8x6.5		
	<b>GEV No.</b>	112950	<b>Ref. No.</b> —
	knob MERTIK gas regulator ø 32mm black for piezoelectric igniter		

<b>PEL</b>			
<b>24STS series</b>			
			
<b>GEV No.</b>	101160 <sup>1</sup>	<b>Ref. No.</b>	026335
<b>description</b>	gas thermostat PEL type 24STS 120-320°C gas inlet M20x1.5 (tube ø 12/10mm) bypass nozzle ø 0.35mm gas outlet M20x1.5 (tube ø 12/10mm) thermocouple connection M9x1 pilot connection M10x1 capillary pipe 1200mm probe ø 6mm probe L 100mm shaft ø 10x8mm shaft L 27/17mm shaft flat upper		
<b>spare parts for</b>	101160		
	<b>GEV No.</b>	101058	<b>Ref. No.</b> 056594
	magnet unit L 39mm D1 ø 15.4mm D2 ø 13.5mm suitable for PEL22/EGA24197 standard		
<b>accessories for</b>	101160		
	<b>GEV No.</b>	101235	<b>Ref. No.</b> —
	gas connection thread M20x1.5 tube ø 12/10mm for PEL gas taps horizontal		
	<b>GEV No.</b>	101236	<b>Ref. No.</b> —
	gas connection thread M20x1.5 tube ø 12/10mm for PEL gas taps vertical		
	<b>GEV No.</b>	101239	<b>Ref. No.</b> —
	adapter thread 3/8" ø 10mm left-hand thread		
	<b>GEV No.</b>	101240	<b>Ref. No.</b> —
	gas connection thread M20x1.5 tube ø 12/10mm for PEL gas taps with gasket and screws horizontal		
	<b>GEV No.</b>	101241	<b>Ref. No.</b> —
	gas connection thread M20x1.5 tube ø 12/10mm for PEL gas taps vertical		
	<b>GEV No.</b>	101248	<b>Ref. No.</b> 050682
	olive for pipe ø 12mm Qty 1 pcs suitable for PEL		

<sup>1</sup>incl. knob and connectors  
Table continues overleaf



accessories for		101160		
	GEV No.	101249	Ref. No.	—
olive for pipe ø 10mm Qty 1 pcs				
	GEV No.	101250	Ref. No.	—
union nut thread M20x1.5 for pipe ø 10mm				
	GEV No.	101251	Ref. No.	—
union nut thread M20x1.5 for pipe ø 12mm				
	GEV No.	101460	Ref. No.	—
O-ring ø 12.37mm D1 ø 2.62mm suitable for PEL22				
	GEV No.	101461	Ref. No.	—
screw kit suitable for PEL22 Qty 4 pcs				
	GEV No.	110079	Ref. No.	—
knob dial plate gas thermostat 1-8 silver				
	GEV No.	110080	Ref. No.	—
knob ø 70mm shaft ø 10x8mm shaft flat universal				





accessories for		101955		
	GEV No.	101450	Ref. No.	—
olive for pipe ø 8mm L 12.7mm Qty 1 pcs ED ø 10mm				
	GEV No.	101451	Ref. No.	—
union nut thread M16x1.5 tube ø 8mm				
	GEV No.	110079	Ref. No.	—
knob dial plate gas thermostat 1-8 silver				
	GEV No.	110081	Ref. No.	—
knob ø 70mm shaft ø 8x6.5mm shaft flat universal				

## gas valves and ignition boxes

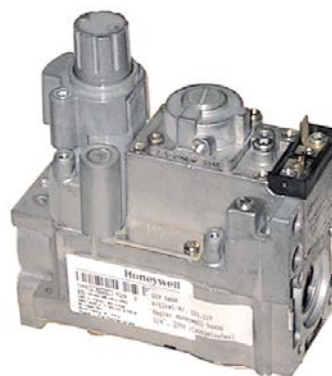
### gas control valves

#### HONEYWELL





1		106229		
<b>GEV No.</b>	106229	<b>Ref. No.</b>	002178	
<b>description</b>	gas valve type V4600A1031 230V 50Hz gas inlet 1/2" gas outlet 1/2" thermocouple connection 11/32" pilot connection M11x1 pressure range 5-50mbar operator type 230V (V404A 1071) suitable for HONEYWELL			
<b>accessories for</b>	106229			
	GEV No.	101305	Ref. No.	—
gas connection straight 1/2" flange 45x45mm ELETTRISIT/V4400/4600/4605 suitable for SIT/HONEYWELL hole distance 36x36mm				
	GEV No.	101306	Ref. No.	—
gas connection angled flange 45x45mm hole distance 36x36mm 1/2" ELETTRISIT/V4400/4600/4605 screw with O-ring suitable for SIT/HONEYWELL				
	GEV No.	101307	Ref. No.	—
gas connection straight flange 45x45mm hole distance 36x36mm 3/4" ELETTRISIT/V4400/4600/4605 screw with O-ring suitable for SIT/HONEYWELL				
	GEV No.	101308	Ref. No.	—
gas connection angled flange 45x45mm hole distance 36x36mm 3/4" ELETTRISIT/V4400/4600/4605 screw with O-ring suitable for SIT/HONEYWELL				
	GEV No.	101494	Ref. No.	—
locking screw thread M11x1 for pipe ø 6mm Qty 1 pcs				

25ST series				
	1			
<b>GEV No.</b>	101955	<b>Ref. No.</b>	006597	
<b>description</b>	gas thermostat PEL type 25ST 140 up to approx. 300°C gas inlet M16x1.5 (tube ø 10mm) bypass nozzle ø 0.5mm gas outlet M16x1.5 (tube ø 10/8mm) thermocouple connection M8x1 pilot connection M10x1 capillary pipe 1200mm probe ø 6mm probe L 120mm shaft ø 8x6.5mm shaft L 38/15mm shaft flat upper			
<b>spare parts for</b>	101955			
	GEV No.	100390	Ref. No.	—
bypass nozzle type PEL22 bore ø 0.5mm thread M6x0.5				
	GEV No.	101060	Ref. No.	056595
magnet unit standard L 39mm D1 ø 15.4mm D2 ø 11mm suitable for PEL20-21/JUNKERS/EGA				
	GEV No.	106199	Ref. No.	—
nut thread M8x1				
<b>accessories for</b>	101955			
	GEV No.	100908	Ref. No.	052125
union screw thread M10x1 for pipe ø 4mm Qty 1 pcs				
	GEV No.	100909	Ref. No.	—
union screw thread M10x1 for pipe ø 6mm Qty 1 pcs				
	GEV No.	101246	Ref. No.	052127
olive for pipe ø 4mm Qty 1 pcs				
	GEV No.	101278	Ref. No.	060325
olive for pipe ø 10mm Qty 1 pcs				
	GEV No.	101286	Ref. No.	—
olive ID ø 6mm Qty 1 pcs				
	GEV No.	101300	Ref. No.	—
union nut thread M16x1.5 tube ø 10mm				





1

<b>GEV No.</b>	106007	<b>Ref. No.</b>	005925
<b>description</b>	gas valve type VK4105A 220-240V 50/60Hz gas inlet flange 32x32mm gas outlet flange 32x32mm thermocouple connection pilot connection pressure range 15-60mbar max 60mbar operator type suitable for HONEYWELL flange 32x32mm		
<b>accessories for</b>	106007		
	<b>GEV No.</b>	102845	<b>Ref. No.</b> —
	gas connection angled 1/2" flange 32x32mm hole distance 24x24mm Tandem		
	<b>GEV No.</b>	102846	<b>Ref. No.</b> —
	gas connection straight 1/2" flange 32x32mm hole distance 24x24mm suitable for Tandem		



1

<b>GEV No.</b>	106008	<b>Ref. No.</b>	006596
<b>description</b>	gas valve type VK4105P 220/240V 50/60Hz gas inlet 1/2" NPT gas outlet 1/2" NPT thermocouple connection pilot connection pressure range 15-60mbar max 60mbar operator type HONEYWELL suitable for coil type 220/240V (V4336A 2220) flange 32x32mm		
<b>accessories for</b>	106008		
	<b>GEV No.</b>	102845	<b>Ref. No.</b> —
	gas connection angled 1/2" flange 32x32mm hole distance 24x24mm Tandem		
	<b>GEV No.</b>	102846	<b>Ref. No.</b> —
	gas connection straight 1/2" flange 32x32mm hole distance 24x24mm suitable for Tandem		

SIT

ELETTROSIT



1

<b>GEV No.</b>	101123	<b>Ref. No.</b>	0A2035
<b>description</b>	gas valve SIT type ELETTROSIT 230V gas inlet 3/4" gas outlet 3/4" thermocouple connection M9x1 pilot connection M10x1 bottom equiv. no. 0.810.138		
<b>spare parts for</b>	101123		
	<b>GEV No.</b>	101312	<b>Ref. No.</b> 054539
	microswitch		
	<b>GEV No.</b>	101352	<b>Ref. No.</b> —
	solenoid coil 230V 50Hz suitable for ELETTROSIT		
<b>accessories for</b>	101123		
	<b>GEV No.</b>	100006	<b>Ref. No.</b> —
	piezoelectric igniter suitable for ELETTROSIT body plastic blowing connection ø2.4mm ø 14mm		
	<b>GEV No.</b>	100904	<b>Ref. No.</b> 052833
	locking screw M10x1 for pipe ø 4mm Qty 1 pcs		
	<b>GEV No.</b>	100905	<b>Ref. No.</b> —
	locking screw M10x1 for pipe ø 6mm Qty 1 pcs		
	<b>GEV No.</b>	101301	<b>Ref. No.</b> —
	gas connection thread 1/2" straight ELETTROSIT screw with O-ring		
	<b>GEV No.</b>	101303	<b>Ref. No.</b> —
	gas connection straight thread 3/4" ELETTROSIT		
	<b>GEV No.</b>	101309	<b>Ref. No.</b> 051281
	extension		



<b>GEV No.</b>	101127	<b>Ref. No.</b>	057543
<b>description</b>	gas valve SIT type ELETTROSIT 230V gas inlet 3/4" gas outlet 3/4" thermocouple connection M9x1 pilot connection M10x1 lateral equiv. no. 0.810.175		
<b>spare parts for</b>	101127		
	<b>GEV No.</b>	101312	<b>Ref. No.</b> 054539
	microswitch		
	<b>GEV No.</b>	101352	<b>Ref. No.</b> —
	solenoid coil 230V 50Hz suitable for ELETTROSIT		
<b>accessories for</b>	101127		
	<b>GEV No.</b>	100006	<b>Ref. No.</b> —
	piezoelectric igniter suitable for ELETTROSIT body plastic blowing connection ø2.4mm ø 14mm		
	<b>GEV No.</b>	100904	<b>Ref. No.</b> 052833
	locking screw M10x1 for pipe ø 4mm Qty 1 pcs		
	<b>GEV No.</b>	100905	<b>Ref. No.</b> —
	locking screw M10x1 for pipe ø 6mm Qty 1 pcs		
	<b>GEV No.</b>	101301	<b>Ref. No.</b> —
	gas connection thread 1/2" straight ELETTROSIT screw with O-ring		
	<b>GEV No.</b>	101303	<b>Ref. No.</b> —
	gas connection straight thread 3/4" ELETTROSIT		
	<b>GEV No.</b>	101309	<b>Ref. No.</b> 051281
	extension		



<b>GEV No.</b>	101122	<b>Ref. No.</b>	054437
<b>description</b>	gas valve SIT type ELETTROSIT 24V gas inlet 3/4" gas outlet 3/4" thermocouple connection M9x1 equiv. no. 0.810.171 pilot outlet M10x1		
<b>spare parts for</b>	101122		
	<b>GEV No.</b>	101312	<b>Ref. No.</b> 054539
	microswitch		

<b>accessories for</b>	101122		
	<b>GEV No.</b>	100006	<b>Ref. No.</b> —
	piezoelectric igniter suitable for ELETTROSIT body plastic blowing connection ø2.4mm ø 14mm		
	<b>GEV No.</b>	100904	<b>Ref. No.</b> 052833
	locking screw M10x1 for pipe ø 4mm Qty 1 pcs		
	<b>GEV No.</b>	100905	<b>Ref. No.</b> —
	locking screw M10x1 for pipe ø 6mm Qty 1 pcs		
	<b>GEV No.</b>	101301	<b>Ref. No.</b> —
	gas connection thread 1/2" straight ELETTROSIT screw with O-ring		
	<b>GEV No.</b>	101303	<b>Ref. No.</b> —
	gas connection straight thread 3/4" ELETTROSIT		
	<b>GEV No.</b>	101309	<b>Ref. No.</b> 051281
	extension		

NOVASIT

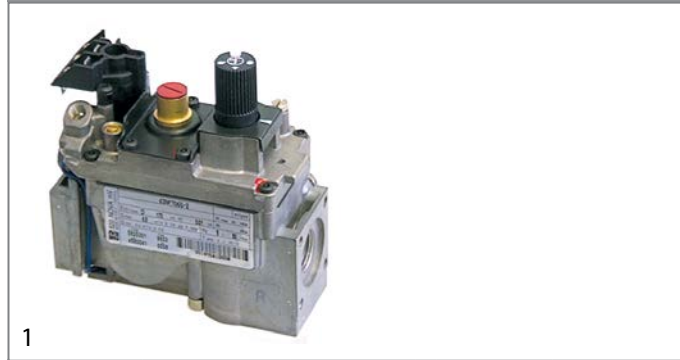

<b>GEV No.</b>	101187	<b>Ref. No.</b>	002606
<b>description</b>	gas valve SIT series Novasit 820 0.17VHz gas inlet 1/2" gas outlet 1/2" thermocouple connection M9x1 pilot connection M10x1 ignition pressurebar pressure range 5-50mbar pressure regulator connection blind equiv. no. 0.820.301 supply Operator millivolt		
<b>spare parts for</b>	101187		
	<b>GEV No.</b>	101065	<b>Ref. No.</b> 056589
	magnet unit with cable L 44mm D1 ø 30mm D2 ø 20mm suitable for NOVASIT		
<b>accessories for</b>	101187		
	<b>GEV No.</b>	100110	<b>Ref. No.</b> 002783
	pilot burner SIT type 190 series 3 flames nozzle ømm gas connectionmm		
	<b>GEV No.</b>	101305	<b>Ref. No.</b> —
	gas connection straight 1/2" flange 45x45mm ELETTROSIT/V4400/4600/4605 suitable for SIT/HONEYWELL hole distance 36x36mm		
	<b>GEV No.</b>	101306	<b>Ref. No.</b> —
	gas connection angled flange 45x45mm hole distance 36x36mm 1/2" ELETTROSIT/V4400/4600/4605 screw with O-ring suitable for SIT/HONEYWELL		
	<b>GEV No.</b>	101307	<b>Ref. No.</b> —
	gas connection straight flange 45x45mm hole distance 36x36mm 3/4" ELETTROSIT/V4400/4600/4605 screw with O-ring suitable for SIT/HONEYWELL		
	<b>GEV No.</b>	101308	<b>Ref. No.</b> —
	gas connection angled flange 45x45mm hole distance 36x36mm 3/4" ELETTROSIT/V4400/4600/4605 screw with O-ring suitable for SIT/HONEYWELL		

Table continues overleaf





<b>accessories for</b>	101187			
	GEV No.	102116	Ref. No.	002607
thermopile ROBERTSHAW L 900mm probe ø 9mm probe L 57mm 250-750mV screw connection 7/16"				



<b>GEV No.</b>	101760	<b>Ref. No.</b>	006182
<b>description</b>	gas valve SIT series Novasit 820 220V 50Hz gas inlet 1/2" gas outlet 1/2" thermocouple connection M9x1 pilot connection M10x1 ignition pressure 3-5mbar pressure range 3-30mbar pressure regulator connection blind equiv. no. 0.820.060		

<b>spare parts for</b>	101760		
------------------------	--------	--	--

	GEV No.	101065	Ref. No.	056589
magnet unit with cable L 44mm D1 ø 30mm D2 ø 20mm suitable for NOVASIT				

	GEV No.	101867	Ref. No.	—
solenoid coil 220V 60Hz				

<b>accessories for</b>	101760		
------------------------	--------	--	--

	GEV No.	100006	Ref. No.	—
piezoelectric igniter suitable for ELETTROSIT body plastic blowing connection ø2.4mm ø 14mm				

	GEV No.	100904	Ref. No.	052833
locking screw M10x1 for pipe ø 4mm Qty 1 pcs				

	GEV No.	100905	Ref. No.	—
locking screw M10x1 for pipe ø 6mm Qty 1 pcs				

	GEV No.	101305	Ref. No.	—
gas connection straight 1/2" flange 45x45mm ELETTROSIT/V4400/4600/4605 suitable for SIT/HONEYWELL hole distance 36x36mm				

	GEV No.	101306	Ref. No.	—
gas connection angled flange 45x45mm hole distance 36x36mm 1/2" ELETTROSIT/V4400/4600/4605 screw with O-ring suitable for SIT/HONEYWELL				



	GEV No.	101307	Ref. No.	—
gas connection straight flange 45x45mm hole distance 36x36mm 3/4" ELETTROSIT/V4400/4600/4605 screw with O-ring suitable for SIT/HONEYWELL				

	GEV No.	101308	Ref. No.	—
gas connection angled flange 45x45mm hole distance 36x36mm 3/4" ELETTROSIT/V4400/4600/4605 screw with O-ring suitable for SIT/HONEYWELL				

	GEV No.	101312	Ref. No.	054539
microswitch				

	GEV No.	101313	Ref. No.	0K3020
solenoid coil 230V 50Hz				

	GEV No.	101314	Ref. No.	—
solenoid coil 24V 50Hz				

<b>accessories for</b>	101760			
	GEV No.	101317	Ref. No.	—
plug with cable L 1000mm suitable for NOVASIT				
	GEV No.	101318	Ref. No.	—
cover cap for solenoid coil suitable for NOVASIT				
	GEV No.	101503	Ref. No.	—
O-ring EPDM thickness 2mm ID ø 32mm Qty 1 pcs				

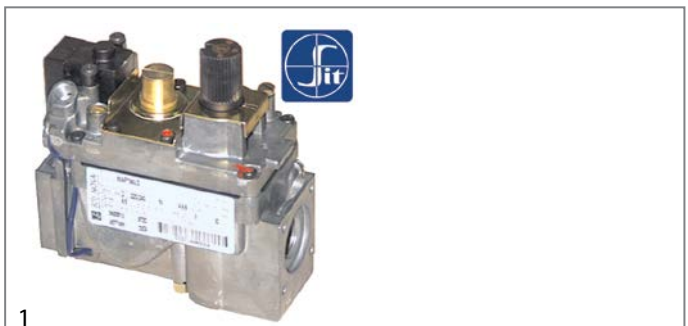

<b>GEV No.</b>	101162	<b>Ref. No.</b>	055446
<b>description</b>	gas valve SIT series Novasit 820 230V 50Hz gas inlet 1/2" gas outlet 1/2" thermocouple connection M9x1 pilot connection M10x1 ignition pressure 3-5mbar pressure range 3-30mbar pressure regulator connection blind equiv. no. 0.820.010		

<b>spare parts for</b>	101162		
------------------------	--------	--	--

	GEV No.	101065	Ref. No.	056589
magnet unit with cable L 44mm D1 ø 30mm D2 ø 20mm suitable for NOVASIT				

	GEV No.	101313	Ref. No.	0K3020
solenoid coil 230V 50Hz				

<b>accessories for</b>	101162		
------------------------	--------	--	--

	GEV No.	100006	Ref. No.	—
piezoelectric igniter suitable for ELETTROSIT body plastic blowing connection ø2.4mm ø 14mm				

	GEV No.	101305	Ref. No.	—
gas connection straight 1/2" flange 45x45mm ELETTROSIT/V4400/4600/4605 suitable for SIT/HONEYWELL hole distance 36x36mm				

	GEV No.	101306	Ref. No.	—
gas connection angled flange 45x45mm hole distance 36x36mm 1/2" ELETTROSIT/V4400/4600/4605 screw with O-ring suitable for SIT/HONEYWELL				

	GEV No.	101307	Ref. No.	—
gas connection straight flange 45x45mm hole distance 36x36mm 3/4" ELETTROSIT/V4400/4600/4605 screw with O-ring suitable for SIT/HONEYWELL				

	GEV No.	101308	Ref. No.	—
gas connection angled flange 45x45mm hole distance 36x36mm 3/4" ELETTROSIT/V4400/4600/4605 screw with O-ring suitable for SIT/HONEYWELL				

	GEV No.	101312	Ref. No.	054539
microswitch				

	GEV No.	101314	Ref. No.	—
solenoid coil 24V 50Hz				













	GEV No.	101317	Ref. No.	—
plug with cable L 1000mm suitable for NOVASIT				

Table continues overleaf















<b>accessories for</b>	101162
	GEV No. 101318 Ref. No. —
cover cap for solenoid coil suitable for NOVASIT	





<b>GEV No.</b>	101761	<b>Ref. No.</b>	003719
<b>description</b>	gas valve SIT series Novasit 820 230V 50Hz gas inlet 1/2" gas outlet 1/2" thermocouple connection M9x1 pilot connection M10x1 ignition pressure 3-5mbar pressure range 3-30mbar pressure regulator connection connection RP equiv. no. 0.820.034		
<b>spare parts for</b>	101761		
	GEV No. 101065	Ref. No.	056589
magnet unit with cable L 44mm D1 ø 30mm D2 ø 20mm suitable for NOVASIT			
	GEV No. 101313	Ref. No.	0K3020
solenoid coil 230V 50Hz			
<b>accessories for</b>	101761		
	GEV No. 100006	Ref. No.	—
piezoelectric igniter suitable for ELETTROSIT body plastic blowing connection ø2.4mm ø 14mm			
	GEV No. 101305	Ref. No.	—
gas connection straight 1/2" flange 45x45mm ELETTROSIT/V4400/4600/4605 suitable for SIT/HONEYWELL hole distance 36x36mm			
	GEV No. 101306	Ref. No.	—
gas connection angled flange 45x45mm hole distance 36x36mm 1/2" ELETTROSIT/V4400/4600/4605 screw with O-ring suitable for SIT/HONEYWELL			
	GEV No. 101307	Ref. No.	—
gas connection straight flange 45x45mm hole distance 36x36mm 3/4" ELETTROSIT/V4400/4600/4605 screw with O-ring suitable for SIT/HONEYWELL			
	GEV No. 101308	Ref. No.	—
gas connection angled flange 45x45mm hole distance 36x36mm 3/4" ELETTROSIT/V4400/4600/4605 screw with O-ring suitable for SIT/HONEYWELL			
	GEV No. 101312	Ref. No.	054539
microswitch			
	GEV No. 101314	Ref. No.	—
solenoid coil 24V 50Hz			
	GEV No. 101317	Ref. No.	—
plug with cable L 1000mm suitable for NOVASIT			
	GEV No. 101318	Ref. No.	—
cover cap for solenoid coil suitable for NOVASIT			



<b>GEV No.</b>	101956	<b>Ref. No.</b>	002903
<b>description</b>	gas valve SIT series Novasit 820 230V 50Hz gas inlet 1/2" gas outlet 1/2" thermocouple connection M9x1 pilot connection M10x1 ignition pressure 5-50mbar pressure range 5-50mbar pressure regulator connection blind equiv. no. 0.820.031		
<b>spare parts for</b>	101956		
	GEV No. 101065	Ref. No.	056589
magnet unit with cable L 44mm D1 ø 30mm D2 ø 20mm suitable for NOVASIT			
	GEV No. 101313	Ref. No.	0K3020
solenoid coil 230V 50Hz			
<b>accessories for</b>	101956		
	GEV No. 100006	Ref. No.	—
piezoelectric igniter suitable for ELETTROSIT body plastic blowing connection ø2.4mm ø 14mm			
	GEV No. 101305	Ref. No.	—
gas connection straight 1/2" flange 45x45mm ELETTROSIT/V4400/4600/4605 suitable for SIT/HONEYWELL hole distance 36x36mm			
	GEV No. 101306	Ref. No.	—
gas connection angled flange 45x45mm hole distance 36x36mm 1/2" ELETTROSIT/V4400/4600/4605 screw with O-ring suitable for SIT/HONEYWELL			
	GEV No. 101307	Ref. No.	—
gas connection straight flange 45x45mm hole distance 36x36mm 3/4" ELETTROSIT/V4400/4600/4605 screw with O-ring suitable for SIT/HONEYWELL			
	GEV No. 101308	Ref. No.	—
gas connection angled flange 45x45mm hole distance 36x36mm 3/4" ELETTROSIT/V4400/4600/4605 screw with O-ring suitable for SIT/HONEYWELL			
	GEV No. 101312	Ref. No.	054539
microswitch			
	GEV No. 101314	Ref. No.	—
solenoid coil 24V 50Hz			
	GEV No. 101317	Ref. No.	—
plug with cable L 1000mm suitable for NOVASIT			
	GEV No. 101318	Ref. No.	—
cover cap for solenoid coil suitable for NOVASIT			







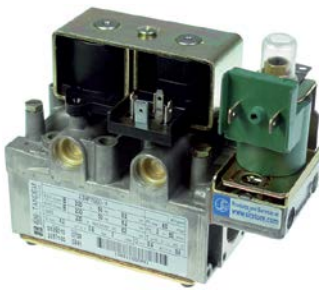

			
1			
<b>GEV No.</b>	101967	<b>Ref. No.</b>	059473
<b>description</b>	gas valve SIT series Novasit 822 230V 50Hz gas inlet 1/2" gas outlet 1/2" thermocouple connection pilot connection M10x1 ignition pressure 3-5mbar pressure range 3-30mbar pressure regulator connection perforated equiv. no. 0.822.110		
<b>spare parts for</b>	101967		
	<b>GEV No.</b>	101313	<b>Ref. No.</b> 0K3020
	solenoid coil 230V 50Hz		
	<b>GEV No.</b>	101542	<b>Ref. No.</b> —
	solenoid coil 50Hz NOVA 822/826/827 suitable for NOVASIT 230V		
<b>accessories for</b>	101967		
	<b>GEV No.</b>	100904	<b>Ref. No.</b> 052833
	locking screw M10x1 for pipe ø 4mm Qty 1 pcs		
	<b>GEV No.</b>	100905	<b>Ref. No.</b> —
	locking screw M10x1 for pipe ø 6mm Qty 1 pcs		
	<b>GEV No.</b>	101305	<b>Ref. No.</b> —
	gas connection straight 1/2" flange 45x45mm ELETTROSIT/V4400/4600/4605 suitable for SIT/HONEYWELL hole distance 36x36mm		
	<b>GEV No.</b>	101306	<b>Ref. No.</b> —
	gas connection angled flange 45x45mm hole distance 36x36mm 1/2" ELETTROSIT/V4400/4600/4605 screw with O-ring suitable for SIT/HONEYWELL		
	<b>GEV No.</b>	101307	<b>Ref. No.</b> —
	gas connection straight flange 45x45mm hole distance 36x36mm 3/4" ELETTROSIT/V4400/4600/4605 screw with O-ring suitable for SIT/HONEYWELL		
	<b>GEV No.</b>	101308	<b>Ref. No.</b> —
	gas connection angled flange 45x45mm hole distance 36x36mm 3/4" ELETTROSIT/V4400/4600/4605 screw with O-ring suitable for SIT/HONEYWELL		
	<b>GEV No.</b>	101503	<b>Ref. No.</b> —
	O-ring EPDM thickness 2mm ID ø 32mm Qty 1 pcs		
	<b>GEV No.</b>	101924	<b>Ref. No.</b> —
	plug with cable L 1090mm suitable for NOVA 822/826/827		

			
SIGMA			
1			
<b>GEV No.</b>	106009	<b>Ref. No.</b>	0C1057
<b>description</b>	gas valve 230V 50Hz gas inlet 3/4" gas outlet 3/4" pressure range 0.5-12mbar Sigma equiv. no. 0.848.037		
<b>spare parts for</b>	106009		
	<b>GEV No.</b>	106214	<b>Ref. No.</b> —
	solenoid coil 230V 50Hz Sigma		
<b>accessories for</b>	106009		
	<b>GEV No.</b>	107222	<b>Ref. No.</b> —
	plug for solenoid valve 3-pole cable length 1070mm		



			
1			
<b>GEV No.</b>	101989	<b>Ref. No.</b>	005757
<b>description</b>	gas valve 230V 50Hz gas inlet 3/4" gas outlet 3/4" SIT pressure range 2-50mbar equiv. no. 0.840.016		
<b>spare parts for</b>	101989		
	<b>GEV No.</b>	106214	<b>Ref. No.</b> —
	solenoid coil 230V 50Hz Sigma		
<b>accessories for</b>	101989		
	<b>GEV No.</b>	107222	<b>Ref. No.</b> —
	plug for solenoid valve 3-pole cable length 1070mm		











TANDEM			
			
1			
<b>GEV No.</b>	101984	<b>Ref. No.</b>	002714
<b>description</b>	gas valve 230V 50Hz gas inlet 1/2" gas outlet 1/2" pilot connection level slow ignition ignition times pressure range 2-50mbar power supply for modulator 230VAC rectified Tandem equiv. no. 0.836.010		
<b>spare parts for</b>	101984		
	<b>GEV No.</b>	101379	<b>Ref. No.</b> 002452
	solenoid coil 230V 50Hz suitable for Tandem		
<b>accessories for</b>	101984		
	<b>GEV No.</b>	101274	<b>Ref. No.</b> —
	olive for pipe ø 16mm Qty 1 pcs		
	<b>GEV No.</b>	101275	<b>Ref. No.</b> —
	union screw thread 1/2" for pipe ø 16mm Qty 1 pcs		
	<b>GEV No.</b>	101925	<b>Ref. No.</b> —
	plug with O-ring thread M10x1 for pilot burner suitable for NOVASIT		
	<b>GEV No.</b>	102845	<b>Ref. No.</b> —
	gas connection angled 1/2" flange 32x32mm hole distance 24x24mm Tandem		
	<b>GEV No.</b>	102846	<b>Ref. No.</b> —
	gas connection straight 1/2" flange 32x32mm hole distance 24x24mm suitable for Tandem		
	<b>GEV No.</b>	102847	<b>Ref. No.</b> —
	O-ring		

<b>accessories for</b>	101189		
	<b>GEV No.</b>	100905	<b>Ref. No.</b> —
	locking screw M10x1 for pipe ø 6mm Qty 1 pcs		
	<b>GEV No.</b>	101274	<b>Ref. No.</b> —
	olive for pipe ø 16mm Qty 1 pcs		
	<b>GEV No.</b>	101275	<b>Ref. No.</b> —
	union screw thread 1/2" for pipe ø 16mm Qty 1 pcs		
	<b>GEV No.</b>	101925	<b>Ref. No.</b> —
	plug with O-ring thread M10x1 for pilot burner suitable for NOVASIT		
	<b>GEV No.</b>	102845	<b>Ref. No.</b> —
	gas connection angled 1/2" flange 32x32mm hole distance 24x24mm Tandem		
	<b>GEV No.</b>	102846	<b>Ref. No.</b> —
	gas connection straight 1/2" flange 32x32mm hole distance 24x24mm suitable for Tandem		
	<b>GEV No.</b>	102847	<b>Ref. No.</b> —
	O-ring		

			
1			
<b>GEV No.</b>	101189	<b>Ref. No.</b>	002340
<b>description</b>	gas valve 230V 50Hz gas inlet 1/2" gas outlet 1/2" pilot connection M10x1 level slow ignition ignition times pressure range 3-50mbar power supply for modulator equiv. no. 0.830.040 suitable for Tandem		
<b>spare parts for</b>	101189		
	<b>GEV No.</b>	101379	<b>Ref. No.</b> 002452
	solenoid coil 230V 50Hz suitable for Tandem		
<b>accessories for</b>	101189		
	<b>GEV No.</b>	100904	<b>Ref. No.</b> 052833
	locking screw M10x1 for pipe ø 4mm Qty 1 pcs		

			
1			
<b>GEV No.</b>	106230	<b>Ref. No.</b>	005526
<b>description</b>	gas valve 24V 50Hz gas inlet 1/2" gas outlet 1/2" pilot connection M10x1 level slow ignition ignition times pressure range 3-50mbar power supply for modulator SIT equiv. no. 0.830.100		
<b>accessories for</b>	106230		
	<b>GEV No.</b>	101274	<b>Ref. No.</b> —
	olive for pipe ø 16mm Qty 1 pcs		
	<b>GEV No.</b>	101275	<b>Ref. No.</b> —
	union screw thread 1/2" for pipe ø 16mm Qty 1 pcs		
	<b>GEV No.</b>	101925	<b>Ref. No.</b> —
	plug with O-ring thread M10x1 for pilot burner suitable for NOVASIT		
	<b>GEV No.</b>	102845	<b>Ref. No.</b> —
	gas connection angled 1/2" flange 32x32mm hole distance 24x24mm Tandem		
	<b>GEV No.</b>	102846	<b>Ref. No.</b> —
	gas connection straight 1/2" flange 32x32mm hole distance 24x24mm suitable for Tandem		



ignition boxes

BRAHMA

BRAHMA



1	<b>GEV No.</b>	102340	<b>Ref. No.</b>	0A5167
<b>description</b> ignition box BRAHMA type SM191.1 electrodes 1 waiting time 1.5s safety time 10s 230V 7VA 50-60Hz				

HONEYWELL



1	<b>GEV No.</b>	101165	<b>Ref. No.</b>	002351
<b>description</b> ignition box HONEYWELL type S4560A 1008 equiv. no. S4560A 1008 electrodes 1 waiting time 0s safety time 10s 220-240V 10VA 50Hz				
<b>spare parts for</b> 101165				
	<b>GEV No.</b>	358696	<b>Ref. No.</b>	—
fine fuse size ø5x20mm 4A medium lag rated 250V Qty 10 pcs				



1	<b>GEV No.</b>	102347	<b>Ref. No.</b>	002641
<b>description</b> ignition box HONEYWELL type S4560M 1010 electrodes 1 waiting time 10s safety time 5s 220-240V 10VA 50Hz				

Honeywell



1	<b>GEV No.</b>	101184	<b>Ref. No.</b>	005924
<b>description</b> ignition box HONEYWELL type S4565C 1033 equiv. no. S4565C 1033 electrodes 2 waiting times safety time 5s 220-240V 4VA 50/60Hz				

SIT



1	<b>GEV No.</b>	101990	<b>Ref. No.</b>	005908
<b>description</b> ignition box SIT type 537ABC electrodes 3 waiting time 1.5s safety time 5s 230V 10VA 50-60Hz protection IP40				



1	<b>GEV No.</b>	102346	<b>Ref. No.</b>	0C1059
<b>description</b> ignition box SIT type 577DBC electrodes 2 waiting time 1.5s safety time 6s 220/240V 20VA 50/60Hz protection IP40				





safety valves

SIT

440 series





1

<b>GEV No.</b>	101100	<b>Ref. No.</b>	050106
<b>description</b>	gas valve pressure range 50mbar gas inlet 1/2" gas outlet 1/2" pilot connection M10x1 (tube ø 6mm) thermocouple connection M9x1 type 0.440.013		
<b>accessories for</b>	101100		
	<b>GEV No.</b>	100904	<b>Ref. No.</b> 052833
	locking screw M10x1 for pipe ø 4mm Qty 1 pcs		
	<b>GEV No.</b>	100905	<b>Ref. No.</b> —
	locking screw M10x1 for pipe ø 6mm Qty 1 pcs		



1

<b>GEV No.</b>	101101	<b>Ref. No.</b>	026888
<b>description</b>	gas valve pressure range 50mbar gas inlet 3/4" gas outlet 3/4" pilot connection M10x1 (tube ø 6mm) thermocouple connection M9x1 type SIT D3		
<b>accessories for</b>	101101		
	<b>GEV No.</b>	100904	<b>Ref. No.</b> 052833
	locking screw M10x1 for pipe ø 4mm Qty 1 pcs		
	<b>GEV No.</b>	100905	<b>Ref. No.</b> —
	locking screw M10x1 for pipe ø 6mm Qty 1 pcs		

gas solenoid valves

BRAHMA

BRAHMA



1

<b>GEV No.</b>	101948 <sup>1</sup>	<b>Ref. No.</b>	059509
<b>description</b>	solenoid valve 230VAC DN 15mm connection 1/2" L 72mm BRAHMA coil type 18811003 p max 0.5bar reg. no. 63AQ0626		
<b>spare parts for</b>	101948		
	<b>GEV No.</b>	101968	<b>Ref. No.</b> 005548
	solenoid valve 230VAC 20VA seat ø 17mm coil type 13902001 BRAHMA		

<sup>1</sup>aluminium housing

ignition parts

pilot burners

SIT

100 series



1





















<b>GEV No.</b>	107103	<b>Ref. No.</b>	0K9223
<b>description</b>	pilot burner SIT 1 flame nozzle ø 0.2mm gas connection 6mm		
<b>spare parts for</b>	107103		
	<b>GEV No.</b>	100245	<b>Ref. No.</b> 056799
	pilot burner nozzle LPG code 20 bore ø 0.2mm Qty 1 pcs thread M8x0.75		
	<b>GEV No.</b>	100885	<b>Ref. No.</b> —
	air mixing sleeve for pilot burner Qty 1 pcs		
	<b>GEV No.</b>	100916	<b>Ref. No.</b> —
	compression spring for pilot burner Qty 1 pcs		
	<b>GEV No.</b>	100917	<b>Ref. No.</b> —
	gasket for pilot burner Qty 1 pcs aluminium		
	<b>GEV No.</b>	100918	<b>Ref. No.</b> —
	screw for pilot burner		
	<b>GEV No.</b>	107160	<b>Ref. No.</b> —
	pilot burner cap SIT 1 flame Hmm Lmm Qty 1 pcs		

Table continues overleaf

<b>spare parts for</b> 107103				
	GEV No.	107166	Ref. No.	—
pilot burner head SIT 1 flame Hmm Lmm Qty 1 pcs				
	GEV No.	107701	Ref. No.	—
pilot burner bottom part SIT 100 series nozzle ø 0.2mm				
<b>accessories for</b> 107103				
	GEV No.	100246	Ref. No.	056656
pilot burner nozzle natural gas bore ø 0.35mm Qty 1 pcs thread M8x0.75				
	GEV No.	100904	Ref. No.	052833
locking screw M10x1 for pipe ø 4mm Qty 1 pcs				
	GEV No.	100905	Ref. No.	—
locking screw M10x1 for pipe ø 6mm Qty 1 pcs				
	GEV No.	102110	Ref. No.	054810
pilot tube copper pipe ø 4mm thickness 1mm L 3000mm				
	GEV No.	102111	Ref. No.	—
pilot tube copper pipe ø 6mm thickness 1mm L 3000mm				
	GEV No.	107171	Ref. No.	058330
pilot burner nozzle SIT natural/liquid gas bore ø 0.25mm Qty 1 pcs				
	GEV No.	107700	Ref. No.	052281
pilot burner bottom part SIT 100 series nozzle ø 0.25mm				
	GEV No.	107702	Ref. No.	052686
pilot burner bottom part SIT 100 series nozzle ø 0.35mm				

	1			
<b>GEV No.</b>	107138	<b>Ref. No.</b>	056751	
<b>description</b>	pilot burner SIT type 100 series 1 flame natural gas nozzle ø 0.35mm gas connectionmm			
<b>spare parts for</b> 107138				
	GEV No.	100245	Ref. No.	056799
pilot burner nozzle LPG code 20 bore ø 0.2mm Qty 1 pcs thread M8x0.75				
	GEV No.	100246	Ref. No.	056656
pilot burner nozzle natural gas bore ø 0.35mm Qty 1 pcs thread M8x0.75				
	GEV No.	100916	Ref. No.	—
compression spring for pilot burner Qty 1 pcs				
	GEV No.	100917	Ref. No.	—
gasket for pilot burner Qty 1 pcs aluminium				
	GEV No.	100918	Ref. No.	—
screw for pilot burner				
	GEV No.	107171	Ref. No.	058330
pilot burner nozzle SIT natural/liquid gas bore ø 0.25mm Qty 1 pcs				

<b>accessories for</b> 107138				
	GEV No.	100904	Ref. No.	052833
locking screw M10x1 for pipe ø 4mm Qty 1 pcs				
	GEV No.	100905	Ref. No.	—
locking screw M10x1 for pipe ø 6mm Qty 1 pcs				
	GEV No.	102110	Ref. No.	054810
pilot tube copper pipe ø 4mm thickness 1mm L 3000mm				
	GEV No.	102111	Ref. No.	—
pilot tube copper pipe ø 6mm thickness 1mm L 3000mm				



































	1			
<b>GEV No.</b>	106902	<b>Ref. No.</b>	029776	
<b>description</b>	pilot burner SIT type 100 series 2 flames nozzle ø 0.2mm gas connection 6mm			
<b>spare parts for</b> 106902				
	GEV No.	100245	Ref. No.	056799
pilot burner nozzle LPG code 20 bore ø 0.2mm Qty 1 pcs thread M8x0.75				
	GEV No.	100842	Ref. No.	—
pilot burner cap 2 flames Qty 1 pcs				
	GEV No.	100885	Ref. No.	—
air mixing sleeve for pilot burner Qty 1 pcs				
	GEV No.	100916	Ref. No.	—
compression spring for pilot burner Qty 1 pcs				
	GEV No.	100917	Ref. No.	—
gasket for pilot burner Qty 1 pcs aluminium				
	GEV No.	100918	Ref. No.	—
screw for pilot burner				
	GEV No.	107161	Ref. No.	—
pilot burner cap SIT 2 flames Hmm Lmm Qty 1 pcs				
	GEV No.	107701	Ref. No.	—
pilot burner bottom part SIT 100 series nozzle ø 0.2mm				
<b>accessories for</b> 106902				
	GEV No.	100246	Ref. No.	056656
pilot burner nozzle natural gas bore ø 0.35mm Qty 1 pcs thread M8x0.75				
	GEV No.	100904	Ref. No.	052833
locking screw M10x1 for pipe ø 4mm Qty 1 pcs				
	GEV No.	100905	Ref. No.	—
locking screw M10x1 for pipe ø 6mm Qty 1 pcs				

Table continues overleaf



accessories for		106902	
	GEV No.	102110	Ref. No. 054810
pilot tube copper pipe ø 4mm thickness 1mm L 3000mm			
	GEV No.	102111	Ref. No. —
pilot tube copper pipe ø 6mm thickness 1mm L 3000mm			
	GEV No.	107171	Ref. No. 058330
pilot burner nozzle SIT natural/liquid gas bore ø 0.25mm Qty 1 pcs			
	GEV No.	107700	Ref. No. 052281
pilot burner bottom part SIT 100 series nozzle ø 0.25mm			
	GEV No.	107702	Ref. No. 052686
pilot burner bottom part SIT 100 series nozzle ø 0.35mm			

 <p>1</p>			
<b>GEV No.</b>	106903	<b>Ref. No.</b>	020152
<b>description</b>	pilot burner SIT type 100 series 3 flames nozzle ø 0.2mm gas connection 6mm		
<b>spare parts for</b>	106903		
	GEV No.	100245	Ref. No. 056799
pilot burner nozzle LPG code 20 bore ø 0.2mm Qty 1 pcs thread M8x0.75			
	GEV No.	100854	Ref. No. 052256
pilot burner bracket double			
	GEV No.	100885	Ref. No. —
air mixing sleeve for pilot burner Qty 1 pcs			
	GEV No.	100916	Ref. No. —
compression spring for pilot burner Qty 1 pcs			
	GEV No.	100917	Ref. No. —
gasket for pilot burner Qty 1 pcs aluminium			
	GEV No.	100918	Ref. No. —
screw for pilot burner			
	GEV No.	107162	Ref. No. —
pilot burner cap SIT 3 flames Hmm Lmm Qty 1 pcs			
	GEV No.	107701	Ref. No. —
pilot burner bottom part SIT 100 series nozzle ø 0.2mm			
<b>accessories for</b>	106903		
	GEV No.	100245	Ref. No. 056799
pilot burner nozzle LPG code 20 bore ø 0.2mm Qty 1 pcs thread M8x0.75			
	GEV No.	100246	Ref. No. 056656
pilot burner nozzle natural gas bore ø 0.35mm Qty 1 pcs thread M8x0.75			
	GEV No.	100904	Ref. No. 052833
locking screw M10x1 for pipe ø 4mm Qty 1 pcs			

accessories for		106903	
	GEV No.	100905	Ref. No. —
locking screw M10x1 for pipe ø 6mm Qty 1 pcs			
	GEV No.	102110	Ref. No. 054810
pilot tube copper pipe ø 4mm thickness 1mm L 3000mm			
	GEV No.	102111	Ref. No. —
pilot tube copper pipe ø 6mm thickness 1mm L 3000mm			
	GEV No.	107171	Ref. No. 058330
pilot burner nozzle SIT natural/liquid gas bore ø 0.25mm Qty 1 pcs			
	GEV No.	107700	Ref. No. 052281
pilot burner bottom part SIT 100 series nozzle ø 0.25mm			
	GEV No.	107702	Ref. No. 052686
pilot burner bottom part SIT 100 series nozzle ø 0.35mm			

















 <p>1</p>			
<b>GEV No.</b>	106906	<b>Ref. No.</b>	0H6331
<b>description</b>	pilot burner SIT type 100 series 3 flames nozzle ø 0.2mm gas connection 6mm		
<b>spare parts for</b>	106906		
	GEV No.	100245	Ref. No. 056799
pilot burner nozzle LPG code 20 bore ø 0.2mm Qty 1 pcs thread M8x0.75			
	GEV No.	100855	Ref. No. 005618
pilot burner bracket triple			
	GEV No.	100885	Ref. No. —
air mixing sleeve for pilot burner Qty 1 pcs			
	GEV No.	100916	Ref. No. —
compression spring for pilot burner Qty 1 pcs			
	GEV No.	100917	Ref. No. —
gasket for pilot burner Qty 1 pcs aluminium			
	GEV No.	100918	Ref. No. —
screw for pilot burner			
	GEV No.	107162	Ref. No. —
pilot burner cap SIT 3 flames Hmm Lmm Qty 1 pcs			
	GEV No.	107701	Ref. No. —
pilot burner bottom part SIT 100 series nozzle ø 0.2mm			
<b>accessories for</b>	106906		
	GEV No.	100245	Ref. No. 056799
pilot burner nozzle LPG code 20 bore ø 0.2mm Qty 1 pcs thread M8x0.75			

Table continues overleaf



accessories for		106906		
	GEV No.	100246	Ref. No.	056656
	pilot burner nozzle natural gas bore ø 0.35mm Qty 1 pcs thread M8x0.75			
	GEV No.	100904	Ref. No.	052833
	locking screw M10x1 for pipe ø 4mm Qty 1 pcs			
	GEV No.	100905	Ref. No.	—
	locking screw M10x1 for pipe ø 6mm Qty 1 pcs			
	GEV No.	102110	Ref. No.	054810
	pilot tube copper pipe ø 4mm thickness 1mm L 3000mm			
	GEV No.	102111	Ref. No.	—
	pilot tube copper pipe ø 6mm thickness 1mm L 3000mm			
	GEV No.	107171	Ref. No.	058330
	pilot burner nozzle SIT natural/liquid gas bore ø 0.25mm Qty 1 pcs			
	GEV No.	107700	Ref. No.	052281
	pilot burner bottom part SIT 100 series nozzle ø 0.25mm			
	GEV No.	107702	Ref. No.	052686
	pilot burner bottom part SIT 100 series nozzle ø 0.35mm			

				
1				
<b>GEV No.</b>	106907	<b>Ref. No.</b>	058329	
<b>description</b>	pilot burner SIT type 100 series 3 flames nozzle ø 0.35mm gas connection 6mm			
<b>spare parts for</b>	106907			
	GEV No.	100246	Ref. No.	056656
	pilot burner nozzle natural gas bore ø 0.35mm Qty 1 pcs thread M8x0.75			
	GEV No.	100855	Ref. No.	005618
	pilot burner bracket triple			
	GEV No.	100885	Ref. No.	—
	air mixing sleeve for pilot burner Qty 1 pcs			
	GEV No.	100916	Ref. No.	—
	compression spring for pilot burner Qty 1 pcs			
	GEV No.	100917	Ref. No.	—
	gasket for pilot burner Qty 1 pcs aluminium			
	GEV No.	100918	Ref. No.	—
	screw for pilot burner			
	GEV No.	107162	Ref. No.	—
	pilot burner cap SIT 3 flames Hmm Lmm Qty 1 pcs			
	GEV No.	107702	Ref. No.	052686
	pilot burner bottom part SIT 100 series nozzle ø 0.35mm			

accessories for		106907		
	GEV No.	100245	Ref. No.	056799
	pilot burner nozzle LPG code 20 bore ø 0.2mm Qty 1 pcs thread M8x0.75			
	GEV No.	100904	Ref. No.	052833
	locking screw M10x1 for pipe ø 4mm Qty 1 pcs			
	GEV No.	100905	Ref. No.	—
	locking screw M10x1 for pipe ø 6mm Qty 1 pcs			
	GEV No.	102110	Ref. No.	054810
	pilot tube copper pipe ø 4mm thickness 1mm L 3000mm			
	GEV No.	102111	Ref. No.	—
	pilot tube copper pipe ø 6mm thickness 1mm L 3000mm			
	GEV No.	107171	Ref. No.	058330
	pilot burner nozzle SIT natural/liquid gas bore ø 0.25mm Qty 1 pcs			
	GEV No.	107700	Ref. No.	052281
	pilot burner bottom part SIT 100 series nozzle ø 0.25mm			
	GEV No.	107701	Ref. No.	—
	pilot burner bottom part SIT 100 series nozzle ø 0.2mm			

accessories

pilot burner caps



				
1				
<b>GEV No.</b>	102816	<b>Ref. No.</b>	003394	
<b>description</b>	pilot burner cap 3 flames suitable for 100 series H 25mm L 64mm			

				
1				
<b>GEV No.</b>	102662	<b>Ref. No.</b>	003328	
<b>description</b>	pilot burner cap 3 flames suitable for 100 series H 28mm L 55mm Qty 1 pcs			

				
1				
<b>GEV No.</b>	102665	<b>Ref. No.</b>	006128	
<b>description</b>	pilot burner cap 3 flames suitable for 100 series H 28mm L 87mm Qty 1 pcs			



			
1			
<b>GEV No.</b>	102664	<b>Ref. No.</b>	059301
<b>description</b>	pilot burner cap 3 flames suitable for 100 series H 29mm L 40mm		

			
1			
<b>GEV No.</b>	102663	<b>Ref. No.</b>	0A5441
<b>description</b>	pilot burner cap 3 flames suitable for 100 series H 29mm L 64mm Qty 1 pcs		
<b>accessories for</b>	102663		
	<b>GEV No.</b>	100885	<b>Ref. No.</b> —
	air mixing sleeve for pilot burner Qty 1 pcs		

			
1			
<b>GEV No.</b>	100836	<b>Ref. No.</b>	052280
<b>description</b>	pilot burner cap 3 flames suitable for 100 series H 30mm L 48mm		

pilot burner bottom parts			
			
1			
<b>GEV No.</b>	107700	<b>Ref. No.</b>	052281
<b>description</b>	pilot burner bottom part SIT 100 series nozzle ø 0.25mm		
<b>spare parts for</b>	107700		
	<b>GEV No.</b>	100916	<b>Ref. No.</b> —
	compression spring for pilot burner Qty 1 pcs		
	<b>GEV No.</b>	100917	<b>Ref. No.</b> —
	gasket for pilot burner Qty 1 pcs aluminium		
	<b>GEV No.</b>	100918	<b>Ref. No.</b> —
	screw for pilot burner		
	<b>GEV No.</b>	102742	<b>Ref. No.</b> —
	pilot burner nozzle LPG code 25 bore ø 0.25mm Qty 1 pcs		

<b>accessories for</b>	107700		
	<b>GEV No.</b>	100245	<b>Ref. No.</b> 056799
	pilot burner nozzle LPG code 20 bore ø 0.2mm Qty 1 pcs thread M8x0.75		
	<b>GEV No.</b>	100246	<b>Ref. No.</b> 056656
	pilot burner nozzle natural gas bore ø 0.35mm Qty 1 pcs thread M8x0.75		
	<b>GEV No.</b>	100904	<b>Ref. No.</b> 052833
	locking screw M10x1 for pipe ø 4mm Qty 1 pcs		
	<b>GEV No.</b>	100905	<b>Ref. No.</b> —
	locking screw M10x1 for pipe ø 6mm Qty 1 pcs		
	<b>GEV No.</b>	102110	<b>Ref. No.</b> 054810
	pilot tube copper pipe ø 4mm thickness 1mm L 3000mm		
	<b>GEV No.</b>	102111	<b>Ref. No.</b> —
	pilot tube copper pipe ø 6mm thickness 1mm L 3000mm		

			
1			
<b>GEV No.</b>	107702	<b>Ref. No.</b>	052686
<b>description</b>	pilot burner bottom part SIT 100 series nozzle ø 0.35mm		
<b>spare parts for</b>	107702		
	<b>GEV No.</b>	100246	<b>Ref. No.</b> 056656
	pilot burner nozzle natural gas bore ø 0.35mm Qty 1 pcs thread M8x0.75		
	<b>GEV No.</b>	100916	<b>Ref. No.</b> —
	compression spring for pilot burner Qty 1 pcs		
	<b>GEV No.</b>	100917	<b>Ref. No.</b> —
	gasket for pilot burner Qty 1 pcs aluminium		
	<b>GEV No.</b>	100918	<b>Ref. No.</b> —
	screw for pilot burner		
<b>accessories for</b>	107702		
	<b>GEV No.</b>	100245	<b>Ref. No.</b> 056799
	pilot burner nozzle LPG code 20 bore ø 0.2mm Qty 1 pcs thread M8x0.75		
	<b>GEV No.</b>	100904	<b>Ref. No.</b> 052833
	locking screw M10x1 for pipe ø 4mm Qty 1 pcs		
	<b>GEV No.</b>	100905	<b>Ref. No.</b> —
	locking screw M10x1 for pipe ø 6mm Qty 1 pcs		
	<b>GEV No.</b>	102110	<b>Ref. No.</b> 054810
	pilot tube copper pipe ø 4mm thickness 1mm L 3000mm		
	<b>GEV No.</b>	102111	<b>Ref. No.</b> —
	pilot tube copper pipe ø 6mm thickness 1mm L 3000mm		
	<b>GEV No.</b>	102742	<b>Ref. No.</b> —
	pilot burner nozzle LPG code 25 bore ø 0.25mm Qty 1 pcs		







			
1			
<b>GEV No.</b>	100880	<b>Ref. No.</b>	006725
<b>description</b>	pilot burner bottom part SIT 100 series nozzle $\phi$ 0.4mm		

pilot burner brackets

universal

			
1			
<b>GEV No.</b>	100854	<b>Ref. No.</b>	052256
<b>description</b>	pilot burner bracket double		

			
1			
<b>GEV No.</b>	100855	<b>Ref. No.</b>	005618
<b>description</b>	pilot burner bracket triple		
<b>accessories for</b>	100855		
	<b>GEV No.</b>	100855	<b>Ref. No.</b> 005618
	pilot burner bracket triple		
	<b>GEV No.</b>	100886	<b>Ref. No.</b> —
	pilot burner bracket suitable for 100 series 3-piece		
	<b>GEV No.</b>	100888	<b>Ref. No.</b> —
	screw bolt for pilot burner		

pilot burner nozzles

			
1			
<b>GEV No.</b>	100245	<b>Ref. No.</b>	056799
<b>description</b>	pilot burner nozzle LPG code 20 bore $\phi$ 0.2mm Qty 1 pcs thread M8x0.75		

			
1			
<b>GEV No.</b>	100246	<b>Ref. No.</b>	056656
<b>description</b>	pilot burner nozzle natural gas bore $\phi$ 0.35mm Qty 1 pcs thread M8x0.75		

ignition electrodes

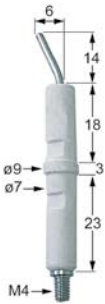
			
1			
<b>GEV No.</b>	100706	<b>Ref. No.</b>	056754
<b>description</b>	ignition electrode connection M4 Qty 1 pcs		

miscellaneous

			
1			
<b>GEV No.</b>	101343	<b>Ref. No.</b>	056579
<b>description</b>	bolt for pilot burner		

			
1			
<b>GEV No.</b>	101342	<b>Ref. No.</b>	056580
<b>description</b>	cover for pilot burner		

140 - 145 -150 series







			
1			
<b>GEV No.</b>	100126	<b>Ref. No.</b>	002055
<b>description</b>	pilot burner SIT type 140 series 1 flame nozzle $\phi$ mm gas connectionmm		
<b>accessories for</b>	100126		
	<b>GEV No.</b>	100204	<b>Ref. No.</b> 059216
	pilot burner nozzle SIT LPG code 14 bore $\phi$ 0.18/0.20mm Qty 1 pcs suitable for 140 series		
	<b>GEV No.</b>	100205	<b>Ref. No.</b> —
	pilot burner nozzle SIT LPG code 19 bore $\phi$ 0.23/0.26mm Qty 1 pcs suitable for SIT 150 series		
	<b>GEV No.</b>	100206	<b>Ref. No.</b> —
	pilot burner nozzle SIT natural gas code 36 bore $\phi$ 0.60/0.55mm Qty 1 pcs suitable for SIT 150 series		
	<b>GEV No.</b>	100207	<b>Ref. No.</b> 059215
	pilot burner nozzle SIT natural gas code 27 bore $\phi$ 0.40/0.38mm suitable for SIT 140 series		
	<b>GEV No.</b>	100216	<b>Ref. No.</b> —
	pilot burner nozzle SIT natural gas code 38 bore $\phi$ 0.45mm Qty 1 pcs suitable for SIT 150 series		
	<b>GEV No.</b>	100701	<b>Ref. No.</b> 059380
	ignition electrode connection M4 Qty 1 pcs		

Table continues overleaf





<b>accessories for</b>	100126		
	GEV No.	100897	Ref. No. 059161
	olive for pipe ø 4mm Qty 1 pcs for pilot burner		
	GEV No.	100898	Ref. No. —
	olive for pipe ø 6mm Qty 1 pcs for pilot burner		
	GEV No.	100906	Ref. No. 057960
	screw connection thread M10x1 for ignition electrode brass Qty 1 pcs WS 10		
	GEV No.	100907	Ref. No. 0C0121
	screw connection thread M10x1 Qty 1 pcs type SEF 1 ømm for thermocouple		
	GEV No.	100908	Ref. No. 052125
	union screw thread M10x1 for pipe ø 4mm Qty 1 pcs		
	GEV No.	100909	Ref. No. —
	union screw thread M10x1 for pipe ø 6mm Qty 1 pcs		















	1		
<b>GEV No.</b>	107134	<b>Ref. No.</b>	005503
<b>description</b>	pilot burner SIT type 140 series 1 flame nozzle ømm gas connectionmm		
<b>accessories for</b>	107134		
	GEV No.	100204	Ref. No. 059216
	pilot burner nozzle SIT LPG code 14 bore ø 0.18/0.20mm Qty 1 pcs suitable for 140 series		
	GEV No.	100205	Ref. No. —
	pilot burner nozzle SIT LPG code 19 bore ø 0.23/0.26mm Qty 1 pcs suitable for SIT 150 series		
	GEV No.	100206	Ref. No. —
	pilot burner nozzle SIT natural gas code 36 bore ø 0.60/0.55mm Qty 1 pcs suitable for SIT 150 series		
	GEV No.	100207	Ref. No. 059215
	pilot burner nozzle SIT natural gas code 27 bore ø 0.40/0.38mm suitable for SIT 140 series		
	GEV No.	100216	Ref. No. —
	pilot burner nozzle SIT natural gas code 38 bore ø 0.45mm Qty 1 pcs suitable for SIT 150 series		
	GEV No.	100701	Ref. No. 059380
	ignition electrode connection M4 Qty 1 pcs		
	GEV No.	100897	Ref. No. 059161
	olive for pipe ø 4mm Qty 1 pcs for pilot burner		
	GEV No.	100898	Ref. No. —
	olive for pipe ø 6mm Qty 1 pcs for pilot burner		
	GEV No.	100906	Ref. No. 057960
	screw connection thread M10x1 for ignition electrode brass Qty 1 pcs WS 10		
	GEV No.	100907	Ref. No. 0C0121
	screw connection thread M10x1 Qty 1 pcs type SEF 1 ømm for thermocouple		
	GEV No.	100908	Ref. No. 052125
	union screw thread M10x1 for pipe ø 4mm Qty 1 pcs		

<b>accessories for</b>	107134		
	GEV No.	100909	Ref. No. —
	union screw thread M10x1 for pipe ø 6mm Qty 1 pcs		















	1		
<b>GEV No.</b>	100094	<b>Ref. No.</b>	059214
<b>description</b>	pilot burner SIT type 140 series 1 flame nozzle ømm gas connectionmm for thermocouple ø 5mm		
<b>accessories for</b>	100094		
	GEV No.	100182	Ref. No. 003547
	cover for pilot burner Qty 1 pcs		
	GEV No.	100204	Ref. No. 059216
	pilot burner nozzle SIT LPG code 14 bore ø 0.18/0.20mm Qty 1 pcs suitable for 140 series		
	GEV No.	100205	Ref. No. —
	pilot burner nozzle SIT LPG code 19 bore ø 0.23/0.26mm Qty 1 pcs suitable for SIT 150 series		
	GEV No.	100206	Ref. No. —
	pilot burner nozzle SIT natural gas code 36 bore ø 0.60/0.55mm Qty 1 pcs suitable for SIT 150 series		
	GEV No.	100207	Ref. No. 059215
	pilot burner nozzle SIT natural gas code 27 bore ø 0.40/0.38mm suitable for SIT 140 series		
	GEV No.	100216	Ref. No. —
	pilot burner nozzle SIT natural gas code 38 bore ø 0.45mm Qty 1 pcs suitable for SIT 150 series		
	GEV No.	100897	Ref. No. 059161
	olive for pipe ø 4mm Qty 1 pcs for pilot burner		
	GEV No.	100898	Ref. No. —
	olive for pipe ø 6mm Qty 1 pcs for pilot burner		
	GEV No.	100908	Ref. No. 052125
	union screw thread M10x1 for pipe ø 4mm Qty 1 pcs		
	GEV No.	100909	Ref. No. —
	union screw thread M10x1 for pipe ø 6mm Qty 1 pcs		
	GEV No.	102110	Ref. No. 054810
	pilot tube copper pipe ø 4mm thickness 1mm L 3000mm		
	GEV No.	102111	Ref. No. —
	pilot tube copper pipe ø 6mm thickness 1mm L 3000mm		

			
<b>GEV No.</b>	107114 <sup>1</sup>	<b>Ref. No.</b>	059379
<b>description</b>	pilot burner SIT type 140 series 2 flames nozzle ømm gas connectionmm		
<b>spare parts for</b>	107114		
	<b>GEV No.</b>	100907	<b>Ref. No.</b> 0C0121
	screw connection thread M10x1 Qty 1 pcs type SEF 1 ømm for thermocouple		
<b>accessories for</b>	107114		
	<b>GEV No.</b>	100204	<b>Ref. No.</b> 059216
	pilot burner nozzle SIT LPG code 14 bore ø 0.18/0.20mm Qty 1 pcs suitable for 140 series		
	<b>GEV No.</b>	100205	<b>Ref. No.</b> —
	pilot burner nozzle SIT LPG code 19 bore ø 0.23/0.26mm Qty 1 pcs suitable for SIT 150 series		
	<b>GEV No.</b>	100206	<b>Ref. No.</b> —
	pilot burner nozzle SIT natural gas code 36 bore ø 0.60/0.55mm Qty 1 pcs suitable for SIT 150 series		
	<b>GEV No.</b>	100207	<b>Ref. No.</b> 059215
	pilot burner nozzle SIT natural gas code 27 bore ø 0.40/0.38mm suitable for SIT 140 series		
	<b>GEV No.</b>	100216	<b>Ref. No.</b> —
	pilot burner nozzle SIT natural gas code 38 bore ø 0.45mm Qty 1 pcs suitable for SIT 150 series		
	<b>GEV No.</b>	100701	<b>Ref. No.</b> 059380
	ignition electrode connection M4 Qty 1 pcs		
	<b>GEV No.</b>	100801	<b>Ref. No.</b> —
	gasket for pilot burner Qty 1 pcs		
	<b>GEV No.</b>	100897	<b>Ref. No.</b> 059161
	olive for pipe ø 4mm Qty 1 pcs for pilot burner		
	<b>GEV No.</b>	100898	<b>Ref. No.</b> —
	olive for pipe ø 6mm Qty 1 pcs for pilot burner		
	<b>GEV No.</b>	100906	<b>Ref. No.</b> 057960
	screw connection thread M10x1 for ignition electrode brass Qty 1 pcs WS 10		
	<b>GEV No.</b>	100908	<b>Ref. No.</b> 052125
	union screw thread M10x1 for pipe ø 4mm Qty 1 pcs		
	<b>GEV No.</b>	100909	<b>Ref. No.</b> —
	union screw thread M10x1 for pipe ø 6mm Qty 1 pcs		
	<b>GEV No.</b>	102110	<b>Ref. No.</b> 054810
	pilot tube copper pipe ø 4mm thickness 1mm L 3000mm		
	<b>GEV No.</b>	102111	<b>Ref. No.</b> —
	pilot tube copper pipe ø 6mm thickness 1mm L 3000mm		













<sup>1</sup>incl. thermocouple fitting



160 series			
			
<b>GEV No.</b>	100109	<b>Ref. No.</b>	0A2472
<b>description</b>	pilot burner SIT type 160 series 1 flame nozzle ømm gas connectionmm		
<b>spare parts for</b>	100109		
	<b>GEV No.</b>	100907	<b>Ref. No.</b> 0C0121
	screw connection thread M10x1 Qty 1 pcs type SEF 1 ømm for thermocouple		
<b>accessories for</b>	100109		
	<b>GEV No.</b>	100202	<b>Ref. No.</b> —
	pilot burner nozzle natural gas code 41 Qty 1 pcs nozzle ø 0.41mm		
	<b>GEV No.</b>	100203	<b>Ref. No.</b> —
	pilot burner nozzle LPG code 25 Qty 1 pcs nozzle ø 0.25mm		
	<b>GEV No.</b>	100701	<b>Ref. No.</b> 059380
	ignition electrode connection M4 Qty 1 pcs		
	<b>GEV No.</b>	100801	<b>Ref. No.</b> —
	gasket for pilot burner Qty 1 pcs		
	<b>GEV No.</b>	100869	<b>Ref. No.</b> —
	pilot burner nozzle natural gas code 51 Qty 1 pcs suitable for 160 series nozzle ø 0.51mm		
	<b>GEV No.</b>	100906	<b>Ref. No.</b> 057960
	screw connection thread M10x1 for ignition electrode brass Qty 1 pcs WS 10		
	<b>GEV No.</b>	100908	<b>Ref. No.</b> 052125
	union screw thread M10x1 for pipe ø 4mm Qty 1 pcs		
	<b>GEV No.</b>	100909	<b>Ref. No.</b> —
	union screw thread M10x1 for pipe ø 6mm Qty 1 pcs		
	<b>GEV No.</b>	101282	<b>Ref. No.</b> —
	olive for pipe ø 4mm L 7.4mm Qty 1 pcs		
	<b>GEV No.</b>	101287	<b>Ref. No.</b> —
	olive for pipe ø 6mm Qty 1 pcs		
	<b>GEV No.</b>	102110	<b>Ref. No.</b> 054810
	pilot tube copper pipe ø 4mm thickness 1mm L 3000mm		
	<b>GEV No.</b>	102111	<b>Ref. No.</b> —
	pilot tube copper pipe ø 6mm thickness 1mm L 3000mm		
	<b>GEV No.</b>	107650	<b>Ref. No.</b> —
	pilot burner nozzle SIT LPG code 30 Qty 1 pcs		













			
1			
<b>GEV No.</b>	100054	<b>Ref. No.</b>	003204
<b>description</b>	pilot burner SIT type 160 series 2 flames nozzle $\varnothing$ mm gas connectionmm		
<b>spare parts for</b>	100054		
	<b>GEV No.</b>	100907	<b>Ref. No.</b> 0C0121
	screw connection thread M10x1 Qty 1 pcs type SEF 1 $\varnothing$ mm for thermocouple		
<b>accessories for</b>	100054		
	<b>GEV No.</b>	100202	<b>Ref. No.</b> —
	pilot burner nozzle natural gas code 41 Qty 1 pcs nozzle $\varnothing$ 0.41mm		
	<b>GEV No.</b>	100203	<b>Ref. No.</b> —
	pilot burner nozzle LPG code 25 Qty 1 pcs nozzle $\varnothing$ 0.25mm		
	<b>GEV No.</b>	100701	<b>Ref. No.</b> 059380
	ignition electrode connection M4 Qty 1 pcs		
	<b>GEV No.</b>	100801	<b>Ref. No.</b> —
	gasket for pilot burner Qty 1 pcs		
	<b>GEV No.</b>	100869	<b>Ref. No.</b> —
	pilot burner nozzle natural gas code 51 Qty 1 pcs suitable for 160 series nozzle $\varnothing$ 0.51mm		
	<b>GEV No.</b>	100906	<b>Ref. No.</b> 057960
	screw connection thread M10x1 for ignition electrode brass Qty 1 pcs WS 10		
	<b>GEV No.</b>	100908	<b>Ref. No.</b> 052125
	union screw thread M10x1 for pipe $\varnothing$ 4mm Qty 1 pcs		
	<b>GEV No.</b>	100909	<b>Ref. No.</b> —
	union screw thread M10x1 for pipe $\varnothing$ 6mm Qty 1 pcs		
	<b>GEV No.</b>	101282	<b>Ref. No.</b> —
	olive for pipe $\varnothing$ 4mm L 7.4mm Qty 1 pcs		
	<b>GEV No.</b>	101287	<b>Ref. No.</b> —
	olive for pipe $\varnothing$ 6mm Qty 1 pcs		
	<b>GEV No.</b>	102110	<b>Ref. No.</b> 054810
	pilot tube copper pipe $\varnothing$ 4mm thickness 1mm L 3000mm		
	<b>GEV No.</b>	102111	<b>Ref. No.</b> —
	pilot tube copper pipe $\varnothing$ 6mm thickness 1mm L 3000mm		
	<b>GEV No.</b>	107650	<b>Ref. No.</b> —
	pilot burner nozzle SIT LPG code 30 Qty 1 pcs		

			
1			
<b>GEV No.</b>	100056	<b>Ref. No.</b>	058146
<b>description</b>	pilot burner SIT type 160 series 3 flames nozzle $\varnothing$ mm gas connectionmm		
<b>spare parts for</b>	100056		
	<b>GEV No.</b>	100907	<b>Ref. No.</b> 0C0121
	screw connection thread M10x1 Qty 1 pcs type SEF 1 $\varnothing$ mm for thermocouple		
<b>accessories for</b>	100056		
	<b>GEV No.</b>	100202	<b>Ref. No.</b> —
	pilot burner nozzle natural gas code 41 Qty 1 pcs nozzle $\varnothing$ 0.41mm		
	<b>GEV No.</b>	100203	<b>Ref. No.</b> —
	pilot burner nozzle LPG code 25 Qty 1 pcs nozzle $\varnothing$ 0.25mm		
	<b>GEV No.</b>	100701	<b>Ref. No.</b> 059380
	ignition electrode connection M4 Qty 1 pcs		
	<b>GEV No.</b>	100801	<b>Ref. No.</b> —
	gasket for pilot burner Qty 1 pcs		
	<b>GEV No.</b>	100869	<b>Ref. No.</b> —
	pilot burner nozzle natural gas code 51 Qty 1 pcs suitable for 160 series nozzle $\varnothing$ 0.51mm		
	<b>GEV No.</b>	100870	<b>Ref. No.</b> 053665
	olive for pipe $\varnothing$ 4mm Qty 1 pcs suitable for 160 series for pilot burner		
	<b>GEV No.</b>	100906	<b>Ref. No.</b> 057960
	screw connection thread M10x1 for ignition electrode brass Qty 1 pcs WS 10		
	<b>GEV No.</b>	100908	<b>Ref. No.</b> 052125
	union screw thread M10x1 for pipe $\varnothing$ 4mm Qty 1 pcs		
	<b>GEV No.</b>	100909	<b>Ref. No.</b> —
	union screw thread M10x1 for pipe $\varnothing$ 6mm Qty 1 pcs		
	<b>GEV No.</b>	101287	<b>Ref. No.</b> —
	olive for pipe $\varnothing$ 6mm Qty 1 pcs		
	<b>GEV No.</b>	102110	<b>Ref. No.</b> 054810
	pilot tube copper pipe $\varnothing$ 4mm thickness 1mm L 3000mm		
	<b>GEV No.</b>	102111	<b>Ref. No.</b> —
	pilot tube copper pipe $\varnothing$ 6mm thickness 1mm L 3000mm		
	<b>GEV No.</b>	107650	<b>Ref. No.</b> —
	pilot burner nozzle SIT LPG code 30 Qty 1 pcs		

 <p>1</p>			
<b>GEV No.</b>	101898	<b>Ref. No.</b>	0C0744
<b>description</b>	pilot burner SIT type 160 series 3 flames nozzle ømm gas connectionmm		
<b>spare parts for</b>	101898		
	GEV No.	100907	Ref. No. 0C0121
screw connection thread M10x1 Qty 1 pcs type SEF 1 ømm for thermocouple			
<b>accessories for</b>	101898		
	GEV No.	100202	Ref. No. —
pilot burner nozzle natural gas code 41 Qty 1 pcs nozzle ø 0.41mm			
	GEV No.	100203	Ref. No. —
pilot burner nozzle LPG code 25 Qty 1 pcs nozzle ø 0.25mm			
	GEV No.	100701	Ref. No. 059380
ignition electrode connection M4 Qty 1 pcs			
	GEV No.	100869	Ref. No. —
pilot burner nozzle natural gas code 51 Qty 1 pcs suitable for 160 series nozzle ø 0.51mm			
	GEV No.	100906	Ref. No. 057960
screw connection thread M10x1 for ignition electrode brass Qty 1 pcs WS 10			
	GEV No.	100908	Ref. No. 052125
union screw thread M10x1 for pipe ø 4mm Qty 1 pcs			
	GEV No.	100909	Ref. No. —
union screw thread M10x1 for pipe ø 6mm Qty 1 pcs			
	GEV No.	101282	Ref. No. —
olive for pipe ø 4mm L 7.4mm Qty 1 pcs			
	GEV No.	101287	Ref. No. —
olive for pipe ø 6mm Qty 1 pcs			
	GEV No.	107650	Ref. No. —
pilot burner nozzle SIT LPG code 30 Qty 1 pcs			















<b>190 series</b>			
 <p>1</p>			
<b>GEV No.</b>	100110	<b>Ref. No.</b>	002783
<b>description</b>	pilot burner SIT type 190 series 3 flames nozzle ømm gas connectionmm		
<b>accessories for</b>	100110		
	GEV No.	100202	Ref. No. —
pilot burner nozzle natural gas code 41 Qty 1 pcs nozzle ø 0.41mm			
	GEV No.	100203	Ref. No. —
pilot burner nozzle LPG code 25 Qty 1 pcs nozzle ø 0.25mm			

<b>accessories for</b>	100110		
	GEV No.	100701	Ref. No. 059380
ignition electrode connection M4 Qty 1 pcs			
	GEV No.	100906	Ref. No. 057960
screw connection thread M10x1 for ignition electrode brass Qty 1 pcs WS 10			
	GEV No.	100907	Ref. No. 0C0121
screw connection thread M10x1 Qty 1 pcs type SEF 1 ømm for thermocouple			
	GEV No.	100908	Ref. No. 052125
union screw thread M10x1 for pipe ø 4mm Qty 1 pcs			
	GEV No.	100909	Ref. No. —
union screw thread M10x1 for pipe ø 6mm Qty 1 pcs			
	GEV No.	101282	Ref. No. —
olive for pipe ø 4mm L 7.4mm Qty 1 pcs			
	GEV No.	101287	Ref. No. —
olive for pipe ø 6mm Qty 1 pcs			
	GEV No.	102110	Ref. No. 054810
pilot tube copper pipe ø 4mm thickness 1mm L 3000mm			
	GEV No.	102111	Ref. No. —
pilot tube copper pipe ø 6mm thickness 1mm L 3000mm			
	GEV No.	107650	Ref. No. —
pilot burner nozzle SIT LPG code 30 Qty 1 pcs			

<b>POLIDORO</b>			
<b>pilot burners</b>			
 <p>1</p>			
<b>GEV No.</b>	100051	<b>Ref. No.</b>	054032
<b>description</b>	pilot burner POLIDORO 3 flames code gas connectionmm		
<b>spare parts for</b>	100051		
	GEV No.	100907	Ref. No. 0C0121
screw connection thread M10x1 Qty 1 pcs type SEF 1 ømm for thermocouple			
<b>accessories for</b>	100051		
	GEV No.	100000	Ref. No. —
pilot burner nozzle POLIDORO LPG code 22 bore ø 0.22mm Qty 1 pcs			
	GEV No.	100208	Ref. No. —
pilot burner nozzle POLIDORO LPG code 20 bore ø 0.2mm Qty 1 pcs			
	GEV No.	100209	Ref. No. —
pilot burner nozzle POLIDORO natural gas code 40 bore ø 0.4mm Qty 1 pcs			
	GEV No.	100701	Ref. No. 059380
ignition electrode connection M4 Qty 1 pcs			

Table continues overleaf













accessories for		100051	
	GEV No.	100906	Ref. No. 057960
	screw connection thread M10x1 for ignition electrode brass Qty 1 pcs WS 10		
	GEV No.	100907	Ref. No. 0C0121
	screw connection thread M10x1 Qty 1 pcs type SEF 1 ømm for thermocouple		
	GEV No.	100908	Ref. No. 052125
	union screw thread M10x1 for pipe ø 4mm Qty 1 pcs		
	GEV No.	100909	Ref. No. —
	union screw thread M10x1 for pipe ø 6mm Qty 1 pcs		
	GEV No.	102110	Ref. No. 054810
	pilot tube copper pipe ø 4mm thickness 1mm L 3000mm		
	GEV No.	102111	Ref. No. —
	pilot tube copper pipe ø 6mm thickness 1mm L 3000mm		
	GEV No.	102508	Ref. No. —
	union screw thread M10x1 for pipe ø 4mm Qty 5 pcs		
	GEV No.	102509	Ref. No. —
	union screw thread M10x1 for pipe ø 6mm Qty 5 pcs		
	GEV No.	102699	Ref. No. —
	pilot burner nozzle POLIDORO natural gas code 25.2 bore ø 2x0.25mm Qty 1 pcs 2 bores		
	GEV No.	102795	Ref. No. —
	olive for pipe ø 4mm Qty 1 pcs		
	GEV No.	102797	Ref. No. —
	olive for pipe ø 6mm Qty 1 pcs		
	GEV No.	106703	Ref. No. —
	pilot burner nozzle POLIDORO natural gas code 27.2 bore ø 2x0.27mm Qty 1 pcs		
	GEV No.	106704	Ref. No. —
	pilot burner nozzle POLIDORO LPG code 16.2 bore ø 2x0.16mm Qty 1 pcs		
	GEV No.	106763	Ref. No. —
	pilot burner nozzle POLIDORO natural gas code 27.2A bore ø 2x 0.27mm Qty 1 pcs		
	GEV No.	106859	Ref. No. 054286
	pilot burner nozzle POLIDORO LPG code 24 bore ø 0.24mm Qty 1 pcs		

producer-specific pilot burners

ZANUSSI

900 / H900 / 1000 series



<b>GEV No.</b>	107138	<b>Ref. No.</b>	056751
<b>description</b>	pilot burner SIT type 100 series 1 flame natural gas nozzle ø 0.35mm gas connectionmm		
<b>spare parts for</b>	107138		
	GEV No.	100245	Ref. No. 056799
	pilot burner nozzle LPG code 20 bore ø 0.2mm Qty 1 pcs thread M8x0.75		
	GEV No.	100246	Ref. No. 056656
	pilot burner nozzle natural gas bore ø 0.35mm Qty 1 pcs thread M8x0.75		
	GEV No.	100916	Ref. No. —
	compression spring for pilot burner Qty 1 pcs		
	GEV No.	100917	Ref. No. —
	gasket for pilot burner Qty 1 pcs aluminium		
	GEV No.	100918	Ref. No. —
	screw for pilot burner		
	GEV No.	107171	Ref. No. 058330
	pilot burner nozzle SIT natural/liquid gas bore ø 0.25mm Qty 1 pcs		
<b>accessories for</b>	107138		
	GEV No.	100904	Ref. No. 052833
	locking screw M10x1 for pipe ø 4mm Qty 1 pcs		
	GEV No.	100905	Ref. No. —
	locking screw M10x1 for pipe ø 6mm Qty 1 pcs		
	GEV No.	102110	Ref. No. 054810
	pilot tube copper pipe ø 4mm thickness 1mm L 3000mm		
	GEV No.	102111	Ref. No. —
	pilot tube copper pipe ø 6mm thickness 1mm L 3000mm		



HD900 series

















<b>GEV No.</b>	100094	<b>Ref. No.</b>	059214
<b>description</b>	pilot burner SIT type 140 series 1 flame nozzle 0mm gas connectionmm for thermocouple 0 5mm		
<b>accessories for</b>	100094		
	GEV No.	100182	Ref. No. 003547
	cover for pilot burner Qty 1 pcs		
	GEV No.	100204	Ref. No. 059216
	pilot burner nozzle SIT LPG code 14 bore 0.18/0.20mm Qty 1 pcs suitable for 140 series		
	GEV No.	100205	Ref. No. —
	pilot burner nozzle SIT LPG code 19 bore 0.23/0.26mm Qty 1 pcs suitable for SIT 150 series		
	GEV No.	100206	Ref. No. —
	pilot burner nozzle SIT natural gas code 36 bore 0.60/0.55mm Qty 1 pcs suitable for SIT 150 series		
	GEV No.	100207	Ref. No. 059215
	pilot burner nozzle SIT natural gas code 27 bore 0.40/0.38mm suitable for SIT 140 series		
	GEV No.	100216	Ref. No. —
	pilot burner nozzle SIT natural gas code 38 bore 0.45mm Qty 1 pcs suitable for SIT 150 series		
	GEV No.	100897	Ref. No. 059161
	olive for pipe 0 4mm Qty 1 pcs for pilot burner		
	GEV No.	100898	Ref. No. —
	olive for pipe 0 6mm Qty 1 pcs for pilot burner		
	GEV No.	100908	Ref. No. 052125
	union screw thread M10x1 for pipe 0 4mm Qty 1 pcs		
	GEV No.	100909	Ref. No. —
	union screw thread M10x1 for pipe 0 6mm Qty 1 pcs		
	GEV No.	102110	Ref. No. 054810
	pilot tube copper pipe 0 4mm thickness 1mm L 3000mm		
	GEV No.	102111	Ref. No. —
	pilot tube copper pipe 0 6mm thickness 1mm L 3000mm		

N700 series





<b>GEV No.</b>	102484	<b>Ref. No.</b>	0C3644
<b>description</b>	pilot burner 2 flames for N700/N900 from serial no. 646		
<b>accessories for</b>	102484		
	GEV No.	100200	Ref. No. —
	pilot burner nozzle PRO-GAS LPG code 20 Qty 1 pcs nozzle 0 2mm		
	GEV No.	100202	Ref. No. —
	pilot burner nozzle natural gas code 41 Qty 1 pcs nozzle 0 41mm		
	GEV No.	100203	Ref. No. —
	pilot burner nozzle LPG code 25 Qty 1 pcs nozzle 0 25mm		
	GEV No.	100869	Ref. No. —
	pilot burner nozzle natural gas code 51 Qty 1 pcs suitable for 160 series nozzle 0 51mm		
	GEV No.	100870	Ref. No. 053665
	olive for pipe 0 4mm Qty 1 pcs suitable for 160 series for pilot burner		
	GEV No.	100908	Ref. No. 052125
	union screw thread M10x1 for pipe 0 4mm Qty 1 pcs		
	GEV No.	101246	Ref. No. 052127
	olive for pipe 0 4mm Qty 1 pcs		
	GEV No.	102455	Ref. No. —
	nozzle holder T1: M10x1 tube 0 7mm from serial no. 646		
	GEV No.	102482	Ref. No. 0C3646
	union screw thread M11x1 L 11mm Qty 1 pcs hole 0 7mm from serial no. 646		
	GEV No.	102483	Ref. No. 0C3645
	olive ID 0 7mm ED 0 9.5mm Qty 1 pcs brass L 7mm from serial no. 646		
	GEV No.	102486	Ref. No. 0C3647
	pilot tube tube 0 4mm L 310mm W 240mm H 90mm for N900 mounting pos. front		
	GEV No.	102487	Ref. No. 0C3648
	pilot tube tube 0 4mm L 530mm W 190mm H 90mm for N900 mounting pos. rear		
	GEV No.	102488	Ref. No. 0C4192
	pilot tube tube 0 4mm L 230mm W 240mm H 90mm for N700 mounting pos. front		
	GEV No.	102489	Ref. No. 0C4193
	pilot tube tube 0 4mm L 355mm W 160mm H 90mm for N700 mounting pos. rear		
	GEV No.	107650	Ref. No. —
	pilot burner nozzle SIT LPG code 30 Qty 1 pcs		



			
1			
<b>GEV No.</b>	106789	<b>Ref. No.</b>	N/A
<b>description</b>	pilot burner 2 flames nozzle $\emptyset$ mm for N700/N900 from serial no. 646 with nozzle holder		
<b>spare parts for</b>	106789		
	<b>GEV No.</b>	102455	<b>Ref. No.</b> —
	nozzle holder T1: M10x1 tube $\emptyset$ 7mm from serial no. 646		
	<b>GEV No.</b>	102482	<b>Ref. No.</b> 0C3646
	union screw thread M11x1 L 11mm Qty 1 pcs hole $\emptyset$ 7mm from serial no. 646		
	<b>GEV No.</b>	102483	<b>Ref. No.</b> 0C3645
	olive ID $\emptyset$ 7mm ED $\emptyset$ 9.5mm Qty 1 pcs brass L 7mm from serial no. 646		
<b>accessories for</b>	106789		
	<b>GEV No.</b>	100200	<b>Ref. No.</b> —
	pilot burner nozzle PRO-GAS LPG code 20 Qty 1 pcs nozzle $\emptyset$ 0.2mm		
	<b>GEV No.</b>	100202	<b>Ref. No.</b> —
	pilot burner nozzle natural gas code 41 Qty 1 pcs nozzle $\emptyset$ 0.41mm		
	<b>GEV No.</b>	100203	<b>Ref. No.</b> —
	pilot burner nozzle LPG code 25 Qty 1 pcs nozzle $\emptyset$ 0.25mm		
	<b>GEV No.</b>	100869	<b>Ref. No.</b> —
	pilot burner nozzle natural gas code 51 Qty 1 pcs suitable for 160 series nozzle $\emptyset$ 0.51mm		
	<b>GEV No.</b>	100870	<b>Ref. No.</b> 053665
	olive for pipe $\emptyset$ 4mm Qty 1 pcs suitable for 160 series for pilot burner		
	<b>GEV No.</b>	100908	<b>Ref. No.</b> 052125
	union screw thread M10x1 for pipe $\emptyset$ 4mm Qty 1 pcs		
	<b>GEV No.</b>	101246	<b>Ref. No.</b> 052127
	olive for pipe $\emptyset$ 4mm Qty 1 pcs		
	<b>GEV No.</b>	102487	<b>Ref. No.</b> 0C3648
	pilot tube tube $\emptyset$ 4mm L 530mm W 190mm H 90mm for N900 mounting pos. rear		
	<b>GEV No.</b>	102488	<b>Ref. No.</b> 0C4192
	pilot tube tube $\emptyset$ 4mm L 230mm W 240mm H 90mm for N700 mounting pos. front		
	<b>GEV No.</b>	102489	<b>Ref. No.</b> 0C4193
	pilot tube tube $\emptyset$ 4mm L 355mm W 160mm H 90mm for N700 mounting pos. rear		
	<b>GEV No.</b>	107650	<b>Ref. No.</b> —
	pilot burner nozzle SIT LPG code 30 Qty 1 pcs		

electrodes

			
1			
<b>GEV No.</b>	100701	<b>Ref. No.</b>	059380
<b>description</b>	ignition electrode connection M4 Qty 1 pcs		
<b>accessories for</b>	100701		
	<b>GEV No.</b>	100906	<b>Ref. No.</b> 057960
	screw connection thread M10x1 for ignition electrode brass Qty 1 pcs WS 10		

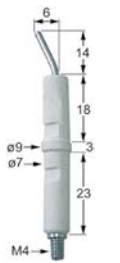
			
1			
<b>GEV No.</b>	100706	<b>Ref. No.</b>	056754
<b>description</b>	ignition electrode connection M4 Qty 1 pcs		

			
1			
<b>GEV No.</b>	100718	<b>Ref. No.</b>	045821
<b>description</b>	ignition electrode D1 $\emptyset$ 10mm connection M5 D2 $\emptyset$ 14mm L1 55mm L2 10mm BL1 22mm BL2 22mm BL3 4mm to clip		

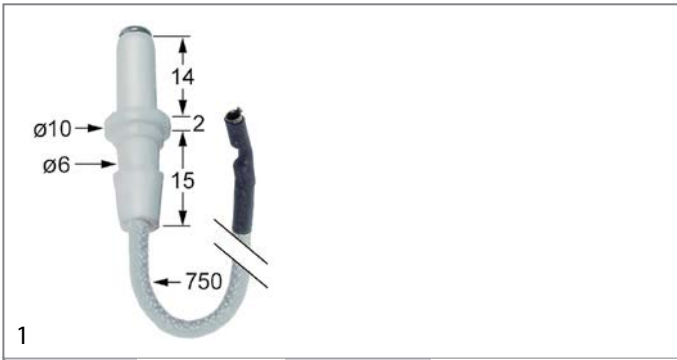

<b>GEV No.</b>	100738	<b>Ref. No.</b>	004970
<b>description</b>	ignition electrode D1 ø6mm cable length 750mm D2 ø10mm BL1 14mm BL2 2mm BL3 15mm to clip with spring and insulation connection ø2.4mm		

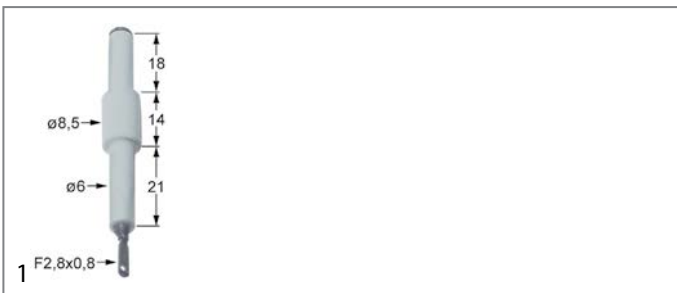

<b>GEV No.</b>	100717	<b>Ref. No.</b>	054099
<b>description</b>	ignition electrode D1 ø6mm connection F 2.8x0.8mm D2 ø8.5mm BL1 18mm BL2 14mm BL3 21mm to clip		



<b>GEV No.</b>	100724	<b>Ref. No.</b>	0H6257
<b>description</b>	ignition electrode D1 ø8mm BL1 13mm BL2 28mm BL3 8mm connection F 2.8x0.8mm M10x0.75		
<b>accessories for</b>	100724		
	<b>GEV No.</b>	519546	<b>Ref. No.</b> —
	nut thread M10x0.75 H 3.45mm WS 14 brass Qty 1 pcs		



<b>GEV No.</b>	102170	<b>Ref. No.</b>	0A5169
<b>description</b>	ignition electrode flange length 24mm flange width 17mm D1 ø10mm fixing dimensions ø4.5mm with flange		

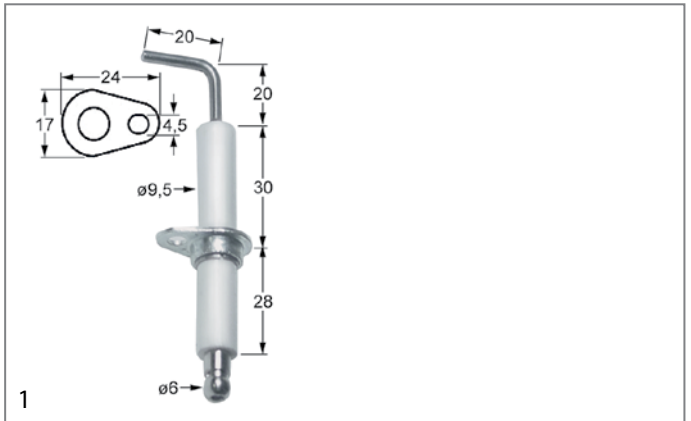

<b>GEV No.</b>	102361	<b>Ref. No.</b>	002637
<b>description</b>	ignition electrode flange length 24mm flange width 17mm D1 ø9.5mm L1 20mm L2 20mm BL1 30mm BL2 28mm fixing dimensions ø4.5mm with flange connection ø6mm		

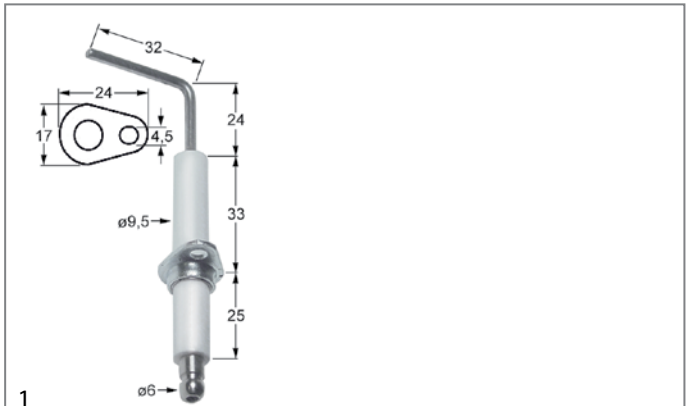

<b>GEV No.</b>	102360	<b>Ref. No.</b>	002344
<b>description</b>	ignition electrode flange length 24mm flange width 17mm D1 ø9.5mm L1 24mm L2 32mm BL1 33mm BL2 25mm fixing dimensions ø4.5mm with flange connection ø6mm		



<b>GEV No.</b>	100739	<b>Ref. No.</b>	003041
<b>description</b>	ignition electrode flange length 24mm flange width 17mm D1 ø9.5mm L1 24mm L2 71mm L4 61mm L3 27mm BL1 24mm BL2 35mm fixing dimensions ø4.5mm with flange connection ø4mm		



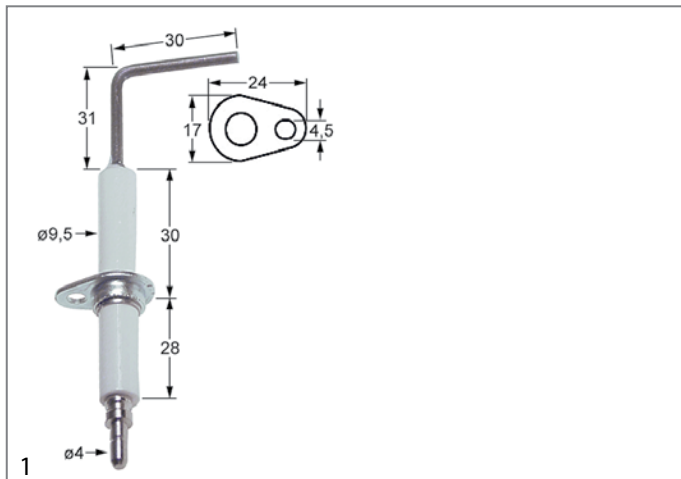

<b>GEV No.</b>	102175	<b>Ref. No.</b>	002638
<b>description</b>	ignition electrode flange length 24mm flange width 17mm D1 ø 9.5mm L1 31mm L2 30mm BL1 30mm BL2 28mm fixing dimensions ø4.5mm with flange connection ø 4mm		

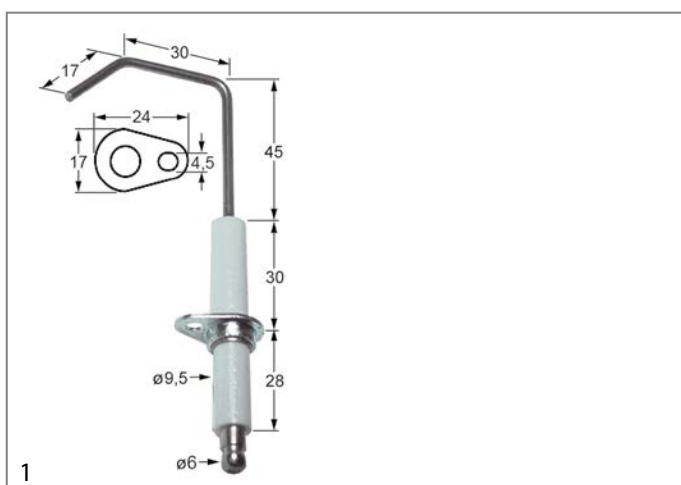

<b>GEV No.</b>	102169	<b>Ref. No.</b>	003556
<b>description</b>	ignition electrode flange length 24mm flange width 17mm D1 ø 9.5mm L1 45mm L2 30mm L4 18mm L3 17mm BL1 30mm BL2 28mm fixing dimensions ø4.5mm with flange connection ø 6mm		

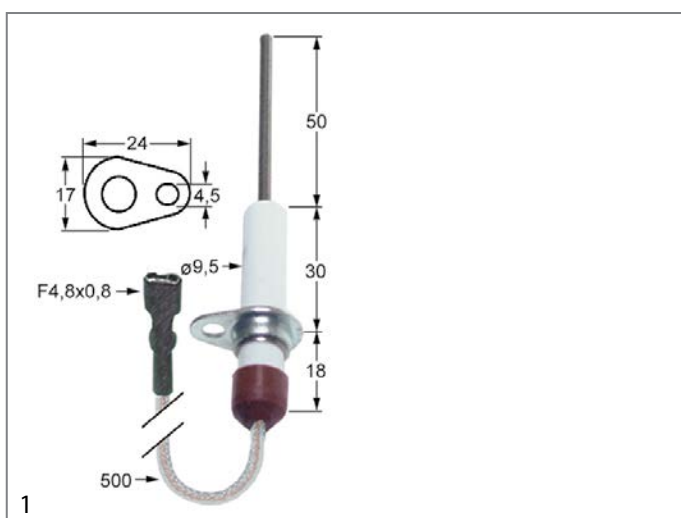

<b>GEV No.</b>	102345	<b>Ref. No.</b>	0C1049
<b>description</b>	ignition electrode flange length 24mm flange width 17mm D1 ø 9.5mm L1 50mm BL1 30mm BL2 18mm connection F 4.8x0.8mm cable length 500mm fixing dimensions ø4.5mm with flange		



<b>GEV No.</b>	102359	<b>Ref. No.</b>	002343
<b>description</b>	ignition electrode flange length 24mm flange width 17mm D1 ø 9.5mm L1 60mm L2 12mm BL1 33mm BL2 25mm fixing dimensions ø4.5mm with flange connection ø 4mm		

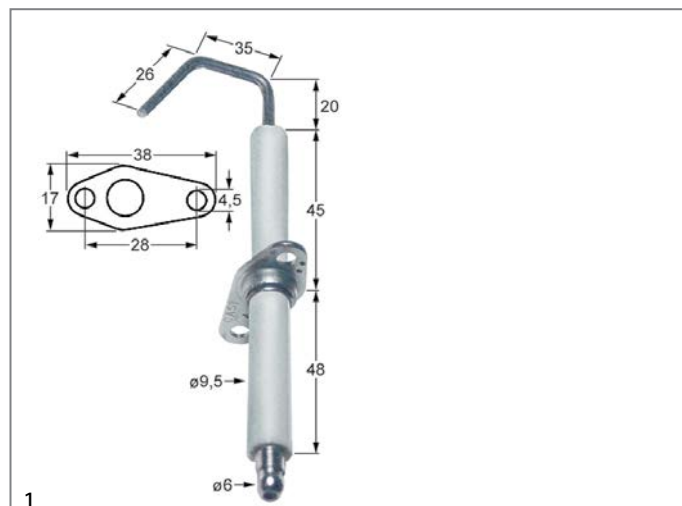

<b>GEV No.</b>	102351	<b>Ref. No.</b>	0C1137
<b>description</b>	ignition electrode flange length 38mm flange width 17mm D1 ø 9.5mm L1 20mm L2 35mm L3 26mm BL1 45mm BL2 48mm cable length 1180mm fixing dimensions ø4.5mm mounting distance 28mm with flange connection ø 6mm		

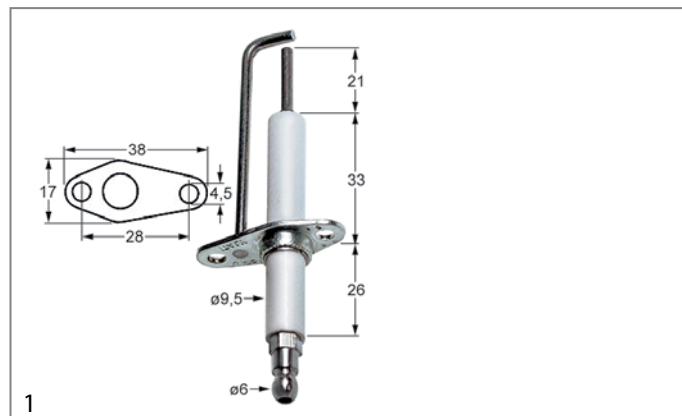

<b>GEV No.</b>	102362	<b>Ref. No.</b>	0H6803
<b>description</b>	ignition electrode flange length 38mm flange width 17mm D1 ø 9.5mm L1 21mm BL1 33mm BL2 26mm fixing dimensions ø4.5mm mounting distance 28mm with flange with earthing contact connection ø 6mm		



1	<b>GEV No.</b>	102352	<b>Ref. No.</b>	0C1134
<b>description</b>	ignition electrode flange length 38mm flange width 17mm D1 ø 9.5mm L1 35mm BL1 30mm BL2 18mm connection F 2.8x0.8mm cable length 600mm fixing dimensions ø4.5mm mounting distance 28mm with flange with earthing contact			

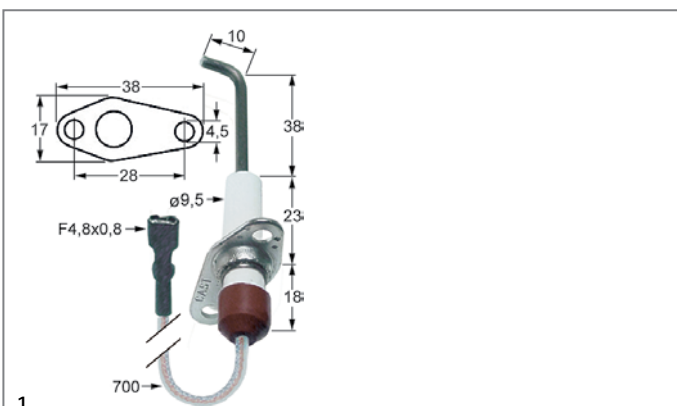

1	<b>GEV No.</b>	102349	<b>Ref. No.</b>	005920
<b>description</b>	ignition electrode flange length 38mm flange width 17mm D1 ø 9.5mm L1 38mm L2 10mm BL1 23mm BL2 18mm connection F 4.8x0.8mm cable length 700mm fixing dimensions ø4.5mm mounting distance 28mm with flange			



1	<b>GEV No.</b>	102350	<b>Ref. No.</b>	005911
<b>description</b>	ignition electrode flange length 51mm flange width 23mm D1 ø 9.5mm L1 33mm L2 11mm BL1 20mm BL2 15mm connection F 6.3x0.8/2.8x0.8mm cable length 450mm fixing dimensions ø5.5mm with flange			

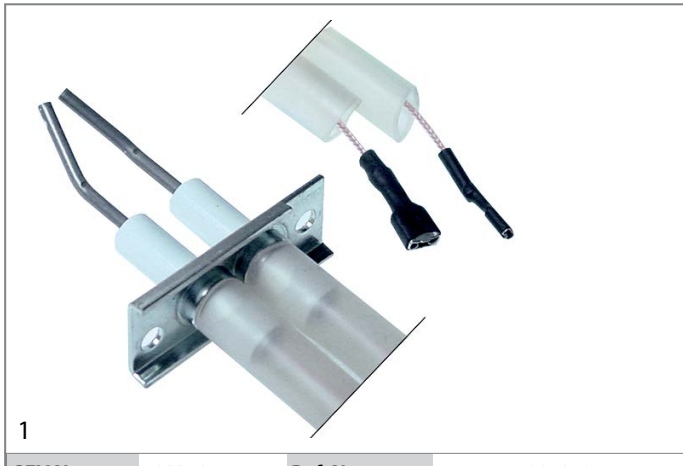

1	<b>GEV No.</b>	102348	<b>Ref. No.</b>	005910
<b>description</b>	ignition electrode flange length 51mm flange width 23mm D1 ø 9.5mm L1 33mm L2 11mm BL1 20mm BL2 15mm connection F 6.3x0.8/2.8x0.8mm cable length 650mm fixing dimensions ø5.5mm with flange			



1	<b>GEV No.</b>	100906	<b>Ref. No.</b>	057960
<b>description</b>	screw connection thread M10x1 for ignition electrode brass Qty 1 pcs WS 10			

ignition cables

pre-assembled cables

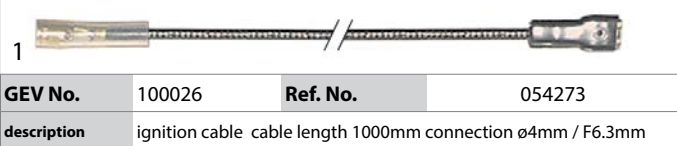

1	<b>GEV No.</b>	100026	<b>Ref. No.</b>	054273
<b>description</b>	ignition cable cable length 1000mm connection ø4mm / F6.3mm			



1	<b>GEV No.</b>	100018	<b>Ref. No.</b>	004943
<b>description</b>	ignition cable cable length 600mm connection ø2.4mm / ø4mm permanent temperature 200°C			



1	<b>GEV No.</b>	100019	<b>Ref. No.</b>	003755
<b>description</b>	ignition cable cable length 900mm connection ø2.4mm / ø4mm			





piezoelectric igniters

mounting diameter 18mm



1

<b>GEV No.</b>	100009	<b>Ref. No.</b>	004944
<b>description</b>	piezoelectric igniter body plastic blowing mounting ø 18mm connection ø2.4mm front measurements 26mm M18x1.5		
<b>accessories for</b>	100009		
	<b>GEV No.</b>	101339	<b>Ref. No.</b> 002816
	cover cap for piezoelectric igniter		
	<b>GEV No.</b>	106869	<b>Ref. No.</b> —
	cover cap for piezoelectric igniter ID ø 22mm ED ø 35mm H 25mm		
	<b>GEV No.</b>	107931	<b>Ref. No.</b> —
	cover cap for piezoelectric igniter ID ø 21mm ED ø 36mm		

mounting diameter 22mm



1

<b>GEV No.</b>	100005	<b>Ref. No.</b>	0H6070
<b>description</b>	piezoelectric igniter body plastic blowing mounting ø 22mm connection ø2.4mm cable lengthmm SIT		

miscellaneous



1

<b>GEV No.</b>	nla <sup>1</sup>	<b>Ref. No.</b>	058225
<b>description</b>	piezoelectric igniter body metal connection F6.3x0.8 2 hole fixing ø 22mm		

<sup>1</sup>no longer available



1

<b>GEV No.</b>	nla <sup>1</sup>	<b>Ref. No.</b>	002057
<b>description</b>	piezoelectric igniter suitable for Minisit connection F6.3x0.8 ømm		

<sup>1</sup>no longer available



1

<b>GEV No.</b>	nla <sup>1</sup>	<b>Ref. No.</b>	054269
<b>description</b>	piezoelectric igniter suitable for Minisit with cover cap ømm connection F6.3x0.8		
<b>spare parts for</b>	101136		
	<b>GEV No.</b>	100001	<b>Ref. No.</b> 002057
	piezoelectric igniter suitable for Minisit connection F6.3x0.8 ømm		

<sup>1</sup>no longer available

accessories



1

<b>GEV No.</b>	101339	<b>Ref. No.</b>	002816
<b>description</b>	cover cap for piezoelectric igniter		

ignition units



1

<b>GEV No.</b>	102485	<b>Ref. No.</b>	004240
<b>description</b>	ignition unit outputs 2 220-240VAC 0.6VA 50-60Hz		



1

<b>GEV No.</b>	101015	<b>Ref. No.</b>	004248
<b>description</b>	ignition unit outputs 4 230VAC 0.6VA 50Hz		



1

<b>GEV No.</b>	101003	<b>Ref. No.</b>	003214
<b>description</b>	ignition unit outputs 4 230VAC 50Hz		



1

<b>GEV No.</b>	101004	<b>Ref. No.</b>	003552
<b>description</b>	ignition unit outputs 6 230VAC inlet F6.3x0.8 outlet F2.8x0.8 50Hz mounting ø 88mm		

### ignition switches



1

<b>GEV No.</b>	345038	<b>Ref. No.</b>	053978
<b>description</b>	momentary push switch mounting ø 25mm black 2NO 250V 16A connection male faston 6.3mm ambient temperature max. 85°C protection IP40		



1

<b>GEV No.</b>	301207	<b>Ref. No.</b>	004241
<b>description</b>	microswitch operation switch mounting distance 24mm 250V 0.5A NO connection male faston 4.8mm type 209 actuating force: 400g		

### thermocouples

#### thermocouple sets universal

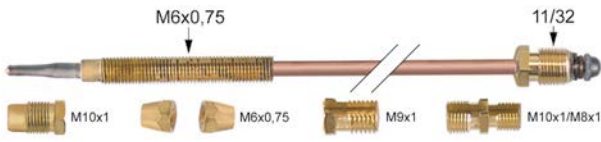

1

<b>GEV No.</b>	102006	<b>Ref. No.</b>	050056
<b>description</b>	thermocouple set 6-piece L 1200mm		

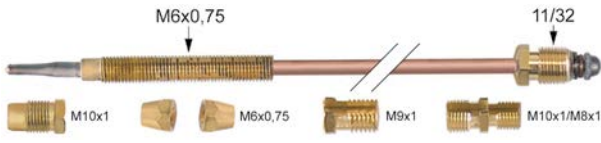

1

<b>GEV No.</b>	102000	<b>Ref. No.</b>	050055
<b>description</b>	thermocouple set 6-piece L 900mm		

### plug-in thermocouples

#### plug-in thermocouples standard

with barrel socket ø5mm - type Junkers with aluminised tip



1

<b>GEV No.</b>	102205	<b>Ref. No.</b>	058332
<b>description</b>	thermocouple M8x1 L 750mm plug connection ø5.0mm		
<b>accessories for</b>	102205		
	<b>GEV No.</b>	101260	<b>Ref. No.</b>
			—
	thermocouple fitting thread M8x1 Qty 1 pcs		

#### with barrel socket ø6(6.5)mm

#### thermocouples SIT

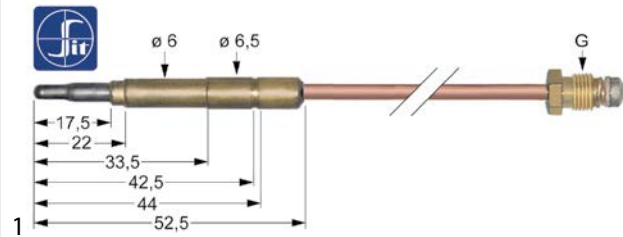

1

<b>GEV No.</b>	107619	<b>Ref. No.</b>	0A2161
<b>description</b>	thermocouple SIT M10x1 L 1000mm plug connection ø6.0(6.5)mm		

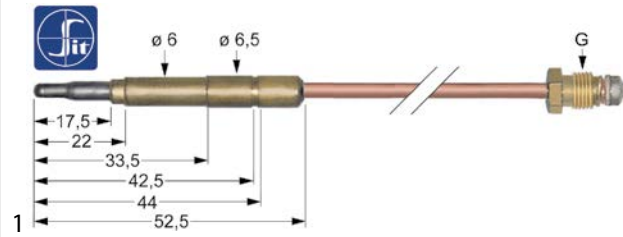

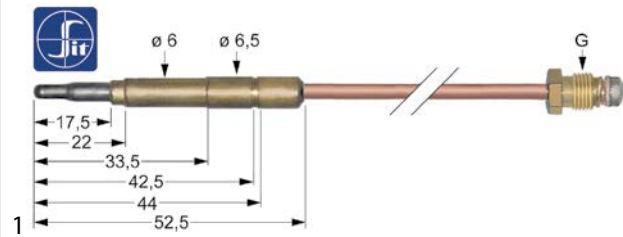

1

<b>GEV No.</b>	107605	<b>Ref. No.</b>	051119
<b>description</b>	thermocouple SIT M8x1 L 1500mm plug connection ø6.0(6.5)mm		



1

<b>GEV No.</b>	107602	<b>Ref. No.</b>	0C0202
<b>description</b>	thermocouple SIT M8x1 L 850mm plug connection ø6.0(6.5)mm		
<b>accessories for</b>	107602		
	<b>GEV No.</b>	100920	<b>Ref. No.</b>
			—
	thermocouple fitting thread M8x1 / M9x1 Qty 1 pcs		
	<b>GEV No.</b>	100922	<b>Ref. No.</b>
			—
	thermocouple fitting thread M10x1 / ASA 11/32 Qty 1 pcs		



<b>GEV No.</b>	107613	<b>Ref. No.</b>	OK3464
<b>description</b>	thermocouple SIT M9x1 L 1200mm plug connection ø6.0(6.5)mm		

<b>GEV No.</b>	107608	<b>Ref. No.</b>	027317
<b>description</b>	thermocouple SIT M9x1 L 500mm plug connection ø6.0(6.5)mm		

<b>GEV No.</b>	107609	<b>Ref. No.</b>	025031
<b>description</b>	thermocouple SIT M9x1 L 600mm plug connection ø6.0(6.5)mm		

plug-in thermocouples with interruption

<b>GEV No.</b>	107863	<b>Ref. No.</b>	0C3162
<b>description</b>	thermocouple SIT with interrupter M9x1 L 1000mm plug connection ø6.0(6.5)mm cable 820mm		

<b>GEV No.</b>	107148	<b>Ref. No.</b>	002784
<b>description</b>	thermocouple SIT with interrupter M9x1 L 600mm M10x1 F 6.3mm		

threaded thermocouples  
 threaded thermocouples standard  
 threaded thermocouples (miscellaneous)

<b>GEV No.</b>	102121	<b>Ref. No.</b>	004955
<b>description</b>	thermocouple M8x1 L 600mm M6x0.5		
<b>accessories for</b>	102121		
		<b>GEV No.</b>	100892
		<b>Ref. No.</b>	—
	thermocouple nut thread M6x0.5 H 6.5mm WS 8 brass Qty 1 pcs		

<b>GEV No.</b>	107646	<b>Ref. No.</b>	052163
<b>description</b>	thermocouple M9x1 L 1000mm M8x1		

threaded thermocouples with interruption

<b>GEV No.</b>	102259	<b>Ref. No.</b>	051635
<b>description</b>	thermocouple with interrupter M9x1 L 1000mm M8x1 with cable 1000mm		



thermopiles

<b>GEV No.</b>	102116	<b>Ref. No.</b>	002607
<b>description</b>	thermopile ROBERTSHAW L 900mm probe $\varnothing$ 9mm probe L 57mm 250-750mV screw connection 7/16"		

extensions

<b>GEV No.</b>	102265	<b>Ref. No.</b>	055032
<b>description</b>	thermocouple extension thread M9x1 L 600mm		

accessories

nuts

<b>GEV No.</b>	102067	<b>Ref. No.</b>	055033
<b>description</b>	nut thread M8x1 H 3mm brass Qty 1 pcs type SEF 1		

interrupters

<b>GEV No.</b>	101258	<b>Ref. No.</b>	0H6263
<b>description</b>	interrupter thread M10x1		

<b>GEV No.</b>	101264	<b>Ref. No.</b>	004982
<b>description</b>	interrupter thread M8x1		

<b>GEV No.</b>	101265	<b>Ref. No.</b>	005687
<b>description</b>	interrupter thread M9x1		

gas burners

hob burners

universal hob burners

SABAF

1 series





<b>GEV No.</b>	104288	<b>Ref. No.</b>	004975	
<b>description</b>	burner cap 3.6kW $\varnothing$ 120mm			
<b>accessories for</b>	104288			
	<b>GEV No.</b>	104289	<b>Ref. No.</b>	004977
	burner lower part 3/3.6kW for burner cap $\varnothing$ 90/120mm			
	<b>GEV No.</b>	105086	<b>Ref. No.</b>	—
	burner ring 3.6kW for burner cap $\varnothing$ 120mm			
	<b>GEV No.</b>	105087	<b>Ref. No.</b>	—
	burner head 3.6kW for burner cap $\varnothing$ 120mm			

<b>GEV No.</b>	104286	<b>Ref. No.</b>	004973	
<b>description</b>	burner cap 3kW $\varnothing$ 90mm			
<b>accessories for</b>	104286			
	<b>GEV No.</b>	104289	<b>Ref. No.</b>	004977
	burner lower part 3/3.6kW for burner cap $\varnothing$ 90/120mm			
	<b>GEV No.</b>	105089	<b>Ref. No.</b>	—
	burner ring 3kW for burner cap $\varnothing$ 90mm			
	<b>GEV No.</b>	105090	<b>Ref. No.</b>	—
	burner head 3kW for burner cap $\varnothing$ 90mm			

<b>GEV No.</b>	104289	<b>Ref. No.</b>	004977	
<b>description</b>	burner lower part 3/3.6kW for burner cap $\varnothing$ 90/120mm			
<b>accessories for</b>	104289			
	<b>GEV No.</b>	104286	<b>Ref. No.</b>	004973
	burner cap 3kW $\varnothing$ 90mm			
	<b>GEV No.</b>	104288	<b>Ref. No.</b>	004975
	burner cap 3.6kW $\varnothing$ 120mm			
	<b>GEV No.</b>	105086	<b>Ref. No.</b>	—
	burner ring 3.6kW for burner cap $\varnothing$ 120mm			

Table continues overleaf



<b>accessories for</b>	104289		
	<b>GEV No.</b>	105087	<b>Ref. No.</b> —
burner head 3.6kW for burner cap ø 120mm			
	<b>GEV No.</b>	105089	<b>Ref. No.</b> —
burner ring 3kW for burner cap ø 90mm			
	<b>GEV No.</b>	105090	<b>Ref. No.</b> —
burner head 3kW for burner cap ø 90mm			
	<b>GEV No.</b>	106482	<b>Ref. No.</b> —
gas injector thread M6x0.75 WS 7 bore ø 1.1mm			
	<b>GEV No.</b>	106485	<b>Ref. No.</b> —
gas injector thread M6x0.75 WS 7 bore ø 1.6mm			



producer-specific hob burners



ZANUSSI



600 series

	<b>GEV No.</b>	104288	<b>Ref. No.</b>	004975
burner cap 3.6kW ø 120mm				
<b>accessories for</b>	104288			
	<b>GEV No.</b>	104289	<b>Ref. No.</b>	004977
burner lower part 3/3.6kW for burner cap ø 90/120mm				
	<b>GEV No.</b>	105086	<b>Ref. No.</b>	—
burner ring 3.6kW for burner cap ø 120mm				
	<b>GEV No.</b>	105087	<b>Ref. No.</b>	—
burner head 3.6kW for burner cap ø 120mm				

	<b>GEV No.</b>	104286	<b>Ref. No.</b>	004973
burner cap 3kW ø 90mm				
<b>accessories for</b>	104286			
	<b>GEV No.</b>	104289	<b>Ref. No.</b>	004977
burner lower part 3/3.6kW for burner cap ø 90/120mm				
	<b>GEV No.</b>	105089	<b>Ref. No.</b>	—
burner ring 3kW for burner cap ø 90mm				
	<b>GEV No.</b>	105090	<b>Ref. No.</b>	—
burner head 3kW for burner cap ø 90mm				







	<b>GEV No.</b>	104289	<b>Ref. No.</b>	004977
burner lower part 3/3.6kW for burner cap ø 90/120mm				
<b>accessories for</b>	104289			
	<b>GEV No.</b>	104286	<b>Ref. No.</b>	004973
burner cap 3kW ø 90mm				
	<b>GEV No.</b>	104288	<b>Ref. No.</b>	004975
burner cap 3.6kW ø 120mm				
	<b>GEV No.</b>	105086	<b>Ref. No.</b>	—
burner ring 3.6kW for burner cap ø 120mm				
	<b>GEV No.</b>	105087	<b>Ref. No.</b>	—
burner head 3.6kW for burner cap ø 120mm				
	<b>GEV No.</b>	105089	<b>Ref. No.</b>	—
burner ring 3kW for burner cap ø 90mm				
	<b>GEV No.</b>	105090	<b>Ref. No.</b>	—
burner head 3kW for burner cap ø 90mm				
	<b>GEV No.</b>	106482	<b>Ref. No.</b>	—
gas injector thread M6x0.75 WS 7 bore ø 1.1mm				
	<b>GEV No.</b>	106485	<b>Ref. No.</b>	—
gas injector thread M6x0.75 WS 7 bore ø 1.6mm				

	<b>GEV No.</b>	104287	<b>Ref. No.</b>	004974
burner ring for burner cap ø 120mm				
<b>accessories for</b>	104287			
	<b>GEV No.</b>	105086	<b>Ref. No.</b>	—
burner ring 3.6kW for burner cap ø 120mm				
	<b>GEV No.</b>	105087	<b>Ref. No.</b>	—
burner head 3.6kW for burner cap ø 120mm				



	<b>GEV No.</b>	104285	<b>Ref. No.</b>	004972
burner ring ø 90mm for burner cap ø 90mm				
<b>accessories for</b>	104285			
	<b>GEV No.</b>	105089	<b>Ref. No.</b>	—
burner ring 3kW for burner cap ø 90mm				
	<b>GEV No.</b>	105090	<b>Ref. No.</b>	—
burner head 3kW for burner cap ø 90mm				

700 (version 1), R701, MD700, PR700 series

			
<b>1</b>			
<b>GEV No.</b>	105056	<b>Ref. No.</b>	053448
<b>description</b>	air mixing sleeve L 43mm ED ø 43mm ID ø 40mm aluminium		
<b>accessories for</b>	105056		
	<b>GEV No.</b>	101947	<b>Ref. No.</b> 058331
	bracket for igniter/thermocouple		
	<b>GEV No.</b>	105008	<b>Ref. No.</b> 056747
	burner ring for burner cap ø 70mm		
	<b>GEV No.</b>	105011	<b>Ref. No.</b> 056748
	burner ring for burner cap ø 100mm		
	<b>GEV No.</b>	105012	<b>Ref. No.</b> 002443
	burner cap ø 100mm		
	<b>GEV No.</b>	105231	<b>Ref. No.</b> 054091
	burner head for burner cap ø 70mm with nozzle holder for plug-in nozzle		
	<b>GEV No.</b>	105232	<b>Ref. No.</b> 002442
	burner cap ø 70mm		
	<b>GEV No.</b>	105233	<b>Ref. No.</b> 054092
	burner head for burner cap ø 100mm with nozzle holder for plug-in nozzle		
	<b>GEV No.</b>	105270	<b>Ref. No.</b> 054093
	gasket for burner cap ø 70mm		
	<b>GEV No.</b>	105271	<b>Ref. No.</b> 054094
	gasket for burner cap ø 100mm		

			
<b>1</b>			
<b>GEV No.</b>	105012	<b>Ref. No.</b>	002443
<b>description</b>	burner cap ø 100mm		
<b>accessories for</b>	105012		
	<b>GEV No.</b>	101947	<b>Ref. No.</b> 058331
	bracket for igniter/thermocouple		
	<b>GEV No.</b>	105011	<b>Ref. No.</b> 056748
	burner ring for burner cap ø 100mm		
	<b>GEV No.</b>	105056	<b>Ref. No.</b> 053448
	air mixing sleeve L 43mm ED ø 43mm ID ø 40mm aluminium		
	<b>GEV No.</b>	105233	<b>Ref. No.</b> 054092
	burner head for burner cap ø 100mm with nozzle holder for plug-in nozzle		
	<b>GEV No.</b>	105271	<b>Ref. No.</b> 054094
	gasket for burner cap ø 100mm		







			
<b>1</b>			
<b>GEV No.</b>	105232	<b>Ref. No.</b>	002442
<b>description</b>	burner cap ø 70mm		
<b>accessories for</b>	105232		
	<b>GEV No.</b>	101947	<b>Ref. No.</b> 058331
	bracket for igniter/thermocouple		
	<b>GEV No.</b>	105008	<b>Ref. No.</b> 056747
	burner ring for burner cap ø 70mm		
	<b>GEV No.</b>	105056	<b>Ref. No.</b> 053448
	air mixing sleeve L 43mm ED ø 43mm ID ø 40mm aluminium		
	<b>GEV No.</b>	105231	<b>Ref. No.</b> 054091
	burner head for burner cap ø 70mm with nozzle holder for plug-in nozzle		
	<b>GEV No.</b>	105270	<b>Ref. No.</b> 054093
	gasket for burner cap ø 70mm		

			
<b>1</b>			
<b>GEV No.</b>	105233	<b>Ref. No.</b>	054092
<b>description</b>	burner head for burner cap ø 100mm with nozzle holder for plug-in nozzle		
<b>accessories for</b>	105233		
	<b>GEV No.</b>	101947	<b>Ref. No.</b> 058331
	bracket for igniter/thermocouple		
	<b>GEV No.</b>	105011	<b>Ref. No.</b> 056748
	burner ring for burner cap ø 100mm		
	<b>GEV No.</b>	105012	<b>Ref. No.</b> 002443
	burner cap ø 100mm		
	<b>GEV No.</b>	105056	<b>Ref. No.</b> 053448
	air mixing sleeve L 43mm ED ø 43mm ID ø 40mm aluminium		
	<b>GEV No.</b>	105271	<b>Ref. No.</b> 054094
	gasket for burner cap ø 100mm		

















 <p>1</p>			
<b>GEV No.</b>	107230	<b>Ref. No.</b>	004239
<b>description</b>	burner head for burner cap ø 100mm with nozzle holder for threaded nozzle		

 <p>1</p>			
<b>GEV No.</b>	105231	<b>Ref. No.</b>	054091
<b>description</b>	burner head for burner cap ø 70mm with nozzle holder for plug-in nozzle		
<b>accessories for</b>	105231		
	<b>GEV No.</b>	101947	<b>Ref. No.</b> 058331
	bracket for igniter/thermocouple		
	<b>GEV No.</b>	105008	<b>Ref. No.</b> 056747
	burner ring for burner cap ø 70mm		
	<b>GEV No.</b>	105056	<b>Ref. No.</b> 053448
	air mixing sleeve L 43mm ED ø 43mm ID ø 40mm aluminium		
	<b>GEV No.</b>	105232	<b>Ref. No.</b> 002442
	burner cap ø 70mm		
	<b>GEV No.</b>	105270	<b>Ref. No.</b> 054093
	gasket for burner cap ø 70mm		

 <p>1</p>			
<b>GEV No.</b>	107229	<b>Ref. No.</b>	004238
<b>description</b>	burner head for burner cap ø 70mm with nozzle holder for threaded nozzle		

 <p>1</p>			
<b>GEV No.</b>	105011	<b>Ref. No.</b>	056748
<b>description</b>	burner ring for burner cap ø 100mm		
<b>accessories for</b>	105011		
	<b>GEV No.</b>	101947	<b>Ref. No.</b> 058331
	bracket for igniter/thermocouple		

<b>accessories for</b>	105011		
	<b>GEV No.</b>	105012	<b>Ref. No.</b> 002443
	burner cap ø 100mm		
	<b>GEV No.</b>	105056	<b>Ref. No.</b> 053448
	air mixing sleeve L 43mm ED ø 43mm ID ø 40mm aluminium		
	<b>GEV No.</b>	105233	<b>Ref. No.</b> 054092
	burner head for burner cap ø 100mm with nozzle holder for plug-in nozzle		
	<b>GEV No.</b>	105271	<b>Ref. No.</b> 054094
	gasket for burner cap ø 100mm		



 <p>1</p>			
<b>GEV No.</b>	105008	<b>Ref. No.</b>	056747
<b>description</b>	burner ring for burner cap ø 70mm		
<b>accessories for</b>	105008		
	<b>GEV No.</b>	101947	<b>Ref. No.</b> 058331
	bracket for igniter/thermocouple		
	<b>GEV No.</b>	105056	<b>Ref. No.</b> 053448
	air mixing sleeve L 43mm ED ø 43mm ID ø 40mm aluminium		
	<b>GEV No.</b>	105231	<b>Ref. No.</b> 054091
	burner head for burner cap ø 70mm with nozzle holder for plug-in nozzle		
	<b>GEV No.</b>	105232	<b>Ref. No.</b> 002442
	burner cap ø 70mm		
	<b>GEV No.</b>	105270	<b>Ref. No.</b> 054093
	gasket for burner cap ø 70mm		





 <p>1</p>			
<b>GEV No.</b>	105271	<b>Ref. No.</b>	054094
<b>description</b>	gasket for burner cap ø 100mm		

 <p>1</p>			
<b>GEV No.</b>	105270	<b>Ref. No.</b>	054093
<b>description</b>	gasket for burner cap ø 70mm		



H900 series			
			
<b>GEV No.</b>	105055	<b>Ref. No.</b>	052116
<b>description</b>	air mixing sleeve L 40mm ED ø 43mm ID ø 40mm aluminium		
<b>accessories for</b>	105055		
	<b>GEV No.</b>	104564	<b>Ref. No.</b> 054193
	burner cap ø 120mm 32 bores inside		
	<b>GEV No.</b>	104565	<b>Ref. No.</b> 054246
	burner head for burner cap ø 120mm		
	<b>GEV No.</b>	104570	<b>Ref. No.</b> 004280
	burner cap ø 120mm 16 bores inside		
	<b>GEV No.</b>	104571	<b>Ref. No.</b> 004279
	burner head for burner cap ø 120mm		
	<b>GEV No.</b>	105001	<b>Ref. No.</b> 058182
	burner lower part ø 84mm for burner cap ø 83mm		
	<b>GEV No.</b>	105002	<b>Ref. No.</b> 058185
	burner cap ø 83mm chrome-plated		
	<b>GEV No.</b>	105003	<b>Ref. No.</b> 058183
	burner lower part ø 103mm for burner cap ø 102mm		
	<b>GEV No.</b>	105004	<b>Ref. No.</b> 058186
	burner cap ø 102mm		
	<b>GEV No.</b>	105005	<b>Ref. No.</b> 058184
	burner head for burner cap ø 122mm		
	<b>GEV No.</b>	105006	<b>Ref. No.</b> 058187
	burner cap ø 122mm with central hole		
	<b>GEV No.</b>	210205	<b>Ref. No.</b> 052102
	drain tray L 345mm W 360mm H 38mm ø 105mm PTFE coated steel		
	<b>GEV No.</b>	210206	<b>Ref. No.</b> 052103
	drain tray L 360mm W 345mm ø 122mm		
	<b>GEV No.</b>	210207	<b>Ref. No.</b> 052104
	drain tray L 360mm W 345mm ø 145mm		

			
<b>GEV No.</b>	105004	<b>Ref. No.</b>	058186
<b>description</b>	burner cap ø 102mm		
<b>accessories for</b>	105004		
	<b>GEV No.</b>	105003	<b>Ref. No.</b> 058183
	burner lower part ø 103mm for burner cap ø 102mm		

<b>accessories for</b>	105004		
	<b>GEV No.</b>	105055	<b>Ref. No.</b> 052116
	air mixing sleeve L 40mm ED ø 43mm ID ø 40mm aluminium		
	<b>GEV No.</b>	105238	<b>Ref. No.</b> 002462
	burner head for burner cap ø 102mm		
	<b>GEV No.</b>	105240	<b>Ref. No.</b> 002459
	venturi for burner cap ø 102mm		
	<b>GEV No.</b>	210206	<b>Ref. No.</b> 052103
	drain tray L 360mm W 345mm ø 122mm		

			
<b>GEV No.</b>	105006	<b>Ref. No.</b>	058187
<b>description</b>	burner cap ø 122mm with central hole		
<b>accessories for</b>	105006		
	<b>GEV No.</b>	105005	<b>Ref. No.</b> 058184
	burner head for burner cap ø 122mm		
	<b>GEV No.</b>	105055	<b>Ref. No.</b> 052116
	air mixing sleeve L 40mm ED ø 43mm ID ø 40mm aluminium		
	<b>GEV No.</b>	105241	<b>Ref. No.</b> 002463
	burner head for burner cap ø 122mm		
	<b>GEV No.</b>	105243	<b>Ref. No.</b> 002460
	venturi for burner cap ø 122mm		
	<b>GEV No.</b>	105244	<b>Ref. No.</b> 002197
	spacer piece for Venturi		
	<b>GEV No.</b>	210207	<b>Ref. No.</b> 052104
	drain tray L 360mm W 345mm ø 145mm		









			
<b>GEV No.</b>	105002	<b>Ref. No.</b>	058185
<b>description</b>	burner cap ø 83mm chrome-plated		
<b>accessories for</b>	105002		
	<b>GEV No.</b>	105001	<b>Ref. No.</b> 058182
	burner lower part ø 84mm for burner cap ø 83mm		
	<b>GEV No.</b>	105055	<b>Ref. No.</b> 052116
	air mixing sleeve L 40mm ED ø 43mm ID ø 40mm aluminium		
	<b>GEV No.</b>	105235	<b>Ref. No.</b> 002461
	burner head ø 163mm for burner cap ø 83mm		
	<b>GEV No.</b>	105237	<b>Ref. No.</b> 002458
	venturi for burner cap ø 83mm		

Table continues overleaf





<b>accessories for</b>	105002			
	GEV No.	210205	Ref. No.	052102
	drain tray L 345mm W 360mm H 38mm ø 105mm PTFE coated steel			



<b>GEV No.</b>	105005	<b>Ref. No.</b>	058184	
<b>description</b>	burner head for burner cap ø 122mm			
<b>accessories for</b>	105005			
	GEV No.	105006	Ref. No.	058187
	burner cap ø 122mm with central hole			
	GEV No.	105055	Ref. No.	052116
	air mixing sleeve L 40mm ED ø 43mm ID ø 40mm aluminium			
	GEV No.	210207	Ref. No.	052104
	drain tray L 360mm W 345mm ø 145mm			

<b>accessories for</b>	105003			
	GEV No.	210206	Ref. No.	052103
	drain tray L 360mm W 345mm ø 122mm			





<b>GEV No.</b>	105001	<b>Ref. No.</b>	058182	
<b>description</b>	burner lower part ø 84mm for burner cap ø 83mm			
<b>accessories for</b>	105001			
	GEV No.	105002	Ref. No.	058185
	burner cap ø 83mm chrome-plated			
	GEV No.	105055	Ref. No.	052116
	air mixing sleeve L 40mm ED ø 43mm ID ø 40mm aluminium			
	GEV No.	210205	Ref. No.	052102
	drain tray L 345mm W 360mm H 38mm ø 105mm PTFE coated steel			



<b>GEV No.</b>	105712	<b>Ref. No.</b>	052118	
<b>description</b>	burner head for burner cap ø 122mm			
<b>spare parts for</b>	105712			
	GEV No.	105006	Ref. No.	058187
	burner cap ø 122mm with central hole			



<b>GEV No.</b>	105003	<b>Ref. No.</b>	058183	
<b>description</b>	burner lower part ø 103mm for burner cap ø 102mm			
<b>accessories for</b>	105003			
	GEV No.	105004	Ref. No.	058186
	burner cap ø 102mm			
	GEV No.	105055	Ref. No.	052116
	air mixing sleeve L 40mm ED ø 43mm ID ø 40mm aluminium			

HD900 series





	1	<b>GEV No.</b>	105055	<b>Ref. No.</b>	052116
		<b>description</b>	air mixing sleeve L 40mm ED ø 43mm ID ø 40mm aluminium		
<b>accessories for</b>	105055				
	GEV No.	104564	Ref. No.	054193	
	burner cap ø 120mm 32 bores inside				
	GEV No.	104565	Ref. No.	054246	
	burner head for burner cap ø 120mm				
	GEV No.	104570	Ref. No.	004280	
	burner cap ø 120mm 16 bores inside				
	GEV No.	104571	Ref. No.	004279	
	burner head for burner cap ø 120mm				
	GEV No.	105001	Ref. No.	058182	
	burner lower part ø 84mm for burner cap ø 83mm				
	GEV No.	105002	Ref. No.	058185	
	burner cap ø 83mm chrome-plated				
	GEV No.	105003	Ref. No.	058183	
	burner lower part ø 103mm for burner cap ø 102mm				
	GEV No.	105004	Ref. No.	058186	
	burner cap ø 102mm				

Table continues overleaf



<b>accessories for</b> 105055				
	GEV No.	105005	Ref. No.	058184
burner head for burner cap ø 122mm				
	GEV No.	105006	Ref. No.	058187
burner cap ø 122mm with central hole				
	GEV No.	210205	Ref. No.	052102
drain tray L 345mm W 360mm H 38mm ø 105mm PTFE coated steel				
	GEV No.	210206	Ref. No.	052103
drain tray L 360mm W 345mm ø 122mm				
	GEV No.	210207	Ref. No.	052104
drain tray L 360mm W 345mm ø 145mm				

				
1				
<b>GEV No.</b>	105004	<b>Ref. No.</b>	058186	
<b>description</b>	burner cap ø 102mm			
<b>accessories for</b>	105004			
	GEV No.	105003	Ref. No.	058183
burner lower part ø 103mm for burner cap ø 102mm				
	GEV No.	105055	Ref. No.	052116
air mixing sleeve L 40mm ED ø 43mm ID ø 40mm aluminium				
	GEV No.	105238	Ref. No.	002462
burner head for burner cap ø 102mm				
	GEV No.	105240	Ref. No.	002459
venturi for burner cap ø 102mm				
	GEV No.	210206	Ref. No.	052103
drain tray L 360mm W 345mm ø 122mm				

				
1				
<b>GEV No.</b>	105006	<b>Ref. No.</b>	058187	
<b>description</b>	burner cap ø 122mm with central hole			
<b>accessories for</b>	105006			
	GEV No.	105005	Ref. No.	058184
burner head for burner cap ø 122mm				
	GEV No.	105055	Ref. No.	052116
air mixing sleeve L 40mm ED ø 43mm ID ø 40mm aluminium				
	GEV No.	105241	Ref. No.	002463
burner head for burner cap ø 122mm				
	GEV No.	105243	Ref. No.	002460
venturi for burner cap ø 122mm				

<b>accessories for</b> 105006				
	GEV No.	105244	Ref. No.	002197
spacer piece for Venturi				
	GEV No.	210207	Ref. No.	052104
drain tray L 360mm W 345mm ø 145mm				

				
1				
<b>GEV No.</b>	105002	<b>Ref. No.</b>	058185	
<b>description</b>	burner cap ø 83mm chrome-plated			
<b>accessories for</b>	105002			
	GEV No.	105001	Ref. No.	058182
burner lower part ø 84mm for burner cap ø 83mm				
	GEV No.	105055	Ref. No.	052116
air mixing sleeve L 40mm ED ø 43mm ID ø 40mm aluminium				
	GEV No.	105235	Ref. No.	002461
burner head ø 163mm for burner cap ø 83mm				
	GEV No.	105237	Ref. No.	002458
venturi for burner cap ø 83mm				
	GEV No.	210205	Ref. No.	052102
drain tray L 345mm W 360mm H 38mm ø 105mm PTFE coated steel				

				
1				
<b>GEV No.</b>	105238	<b>Ref. No.</b>	002462	
<b>description</b>	burner head for burner cap ø 102mm			
<b>accessories for</b>	105238			
	GEV No.	105004	Ref. No.	058186
burner cap ø 102mm				







				
1				
<b>GEV No.</b>	105241	<b>Ref. No.</b>	002463	
<b>description</b>	burner head for burner cap ø 122mm			
<b>accessories for</b>	105241			
	GEV No.	105006	Ref. No.	058187
burner cap ø 122mm with central hole				
	GEV No.	105055	Ref. No.	052116
air mixing sleeve L 40mm ED ø 43mm ID ø 40mm aluminium				
	GEV No.	105243	Ref. No.	002460
venturi for burner cap ø 122mm				

Table continues overleaf







<b>accessories for</b>	105241		
	<b>GEV No.</b>	105244	<b>Ref. No.</b> 002197
spacer piece for Venturi			

 <p>1</p>			
<b>GEV No.</b>	105235	<b>Ref. No.</b>	002461
<b>description</b>	burner head ø 163mm for burner cap ø 83mm		
<b>accessories for</b>	105235		
	<b>GEV No.</b>	105002	<b>Ref. No.</b> 058185
burner cap ø 83mm chrome-plated			

 <p>1</p>			
<b>GEV No.</b>	105244	<b>Ref. No.</b>	002197
<b>description</b>	spacer piece for Venturi		
<b>accessories for</b>	105244		
	<b>GEV No.</b>	105006	<b>Ref. No.</b> 058187
burner cap ø 122mm with central hole			
	<b>GEV No.</b>	105055	<b>Ref. No.</b> 052116
air mixing sleeve L 40mm ED ø 43mm ID ø 40mm aluminium			
	<b>GEV No.</b>	105241	<b>Ref. No.</b> 002463
burner head for burner cap ø 122mm			
	<b>GEV No.</b>	105243	<b>Ref. No.</b> 002460
venturi for burner cap ø 122mm			

 <p>1</p>			
<b>GEV No.</b>	105240	<b>Ref. No.</b>	002459
<b>description</b>	venturi for burner cap ø 102mm		

 <p>1</p>			
<b>GEV No.</b>	105243	<b>Ref. No.</b>	002460
<b>description</b>	venturi for burner cap ø 122mm		
<b>accessories for</b>	105243		
	<b>GEV No.</b>	105006	<b>Ref. No.</b> 058187
burner cap ø 122mm with central hole			

<b>accessories for</b>	105243		
	<b>GEV No.</b>	105055	<b>Ref. No.</b> 052116
air mixing sleeve L 40mm ED ø 43mm ID ø 40mm aluminium			
	<b>GEV No.</b>	105241	<b>Ref. No.</b> 002463
burner head for burner cap ø 122mm			
	<b>GEV No.</b>	105244	<b>Ref. No.</b> 002197
spacer piece for Venturi			

 <p>1</p>			
<b>GEV No.</b>	105237	<b>Ref. No.</b>	002458
<b>description</b>	venturi for burner cap ø 83mm		

<b>N700, N900 series</b>			
 <p>1</p>			
<b>GEV No.</b>	104558	<b>Ref. No.</b>	0C0128
<b>description</b>	burner cap ø 100mm 10kW		

 <p>1</p>			
<b>GEV No.</b>	104554	<b>Ref. No.</b>	0C0129
<b>description</b>	burner cap ø 62mm 6kW		

 <p>1</p>			
<b>GEV No.</b>	104555	<b>Ref. No.</b>	0C0127
<b>description</b>	burner head for burner cap ø 62mm 6kW		

 <p>1</p>			
<b>GEV No.</b>	104559	<b>Ref. No.</b>	0C0126
<b>description</b>	burner head ø 99mm for burner cap ø 100mm 10kW H 25mm seat ø 46.5mm		

			
1			
<b>GEV No.</b>	104557	<b>Ref. No.</b>	0C0124
<b>description</b>	burner holder		

			
1			
<b>GEV No.</b>	532505	<b>Ref. No.</b>	0C0188
<b>description</b>	O-ring silicone thickness 1.78mm ID ø 33.05mm Qty 1 pcs		

			
1			
<b>GEV No.</b>	104560	<b>Ref. No.</b>	0C0133
<b>description</b>	venturi for burner cap ø 100mm 10kW		

			
1			
<b>GEV No.</b>	104556	<b>Ref. No.</b>	0C0125
<b>description</b>	venturi for burner cap ø 62mm 6kW		

SL90, Stratos850/900, Janus1100 series

			
1			
<b>GEV No.</b>	103087	<b>Ref. No.</b>	0H6320
<b>description</b>	burner cap D ø 95mm with central hole		

			
1			
<b>GEV No.</b>	103088	<b>Ref. No.</b>	0H6321
<b>description</b>	burner cap E ø 115mm with central hole		

			
1			
<b>GEV No.</b>	104028	<b>Ref. No.</b>	0H6340
<b>description</b>	burner head D for burner cap ø 95mm		

			
1			
<b>GEV No.</b>	104029	<b>Ref. No.</b>	0H6341
<b>description</b>	burner head E for burner cap ø 115mm		

			
1			
<b>GEV No.</b>	104043	<b>Ref. No.</b>	0H7155
<b>description</b>	burner lower part D for burner cap ø 95mm		











			
1			
<b>GEV No.</b>	104044	<b>Ref. No.</b>	0G1811
<b>description</b>	burner lower part E for burner cap ø 115mm		

			
1			
<b>GEV No.</b>	103007	<b>Ref. No.</b>	0H6863
<b>description</b>	O-ring Viton thickness 5mm ID ø 42.5mm Qty 1 pcs		





1100 (1) series

			
1			
<b>GEV No.</b>	103093	<b>Ref. No.</b>	003569
<b>description</b>	burner head for burner cap ø 78mm suitable for ZANUSSI		





old series			
	1		
<b>GEV No.</b>	105056	<b>Ref. No.</b>	053448
<b>description</b>	air mixing sleeve L 43mm ED ø 43mm ID ø 40mm aluminium		
<b>accessories for</b>	105056		
	GEV No.	101947	Ref. No. 058331
	bracket for igniter/thermocouple		
	GEV No.	105008	Ref. No. 056747
	burner ring for burner cap ø 70mm		
	GEV No.	105011	Ref. No. 056748
	burner ring for burner cap ø 100mm		
	GEV No.	105012	Ref. No. 002443
	burner cap ø 100mm		
	GEV No.	105231	Ref. No. 054091
	burner head for burner cap ø 70mm with nozzle holder for plug-in nozzle		
	GEV No.	105232	Ref. No. 002442
	burner cap ø 70mm		
	GEV No.	105233	Ref. No. 054092
	burner head for burner cap ø 100mm with nozzle holder for plug-in nozzle		
	GEV No.	105270	Ref. No. 054093
	gasket for burner cap ø 70mm		
	GEV No.	105271	Ref. No. 054094
	gasket for burner cap ø 100mm		

	1		
<b>GEV No.</b>	105015	<b>Ref. No.</b>	052527
<b>description</b>	burner cap ø 120mm		

	1		
<b>GEV No.</b>	105002	<b>Ref. No.</b>	058185
<b>description</b>	burner cap ø 83mm chrome-plated		
<b>accessories for</b>	105002		
	GEV No.	105001	Ref. No. 058182
	burner lower part ø 84mm for burner cap ø 83mm		
	GEV No.	105055	Ref. No. 052116
	air mixing sleeve L 40mm ED ø 43mm ID ø 40mm aluminium		
	GEV No.	105235	Ref. No. 002461
	burner head ø 163mm for burner cap ø 83mm		
	GEV No.	105237	Ref. No. 002458
	venturi for burner cap ø 83mm		

<b>accessories for</b>	105002		
	GEV No.	210205	Ref. No. 052102
	drain tray L 345mm W 360mm H 38mm ø 105mm PTFE coated steel		

	1		
<b>GEV No.</b>	105014	<b>Ref. No.</b>	052531
<b>description</b>	burner head for burner cap ø 120mm		

	1		
<b>GEV No.</b>	105013	<b>Ref. No.</b>	050694
<b>description</b>	burner head for burner cap ø 83mm		

700, R701, MD700 solid tops series













	1		
<b>GEV No.</b>	105055	<b>Ref. No.</b>	052116
<b>description</b>	air mixing sleeve L 40mm ED ø 43mm ID ø 40mm aluminium		
<b>accessories for</b>	105055		
	GEV No.	104564	Ref. No. 054193
	burner cap ø 120mm 32 bores inside		
	GEV No.	104565	Ref. No. 054246
	burner head for burner cap ø 120mm		
	GEV No.	104570	Ref. No. 004280
	burner cap ø 120mm 16 bores inside		
	GEV No.	104571	Ref. No. 004279
	burner head for burner cap ø 120mm		
	GEV No.	105001	Ref. No. 058182
	burner lower part ø 84mm for burner cap ø 83mm		
	GEV No.	105002	Ref. No. 058185
	burner cap ø 83mm chrome-plated		
	GEV No.	105003	Ref. No. 058183
	burner lower part ø 103mm for burner cap ø 102mm		
	GEV No.	105004	Ref. No. 058186
	burner cap ø 102mm		
	GEV No.	105005	Ref. No. 058184
	burner head for burner cap ø 122mm		
	GEV No.	105006	Ref. No. 058187
	burner cap ø 122mm with central hole		



Table continues overleaf

<b>accessories for</b>	105055		
	GEV No.	210205	Ref. No. 052102
	drain tray L 345mm W 360mm H 38mm ø 105mm PTFE coated steel		
	GEV No.	210206	Ref. No. 052103
	drain tray L 360mm W 345mm ø 122mm		
	GEV No.	210207	Ref. No. 052104
	drain tray L 360mm W 345mm ø 145mm		

	1		
<b>GEV No.</b>	104564	<b>Ref. No.</b>	054193
<b>description</b>	burner cap ø 120mm 32 bores inside		
<b>accessories for</b>	104564		
	GEV No.	104565	Ref. No. 054246
	burner head for burner cap ø 120mm		
	GEV No.	104566	Ref. No. 054536
	cover ø 120mm solid top range		
	GEV No.	105055	Ref. No. 052116
	air mixing sleeve L 40mm ED ø 43mm ID ø 40mm aluminium		

	1		
<b>GEV No.</b>	104565	<b>Ref. No.</b>	054246
<b>description</b>	burner head for burner cap ø 120mm		
<b>accessories for</b>	104565		
	GEV No.	104564	Ref. No. 054193
	burner cap ø 120mm 32 bores inside		
	GEV No.	104566	Ref. No. 054536
	cover ø 120mm solid top range		
	GEV No.	105055	Ref. No. 052116
	air mixing sleeve L 40mm ED ø 43mm ID ø 40mm aluminium		

	1		
<b>GEV No.</b>	104566	<b>Ref. No.</b>	054536
<b>description</b>	cover ø 120mm solid top range		
<b>accessories for</b>	104566		
	GEV No.	104564	Ref. No. 054193
	burner cap ø 120mm 32 bores inside		
	GEV No.	104565	Ref. No. 054246
	burner head for burner cap ø 120mm		

<b>accessories for</b>	104566		
	GEV No.	104570	Ref. No. 004280
	burner cap ø 120mm 16 bores inside		
	GEV No.	104571	Ref. No. 004279
	burner head for burner cap ø 120mm		
	GEV No.	105055	Ref. No. 052116
	air mixing sleeve L 40mm ED ø 43mm ID ø 40mm aluminium		

<b>N700, PR700 solid tops series</b>			
	1		
<b>GEV No.</b>	105055	<b>Ref. No.</b>	052116
<b>description</b>	air mixing sleeve L 40mm ED ø 43mm ID ø 40mm aluminium		
<b>accessories for</b>	105055		
	GEV No.	104564	Ref. No. 054193
	burner cap ø 120mm 32 bores inside		
	GEV No.	104565	Ref. No. 054246
	burner head for burner cap ø 120mm		
	GEV No.	104570	Ref. No. 004280
	burner cap ø 120mm 16 bores inside		
	GEV No.	104571	Ref. No. 004279
	burner head for burner cap ø 120mm		
	GEV No.	105001	Ref. No. 058182
	burner lower part ø 84mm for burner cap ø 83mm		
	GEV No.	105002	Ref. No. 058185
	burner cap ø 83mm chrome-plated		
	GEV No.	105003	Ref. No. 058183
	burner lower part ø 103mm for burner cap ø 102mm		
	GEV No.	105004	Ref. No. 058186
	burner cap ø 102mm		
	GEV No.	105005	Ref. No. 058184
	burner head for burner cap ø 122mm		
	GEV No.	105006	Ref. No. 058187
	burner cap ø 122mm with central hole		
	GEV No.	210205	Ref. No. 052102
	drain tray L 345mm W 360mm H 38mm ø 105mm PTFE coated steel		
	GEV No.	210206	Ref. No. 052103
	drain tray L 360mm W 345mm ø 122mm		
	GEV No.	210207	Ref. No. 052104
	drain tray L 360mm W 345mm ø 145mm		















			
1			
<b>GEV No.</b>	104570	<b>Ref. No.</b>	004280
<b>description</b>	burner cap ø 120mm 16 bores inside		
<b>accessories for</b>	104570		
	<b>GEV No.</b>	104566	<b>Ref. No.</b> 054536
	cover ø 120mm solid top range		
	<b>GEV No.</b>	104571	<b>Ref. No.</b> 004279
	burner head for burner cap ø 120mm		
	<b>GEV No.</b>	105055	<b>Ref. No.</b> 052116
	air mixing sleeve L 40mm ED ø 43mm ID ø 40mm aluminium		

			
1			
<b>GEV No.</b>	104571	<b>Ref. No.</b>	004279
<b>description</b>	burner head for burner cap ø 120mm		
<b>accessories for</b>	104571		
	<b>GEV No.</b>	104566	<b>Ref. No.</b> 054536
	cover ø 120mm solid top range		
	<b>GEV No.</b>	104570	<b>Ref. No.</b> 004280
	burner cap ø 120mm 16 bores inside		
	<b>GEV No.</b>	105055	<b>Ref. No.</b> 052116
	air mixing sleeve L 40mm ED ø 43mm ID ø 40mm aluminium		





			
1			
<b>GEV No.</b>	104566	<b>Ref. No.</b>	054536
<b>description</b>	cover ø 120mm solid top range		
<b>accessories for</b>	104566		
	<b>GEV No.</b>	104564	<b>Ref. No.</b> 054193
	burner cap ø 120mm 32 bores inside		
	<b>GEV No.</b>	104565	<b>Ref. No.</b> 054246
	burner head for burner cap ø 120mm		
	<b>GEV No.</b>	104570	<b>Ref. No.</b> 004280
	burner cap ø 120mm 16 bores inside		
	<b>GEV No.</b>	104571	<b>Ref. No.</b> 004279
	burner head for burner cap ø 120mm		
	<b>GEV No.</b>	105055	<b>Ref. No.</b> 052116
	air mixing sleeve L 40mm ED ø 43mm ID ø 40mm aluminium		





900, N900, HD900, Janus1100 solid tops series			
			
1			
<b>GEV No.</b>	104572	<b>Ref. No.</b>	052500
<b>description</b>	bracket for gas burner		
<b>accessories for</b>	104572		
	<b>GEV No.</b>	105024	<b>Ref. No.</b> 052376
	burner head for burner cap ø 180mm		
	<b>GEV No.</b>	105025	<b>Ref. No.</b> 052374
	cover ø 80mm solid top range		
	<b>GEV No.</b>	105026	<b>Ref. No.</b> 052377
	burner cap ø 180mm with central hole		

			
1			
<b>GEV No.</b>	105026	<b>Ref. No.</b>	052377
<b>description</b>	burner cap ø 180mm with central hole		
<b>accessories for</b>	105026		
	<b>GEV No.</b>	104572	<b>Ref. No.</b> 052500
	bracket for gas burner		
	<b>GEV No.</b>	105024	<b>Ref. No.</b> 052376
	burner head for burner cap ø 180mm		
	<b>GEV No.</b>	105025	<b>Ref. No.</b> 052374
	cover ø 80mm solid top range		

			
1			
<b>GEV No.</b>	105024	<b>Ref. No.</b>	052376
<b>description</b>	burner head for burner cap ø 180mm		
<b>accessories for</b>	105024		
	<b>GEV No.</b>	104572	<b>Ref. No.</b> 052500
	bracket for gas burner		
	<b>GEV No.</b>	105025	<b>Ref. No.</b> 052374
	cover ø 80mm solid top range		
	<b>GEV No.</b>	105026	<b>Ref. No.</b> 052377
	burner cap ø 180mm with central hole		





			
1			
<b>GEV No.</b>	104743	<b>Ref. No.</b>	059374
<b>description</b>	burner head for burner cap ø 180mm with venturi		
<b>accessories for</b>	104743		
	<b>GEV No.</b>	101345	<b>Ref. No.</b> 020997
	nut thread M15x1 H 3mm WS 19 brass Qty 1 pcs		
	<b>GEV No.</b>	105025	<b>Ref. No.</b> 052374
	cover ø 80mm solid top range		
	<b>GEV No.</b>	105026	<b>Ref. No.</b> 052377
	burner cap ø 180mm with central hole		

			
1			
<b>GEV No.</b>	105025	<b>Ref. No.</b>	052374
<b>description</b>	cover ø 80mm solid top range		
<b>accessories for</b>	105025		
	<b>GEV No.</b>	104572	<b>Ref. No.</b> 052500
	bracket for gas burner		
	<b>GEV No.</b>	105024	<b>Ref. No.</b> 052376
	burner head for burner cap ø 180mm		
	<b>GEV No.</b>	105026	<b>Ref. No.</b> 052377
	burner cap ø 180mm with central hole		

## stockpot stoves

			
1			
<b>GEV No.</b>	105028	<b>Ref. No.</b>	026643
<b>description</b>	burner cap ø 200mm with central hole		
<b>accessories for</b>	105028		
	<b>GEV No.</b>	105027	<b>Ref. No.</b> 0HB190
	burner head for burner cap ø 200mm		

			
1			
<b>GEV No.</b>	105027	<b>Ref. No.</b>	0HB190
<b>description</b>	burner head for burner cap ø 200mm		
<b>accessories for</b>	105027		
	<b>GEV No.</b>	105028	<b>Ref. No.</b> 026643
	burner cap ø 200mm with central hole		

## boiling tops (1)

			
1			
<b>GEV No.</b>	105023	<b>Ref. No.</b>	020986
<b>description</b>	burner cap ø 145mm		

			
1			
<b>GEV No.</b>	105307	<b>Ref. No.</b>	020985
<b>description</b>	burner cap ø 80mm		

			
1			
<b>GEV No.</b>	105308	<b>Ref. No.</b>	020984
<b>description</b>	burner head		

			
1			
<b>GEV No.</b>	105022	<b>Ref. No.</b>	020954
<b>description</b>	burner head for burner cap ø 145mm		





table cookers (2)

			
1			
<b>GEV No.</b>	105006	<b>Ref. No.</b>	058187
<b>description</b>	burner cap ø 122mm with central hole		
<b>accessories for</b>	105006		
	<b>GEV No.</b>	105005	<b>Ref. No.</b> 058184
	burner head for burner cap ø 122mm		
	<b>GEV No.</b>	105055	<b>Ref. No.</b> 052116
	air mixing sleeve L 40mm ED ø 43mm ID ø 40mm aluminium		
	<b>GEV No.</b>	105241	<b>Ref. No.</b> 002463
	burner head for burner cap ø 122mm		
	<b>GEV No.</b>	105243	<b>Ref. No.</b> 002460
	venturi for burner cap ø 122mm		
	<b>GEV No.</b>	105244	<b>Ref. No.</b> 002197
	spacer piece for Venturi		
	<b>GEV No.</b>	210207	<b>Ref. No.</b> 052104
	drain tray L 360mm W 345mm ø 145mm		

			
1			
<b>GEV No.</b>	105002	<b>Ref. No.</b>	058185
<b>description</b>	burner cap ø 83mm chrome-plated		
<b>accessories for</b>	105002		
	<b>GEV No.</b>	105001	<b>Ref. No.</b> 058182
	burner lower part ø 84mm for burner cap ø 83mm		
	<b>GEV No.</b>	105055	<b>Ref. No.</b> 052116
	air mixing sleeve L 40mm ED ø 43mm ID ø 40mm aluminium		
	<b>GEV No.</b>	105235	<b>Ref. No.</b> 002461
	burner head ø 163mm for burner cap ø 83mm		
	<b>GEV No.</b>	105237	<b>Ref. No.</b> 002458
	venturi for burner cap ø 83mm		
	<b>GEV No.</b>	210205	<b>Ref. No.</b> 052102
	drain tray L 345mm W 360mm H 38mm ø 105mm PTFE coated steel		

			
1			
<b>GEV No.</b>	105241	<b>Ref. No.</b>	002463
<b>description</b>	burner head for burner cap ø 122mm		
<b>accessories for</b>	105241		
	<b>GEV No.</b>	105006	<b>Ref. No.</b> 058187
	burner cap ø 122mm with central hole		
	<b>GEV No.</b>	105055	<b>Ref. No.</b> 052116
	air mixing sleeve L 40mm ED ø 43mm ID ø 40mm aluminium		
	<b>GEV No.</b>	105243	<b>Ref. No.</b> 002460
	venturi for burner cap ø 122mm		
	<b>GEV No.</b>	105244	<b>Ref. No.</b> 002197
	spacer piece for Venturi		

			
1			
<b>GEV No.</b>	105235	<b>Ref. No.</b>	002461
<b>description</b>	burner head ø 163mm for burner cap ø 83mm		
<b>accessories for</b>	105235		
	<b>GEV No.</b>	105002	<b>Ref. No.</b> 058185
	burner cap ø 83mm chrome-plated		

			
1			
<b>GEV No.</b>	105243	<b>Ref. No.</b>	002460
<b>description</b>	venturi for burner cap ø 122mm		
<b>accessories for</b>	105243		
	<b>GEV No.</b>	105006	<b>Ref. No.</b> 058187
	burner cap ø 122mm with central hole		
	<b>GEV No.</b>	105055	<b>Ref. No.</b> 052116
	air mixing sleeve L 40mm ED ø 43mm ID ø 40mm aluminium		
	<b>GEV No.</b>	105241	<b>Ref. No.</b> 002463
	burner head for burner cap ø 122mm		
	<b>GEV No.</b>	105244	<b>Ref. No.</b> 002197
	spacer piece for Venturi		



			
1			
<b>GEV No.</b>	105237	<b>Ref. No.</b>	002458
<b>description</b>	venturi for burner cap ø 83mm		

### pan supports

			
1			
<b>GEV No.</b>	210211	<b>Ref. No.</b>	OG2033
<b>description</b>	pan support W 175mm L 360mm		

			
1			
<b>GEV No.</b>	210027	<b>Ref. No.</b>	0C2526
<b>description</b>	pan support W 284mm L 386mm H 51mm suitable for ELECTROLUX, ZANUSSI		

			
1			
<b>GEV No.</b>	210138	<b>Ref. No.</b>	002436
<b>description</b>	pan support W 285mm L 345mm		

			
1			
<b>GEV No.</b>	210155	<b>Ref. No.</b>	004976
<b>description</b>	pan support W 320mm L 530mm		

			
1			
<b>GEV No.</b>	210148	<b>Ref. No.</b>	002446
<b>description</b>	pan support W 340mm L 595mm		

			
1			
<b>GEV No.</b>	210139	<b>Ref. No.</b>	058179
<b>description</b>	pan support W 345mm L 395mm		

			
1			
<b>GEV No.</b>	210146	<b>Ref. No.</b>	002437
<b>description</b>	pan support W 350mm L 390mm		

			
1			
<b>GEV No.</b>	210208	<b>Ref. No.</b>	0C0132
<b>description</b>	pan support W 370mm L 380mm		

			
1			
<b>GEV No.</b>	210209	<b>Ref. No.</b>	0C0130
<b>description</b>	pan support W 370mm L 395mm		

### reducers for pan supports

			
1			
<b>GEV No.</b>	210001	<b>Ref. No.</b>	025056
<b>description</b>	reducer for pan support L 265mm W 265mm SS suitable for universal		



spillage trays



1

<b>GEV No.</b>	210205	<b>Ref. No.</b>	052102
<b>description</b>	drain tray L 345mm W 360mm H 38mm ø 105mm PTFE coated steel		



1

<b>GEV No.</b>	210206	<b>Ref. No.</b>	052103
<b>description</b>	drain tray L 360mm W 345mm ø 122mm		



1

<b>GEV No.</b>	210207	<b>Ref. No.</b>	052104
<b>description</b>	drain tray L 360mm W 345mm ø 145mm		

accessories

reducers for pan supports



1

<b>GEV No.</b>	210001	<b>Ref. No.</b>	025056
<b>description</b>	reducer for pan support L 265mm W 265mm SS suitable for universal		



1

<b>GEV No.</b>	210002	<b>Ref. No.</b>	0A2000
<b>description</b>	reducer for pan support L 340mm W 100mm		

pan supports



1

<b>GEV No.</b>	210211	<b>Ref. No.</b>	0G2033
<b>description</b>	pan support W 175mm L 360mm		



1

<b>GEV No.</b>	210027	<b>Ref. No.</b>	0C2526
<b>description</b>	pan support W 284mm L 386mm H 51mm suitable for ELECTROLUX, ZANUSSI		



1

<b>GEV No.</b>	210138	<b>Ref. No.</b>	002436
<b>description</b>	pan support W 285mm L 345mm		



1

<b>GEV No.</b>	210155	<b>Ref. No.</b>	004976
<b>description</b>	pan support W 320mm L 530mm		



1

<b>GEV No.</b>	210148	<b>Ref. No.</b>	002446
<b>description</b>	pan support W 340mm L 595mm		



1

<b>GEV No.</b>	210122	<b>Ref. No.</b>	0KC890
<b>description</b>	pan support W 340mm L 730mm B-B burner		



1

<b>GEV No.</b>	210139	<b>Ref. No.</b>	058179
<b>description</b>	pan support W 345mm L 395mm		



1

<b>GEV No.</b>	210131	<b>Ref. No.</b>	0K1983
<b>description</b>	pan support W 345mm L 800mm C-C/C-D/D-E burner		



1

<b>GEV No.</b>	210130	<b>Ref. No.</b>	0K2331
<b>description</b>	pan support W 345mm L 810mm D-E burner		



1

<b>GEV No.</b>	210146	<b>Ref. No.</b>	002437
<b>description</b>	pan support W 350mm L 390mm		



1

<b>GEV No.</b>	210208	<b>Ref. No.</b>	0C0132
<b>description</b>	pan support W 370mm L 380mm		



1

<b>GEV No.</b>	210209	<b>Ref. No.</b>	0C0130
<b>description</b>	pan support W 370mm L 395mm		

**spillage trays**



1

<b>GEV No.</b>	210205	<b>Ref. No.</b>	052102
<b>description</b>	drain tray L 345mm W 360mm H 38mm ø 105mm PTFE coated steel		



1

<b>GEV No.</b>	210206	<b>Ref. No.</b>	052103
<b>description</b>	drain tray L 360mm W 345mm ø 122mm		



1

<b>GEV No.</b>	210207	<b>Ref. No.</b>	052104
<b>description</b>	drain tray L 360mm W 345mm ø 145mm		

**air mixers**



1

<b>GEV No.</b>	104569	<b>Ref. No.</b>	002527
<b>description</b>	air mixer		



1

<b>GEV No.</b>	105057	<b>Ref. No.</b>	026217
<b>description</b>	air mixing tube		











			
1			
<b>GEV No.</b>	106615	<b>Ref. No.</b>	051389
<b>description</b>	air mixing tube L 42mm ø 22mm		

bar burners

bar burners

			
1			
<b>GEV No.</b>	105769	<b>Ref. No.</b>	003709
<b>description</b>	bar burner 1-row ø 50mm Wmm Hmm L 340mm flange width 57mm flange length 57mm convection oven		

			
1			
<b>GEV No.</b>	104128	<b>Ref. No.</b>	052855
<b>description</b>	bar burner 2 row L 390mm W 180mm ømm H 45mm 6.4kW charrill		
<b>accessories for</b>	104128		
	<b>GEV No.</b>	100562	<b>Ref. No.</b> 050591
	gas injector bore ø 2.15mm		
	<b>GEV No.</b>	100574	<b>Ref. No.</b> 026786
	gas injector bore ø 1.4mm		
	<b>GEV No.</b>	100579	<b>Ref. No.</b> 026718
	gas injector bore ø 1.3mm		
	<b>GEV No.</b>	101345	<b>Ref. No.</b> 020997
	nut thread M15x1 H 3mm WS 19 brass Qty 1 pcs		
	<b>GEV No.</b>	101346	<b>Ref. No.</b> 025902
	union nut nozzle holder		
	<b>GEV No.</b>	101347	<b>Ref. No.</b> 020988
	nozzle holder angled		
	<b>GEV No.</b>	106615	<b>Ref. No.</b> 051389
	air mixing tube L 42mm ø 22mm		

			
1			
<b>GEV No.</b>	104573	<b>Ref. No.</b>	058979
<b>description</b>	bar burner 2 row L 400mm W 420mm ømm H 50mm oven		

			
1			
<b>GEV No.</b>	105642	<b>Ref. No.</b>	026864
<b>description</b>	bar burner 2 row L 420mm W 125mm ømm H 95mm fryer		

			
1			
<b>GEV No.</b>	104122	<b>Ref. No.</b>	056655
<b>description</b>	bar burner 2 row L 430mm W 205mm ømm H 45mm 6.95kW charrill		

			
1			
<b>GEV No.</b>	105483	<b>Ref. No.</b>	005656
<b>description</b>	bar burner 2 row L 468mm W 200mm ømm H 45mm charrill		

			
1			
<b>GEV No.</b>	104578	<b>Ref. No.</b>	004591
<b>description</b>	bar burner 2 row L 510mm W 190mm ømm H 40mm griddle		

			
1			
<b>GEV No.</b>	105637	<b>Ref. No.</b>	059523
<b>description</b>	bar burner 2 row L 520mm W 235mm ømm H 90mm pasta cooker		

			
1			
<b>GEV No.</b>	105640	<b>Ref. No.</b>	056877
<b>description</b>	bar burner 2 row L 525mm W 210mm ømm H 90mm pasta cooker		





			
1			
<b>GEV No.</b>	104584	<b>Ref. No.</b>	006462
<b>description</b>	bar burner 2 row L 545mm W 190mm ømm H 50mm multi purpose roasting pan		

			
1			
<b>GEV No.</b>	104581	<b>Ref. No.</b>	006650
<b>description</b>	bar burner 2 row L 550mm W 190mm ømm H 50mm griddle		

			
1			
<b>GEV No.</b>	104582	<b>Ref. No.</b>	002358
<b>description</b>	bar burner 2 row L 580mm W 225mm ømm H 45mm chargrill		

			
1			
<b>GEV No.</b>	104157	<b>Ref. No.</b>	051716
<b>description</b>	bar burner 3 row L 460mm W 355mm ømm H mm kettle		

			
1			
<b>GEV No.</b>	104583	<b>Ref. No.</b>	0C0490
<b>description</b>	bar burner 3 row L 640mm ømm H 265mm chargrill		

			
1			
<b>GEV No.</b>	104580	<b>Ref. No.</b>	0A5124
<b>description</b>	bar burner 3 row L 645mm W 190mm ømm H 45mm griddle		

			
1			
<b>GEV No.</b>	104585	<b>Ref. No.</b>	006471
<b>description</b>	bar burner 4 row L 415mm W 490mm ømm H 40mm multi purpose roasting pan		

			
1			
<b>GEV No.</b>	105647	<b>Ref. No.</b>	004353
<b>description</b>	bar burner 4 row L 450mm W 455mm ømm H 245mm tilting bratt pan		

			
1			
<b>GEV No.</b>	105660	<b>Ref. No.</b>	059506
<b>description</b>	bar burner 4 row L 475mm W 470mm ømm kettle		

			
1			
<b>GEV No.</b>	105652	<b>Ref. No.</b>	0C0700
<b>description</b>	bar burner 4 row L 580mm W 545mm ømm H 30mm tilting bratt pan		

			
1			
<b>GEV No.</b>	104579	<b>Ref. No.</b>	056002
<b>description</b>	bar burner 4 row L 625mm W 330mm ømm H 85mm griddle		

			
1			
<b>GEV No.</b>	105651	<b>Ref. No.</b>	059624
<b>description</b>	bar burner 6 row L 550mm W 790mm ømm H 60mm frying pan		

			
1			
<b>GEV No.</b>	105648	<b>Ref. No.</b>	051296
<b>description</b>	bar burner 6 row L 595mm W 630mm ømm H 45mm tilting bratt pan		





<b>GEV No.</b>	105650	<b>Ref. No.</b>	0A5166
<b>description</b>	bar burner 6 row L 630mm W 550mm ømm tilting bratt pan		



<b>GEV No.</b>	105061	<b>Ref. No.</b>	052717
<b>description</b>	bar burner angled L 680mm W 260mm ømm Hmm oven		



<b>GEV No.</b>	105653	<b>Ref. No.</b>	0C0701
<b>description</b>	bar burner L 700mm W 585mm ømm H 30mm tilting bratt pan		

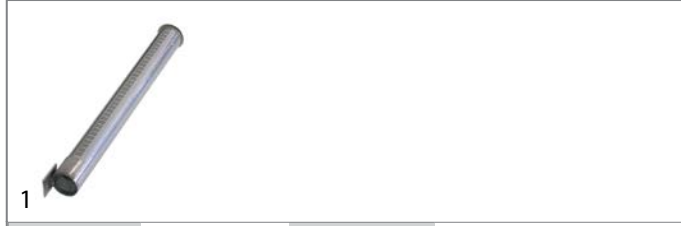

<b>GEV No.</b>	104291	<b>Ref. No.</b>	004971
<b>description</b>	bar burner ø 26mm Wmm Hmm L 260mm bain marie		

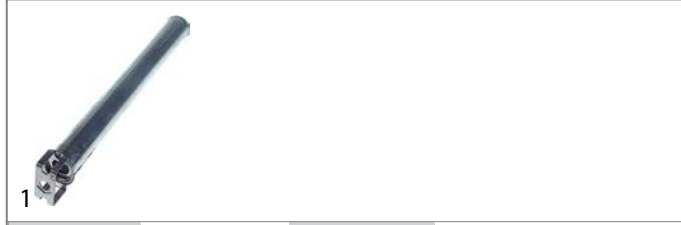

<b>GEV No.</b>	105643	<b>Ref. No.</b>	003326
<b>description</b>	bar burner ø 40mm Wmm Hmm L 380mm flange width 46mm fryer flange ø 61mm		

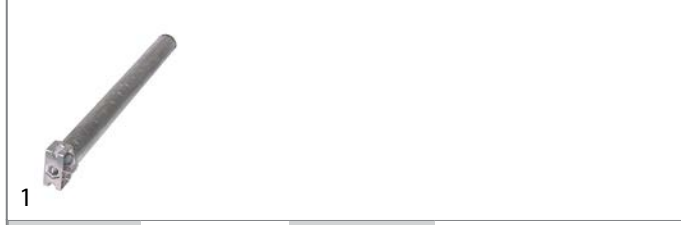

<b>GEV No.</b>	104229	<b>Ref. No.</b>	054117
<b>description</b>	bar burner ø 40mm Wmm Hmm L 480mm flange width 46mm gas range flange ø 61mm		

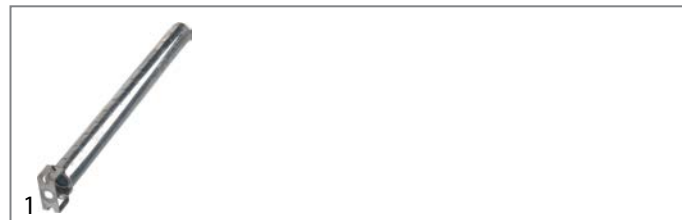

<b>GEV No.</b>	104574	<b>Ref. No.</b>	004258
<b>description</b>	bar burner ø 40mm Wmm Hmm L 485mm oven flange ø 46mm		



<b>GEV No.</b>	104589	<b>Ref. No.</b>	0A5447
<b>description</b>	bar burner ø 40mm Wmm Hmm L 550mm flange width 46mm bain marie flange ø 61mm		



<b>GEV No.</b>	104593	<b>Ref. No.</b>	059809
<b>description</b>	bar burner ø 40mm Wmm Hmm L 600mm flange width 46mm bain marie flange ø 61mm		



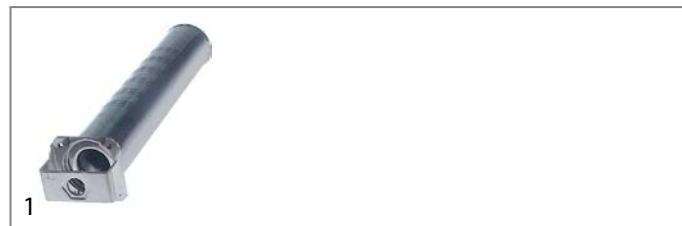

<b>GEV No.</b>	104223	<b>Ref. No.</b>	059221
<b>description</b>	bar burner ø 40mm Wmm Hmm L 620mm flange width 46mm gas range		





<b>GEV No.</b>	105768	<b>Ref. No.</b>	003677
<b>description</b>	bar burner ø 50mm Wmm Hmm L 267mm flange width 57mm flange length 57mm convection oven		





			
1			
<b>GEV No.</b>	105784	<b>Ref. No.</b>	056451
<b>description</b>	bar burner ø 50mm Wmm Hmm L 300mm flange width 57mm flange length 57mm convection oven		

			
1			
<b>GEV No.</b>	105644	<b>Ref. No.</b>	005929
<b>description</b>	bar burner ø 50mm Wmm Hmm L 390mm flange width 57mm flange length 57mm fryer		

			
1			
<b>GEV No.</b>	105407	<b>Ref. No.</b>	005794
<b>description</b>	bar burner ø 50mm Wmm Hmm L 320mm flange width 72mm pasta cooker flange ø 75mm		

			
1			
<b>GEV No.</b>	104290	<b>Ref. No.</b>	004954
<b>description</b>	bar burner ø 50mm Wmm Hmm L 390mm tilting bratt pan		

			
1			
<b>GEV No.</b>	105661	<b>Ref. No.</b>	0C0743
<b>description</b>	bar burner ø 50mm Wmm Hmm L 330mm flange width 57mm flange length 57mm kettle		

			
1			
<b>GEV No.</b>	105645	<b>Ref. No.</b>	006127
<b>description</b>	bar burner ø 50mm Wmm Hmm L 408mm flange width 57mm flange length 57mm fryer		

			
1			
<b>GEV No.</b>	105641	<b>Ref. No.</b>	004847
<b>description</b>	bar burner ø 50mm Wmm Hmm L 330mm flange width 57mm flange length 57mm pasta cooker		

			
1			
<b>GEV No.</b>	104575	<b>Ref. No.</b>	002513
<b>description</b>	bar burner ø 50mm Wmm Hmm L 500mm flange width 57mm flange length 57mm oven		

			
1			
<b>GEV No.</b>	105638	<b>Ref. No.</b>	004726
<b>description</b>	bar burner ø 50mm Wmm Hmm L 340mm flange width 57mm flange length 57mm pasta cooker		

			
1			
<b>GEV No.</b>	105766	<b>Ref. No.</b>	054028
<b>description</b>	bar burner ø 50mm Wmm Hmm L 525mm flange width 57mm flange length 57mm convection oven		





			
1			
<b>GEV No.</b>	105639	<b>Ref. No.</b>	056638
<b>description</b>	bar burner ø 60mm Wmm Hmm L 390mm 1-row with bolt bolt ø 10x45mm flange width 67mm flange length 67mm pasta cooker		

			
1			
<b>GEV No.</b>	105770	<b>Ref. No.</b>	004831
<b>description</b>	bar burner ø 60mm Wmm Hmm L 570mm flange width 61mm convection oven flange ø 79mm		

			
1			
<b>GEV No.</b>	104129	<b>Ref. No.</b>	052912
<b>description</b>	bar burner ømm W 40mm H 31mm L 670mm griddle		

			
1			
<b>GEV No.</b>	104188	<b>Ref. No.</b>	0H6335
<b>description</b>	bar burner ømm W 40mm H 53mm L 400mm flange width 48mm flange length 83mm range/boiling pan		

			
1			
<b>GEV No.</b>	104590	<b>Ref. No.</b>	0TR593
<b>description</b>	bar burner T-shape L 224mm ø 32mm bain marie		

			
1			
<b>GEV No.</b>	104588	<b>Ref. No.</b>	058749
<b>description</b>	bar burner T-shape L 240mm ø 32mm bain marie		



			
1			
<b>GEV No.</b>	104587	<b>Ref. No.</b>	050919
<b>description</b>	bar burner T-shape L 585mm ø 32mm bain marie		

			
1			
<b>GEV No.</b>	104591	<b>Ref. No.</b>	051975
<b>description</b>	bar burner T-shape L 630mm ø 32mm bain marie		

			
1			
<b>GEV No.</b>	105813	<b>Ref. No.</b>	002857
<b>description</b>	burner ømm W 185mm H 110mm L 560mm combi-steamer		

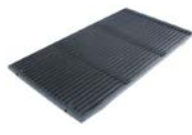
			
1			
<b>GEV No.</b>	211041	<b>Ref. No.</b>	0C0424
<b>description</b>	chargrill grid L 175mm W 640mm H 50mm		

			
1			
<b>GEV No.</b>	211034	<b>Ref. No.</b>	0C6879
<b>description</b>	chargrill grid L 340mm W 545mm		

			
1			
<b>GEV No.</b>	211025	<b>Ref. No.</b>	004963
<b>description</b>	chargrill grid L 480mm W 305mm H 14mm		
<b>accessories for</b>	211025		
	<b>GEV No.</b>	211098	<b>Ref. No.</b> —
	handle ø 28mm L 89mm thread M10x1 black		





			
1			
<b>GEV No.</b>	211087	<b>Ref. No.</b>	0C0450
<b>description</b>	chargrill grid L 640mm W 160mm		

			
1			
<b>GEV No.</b>	211024	<b>Ref. No.</b>	004964
<b>description</b>	lava rock grid L 420mm W 268mm		

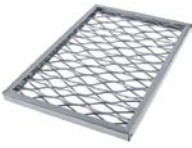
			
1			
<b>GEV No.</b>	211006	<b>Ref. No.</b>	054711
<b>description</b>	lava rock grid L 440mm W 290mm		

			
1			
<b>GEV No.</b>	211051	<b>Ref. No.</b>	056657
<b>description</b>	lava rock grid L 440mm W 290mm		

			
1			
<b>GEV No.</b>	211035	<b>Ref. No.</b>	006205
<b>description</b>	lava rock grid L 447mm W 285mm		

			
1			
<b>GEV No.</b>	211059	<b>Ref. No.</b>	002385
<b>description</b>	lava rock grid L 600mm W 345mm		

			
1			
<b>GEV No.</b>	211039	<b>Ref. No.</b>	0C0479
<b>description</b>	lava rock grid L 630mm W 340mm H 45mm		



			
1			
<b>GEV No.</b>	211036	<b>Ref. No.</b>	006206
<b>description</b>	lava rock grid L 635mm W 445mm H 20mm		

			
1			
<b>GEV No.</b>	211037	<b>Ref. No.</b>	002395
<b>description</b>	lava rock grid L 715mm W 595mm		

chargrill grids

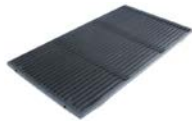
			
1			
<b>GEV No.</b>	211041	<b>Ref. No.</b>	0C0424
<b>description</b>	chargrill grid L 175mm W 640mm H 50mm		

			
1			
<b>GEV No.</b>	211034	<b>Ref. No.</b>	0C6879
<b>description</b>	chargrill grid L 340mm W 545mm		

			
1			
<b>GEV No.</b>	211025	<b>Ref. No.</b>	004963
<b>description</b>	chargrill grid L 480mm W 305mm H 14mm		
<b>accessories for</b>	211025		
	<b>GEV No.</b>	211098	<b>Ref. No.</b> —
	handle ø 28mm L 89mm thread M10x1 black		

			
1			
<b>GEV No.</b>	211087	<b>Ref. No.</b>	0C0450
<b>description</b>	chargrill grid L 640mm W 160mm		



lava rock grids



1

<b>GEV No.</b>	211024	<b>Ref. No.</b>	004964
<b>description</b>	lava rock grid L 420mm W 268mm		



1

<b>GEV No.</b>	211006	<b>Ref. No.</b>	054711
<b>description</b>	lava rock grid L 440mm W 290mm		



1

<b>GEV No.</b>	211051	<b>Ref. No.</b>	056657
<b>description</b>	lava rock grid L 440mm W 290mm		

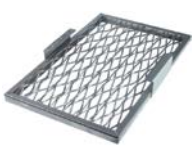

1

<b>GEV No.</b>	211035	<b>Ref. No.</b>	006205
<b>description</b>	lava rock grid L 447mm W 285mm		



1

<b>GEV No.</b>	211059	<b>Ref. No.</b>	002385
<b>description</b>	lava rock grid L 600mm W 345mm		



1

<b>GEV No.</b>	211039	<b>Ref. No.</b>	0C0479
<b>description</b>	lava rock grid L 630mm W 340mm H 45mm		



1

<b>GEV No.</b>	211036	<b>Ref. No.</b>	006206
<b>description</b>	lava rock grid L 635mm W 445mm H 20mm		



1

<b>GEV No.</b>	211037	<b>Ref. No.</b>	002395
<b>description</b>	lava rock grid L 715mm W 595mm		

tube burners



1

<b>GEV No.</b>	105071	<b>Ref. No.</b>	059297
<b>description</b>	tubular burner L 265mm W 50mm H 71mm for fryer oval suitable for 700/900 series		



1

<b>GEV No.</b>	104568	<b>Ref. No.</b>	004287
<b>description</b>	tubular burner ø 74mm L 185mm H 60mm round solid top range		
<b>accessories for</b>	104568		
<b>GEV No.</b>	104569	<b>Ref. No.</b>	002527
<b>description</b>	air mixer		



1

<b>GEV No.</b>	104293	<b>Ref. No.</b>	004945
<b>description</b>	tubular burner ø 74mm L 200mm H 60mm round for fryer		

ring burners



1

<b>GEV No.</b>	105655	<b>Ref. No.</b>	051564
<b>description</b>	ring burner for kettle		





			
1			
<b>GEV No.</b>	104189	<b>Ref. No.</b>	0H7082
<b>description</b>	ring burner L 460mm W 245mm for oven		

			
1			
<b>GEV No.</b>	105654	<b>Ref. No.</b>	051563
<b>description</b>	ring burner L 465mm W 233mm for kettle		

## accessories

### covers

			
1			
<b>GEV No.</b>	104576	<b>Ref. No.</b>	059596
<b>description</b>	cover for gas burner		

			
1			
<b>GEV No.</b>	104230	<b>Ref. No.</b>	054119
<b>description</b>	cover L 505mm W 200mm gas range suitable for 700 series		

			
1			
<b>GEV No.</b>	104577	<b>Ref. No.</b>	0C0175
<b>description</b>	cover L 690mm W 200mm gas range		

### nozzle holders

			
1			
<b>GEV No.</b>	101344	<b>Ref. No.</b>	052387
<b>description</b>	nozzle holder		





			
1			
<b>GEV No.</b>	106580	<b>Ref. No.</b>	002187
<b>description</b>	nozzle holder		

			
1			
<b>GEV No.</b>	101347	<b>Ref. No.</b>	020988
<b>description</b>	nozzle holder angled		

### air slides

			
1			
<b>GEV No.</b>	104193	<b>Ref. No.</b>	0H6880
<b>description</b>	air slide		





### miscellaneous

			
1			
<b>GEV No.</b>	104572	<b>Ref. No.</b>	052500
<b>description</b>	bracket for gas burner		
<b>accessories for</b>	104572		
	<b>GEV No.</b>	105024	<b>Ref. No.</b>
			052376
	burner head for burner cap ø 180mm		
	<b>GEV No.</b>	105025	<b>Ref. No.</b>
			052374
	cover ø 80mm solid top range		
	<b>GEV No.</b>	105026	<b>Ref. No.</b>
			052377
	burner cap ø 180mm with central hole		



 <p>1</p>			
<b>GEV No.</b>	101947	<b>Ref. No.</b>	058331
<b>description</b>	bracket for igniter/thermocouple		
<b>accessories for</b>	101947		
	<b>GEV No.</b>	105008	<b>Ref. No.</b> 056747
	burner ring for burner cap ø 70mm		
	<b>GEV No.</b>	105011	<b>Ref. No.</b> 056748
	burner ring for burner cap ø 100mm		
	<b>GEV No.</b>	105012	<b>Ref. No.</b> 002443
	burner cap ø 100mm		
	<b>GEV No.</b>	105056	<b>Ref. No.</b> 053448
	air mixing sleeve L 43mm ED ø 43mm ID ø 40mm aluminium		
	<b>GEV No.</b>	105231	<b>Ref. No.</b> 054091
	burner head for burner cap ø 70mm with nozzle holder for plug-in nozzle		
	<b>GEV No.</b>	105232	<b>Ref. No.</b> 002442
	burner cap ø 70mm		
	<b>GEV No.</b>	105233	<b>Ref. No.</b> 054092
	burner head for burner cap ø 100mm with nozzle holder for plug-in nozzle		
	<b>GEV No.</b>	105270	<b>Ref. No.</b> 054093
	gasket for burner cap ø 70mm		
	<b>GEV No.</b>	105271	<b>Ref. No.</b> 054094
	gasket for burner cap ø 100mm		

 <p>1</p>			
<b>GEV No.</b>	416578	<b>Ref. No.</b>	057730
<b>description</b>	ceramic plate		

 <p>1</p>			
<b>GEV No.</b>	105244	<b>Ref. No.</b>	002197
<b>description</b>	spacer piece for Venturi		
<b>accessories for</b>	105244		
	<b>GEV No.</b>	105006	<b>Ref. No.</b> 058187
	burner cap ø 122mm with central hole		
	<b>GEV No.</b>	105055	<b>Ref. No.</b> 052116
	air mixing sleeve L 40mm ED ø 43mm ID ø 40mm aluminium		
	<b>GEV No.</b>	105241	<b>Ref. No.</b> 002463
	burner head for burner cap ø 122mm		
	<b>GEV No.</b>	105243	<b>Ref. No.</b> 002460
	venturi for burner cap ø 122mm		

## gas nozzles

### main nozzles

#### gas nozzles M7x1



1

<b>GEV No.</b>	100522	<b>Ref. No.</b>	055113
<b>description</b>	gas injector thread M7x1 WS 10 bore ø 1.35mm		

#### gas nozzles M10x1



1

<b>GEV No.</b>	100150	<b>Ref. No.</b>	054630
<b>description</b>	gas injector thread M10x1 bore ø 0.95mm L 30mm WS 12		



1

<b>GEV No.</b>	100670	<b>Ref. No.</b>	002265
<b>description</b>	gas injector thread M10x1 bore ø 0.9mm L 30mm WS 12		



1

<b>GEV No.</b>	100156	<b>Ref. No.</b>	059364
<b>description</b>	gas injector thread M10x1 bore ø 1.3mm L 30mm WS 12		



1

<b>GEV No.</b>	100155	<b>Ref. No.</b>	056470
<b>description</b>	gas injector thread M10x1 bore ø 1.45mm L 30mm WS 12		



1

<b>GEV No.</b>	101975	<b>Ref. No.</b>	003722
<b>description</b>	gas injector thread M10x1 bore ø 1.55mm L 30mm WS 12		



1

<b>GEV No.</b>	100816	<b>Ref. No.</b>	002862
<b>description</b>	gas injector thread M10x1 bore ø 1.5mm WS 12		





1

<b>GEV No.</b>	100151	<b>Ref. No.</b>	054127
<b>description</b>	gas injector thread M10x1 bore ø 1.65mm L 30mm WS 12		

			
1			
<b>GEV No.</b>	100152	<b>Ref. No.</b>	054631
<b>description</b>	gas injector thread M10x1 bore ø 1.8mm L 30mm WS 12		

			
1			
<b>GEV No.</b>	106403	<b>Ref. No.</b>	054033
<b>description</b>	gas injector thread M10x1 bore ø 1.9mm L 30mm WS 12		

			
1			
<b>GEV No.</b>	102499	<b>Ref. No.</b>	056471
<b>description</b>	gas injector thread M10x1 bore ø 2.25mm L 30mm WS 12		

			
1			
<b>GEV No.</b>	106408	<b>Ref. No.</b>	054034
<b>description</b>	gas injector thread M10x1 bore ø 3mm L 30mm WS 12		

			
1			
<b>GEV No.</b>	106451	<b>Ref. No.</b>	0A2088
<b>description</b>	gas injector thread M10x1 WS 12 bore ø 0.9mm		

			
1			
<b>GEV No.</b>	106466	<b>Ref. No.</b>	059314
<b>description</b>	gas injector thread M10x1 WS 12 bore ø 1.15mm		

			
1			
<b>GEV No.</b>	106328	<b>Ref. No.</b>	002393
<b>description</b>	gas injector thread M10x1 WS 12 bore ø 1.3mm		

			
1			
<b>GEV No.</b>	101961	<b>Ref. No.</b>	0A2103
<b>description</b>	gas injector thread M10x1 WS 12 bore ø 1.55mm		

			
1			
<b>GEV No.</b>	106468	<b>Ref. No.</b>	059336
<b>description</b>	gas injector thread M10x1 WS 12 bore ø 1.7mm		

			
1			
<b>GEV No.</b>	109115	<b>Ref. No.</b>	0C0141
<b>description</b>	gas injector thread M10x1 WS 12 bore ø 1.95mm		

			
1			
<b>GEV No.</b>	106457	<b>Ref. No.</b>	0C0142
<b>description</b>	gas injector thread M10x1 WS 12 bore ø 2.05mm		

			
1			
<b>GEV No.</b>	104627	<b>Ref. No.</b>	0A2475
<b>description</b>	gas injector thread M10x1 WS 12 bore ø 2.25mm		

			
1			
<b>GEV No.</b>	106475	<b>Ref. No.</b>	0A2083
<b>description</b>	gas injector thread M10x1 WS 12 bore ø 2.2mm		

			
1			
<b>GEV No.</b>	106469	<b>Ref. No.</b>	059382
<b>description</b>	gas injector thread M10x1 WS 12 bore ø 2.5mm		







			
1			
<b>GEV No.</b>	106461	<b>Ref. No.</b>	059383
<b>description</b>	gas injector thread M10x1 WS 12 bore ø 2.8mm		

			
1			
<b>GEV No.</b>	106474	<b>Ref. No.</b>	0A2102
<b>description</b>	gas injector thread M10x1 WS 12 bore ø 2mm		

			
1			
<b>GEV No.</b>	693314	<b>Ref. No.</b>	059528
<b>description</b>	gas injector thread M10x1 WS 12 bore ø 3.95mm		

			
1			
<b>GEV No.</b>	100381	<b>Ref. No.</b>	059357
<b>description</b>	gas injector thread M10x1 WS 12 bore ø 0.85mm		

			
1			
<b>GEV No.</b>	100382	<b>Ref. No.</b>	059328
<b>description</b>	gas injector thread M10x1 WS 12 bore ø 1.05mm		

			
1			
<b>GEV No.</b>	100538	<b>Ref. No.</b>	0A2076
<b>description</b>	gas injector thread M10x1 WS 12 bore ø 1.1mm		

			
1			
<b>GEV No.</b>	100387	<b>Ref. No.</b>	0A2091
<b>description</b>	gas injector thread M10x1 WS 12 bore ø 1.45mm		

			
1			
<b>GEV No.</b>	100384	<b>Ref. No.</b>	056793
<b>description</b>	gas injector thread M10x1 WS 12 bore ø 1.8mm		

gas nozzles M13x1

			
1			
<b>GEV No.</b>	109108	<b>Ref. No.</b>	005652
<b>description</b>	gas injector thread M13x1 bore ø 2.2mm WS 13		

gas nozzles (other)

			
1			
<b>GEV No.</b>	106824	<b>Ref. No.</b>	050677
<b>description</b>	gas injector bore ø 0.4mm		

			
1			
<b>GEV No.</b>	100588	<b>Ref. No.</b>	052528
<b>description</b>	gas injector bore ø 0.6mm		

			
1			
<b>GEV No.</b>	100586	<b>Ref. No.</b>	050679
<b>description</b>	gas injector bore ø 0.7mm		



1

<b>GEV No.</b>	100567	<b>Ref. No.</b>	025983
<b>description</b>	gas injector bore ø 0.85mm		



1

<b>GEV No.</b>	100580	<b>Ref. No.</b>	026788
<b>description</b>	gas injector bore ø 1.25mm		



1

<b>GEV No.</b>	100577	<b>Ref. No.</b>	050675
<b>description</b>	gas injector bore ø 0.8mm		



1

<b>GEV No.</b>	100575	<b>Ref. No.</b>	026213
<b>description</b>	gas injector bore ø 1.2mm		



1

<b>GEV No.</b>	100569	<b>Ref. No.</b>	026717
<b>description</b>	gas injector bore ø 0.95mm		



1

<b>GEV No.</b>	100583	<b>Ref. No.</b>	025866
<b>description</b>	gas injector bore ø 1.35mm		



1

<b>GEV No.</b>	100568	<b>Ref. No.</b>	051121
<b>description</b>	gas injector bore ø 0.9mm		



1

<b>GEV No.</b>	100579	<b>Ref. No.</b>	026718
<b>description</b>	gas injector bore ø 1.3mm		



1

<b>GEV No.</b>	100565	<b>Ref. No.</b>	050501
<b>description</b>	gas injector bore ø 1.05mm		



1

<b>GEV No.</b>	100573	<b>Ref. No.</b>	045676
<b>description</b>	gas injector bore ø 1.45mm		



1

<b>GEV No.</b>	100582	<b>Ref. No.</b>	026785
<b>description</b>	gas injector bore ø 1.15mm		



1

<b>GEV No.</b>	100574	<b>Ref. No.</b>	026786
<b>description</b>	gas injector bore ø 1.4mm		



1

<b>GEV No.</b>	100587	<b>Ref. No.</b>	025865
<b>description</b>	gas injector bore ø 1.1mm		





1

<b>GEV No.</b>	100578	<b>Ref. No.</b>	050515
<b>description</b>	gas injector bore ø 1.55mm		





			
1			
<b>GEV No.</b>	100564	<b>Ref. No.</b>	025954
<b>description</b>	gas injector bore ø 1.5mm		

			
1			
<b>GEV No.</b>	100593	<b>Ref. No.</b>	025953
<b>description</b>	gas injector bore ø 1.9mm		

			
1			
<b>GEV No.</b>	100581	<b>Ref. No.</b>	026622
<b>description</b>	gas injector bore ø 1.65mm		

			
1			
<b>GEV No.</b>	100595	<b>Ref. No.</b>	050750
<b>description</b>	gas injector bore ø 2.05mm		

			
1			
<b>GEV No.</b>	100570	<b>Ref. No.</b>	026789
<b>description</b>	gas injector bore ø 1.75mm		

			
1			
<b>GEV No.</b>	100562	<b>Ref. No.</b>	050591
<b>description</b>	gas injector bore ø 2.15mm		

			
1			
<b>GEV No.</b>	100591	<b>Ref. No.</b>	026954
<b>description</b>	gas injector bore ø 1.7mm		

			
1			
<b>GEV No.</b>	100576	<b>Ref. No.</b>	026787 51530
<b>description</b>	gas injector bore ø 2.1mm		

			
1			
<b>GEV No.</b>	100572	<b>Ref. No.</b>	025868
<b>description</b>	gas injector bore ø 1.85mm		

			
1			
<b>GEV No.</b>	100563	<b>Ref. No.</b>	026214
<b>description</b>	gas injector bore ø 2.2mm		

			
1			
<b>GEV No.</b>	100571	<b>Ref. No.</b>	025867
<b>description</b>	gas injector bore ø 1.8mm		

			
1			
<b>GEV No.</b>	100585	<b>Ref. No.</b>	050493
<b>description</b>	gas injector bore ø 2.3mm		

			
1			
<b>GEV No.</b>	102865	<b>Ref. No.</b>	0A2301
<b>description</b>	gas injector bore ø 1.95mm		

			
1			
<b>GEV No.</b>	100596	<b>Ref. No.</b>	050807
<b>description</b>	gas injector bore ø 2.4mm		



1

<b>GEV No.</b>	100592	<b>Ref. No.</b>	051460
<b>description</b>	gas injector bore ø 2.7mm		



1

<b>GEV No.</b>	100561	<b>Ref. No.</b>	026720
<b>description</b>	gas injector bore ø 2mm		



1

<b>GEV No.</b>	100589	<b>Ref. No.</b>	057512
<b>description</b>	gas injector bore ø 3.2mm		



1

<b>GEV No.</b>	100590	<b>Ref. No.</b>	050571
<b>description</b>	gas injector bore ø 3.6mm		



1

<b>GEV No.</b>	100584	<b>Ref. No.</b>	051874
<b>description</b>	gas injector bore ø 3.8mm		



1

<b>GEV No.</b>	103180	<b>Ref. No.</b>	026623
<b>description</b>	nozzle bore ø 2.85mm		

## pilot burner nozzles

### pilot burner nozzles POLIDORO



1

<b>GEV No.</b>	106859	<b>Ref. No.</b>	054286
<b>description</b>	pilot burner nozzle POLIDORO LPG code 24 bore ø 0.24mm Qty 1 pcs		

### pilot burner nozzles SIT

#### 100 series



1

<b>GEV No.</b>	100245	<b>Ref. No.</b>	056799
<b>description</b>	pilot burner nozzle LPG code 20 bore ø 0.2mm Qty 1 pcs thread M8x0.75		



1

<b>GEV No.</b>	100246	<b>Ref. No.</b>	056656
<b>description</b>	pilot burner nozzle natural gas bore ø 0.35mm Qty 1 pcs thread M8x0.75		



1

<b>GEV No.</b>	107170	<b>Ref. No.</b>	058525
<b>description</b>	pilot burner nozzle SIT natural gas bore ø 0.35mm Qty 1 pcs		



1

<b>GEV No.</b>	107171	<b>Ref. No.</b>	058330
<b>description</b>	pilot burner nozzle SIT natural/liquid gas bore ø 0.25mm Qty 1 pcs		

#### 140/150 series



1

<b>GEV No.</b>	100204	<b>Ref. No.</b>	059216
<b>description</b>	pilot burner nozzle SIT LPG code 14 bore ø 0.18/0.20mm Qty 1 pcs suitable for 140 series		



1

<b>GEV No.</b>	100207	<b>Ref. No.</b>	059215
<b>description</b>	pilot burner nozzle SIT natural gas code 27 bore ø 0.40/0.38mm suitable for SIT 140 series		



			
1			
<b>GEV No.</b>	103288	<b>Ref. No.</b>	059356
<b>description</b>	pilot burner nozzle SIT natural gas code 50 bore ø 0.50mm suitable for 140 series		

160 series

			
1			
<b>GEV No.</b>	107174	<b>Ref. No.</b>	053670
<b>description</b>	pilot burner nozzle SIT natural gas code 41 Qty 1 pcs		

			
1			
<b>GEV No.</b>	107175	<b>Ref. No.</b>	053668
<b>description</b>	pilot burner nozzle SIT natural gas code 51 Qty 1 pcs suitable for 160 series		

bypass nozzles

bypass nozzles EGA

			
1			
<b>GEV No.</b>	100346	<b>Ref. No.</b>	0K0241
<b>description</b>	bypass nozzle EGA type 31248 series bore ø 0.85mm		

bypass nozzles PEL20/21

			
1			
<b>GEV No.</b>	100554	<b>Ref. No.</b>	002900
<b>description</b>	bypass nozzle type PEL20/21 bore ø 0.45mm thread M5x0.5		

			
1			
<b>GEV No.</b>	100553	<b>Ref. No.</b>	002901
<b>description</b>	bypass nozzle type PEL20/21 bore ø 0.4mm thread M5x0.5		

			
1			
<b>GEV No.</b>	100550	<b>Ref. No.</b>	002911
<b>description</b>	bypass nozzle type PEL20/21 bore ø 0.55mm thread M5x0.5		

			
1			
<b>GEV No.</b>	100526	<b>Ref. No.</b>	002925
<b>description</b>	bypass nozzle type PEL20/21 bore ø 0.5mm thread M5x0.5		

			
1			
<b>GEV No.</b>	100551	<b>Ref. No.</b>	002904
<b>description</b>	bypass nozzle type PEL20/21 bore ø 0.6mm thread M5x0.5		

			
1			
<b>GEV No.</b>	100552	<b>Ref. No.</b>	002908
<b>description</b>	bypass nozzle type PEL20/21 bore ø 0.7mm thread M5x0.5		

			
1			
<b>GEV No.</b>	100555	<b>Ref. No.</b>	002899
<b>description</b>	bypass nozzle type PEL20/21 bore ø 0.8mm thread M5x0.5		

			
1			
<b>GEV No.</b>	100556	<b>Ref. No.</b>	002909
<b>description</b>	bypass nozzle type PEL20/21 bore ø 0.95mm thread M5x0.5		

			
1			
<b>GEV No.</b>	100528	<b>Ref. No.</b>	002926
<b>description</b>	bypass nozzle type PEL20/21 bore ø 0.9mm thread M5x0.5		

			
1			
<b>GEV No.</b>	100557	<b>Ref. No.</b>	002902
<b>description</b>	bypass nozzle type PEL20/21 bore ø 1.05mm thread M5x0.5		

			
1			
<b>GEV No.</b>	100531	<b>Ref. No.</b>	002927
<b>description</b>	bypass nozzle type PEL20/21 bore ø 1.15mm thread M5x0.5		

			
1			
<b>GEV No.</b>	100533	<b>Ref. No.</b>	002928
<b>description</b>	bypass nozzle type PEL20/21 bore ø 1.3mm thread M5x0.5		

			
1			
<b>GEV No.</b>	100534	<b>Ref. No.</b>	003182
<b>description</b>	bypass nozzle type PEL20/21 bore ø 1.4mm thread M5x0.5		



## bypass nozzles PEL22



1

<b>GEV No.</b>	100414	<b>Ref. No.</b>	004261
----------------	--------	-----------------	--------

<b>description</b>	bypass nozzle type PEL22 bore $\varnothing$ 0.45mm thread M6x0.5		
--------------------	--	--	--



1

<b>GEV No.</b>	100409	<b>Ref. No.</b>	056743
----------------	--------	-----------------	--------

<b>description</b>	bypass nozzle type PEL22 bore $\varnothing$ 0.8mm thread M6x0.5		
--------------------	---	--	--



1

<b>GEV No.</b>	106309	<b>Ref. No.</b>	003372
----------------	--------	-----------------	--------

<b>description</b>	bypass nozzle type PEL22 bore $\varnothing$ 1.7mm thread M6x0.5		
--------------------	---	--	--

## bypass nozzles PEL23/24



1

<b>GEV No.</b>	100674	<b>Ref. No.</b>	002976
----------------	--------	-----------------	--------

<b>description</b>	bypass nozzle type PEL23/24 bore $\varnothing$ 1.4mm thread M8x0.5		
--------------------	--	--	--

## auxiliary gas parts

## screw connections

## double nipples



1

<b>GEV No.</b>	106518	<b>Ref. No.</b>	002716
----------------	--------	-----------------	--------

<b>description</b>	double nipple T1: 1/2" T2: M24x1.5 tube $\varnothing$ 16mm		
--------------------	--	--	--

## olives



1

<b>GEV No.</b>	106426	<b>Ref. No.</b>	054979
----------------	--------	-----------------	--------

<b>description</b>	olive		
--------------------	-------	--	--



1

<b>GEV No.</b>	101278	<b>Ref. No.</b>	060325
----------------	--------	-----------------	--------

<b>description</b>	olive for pipe $\varnothing$ 10mm Qty 1 pcs		
--------------------	---	--	--

<b>accessories for</b>	101278		
------------------------	--------	--	--



<b>GEV No.</b>	100943	<b>Ref. No.</b>	—
----------------	--------	-----------------	---

<b>description</b>	union nut thread M17x1 tube $\varnothing$ 10mm		
--------------------	--	--	--



<b>GEV No.</b>	101300	<b>Ref. No.</b>	—
----------------	--------	-----------------	---

<b>description</b>	union nut thread M16x1.5 tube $\varnothing$ 10mm		
--------------------	--	--	--



<b>GEV No.</b>	101478	<b>Ref. No.</b>	—
----------------	--------	-----------------	---

<b>description</b>	union nut thread 3/8" for pipe $\varnothing$ 10mm		
--------------------	---	--	--



1

<b>GEV No.</b>	101248	<b>Ref. No.</b>	050682
----------------	--------	-----------------	--------

<b>description</b>	olive for pipe $\varnothing$ 12mm Qty 1 pcs suitable for PEL		
--------------------	--	--	--

<b>accessories for</b>	101248		
------------------------	--------	--	--



<b>GEV No.</b>	101251	<b>Ref. No.</b>	—
----------------	--------	-----------------	---

<b>description</b>	union nut thread M20x1.5 for pipe $\varnothing$ 12mm		
--------------------	--	--	--



1

<b>GEV No.</b>	101256	<b>Ref. No.</b>	054817
----------------	--------	-----------------	--------

<b>description</b>	olive for pipe $\varnothing$ 16mm Qty 1 pcs		
--------------------	---	--	--

<b>accessories for</b>	101256		
------------------------	--------	--	--



<b>GEV No.</b>	101253	<b>Ref. No.</b>	—
----------------	--------	-----------------	---

<b>description</b>	union nut thread M24x1.5 PEL for pipe $\varnothing$ 16mm		
--------------------	--	--	--



1

<b>GEV No.</b>	101246	<b>Ref. No.</b>	052127
----------------	--------	-----------------	--------

<b>description</b>	olive for pipe $\varnothing$ 4mm Qty 1 pcs		
--------------------	--	--	--

<b>accessories for</b>	101246		
------------------------	--------	--	--



<b>GEV No.</b>	100908	<b>Ref. No.</b>	052125
----------------	--------	-----------------	--------

<b>description</b>	union screw thread M10x1 for pipe $\varnothing$ 4mm Qty 1 pcs		
--------------------	---	--	--





1

<b>GEV No.</b>	100897	<b>Ref. No.</b>	059161
----------------	--------	-----------------	--------

<b>description</b>	olive for pipe $\varnothing$ 4mm Qty 1 pcs for pilot burner		
--------------------	---	--	--



 <p>1</p>			
<b>GEV No.</b>	100870	<b>Ref. No.</b>	053665
<b>description</b>	olive for pipe ø 4mm Qty 1 pcs suitable for 160 series for pilot burner		

 <p>1</p>			
<b>GEV No.</b>	102483	<b>Ref. No.</b>	0C3645
<b>description</b>	olive ID ø 7mm ED ø 9.5mm Qty 1 pcs brass L 7mm from serial no. 646		

union nuts

 <p>1</p>			
<b>GEV No.</b>	101346	<b>Ref. No.</b>	025902
<b>description</b>	union nut nozzle holder		

union screws

 <p>1</p>			
<b>GEV No.</b>	100904	<b>Ref. No.</b>	052833
<b>description</b>	locking screw M10x1 for pipe ø 4mm Qty 1 pcs		

 <p>1</p>			
<b>GEV No.</b>	100906	<b>Ref. No.</b>	057960
<b>description</b>	screw connection thread M10x1 for ignition electrode brass Qty 1 pcs WS 10		

 <p>1</p>			
<b>GEV No.</b>	100907	<b>Ref. No.</b>	0C0121
<b>description</b>	screw connection thread M10x1 Qty 1 pcs type SEF 1 ømm for thermocouple		

 <p>1</p>			
<b>GEV No.</b>	100908	<b>Ref. No.</b>	052125
<b>description</b>	union screw thread M10x1 for pipe ø 4mm Qty 1 pcs		
<b>accessories for</b>	100908		
 <p>GEV No. 100897 Ref. No. 059161</p> <p>olive for pipe ø 4mm Qty 1 pcs for pilot burner</p>			
 <p>GEV No. 101246 Ref. No. 052127</p> <p>olive for pipe ø 4mm Qty 1 pcs</p>			
 <p>GEV No. 101280 Ref. No. —</p> <p>olive for pipe ø 4mm Qty 1 pcs</p>			
 <p>GEV No. 101282 Ref. No. —</p> <p>olive for pipe ø 4mm L 7.4mm Qty 1 pcs</p>			

 <p>1</p>			
<b>GEV No.</b>	102482	<b>Ref. No.</b>	0C3646
<b>description</b>	union screw thread M11x1 L 11mm Qty 1 pcs hole ø 7mm from serial no. 646		

 <p>1</p>			
<b>GEV No.</b>	101467	<b>Ref. No.</b>	051950
<b>description</b>	union screw thread M18x1.5 for pipe ø 12mm Qty 1 pcs		



## gas pressure regulators

Standard pressure according to country:

Germany 50mbar

France 37mbar

Italy 30mbar

Spain 37/50mbar

UK 20mbar



1

<b>GEV No.</b>	250124	<b>Ref. No.</b>	0S0027
<b>description</b>	gas pressure regulator BP2205 connection 1/4" - 1/2" 30mbar/7kg/h countries IT input pressure max. 4bar NOVACOMET LPG		

## gas lines

## pilot tubes

## producer-specific



1

<b>GEV No.</b>	106519	<b>Ref. No.</b>	0C0802
<b>description</b>	gas line tube ø 16mm L 410mm W 80mm		

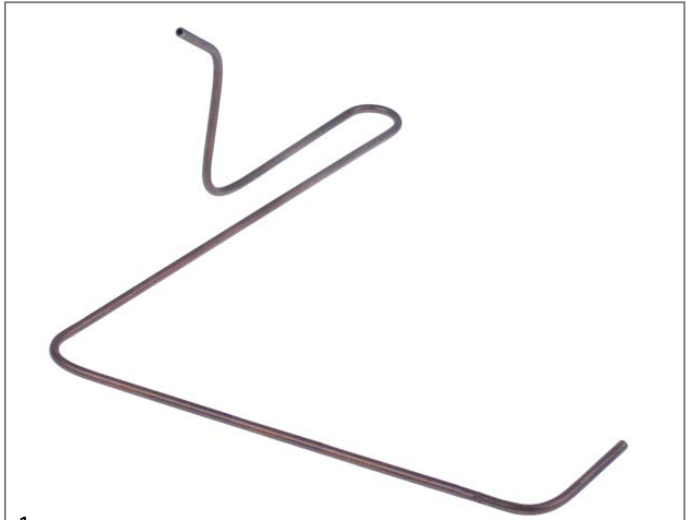

1

<b>GEV No.</b>	102488	<b>Ref. No.</b>	0C4192
<b>description</b>	pilot tube tube ø 4mm L 230mm W 240mm H 90mm for N700 mounting pos. front		

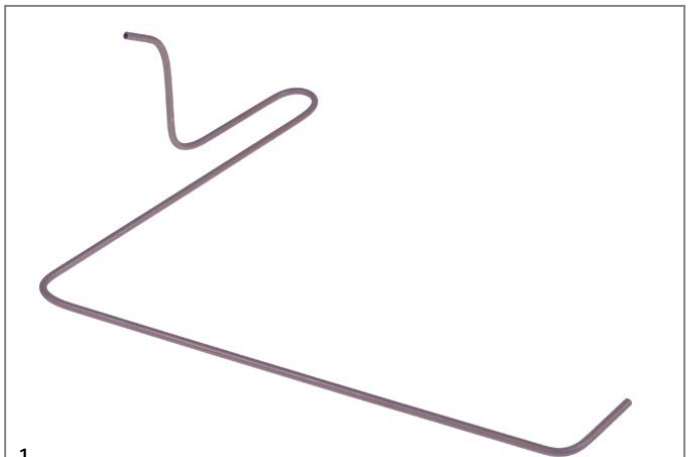

1

<b>GEV No.</b>	102486	<b>Ref. No.</b>	0C3647
<b>description</b>	pilot tube tube ø 4mm L 310mm W 240mm H 90mm for N900 mounting pos. front		

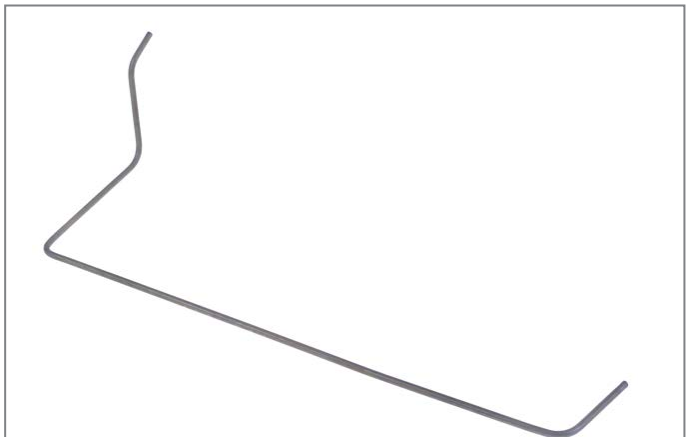





1

<b>GEV No.</b>	102489	<b>Ref. No.</b>	0C4193
<b>description</b>	pilot tube tube ø 4mm L 355mm W 160mm H 90mm for N700 mounting pos. rear		







			
1			
<b>GEV No.</b>	102487	<b>Ref. No.</b>	0C3648
<b>description</b>	pilot tube tube ø 4mm L 530mm W 190mm H 90mm for N900 mounting pos. rear		

<b>universal</b>			
			
1			
<b>GEV No.</b>	102110	<b>Ref. No.</b>	054810
<b>description</b>	pilot tube copper pipe ø 4mm thickness 1mm L 3000mm		
<b>accessories for</b>	102110		
	<b>GEV No.</b>	100908	<b>Ref. No.</b> 052125
	union screw thread M10x1 for pipe ø 4mm Qty 1 pcs		
	<b>GEV No.</b>	101246	<b>Ref. No.</b> 052127
	olive for pipe ø 4mm Qty 1 pcs		

**pressure switches**

			
1			
<b>GEV No.</b>	541073	<b>Ref. No.</b>	002635
<b>description</b>	pressure control ø 45mm pressure range adjustable 5-20mbar pressure connection vertical gas technology connection 1/4" pressure connection ø 1/4"mm		

			
1			
<b>GEV No.</b>	541867	<b>Ref. No.</b>	003772
<b>description</b>	pressure control ø 80mm reset pressure 0.42bar triggering pressure 0.78mbar connection 7.5/10.5mm 250V voltage AC 1CO pressure connection ø 7.5-10.5mm		

			
1			
<b>GEV No.</b>	541446	<b>Ref. No.</b>	005029
<b>description</b>	pressure control pressure range 10-50mbar connection 1/4"		

			
1			
<b>GEV No.</b>	541352	<b>Ref. No.</b>	005746
<b>description</b>	pressure control triggering pressure 1.5mbar reset pressure 1.2mbar pressure range 1.5/1.2mbar pressure connection horizontal gas technology connection 6mm suitable for ZANUSSI		

**equipment-specific units**

**for potato peelers**

**abrasive side elements**

**grinding discs**

			
1			
<b>GEV No.</b>	696377	<b>Ref. No.</b>	037546
<b>description</b>	grating disc ø 350mm for potato peeler device		

**for dough mixers**

**chains**

**roller chains 08B-1 single**

			
1			
<b>GEV No.</b>	693275	<b>Ref. No.</b>	056862
<b>description</b>	roller chain DIN/ISO 08 B-1 splitting 1/2" / 12.7mm links 23 internal width 7.75mm rollerø 8.51mm single without connecting bow		

## connectors



1

<b>GEV No.</b>	693276	<b>Ref. No.</b>	056863
<b>description</b>	connector single DIN/ISO 08 B-1 splitting 1/2" links 1 L 23mm internal width 11.8mm rollerø 4.3mm metal		

## for fridges

## spare parts and accessories



1

<b>GEV No.</b>	690632	<b>Ref. No.</b>	082757
<b>description</b>	pin refrigerated counter ø 5mm L 17mm		

## housing and bezels

## covers



1

<b>GEV No.</b>	694337	<b>Ref. No.</b>	0A9666
<b>description</b>	bezel for lighting L 1375mm W 85mm H 18mm suitable for ELECTROLUX		

## for refrigerated counters

## spare parts and accessories



1

<b>GEV No.</b>	690632	<b>Ref. No.</b>	082757
<b>description</b>	pin refrigerated counter ø 5mm L 17mm		

## for cold storage cells

## pressure compensation valves



1

<b>GEV No.</b>	750332	<b>Ref. No.</b>	081971
<b>description</b>	pressure compensation valve mounting ø 61mm MiniElebar T.N. unheated for walk-in fridge +1 up to +10°C built-in depth 60mm mounting pos. horizontal		

spare parts for 750332



<b>GEV No.</b>	750335	<b>Ref. No.</b>	—
<b>description</b>	ventilation grille suitable for MiniElebar ø 86mm mounting distance 69.5mm H 14.5mm		

## for ice-cube maker

## doors

## door guides



1

<b>GEV No.</b>	695447	<b>Ref. No.</b>	OKM684
<b>description</b>	door guides mounting pos. right L 215/240mm W 14mm		

## miscellaneous



1

<b>GEV No.</b>	695630	<b>Ref. No.</b>	086445 OKM780
<b>description</b>	coupling set ø 37mm		

## for espresso machines

## brewing units

## filter holder gaskets

## O-rings



1

<b>GEV No.</b>	510409	<b>Ref. No.</b>	007029
<b>description</b>	O-ring EPDM thickness 5.34mm ID ø 56.52mm Qty 1 pcs		

## for convection ovens/combi-steamers

## steam generators

## steam generators



1

<b>GEV No.</b>	694312	<b>Ref. No.</b>	005234
<b>description</b>	steam generator L 615mm W 100mm H 425mm		



spare parts and accessories

1			
<b>GEV No.</b>	690869	<b>Ref. No.</b>	003825
<b>description</b>	bar L 440mm		

1			
<b>GEV No.</b>	700497	<b>Ref. No.</b>	054561
<b>description</b>	bush for door mechanism		

1			
<b>GEV No.</b>	550541	<b>Ref. No.</b>	002843
<b>description</b>	duct suitable for chip scuttle		

filters

1			
<b>GEV No.</b>	514377	<b>Ref. No.</b>	0H6299
<b>description</b>	drain filter		



1			
<b>GEV No.</b>	514425	<b>Ref. No.</b>	0C1740
<b>description</b>	drain filter ø 102mm		

frame

1			
<b>GEV No.</b>	693398	<b>Ref. No.</b>	057382
<b>description</b>	frame for level glass		

cleaning system

cleaning arms

1				
<b>GEV No.</b>	693408	<b>Ref. No.</b>	0C5503 0C8317	
<b>description</b>	cleaning arm			
<b>spare parts for</b>	693408			
	<b>GEV No.</b>	693409	<b>Ref. No.</b>	007026
	retainer clip for wash arm			

door mechanics

miscellaneous

1			
<b>GEV No.</b>	690631	<b>Ref. No.</b>	081807
<b>description</b>	bush refrigerated counter		

vibration pumps

1				
<b>GEV No.</b>	500566	<b>Ref. No.</b>	0C2341	
<b>description</b>	vibration pump 230V 32W 50Hz inlet ø 7 outlet ø 1/8" IT CEME type E512/A32			
<b>accessories for</b>	500566			
	<b>GEV No.</b>	510303	<b>Ref. No.</b>	—
	O-ring EPDM thickness 1.78mm ID ø 6.75mm Qty 1 pcs			
	<b>GEV No.</b>	520512	<b>Ref. No.</b>	—
	reducer WS 17 IT 1/4" ET 1/8" total length 28mm			
	<b>GEV No.</b>	542346	<b>Ref. No.</b>	—
	hose connector thread 1/4" with O-ring hose ø 5mm stainless steel Qty 1 pcs			

heat exchangers

1			
<b>GEV No.</b>	692323	<b>Ref. No.</b>	003881
<b>description</b>	heat exchanger for convection oven		

## miscellaneous



1

<b>GEV No.</b>	693429	<b>Ref. No.</b>	002662
<b>description</b>	bush		



1

<b>GEV No.</b>	550697	<b>Ref. No.</b>	0K2358
<b>description</b>	bush for knob		



1

<b>GEV No.</b>	698582	<b>Ref. No.</b>	002634
<b>description</b>	gasket conical D1 ø 74mm D2 ø 17mm thickness 11mm		



1

<b>GEV No.</b>	693432	<b>Ref. No.</b>	002663
<b>description</b>	gasket for knob		



1

<b>GEV No.</b>	693430	<b>Ref. No.</b>	051263
<b>description</b>	nut thread M22x1.5 H 5mm WS 26 zinc-coated steel Qty 1 pcs		



1

<b>GEV No.</b>	693431	<b>Ref. No.</b>	002727
<b>description</b>	plain washer		

## for tilting bratt pans

## spare parts and accessories



1

<b>GEV No.</b>	693285	<b>Ref. No.</b>	051266
<b>description</b>	spigot		

## gearboxes



1

<b>GEV No.</b>	693270	<b>Ref. No.</b>	002795
<b>description</b>	gearbox		

## poly-V-belt pulleys



1

<b>GEV No.</b>	693264	<b>Ref. No.</b>	052783
<b>description</b>	V-belt pulley single disc ø 165mm shaft intake ø 20mm groove depth 10mm disc width 16mm groove width 4mm overall width 54mm aluminium		





1

<b>GEV No.</b>	693261	<b>Ref. No.</b>	056976
<b>description</b>	V-belt pulley single disc ø 80mm shaft intake ø 15mm groove depth 9mm disc width 16mm groove width 4mm overall width 26mm steel shaft ø 25mm		



			
1			
<b>GEV No.</b>	693268	<b>Ref. No.</b>	002147
<b>description</b>	V-ripped belt pulley grooves 6 disc ø 60mm shaft intake ø 15mm disc width 17mm groove depth 1.5mm groove width 1.5mm overall width 30mm		

spindles			
			
1			
<b>GEV No.</b>	693278	<b>Ref. No.</b>	056830
<b>description</b>	end piece DIN/ISO splitting links L 30mm internal width M8mm rollerø 4.5mm metal chrome-plated		

			
1			
<b>GEV No.</b>	693277	<b>Ref. No.</b>	056827
<b>description</b>	end piece L 30mm internal width 8.5mm rollerø 4.5mm chrome-plated brass		

			
1			
<b>GEV No.</b>	693267	<b>Ref. No.</b>	052803
<b>description</b>	threaded rod		

			
1			
<b>GEV No.</b>	693271	<b>Ref. No.</b>	056823
<b>description</b>	threaded rod thread M6 L 500mm ø 21mm		

			
1			
<b>GEV No.</b>	693292	<b>Ref. No.</b>	0C0674
<b>description</b>	threaded rod thread TR20x4 L 525mm		

			
1			
<b>GEV No.</b>	693283	<b>Ref. No.</b>	051336
<b>description</b>	threaded rod thread TR20x4 L 865mm		

miscellaneous			
			
1			
<b>GEV No.</b>	693284	<b>Ref. No.</b>	051265
<b>description</b>	bracket		

			
1			
<b>GEV No.</b>	693274	<b>Ref. No.</b>	056825
<b>description</b>	bush		

			
1			
<b>GEV No.</b>	693282	<b>Ref. No.</b>	051277
<b>description</b>	bush		

			
1			
<b>GEV No.</b>	523510	<b>Ref. No.</b>	056820
<b>description</b>	deep-groove ball bearing type 6202-2RS shaft ø 15mm ED ø 35mm W 11mm with sealing discs deep-groove ball bearing DIN 625-1		

			
1			
<b>GEV No.</b>	693279	<b>Ref. No.</b>	056852
<b>description</b>	hauling cable for tilting bratt pan complete		



1

<b>GEV No.</b>	693281	<b>Ref. No.</b>	051326
<b>description</b>	spindle		



2

<b>GEV No.</b>	693272	<b>Ref. No.</b>	056818
<b>description</b>	threaded bush		



1

<b>GEV No.</b>	693291	<b>Ref. No.</b>	0C0675
<b>description</b>	threaded bush		



1

<b>GEV No.</b>	693266	<b>Ref. No.</b>	052800
<b>description</b>	threaded bush for tilting bratt pan		



1

<b>GEV No.</b>	693318	<b>Ref. No.</b>	051264
<b>description</b>	threaded bush for tilting bratt pan		

## for boiling pans

### spare parts and accessories



1

<b>GEV No.</b>	690869	<b>Ref. No.</b>	003825
<b>description</b>	bar L 440mm		



1

<b>GEV No.</b>	111634	<b>Ref. No.</b>	058759
<b>description</b>	shaft extension		



1

<b>GEV No.</b>	693285	<b>Ref. No.</b>	051266
<b>description</b>	spigot		

### filters



1

<b>GEV No.</b>	514379	<b>Ref. No.</b>	027114
<b>description</b>	drain filter kettle		



gearboxes

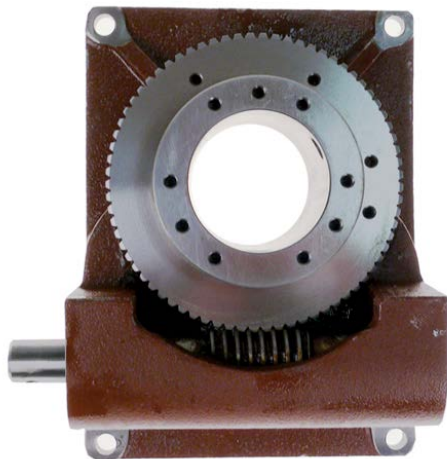

1

<b>GEV No.</b>	520400	<b>Ref. No.</b>	OG1613
<b>description</b>	auger gear		

level glasses

components

level glass pipes



1

<b>GEV No.</b>	697862	<b>Ref. No.</b>	059856
<b>description</b>	level glass pipe ø 10mm L 167mm thickness 1.5mm with O-rings brown		

complete



1

<b>GEV No.</b>	540200	<b>Ref. No.</b>	0H7003
<b>description</b>	level glass for kettle complete thread 1½"		

miscellaneous



1

<b>GEV No.</b>	540993	<b>Ref. No.</b>	OTR591
<b>description</b>	support for manometer size 1/2"		

for pasta cookers

spare parts and accessories



1

<b>GEV No.</b>	693285	<b>Ref. No.</b>	051266
<b>description</b>	spigot		

for dishwashers

containers

container lids



1

<b>GEV No.</b>	504708	<b>Ref. No.</b>	047551
<b>description</b>	lid		



1

<b>GEV No.</b>	510109	<b>Ref. No.</b>	069472
<b>description</b>	lid for salt tank		



1

<b>GEV No.</b>	510110	<b>Ref. No.</b>	069552
<b>description</b>	lid for salt tank		



1

<b>GEV No.</b>	504701	<b>Ref. No.</b>	068644
<b>description</b>	screw cap		

### dosing containers



1

<b>GEV No.</b>	504696	<b>Ref. No.</b>	049975
<b>description</b>	container		



1

<b>GEV No.</b>	504700	<b>Ref. No.</b>	068630
<b>description</b>	container		



1

<b>GEV No.</b>	504690	<b>Ref. No.</b>	049024
----------------	--------	-----------------	--------

**description** dosing container

**spare parts for** 504690



<b>GEV No.</b>	504693	<b>Ref. No.</b>	049022
----------------	--------	-----------------	--------

round filters



<b>GEV No.</b>	504699	<b>Ref. No.</b>	049941
----------------	--------	-----------------	--------

hose connector



1

<b>GEV No.</b>	504707	<b>Ref. No.</b>	047549
----------------	--------	-----------------	--------

**description** rinse aid container



**salt tanks**



1

<b>GEV No.</b>	524177	<b>Ref. No.</b>	069467
<b>description</b>	lid ø 69mm H 20mm for salt tank ID ø 50mm		
<b>accessories for</b>	524177		
	<b>GEV No.</b>	524148	<b>Ref. No.</b>
			—
	O-ring EPDM thickness 3.53mm ID ø 40.86mm Qty 1 pcs		



1

<b>GEV No.</b>	510018	<b>Ref. No.</b>	069469
<b>description</b>	nut ø 92mm H 10.5mm for salt tank ID ø 64mm		



1

<b>GEV No.</b>	510929	<b>Ref. No.</b>	069575
<b>description</b>	salt tank ø 120mm H 117mm hose ø 10mm mounting ø 70mm overall height 157mm		
<b>spare parts for</b>	510929		
	<b>GEV No.</b>	506015	<b>Ref. No.</b>
			—
	O-ring EPDM thickness 3.53mm ID ø 39.69mm Qty 1 pcs		
	<b>GEV No.</b>	510018	<b>Ref. No.</b>
			069469
	nut ø 92mm H 10.5mm for salt tank ID ø 64mm		
	<b>GEV No.</b>	524177	<b>Ref. No.</b>
			069467
	lid ø 69mm H 20mm for salt tank ID ø 50mm		
<b>accessories for</b>	510929		
	<b>GEV No.</b>	510071	<b>Ref. No.</b>
			049244
	flat gasket rubber ED ø 81mm ID ø 68mm thickness 3mm for salt tank Qty 1 pcs		
	<b>GEV No.</b>	510654	<b>Ref. No.</b>
			—
	gasket H 6mm D1 ø 82mm D2 ø 68mm		

**accessories for** 510929

	<b>GEV No.</b>	510883	<b>Ref. No.</b>	—
	gasket rubber ED ø 86mm ID ø 66mm thickness 2mm for salt tank Qty 1 pcs			







1

<b>GEV No.</b>	504232	<b>Ref. No.</b>	049075
<b>description</b>	salt tank ø 120mm H 120mm		



1

<b>GEV No.</b>	510032	<b>Ref. No.</b>	069680
<b>description</b>	salt tank without gasket new model		
<b>spare parts for</b>	510032		
	<b>GEV No.</b>	506015	<b>Ref. No.</b>
			—
	O-ring EPDM thickness 3.53mm ID ø 39.69mm Qty 1 pcs		
	<b>GEV No.</b>	510018	<b>Ref. No.</b>
			069469
	nut ø 92mm H 10.5mm for salt tank ID ø 64mm		
	<b>GEV No.</b>	510071	<b>Ref. No.</b>
			049244
	flat gasket rubber ED ø 81mm ID ø 68mm thickness 3mm for salt tank Qty 1 pcs		
	<b>GEV No.</b>	524177	<b>Ref. No.</b>
			069467
	lid ø 69mm H 20mm for salt tank ID ø 50mm		

accessories



1

<b>GEV No.</b>	510071	<b>Ref. No.</b>	049244
<b>description</b>	flat gasket rubber ED ø 81mm ID ø 68mm thickness 3mm for salt tank Qty 1 pcs		



1

<b>GEV No.</b>	504712	<b>Ref. No.</b>	047548
<b>description</b>	funnel		



1

<b>GEV No.</b>	504713	<b>Ref. No.</b>	047552
<b>description</b>	intake lance		



1

<b>GEV No.</b>	504703	<b>Ref. No.</b>	048434
<b>description</b>	lid suitable for ZANUSSI equiv. no. 048434 external height 20mm		



1

<b>GEV No.</b>	504710	<b>Ref. No.</b>	047550
<b>description</b>	nut		



1

<b>GEV No.</b>	504704	<b>Ref. No.</b>	068627
<b>description</b>	thread bolt for dosing container		

boilers

boilers for dishwashers



1

<b>GEV No.</b>	504740	<b>Ref. No.</b>	069453
<b>description</b>	boiler		



1

<b>GEV No.</b>	504741	<b>Ref. No.</b>	046294
<b>description</b>	boiler		



1

<b>GEV No.</b>	504744	<b>Ref. No.</b>	047950
<b>description</b>	boiler		



1

<b>GEV No.</b>	504745	<b>Ref. No.</b>	049336
<b>description</b>	boiler		



1

<b>GEV No.</b>	504746	<b>Ref. No.</b>	048548
<b>description</b>	boiler		



1

<b>GEV No.</b>	504747	<b>Ref. No.</b>	0L1639
<b>description</b>	boiler		



			
1			
<b>GEV No.</b>	504748	<b>Ref. No.</b>	049958
<b>description</b>	boiler		



			
1			
<b>GEV No.</b>	504749	<b>Ref. No.</b>	049902
<b>description</b>	boiler		

			
1			
<b>GEV No.</b>	504751	<b>Ref. No.</b>	049632
<b>description</b>	boiler		

			
1			
<b>GEV No.</b>	504756	<b>Ref. No.</b>	0L1906
<b>description</b>	boiler		

			
1			
<b>GEV No.</b>	504759	<b>Ref. No.</b>	0L0514
<b>description</b>	boiler kit		

			
1			
<b>GEV No.</b>	504739	<b>Ref. No.</b>	0L2081
<b>description</b>	boiler ø 140mm L 325mm inlet ø 48mm		

accessories			
			
1			
<b>GEV No.</b>	511459	<b>Ref. No.</b>	069459
<b>description</b>	connecting fitting for boiler		
<b>accessories for</b>	511459		
			
	<b>GEV No.</b>	511460	<b>Ref. No.</b>
			069461
	<b>description</b>	connecting fitting for boiler	

			
1			
<b>GEV No.</b>	511460	<b>Ref. No.</b>	069461
<b>description</b>	connecting fitting for boiler		

			
1			
<b>GEV No.</b>	517339	<b>Ref. No.</b>	005381
<b>description</b>	flange ø 74mm ID ø 33mm thickness 1mm hole ø 9mm		

softener cartridges			
softening columns			
			
1			
<b>GEV No.</b>	505102	<b>Ref. No.</b>	049074
<b>description</b>	softener 4-fold L 380mm W 180mm		

			
1			
<b>GEV No.</b>	530000	<b>Ref. No.</b>	069476
<b>description</b>	softener 4-fold L 380mm W 180mm		

## housing and bezels

## fascias



1

<b>GEV No.</b>	504709	<b>Ref. No.</b>	047547
<b>description</b>	bezel		

## trapdoors



1

<b>GEV No.</b>	504706	<b>Ref. No.</b>	048465
<b>description</b>	door		



1

<b>GEV No.</b>	504698	<b>Ref. No.</b>	048363
<b>description</b>	door for rinse aid container		

## hood mechanics for dishwashers

## bolts



1

<b>GEV No.</b>	504679	<b>Ref. No.</b>	048349
<b>description</b>	screw bolt hood mechanics		

## bushes



1

<b>GEV No.</b>	504677	<b>Ref. No.</b>	046538
<b>description</b>	bush hood mechanics		

## rollers



1

<b>GEV No.</b>	504681	<b>Ref. No.</b>	049598
<b>description</b>	roller hood mechanics		



1

<b>GEV No.</b>	524964	<b>Ref. No.</b>	048657
<b>description</b>	roller ø 34.5mm H 26mm for hood mechanics plastic hole ø 10mm		



1

<b>GEV No.</b>	524963	<b>Ref. No.</b>	048260
<b>description</b>	roller ø 49mm H 21.5mm for hood mechanics plastic white hole ø 10mm		

## miscellaneous



1

<b>GEV No.</b>	504680	<b>Ref. No.</b>	049597
<b>description</b>	linkage guide hood mechanics		









 <p>Image not available</p>			
1			
<b>GEV No.</b>	504766	<b>Ref. No.</b>	048297
<b>description</b>	pin hood mechanics		



			
2			
<b>GEV No.</b>	504678	<b>Ref. No.</b>	049430
<b>description</b>	screw connection hood mechanics		

air traps



air traps

			
1			
<b>GEV No.</b>	504617	<b>Ref. No.</b>	048853
<b>description</b>	air trap		
<b>accessories for</b>	504617		
			
	<b>GEV No.</b>	504618	<b>Ref. No.</b> 068642
	O-ring EPDM thickness 2.62mm ID ø 15.54mm Qty 1 pcs		
			
	<b>GEV No.</b>	504621	<b>Ref. No.</b> 049268
	nut		





			
1			
<b>GEV No.</b>	504620	<b>Ref. No.</b>	048308
<b>description</b>	air trap		
<b>accessories for</b>	504620		
			
	<b>GEV No.</b>	504618	<b>Ref. No.</b> 068642
	O-ring EPDM thickness 2.62mm ID ø 15.54mm Qty 1 pcs		
			
	<b>GEV No.</b>	504621	<b>Ref. No.</b> 049268
	nut		

			
1			
<b>GEV No.</b>	504622	<b>Ref. No.</b>	046631
<b>description</b>	air trap		
<b>accessories for</b>	504622		
			
	<b>GEV No.</b>	511452	<b>Ref. No.</b> 067930
	gasket for air trap		

<b>accessories for</b>	504622		
			
	<b>GEV No.</b>	528487	<b>Ref. No.</b> —
	O-ring EPDM thickness 2.62mm ID ø 9.19mm Qty 1 pcs		



			
1			
<b>GEV No.</b>	504624	<b>Ref. No.</b>	045459
<b>description</b>	air trap		
<b>accessories for</b>	504624		
			
	<b>GEV No.</b>	528487	<b>Ref. No.</b> —
	O-ring EPDM thickness 2.62mm ID ø 9.19mm Qty 1 pcs		

			
1			
<b>GEV No.</b>	511445	<b>Ref. No.</b>	0L0098
<b>description</b>	air trap L 230mm W 60mm hose ø 6mm		

			
1			
<b>GEV No.</b>	510103	<b>Ref. No.</b>	069515
<b>description</b>	air trap L 85mm W 20mm H 80mm hose ø 6mm plastic		
<b>spare parts for</b>	510103		
			
	<b>GEV No.</b>	505045	<b>Ref. No.</b> —
	O-ring EPDM thickness 1.78mm ID ø 5.28mm Qty 1 pcs		
			
	<b>GEV No.</b>	505094	<b>Ref. No.</b> —
	air trap		
			
	<b>GEV No.</b>	510016	<b>Ref. No.</b> 069646
	eye bolt for rinse aid container connection		
			
	<b>GEV No.</b>	510105	<b>Ref. No.</b> 069670
	hose connector for air trap		

air trap accessories

			
1			
<b>GEV No.</b>	511452	<b>Ref. No.</b>	067930
<b>description</b>	gasket for air trap		

			
1			
<b>GEV No.</b>	510105	<b>Ref. No.</b>	069670
<b>description</b>	hose connector for air trap		
<b>spare parts for</b>	510105		
	<b>GEV No.</b>	510017	<b>Ref. No.</b> 069987
	union screw		

			
1			
<b>GEV No.</b>	504621	<b>Ref. No.</b>	049268
<b>description</b>	nut		

## mechanics for flight type dishwashers

			
1			
<b>GEV No.</b>	510598	<b>Ref. No.</b>	0E5006
<b>description</b>	guide for spindle L 60mm W 40mm hole ø 21mm thickness 15mm		

			
1			
<b>GEV No.</b>	511483	<b>Ref. No.</b>	0K8142
<b>description</b>	hook		

			
1			
<b>GEV No.</b>	504603	<b>Ref. No.</b>	0K8166
<b>description</b>	hook for dishwasher		



			
1			
<b>GEV No.</b>	511597	<b>Ref. No.</b>	0KU566
<b>description</b>	tappet for dishwasher L 140mm W 45mm H 68mm hole ø 8.4mm		

## backflow preventers



## backflow preventers

			
1			
<b>GEV No.</b>	510789	<b>Ref. No.</b>	048191
<b>description</b>	backflow preventer		

			
1			
<b>GEV No.</b>	524491	<b>Ref. No.</b>	0L2435
<b>description</b>	backflow preventer		

			
1			
<b>GEV No.</b>	511446	<b>Ref. No.</b>	049459
<b>description</b>	backflow preventer dimensions 200x260mm		
<b>accessories for</b>	511446		
	<b>GEV No.</b>	511448	<b>Ref. No.</b> 049480
	lid for back flow restrictor		
	<b>GEV No.</b>	512175	<b>Ref. No.</b> 049460
	O-ring EPDM thickness 2.62mm ID ø 53.65mm Qty 1 pcs		



			
1			
<b>GEV No.</b>	516101	<b>Ref. No.</b>	0L1892
<b>description</b>	backflow preventer dishwasher hose ø 12mm		
<b>spare parts for</b>	516101		
	<b>GEV No.</b>	506367	<b>Ref. No.</b> —
	 flat gasket rubber ED ø 40mm ID ø 28mm thickness 1.8mm Qty 1 pcs		

			
1			
<b>GEV No.</b>	520273	<b>Ref. No.</b>	049851
<b>description</b>	non-return valve brass connection 1/2" IT - 1/2" IT total length 60mm DN15		

accessories			
			
1			
<b>GEV No.</b>	511448	<b>Ref. No.</b>	049480
<b>description</b>	lid for back flow restrictor		

door mechanics			
bolts			
			
1			
<b>GEV No.</b>	504658	<b>Ref. No.</b>	047478
<b>description</b>	bolt for hinge		

springs			
roller springs			
			
1			
<b>GEV No.</b>	519449	<b>Ref. No.</b>	0E5158
<b>description</b>	roller spring W 25mm ID ø 32mm lug lengthmm		

linkage			
			
1			
<b>GEV No.</b>	504643	<b>Ref. No.</b>	049282
<b>description</b>	door pin		

			
1			
<b>GEV No.</b>	504654	<b>Ref. No.</b>	048581
<b>description</b>	door pin spring linkage		

			
1			
<b>GEV No.</b>	507413	<b>Ref. No.</b>	0L0034
<b>description</b>	linkage guide L 220mm H 5mm W 30mm		

sliding plates			
			
1			
<b>GEV No.</b>	504645	<b>Ref. No.</b>	049285
<b>description</b>	sliding plate sliding plate		

hinges			
			
1			
<b>GEV No.</b>	504651	<b>Ref. No.</b>	048582
<b>description</b>	door hinge hinge left mounting pos. left		

			
1			
<b>GEV No.</b>	504647	<b>Ref. No.</b>	0L0718
<b>description</b>	door hinge hinge lever left mounting pos. left		

			
1			
<b>GEV No.</b>	504646	<b>Ref. No.</b>	0L0717
<b>description</b>	door hinge hinge lever right mounting pos. right		

			
1			
<b>GEV No.</b>	518547	<b>Ref. No.</b>	069513
<b>description</b>	door hinge hinge mounting pos. left		

			
1			
<b>GEV No.</b>	518253	<b>Ref. No.</b>	0A6146
<b>description</b>	door hinge hinge mounting pos. right		

			
1			
<b>GEV No.</b>	504650	<b>Ref. No.</b>	048583
<b>description</b>	door hinge hinge right mounting pos. right		

<b>hinge pins</b>			
			
1			
<b>GEV No.</b>	504642	<b>Ref. No.</b>	049281
<b>description</b>	hinge pin hinge pin		

			
1			
<b>GEV No.</b>	518097	<b>Ref. No.</b>	049685
<b>description</b>	hinge pin ø 25mm D1 ø 16mm L 34mm thread M8 stainless steel		

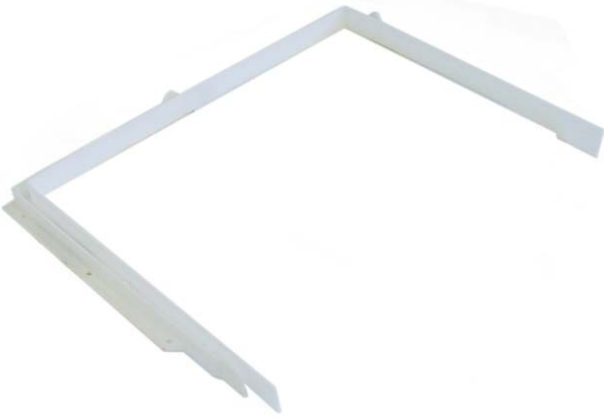
<b>door frames</b>			
			
1			
<b>GEV No.</b>	504665	<b>Ref. No.</b>	047483
<b>description</b>	door frame door frame		

<b>door bumpers</b>			
			
1			
<b>GEV No.</b>	504644	<b>Ref. No.</b>	049286
<b>description</b>	door bumper end stop		

<b>locks</b>			
			
1			
<b>GEV No.</b>	504663	<b>Ref. No.</b>	049536
<b>description</b>	door catch L 35mm W 12mm H 28mm mounting distance 28mm		







			
1			
<b>GEV No.</b>	504659	<b>Ref. No.</b>	047491
<b>description</b>	door catch L 84mm W 19mm H 31mm mounting distance 64mm catch housing		

			
1			
<b>GEV No.</b>	504641	<b>Ref. No.</b>	049280
<b>description</b>	hinge mounting pos. left hinge		

miscellaneous			
			
1			
<b>GEV No.</b>	504482	<b>Ref. No.</b>	0L0366
<b>description</b>	bracket H 19mm L 70mm W 35mm		

			
1			
<b>GEV No.</b>	504656	<b>Ref. No.</b>	046291
<b>description</b>	hinge mounting pos. left hinge		

			
1			
<b>GEV No.</b>	504648	<b>Ref. No.</b>	048812
<b>description</b>	bush bush		

			
1			
<b>GEV No.</b>	504640	<b>Ref. No.</b>	049279
<b>description</b>	hinge mounting pos. right hinge		

			
1			
<b>GEV No.</b>	518081	<b>Ref. No.</b>	0L0608
<b>description</b>	handle rail set 3-piece L 550mm		

			
1			
<b>GEV No.</b>	504655	<b>Ref. No.</b>	046292
<b>description</b>	hinge mounting pos. right hinge		

			
1			
<b>GEV No.</b>	504657	<b>Ref. No.</b>	048161
<b>description</b>	hinge hinge		

			
1			
<b>GEV No.</b>	504636	<b>Ref. No.</b>	049246
<b>description</b>	plate plastic plastic plate		

			
1			
<b>GEV No.</b>	504637	<b>Ref. No.</b>	049802
<b>description</b>	spring jack spring jack		

curtains

curtains



1  
**GEV No.** 533110    **Ref. No.** 046883

**description** curtain W 530mm H 350mm warewashing



1  
**GEV No.** 533109    **Ref. No.** 0E5277

**description** curtain W 545mm H 445mm warewashing



1  
**GEV No.** 533004    **Ref. No.** 0E5038

**description** curtain W 550mm H 355mm

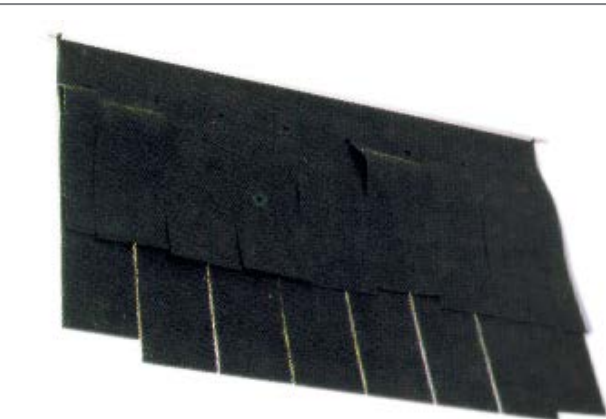

1  
**GEV No.** 533105    **Ref. No.** 046882

**description** curtain W 575mm H 420mm warewashing



1  
**GEV No.** 533106    **Ref. No.** 048042

**description** curtain W 640mm H 430mm warewashing

washing and rinsing systems



1  
**GEV No.** 504529    **Ref. No.** 048401

**description** bush



1  
**GEV No.** 504550    **Ref. No.** 046362

**description** bush



1  
**GEV No.** 693407    **Ref. No.** 0C5103

**description** bush for wash arm





1  
**GEV No.** 504504    **Ref. No.** 049042

**description** bush wash arm





			
1			
<b>GEV No.</b>	504515	<b>Ref. No.</b>	049294
<b>description</b>	connector holder		

			
1			
<b>GEV No.</b>	504542	<b>Ref. No.</b>	047991
<b>description</b>	connector holder		

			
1			
<b>GEV No.</b>	510016	<b>Ref. No.</b>	069646
<b>description</b>	eye bolt for rinse aid container connection		

			
1			
<b>GEV No.</b>	504261	<b>Ref. No.</b>	0L0077
<b>description</b>	hose ø 63/53mm L 230mm L-shape		

			
1			
<b>GEV No.</b>	504503	<b>Ref. No.</b>	049047
<b>description</b>	knurled nut thread M10x1 ø 30mm H 4mm SS		

			
1			
<b>GEV No.</b>	504528	<b>Ref. No.</b>	048632
<b>description</b>	knurled nut thread M12x1 ø 35mm H 6mm SS		

			
1			
<b>GEV No.</b>	504516	<b>Ref. No.</b>	047282
<b>description</b>	knurled nut thread M8x1 ø 25mm H 6mm SS		

			
1			
<b>GEV No.</b>	504547	<b>Ref. No.</b>	047283
<b>description</b>	knurled nut thread M8x1 ø 25mm H 6mm SS		

			
1			
<b>GEV No.</b>	504272	<b>Ref. No.</b>	049596
<b>description</b>	nut		

			
1			
<b>GEV No.</b>	504555	<b>Ref. No.</b>	047891
<b>description</b>	nut		

			
1			
<b>GEV No.</b>	504506	<b>Ref. No.</b>	049039
<b>description</b>	nut for wash arm support		

			
1			
<b>GEV No.</b>	504517	<b>Ref. No.</b>	048330
<b>description</b>	nut for wash arm support		

			
1			
<b>GEV No.</b>	504523	<b>Ref. No.</b>	048824
<b>description</b>	nut for wash arm support		

			
1			
<b>GEV No.</b>	504536	<b>Ref. No.</b>	048237
<b>description</b>	nut for wash arm support		

			
1			
<b>GEV No.</b>	504505	<b>Ref. No.</b>	049043
<b>description</b>	nut wash arm		

			
1			
<b>GEV No.</b>	693409	<b>Ref. No.</b>	007026
<b>description</b>	retainer clip for wash arm		

			
1			
<b>GEV No.</b>	518003	<b>Ref. No.</b>	069444
<b>description</b>	screw cap		

			
1			
<b>GEV No.</b>	510011	<b>Ref. No.</b>	069497
<b>description</b>	screw connection plastic		

			
1			
<b>GEV No.</b>	504520	<b>Ref. No.</b>	048820
<b>description</b>	throttle disc		

			
1			
<b>GEV No.</b>	504530	<b>Ref. No.</b>	048931
<b>description</b>	throttle disc		

			
1			
<b>GEV No.</b>	510112	<b>Ref. No.</b>	069440
<b>description</b>	Thumb screw thread M10 thread L 10mm ø 22mm H 4.5mm SS		

			
1			
<b>GEV No.</b>	693405	<b>Ref. No.</b>	007009
<b>description</b>	wash arm support		

			
1			
<b>GEV No.</b>	693406	<b>Ref. No.</b>	0C5293
<b>description</b>	wash arm support		

			
1			
<b>GEV No.</b>	507411	<b>Ref. No.</b>	046860
<b>description</b>	wash jet		

			
1			
<b>GEV No.</b>	504560	<b>Ref. No.</b>	046400
<b>description</b>	wash pipe		

			
1			
<b>GEV No.</b>	518102	<b>Ref. No.</b>	0L0095
<b>description</b>	wash pipe L 700mm with rinse arm shaft		



			
1			
<b>GEV No.</b>	504634	<b>Ref. No.</b>	046542
<b>description</b>	wash pipe ø 60mm L 400mm		

			
1			
<b>GEV No.</b>	504258	<b>Ref. No.</b>	0E2969
<b>description</b>	wash pipe ø 63mm L 185mm L-shape		

## knobs

### universal knobs

			
1			
<b>GEV No.</b>	110253	<b>Ref. No.</b>	0A2269
<b>description</b>	knob switch zero mark t.max.°C ø 50mm shaft ø 6x4.6mm shaft flat upper black		

### producer-specific knobs

#### ELECTROLUX (Zanussi, Alpeninox, Therma, Juno)

			
1			
<b>GEV No.</b>	111599	<b>Ref. No.</b>	052604
<b>description</b>	knob gas tap with ignition flame ø 50mm shaft ø 10x8mm shaft flat upper black		

			
1			
<b>GEV No.</b>	111595	<b>Ref. No.</b>	054105
<b>description</b>	knob gas tap without ignition flame ø 50mm shaft ø 8x6.5mm shaft flat upper black		

			
1			
<b>GEV No.</b>	111639	<b>Ref. No.</b>	051697
<b>description</b>	knob switch 5-position ø 50mm shaft ø 6x4.6mm shaft flat upper		

			
1			
<b>GEV No.</b>	110280	<b>Ref. No.</b>	059249
<b>description</b>	knob gas thermostat t.max. 330°C temperature range 120-330°C ø 55mm shaft ø 8x6.5mm shaft flat upper black		

			
1			
<b>GEV No.</b>	111773	<b>Ref. No.</b>	002671
<b>description</b>	knob ø 55mm shaft ø 6x4.6mm shaft flat universal universal		

			
1			
<b>GEV No.</b>	111710	<b>Ref. No.</b>	002672
<b>description</b>	knob switch zero mark t.max.°C temperature range°C ø 55mm shaft ø 6x4.6mm shaft flat upper white		

			
1			
<b>GEV No.</b>	111966	<b>Ref. No.</b>	0C3022
<b>description</b>	knob time 120min ø 55mm shaft ø 6x4.6mm shaft flat lower grey		



1

<b>GEV No.</b>	112705	<b>Ref. No.</b>	003743
<b>description</b>	knob zero mark t.max.°C temperature range°C ø 55mm shaft ø 6x4.6mm shaft flat upper grey		
<b>spare parts for</b>	112705		
	<b>GEV No.</b>	550132	<b>Ref. No.</b>
			025245
	knob spring ø 6x4.6mm Qty 10 pcs		



1

<b>GEV No.</b>	110445	<b>Ref. No.</b>	059386
<b>description</b>	knob gas tap with ignition flame t.max.°C temperature range°C ø 70mm shaft ø 10x8mm shaft flat upper black		



1

<b>GEV No.</b>	110283	<b>Ref. No.</b>	059244
<b>description</b>	knob gas tap with ignition flame t.max.°C temperature range°C ø 70mm shaft ø 8x6.5mm shaft flat upper black		



1

<b>GEV No.</b>	110290	<b>Ref. No.</b>	058561
<b>description</b>	knob gas tap without ignition flame t.max.°C ø 70mm shaft ø 8x6.5mm shaft flat upper		



1

<b>GEV No.</b>	111600	<b>Ref. No.</b>	059538
<b>description</b>	knob graduated t.max.°C temperature range°C ø 70mm shaft ø 10x8mm		



1

<b>GEV No.</b>	110708	<b>Ref. No.</b>	004987
<b>description</b>	knob energy regulator 1-6 + MAX t.max.°C temperature range°C ø 60mm shaft ø 6x4.6mm shaft flat left black		



1

<b>GEV No.</b>	110070	<b>Ref. No.</b>	051638
<b>description</b>	knob gas tap with ignition flame ø 60mm black shaft special		



1

<b>GEV No.</b>	110045	<b>Ref. No.</b>	052138
<b>description</b>	knob gas tap with ignition flame ø 60mm shaft ø 10x8mm shaft flat upper black		



1

<b>GEV No.</b>	110716	<b>Ref. No.</b>	004966
<b>description</b>	knob gas tap with ignition flame t.max.°C temperature range°C ø 60mm shaft ø 8x6.5mm shaft flat lower black		



1

<b>GEV No.</b>	110710	<b>Ref. No.</b>	004957
<b>description</b>	knob gas tap without ignition flame t.max.°C temperature range°C ø 60mm shaft ø 8x6.5mm shaft flat lower black		

1

<b>GEV No.</b>	110714	<b>Ref. No.</b>	005672
<b>description</b>	knob gas thermostat 1-7 t.max.°C temperature range°C ø 60mm shaft ø 8x6.5mm shaft flat lower black		



1

<b>GEV No.</b>	110711	<b>Ref. No.</b>	004913
<b>description</b>	knob switch 7-position t.max.°C temperature range°C ø 60mm shaft ø 6x4.6mm shaft flat right black		



1

<b>GEV No.</b>	110399	<b>Ref. No.</b>	052087
<b>description</b>	knob oven TH/BH/TH+BH ø 60mm shaft ø 6x4.6mm shaft flat lower black		



1

<b>GEV No.</b>	110715	<b>Ref. No.</b>	004924
<b>description</b>	knob thermostat t.max. 190°C temperature range 10x9°C ø 60mm shaft ø 6x4.6mm shaft flat right black		



1

<b>GEV No.</b>	110043	<b>Ref. No.</b>	050341
<b>description</b>	knob switch 0-1-0-1 ø 60mm shaft ø 6x4.6mm shaft flat upper black		



1

<b>GEV No.</b>	110707	<b>Ref. No.</b>	005432
<b>description</b>	knob thermostat t.max. 275°C temperature range 50-275°C ø 59mm shaft ø 6x4.6mm shaft flat right rotation 270° black		



1

<b>GEV No.</b>	110042	<b>Ref. No.</b>	051552
<b>description</b>	knob switch 5-position ø 60mm shaft ø 6x4.6mm shaft flat upper black		



1

<b>GEV No.</b>	110713	<b>Ref. No.</b>	004916
<b>description</b>	knob thermostat t.max. 310°C temperature range 100-310°C ø 60mm shaft ø 6x4.6mm shaft flat right black		



1

<b>GEV No.</b>	110397	<b>Ref. No.</b>	052183
<b>description</b>	knob switch 5-position ø 60mm shaft ø 6x4.6mm shaft flat upper black		



1

<b>GEV No.</b>	110712	<b>Ref. No.</b>	004909
<b>description</b>	knob thermostat t.max. 90°C temperature range 30-90°C ø 60mm shaft ø 6x4.6mm shaft flat right rotation 270° black		



1

<b>GEV No.</b>	111768	<b>Ref. No.</b>	055447
<b>description</b>	knob gas tap with ignition flame ø 20mm		



1

<b>GEV No.</b>	111646	<b>Ref. No.</b>	003704
<b>description</b>	knob gas tap without ignition flame ø 30mm black		



1

<b>GEV No.</b>	111767	<b>Ref. No.</b>	056452
<b>description</b>	knob gas tap without ignition flame ø 30mm white		



1

<b>GEV No.</b>	112340	<b>Ref. No.</b>	048340
<b>description</b>	knob switch zero mark t.max.°C temperature range°C ø 40mm shaft ø 6x4.6mm shaft flat left black		



1

<b>GEV No.</b>	110203	<b>Ref. No.</b>	003762
<b>description</b>	knob switch zero mark t.max.°C temperature range°C ø 55mm shaft ø 6x4.6mm shaft flat upper black		



1

<b>GEV No.</b>	110046	<b>Ref. No.</b>	026915
<b>description</b>	knob thermostat 1-8 t.max.°C ø 60mm shaft ø 8 x 5mm shaft flat lower		



1

<b>GEV No.</b>	111660	<b>Ref. No.</b>	006570
<b>description</b>	knob thermostat t.max. 190°C temperature range 110-190°C ø 60mm shaft ø MERTIKmm black		



1

<b>GEV No.</b>	111625	<b>Ref. No.</b>	006464
<b>description</b>	knob thermostat t.max. 250°C temperature range 90-250°C ø 60mm shaft ø MERTIKmm black		



1

<b>GEV No.</b>	111686	<b>Ref. No.</b>	005208
<b>description</b>	knob thermostat t.max. 300°C temperature range 50-300°C ø 54mm shaft ø 6x4.6mm shaft flat upper rotation 270° silver		

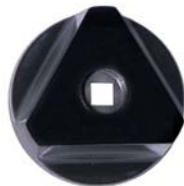

1

<b>GEV No.</b>	110287	<b>Ref. No.</b>	025260	
<b>description</b>	knob water t.max.°C temperature range°C ø 50mm shaft ø 7x7mm shaft flat black			
<b>accessories for</b>	110287			
	<b>GEV No.</b>	110288	<b>Ref. No.</b>	054367
	cover cap knob white			





1 

<b>GEV No.</b>	111445	<b>Ref. No.</b>	047844
<b>description</b>	knob zero mark ø 40mm shaft ø 6x4.6mm shaft flat right light blue		

1 

<b>GEV No.</b>	110291	<b>Ref. No.</b>	056197
<b>description</b>	knob thermostat t.max. 250°C temperature range 50-250°C ø 55mm shaft ø 6x4.6mm shaft flat lower rotation 310° grey		

1 

<b>GEV No.</b>	110474	<b>Ref. No.</b>	056222
<b>description</b>	knob convection oven ø 55mm shaft ø 6x4.6mm shaft flat lower		

1 

<b>GEV No.</b>	111442	<b>Ref. No.</b>	047693
<b>description</b>	knob zero mark ø 42mm shaft ø 6x4.6mm shaft flat right grey		

1 

<b>GEV No.</b>	111943	<b>Ref. No.</b>	056198
<b>description</b>	knob energy regulator ø 55mm shaft ø 6x4.6mm shaft flat lower black		

1 

<b>GEV No.</b>	111770	<b>Ref. No.</b>	006948
<b>description</b>	knob set 120min, 1 - 10, 50 - 250°C ø 55mm shaft ø 6x4.6mm shaft flat upper/lower grey 3-piece		
<b>accessories for</b>	111770		
	<b>GEV No.</b>	550132	<b>Ref. No.</b> 025245
	knob spring ø 6x4.6mm Qty 10 pcs		

1 

<b>GEV No.</b>	111684	<b>Ref. No.</b>	056204
<b>description</b>	knob oven ø 55mm shaft ø 6x4.6mm shaft flat lower		

1 

<b>GEV No.</b>	110137	<b>Ref. No.</b>	048402
<b>description</b>	knob switch zero mark ø 44mm shaft ø 6x4.6mm shaft flat left black		

1 

<b>GEV No.</b>	111761	<b>Ref. No.</b>	056127
<b>description</b>	knob programme ø 55mm shaft ø 6x4.6mm shaft flat lower		

1 

<b>GEV No.</b>	110907	<b>Ref. No.</b>	048830
<b>description</b>	knob switch zero mark ø 44mm shaft ø 6x4.6mm shaft flat left black		



1

<b>GEV No.</b>	111765	<b>Ref. No.</b>	055474
<b>description</b>	knob core temperature t.max. 100°C temperature range 50-100°C ø 55mm shaft ø 6x4.6mm shaft flat lower black		



1

<b>GEV No.</b>	111614	<b>Ref. No.</b>	0C0189
<b>description</b>	knob switch zero mark t.max. °C temperature range °C ø 46mm shaft MERTIK shaft ømm shaft flat black		



1

<b>GEV No.</b>	111602	<b>Ref. No.</b>	0C0257
<b>description</b>	knob switch zero mark ø 46mm shaft standard shaft ø 6x4.6mm shaft flat upper black		
<b>accessories for</b>	111602		
	<b>GEV No.</b>	111607	<b>Ref. No.</b> 053816
	<b>GEV No.</b>	111628	<b>Ref. No.</b> 0C0466
	<b>GEV No.</b>	550132	<b>Ref. No.</b> 025245



1

<b>GEV No.</b>	111631	<b>Ref. No.</b>	0C0465
<b>description</b>	knob switch zero mark t.max. °C temperature range °C ø 46mm shaft ø 10x8mm shaft flat upper black		



1

<b>GEV No.</b>	111632	<b>Ref. No.</b>	0C0192
<b>description</b>	bezel gas tap with ignition flame t.max. °C for front hob		



1

<b>GEV No.</b>	111598	<b>Ref. No.</b>	0C0191
<b>description</b>	knob switch zero mark ø 46mm shaft standard shaft ø 8x6.5mm shaft flat upper black		



1

<b>GEV No.</b>	111633	<b>Ref. No.</b>	0C0193
<b>description</b>	bezel gas tap with ignition flame t.max. °C for rear hob		



1

<b>GEV No.</b>	111615	<b>Ref. No.</b>	0C0190
<b>description</b>	knob switch zero mark t.max. °C temperature range °C ø 32mm shaft MERTIK shaft ømm shaft flat grey		





1

<b>GEV No.</b>	111621	<b>Ref. No.</b>	0C0259
<b>description</b>	bezel oven TH/BH/TH+BH		





			
1			
<b>GEV No.</b>	111654	<b>Ref. No.</b>	0C0518
<b>description</b>	bezel switch 0-1-0-1		

			
1			
<b>GEV No.</b>	111665	<b>Ref. No.</b>	0C0615
<b>description</b>	bezel thermostat t.max. 185°C 105-185°C		

			
1			
<b>GEV No.</b>	111635	<b>Ref. No.</b>	0C0560
<b>description</b>	bezel switch 4-position		

			
1			
<b>GEV No.</b>	111628	<b>Ref. No.</b>	0C0466
<b>description</b>	bezel thermostat t.max. 280°C 120-280°C		

			
1			
<b>GEV No.</b>	111605	<b>Ref. No.</b>	0C0304
<b>description</b>	bezel switch 7-position for front hob		

			
1			
<b>GEV No.</b>	111620	<b>Ref. No.</b>	0C0258
<b>description</b>	bezel thermostat t.max. 300°C 100-300°C		

			
1			
<b>GEV No.</b>	111606	<b>Ref. No.</b>	0C0307
<b>description</b>	bezel switch 7-position for rear hob		

			
1			
<b>GEV No.</b>	111653	<b>Ref. No.</b>	0C0515
<b>description</b>	bezel thermostat t.max. 90°C 30-90°C		

			
1			
<b>GEV No.</b>	111608	<b>Ref. No.</b>	0C0317
<b>description</b>	bezel thermostat 1-8 for front hob		

			
1			
<b>GEV No.</b>	111675	<b>Ref. No.</b>	0C0711
<b>description</b>	bezel water hot/cold		

			
1			
<b>GEV No.</b>	111609	<b>Ref. No.</b>	0C0318
<b>description</b>	bezel thermostat 1-8 for rear hob		

			
1			
<b>GEV No.</b>	111661	<b>Ref. No.</b>	0C0623
<b>description</b>	bezel gas regulator t.max. 190°C 120-190°C		



1

<b>GEV No.</b>	111613	<b>Ref. No.</b>	0C0194
<b>description</b>	bezel gas regulator t.max. 270°C 110-270°C		



1

<b>GEV No.</b>	111626	<b>Ref. No.</b>	0C0597
<b>description</b>	bezel gas regulator t.max. 270°C 110-270°C		



1

<b>GEV No.</b>	111650	<b>Ref. No.</b>	0C0503
<b>description</b>	bezel gas regulator t.max. 90°C 30-90°C		



1

<b>GEV No.</b>	110448	<b>Ref. No.</b>	059378
<b>description</b>	knob gas tap with ignition flame t.max.°C temperature range°C ø 70mm shaft ø 10x8mm shaft flat upper black		



1

<b>GEV No.</b>	110348	<b>Ref. No.</b>	059206
<b>description</b>	knob gas tap with ignition flame t.max.°C temperature range°C ø 70mm shaft ø 8x6.5mm shaft flat upper black		



1

<b>GEV No.</b>	111596	<b>Ref. No.</b>	004329
<b>description</b>	knob gas tap without ignition flame t.max.°C temperature range°C ø 70mm shaft ø 8x6.5mm shaft flat upper black		



1

<b>GEV No.</b>	111624	<b>Ref. No.</b>	059422
<b>description</b>	knob gas thermostat t.max. 280°C ø 70mm shaft ø 8x6.5mm shaft flat upper black		



1

<b>GEV No.</b>	111612	<b>Ref. No.</b>	004336
<b>description</b>	knob gas thermostat t.max. 290°C ø 70mm shaft ø 8x6.5mm shaft flat upper black		



1

<b>GEV No.</b>	110446	<b>Ref. No.</b>	059413
<b>description</b>	knob gas thermostat t.max. 300°C ø 70mm shaft ø 8x6.5mm shaft flat upper		



1

<b>GEV No.</b>	110286	<b>Ref. No.</b>	059801
<b>description</b>	knob gas thermostat t.max. 90°C temperature range 30-90°C ø 70mm shaft ø 8x6.5mm shaft flat upper black		





1

<b>GEV No.</b>	111534	<b>Ref. No.</b>	059304
<b>description</b>	knob gas valves t.max.°C temperature range°C ø 70mm shaft ø 10x8mm shaft flat upper black		

			
1			
<b>GEV No.</b>	111644	<b>Ref. No.</b>	059531
<b>description</b>	knob water cold t.max.°C temperature range°C ø 70mm shaft ø 10x8mm shaft flat upper black H 25mm		

			
1			
<b>GEV No.</b>	111618	<b>Ref. No.</b>	004343
<b>description</b>	knob oven t.max.°C temperature range°C ø 70mm shaft ø 6x4.6mm shaft flat upper black		

			
1			
<b>GEV No.</b>	111680	<b>Ref. No.</b>	059516
<b>description</b>	knob water hot ø 70mm shaft ø 10x8mm shaft flat upper black/red H 39mm		

			
1			
<b>GEV No.</b>	110449	<b>Ref. No.</b>	059333
<b>description</b>	knob switch 0-1-0-1 ø 70mm shaft ø 6x4.6mm shaft flat upper black		

			
1			
<b>GEV No.</b>	111643	<b>Ref. No.</b>	004465
<b>description</b>	knob water t.max.°C temperature range°C ø 70mm shaft ø 10x8mm shaft flat upper black		

			
1			
<b>GEV No.</b>	111637	<b>Ref. No.</b>	059546
<b>description</b>	knob switch 4-position t.max.°C temperature range°C ø 70mm shaft ø 6x4.6mm shaft flat upper black		

			
1			
<b>GEV No.</b>	111640	<b>Ref. No.</b>	059779
<b>description</b>	knob energy regulator 1-8 + MAX ø 70mm shaft ø 6x4.6mm shaft flat upper black		

			
1			
<b>GEV No.</b>	110428	<b>Ref. No.</b>	059230
<b>description</b>	knob switch 7-position t.max.°C temperature range°C ø 70mm shaft ø 6x4.6mm shaft flat upper black		

			
1			
<b>GEV No.</b>	110429	<b>Ref. No.</b>	059554
<b>description</b>	knob energy regulator 1-8 + MAX t.max.°C temperature range°C ø 70mm shaft ø 6x4.6mm shaft flat upper black		

			
1			
<b>GEV No.</b>	111659	<b>Ref. No.</b>	059303
<b>description</b>	knob thermostat t.max. 185°C temperature range 105-185°C ø 70mm shaft ø 6x4.6mm shaft flat upper black		



1

<b>GEV No.</b>	110447	<b>Ref. No.</b>	059403
<b>description</b>	knob thermostat t.max. 280°C temperature range 120-280°C ø 70mm shaft ø 6x4.6mm shaft flat upper rotation 270° black		



1

<b>GEV No.</b>	110467	<b>Ref. No.</b>	002386
<b>description</b>	knob thermostat t.max. 90°C temperature range 30-90°C ø 70mm shaft ø 6x4.6mm shaft flat upper rotation 270° black		

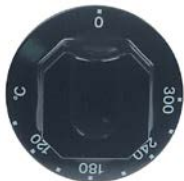

1

<b>GEV No.</b>	111671	<b>Ref. No.</b>	002104
<b>description</b>	knob thermostat t.max. 300°C temperature range 110-200°C ø 70mm shaft ø 6x4.6mm shaft flat upper rotation 270° black		



1

<b>GEV No.</b>	111676	<b>Ref. No.</b>	004885
<b>description</b>	knob water hot/cold ø 70mm shaft ø 6x4.6mm shaft flat upper black		



1

<b>GEV No.</b>	110466	<b>Ref. No.</b>	002401
<b>description</b>	knob thermostat t.max. 300°C temperature range 160-300°C ø 70mm shaft ø 6x4.6mm shaft flat upper rotation 270° black		



1

<b>GEV No.</b>	110309	<b>Ref. No.</b>	058597
<b>description</b>	knob gas tap with ignition flame ø 70mm shaft ø 10x8mm shaft flat upper black		



1

<b>GEV No.</b>	111627	<b>Ref. No.</b>	004710
<b>description</b>	knob thermostat t.max. 310°C temperature range 150-310°C ø 70mm shaft ø 6x4.6mm shaft flat upper rotation 270° black		



1

<b>GEV No.</b>	111656	<b>Ref. No.</b>	002603
<b>description</b>	knob gas tap with ignition flame ø 70mm shaft ø 10x8mm shaft flat upper black		



1

<b>GEV No.</b>	111619	<b>Ref. No.</b>	004330
<b>description</b>	knob thermostat t.max. 320°C temperature range 140-320°C ø 70mm shaft ø 6x4.6mm shaft flat upper black		



1

<b>GEV No.</b>	110282	<b>Ref. No.</b>	003392
<b>description</b>	knob gas thermostat t.max. 190°C temperature range 110-190°C ø 70mm shaft ø 10x8mm shaft flat upper black		

1

<b>GEV No.</b>	111678	<b>Ref. No.</b>	058708
<b>description</b>	knob water hot ø 70mm shaft ø 10x8mm shaft flat upper black/red H 29mm		



1

<b>GEV No.</b>	110314	<b>Ref. No.</b>	058591
<b>description</b>	knob thermostat t.max. 185°C temperature range 105-185°C ø 70mm shaft ø 6x4.6mm shaft flat upper black		



1

<b>GEV No.</b>	110289	<b>Ref. No.</b>	058534
<b>description</b>	knob gas tap without ignition flame t.max.°C temperature range°C ø 70mm shaft ø 8x6.5mm shaft flat upper black		



1

<b>GEV No.</b>	110342	<b>Ref. No.</b>	058579
<b>description</b>	knob thermostat t.max. 310°C temperature range 110-310°C ø 70mm shaft ø 6x4.6mm shaft flat upper rotation 270° black		



1

<b>GEV No.</b>	110319	<b>Ref. No.</b>	058537
<b>description</b>	knob gas thermostat t.max. 300°C ø 70mm shaft ø 8x6.5mm shaft flat upper black		



1

<b>GEV No.</b>	110279	<b>Ref. No.</b>	058542
<b>description</b>	knob thermostat t.max. 320°C temperature range 140-320°C ø 70mm shaft ø 6x4.6mm shaft flat upper rotation 270° black		



1

<b>GEV No.</b>	110278	<b>Ref. No.</b>	058541
<b>description</b>	knob oven TH/BH/TH+BH t.max.°C temperature range°C ø 70mm shaft ø 6x4.6mm shaft flat upper black		



1

<b>GEV No.</b>	111630	<b>Ref. No.</b>	004821
<b>description</b>	knob gas tap with ignition flame t.max.°C temperature range°C ø 55mm shaft ø 8x6.5mm shaft flat upper black		



1

<b>GEV No.</b>	110317	<b>Ref. No.</b>	058547
<b>description</b>	knob switch 7-position t.max.°C temperature range°C ø 70mm shaft ø 6x4.6mm shaft flat upper black		



1

<b>GEV No.</b>	111623	<b>Ref. No.</b>	004658
<b>description</b>	knob gas thermostat t.max. 280°C ø 55mm shaft ø 10x8mm shaft flat upper black		



1

<b>GEV No.</b>	110349	<b>Ref. No.</b>	059220
<b>description</b>	knob gas thermostat t.max. 330°C ø 55mm shaft ø 8x6.5mm shaft flat upper black		



1

<b>GEV No.</b>	111664	<b>Ref. No.</b>	004783
<b>description</b>	knob thermostat t.max. 185°C temperature range 105-185°C ø 55mm shaft ø 6x4.6mm shaft flat upper black		



1

<b>GEV No.</b>	111645	<b>Ref. No.</b>	004871
<b>description</b>	knob gas thermostat t.max. 90°C ø 55mm shaft ø 8x6.5mm shaft flat upper black		



1

<b>GEV No.</b>	111669	<b>Ref. No.</b>	059468
<b>description</b>	knob thermostat t.max. 300°C temperature range 120-300°C ø 55mm shaft ø 6x4.6mm shaft flat lower rotation 270° black		



1

<b>GEV No.</b>	111670	<b>Ref. No.</b>	059469
<b>description</b>	knob energy regulators 1-7 t.max. °C temperature range °C ø 55mm shaft ø 6x4.6mm shaft flat lower black		



1

<b>GEV No.</b>	110427	<b>Ref. No.</b>	059236
<b>description</b>	knob thermostat t.max. 350°C temperature range 105-185°C ø 55mm shaft ø 6x4.6mm shaft flat lower rotation 270° black		



1

<b>GEV No.</b>	110426	<b>Ref. No.</b>	059850
<b>description</b>	knob graduated/grill ø 55mm shaft ø 6x4.6mm shaft flat lower		



1

<b>GEV No.</b>	112597	<b>Ref. No.</b>	005855
<b>description</b>	knob thermostat t.max. 90°C temperature range 30-90°C ø 55mm shaft ø 6x4.6mm shaft flat right rotation 270°		



1

<b>GEV No.</b>	111651	<b>Ref. No.</b>	004566
<b>description</b>	knob switch 0-1-0-1 ø 55mm shaft ø 6x4.6mm shaft flat upper black		





1

<b>GEV No.</b>	111652	<b>Ref. No.</b>	004565
<b>description</b>	knob thermostat t.max. 90°C temperature range 30-90°C ø 55mm shaft ø 6x4.6mm shaft flat upper black		







 <p>1</p>			
<b>GEV No.</b>	110308	<b>Ref. No.</b>	058776
<b>description</b>	knob gas thermostat t.max. 280°C ø 55mm shaft ø 8x6.5mm shaft flat upper black		

 <p>1</p>			
<b>GEV No.</b>	110281	<b>Ref. No.</b>	059010
<b>description</b>	knob gas thermostat t.max. 330°C ø 55mm shaft ø 8x6.5mm shaft flat upper black		

 <p>1</p>			
<b>GEV No.</b>	110344	<b>Ref. No.</b>	058651
<b>description</b>	knob thermostat t.max. 90°C temperature range 30-90°C ø 55mm shaft ø 6x4.6mm shaft flat upper rotation 270° black		

 <p>1</p>			
<b>GEV No.</b>	110701	<b>Ref. No.</b>	003029
<b>description</b>	knob energyregulator 1-10 + MAX t.max.°C temperature range°C ø 38mm shaft ø 6x4.6mm shaft flat upper black		

 <p>1</p>			
<b>GEV No.</b>	111688	<b>Ref. No.</b>	005210
<b>description</b>	knob 120min		

 <p>1</p>			
<b>GEV No.</b>	111764	<b>Ref. No.</b>	007044
<b>description</b>	knob universal ø 60mm shaft ø 6x4.6mm		

 <p>1</p>			
<b>GEV No.</b>	111444	<b>Ref. No.</b>	048153
<b>description</b>	knob zero mark ø 40mm shaft ø 6x4.6mm shaft flat right anthracite		

accessories

button springs

 <p>1</p>			
<b>GEV No.</b>	550132	<b>Ref. No.</b>	025245
<b>description</b>	knob spring ø 6x4.6mm Qty 10 pcs		

covers

 <p>1</p>			
<b>GEV No.</b>	110288	<b>Ref. No.</b>	054367
<b>description</b>	cover cap knob white		

fascias

 <p>1</p>			
<b>GEV No.</b>	111766	<b>Ref. No.</b>	055454
<b>description</b>	bezel		

 <p>1</p>			
<b>GEV No.</b>	111661	<b>Ref. No.</b>	0C0623
<b>description</b>	bezel gas regulator t.max. 190°C 120-190°C		

			
1			
<b>GEV No.</b>	111613	<b>Ref. No.</b>	0C0194
<b>description</b>	bezel gas regulator t.max. 270°C 110-270°C		

			
1			
<b>GEV No.</b>	111626	<b>Ref. No.</b>	0C0597
<b>description</b>	bezel gas regulator t.max. 270°C 110-270°C		

			
1			
<b>GEV No.</b>	111650	<b>Ref. No.</b>	0C0503
<b>description</b>	bezel gas regulator t.max. 90°C 30-90°C		

			
1			
<b>GEV No.</b>	111632	<b>Ref. No.</b>	0C0192
<b>description</b>	bezel gas tap with ignition flame t.max.°C for front hob		

			
1			
<b>GEV No.</b>	111633	<b>Ref. No.</b>	0C0193
<b>description</b>	bezel gas tap with ignition flame t.max.°C for rear hob		

			
1			
<b>GEV No.</b>	111621	<b>Ref. No.</b>	0C0259
<b>description</b>	bezel oven TH/BH/TH+BH		

			
1			
<b>GEV No.</b>	111654	<b>Ref. No.</b>	0C0518
<b>description</b>	bezel switch 0-1-0-1		

			
1			
<b>GEV No.</b>	111635	<b>Ref. No.</b>	0C0560
<b>description</b>	bezel switch 4-position		

			
1			
<b>GEV No.</b>	111605	<b>Ref. No.</b>	0C0304
<b>description</b>	bezel switch 7-position for front hob		

			
1			
<b>GEV No.</b>	111606	<b>Ref. No.</b>	0C0307
<b>description</b>	bezel switch 7-position for rear hob		

			
1			
<b>GEV No.</b>	111608	<b>Ref. No.</b>	0C0317
<b>description</b>	bezel thermostat 1-8 for front hob		

			
1			
<b>GEV No.</b>	111609	<b>Ref. No.</b>	0C0318
<b>description</b>	bezel thermostat 1-8 for rear hob		

			
1			
<b>GEV No.</b>	111665	<b>Ref. No.</b>	0C0615
<b>description</b>	bezel thermostat t.max. 185°C 105-185°C		

			
1			
<b>GEV No.</b>	111628	<b>Ref. No.</b>	0C0466
<b>description</b>	bezel thermostat t.max. 280°C 120-280°C		

			
1			
<b>GEV No.</b>	111620	<b>Ref. No.</b>	0C0258
<b>description</b>	bezel thermostat t.max. 300°C 100-300°C		

			
1			
<b>GEV No.</b>	111653	<b>Ref. No.</b>	0C0515
<b>description</b>	bezel thermostat t.max. 90°C 30-90°C		





			
1			
<b>GEV No.</b>	111675	<b>Ref. No.</b>	0C0711
<b>description</b>	bezel water hot/cold		

gaskets			
			
1			
<b>GEV No.</b>	110300	<b>Ref. No.</b>	059326
<b>description</b>	gasket		

			
1			
<b>GEV No.</b>	550679	<b>Ref. No.</b>	006465
<b>description</b>	gasket for knob		

			
1			
<b>GEV No.</b>	693432	<b>Ref. No.</b>	002663
<b>description</b>	gasket for knob		

			
1			
<b>GEV No.</b>	111607	<b>Ref. No.</b>	053816
<b>description</b>	gasket knob D1 ø 14mm D2 ø 4mm thickness 3mm equiv. no. 53816 suitable for JUNO, ZANUSSI		

			
1			
<b>GEV No.</b>	111762	<b>Ref. No.</b>	056500
<b>description</b>	gasket knob hole distance 24mm D1 ø 40mm D2 ø 14mm equiv. no. 56500 suitable for ZANUSSI		

			
1			
<b>GEV No.</b>	110202	<b>Ref. No.</b>	0H6984
<b>description</b>	gasket switch shaft		

			
1			
<b>GEV No.</b>	110271	<b>Ref. No.</b>	0H6667
<b>description</b>	gasket switch shaft		

miscellaneous			
			
1			
<b>GEV No.</b>	693429	<b>Ref. No.</b>	002662
<b>description</b>	bush		

			
1			
<b>GEV No.</b>	550697	<b>Ref. No.</b>	0K2358
<b>description</b>	bush for knob		

			
1			
<b>GEV No.</b>	693430	<b>Ref. No.</b>	051263
<b>description</b>	nut thread M22x1.5 H 5mm WS 26 zinc-coated steel Qty 1 pcs		

			
1			
<b>GEV No.</b>	693431	<b>Ref. No.</b>	002727
<b>description</b>	plain washer		

## handles and hand wheels

### hand wheels

hand wheels			
			
1			
<b>GEV No.</b>	693399	<b>Ref. No.</b>	0A5164
<b>description</b>	hand wheel ø 160mm D1 ø 40mm bore ø 16mm hole ø 4mm thread hole distance 4mm groove widthmm L1 22mm L2 50mm handle length 75mm with folding handle		

			
1			
<b>GEV No.</b>	691974	<b>Ref. No.</b>	052392
<b>description</b>	hand wheel ø 175mm D1 ø 40mm bore ø 20mm depth of bore 35mm thread M8 hole distance 8mm L2 155mm without handle		
<b>accessories for</b>	691974		
	<b>GEV No.</b>	<b>Ref. No.</b>	
	690859	052393	
	folding handle ø 28mm total length 110mm seat ø 26mm shaft ømm thread M6 with pin L 110mm		

spare parts and accessories



1			
<b>GEV No.</b>	690859	<b>Ref. No.</b>	052393
<b>description</b>	folding handle ø 28mm total length 110mm seat ø 26mm shaft ømm thread M6 with pin L 110mm		

cylindrical handles

fixed



1			
<b>GEV No.</b>	540713	<b>Ref. No.</b>	058111
<b>description</b>	cylindrical handle thread M8 ø 17mm L 38mm		



1			
<b>GEV No.</b>	111219	<b>Ref. No.</b>	057728
<b>description</b>	cylindrical handle thread M8 ø 28mm L 86mm		



1			
<b>GEV No.</b>	691314	<b>Ref. No.</b>	057728
<b>description</b>	cylindrical handle thread M8 ø 28mm L 86mm		

cone handles



1			
<b>GEV No.</b>	110704	<b>Ref. No.</b>	004906
<b>description</b>	cone handle thread M6 ø 16mm L 25mm plastic black		



1			
<b>GEV No.</b>	514322	<b>Ref. No.</b>	029898
<b>description</b>	cone handle thread M6 ø 20mm L 26mm plastic black		

star handles



1			
<b>GEV No.</b>	111666	<b>Ref. No.</b>	010142
<b>description</b>	star handle shaft 7x7mm ø 68mm L 22mm black thermoplastic		

handle rails

handle rails



1			
<b>GEV No.</b>	518081	<b>Ref. No.</b>	0L0608
<b>description</b>	handle rail set 3-piece L 550mm		

bracket handles



1			
<b>GEV No.</b>	690448	<b>Ref. No.</b>	081906
<b>description</b>	pull handle L 402mm H 42mm mounting distance 375mm		

lever handles



1			
<b>GEV No.</b>	540929	<b>Ref. No.</b>	056887
<b>description</b>	lever handle suitable for outlet tap shaft 8x8mm L 90mm		



recessed handles



1

<b>GEV No.</b>	504780	<b>Ref. No.</b>	047481
<b>description</b>	handle		



1

<b>GEV No.</b>	700449	<b>Ref. No.</b>	066847
<b>description</b>	handle		

hand cranks



1

<b>GEV No.</b>	514250	<b>Ref. No.</b>	002276
<b>description</b>	hand crank bore $\varnothing$ 10mm L 80mm with folding handle		

accessories

extensions



1

<b>GEV No.</b>	540928	<b>Ref. No.</b>	056985
<b>description</b>	extension handle		

miscellaneous



1

<b>GEV No.</b>	690453	<b>Ref. No.</b>	083420
<b>description</b>	handle		

locks

locking devices

producer-specific

ZANUSSI





1

<b>GEV No.</b>	690461	<b>Ref. No.</b>	0A8053
<b>description</b>	key cylinder straight thread M19x1 rotation 90° cam length 54mm cam width 16mm		



1

<b>GEV No.</b>	700443	<b>Ref. No.</b>	025083	
<b>description</b>	handle			
<b>accessories for</b>	700443			
	<b>GEV No.</b>	700452	<b>Ref. No.</b>	054854
	door catch with spigot			



1

<b>GEV No.</b>	690641	<b>Ref. No.</b>	0A8655
<b>description</b>	key cylinder thread M15x1 rotation 90° L 20mm		

			
1			
<b>GEV No.</b>	690637	<b>Ref. No.</b>	081694
<b>description</b>	key cylinder with slide latch ø 23mm thread M19x1 mounting measurements 16.5x19mm hub 38-45mm shaft ø 11mm thread L 24mm		

## handle latches

producer-specific

ELECTROLUX/ZANUSSI

group 2

			
1			
<b>GEV No.</b>	700444	<b>Ref. No.</b>	053756
<b>description</b>	bolt for catch		

			
1			
<b>GEV No.</b>	700460	<b>Ref. No.</b>	0C6059
<b>description</b>	cap		

			
1			
<b>GEV No.</b>	700445	<b>Ref. No.</b>	053757
<b>description</b>	compression spring ø 21.7mm L 29mm wire gauge ø 1.5mm		

			
1			
<b>GEV No.</b>	700447	<b>Ref. No.</b>	053766
<b>description</b>	door catch with spigot		

			
1			
<b>GEV No.</b>	700453	<b>Ref. No.</b>	055057
<b>description</b>	door handle metal		

			
1			
<b>GEV No.</b>	700454	<b>Ref. No.</b>	055059
<b>description</b>	protector L 212mm W 60mm H 70mm		

			
1			
<b>GEV No.</b>	700446	<b>Ref. No.</b>	053761
<b>description</b>	push button		

			
1			
<b>GEV No.</b>	700442	<b>Ref. No.</b>	025033 0G6450
<b>description</b>	thread bolt thread M6 L 32mm thread L 13mm head ø 8mm for rail		

			
1			
<b>GEV No.</b>	700450	<b>Ref. No.</b>	054282
<b>description</b>	torsion spring ø 13mm L2 177mm wire gauge ø 2.5mm L1 10mm L3 177mm Qty 1 pcs		

## group 3

			
1			
<b>GEV No.</b>	700482	<b>Ref. No.</b>	006977
<b>description</b>	catch		

accessories for 700482

	<b>GEV No.</b>	694364	<b>Ref. No.</b>	—
door handle L 185mm W 57mm H 61mm black plastic				

	<b>GEV No.</b>	694376	<b>Ref. No.</b>	—
door catch with hook H 69mm L 67-71mm W 20mm mounting distance 40mm				



	<b>GEV No.</b>	700483	<b>Ref. No.</b>	006981
door catch with spigot				

			
1			
<b>GEV No.</b>	700483	<b>Ref. No.</b>	006981
<b>description</b>	door catch with spigot		



			
1			
<b>GEV No.</b>	700481	<b>Ref. No.</b>	006978
<b>description</b>	door handle black plastic		

			
1			
<b>GEV No.</b>	690873	<b>Ref. No.</b>	006979
<b>description</b>	spring		

group 4			
			
1			
<b>GEV No.</b>	700485	<b>Ref. No.</b>	0C1645
<b>description</b>	catch		
<b>accessories for</b>	700485		
	<b>GEV No.</b>	700481	<b>Ref. No.</b> 006978
	door handle black plastic		
	<b>GEV No.</b>	700486	<b>Ref. No.</b> 007092
	door catch with hook		

			
1			
<b>GEV No.</b>	700486	<b>Ref. No.</b>	007092
<b>description</b>	door catch with hook		

			
1			
<b>GEV No.</b>	700481	<b>Ref. No.</b>	006978
<b>description</b>	door handle black plastic		

edgmount latches

handle latches

producer-specific

INOXTREND

			
1			
<b>GEV No.</b>	690146	<b>Ref. No.</b>	OK1669
<b>description</b>	handle latch L 172mm mounting distance 134mm non lockable heated units 6200 H 65mm type DUPLO total length 248mm		
<b>accessories for</b>	690146		
	<b>GEV No.</b>	690123	<b>Ref. No.</b> —
	door catch with roller		
	<b>GEV No.</b>	693777	<b>Ref. No.</b> 0K2347
	gasket H 6.6mm L 105mm W 45mm L1 78mm W1 25mm for handle		
	<b>GEV No.</b>	693778	<b>Ref. No.</b> 0K1952
	door catch		

MODULAR

			
1			
<b>GEV No.</b>	690146	<b>Ref. No.</b>	OK1669
<b>description</b>	handle latch L 172mm mounting distance 134mm non lockable heated units 6200 H 65mm type DUPLO total length 248mm		
<b>accessories for</b>	690146		
	<b>GEV No.</b>	690123	<b>Ref. No.</b> —
	door catch with roller		
	<b>GEV No.</b>	693777	<b>Ref. No.</b> 0K2347
	gasket H 6.6mm L 105mm W 45mm L1 78mm W1 25mm for handle		
	<b>GEV No.</b>	693778	<b>Ref. No.</b> 0K1952
	door catch		

ZANUSSI

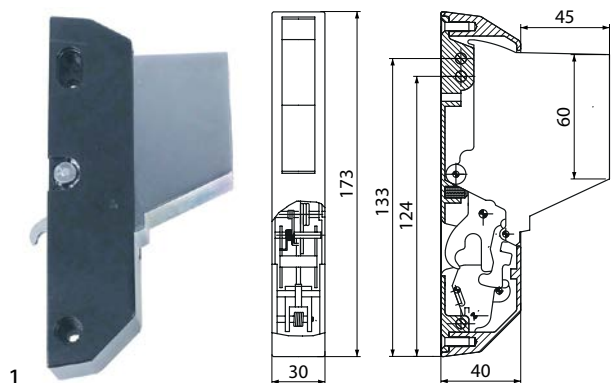

<b>GEV No.</b>	700467	<b>Ref. No.</b>	002647
<b>description</b>	catch L 173mm H 40mm mounting distance 133/124mm W 30mm non lockable 6200 total length 170mm overall height 85mm		

accessories for 700467

	<b>GEV No.</b>	693937	<b>Ref. No.</b>	0F0029
	door handle H 44mm L 220mm W 50mm plastic black			
	<b>GEV No.</b>	700468	<b>Ref. No.</b>	—
	door catch with roller			
	<b>GEV No.</b>	701412	<b>Ref. No.</b>	—
	cover cap plastic round ø 11mm black for catch thickness 8mm			

door catches



<b>GEV No.</b>	693778	<b>Ref. No.</b>	0K1952
<b>description</b>	door catch		



<b>GEV No.</b>	700461	<b>Ref. No.</b>	002086
<b>description</b>	door catch L 22mm thread M5 ø 9mm with spigot total length 45mm thread L 23mm		



<b>GEV No.</b>	700082	<b>Ref. No.</b>	056464
<b>description</b>	door catch L 38mm W 18mm mounting distance 26mm		



<b>GEV No.</b>	700451	<b>Ref. No.</b>	054562
<b>description</b>	door catch with spigot		

snap locks

universal



<b>GEV No.</b>	504662	<b>Ref. No.</b>	049271
<b>description</b>	snap lock L 70mm W 12mm H 16mm mounting distance 58mm without door catch stainless steel		

accessories for 504662

	<b>GEV No.</b>	504663	<b>Ref. No.</b>	049536
	door catch L 35mm W 12mm H 28mm mounting distance 28mm			

espagnolette locks

universal



<b>GEV No.</b>	690837	<b>Ref. No.</b>	056551
<b>description</b>	bolt piece L 75mm W 29mm H 28mm cam length 17.5mm cam width 10mm mounting distance 20/40mm		



<b>GEV No.</b>	690041	<b>Ref. No.</b>	0K2246
<b>description</b>	cam L 148mm mounting distance 32mm		



<b>GEV No.</b>	693797	<b>Ref. No.</b>	004104
<b>description</b>	console upper/lower for cam		



<b>GEV No.</b>	690040	<b>Ref. No.</b>	0KS854
<b>description</b>	door catch with roller H 42mm L 40mm W 40mm zinc die cast mounting distance 26mm type 0751 series		





<b>GEV No.</b>	690838	<b>Ref. No.</b>	056571
<b>description</b>	door catch with roller H 48mm L 50mm W 26mm mounting distance 28mm roller ø 10mm		



1 			
<b>GEV No.</b>	690836	<b>Ref. No.</b>	056550
<b>description</b>	latch gear L 17mm W 26mm H 1.5mm mounting distance 42mm shaft diameter 7x7mm		

miscellaneous

1 			
<b>GEV No.</b>	700440	<b>Ref. No.</b>	003682
<b>description</b>	bolt for catch		



1 			
<b>GEV No.</b>	700452	<b>Ref. No.</b>	054854
<b>description</b>	door catch with spigot		

hinges

edgmount hinges

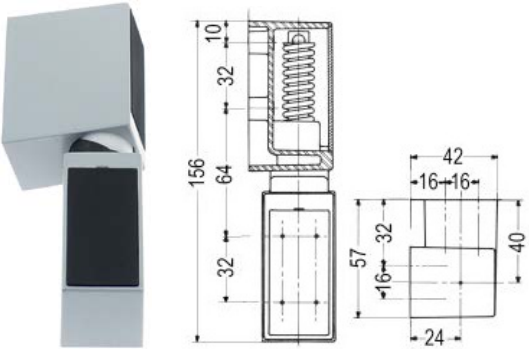
CAFF/FERMOD

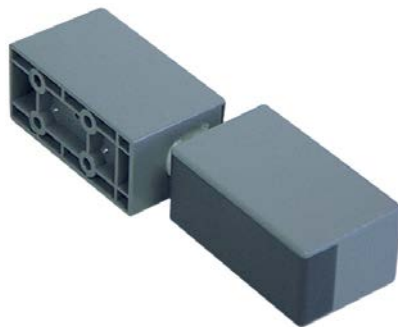
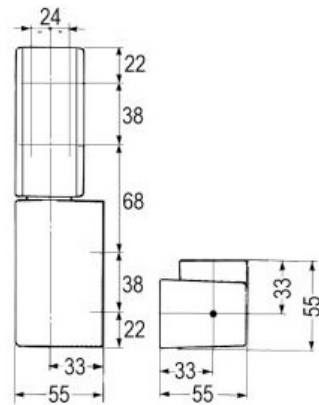
1 			
<b>GEV No.</b>	690642	<b>Ref. No.</b>	0A9531
<b>description</b>	edgmount hinge L 156mm mounting distance 64/32mm hinging right with gradient and spring series G 466		

1 			
			
<b>GEV No.</b>	690805	<b>Ref. No.</b>	084892
<b>description</b>	edgmount hinge L 188mm mounting distance 38mm hinging left/right with gradient and spring series G 920		
<b>accessories for</b>	690805		
	<b>GEV No.</b>	691642	<b>Ref. No.</b> —
	base plate thickness 5mm plastic L 98mm W 49mm		

spring assisted hinges

universal

INTERKLIMAT

hinges



1

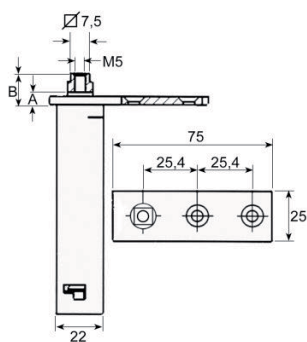

<b>GEV No.</b>	690622	<b>Ref. No.</b>	082219
<b>description</b>	spring assisted hinge series 28L mounting pos. left/right L 75mm W 25mm H 103mm A 13mm B 18mm mounting measurements 22x22mm intake 7.5x7.5 refrigeration units		

accessories

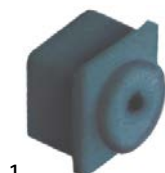

1

<b>GEV No.</b>	690757	<b>Ref. No.</b>	081654
<b>description</b>	bush for door hinge ID ø 7.5mm L 25.5mm W 25.5mm black H 4.5mm		



1

<b>GEV No.</b>	690747	<b>Ref. No.</b>	0A8856
<b>description</b>	bush for hinge ID ø 7.5mm L 25.5mm W 25.5mm white mounting measurements 22x22mm H 4.5mm		

producer-specific

ELECTROLUX/ZANUSSI

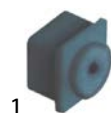

1

<b>GEV No.</b>	690757	<b>Ref. No.</b>	081654
<b>description</b>	bush for door hinge ID ø 7.5mm L 25.5mm W 25.5mm black H 4.5mm		



1

<b>GEV No.</b>	690747	<b>Ref. No.</b>	0A8856
<b>description</b>	bush for hinge ID ø 7.5mm L 25.5mm W 25.5mm white mounting measurements 22x22mm H 4.5mm		



1

<b>GEV No.</b>	690620	<b>Ref. No.</b>	0A8372
<b>description</b>	spring assisted hinge		



1

<b>GEV No.</b>	690621	<b>Ref. No.</b>	0A8371
<b>description</b>	spring assisted hinge left		



1

<b>GEV No.</b>	690633	<b>Ref. No.</b>	082587
<b>description</b>	spring assisted hinge refrigerator		
<b>accessories for</b>	690633		



<b>GEV No.</b>	690634	<b>Ref. No.</b>	082501 087135
<b>description</b>	hinge bearing mounting pos. lower with bolt refrigerator		





<b>GEV No.</b>	690635	<b>Ref. No.</b>	082499
<b>description</b>	hinge bearing mounting pos. upper with bolt refrigerator		

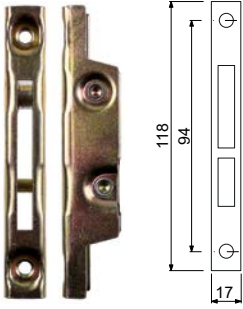

SAGI			
 <p>1</p>			
<b>GEV No.</b>	690747	<b>Ref. No.</b>	0A8856
<b>description</b>	bush for hinge ID $\varnothing$ 7.5mm L 25.5mm W 25.5mm white mounting measurements 22x22mm H 4.5mm		

oven hinges



 <p>1</p>			
<b>GEV No.</b>	691939	<b>Ref. No.</b>	052725
<b>description</b>	cover mounting distance 94mm L 122mm W 20mm oven hinge		

 <p>1</p>			
<b>GEV No.</b>	700001	<b>Ref. No.</b>	053096
<b>description</b>	opposite support L 118mm W 17mm mounting distance 94mm		

 <p>1</p>			
<b>GEV No.</b>	700457	<b>Ref. No.</b>	058934
<b>description</b>	opposite support oven hinge		

 <p>1</p>				
<b>GEV No.</b>	700456	<b>Ref. No.</b>	056339	
<b>description</b>	oven hinge			
<b>accessories for</b>	700456			
	<b>GEV No.</b>	700457	<b>Ref. No.</b>	058934
	opposite support oven hinge			

 <p>1</p>			
<b>GEV No.</b>	701596	<b>Ref. No.</b>	059227
<b>description</b>	oven hinge mounting distance 173mm mounting distance 2 105mm lug mounting 14mm lever length 117mm groove distance 10mm spring thickness 3mm mounting ear position left/right spring length 112mm W 25mm		

 <p>1</p>				
<b>GEV No.</b>	700006	<b>Ref. No.</b>	0A2005	
<b>description</b>	oven hinge mounting distance 173mm mounting distance 2 105mm lug mounting 14mm lever length 120mm groove distance 11mm spring thickness 3.5mm mounting ear position left spring length 112mm W 25mm			
<b>accessories for</b>	700006			
	<b>GEV No.</b>	700001	<b>Ref. No.</b>	053096
	opposite support L 118mm W 17mm mounting distance 94mm			
	<b>GEV No.</b>	700007	<b>Ref. No.</b>	0A2004
	oven hinge mounting distance 173mm mounting distance 2 105mm lug mounting 14mm lever length 120mm groove distance 11mm spring thickness 3.5mm mounting ear position right spring length 112mm W 25mm			

<b>GEV No.</b>	700007	<b>Ref. No.</b>	0A2004
<b>description</b>	oven hinge mounting distance 173mm mounting distance 2 105mm lug mounting 14mm lever length 120mm groove distance 11mm spring thickness 3.5mm mounting ear position right spring length 112mm W 25mm		
<b>accessories for</b>	700007		
	<b>GEV No.</b>	700001	<b>Ref. No.</b> 053096
	opposite support L 118mm W 17mm mounting distance 94mm		

<b>GEV No.</b>	701561	<b>Ref. No.</b>	050766
<b>description</b>	oven hinge mounting distance 173mm mounting distance 2mm lug mounting 14mm lever length 112mm groove distance 10mm spring thickness 3mm mounting ear position left/right spring length 111mm L 205mm W 25mm with opposite support		

<b>GEV No.</b>	701414	<b>Ref. No.</b>	0C3129
<b>description</b>	oven hinge mounting distance 173mm mounting distance 2mm lug mounting 14mm lever length 113mm groove distance 10mm spring thickness 4mm mounting ear position left/right spring length 111mm L 205mm W 25mm with opposite support		

<b>GEV No.</b>	700892	<b>Ref. No.</b>	0C3026
<b>description</b>	oven hinge Qty 2 pcs		

door bearing

<b>GEV No.</b>	700080	<b>Ref. No.</b>	0A8689
<b>description</b>	bolt for hinge		

<b>GEV No.</b>	700464	<b>Ref. No.</b>	055318
<b>description</b>	bolt for hinge		

<b>GEV No.</b>	700466	<b>Ref. No.</b>	059083
<b>description</b>	bolt for hinge		

<b>GEV No.</b>	690645	<b>Ref. No.</b>	0A9096
<b>description</b>	bush for door hinge		

<b>GEV No.</b>	691310	<b>Ref. No.</b>	083875
<b>description</b>	bush L 23mm W 23mm ID ø 7mm for hinge		





			
1			
<b>GEV No.</b>	690696	<b>Ref. No.</b>	084528
<b>description</b>	bush mounting pos. lower for door hinge		

			
1			
<b>GEV No.</b>	690695	<b>Ref. No.</b>	084521
<b>description</b>	bush mounting pos. upper for door hinge		

			
1			
<b>GEV No.</b>	690631	<b>Ref. No.</b>	081807
<b>description</b>	bush refrigerated counter		

			
1			
<b>GEV No.</b>	700083	<b>Ref. No.</b>	0A8072
<b>description</b>	hinge		

			
1			
<b>GEV No.</b>	690660	<b>Ref. No.</b>	082756
<b>description</b>	hinge L 50mm W 42mm H 25mm hole distance 28/25mm lower		

			
1			
<b>GEV No.</b>	693776	<b>Ref. No.</b>	005241
<b>description</b>	hinge mounting pos. bottom right		

			
1			
<b>GEV No.</b>	700029	<b>Ref. No.</b>	0G5222
<b>description</b>	hinge mounting pos. right		

			
1			
<b>GEV No.</b>	693782	<b>Ref. No.</b>	005242
<b>description</b>	hinge mounting pos. upper right		

			
1			
<b>GEV No.</b>	700021	<b>Ref. No.</b>	045480
<b>description</b>	hinge SS left		

			
1			
<b>GEV No.</b>	700020	<b>Ref. No.</b>	045481
<b>description</b>	hinge SS right		

			
1			
<b>GEV No.</b>	700475	<b>Ref. No.</b>	002652
<b>description</b>	hinge bearing L 125mm W 50mm H 18mm mounting pos. bottom right with bolt		

			
1			
<b>GEV No.</b>	690630	<b>Ref. No.</b>	081808
<b>description</b>	hinge bearing mounting pos. bottom left with bolt refrigerated counter		

			
1			
<b>GEV No.</b>	700476	<b>Ref. No.</b>	005694
<b>description</b>	hinge bearing mounting pos. bottom right with bolt		

			
1			
<b>GEV No.</b>	700511	<b>Ref. No.</b>	007091
<b>description</b>	hinge bearing mounting pos. bottom right with bolt		

			
1			
<b>GEV No.</b>	690625	<b>Ref. No.</b>	082374
<b>description</b>	hinge bearing mounting pos. centre with bolt refrigerator		

			
1			
<b>GEV No.</b>	690699	<b>Ref. No.</b>	082754
<b>description</b>	hinge bearing mounting pos. centre without bolt		

			
1			
<b>GEV No.</b>	690624	<b>Ref. No.</b>	081656
<b>description</b>	hinge bearing mounting pos. left without bolt		

			
1			
<b>GEV No.</b>	690656	<b>Ref. No.</b>	082722
<b>description</b>	hinge bearing mounting pos. left without bolt		

			
1			
<b>GEV No.</b>	690694	<b>Ref. No.</b>	084519
<b>description</b>	hinge bearing mounting pos. lower with bolt		

			
1			
<b>GEV No.</b>	690785	<b>Ref. No.</b>	084534
<b>description</b>	hinge bearing mounting pos. lower with bolt		

			
1			
<b>GEV No.</b>	700480	<b>Ref. No.</b>	002875
<b>description</b>	hinge bearing mounting pos. lower with bolt		

			
1			
<b>GEV No.</b>	690634	<b>Ref. No.</b>	082501 087135
<b>description</b>	hinge bearing mounting pos. lower with bolt refrigerator		

			
1			
<b>GEV No.</b>	690665	<b>Ref. No.</b>	0A8973
<b>description</b>	hinge bearing mounting pos. right with bolt		





 <p>1</p>			
<b>GEV No.</b>	690623	<b>Ref. No.</b>	081655
<b>description</b>	hinge bearing mounting pos. right without bolt		

 <p>1</p>			
<b>GEV No.</b>	690655	<b>Ref. No.</b>	082721
<b>description</b>	hinge bearing mounting pos. right without bolt		

 <p>1</p>			
<b>GEV No.</b>	690627	<b>Ref. No.</b>	082256
<b>description</b>	hinge bearing mounting pos. right/left with bolt refrigerator		

 <p>1</p>			
<b>GEV No.</b>	690628	<b>Ref. No.</b>	082350
<b>description</b>	hinge bearing mounting pos. right/left without bolt		

 <p>1</p>			
<b>GEV No.</b>	690649	<b>Ref. No.</b>	0A9174
<b>description</b>	hinge bearing mounting pos. right/left without bolt		

 <p>1</p>			
<b>GEV No.</b>	690673	<b>Ref. No.</b>	0A8688
<b>description</b>	hinge bearing mounting pos. right/left without bolt		

 <p>1</p>			
<b>GEV No.</b>	690679	<b>Ref. No.</b>	0A8974
<b>description</b>	hinge bearing mounting pos. upper left with bolt		

 <p>1</p>			
<b>GEV No.</b>	690698	<b>Ref. No.</b>	084535
<b>description</b>	hinge bearing mounting pos. upper left with bolt		

 <p>1</p>			
<b>GEV No.</b>	700462	<b>Ref. No.</b>	055415
<b>description</b>	hinge bearing mounting pos. upper right with bolt		

 <p>1</p>			
<b>GEV No.</b>	700463	<b>Ref. No.</b>	055316
<b>description</b>	hinge bearing mounting pos. upper right with bolt		

 <p>1</p>			
<b>GEV No.</b>	700473	<b>Ref. No.</b>	002651
<b>description</b>	hinge bearing mounting pos. upper right with bolt		

 <p>1</p>			
<b>GEV No.</b>	690693	<b>Ref. No.</b>	084520
<b>description</b>	hinge bearing mounting pos. upper with bolt		

			
1			
<b>GEV No.</b>	700477	<b>Ref. No.</b>	002876
<b>description</b>	hinge bearing mounting pos. upper with bolt		

			
1			
<b>GEV No.</b>	690668	<b>Ref. No.</b>	0A8470
<b>description</b>	hinge bearing with bolt		

			
1			
<b>GEV No.</b>	690635	<b>Ref. No.</b>	082499
<b>description</b>	hinge bearing mounting pos. upper with bolt refrigerator		

			
1			
<b>GEV No.</b>	690670	<b>Ref. No.</b>	0A8505
<b>description</b>	hinge bearing with bolt		

			
1			
<b>GEV No.</b>	690644	<b>Ref. No.</b>	0A9266
<b>description</b>	hinge bearing with bolt		

			
1			
<b>GEV No.</b>	690866	<b>Ref. No.</b>	006972
<b>description</b>	hinge bearing with bolt		

			
1			
<b>GEV No.</b>	690650	<b>Ref. No.</b>	0A9173
<b>description</b>	hinge bearing with bolt		

			
1			
<b>GEV No.</b>	690867	<b>Ref. No.</b>	006980
<b>description</b>	hinge bearing with bolt		

			
1			
<b>GEV No.</b>	690652	<b>Ref. No.</b>	083751
<b>description</b>	hinge bearing with bolt		

			
1			
<b>GEV No.</b>	690868	<b>Ref. No.</b>	007086
<b>description</b>	hinge bearing with bolt		

			
1			
<b>GEV No.</b>	690664	<b>Ref. No.</b>	0A8455
<b>description</b>	hinge bearing with bolt		

			
1			
<b>GEV No.</b>	700484	<b>Ref. No.</b>	007007
<b>description</b>	hinge bearing with bolt		







			
1			
<b>GEV No.</b>	690638	<b>Ref. No.</b>	082500
<b>description</b>	hinge bearing without bolt		

			
1			
<b>GEV No.</b>	700079	<b>Ref. No.</b>	0A8687
<b>description</b>	hinge bearing without bolt		

			
1			
<b>GEV No.</b>	690639	<b>Ref. No.</b>	082257
<b>description</b>	hinge bearing without bolt		

			
1			
<b>GEV No.</b>	690667	<b>Ref. No.</b>	0A8073
<b>description</b>	hinge pin		

			
1			
<b>GEV No.</b>	690643	<b>Ref. No.</b>	0A9097
<b>description</b>	hinge bearing without bolt		

accessories			
base plate			
			
1			
<b>GEV No.</b>	700479	<b>Ref. No.</b>	002877
<b>description</b>	base plate for door hinge mounting pos. upper left		

			
1			
<b>GEV No.</b>	690651	<b>Ref. No.</b>	083716
<b>description</b>	hinge bearing without bolt		

miscellaneous			
			
1			
<b>GEV No.</b>	690666	<b>Ref. No.</b>	0A8074
<b>description</b>	bush conical ID 6mm ED 8.2mm L 15mm brass		

			
1			
<b>GEV No.</b>	690871	<b>Ref. No.</b>	005041
<b>description</b>	hinge bearing without bolt		

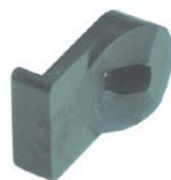
			
1			
<b>GEV No.</b>	690647	<b>Ref. No.</b>	082964
<b>description</b>	bush refrigerator		

			
1			
<b>GEV No.</b>	693288	<b>Ref. No.</b>	002107
<b>description</b>	hinge bearing without bolt		

			
1			
<b>GEV No.</b>	690646	<b>Ref. No.</b>	0A9092
<b>description</b>	bush refrigerator ID 7mm		



1

<b>GEV No.</b>	700474	<b>Ref. No.</b>	002653
<b>description</b>	disc for hinge corrugated		



1

<b>GEV No.</b>	690648	<b>Ref. No.</b>	082962
<b>description</b>	pressure pin refrigerator		



1

<b>GEV No.</b>	700478	<b>Ref. No.</b>	002645
<b>description</b>	protector for glass door for hinge		

## pullouts

### drawer slides

#### producer-specific

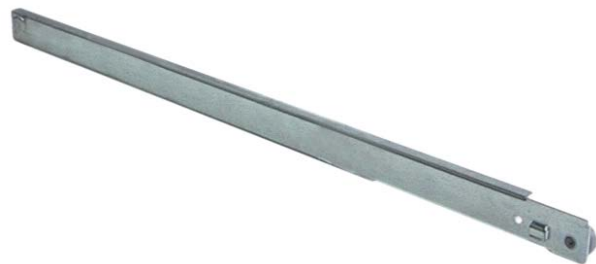

1

<b>GEV No.</b>	690677	<b>Ref. No.</b>	082742
<b>description</b>	drawer rail L 620mm pull-out lengthmm Qty 1 piece W 11mm H 29mm mounting pos. left		



1

<b>GEV No.</b>	690676	<b>Ref. No.</b>	082743
<b>description</b>	drawer rail L 620mm pull-out lengthmm Qty 1 piece W 11mm H 29mm mounting pos. right		

**spare parts for** 690676



<b>GEV No.</b>	690680	<b>Ref. No.</b>	0A8292
<b>description</b>	roller rollerø 24mm B1 6mm overall width 9mm A 24mm B 6mm C 9mm D 6mm E 10mm ceramic bearing ball bearing		



1

<b>GEV No.</b>	690773	<b>Ref. No.</b>	084437
<b>description</b>	drawer slide L 580mm pull-out length 520mm Qty 1 piece W 17mm H 60mm mounting pos. right		



1

<b>GEV No.</b>	690654	<b>Ref. No.</b>	082761
<b>description</b>	drawer slide L 580mm pull-out length 550mm Qty 1 piece W 18mm H 62mm mounting pos. left		



1

<b>GEV No.</b>	690653	<b>Ref. No.</b>	082760
<b>description</b>	drawer slide L 580mm pull-out length 550mm Qty 1 piece W 18mm H 62mm mounting pos. right		

**spare parts for** 690653



<b>GEV No.</b>	690750	<b>Ref. No.</b>	089159 0A8370
----------------	--------	-----------------	------------------

stop for telescopic rail L 20mm plastic H 12mm D 9mm

### accessories



1

<b>GEV No.</b>	690750	<b>Ref. No.</b>	089159 0A8370
<b>description</b>	stop for telescopic rail L 20mm plastic H 12mm D 9mm		

### rollers

#### rollers



1

<b>GEV No.</b>	690680	<b>Ref. No.</b>	0A8292
<b>description</b>	roller rollerø 24mm B1 6mm overall width 9mm A 24mm B 6mm C 9mm D 6mm E 10mm ceramic bearing ball bearing		

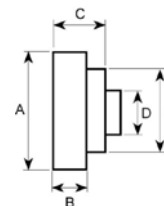



roller with holder			
			
1			
<b>GEV No.</b>	690711	<b>Ref. No.</b>	033886
<b>description</b>	roller rollerø 22mm B1 6mm with holder SS/Nylon mounting pos. right door (left) bearing ball bearing Qty 1 pcs H 11mm L 63mm mounting distance 38/50mm		

## fittings for catering equipment

### outlet taps

#### producer-specific

#### ZANUSSI

			
1			
<b>GEV No.</b>	540986	<b>Ref. No.</b>	006688
<b>description</b>	ball valve without handle L 67mm shaft ø 17x17mm inlet 1" IT outlet 1" ET		
<b>accessories for</b>	540986		
	<b>GEV No.</b>	540678	<b>Ref. No.</b> 006689
	 handle for outlet tap		

			
1			
<b>GEV No.</b>	540678	<b>Ref. No.</b>	006689
<b>description</b>	handle for outlet tap		

### aerators and air bleeders

			
1			
<b>GEV No.</b>	540826	<b>Ref. No.</b>	OKC081
<b>description</b>	aerator and air bleeder thread 1/2" ET WS 24 chrome-plated brass L 30mm		

			
1			
<b>GEV No.</b>	540827	<b>Ref. No.</b>	010023
<b>description</b>	aerator and air bleeder thread 3/4" ET chrome-plated L 45mm ø 36mm		

			
1			
<b>GEV No.</b>	540825	<b>Ref. No.</b>	051566
<b>description</b>	aerator and air bleeder thread 3/8" ET WS 24 chrome-plated L 37mm		

### lid hinges

#### ELECTROLUX

#### spare parts

			
1			
<b>GEV No.</b>	693310	<b>Ref. No.</b>	059865
<b>description</b>	adjusting bush		

			
1			
<b>GEV No.</b>	701215	<b>Ref. No.</b>	002983
<b>description</b>	adjusting bush D1 ø 47mm D2 ø 45mm L 77mm		

			
1			
<b>GEV No.</b>	701216	<b>Ref. No.</b>	002982
<b>description</b>	adjusting bush ø 47mm L 40mm		

			
1			
<b>GEV No.</b>	693301	<b>Ref. No.</b>	052891
<b>description</b>	bracket right		

			
1			
<b>GEV No.</b>	693302	<b>Ref. No.</b>	004849
<b>description</b>	bracket		

			
1			
<b>GEV No.</b>	693306	<b>Ref. No.</b>	002106
<b>description</b>	bracket right		

			
1			
<b>GEV No.</b>	693307	<b>Ref. No.</b>	002944
<b>description</b>	bracket for kettle type series 900		

			
1			
<b>GEV No.</b>	693309	<b>Ref. No.</b>	059863
<b>description</b>	brake		

			
1			
<b>GEV No.</b>	693298	<b>Ref. No.</b>	052892
<b>description</b>	bracket left		

			
1			
<b>GEV No.</b>	693300	<b>Ref. No.</b>	052897
<b>description</b>	bush		



			
1			
<b>GEV No.</b>	693308	<b>Ref. No.</b>	059864
<b>description</b>	bush		

			
1			
<b>GEV No.</b>	693312	<b>Ref. No.</b>	059859
<b>description</b>	countersunk screw thread M6		

			
1			
<b>GEV No.</b>	693311	<b>Ref. No.</b>	059860
<b>description</b>	cylinder head bolt thread M6 thread L 15mm SS Qty 1 pcs intake slotted		

			
1			
<b>GEV No.</b>	693305	<b>Ref. No.</b>	0A2612
<b>description</b>	spanner		

			
1			
<b>GEV No.</b>	693299	<b>Ref. No.</b>	052894
<b>description</b>	torsion spring $\varnothing$ 28.6mm L2 103mm wire gauge $\varnothing$ 3.6mm L1 45mm		

			
1			
<b>GEV No.</b>	693313	<b>Ref. No.</b>	051527
<b>description</b>	torsion spring $\varnothing$ 38.1mm wire gauge $\varnothing$ 6.2mm L1 19mm L2 212mm L3 19mm		

			
1			
<b>GEV No.</b>	693316	<b>Ref. No.</b>	059518
<b>description</b>	torsion spring $\varnothing$ 38.2mm wire gauge $\varnothing$ 6.2mm L1 33mm L2 320mm L3 24mm		

			
1			
<b>GEV No.</b>	693315	<b>Ref. No.</b>	002981
<b>description</b>	torsion spring $\varnothing$ 39mm wire gauge $\varnothing$ 7.1mm L1 31mm L2 322mm L3 23mm		

			
1			
<b>GEV No.</b>	693304	<b>Ref. No.</b>	004850
<b>description</b>	torsion spring wire gauge $\varnothing$ 4mm L1 7mm L2 101mm L3 7mm $\varnothing$ 28.6mm		

## drain taps

brass

### drain taps

			
1			
<b>GEV No.</b>	548001	<b>Ref. No.</b>	0S1037
<b>description</b>	drain tap 1 1/2" IT O-ring seal kettle connection with union nut A 80mm B1 68mm B2 132mm		
<b>spare parts for</b>	548001		
	<b>GEV No.</b>	505092	<b>Ref. No.</b> —
	O-ring EPDM thickness 5.34mm ID $\varnothing$ 43.82mm Qty 1 pcs		
	<b>GEV No.</b>	540213	<b>Ref. No.</b> —
	handle ID $\varnothing$ 5mm L 117mm		



1

<b>GEV No.</b>	540275	<b>Ref. No.</b>	0C4850
<b>description</b>	drain tap 2" IT with union nut A 90mm B 151mm B1 80mm chrome-plated brass		
<b>spare parts for</b>	540275		
	GEV No.	540214	Ref. No. —
	handle ID ø 6mm L 145mm		
<b>accessories for</b>	540275		
	GEV No.	529484	Ref. No. —
	flat gasket fibre ED ø 58mm ID ø 50mm thickness 2mm Qty 1 pcs		
	GEV No.	542448	Ref. No. —
	gasket silicone 60x49x2 for drain tap 2"		





1

<b>GEV No.</b>	541860	<b>Ref. No.</b>	0S0950
<b>description</b>	drain tap 2" IT with union nut conical seal A 95mm B1 75mm B2 155mm		
<b>spare parts for</b>	541860		
	GEV No.	540214	Ref. No. —
	handle ID ø 6mm L 145mm		
	GEV No.	540959	Ref. No. —
	gasket for drain tap hose ext. ø 60mm ID ø 50mm H 2mm		
<b>accessories for</b>	541860		
	GEV No.	529484	Ref. No. —
	flat gasket fibre ED ø 58mm ID ø 50mm thickness 2mm Qty 1 pcs		



1

<b>GEV No.</b>	540296	<b>Ref. No.</b>	017215
<b>description</b>	drain tap ET M60x2mm chrome-plated brass		
<b>spare parts for</b>	540296		
	GEV No.	505092	Ref. No. —
	O-ring EPDM thickness 5.34mm ID ø 43.82mm Qty 1 pcs		
	GEV No.	540213	Ref. No. —
	handle ID ø 5mm L 117mm		



1

<b>GEV No.</b>	540157	<b>Ref. No.</b>	053159
<b>description</b>	drain tap ET M78x3mm chrome-plated brass		
<b>spare parts for</b>	540157		
	GEV No.	540214	Ref. No. —
	handle ID ø 6mm L 145mm		

**accessories**



1

<b>GEV No.</b>	540222	<b>Ref. No.</b>	053809
<b>description</b>	O-ring EPDM thickness 2.62mm ID ø 47.3mm Qty 1 pcs		





safety fittings



safety fittings

			
1			
<b>GEV No.</b>	514304	<b>Ref. No.</b>	059663
<b>description</b>	safety fitting thread 1" 0.5bar 140kg/h thread size manometer 1/2" chrome-plated H 188mm		
<b>spare parts for</b>	514304		
	<b>GEV No.</b>	540322	<b>Ref. No.</b> —
	ball handle thread M8 ø 32mm with metal bush		



accessories

			
1			
<b>GEV No.</b>	540820	<b>Ref. No.</b>	010348
<b>description</b>	fitting support thread 1 1/4" W 165mm		

			
1			
<b>GEV No.</b>	540822	<b>Ref. No.</b>	054808
<b>description</b>	fitting support thread 3/4"		

			
1			
<b>GEV No.</b>	540835	<b>Ref. No.</b>	027297
<b>description</b>	screw cap thread 3/4"		
<b>spare parts for</b>	540835		
	<b>GEV No.</b>	513016	<b>Ref. No.</b> 027300
	O-ring EPDM thickness 3.53mm ID ø 26.58mm Qty 1 pcs		
<b>accessories for</b>	540835		
	<b>GEV No.</b>	513016	<b>Ref. No.</b> 027300
	O-ring EPDM thickness 3.53mm ID ø 26.58mm Qty 1 pcs		

safety valves



			
1			
<b>GEV No.</b>	540721	<b>Ref. No.</b>	056691
<b>description</b>	safety valve triggering pressure 0.5bar M88 thread 1 1/4"		
<b>accessories for</b>	540721		
	<b>GEV No.</b>	541501	<b>Ref. No.</b> —
	reducer for safety fitting IT 1 1/4" ET 3/4"		

			
1			
<b>GEV No.</b>	540722	<b>Ref. No.</b>	052623
<b>description</b>	safety valve with outlet for lid		

filters

accessories

fastening material

			
1			
<b>GEV No.</b>	693914	<b>Ref. No.</b>	054905
<b>description</b>	spring clip for drain filter		
<b>accessories for</b>	693914		
	<b>GEV No.</b>	694000	<b>Ref. No.</b> 004836
	filter		

## equipment feet and end caps

## bullet feet

zamak/SS



1

<b>GEV No.</b>	700112	<b>Ref. No.</b>	032550
<b>description</b>	equipment foot pipe type 40x40 thickness 1mm H 33-60mm Zamak/SS Qty 1 pcs		

## baskets

## fryer baskets

ZANUSSI



1

<b>GEV No.</b>	970142	<b>Ref. No.</b>	058518
<b>description</b>	fryer basket L1 255mm W1 230mm H1 120mm chrome-plated steel		



1

<b>GEV No.</b>	970575	<b>Ref. No.</b>	053206
<b>description</b>	fryer basket L1 260mm W1 135mm H1 120mm chrome-plated steel		



1

<b>GEV No.</b>	970404	<b>Ref. No.</b>	052683
<b>description</b>	fryer basket L1 260mm W1 270mm H1 120mm chrome-plated steel		



1

<b>GEV No.</b>	970407	<b>Ref. No.</b>	004499
<b>description</b>	fryer basket L1 260mm W1 270mm H1 120mm L2 540mm H2 130mm H3 240mm chrome-plated steel		



1

<b>GEV No.</b>	970139	<b>Ref. No.</b>	005704
<b>description</b>	fryer basket L1 265mm W1 210mm H1 105mm L2 480mm H2 147mm H3 205mm chrome-plated steel		



1

<b>GEV No.</b>	970577	<b>Ref. No.</b>	058157
<b>description</b>	fryer basket L1 270mm W1 185mm H1 120mm chrome-plated steel		



1

<b>GEV No.</b>	970141	<b>Ref. No.</b>	026820
<b>description</b>	fryer basket L1 285mm W1 115mm H1 110mm		



1

<b>GEV No.</b>	970140	<b>Ref. No.</b>	054948
<b>description</b>	fryer basket L1 320mm W1 100mm H1 120mm chrome-plated steel		





1

<b>GEV No.</b>	970143	<b>Ref. No.</b>	054960
<b>description</b>	fryer basket L1 320mm W1 225mm H1 120mm L2 550mm H2 140mm H3 250mm		



1

<b>GEV No.</b>	970408	<b>Ref. No.</b>	005933
<b>description</b>	fryer basket L1 325mm W1 225mm H1 120mm chrome-plated steel		



1

<b>GEV No.</b>	970406	<b>Ref. No.</b>	004492
<b>description</b>	fryer basket L1 325mm W1 225mm H1 90mm chrome-plated steel		



1

<b>GEV No.</b>	970412	<b>Ref. No.</b>	006133
<b>description</b>	fryer basket L1 330mm W1 135mm H1 140mm chrome-plated steel		



1

<b>GEV No.</b>	970145	<b>Ref. No.</b>	059327
<b>description</b>	fryer basket L1 330mm W1 160mm H1 120mm chrome-plated steel		



1

<b>GEV No.</b>	970413	<b>Ref. No.</b>	006539
<b>description</b>	fryer basket L1 330mm W1 285mm H1 140mm L2 700mm H2 200mm H3 260mm chrome-plated steel		



1

<b>GEV No.</b>	970144	<b>Ref. No.</b>	052290
<b>description</b>	fryer basket L1 340mm W1 160mm H1 150mm chrome-plated steel		



1

<b>GEV No.</b>	970411	<b>Ref. No.</b>	059307
<b>description</b>	fryer basket L1 340mm W1 335mm H1 120mm chrome-plated steel		

pasta baskets

ZANUSSI



1

<b>GEV No.</b>	970398	<b>Ref. No.</b>	006886
<b>description</b>	pasta basket H1 125mm W1 105mm L1 165mm H3 200mm stainless steel		



1

<b>GEV No.</b>	970396	<b>Ref. No.</b>	056918
<b>description</b>	pasta basket H1 180mm ø 135mm H3 360mm stainless steel		



1

<b>GEV No.</b>	970394	<b>Ref. No.</b>	0C1339
<b>description</b>	pasta basket H1 210mm W1 240mm L1 285mm H3 420mm stainless steel		



1

<b>GEV No.</b>	970397	<b>Ref. No.</b>	056917
<b>description</b>	pasta basket H1 180mm ø 170mm H3 360mm stainless steel		



1

<b>GEV No.</b>	970395	<b>Ref. No.</b>	0C1341
<b>description</b>	pasta basket H1 210mm W1 275mm L1 480mm H3 415mm stainless steel		



1

<b>GEV No.</b>	970393	<b>Ref. No.</b>	056919
<b>description</b>	pasta basket H1 180mm W1 150mm L1 275mm H3 340mm stainless steel		



1

<b>GEV No.</b>	970392	<b>Ref. No.</b>	0C1340
<b>description</b>	pasta basket H1 210mm W1 285mm L1 160mm stainless steel		



1

<b>GEV No.</b>	970809	<b>Ref. No.</b>	0C6290
<b>description</b>	pasta basket H1 200mm W1 290mm L1 145mm size 1/3 H3 345mm stainless steel Qty 2 pcs		



1

<b>GEV No.</b>	970399	<b>Ref. No.</b>	0G2326
<b>description</b>	pasta basket H1 215mm W1 160mm L1 275mm H3 338mm stainless steel		



1

Image not available

<b>GEV No.</b>	970388	<b>Ref. No.</b>	005809
<b>description</b>	pasta basket H1 200mm W1 290mm L1 290mm H3 340mm stainless steel		



1

<b>GEV No.</b>	970401	<b>Ref. No.</b>	004873
<b>description</b>	pasta basket H1 265mm W1 105mm L1 350mm H3 380mm stainless steel		



1

<b>GEV No.</b>	970386	<b>Ref. No.</b>	005807
<b>description</b>	pasta basket right H1 200mm W1 145mm L1 145mm H3 340mm stainless steel		



1

<b>GEV No.</b>	970403	<b>Ref. No.</b>	004875
<b>description</b>	pasta basket H1 265mm W1 220mm L1 170mm H3 455mm stainless steel		



1

<b>GEV No.</b>	970748	<b>Ref. No.</b>	004872
<b>description</b>	pasta basket set 4-piece H1 170mm W1 115mm L1 265mm H3 430mm stainless steel		



1

<b>GEV No.</b>	970402	<b>Ref. No.</b>	004874
<b>description</b>	pasta basket H1 265mm W1 220mm L1 350mm H3 445mm stainless steel		



1

<b>GEV No.</b>	970788	<b>Ref. No.</b>	0C9225
<b>description</b>	pasta basket set 4-piece H1 170mm W1 115mm L1 265mm mounting pos. left/right stainless steel		



1

<b>GEV No.</b>	970385	<b>Ref. No.</b>	005806
<b>description</b>	pasta basket left H1 200mm W1 145mm L1 145mm H3 340mm stainless steel		



1

<b>GEV No.</b>	970572	<b>Ref. No.</b>	056922
<b>description</b>	chargrill grid L 500mm W 290mm H 115mm stainless steel pasta cooker		

crumb screens



1			
<b>GEV No.</b>	970524	<b>Ref. No.</b>	006130
<b>description</b>	crumb screen L 295mm W 385mm suitable for fryer		

warewashing baskets

steel wire baskets round

mix baskets



1			
<b>GEV No.</b>	970494	<b>Ref. No.</b>	045098
<b>description</b>	mix basket ED ø 520mm H 155mm usable height 85mm		

plate baskets



1			
<b>GEV No.</b>	970561	<b>Ref. No.</b>	065565
<b>description</b>	plate basket ED ø 520mm		

steel wire baskets square

mix baskets



1			
<b>GEV No.</b>	970074 <sup>1</sup>	<b>Ref. No.</b>	050058
<b>description</b>	mix basket L 500mm W 500mm H 130mm mesh type close-meshed		

<sup>1</sup>fine-meshed

accessories

plate inserts



1			
<b>GEV No.</b>	970517	<b>Ref. No.</b>	069562
<b>description</b>	plate insert L 320mm W 80mm plates 12		

shelves and shelf rails

grates

universal

without upstand



1			
<b>GEV No.</b>	970125	<b>Ref. No.</b>	082729
<b>description</b>	grate W 325mm D 530mm GN 1/1 plastic-coated steel crossing wires 1 white suitable for refrigerator		
<b>accessories for</b>	970125		
	<b>GEV No.</b>	690330	<b>Ref. No.</b>
			—
	<b>description</b>	rack L 1000mm W 22mm H 4mm aperture 3x8mm hole distance 12.5mm stainless steel	
	<b>GEV No.</b>	694700	<b>Ref. No.</b>
			—
	<b>description</b>	shelf support L 31/28mm W 22mm H 18mm SS Qty 12 pcs	
	<b>GEV No.</b>	694701	<b>Ref. No.</b>
			—
	<b>description</b>	shelf support L 31/28mm W 22mm H 17mm SS with hook Qty 12 pcs	

with upstand

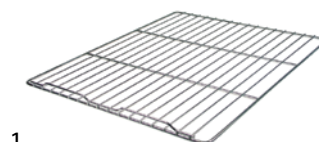



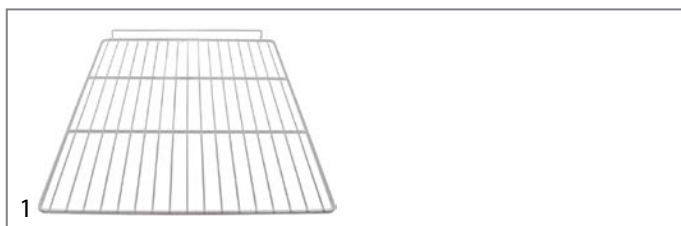

1			
<b>GEV No.</b>	970527	<b>Ref. No.</b>	081883
<b>description</b>	grate W 530mm D 650mm GN 2/1 chrome-plated steel with hinge camp crossing wires 2 suitable for refrigerator		
<b>accessories for</b>	970527		
	<b>GEV No.</b>	690330	<b>Ref. No.</b>
			—
	<b>description</b>	rack L 1000mm W 22mm H 4mm aperture 3x8mm hole distance 12.5mm stainless steel	
	<b>GEV No.</b>	694700	<b>Ref. No.</b>
			—
	<b>description</b>	shelf support L 31/28mm W 22mm H 18mm SS Qty 12 pcs	

Table continues overleaf

<b>accessories for</b>	970527		
	<b>GEV No.</b>	694701	<b>Ref. No.</b> —
shelf support L 31/28mm W 22mm H 17mm SS with hook Qty 12 pcs			





<b>GEV No.</b>	970556	<b>Ref. No.</b>	083635
<b>description</b>	grate W 530mm D 650mm GN 2/1 plastic-coated steel with hinge camp wire gauge frame 9mm lengthwise wires gauge 5mm crossing wires 2 white suitable for refrigerator		

<b>accessories for</b>	970556		
	<b>GEV No.</b>	690330	<b>Ref. No.</b> —
rack L 1000mm W 22mm H 4mm aperture 3x8mm hole distance 12.5mm stainless steel			
	<b>GEV No.</b>	690332	<b>Ref. No.</b> —
shelf support L 31/28mm W 22mm H 17mm SS with hook Qty 1 pcs			
	<b>GEV No.</b>	694700	<b>Ref. No.</b> —
shelf support L 31/28mm W 22mm H 18mm SS Qty 12 pcs			
	<b>GEV No.</b>	694701	<b>Ref. No.</b> —
shelf support L 31/28mm W 22mm H 17mm SS with hook Qty 12 pcs			

<b>producer-specific</b>			
	1		
<b>GEV No.</b>	970019	<b>Ref. No.</b>	006029
<b>description</b>	ventilation grille W 395mm D 75mm steel chrome-plated suitable for refrigerator for bottom heaters		

<b>grates</b>			
	1		
<b>GEV No.</b>	691972	<b>Ref. No.</b>	006580
<b>description</b>	chimney grate L 396mm W 70mm H 25mm cast iron		

<b>grid attachments</b>			
	1		
<b>GEV No.</b>	690806	<b>Ref. No.</b>	082317
<b>description</b>	rack support L 540mm H 26mm W 17.5mm plastic suitable for ELECTROLUX, ZANUSSI		

	1		
<b>GEV No.</b>	690807	<b>Ref. No.</b>	082316
<b>description</b>	rack support L 720mm H 26mm W 27mm plastic		

<b>shelf rails and supports</b>			
<b>producer-specific</b>			
	1		
<b>GEV No.</b>	690739	<b>Ref. No.</b>	0A8164
<b>description</b>	guide L-shape L 445mm W 20mm H 22mm mounting pos. left		

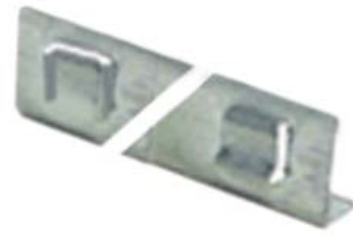
	1		
<b>GEV No.</b>	690784	<b>Ref. No.</b>	0A8163
<b>description</b>	guide L-shape L 445mm W 20mm H 22mm mounting pos. right		



1

<b>GEV No.</b>	690778	<b>Ref. No.</b>	082304 093853
<b>description</b>	guide U-shape L 466mm W 14mm H 20mm mounting pos. left/right		

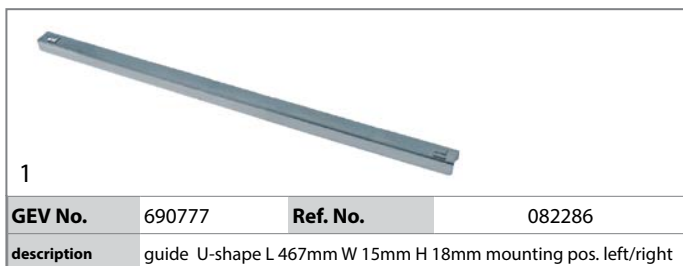

1

<b>GEV No.</b>	690777	<b>Ref. No.</b>	082286
<b>description</b>	guide U-shape L 467mm W 15mm H 18mm mounting pos. left/right		

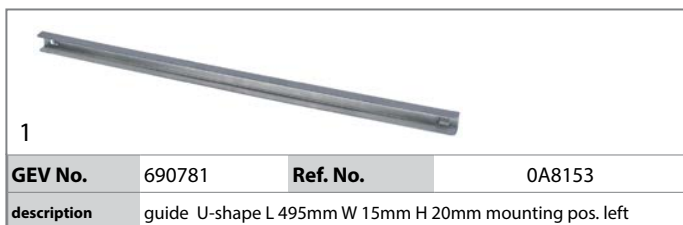

1

<b>GEV No.</b>	690781	<b>Ref. No.</b>	0A8153
<b>description</b>	guide U-shape L 495mm W 15mm H 20mm mounting pos. left		



1

<b>GEV No.</b>	690779	<b>Ref. No.</b>	082719
<b>description</b>	guide U-shape L 565mm W 14mm H 20mm mounting pos. left		

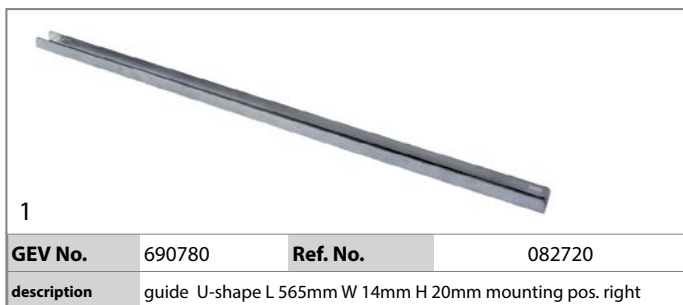

1

<b>GEV No.</b>	690780	<b>Ref. No.</b>	082720
<b>description</b>	guide U-shape L 565mm W 14mm H 20mm mounting pos. right		

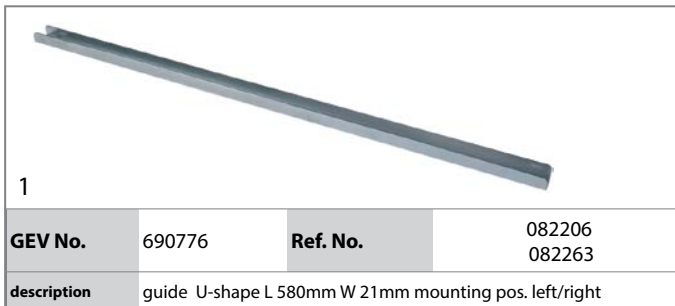

1

<b>GEV No.</b>	690776	<b>Ref. No.</b>	082206 082263
<b>description</b>	guide U-shape L 580mm W 21mm mounting pos. left/right		

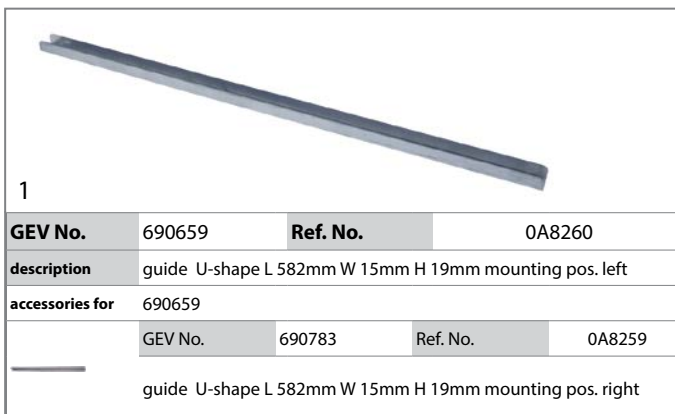

1

<b>GEV No.</b>	690659	<b>Ref. No.</b>	0A8260
<b>description</b>	guide U-shape L 582mm W 15mm H 19mm mounting pos. left		
<b>accessories for</b>	690659		
	<b>GEV No.</b>	690783	<b>Ref. No.</b>
			0A8259
	guide U-shape L 582mm W 15mm H 19mm mounting pos. right		

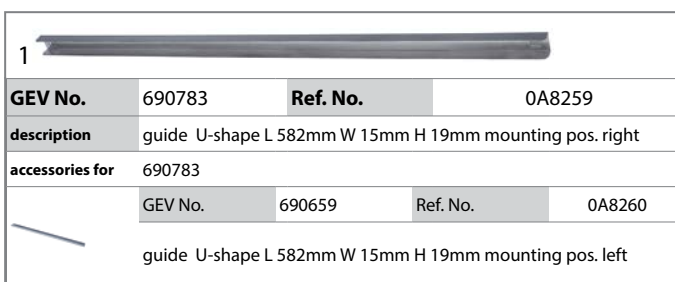

1

<b>GEV No.</b>	690783	<b>Ref. No.</b>	0A8259
<b>description</b>	guide U-shape L 582mm W 15mm H 19mm mounting pos. right		
<b>accessories for</b>	690783		
	<b>GEV No.</b>	690659	<b>Ref. No.</b>
			0A8260
	guide U-shape L 582mm W 15mm H 19mm mounting pos. left		

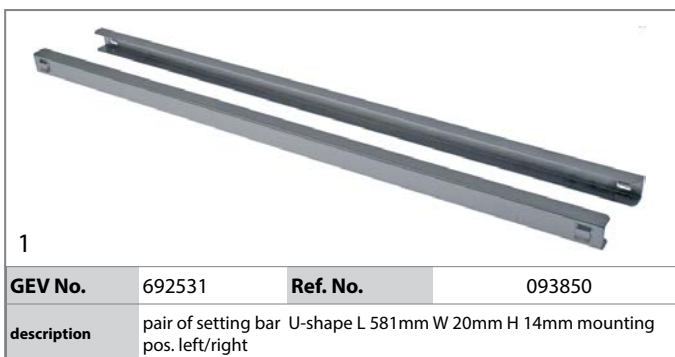

1

<b>GEV No.</b>	692531	<b>Ref. No.</b>	093850
<b>description</b>	pair of setting bar U-shape L 581mm W 20mm H 14mm mounting pos. left/right		

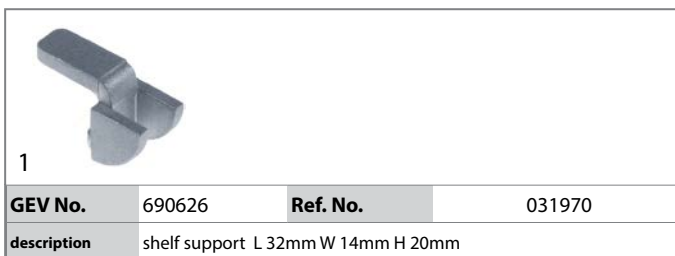

1

<b>GEV No.</b>	690626	<b>Ref. No.</b>	031970
<b>description</b>	shelf support L 32mm W 14mm H 20mm		



**gaskets**

**refrigeration gaskets**

plug-in gaskets

profile 9048

We offer custom-made gaskets for this profile

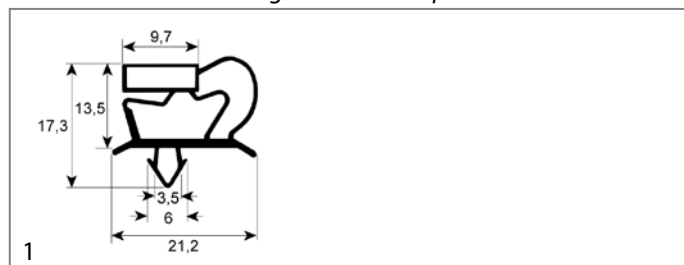

<b>GEV No.</b>	900021	<b>Ref. No.</b>	031694
<b>description</b>	refrigeration gasket profile 9048 W 142mm L 372mm plug size drawer refrigeration size 2/5 suitable for ELECTROLUX, ZANUSSI		

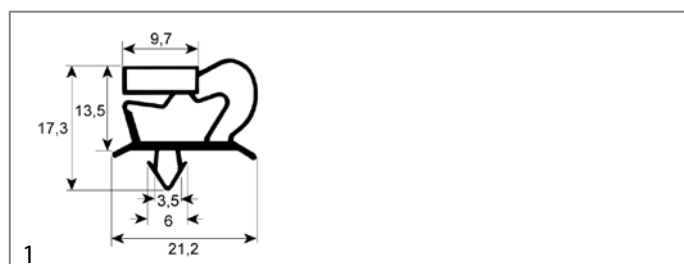

<b>GEV No.</b>	900302	<b>Ref. No.</b>	082740
<b>description</b>	refrigeration gasket profile 9048 W 157mm L 312mm plug size refrigeration		

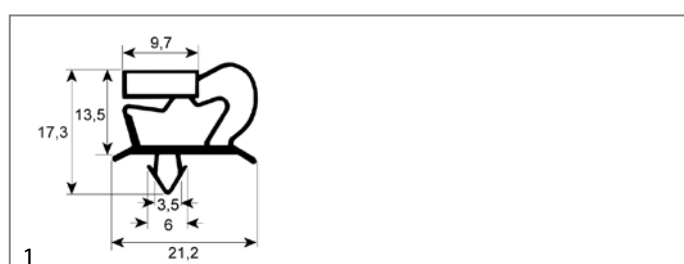

<b>GEV No.</b>	900372	<b>Ref. No.</b>	0A8752
<b>description</b>	refrigeration gasket profile 9048 W 157mm L 372mm plug size drawer size 1/3		

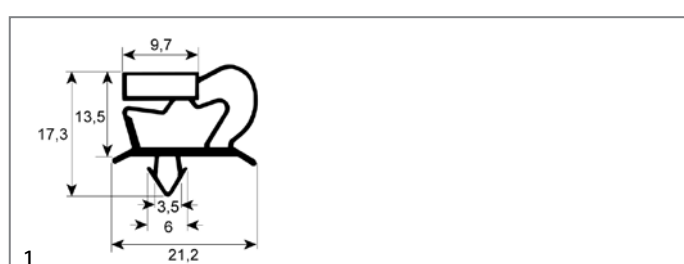

<b>GEV No.</b>	900303	<b>Ref. No.</b>	081772
<b>description</b>	refrigeration gasket profile 9048 W 195mm L 372mm plug size drawer refrigeration size 1/3 suitable for ELECTROLUX, ZANUSSI		

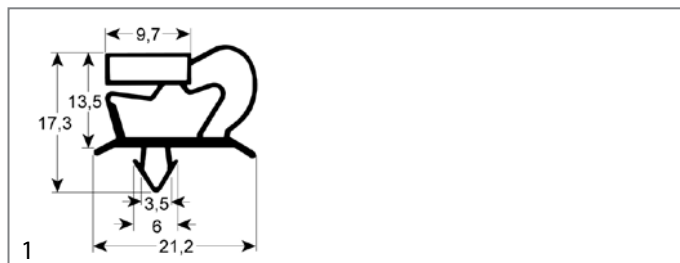

<b>GEV No.</b>	900373	<b>Ref. No.</b>	0A9289
<b>description</b>	refrigeration gasket profile 9048 W 212mm L 417mm plug size drawer		

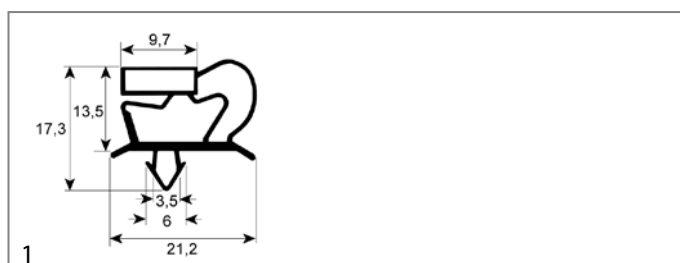

<b>GEV No.</b>	900019	<b>Ref. No.</b>	082759
<b>description</b>	refrigeration gasket profile 9048 W 262mm L 372mm plug size drawer size 1/2		

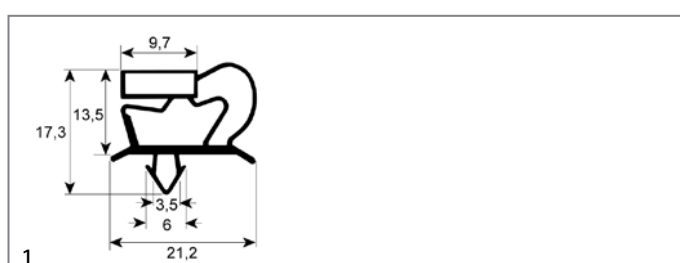

<b>GEV No.</b>	900305	<b>Ref. No.</b>	081815
<b>description</b>	refrigeration gasket profile 9048 W 322mm L 372mm plug size drawer size 1/2		

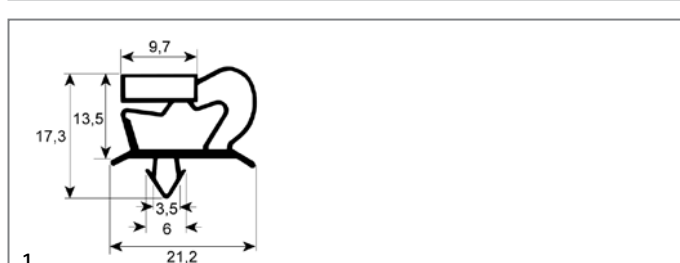

<b>GEV No.</b>	900020	<b>Ref. No.</b>	031693
<b>description</b>	refrigeration gasket profile 9048 W 372mm L 385mm plug size drawer refrigeration size 3/5 suitable for ELECTROLUX, ZANUSSI		



<b>GEV No.</b>	900018	<b>Ref. No.</b>	082725
<b>description</b>	refrigeration gasket profile 9048 W 372mm L 572mm plug size door size 1/1		

<b>GEV No.</b>	900304	<b>Ref. No.</b>	081805
<b>description</b>	refrigeration gasket profile 9048 W 372mm L 587mm plug size door refrigeration size 1/1		

<b>GEV No.</b>	900029	<b>Ref. No.</b>	0A9150
<b>description</b>	refrigeration gasket profile 9048 W 417mm L 502mm plug size door refrigeration		

<b>GEV No.</b>	900986	<b>Ref. No.</b>	0A8992
<b>description</b>	refrigeration gasket profile 9048 W 450mm L 578mm plug size		

<b>GEV No.</b>	900384	<b>Ref. No.</b>	083742
<b>description</b>	refrigeration gasket profile 9048 W 502mm L 1502mm plug size		

<b>GEV No.</b>	900383	<b>Ref. No.</b>	083675
<b>description</b>	refrigeration gasket profile 9048 W 502mm L 717mm plug size		

<b>GEV No.</b>	900380	<b>Ref. No.</b>	0A9195
<b>description</b>	refrigeration gasket profile 9048 W 597mm L 1677mm plug size		

<b>GEV No.</b>	900389	<b>Ref. No.</b>	083664
<b>description</b>	refrigeration gasket profile 9048 W 637mm L 1512mm plug size door refrigeration suitable for ELECTROLUX, ZANUSSI		

<b>GEV No.</b>	900388	<b>Ref. No.</b>	083662
<b>description</b>	refrigeration gasket profile 9048 W 637mm L 717mm plug size 1/2 door refrigeration		

<b>GEV No.</b>	900023	<b>Ref. No.</b>	082375
<b>description</b>	refrigeration gasket profile 9048 W 647mm L 1517mm plug size door refrigeration suitable for ELECTROLUX, ZANUSSI		

<b>GEV No.</b>	900377	<b>Ref. No.</b>	084529
<b>description</b>	refrigeration gasket profile 9048 W 647mm L 1792mm plug size		





<b>GEV No.</b>	900035	<b>Ref. No.</b>	082424
<b>description</b>	refrigeration gasket profile 9048 W 648mm L 725mm plug size 1/2 door refrigeration suitable for ELECTROLUX, ZANUSSI		

<b>GEV No.</b>	900301	<b>Ref. No.</b>	080959
<b>description</b>	refrigeration gasket profile 9048 W 660mm L 1565mm plug size door refrigeration		

<b>GEV No.</b>	900385	<b>Ref. No.</b>	083749
<b>description</b>	refrigeration gasket profile 9048 W 707mm L 797mm plug size 1/2 door refrigeration		

<b>GEV No.</b>	900375	<b>Ref. No.</b>	0A9180
<b>description</b>	refrigeration gasket profile 9048 W 740mm L 1810mm plug size		

<b>GEV No.</b>	900386	<b>Ref. No.</b>	083722
<b>description</b>	refrigeration gasket profile 9048 W 797mm L 1492mm plug size door refrigeration suitable for ELECTROLUX, ZANUSSI		

profile 9773

We offer custom-made gaskets for this profile

<b>GEV No.</b>	901392	<b>Ref. No.</b>	0A9565
<b>description</b>	refrigeration gasket profile 9773 W 395mm L 595mm external size W1 382mm L1 582mm plug size suitable for ELECTROLUX, ZANUSSI		

<b>GEV No.</b>	900985	<b>Ref. No.</b>	087357
<b>description</b>	refrigeration gasket profile 9773 W 598mm L 1690mm external size W1 585mm L1 1677mm plug size suitable for ELECTROLUX, ZANUSSI		

<b>GEV No.</b>	900379	<b>Ref. No.</b>	088076
<b>description</b>	refrigeration gasket profile 9773 W 620mm L 1700mm external size W1 607mm L1 1687mm plug size suitable for ELECTROLUX, ZANUSSI		

<b>GEV No.</b>	900984	<b>Ref. No.</b>	0A8230
<b>description</b>	refrigeration gasket profile 9773 W 664mm L 762mm external size W1 651mm L1 749mm plug size suitable for ELECTROLUX, ZANUSSI		

<b>GEV No.</b>	900983	<b>Ref. No.</b>	0A8225
<b>description</b>	refrigeration gasket profile 9773 W 665mm L 1570mm external size W1 652mm L1 1557mm plug size suitable for ELECTROLUX, ZANUSSI		

<b>GEV No.</b>	900254	<b>Ref. No.</b>	085719
<b>description</b>	refrigeration gasket profile 9773 W 682mm L 1531mm external size W1 669mm L1 1518mm plug size suitable for ELECTROLUX, ZANUSSI		

<b>GEV No.</b>	900381	<b>Ref. No.</b>	0A8647
<b>description</b>	refrigeration gasket profile 9773 W 685mm L 1518mm external size W1 672mm L1 1505mm plug size suitable for ELECTROLUX, ZANUSSI		

**profile 9704**  
We offer custom-made gaskets for this profile

<b>GEV No.</b>	900374	<b>Ref. No.</b>	082586
<b>description</b>	refrigeration gasket profile 9704 W 665mm L 1535mm plug size glass door refrigeration suitable for ELECTROLUX, ZANUSSI		

**profile 9333**

We offer custom-made gaskets for this profile

<b>GEV No.</b>	900387	<b>Ref. No.</b>	083791
<b>description</b>	refrigeration gasket profile 9333 W 520mm L 1515mm plug size glass door refrigeration		

<b>GEV No.</b>	900989	<b>Ref. No.</b>	0A8365
<b>description</b>	refrigeration gasket profile 9333 W 670mm L 1460mm plug size		

<b>GEV No.</b>	900382	<b>Ref. No.</b>	0A8648
<b>description</b>	refrigeration gasket profile 9333 W 685mm L 1515mm plug size glass door refrigeration		

**profile 9237**

We offer custom-made gaskets for this profile

<b>GEV No.</b>	900012	<b>Ref. No.</b>	081943
<b>description</b>	refrigeration gasket profile 9237 W 645mm L 1535mm plug size door refrigeration		

<b>GEV No.</b>	901343	<b>Ref. No.</b>	0A9559
<b>description</b>	refrigeration gasket profile 9237 W 661mm L 1512mm plug size		

<b>GEV No.</b>	900013	<b>Ref. No.</b>	081725
<b>description</b>	refrigeration gasket profile 9237 W 690mm L 710mm plug size 1/2 door refrigeration		

<b>GEV No.</b>	900015	<b>Ref. No.</b>	081724
<b>description</b>	refrigeration gasket profile 9237 W 710mm L 1500mm plug size door refrigeration		

profile 9794

We offer custom-made gaskets for this profile

<b>GEV No.</b>	900987	<b>Ref. No.</b>	087691
<b>description</b>	refrigeration gasket profile 9794 W 254mm L 387mm plug size		

<b>GEV No.</b>	900890	<b>Ref. No.</b>	087664
<b>description</b>	refrigeration gasket profile 9794 W 390mm L 555mm plug size		

<b>GEV No.</b>	901369	<b>Ref. No.</b>	099531
<b>description</b>	refrigeration gasket profile 9794 W 390mm L 560mm plug size		

<b>GEV No.</b>	901153	<b>Ref. No.</b>	089735
<b>description</b>	refrigeration gasket profile 9794 W 622mm L 1495mm plug size		

<b>GEV No.</b>	900981	<b>Ref. No.</b>	087129
<b>description</b>	refrigeration gasket profile 9794 W 626mm L 1467mm plug size		

<b>GEV No.</b>	900988	<b>Ref. No.</b>	0A9741
<b>description</b>	refrigeration gasket profile 9794 W 691mm L 626mm plug size		

profile 9794Z (blast freezer)

<b>GEV No.</b>	901237 <sup>1</sup>	<b>Ref. No.</b>	083377
<b>description</b>	blast freezer gasket profile 9794Z W 406mm L 666mm plug size for blast chiller suitable for ELECTROLUX, ZANUSSI		

<sup>1</sup>for blast freezer

<b>GEV No.</b>	901236 <sup>1</sup>	<b>Ref. No.</b>	083397
<b>description</b>	blast freezer gasket profile 9794Z W 666mm L 736mm plug size suitable for ELECTROLUX, ZANUSSI		

<sup>1</sup>for blast freezer

**screw-in gaskets**  
**profile 9030**

We offer custom-made gaskets for this profile

<b>GEV No.</b>	900001	<b>Ref. No.</b>	0A8083
<b>description</b>	refrigeration gasket profile 9030 W 185mm L 390mm external size		

<b>GEV No.</b>	900034	<b>Ref. No.</b>	0A8379
<b>description</b>	refrigeration gasket profile 9030 W 200mm L 392mm external size refrigeration		

<b>GEV No.</b>	900002	<b>Ref. No.</b>	0A8079
<b>description</b>	refrigeration gasket profile 9030 W 310mm L 390mm external size drawer for refrigerated counter refrigeration size 1/2		

<b>GEV No.</b>	900309	<b>Ref. No.</b>	0K9330
<b>description</b>	refrigeration gasket profile 9030 W 330mm L 380mm external size drawer for refrigerated counter refrigeration size 1/2		

<b>GEV No.</b>	900308	<b>Ref. No.</b>	0K9331
<b>description</b>	refrigeration gasket profile 9030 W 380mm L 585mm external size drawer for refrigerated counter refrigeration size 1/1		

<b>GEV No.</b>	900003	<b>Ref. No.</b>	0A8081
<b>description</b>	refrigeration gasket profile 9030 W 390mm L 435mm external size drawer for refrigerated counter refrigeration size 3/5		

<b>GEV No.</b>	900004	<b>Ref. No.</b>	0A8075
<b>description</b>	refrigeration gasket profile 9030 W 391mm L 640mm external size door for refrigerated counter refrigeration size 1/1		

<b>GEV No.</b>	900007	<b>Ref. No.</b>	0A8144
<b>description</b>	refrigeration gasket profile 9030 W 446mm L 540mm external size refrigeration size 1/1		



<b>GEV No.</b>	900014	<b>Ref. No.</b>	0A8159
<b>description</b>	refrigeration gasket profile 9030 W 540mm L 670mm external size refrigeration size 1/1		

<b>GEV No.</b>	900191	<b>Ref. No.</b>	055314
<b>description</b>	window gasket profile 1820 perimeter 2200mm Qty 1		

<b>GEV No.</b>	900006	<b>Ref. No.</b>	081293
<b>description</b>	refrigeration gasket profile 9030 W 670mm L 1570mm external size door refrigeration suitable for ELECTROLUX, ZANUSSI		

<b>GEV No.</b>	900743	<b>Ref. No.</b>	unbekannt
<b>description</b>	window gasket profile 1820 Qty supplied by meter		

<b>GEV No.</b>	900005	<b>Ref. No.</b>	081294
<b>description</b>	refrigeration gasket profile 9030 W 675mm L 770mm external size 1/2 door refrigeration suitable for ELECTROLUX, ZANUSSI		

<b>GEV No.</b>	900272	<b>Ref. No.</b>	003680
<b>description</b>	window gasket profile 1830 L 1500mm Qty 1		

**gaskets for heated units**

**window seals**

<b>GEV No.</b>	900270	<b>Ref. No.</b>	057866
<b>description</b>	window gasket profile 1510 Qty 5m		

<b>GEV No.</b>	900154	<b>Ref. No.</b>	0K2079
<b>description</b>	window gasket profile 1840 perimeter 1700mm Qty 1		

<b>GEV No.</b>	900190	<b>Ref. No.</b>	055412
<b>description</b>	window gasket profile 1820 perimeter 1400mm Qty 1		

<b>GEV No.</b>	900269	<b>Ref. No.</b>	003739
<b>description</b>	window gasket profile 1874 perimeter 2060mm Qty 1		

<b>GEV No.</b>	900185	<b>Ref. No.</b>	002837
<b>description</b>	window gasket profile 1875 perimeter 1500mm Qty 1		

<b>GEV No.</b>	900186	<b>Ref. No.</b>	002878
<b>description</b>	window gasket profile 1875 perimeter 2000mm Qty 1		

**door seals**

<b>GEV No.</b>	900189	<b>Ref. No.</b>	053751
<b>description</b>	door seal profile 2260 W 645mm L 715mm external size Qty 1 10 x 2/1		

<b>GEV No.</b>	900040	<b>Ref. No.</b>	0H6657
<b>description</b>	door seal profile 2447 W 627mm L 1321mm external size Qty 1		

<b>GEV No.</b>	900039	<b>Ref. No.</b>	0H6660
<b>description</b>	door seal profile 2447 W 777mm L 1321mm external size Qty 1		

<b>GEV No.</b>	900187	<b>Ref. No.</b>	055414
<b>description</b>	door seal profile 2450 W 395mm H 585mm external size Qty 1 suitable for ELECTROLUX 395x585		

<b>GEV No.</b>	900188	<b>Ref. No.</b>	055315
<b>description</b>	door seal profile 2450 W 640mm H 720mm external size Qty 1 suitable for ELECTROLUX 640x720		

<b>GEV No.</b>	900275	<b>Ref. No.</b>	054986
<b>description</b>	door seal profile 2450 W 645mm H 1380mm external size Qty 1 suitable for ELECTROLUX 640x1380		

<b>GEV No.</b>	900433	<b>Ref. No.</b>	005713
<b>description</b>	door seal profile 2520 W 430mm L 635mm external size Qty 1 suitable for ELECTROLUX, JUNO, ZANUSSI 635x430		

<b>GEV No.</b>	900579	<b>Ref. No.</b>	005708
<b>description</b>	door seal profile 2520 W 450mm L 1490mm external size Qty 1 suitable for ELECTROLUX 450x1490		



<b>GEV No.</b>	900577	<b>Ref. No.</b>	005710
<b>description</b>	door seal profile 2520 W 450mm L 550mm external size Qty 1 suitable for ELECTROLUX 450x550		

<b>GEV No.</b>	900160	<b>Ref. No.</b>	005712
<b>description</b>	door seal profile 2520 W 655mm L 725mm external size Qty 1 suitable for ELECTROLUX		

<b>GEV No.</b>	900578	<b>Ref. No.</b>	005709
<b>description</b>	door seal profile 2520 W 450mm L 770mm external size Qty 1 suitable for ELECTROLUX 450x770		

<b>GEV No.</b>	900276	<b>Ref. No.</b>	0C1473
<b>description</b>	door seal profile 2760 W 480mm L 1460mm outer plug size Qty 1 suitable for ELECTROLUX 1438x450		

<b>GEV No.</b>	900161	<b>Ref. No.</b>	005705
<b>description</b>	door seal profile 2520 W 640mm L 1400mm external size Qty 1 suitable for ELECTROLUX 640x1400		

<b>GEV No.</b>	900278	<b>Ref. No.</b>	006992
<b>description</b>	door seal profile 2760 W 480mm L 505mm outer plug size Qty 1 suitable for ELECTROLUX 475x450		

<b>GEV No.</b>	900590	<b>Ref. No.</b>	005706
<b>description</b>	door seal profile 2520 W 640mm L 730mm external size Qty 1 suitable for ELECTROLUX 640x730		

<b>GEV No.</b>	900268	<b>Ref. No.</b>	007069
<b>description</b>	door seal profile 2760 W 480mm L 755mm outer plug size Qty 1 suitable for ELECTROLUX 450x725		

<b>GEV No.</b>	900434	<b>Ref. No.</b>	005711
<b>description</b>	door seal profile 2520 W 655mm L 1400mm external size Qty 1 suitable for ELECTROLUX 660x1400		

<b>GEV No.</b>	900267	<b>Ref. No.</b>	0C1195
<b>description</b>	door seal profile 2760 W 660mm L 1460mm outer plug size Qty 1 suitable for ELECTROLUX 1438x630		

<b>GEV No.</b>	901146	<b>Ref. No.</b>	0C1887
<b>description</b>	door seal profile 2760 W 665mm L 760mm outer plug size Qty 1 suitable for ELECTROLUX 725x630		

<b>GEV No.</b>	900047	<b>Ref. No.</b>	0H6768
<b>description</b>	door seal profile 2924 W 50mm L 570mm external size Qty 1 mounting pos. upper		

<b>GEV No.</b>	900146 <sup>1</sup>	<b>Ref. No.</b>	0H6516
<b>description</b>	door seal profile 2940 W 600mm L 670mm external size Qty 1		

<sup>1</sup>3-sided (long side open)

<b>GEV No.</b>	900306	<b>Ref. No.</b>	057656
<b>description</b>	door seal profile 2947 Qty supplied by meter		

<b>GEV No.</b>	900624	<b>Ref. No.</b>	054112
<b>description</b>	door seal profile 2953 Qty supplied by meter		

<b>GEV No.</b>	900273	<b>Ref. No.</b>	054850
<b>description</b>	door seal profile 2970 L 1133mm Qty 1		

door gaskets (wire reinforced)

<b>GEV No.</b>	900279	<b>Ref. No.</b>	005194
<b>description</b>	oven gasket wire reinforced L 395mm W 285mm		

door seals with tension springs

<b>GEV No.</b>	900046	<b>Ref. No.</b>	0H6762
<b>description</b>	oven gasket profile 2958 L 290mm Qty 1 mounting pos. lateral		

gaskets for tray rack trolleys

<b>GEV No.</b>	900592	<b>Ref. No.</b>	0H6662
<b>description</b>	tray rack trolley gasket profile 4040 L 658mm Qty 1		





<b>GEV No.</b>	900580	<b>Ref. No.</b>	006176
<b>description</b>	tray rack trolley gasket profile 4055 L 660mm Qty 1		

<b>GEV No.</b>	900295	<b>Ref. No.</b>	0C0899
<b>description</b>	tray rack trolley gasket profile 4100 L 610mm Qty 1		

<b>GEV No.</b>	900274	<b>Ref. No.</b>	0C1196
<b>description</b>	tray rack trolley gasket profile 4100 L 745mm Qty 1		

O-rings

EPDM

<b>GEV No.</b>	510302	<b>Ref. No.</b>	047986
<b>description</b>	O-ring EPDM ID ø 12.42mm thickness 1.78mm Qty 1 pcs		

<b>GEV No.</b>	504512	<b>Ref. No.</b>	047473
<b>description</b>	O-ring EPDM thickness 1.78mm ID ø 14mm Qty 1 pcs		

<b>GEV No.</b>	532003	<b>Ref. No.</b>	059293
<b>description</b>	O-ring EPDM thickness 1.78mm ID ø 3.69mm Qty 10 pcs		

<b>GEV No.</b>	528485	<b>Ref. No.</b>	067898
<b>description</b>	O-ring EPDM thickness 1.78mm ID ø 6.07mm Qty 1 pcs		

<b>GEV No.</b>	530293	<b>Ref. No.</b>	0L0555
<b>description</b>	O-ring EPDM thickness 1.78mm ID ø 8.73mm Qty 1 pcs		

<b>GEV No.</b>	504574	<b>Ref. No.</b>	046376
<b>description</b>	O-ring EPDM thickness 1.78mm ID ø 9.25mm Qty 1 pcs		

<b>GEV No.</b>	532581	<b>Ref. No.</b>	0E5118
<b>description</b>	O-ring EPDM thickness 2.3mm ID ø 17.2mm Qty 1 pcs		

<b>GEV No.</b>	529412	<b>Ref. No.</b>	069644
<b>description</b>	O-ring EPDM thickness 2.62mm ID ø 10.78mm Qty 1 pcs		

<b>GEV No.</b>	528223	<b>Ref. No.</b>	067292
<b>description</b>	O-ring EPDM thickness 2.62mm ID ø 11.91mm Qty 1 pcs		

<b>GEV No.</b>	507313	<b>Ref. No.</b>	046223
<b>description</b>	O-ring EPDM thickness 2.62mm ID ø 13.95mm Qty 1 pcs		

<b>GEV No.</b>	532546	<b>Ref. No.</b>	052206
<b>description</b>	O-ring EPDM thickness 2.62mm ID ø 52.07mm Qty 1 pcs		

<b>GEV No.</b>	504618	<b>Ref. No.</b>	068642
<b>description</b>	O-ring EPDM thickness 2.62mm ID ø 15.54mm Qty 1 pcs		

<b>GEV No.</b>	512175	<b>Ref. No.</b>	049460
<b>description</b>	O-ring EPDM thickness 2.62mm ID ø 53.65mm Qty 1 pcs		

<b>GEV No.</b>	504590	<b>Ref. No.</b>	047929
<b>description</b>	O-ring EPDM thickness 2.62mm ID ø 18.72mm Qty 1 pcs		

<b>GEV No.</b>	504577	<b>Ref. No.</b>	047462
<b>description</b>	O-ring EPDM thickness 2.62mm ID ø 60mm Qty 1 pcs		

<b>GEV No.</b>	528919	<b>Ref. No.</b>	069527
<b>description</b>	O-ring EPDM thickness 2.62mm ID ø 20.24mm Qty 1 pcs		

<b>GEV No.</b>	510009	<b>Ref. No.</b>	069531 OKM724
<b>description</b>	O-ring EPDM thickness 3.53mm ID ø 101.2mm Qty 1 pcs		

<b>GEV No.</b>	510769	<b>Ref. No.</b>	046799
<b>description</b>	O-ring EPDM thickness 2.62mm ID ø 25.07mm Qty 1 pcs		

<b>GEV No.</b>	511339	<b>Ref. No.</b>	048327
<b>description</b>	O-ring EPDM thickness 3.53mm ID ø 110.7mm Qty 1 pcs		

<b>GEV No.</b>	504561	<b>Ref. No.</b>	067768
<b>description</b>	O-ring EPDM thickness 2.62mm ID ø 29.82mm Qty 1 pcs		

<b>GEV No.</b>	504593	<b>Ref. No.</b>	049033
<b>description</b>	O-ring EPDM thickness 3.53mm ID ø 123.4mm Qty 1 pcs		

<b>GEV No.</b>	540222	<b>Ref. No.</b>	053809
<b>description</b>	O-ring EPDM thickness 2.62mm ID ø 47.3mm Qty 1 pcs		



<b>GEV No.</b>	511517	<b>Ref. No.</b>	059475
<b>description</b>	O-ring EPDM thickness 3.53mm ID $\varnothing$ 21.82mm Qty 10 pcs		

<b>GEV No.</b>	532612	<b>Ref. No.</b>	068799
<b>description</b>	O-ring EPDM thickness 3.53mm ID $\varnothing$ 60.33mm Qty 1 pcs		

<b>GEV No.</b>	517087	<b>Ref. No.</b>	050292
<b>description</b>	O-ring EPDM thickness 3.53mm ID $\varnothing$ 23.4mm Qty 1 pcs		

<b>GEV No.</b>	504580	<b>Ref. No.</b>	046366
<b>description</b>	O-ring EPDM thickness 3.53mm ID $\varnothing$ 73.03mm Qty 1 pcs		

<b>GEV No.</b>	513016	<b>Ref. No.</b>	027300
<b>description</b>	O-ring EPDM thickness 3.53mm ID $\varnothing$ 26.58mm Qty 1 pcs		

<b>GEV No.</b>	504578	<b>Ref. No.</b>	045462 047458
<b>description</b>	O-ring EPDM thickness 3.53mm ID $\varnothing$ 94.84mm Qty 1 pcs		

<b>GEV No.</b>	510072	<b>Ref. No.</b>	049245
<b>description</b>	O-ring EPDM thickness 3.53mm ID $\varnothing$ 32.93mm Qty 1 pcs		

<b>GEV No.</b>	521709	<b>Ref. No.</b>	048984
<b>description</b>	O-ring EPDM thickness 3mm ID $\varnothing$ 126mm Qty 1 pcs		

<b>GEV No.</b>	510895	<b>Ref. No.</b>	027301
<b>description</b>	O-ring EPDM thickness 3.53mm ID $\varnothing$ 34.52mm Qty 1 pcs		

<b>GEV No.</b>	510563	<b>Ref. No.</b>	0E5062
<b>description</b>	O-ring EPDM thickness 3mm ID $\varnothing$ 28mm Qty 1 pcs		

<b>GEV No.</b>	508061	<b>Ref. No.</b>	065506
<b>description</b>	O-ring EPDM thickness 3.53mm ID $\varnothing$ 42.86mm Qty 1 pcs		

<b>GEV No.</b>	501008	<b>Ref. No.</b>	046865
<b>description</b>	O-ring EPDM thickness 3mm ID $\varnothing$ 64mm Qty 1 pcs		

<b>GEV No.</b>	508370	<b>Ref. No.</b>	048229
<b>description</b>	O-ring EPDM thickness 3.53mm ID $\varnothing$ 46.04mm Qty 1 pcs		

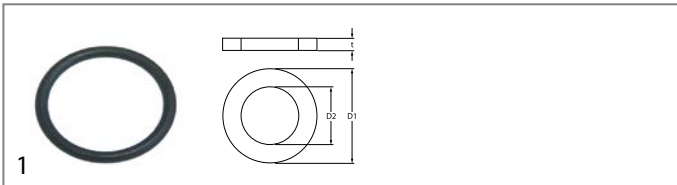

1

<b>GEV No.</b>	510408	<b>Ref. No.</b>	067620
<b>description</b>	O-ring EPDM thickness 5.34mm ID ø 47mm Qty 1 pcs		

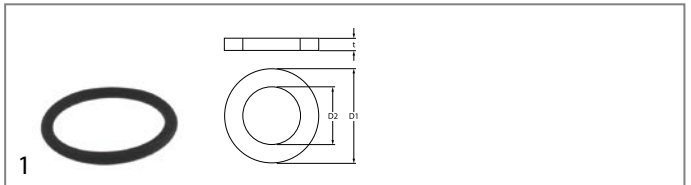

1

<b>GEV No.</b>	532506	<b>Ref. No.</b>	007074
<b>description</b>	O-ring Viton thickness 3.53mm ID ø 29.75mm Qty 1 pcs		

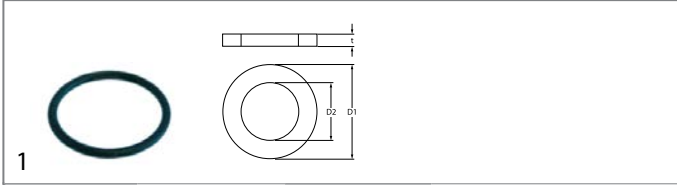

1

<b>GEV No.</b>	510409	<b>Ref. No.</b>	007029
<b>description</b>	O-ring EPDM thickness 5.34mm ID ø 56.52mm Qty 1 pcs		

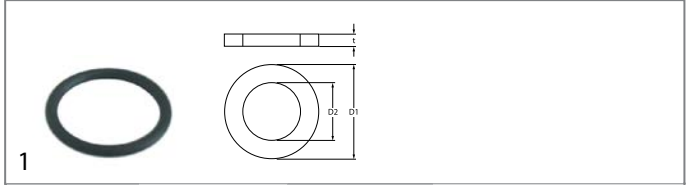

1

<b>GEV No.</b>	528412	<b>Ref. No.</b>	002874
<b>description</b>	O-ring Viton thickness 3.53mm ID ø 31.34mm Qty 1 pcs		

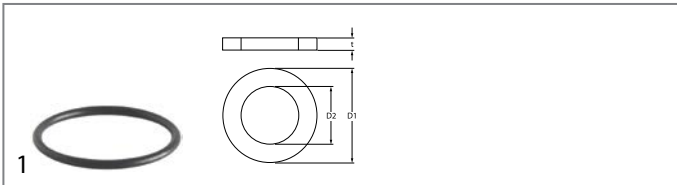

1

<b>GEV No.</b>	532613	<b>Ref. No.</b>	049593
<b>description</b>	O-ring EPDM thickness 5.34mm ID ø 72.39mm Qty 1 pcs		

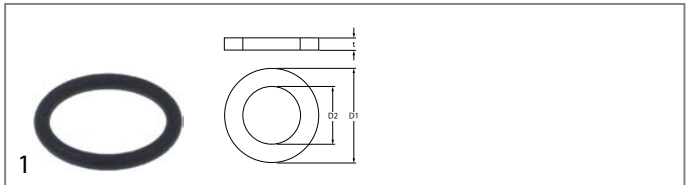

1

<b>GEV No.</b>	550530	<b>Ref. No.</b>	055323
<b>description</b>	O-ring Viton thickness 5.34mm ID ø 37.8mm Qty 1 pcs		

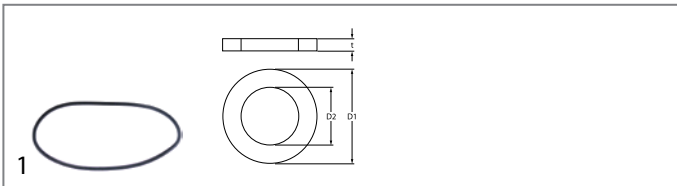

1

<b>GEV No.</b>	510551	<b>Ref. No.</b>	0L0338
<b>description</b>	pump cover gasket ID ø 158.3mm pump type 1214/1293/1225/2243/1226/1204/3473/1241 thickness 3.53mm EPDM Qty 1 pcs		

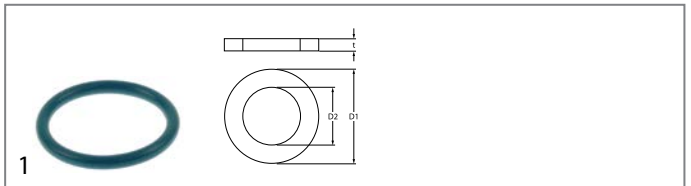

1

<b>GEV No.</b>	103007	<b>Ref. No.</b>	0H6863
<b>description</b>	O-ring Viton thickness 5mm ID ø 42.5mm Qty 1 pcs		

**silicone**

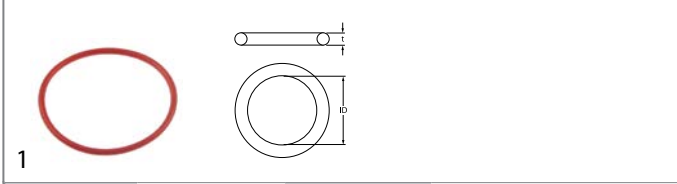

1

<b>GEV No.</b>	532505	<b>Ref. No.</b>	0C0188
<b>description</b>	O-ring silicone thickness 1.78mm ID ø 33.05mm Qty 1 pcs		

**sealing washers**

**fibre gaskets**

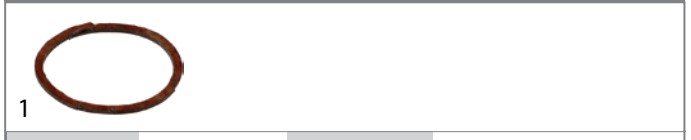

1

<b>GEV No.</b>	504765	<b>Ref. No.</b>	066088
<b>description</b>	flat gasket FIBER ED ø 54mm ID ø 48mm thickness 2mm for thread 1½" Qty 1 pcs		

**Viton**

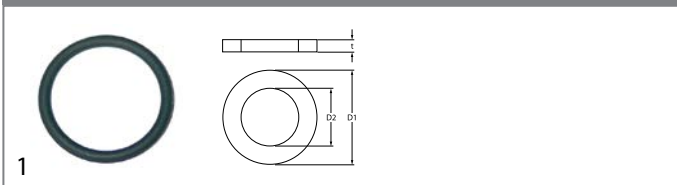

1

<b>GEV No.</b>	511300	<b>Ref. No.</b>	002873
<b>description</b>	O-ring Viton thickness 3.53mm ID ø 28.17mm for 57 series for motor shaft		

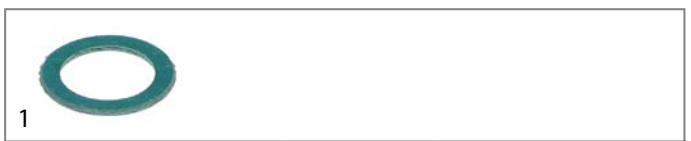



1

<b>GEV No.</b>	510597	<b>Ref. No.</b>	050296
<b>description</b>	flat gasket fibre ED ø 34mm ID ø 24mm thickness 2mm Qty 1 pcs		





 <p>1</p>			
<b>GEV No.</b>	504306	<b>Ref. No.</b>	069438
<b>description</b>	gasket fibre ED ø 16mm ID ø 10mm thickness 2mm Qty 1 pcs		

 <p>1</p>			
<b>GEV No.</b>	514251	<b>Ref. No.</b>	050295
<b>description</b>	gasket fibre ED ø 46mm ID ø 38mm thickness 2mm Qty 1 pcs		

 <p>1</p>			
<b>GEV No.</b>	540796	<b>Ref. No.</b>	020279
<b>description</b>	gasket fibre ED ø 60mm ID ø 50mm thickness 2mm for outlet tap Qty 1 pcs		

rubber gaskets

 <p>1</p>			
<b>GEV No.</b>	504524	<b>Ref. No.</b>	048823
<b>description</b>	flat gasket rubber ED ø 121mm ID ø 85mm thickness 1mm Qty 1 pcs		

 <p>1</p>			
<b>GEV No.</b>	520054 <sup>1</sup>	<b>Ref. No.</b>	046925
<b>description</b>	flat gasket rubber ED ø 23.5mm ID ø 14mm thickness 2.3mm Qty 10 pcs		

<sup>1</sup>Qty 10 pieces

 <p>1</p>			
<b>GEV No.</b>	504507	<b>Ref. No.</b>	049038
<b>description</b>	flat gasket rubber ED ø 49.5mm ID ø 39mm thickness 2mm Qty 1 pcs equiv. no. 049038 suitable for ZANUSSI		

 <p>1</p>			
<b>GEV No.</b>	504711	<b>Ref. No.</b>	030186
<b>description</b>	flat gasket rubber ED ø 55mm ID ø 42mm thickness 3mm Qty 1 pcs		

 <p>1</p>			
<b>GEV No.</b>	510071	<b>Ref. No.</b>	049244
<b>description</b>	flat gasket rubber ED ø 81mm ID ø 68mm thickness 3mm for salt tank Qty 1 pcs		

 <p>1</p>			
<b>GEV No.</b>	504774	<b>Ref. No.</b>	046595
<b>description</b>	gasket rubber ED ø 58.5mm ID ø 47mm thickness 3mm Qty 1 pcs		

 <p>1</p>			
<b>GEV No.</b>	504776	<b>Ref. No.</b>	049828
<b>description</b>	gasket rubber ED ø 60mm ID ø 50mm thickness 1.5mm for intake body		

PTFE gaskets

 <p>1</p>			
<b>GEV No.</b>	510012	<b>Ref. No.</b>	069643
<b>description</b>	flat gasket PTFE ED ø 16.5mm ID ø 12.5mm thickness 1.5mm Qty 1 pcs equiv. no. 437008		

 <p>1</p>			
<b>GEV No.</b>	693745	<b>Ref. No.</b>	002624
<b>description</b>	gasket PTFE ED ø 20mm ID ø 15mm thickness 1mm Qty 1 pcs		

foam rubber gaskets

 <p>1</p>			
<b>GEV No.</b>	504669	<b>Ref. No.</b>	046583
<b>description</b>	foam rubber gasket W 10mm thickness 2mm self-adhesive Qty 5m		

 <p>1</p>			
<b>GEV No.</b>	901678	<b>Ref. No.</b>	0K7496
<b>description</b>	foam rubber gasket Qty 1200mm incl. adhesive for lid		

## sealing cords

## square



1

<b>GEV No.</b>	693739	<b>Ref. No.</b>	058404
<b>description</b>	sealing cord square size 12x12mm t.max. 550°C braided L 5m		

## door seal rails



1

<b>GEV No.</b>	900376	<b>Ref. No.</b>	0A8409
<b>description</b>	bottom gasket W 37mm W2 15mm L 1000mm self-adhesive		

## shaft gaskets

## shaft gaskets



1

<b>GEV No.</b>	511532	<b>Ref. No.</b>	0KV751
<b>description</b>	shaft seal ID ø 15mm ED ø 25.5mm thickness 6.5mm for ice-cube maker		



1

<b>GEV No.</b>	511533	<b>Ref. No.</b>	0KM798
<b>description</b>	shaft seal ID ø 25mm ED ø 34mm thickness 5mm for ice maker		

## miscellaneous



1

<b>GEV No.</b>	511301	<b>Ref. No.</b>	002699
<b>description</b>	shaft seal ID ø 16mm ED ø 38mm thickness 18mm		

## special gaskets

## door seals for dishwashers



1

<b>GEV No.</b>	504675	<b>Ref. No.</b>	047455
<b>description</b>	door seal L 315mm W 255mm mounting pos. left H 15mm door suitable for ZANUSSI equiv. no. 047455		



1

<b>GEV No.</b>	504674	<b>Ref. No.</b>	047454
<b>description</b>	door seal L 315mm W 255mm mounting pos. right H 15mm door suitable for ZANUSSI equiv. no. 047454		



1

<b>GEV No.</b>	504667	<b>Ref. No.</b>	049017
<b>description</b>	door seal L 440mm mounting pos. upper door suitable for ZANUSSI equiv. no. 049017		



1

<b>GEV No.</b>	504758	<b>Ref. No.</b>	049892
<b>description</b>	door seal L 560mm mounting pos. upper		



1

<b>GEV No.</b>	504673	<b>Ref. No.</b>	046394
<b>description</b>	door seal L 600mm mounting pos. upper door suitable for ZANUSSI equiv. no. 046394		

1

<b>GEV No.</b>	504668	<b>Ref. No.</b>	049016
<b>description</b>	door seal mounting pos. lower door suitable for ZANUSSI equiv. no. 049016		

1

<b>GEV No.</b>	504669	<b>Ref. No.</b>	046583
<b>description</b>	foam rubber gasket W 10mm thickness 2mm self-adhesive Qty 5m		

miscellaneous

1

<b>GEV No.</b>	693402	<b>Ref. No.</b>	002706
<b>description</b>	boiler gasket		

1

<b>GEV No.</b>	901678	<b>Ref. No.</b>	0K7496
<b>description</b>	foam rubber gasket Qty 1200mm incl. adhesive for lid		

1

<b>GEV No.</b>	550924	<b>Ref. No.</b>	002075
<b>description</b>	gasket for probe ID ø 6mm EPDM		

1

<b>GEV No.</b>	504322	<b>Ref. No.</b>	060717
<b>description</b>	gasket L 14mm W 14mm external height 4mm ID ø 8mm		

1

<b>GEV No.</b>	693396	<b>Ref. No.</b>	057402
<b>description</b>	gasket level glass L 30mm W 30mm thickness 0.8mm equiv. no. 250617 suitable for JUNO		
<b>accessories for</b>	693396		
	<b>GEV No.</b>	693398	<b>Ref. No.</b> 057382
	frame for level glass		

1

<b>GEV No.</b>	510014	<b>Ref. No.</b>	069525
<b>description</b>	gasket suitable for HOBART equiv. no. 139321-155 L 84mm W 40mm thickness 2.5mm		

1

<b>GEV No.</b>	700491	<b>Ref. No.</b>	003990
<b>description</b>	gasket suitable for JUNO equiv. no. 03990 L 40mm W 35mm door catch thickness 1mm		

1

<b>GEV No.</b>	504732	<b>Ref. No.</b>	046360
<b>description</b>	gasket suitable for ZANUSSI equiv. no. 046360 L 47mm W 18.5mm thickness 3mm		

1

<b>GEV No.</b>	693404	<b>Ref. No.</b>	055371
<b>description</b>	gasket suitable for ZANUSSI equiv. no. 55371 fanwheel ED ø 800mm		

refrigeration cycle components

valves

expansion valves

DANFOSS

valves

type TUA/TUB/TUC



1

<b>GEV No.</b>	750016	<b>Ref. No.</b>	087333
<b>description</b>	expansion valve DANFOSS type TUB coolant R134a angled 90° thermostatically controlled inlet 6mm ODF outlet 12mm ODF p max 34bar -40 up to +10°C capillary pipe 800mm		

refrigeration pipes

copper pipes uninsulated



1

<b>GEV No.</b>	694252	<b>Ref. No.</b>	091724
<b>description</b>	T-piece ED ø 6mm copper		



1

<b>GEV No.</b>	693403	<b>Ref. No.</b>	003874
<b>description</b>	gasket suitable for ZANUSSI hot air		

thermostat gaskets



1

<b>GEV No.</b>	510167	<b>Ref. No.</b>	066717
<b>description</b>	gasket for thermostat ED ø 41mm ID ø 18mm Qty ANGELO PO/ ZANUSSI pcs equiv. no. 3150270/66717		

gaskets for wash arm support



1

<b>GEV No.</b>	504537	<b>Ref. No.</b>	048236
<b>description</b>	gasket D1 ø 100mm D2 ø 70mm thickness 7.5mm wash arm support equiv. no. 048236 suitable for ZANUSSI		



1

<b>GEV No.</b>	504559	<b>Ref. No.</b>	047928
<b>description</b>	gasket D1 ø 26mm D2 ø 70mm thickness 2mm rubber with 3 screw holes wash arm support equiv. no. 047928 suitable for ZANUSSI		





## evaporators

### for fridges

#### producer-specific



1

**GEV No.** 750251 **Ref. No.** 082231

**description** evaporator L 315mm W 105mm H 690mm overall height 125mm refrigerators and refrigerator-freezers suitable for ELECTROLUX, ZANUSSI



1

**GEV No.** 750150 **Ref. No.** 082211

**description** evaporator L 315mm W 125mm H 105mm refrigerators and refrigerator-freezers suitable for ELECTROLUX, ZANUSSI



1

**GEV No.** 750250 **Ref. No.** 082732

**description** evaporator L 395mm W 100mm H 250mm refrigerator suitable for ELECTROLUX, ZANUSSI



1

**GEV No.** 750009 **Ref. No.** 0A9212

**description** evaporator L 445mm W 95mm H 110mm

## condensers

### condensers

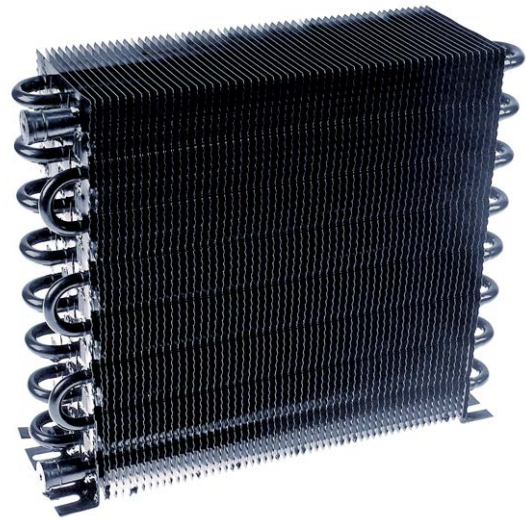

1

**GEV No.** 750249 **Ref. No.** 082229

**description** condenser refrigerator W 300mm D 90mm H 250mm suitable for ELECTROLUX, ZANUSSI

## transmission technology and ball bearings

### drive belts

#### V-belts

#### profile Z/10



1

**GEV No.** 693262 **Ref. No.** 052804

**description** V-belt belt width 10mm L 560mm H 6mm CODE Z22 profile Z/10

#### toothed belts



1

**GEV No.** 504778 **Ref. No.** 0E5050

**description** toothed belt profile T10 L 610mm H 4mm teeth 61 rubber with textile insertion CODE 354TI W 16mm

			
1			
<b>GEV No.</b>	698653	<b>Ref. No.</b>	0KJ039
<b>description</b>	toothed belt profile V L 1000mm CODE 4668 W 31.5mm		

poly-v belts

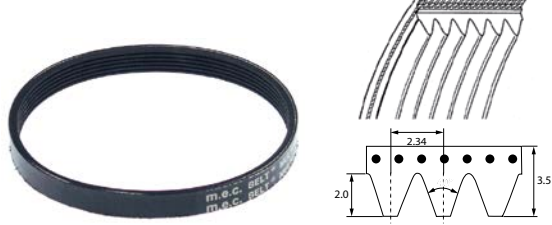
			
1			
<b>GEV No.</b>	693269	<b>Ref. No.</b>	002148
<b>description</b>	poly-v belt grooves 6 W 14mm L 355mm profile J		

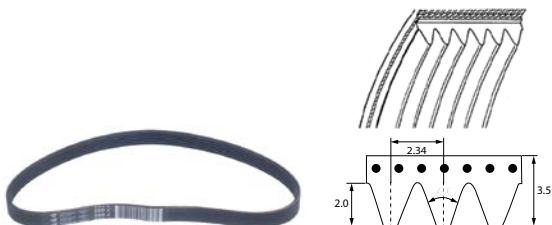
			
1			
<b>GEV No.</b>	698409	<b>Ref. No.</b>	033106 0KJ780
<b>description</b>	poly-v belt grooves 6 W 14mm L 559mm profile J		

chains

roller chains 08B-1 single

			
1			
<b>GEV No.</b>	693275	<b>Ref. No.</b>	056862
<b>description</b>	roller chain DIN/ISO 08 B-1 splitting 1/2" / 12.7mm links 23 internal width 7.75mm rollerø 8.51mm single without connecting bow		

connectors

			
1			
<b>GEV No.</b>	693276	<b>Ref. No.</b>	056863
<b>description</b>	connector single DIN/ISO 08 B-1 splitting 1/2" links 1 L 23mm internal width 11.8mm rollerø 4.3mm metal		

springs

torsion springs

			
1			
<b>GEV No.</b>	504653	<b>Ref. No.</b>	046268
<b>description</b>	torsion spring mounting pos. left		

			
1			
<b>GEV No.</b>	504652	<b>Ref. No.</b>	046269
<b>description</b>	torsion spring mounting pos. right		

			
1			
<b>GEV No.</b>	700487	<b>Ref. No.</b>	054560
<b>description</b>	torsion spring ø 10.8mm L2 5mm wire gauge ø 2.2mm L1 86mm L3 86mm		

			
1			
<b>GEV No.</b>	700450	<b>Ref. No.</b>	054282
<b>description</b>	torsion spring ø 13mm L2 177mm wire gauge ø 2.5mm L1 10mm L3 177mm Qty 1 pcs		

			
1			
<b>GEV No.</b>	690683	<b>Ref. No.</b>	082178
<b>description</b>	torsion spring ø 14.5mm wire gauge ø 2.5mm L1 86mm L2 30mm L3 16mm refrigerator		

			
1			
<b>GEV No.</b>	700087	<b>Ref. No.</b>	082179
<b>description</b>	torsion spring ø 14.5mm wire gauge ø 2.7mm L1 86mm L2 30mm L3 16mm refrigerator		

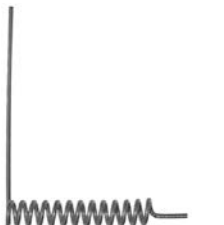
			
1			
<b>GEV No.</b>	700023	<b>Ref. No.</b>	0H6608
<b>description</b>	torsion spring ø 18.2mm L2 150mm wire gauge ø 3.2mm mounting pos. left L1 100mm L3 24mm		

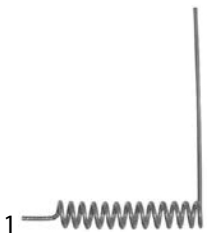
			
<b>GEV No.</b>	700022	<b>Ref. No.</b>	0H6607
<b>description</b>	torsion spring ø 18.6mm L2 93mm wire gauge ø 3.4mm mounting pos. right L1 133mm L3 24mm		

			
<b>GEV No.</b>	693299	<b>Ref. No.</b>	052894
<b>description</b>	torsion spring ø 28.6mm L2 103mm wire gauge ø 3.6mm L1 45mm		

			
<b>GEV No.</b>	693313	<b>Ref. No.</b>	051527
<b>description</b>	torsion spring ø 38.1mm wire gauge ø 6.2mm L1 19mm L2 212mm L3 19mm		

			
<b>GEV No.</b>	693316	<b>Ref. No.</b>	059518
<b>description</b>	torsion spring ø 38.2mm wire gauge ø 6.2mm L1 33mm L2 320mm L3 24mm		

			
<b>GEV No.</b>	693286	<b>Ref. No.</b>	051268
<b>description</b>	torsion spring ø 39.2mm wire gauge ø 7.2mm L1 308mm L2 19mm L3 19mm for kettle type series 900		

			
<b>GEV No.</b>	693315	<b>Ref. No.</b>	002981
<b>description</b>	torsion spring ø 39mm wire gauge ø 7.1mm L1 31mm L2 322mm L3 23mm		

			
<b>GEV No.</b>	504697	<b>Ref. No.</b>	048279
<b>description</b>	torsion spring ø 6mm L2 6mm wire gauge ø 1.2mm L1 67mm L3 29mm		

			
<b>GEV No.</b>	504705	<b>Ref. No.</b>	068645
<b>description</b>	torsion spring ø 7mm L2 5mm wire gauge ø 1mm L1 50mm L3 29mm		

compression springs

			
<b>GEV No.</b>	301209	<b>Ref. No.</b>	004243
<b>description</b>	compression spring ø 10mm L 15mm wire gauge ø 0.9mm		

			
<b>GEV No.</b>	700422	<b>Ref. No.</b>	052789
<b>description</b>	compression spring ø 14.8mm L 70mm wire gauge ø 1.7mm		

			
<b>GEV No.</b>	700445	<b>Ref. No.</b>	053757
<b>description</b>	compression spring ø 21.7mm L 29mm wire gauge ø 1.5mm		

			
<b>GEV No.</b>	700424	<b>Ref. No.</b>	056846
<b>description</b>	compression spring ø 26mm L 220mm wire gauge ø 4.2mm		

			
<b>GEV No.</b>	504660	<b>Ref. No.</b>	047492
<b>description</b>	compression spring ø 8.9mm L 37.5mm wire gauge ø 1.15mm		

spring compressors

			
<b>GEV No.</b>	504688	<b>Ref. No.</b>	049886
<b>description</b>	spring compressor		

			
<b>GEV No.</b>	504689	<b>Ref. No.</b>	049583
<b>description</b>	spring compressor		

			
<b>GEV No.</b>	693287	<b>Ref. No.</b>	051267
<b>description</b>	spring compressor		

			
1			
<b>GEV No.</b>	693290	<b>Ref. No.</b>	0A2551
<b>description</b>	spring compressor		

### roller springs

#### roller springs

			
1			
<b>GEV No.</b>	519449	<b>Ref. No.</b>	0E5158
<b>description</b>	roller spring W 25mm ID ø 32mm lug lengthmm		

			
1			
<b>GEV No.</b>	504518	<b>Ref. No.</b>	0E5167
<b>description</b>	roller spring W 39mm ID ø 32mm lug lengthmm		

### miscellaneous

			
1			
<b>GEV No.</b>	700455	<b>Ref. No.</b>	055558
<b>description</b>	spring		

			
1			
<b>GEV No.</b>	691220	<b>Ref. No.</b>	053342
<b>description</b>	spring clip shaft diameter 6mm ømm L 17mm W 14mm H 5mm wire gauge ø 1.5mm		

### tension springs

			
1			
<b>GEV No.</b>	504687	<b>Ref. No.</b>	049947
<b>description</b>	tension spring		

			
1			
<b>GEV No.</b>	504649	<b>Ref. No.</b>	048815
<b>description</b>	tension spring ø 10.5mm total length 274mm wire gauge ø 1.8mm		

			
1			
<b>GEV No.</b>	504639	<b>Ref. No.</b>	049086
<b>description</b>	tension spring ø 15.5mm total length 198mm wire gauge ø 1.5mm		

			
1			
<b>GEV No.</b>	504638	<b>Ref. No.</b>	049200
<b>description</b>	tension spring ø 15mm total length 185mm wire gauge ø 1.5mm		

			
1			
<b>GEV No.</b>	700420	<b>Ref. No.</b>	056975
<b>description</b>	tension spring ø 20mm total length 60mm wire gauge ø 2.6mm		

			
1			
<b>GEV No.</b>	693295	<b>Ref. No.</b>	0C0666
<b>description</b>	tension spring ø 29.5mm total length 310mm wire gauge ø 4.6mm		

			
1			
<b>GEV No.</b>	693289	<b>Ref. No.</b>	0A5150
<b>description</b>	tension spring ø 36.5mm total length 240mm wire gauge ø 6.9mm		

			
1			
<b>GEV No.</b>	504686	<b>Ref. No.</b>	048258
<b>description</b>	tension spring ø 39.3mm total length 493mm wire gauge ø 4.1mm		

			
1			
<b>GEV No.</b>	504684	<b>Ref. No.</b>	048655
<b>description</b>	tension spring ø 40mm total length 365mm wire gauge ø 4mm		

			
1			
<b>GEV No.</b>	504685	<b>Ref. No.</b>	049582
<b>description</b>	tension spring ø 40mm total length 750mm wire gauge ø 5.5mm		

			
1			
<b>GEV No.</b>	504682	<b>Ref. No.</b>	046615
<b>description</b>	tension spring ø 50mm total length 290mm L2 165mm		



			
1			
<b>GEV No.</b>	693294	<b>Ref. No.</b>	0C0671
<b>description</b>	tension spring ø 70mm total length 355mm wire gauge ø 10mm		

## manometers

			
1			
<b>GEV No.</b>	541579	<b>Ref. No.</b>	017055
<b>description</b>	manometer ø 52mm pressure range 0 up to 1bar connection marking 0.5 thread 1/4"		

			
1			
<b>GEV No.</b>	541334	<b>Ref. No.</b>	059515
<b>description</b>	manometer ø 60mm pressure range 0 up to 1bar thread 1/8" marking 0.5 kettle connection on the backside		

			
1			
<b>GEV No.</b>	541339	<b>Ref. No.</b>	0C0712
<b>description</b>	manometer ø 62.4mm pressure range 0 up to 1bar thread 1/8" marking connection		

## hose reels and spray guns

### spray guns

			
1			
<b>GEV No.</b>	549332	<b>Ref. No.</b>	003167
<b>description</b>	spray gun for appliances 1/2" IT L 215mm type ZANUSSI		
<b>accessories for</b>	549332		
	<b>GEV No.</b>	520168	<b>Ref. No.</b> —
	double nipple nickel-plated brass thread 1/2" - 1/2" Qty 1 pcs		

			
1			
<b>GEV No.</b>	542038	<b>Ref. No.</b>	003175
<b>description</b>	spray gun for appliances 3/8" IT L 135mm		

			
1			
<b>GEV No.</b>	542966	<b>Ref. No.</b>	003513
<b>description</b>	wall holder for hand spray		

## hose reels

### appliance hose reels

			
1			
<b>GEV No.</b>	545800	<b>Ref. No.</b>	0C1128
<b>description</b>	hose reel complete with spray gun hose length 1.6m		

## dosing pumps



### peristaltic dosing pumps

#### MICRODOS

##### built-in version

##### without control





<b>1</b>				
<b>GEV No.</b>	361097	<b>Ref. No.</b>	049311 049625 0L0697 0S0704	
<b>description</b>	dosing pump MICRODOS without control 0.5l/h 230VAC rinse aid hose ø 4x6mm hose silicone suction level 1.5m horizontal/vertical type MP3			
<b>spare parts for</b>	361097			
	<b>GEV No.</b>	361487	<b>Ref. No.</b>	—
	pump hose rinse aid ID ø 5mm ED ø 10mm hose ø 4x6mm hose type silicone with connections Shore 60°			
	<b>GEV No.</b>	361515	<b>Ref. No.</b>	—
	roller assembly rinse aid hose type silicone black			
	<b>GEV No.</b>	361595	<b>Ref. No.</b>	—
	pump hose rinse aid ID ø 6mm ED ø 10.6mm hose ø 6x10mm hose ø 6mm hose type silicone			

#### SEKO



##### built-in version







##### without control



<b>1</b>				
<b>GEV No.</b>	361150 <sup>1</sup>	<b>Ref. No.</b>	0S0704	
<b>description</b>	dosing pump SEKO without control 0.4l/h 230VAC rinse aid hose ø 4x6mm hose type D hose Sekobril suction level 1.5m horizontal/vertical type PG dimensions 67x95x52mm			
<b>spare parts for</b>	361150			
	<b>GEV No.</b>	361135	<b>Ref. No.</b>	—
	pump hose SEKO rinse aid hose ø 3x8mm hose ø 4x6mm hose type D hose Sekobril			
	<b>GEV No.</b>	361136	<b>Ref. No.</b>	—
	roller assembly for dosing pump hole ø 4.8x4mm			
	<b>GEV No.</b>	361562	<b>Ref. No.</b>	—
	pump cover for dosing pump yellow			

<sup>1</sup>with accessories

<b>spare parts for</b>	361150			
	<b>GEV No.</b>	361866	<b>Ref. No.</b>	—
	union nut for hose connector ø 17mm			
<b>accessories for</b>	361150			
	<b>GEV No.</b>	361144	<b>Ref. No.</b>	—
	mounting set rinse aid hose type 4x6mm hose length 2m PVC/nylon hose container filter/non-return valve transparent			
	<b>GEV No.</b>	570123	<b>Ref. No.</b>	—
	PVC hose ID ø 4mm ED ø 6mm L 3.5m thickness 1mm t.max. 60°C transparent			

<b>1</b>				
<b>GEV No.</b>	361152 <sup>1</sup>	<b>Ref. No.</b>	0S0705	
<b>description</b>	dosing pump SEKO without control 3l/h 230VAC detergent hose ø 4x6mm hose type K hose Santoprene suction level 1.5m horizontal/vertical type PG built-in version dimensions 67x95x52mm			
<b>spare parts for</b>	361152			
	<b>GEV No.</b>	361136	<b>Ref. No.</b>	—
	roller assembly for dosing pump hole ø 4.8x4mm			
	<b>GEV No.</b>	361562	<b>Ref. No.</b>	—
	pump cover for dosing pump yellow			
	<b>GEV No.</b>	361815	<b>Ref. No.</b>	049419
	pump hose detergent hose ø 6x10mm hose ø 4x6mm hose type K hose Santoprene type SEKO			
<b>accessories for</b>	361152			
	<b>GEV No.</b>	361142	<b>Ref. No.</b>	—
	mounting set detergent hose type 4x6mm hose length 2m PVC 2x hose/container filter/tank intake transparent			
	<b>GEV No.</b>	520090	<b>Ref. No.</b>	—
	PVC hose ID ø 4mm ED ø 6mm L 2m thickness 1mm t.max. 60°C transparent			
	<b>GEV No.</b>	520091	<b>Ref. No.</b>	—
	nylon hose ID ø 4mm ED ø 6mm L 2m thickness 1mm operating p. 10bar burst p. 50bar t.max. 100°C transparent			

<sup>1</sup>with accessories



<b>spare parts</b>				
				
<b>1</b>				
<b>GEV No.</b>	361815	<b>Ref. No.</b>	049419	
<b>description</b>	pump hose detergent hose ø 6x10mm hose ø 4x6mm hose type K hose Santoprene type SEKO			



piston pumps

with solenoid coil



<b>GEV No.</b>	361740	<b>Ref. No.</b>	048580
<b>description</b>	dosing pump inlet 4x6mm outlet 5mm 230V rinse aid duty cycle 25% type EKP-M 50Hz impulse 3imp/s		
<b>spare parts for</b>	361740		
	<b>GEV No.</b>	361811	<b>Ref. No.</b> —
	hose connector for dosing pump hose ø 6.3mm T1: M12x1.5 chrome-plated brass		
<b>accessories for</b>	361740		
	<b>GEV No.</b>	361505	<b>Ref. No.</b> —
	screw pipe fitting straight nickel-plated brass thread 3/8" IT hose ø 6x8mm		

spare parts





	<b>GEV No.</b>	361113	<b>Ref. No.</b>	069479
<b>description</b>	solenoid coil 230VAC for type DB2			

membrane dosing pumps





self-priming

LANG





	<b>GEV No.</b>	361008 <sup>1</sup>	<b>Ref. No.</b>	045478
<b>description</b>	dosing pump type N6 with special hose set rinse aid pressure connection ø angled, 4x6mm suction connection ø straight, 4x6mm suction connection straight, M10x1			
<b>spare parts for</b>	361008			
	<b>GEV No.</b>	361079	<b>Ref. No.</b>	—
	spring for type N5/N6 for ball			
	<b>GEV No.</b>	361080	<b>Ref. No.</b>	—
	O-ring EPDM thickness 2mm ID ø 16mm Qty 1 pcs			
	<b>GEV No.</b>	361085	<b>Ref. No.</b>	—
	O-ring EPDM thickness 2mm ID ø 8mm Qty 1 pcs			
	<b>GEV No.</b>	361309	<b>Ref. No.</b>	—
	ball for type N5/N6			
	<b>GEV No.</b>	361310	<b>Ref. No.</b>	—
	bracket for type N6 ball guide			

<sup>1</sup>with accessories

<b>spare parts for</b>	361008			
	<b>GEV No.</b>	361311	<b>Ref. No.</b>	—
	O-ring EPDM thickness 2mm ID ø 6mm Qty 1 pcs for type N6			
	<b>GEV No.</b>	361314	<b>Ref. No.</b>	—
	valve ring for type N6 holder for O-ring			
	<b>GEV No.</b>	361317	<b>Ref. No.</b>	—
	sealing disc for type N6			
	<b>GEV No.</b>	361886	<b>Ref. No.</b>	—
	non-return valve inletmm outletmm outlet ø 12.4mm L 12.7mm			

various



	<b>GEV No.</b>	361370	<b>Ref. No.</b>	049484
<b>description</b>	dosing pump type model 2 rinse aid inlet 4x6mm outlet 4x6mm pressure connection ø 4x6mm suction connection ø 4x6mm			
<b>spare parts for</b>	361370			
	<b>GEV No.</b>	361307	<b>Ref. No.</b>	—
	membrane dosing pump ø 68mm hole ø 6mm for type DIB3P/DIB5P			
	<b>GEV No.</b>	361459	<b>Ref. No.</b>	—
	hose connector ø 6mm for dosing pump			

accessories

	<b>GEV No.</b>	361462	<b>Ref. No.</b>	051028
<b>description</b>	container filter with weight SS hose ø 4x6mm			

non-return valves

	<b>GEV No.</b>	361147	<b>Ref. No.</b>	049358
<b>description</b>	non-return valve inlet 4x6mm outlet 1/8" L 50mm Qty 1 pcs			

tank inlets



<b>GEV No.</b>	361270	<b>Ref. No.</b>	049801
<b>description</b>	tank inlet SS M12 hose ø 4mm		

<b>GEV No.</b>	520011	<b>Ref. No.</b>	0L1887
<b>description</b>	supply hose PVC straight-curved DN13 connections 3/4" L 2000mm operating p. 10bar burst p. 32bar t.max. 90°C approval VDE flat seal		

hoses

supply hoses

stainless steel flexi hoses

universal hoses

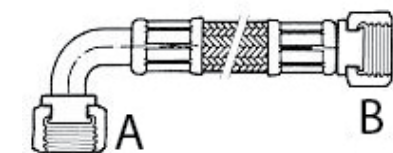
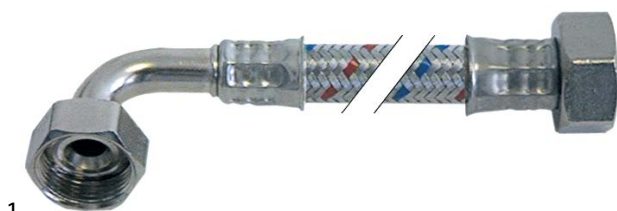

<b>GEV No.</b>	520008	<b>Ref. No.</b>	069571
<b>description</b>	flex hose SS braid straight-curved DN12 connection 1: 3/4" connection 2: 3/4" L 1500mm approval DVGW operating p. 10bar test pressure 32bar burst p. 95bar		
<b>accessories for</b>	520008		
	<b>GEV No.</b>	520054	<b>Ref. No.</b> 046925
	flat gasket rubber ED ø 23.5mm ID ø 14mm thickness 2.3mm Qty 10 pcs		

drain hoses

<b>GEV No.</b>	530615	<b>Ref. No.</b>	047894
<b>description</b>	drain hose DN40 L 1000mm straight ø inside 58mm straight ext. ø 65mm outer hose ø 47mm temp.-resist. 90°C		

<b>GEV No.</b>	504253	<b>Ref. No.</b>	049856
<b>description</b>	drain hose DN21 L 1600mm A int. ø 35mm A ext. ø 40mm B int. ø 40mm B ext. ø 46mm outer hose ø 29mm		

<b>GEV No.</b>	530575	<b>Ref. No.</b>	047465
<b>description</b>	drain hose DN31 L 1000mm A int. ø 36mm A ext. ø 40mm B int. ø 40mm B ext. ø 46mm outer hose ø 41mm		

PVC supply hoses



<b>GEV No.</b>	520010	<b>Ref. No.</b>	0C5562
<b>description</b>	supply hose PVC straight-curved DN13 connections 3/4" L 1500mm operating p. 10bar burst p. 32bar t.max. 90°C blue approval VDE flat seal		
<b>accessories for</b>	520010		
	<b>GEV No.</b>	520053	<b>Ref. No.</b> —
	screen connection 3/4" D1 ø 26mm D2 ø 15mm Qty 10 pcs rubber thickness 8mm		
	<b>GEV No.</b>	520054	<b>Ref. No.</b> 046925
	flat gasket rubber ED ø 23.5mm ID ø 14mm thickness 2.3mm Qty 10 pcs		

<b>GEV No.</b>	504254	<b>Ref. No.</b>	048818
<b>description</b>	drain hose DN35 L 1600mm A int. ø 35mm A ext. ø 41mm B int. ø 41mm B ext. ø 49mm outer hose ø 42mm		



1

<b>GEV No.</b>	504252	<b>Ref. No.</b>	047558
<b>description</b>	drain hose DN1.5 L 2150mm straight ø inside 18mm straight ext. ø 24mm elbow ø inside 28mm elbow ext. ø 34mm outer hose ø 24mm		



1

<b>GEV No.</b>	504626	<b>Ref. No.</b>	045768
<b>description</b>	formed hose D1 ø 55mm D2 ø 45mm L 300mm dishwasher straight		

industrial hoses

Niplaflex hoses



1

<b>GEV No.</b>	530719	<b>Ref. No.</b>	055445
<b>description</b>	hose ID ø 11mm ED ø 18mm L 0.4m operating p. 10bar burst p. 30bar t.max. 110°C		



1

<b>GEV No.</b>	504631	<b>Ref. No.</b>	0L0613
<b>description</b>	formed hose dishwasher straight equiv. no. 045456		



1

<b>GEV No.</b>	530561	<b>Ref. No.</b>	0C4158
<b>description</b>	pressure hose ID ø 10mm ED ø 17mm L 5m thickness 3.5mm operating p. 10bar burst p. 30bar t.max. 110°C		



1

<b>GEV No.</b>	504633	<b>Ref. No.</b>	046565
<b>description</b>	formed hose dishwasher straight equiv. no. 046565		

pressure control hoses



1

<b>GEV No.</b>	530560	<b>Ref. No.</b>	048883
<b>description</b>	pressure control hose ID ø 5mm ED ø 9mm L 5m operating p. 30bar burst p. 90bar temp.-resist. 60°C		

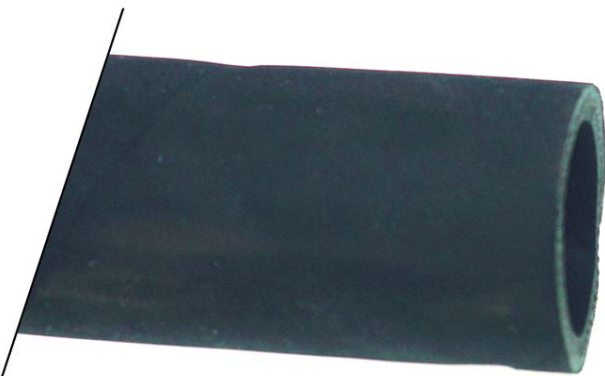

1

<b>GEV No.</b>	530720	<b>Ref. No.</b>	056888
<b>description</b>	steam hose ID ø 30mm ED ø 41mm L 700mm Qty 1 for combi-steamer		

formed hoses

straight



1

<b>GEV No.</b>	504627	<b>Ref. No.</b>	046257
<b>description</b>	formed hose D1 ø 42mm D2 ø 52mm L 430mm dishwasher straight		

form L



1

<b>GEV No.</b>	504629	<b>Ref. No.</b>	046398
<b>description</b>	formed hose warewashing L-shape equiv. no. 046398		

1

<b>GEV No.</b>	504625	<b>Ref. No.</b>	049041
<b>description</b>	formed hose warewashing L-shape equiv. no. 049041		



1

<b>GEV No.</b>	518216	<b>Ref. No.</b>	069535
<b>description</b>	formed hose warewashing L-shape equiv. no. 127001 mounting pos. upper		

with branch



1

<b>GEV No.</b>	504630	<b>Ref. No.</b>	048241
<b>description</b>	formed hose warewashing equiv. no. 048241 with piggyback, old		

form S



1

<b>GEV No.</b>	504632	<b>Ref. No.</b>	046372
<b>description</b>	formed hose S-shape warewashing equiv. no. 046372		

miscellaneous



1

<b>GEV No.</b>	518036	<b>Ref. No.</b>	069442
<b>description</b>	formed hose angled warewashing		

for dishwashers

pressure hoses



1

<b>GEV No.</b>	513319	<b>Ref. No.</b>	049773
<b>description</b>	hose ext. ø 36 ID ø 25mm L 1000mm black		



1

<b>GEV No.</b>	513320	<b>Ref. No.</b>	049599
<b>description</b>	hose ext. ø 36 ID ø 27mm black		

fittings, hose and pipe connectors

hose connectors

without screw connection



1

<b>GEV No.</b>	501210	<b>Ref. No.</b>	047431
<b>description</b>	Y-piece plastic hose ø 10-10-10mm		



			
1			
<b>GEV No.</b>	504583	<b>Ref. No.</b>	048195
<b>description</b>	Y-piece plastic hose ø 12-12-12mm		

			
1			
<b>GEV No.</b>	504582	<b>Ref. No.</b>	0L0353
<b>description</b>	cross fitting SS hose ø 11-11-11-11mm 4-way		

hose connectors

producer-specific

			
1			
<b>GEV No.</b>	504584	<b>Ref. No.</b>	0L0365
<b>description</b>	hose connector metal L 56mm D1 ø 29mm D2 ø 14mm D3 ø 14mm		



valves and tank inlets

ball valves

universal

ball valves with butterfly handle

			
1			
<b>GEV No.</b>	540983	<b>Ref. No.</b>	0A5439
<b>description</b>	ball valve connection 1" IT - 1" ET DN25 total length 79mm		

				
1				
<b>GEV No.</b>	540937	<b>Ref. No.</b>	005919	
<b>description</b>	ball valve connection 3/4" IT - 1" IT DN20 total length 80mm			
<b>accessories for</b>	540937			
	<b>GEV No.</b>	540938	<b>Ref. No.</b>	0C0563
	extension for ball valve			
	<b>GEV No.</b>	540939	<b>Ref. No.</b>	—
	lever handle suitable for outlet tap shaft 8x8mm			

			
1			
<b>GEV No.</b>	540982	<b>Ref. No.</b>	005927
<b>description</b>	ball valve connection 3/4" IT - 3/4" ET DN20 total length 69mm shaft ø 8x5mm		

			
1			
<b>GEV No.</b>	540658	<b>Ref. No.</b>	053108
<b>description</b>	ball valve connection 3/4" IT - 3/4" IT DN20 total length 69mm		



				
1				
<b>GEV No.</b>	540931	<b>Ref. No.</b>	056843	
<b>description</b>	ball valve connection 3/8" IT - 3/8" IT DN10 total length 42mm			
<b>accessories for</b>	540931			
	<b>GEV No.</b>	111643	<b>Ref. No.</b>	004465
	knob water t.max.°C temperature range°C ø 70mm shaft ø 10x8mm shaft flat upper black			
	<b>GEV No.</b>	301208	<b>Ref. No.</b>	004242
	disc			
	<b>GEV No.</b>	540932	<b>Ref. No.</b>	0A2563
	adapter for ball valve			

Table continues overleaf



<b>accessories for</b>	540931		
	<b>GEV No.</b>	540933	<b>Ref. No.</b> 0A2135
	extension IT for ball valve ET M6 shaft ø 10x8mm		

## ball valves with lever handle



<b>GEV No.</b>	520282	<b>Ref. No.</b>	004729
<b>description</b>	ball valve connection 1" IT - 1" IT DN25 total length 67mm with lever handle		

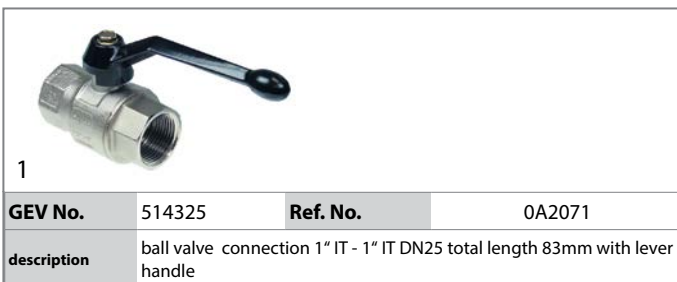

<b>GEV No.</b>	514325	<b>Ref. No.</b>	0A2071
<b>description</b>	ball valve connection 1" IT - 1" IT DN25 total length 83mm with lever handle		



<b>GEV No.</b>	520280	<b>Ref. No.</b>	0H6385
<b>description</b>	ball valve connection 1/2" IT - 1/2" IT DN15 total length 50mm with lever handle handle length 85mm		



<b>GEV No.</b>	540981 <sup>1</sup>	<b>Ref. No.</b>	004486
<b>description</b>	ball valve connection 1/2" IT - tube ø16mm total length 69mm handle length 95mm		

<sup>1</sup>pipe connection ø16mm

<b>GEV No.</b>	540991	<b>Ref. No.</b>	0A5258
<b>description</b>	ball valve connection 3/8" IT - 3/8" ET DN10 total length 62mm with lever handle handle length 95mm		

## producer-specific

## ZANUSSI

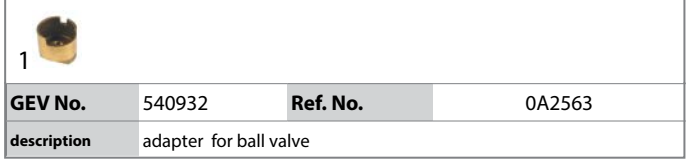

<b>GEV No.</b>	540932	<b>Ref. No.</b>	0A2563
<b>description</b>	adapter for ball valve		

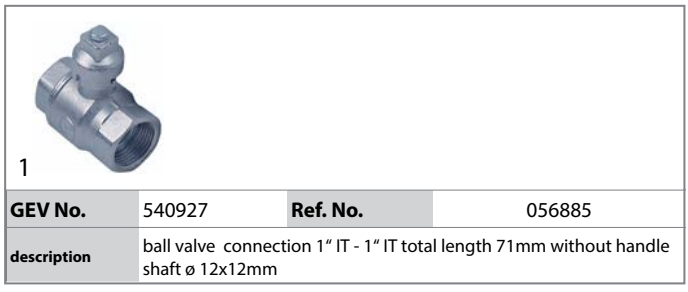

<b>GEV No.</b>	540927	<b>Ref. No.</b>	056885
<b>description</b>	ball valve connection 1" IT - 1" IT total length 71mm without handle shaft ø 12x12mm		

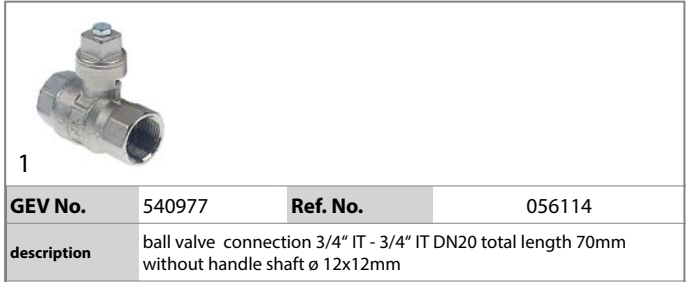

<b>GEV No.</b>	540977	<b>Ref. No.</b>	056114
<b>description</b>	ball valve connection 3/4" IT - 3/4" IT DN20 total length 70mm without handle shaft ø 12x12mm		

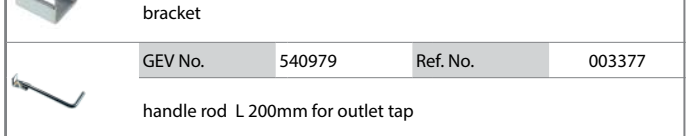

<b>GEV No.</b>	540978	<b>Ref. No.</b>	003378
	bracket		

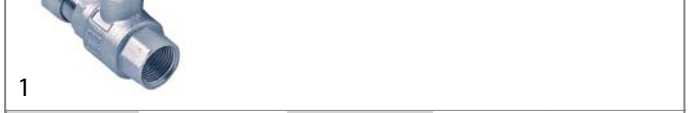

	handle rod L 200mm for outlet tap		
--	-----------------------------------	--	--

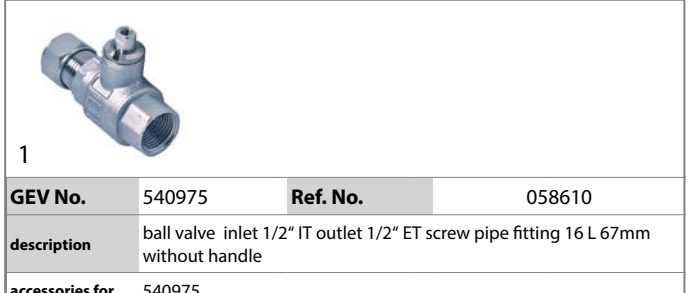

<b>GEV No.</b>	540975	<b>Ref. No.</b>	058610
<b>description</b>	ball valve inlet 1/2" IT outlet 1/2" ET screw pipe fitting 16 L 67mm without handle		







<b>GEV No.</b>	540965	<b>Ref. No.</b>	002457
	drain pipe thread		

Table continues overleaf





<b>accessories for</b>	540975		
	<b>GEV No.</b>	540976	<b>Ref. No.</b> 004505
	drain pipe L 80mm ET 1/2"		

	1		
<b>GEV No.</b>	540962	<b>Ref. No.</b>	053466
<b>description</b>	ball valve inlet 1/2" IT outlet 1/2" IT L 56mm without handle		

	1		
<b>GEV No.</b>	540964	<b>Ref. No.</b>	058647
<b>description</b>	ball valve inlet 1/2" IT outlet 1/2" IT L 61mm without handle shaft ø 10x7.3mm		
<b>accessories for</b>	540964		
	<b>GEV No.</b>	540965	<b>Ref. No.</b> 002457
	drain pipe thread		
	<b>GEV No.</b>	540976	<b>Ref. No.</b> 004505
	drain pipe L 80mm ET 1/2"		

	1		
<b>GEV No.</b>	540980	<b>Ref. No.</b>	005948
<b>description</b>	ball valve inlet 3/4" ET outlet 3/4" IT L 68mm without handle shaft ø 12x9mm		

	1		
<b>GEV No.</b>	541633	<b>Ref. No.</b>	002033
<b>description</b>	ball valve thread 1/2"		

	1		
<b>GEV No.</b>	540986	<b>Ref. No.</b>	006688
<b>description</b>	ball valve without handle L 67mm shaft ø 17x17mm inlet 1" IT outlet 1" ET		
<b>accessories for</b>	540986		
	<b>GEV No.</b>	540678	<b>Ref. No.</b> 006689
	handle for outlet tap		

	1		
<b>GEV No.</b>	540978	<b>Ref. No.</b>	003378
<b>description</b>	bracket		

	1		
<b>GEV No.</b>	540938	<b>Ref. No.</b>	0C0563
<b>description</b>	extension for ball valve		

	1		
<b>GEV No.</b>	514070	<b>Ref. No.</b>	005770
<b>description</b>	extension for outlet tap L 525mm		

	1		
<b>GEV No.</b>	540933	<b>Ref. No.</b>	0A2135
<b>description</b>	extension IT for ball valve ET M6 shaft ø 10x8mm		

	1		
<b>GEV No.</b>	514068	<b>Ref. No.</b>	002883
<b>description</b>	handle for outlet tap		

	1		
<b>GEV No.</b>	514069	<b>Ref. No.</b>	002881
<b>description</b>	handle for outlet tap		

	1		
<b>GEV No.</b>	514072	<b>Ref. No.</b>	002880
<b>description</b>	handle for outlet tap		

	1		
<b>GEV No.</b>	540678	<b>Ref. No.</b>	006689
<b>description</b>	handle for outlet tap		

	1		
<b>GEV No.</b>	540987	<b>Ref. No.</b>	006142
<b>description</b>	handle for outlet tap		

	1		
<b>GEV No.</b>	514176	<b>Ref. No.</b>	003829
<b>description</b>	handle rod L 165mm		

			
1			
<b>GEV No.</b>	540979	<b>Ref. No.</b>	003377
<b>description</b>	handle rod L 200mm for outlet tap		

			
1			
<b>GEV No.</b>	111666	<b>Ref. No.</b>	010142
<b>description</b>	star handle shaft 7x7mm ø 68mm L 22mm black thermoplastic		



ball valves electric

			
1			
<b>GEV No.</b>	401140	<b>Ref. No.</b>	005026
<b>description</b>	ball valve inlet 1" IT outlet 1" IT with plug 230V L 152mm 50/60Hz closed off-current mode of operation electric connection cable 200mm size DN25		

			
1			
<b>GEV No.</b>	401139	<b>Ref. No.</b>	0C0882
<b>description</b>	ball valve inlet 3/4" IT outlet 3/4" IT with plug 230V L 65mm 50/60Hz closed off-current mode of operation electric connection cable 200mm		

shut-off valves

universal

			
1			
<b>GEV No.</b>	540935	<b>Ref. No.</b>	056616
<b>description</b>	shut-off valve connection tube ø 10mm total length 110mm shaft 7x7mm		
<b>accessories for</b>	540935		
	<b>GEV No.</b>	<b>Ref. No.</b>	<b>025260</b>
	knob water t.max.°C temperature range°C ø 50mm shaft ø 7x7mm shaft flat black		

inlet taps

			
1			
<b>GEV No.</b>	540799	<b>Ref. No.</b>	002322
<b>description</b>	inlet tap connection 1/2" projection 130mm with swivel spout		
<b>spare parts for</b>	540799		
	<b>GEV No.</b>	<b>Ref. No.</b>	—
	tap head without plunger bush bearing thread 1/2" T2: M24x1 D1 ø 18mm D2 ø 24mm H1 18-24mm H2 29mm H3 10mm shaft intake ø 8mm suitable for RUBINETTERIE DEL FRIULI		
	<b>GEV No.</b>	<b>Ref. No.</b>	—
	star handle shaft intake ø 8mm shaft length H1 12mm H2 22mm D1 ø 32mm suitable for RUBINETTERIE DEL FRIULI marking blue		

			
1			
<b>GEV No.</b>	540989	<b>Ref. No.</b>	0C0689
<b>description</b>	inlet spout		

			
1			
<b>GEV No.</b>	540990	<b>Ref. No.</b>	051672
<b>description</b>	inlet spout connection 1/2" ET projection 120mm spout height 55mm		

1

<b>GEV No.</b>	541895	<b>Ref. No.</b>	0C4146
<b>description</b>	inlet spout connection 1/2" ET tube ø 16mm projection 50mm overall height 70mm spout height 50mm rotation°		



1

<b>GEV No.</b>	540966	<b>Ref. No.</b>	004537
<b>description</b>	inlet spout for pasta cooker		



1

<b>GEV No.</b>	540992	<b>Ref. No.</b>	051521
<b>description</b>	inlet tap connection 1/2" IT projection 23mm spout height 23mm		

## drain systems and wash basins

### standpipes

#### producer-specific

#### ZANUSSI



1

<b>GEV No.</b>	501354	<b>Ref. No.</b>	032244
<b>description</b>	drain fitting thread M35x2 brass ø 45mm H 25mm ID ø 30mm		



1

<b>GEV No.</b>	510597	<b>Ref. No.</b>	050296
<b>description</b>	flat gasket fibre ED ø 34mm ID ø 24mm thickness 2mm Qty 1 pcs		



1

<b>GEV No.</b>	501355	<b>Ref. No.</b>	032245
<b>description</b>	nut thread M35x2 H 8mm WS 41 steel		



1

<b>GEV No.</b>	540967	<b>Ref. No.</b>	050301	
<b>description</b>	overflow pipe L 140mm ø 20mm			
<b>accessories for</b>	540967			
	<b>GEV No.</b>	511518	<b>Ref. No.</b>	—
	O-ring EPDM thickness 3.53mm ID ø 23.4mm Qty 10 pcs			



1

<b>GEV No.</b>	540969	<b>Ref. No.</b>	0A5181	
<b>description</b>	overflow pipe L 85mm ø 20mm			
<b>accessories for</b>	540969			
	<b>GEV No.</b>	511516	<b>Ref. No.</b>	—
	O-ring EPDM thickness 3.53mm ID ø 20.22mm Qty 10 pcs			

## connection fittings

### screw pipe fittings



1

<b>GEV No.</b>	540052	<b>Ref. No.</b>	002188
<b>description</b>	elbow screw joint thread 3/8" tube ø 10mm chrome-plated brass		

## water cycle components

### supply filters



1

<b>GEV No.</b>	520261	<b>Ref. No.</b>	053037
<b>description</b>	supply filter thread 1/2" IT - 1/2" IT total length 58mm red brass mesh opening 0.4mm		





1

<b>GEV No.</b>	520262	<b>Ref. No.</b>	068121
<b>description</b>	supply filter thread 3/4" IT - 3/4" IT total length 70mm red brass DN20 mesh opening 0.4mm		



1

<b>GEV No.</b>	504586	<b>Ref. No.</b>	048834
<b>description</b>	supply filter thread 3/4" ET - 3/4" IT total length 108mm plastic		



1

<b>GEV No.</b>	504585	<b>Ref. No.</b>	048746
<b>description</b>	supply filter thread 3/4" ET - 3/4" IT total length 122mm plastic DN19		

**non-return valves**



1

<b>GEV No.</b>	520273	<b>Ref. No.</b>	049851
<b>description</b>	non-return valve brass connection 1/2" IT - 1/2" IT total length 60mm DN15		

**ancillary products**

**clamps**

**hose clamps**  
DIN 3017 - W2



1

<b>GEV No.</b>	520112	<b>Ref. No.</b>	048126
<b>description</b>	hose clamp ø 12-20mm width 9mm Qty 10 pcs DIN 3017		



1

<b>GEV No.</b>	520116	<b>Ref. No.</b>	046878
<b>description</b>	hose clamp ø 32-50mm width 9mm Qty 5 pcs DIN 3017		



1

<b>GEV No.</b>	520118	<b>Ref. No.</b>	046855
<b>description</b>	hose clamp ø 50-70mm width 9mm Qty 5 pcs DIN 3017		



1

<b>GEV No.</b>	520119	<b>Ref. No.</b>	046853
<b>description</b>	hose clamp ø 60-80mm width 9mm Qty 5 pcs DIN 3017		



1

<b>GEV No.</b>	520110	<b>Ref. No.</b>	046946
<b>description</b>	hose clamp ø 8-12mm width 9mm Qty 10 pcs DIN 3017		

**pipes**

**miscellaneous**



1

<b>GEV No.</b>	695617	<b>Ref. No.</b>	056810
<b>description</b>	water pipe		





tools

cleaning tools

scrapers



1			
<b>GEV No.</b>	705022	<b>Ref. No.</b>	056940
<b>description</b>	scraper for chargrill		



1			
<b>GEV No.</b>	705008	<b>Ref. No.</b>	055995
<b>description</b>	scraper for griddle		
<b>spare parts for</b>	705008		
	<b>GEV No.</b>	<b>Ref. No.</b>	
	705021	0C2519	
	spare blades for scraper Qty 10 pcs		



1			
<b>GEV No.</b>	705021	<b>Ref. No.</b>	0C2519
<b>description</b>	spare blades for scraper Qty 10 pcs		

measuring equipment

thermometers

built-in thermometers

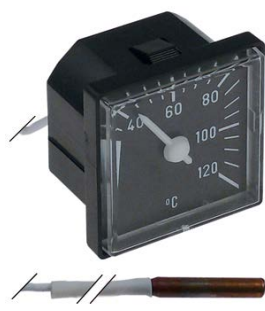

1			
<b>GEV No.</b>	541522	<b>Ref. No.</b>	048525
<b>description</b>	thermometer mounting measurements 45x45mm +40 up to +120°C capillary pipe 5000mm probe ø 6mm probe L 36mm front measurements 48x48mm		



1			
<b>GEV No.</b>	541095	<b>Ref. No.</b>	048544
<b>description</b>	thermometer mounting measurements 58x25.5mm 0 up to +120°C capillary pipe 3000mm probe ø 6.5mm probe L 20mm		



1			
<b>GEV No.</b>	541080	<b>Ref. No.</b>	083101
<b>description</b>	thermometer mounting measurements 58x25.5mm -40 up to +40°C capillary pipe 2500mm probe ø 6mm probe L 30mm		

ø52mm



1			
<b>GEV No.</b>	541521	<b>Ref. No.</b>	032863
<b>description</b>	thermometer mounting ø 52mm t.max. 120°C 0 up to +120°C probe ø 8.5mm probe L 33mm capillary pipe 1000mm		



1			
<b>GEV No.</b>	541840	<b>Ref. No.</b>	048564
<b>description</b>	thermometer mounting ø 52mm t.max. 120°C 0-120°C probe ø 6mm probe L 38mm capillary pipe 2500mm		



1			
<b>GEV No.</b>	541582	<b>Ref. No.</b>	056383
<b>description</b>	thermometer mounting ø 52mm t.max. 350°C +50 up to +350°C probe ø 6mm probe L 17mm capillary pipe 1700mm		



1

<b>GEV No.</b>	541090	<b>Ref. No.</b>	053808
<b>description</b>	thermometer mounting ø 52mm t.max. 350°C 0 up to +350°C probe ø 6.5mm probe L 22mm capillary pipe 1450mm		



1

<b>GEV No.</b>	541083	<b>Ref. No.</b>	081792
<b>description</b>	thermometer mounting ø 52mm t.max. 40°C -40 up to +40°C probe ø 6mm probe L 30mm capillary pipe 1500mm		

ø60mm



1

<b>GEV No.</b>	541082	<b>Ref. No.</b>	081512
<b>description</b>	thermometer mounting ø 60mm t.max. 40°C -40 up to +40°C probe ø 6mm probe L 135mm capillary pipe 2000mm		

## fastening material

### screws

#### hexagonal screws



1

<b>GEV No.</b>	560464	<b>Ref. No.</b>	OKE147
<b>description</b>	hexagonal screw thread M8 thread L 12mm SS WS 13 Qty 1 pcs head thickness 5mm DIN 933 / ISO 4017		

### cylinder head bolts

#### miscellaneous



1

<b>GEV No.</b>	693311	<b>Ref. No.</b>	059860
<b>description</b>	cylinder head bolt thread M6 thread L 15mm SS Qty 1 pcs intake slotted		



1

<b>GEV No.</b>	550843	<b>Ref. No.</b>	051675
<b>description</b>	screw		

### grub screws

#### DIN 913/ISO 4026



1

<b>GEV No.</b>	504733	<b>Ref. No.</b>	047846
<b>description</b>	grub screw thread M4 L 5mm stainless steel DIN 913 intake internal hexagon WS 2 Qty 1 pcs		

#### DIN 916/ISO 4029



1

<b>GEV No.</b>	504734	<b>Ref. No.</b>	046258
<b>description</b>	grub screw thread M4 L 6mm black DIN 916 intake internal hexagon WS 2 Qty 1 pcs		

### knurled screws



1

<b>GEV No.</b>	510112	<b>Ref. No.</b>	069440
<b>description</b>	Thumb screw thread M10 thread L 10mm ø 22mm H 4.5mm SS		





miscellaneous			
			
1			
<b>GEV No.</b>	700442	<b>Ref. No.</b>	025033 0G6450
<b>description</b>	thread bolt thread M6 L 32mm thread L 13mm head ø 8mm for rail		

## nuts

### knurled nuts

			
1			
<b>GEV No.</b>	504503	<b>Ref. No.</b>	049047
<b>description</b>	knurled nut thread M10x1 ø 30mm H 4mm SS		

			
1			
<b>GEV No.</b>	504528	<b>Ref. No.</b>	048632
<b>description</b>	knurled nut thread M12x1 ø 35mm H 6mm SS		

			
1			
<b>GEV No.</b>	504516	<b>Ref. No.</b>	047282
<b>description</b>	knurled nut thread M8x1 ø 25mm H 6mm SS		

			
1			
<b>GEV No.</b>	504547	<b>Ref. No.</b>	047283
<b>description</b>	knurled nut thread M8x1 ø 25mm H 6mm SS		

### hexagonal nuts

#### DIN 6923 / ISO 4161

			
1			
<b>GEV No.</b>	504315	<b>Ref. No.</b>	0E5372
<b>description</b>	nut thread M5 H 5mm WS 8 Qty 10 pcs		

### hexagonal nuts metric (without norm)

			
1			
<b>GEV No.</b>	514252	<b>Ref. No.</b>	050287
<b>description</b>	hexagonal nut		

			
1			
<b>GEV No.</b>	690842	<b>Ref. No.</b>	056409
<b>description</b>	nut		

			
1			
<b>GEV No.</b>	101345	<b>Ref. No.</b>	020997
<b>description</b>	nut thread M15x1 H 3mm WS 19 brass Qty 1 pcs		

			
1			
<b>GEV No.</b>	693430	<b>Ref. No.</b>	051263
<b>description</b>	nut thread M22x1.5 H 5mm WS 26 zinc-coated steel Qty 1 pcs		

			
1			
<b>GEV No.</b>	102067	<b>Ref. No.</b>	055033
<b>description</b>	nut thread M8x1 H 3mm brass Qty 1 pcs type SEF 1		

## washers

### spring washers

			
1			
<b>GEV No.</b>	104284	<b>Ref. No.</b>	0C6288
<b>description</b>	clamping washer nominal-ø 4mm ED ø 10mm steel thickness 0.7mm Qty 10 pcs		

## washers

## miscellaneous



1

<b>GEV No.</b>	301208	<b>Ref. No.</b>	004242
<b>description</b>	disc		



1

<b>GEV No.</b>	693431	<b>Ref. No.</b>	002727
<b>description</b>	plain washer		



1

<b>GEV No.</b>	690844	<b>Ref. No.</b>	056416
<b>description</b>	plain washer plastic		

## fasteners

## slot nuts



1

<b>GEV No.</b>	560268	<b>Ref. No.</b>	0E5048
<b>description</b>	slot nut W 8mm H 7mm L 35mm		

## clamps

## hose clamps

## DIN 3017 - W2



1

<b>GEV No.</b>	520112	<b>Ref. No.</b>	048126
<b>description</b>	hose clamp ø 12-20mm width 9mm Qty 10 pcs DIN 3017		



1

<b>GEV No.</b>	520116	<b>Ref. No.</b>	046878
<b>description</b>	hose clamp ø 32-50mm width 9mm Qty 5 pcs DIN 3017		



1

<b>GEV No.</b>	520118	<b>Ref. No.</b>	046855
<b>description</b>	hose clamp ø 50-70mm width 9mm Qty 5 pcs DIN 3017		



1

<b>GEV No.</b>	520119	<b>Ref. No.</b>	046853
<b>description</b>	hose clamp ø 60-80mm width 9mm Qty 5 pcs DIN 3017		



1

<b>GEV No.</b>	520110	<b>Ref. No.</b>	046946
<b>description</b>	hose clamp ø 8-12mm width 9mm Qty 10 pcs DIN 3017		

## retaining rings

## DIN 471



1

<b>GEV No.</b>	504519	<b>Ref. No.</b>	048979
<b>description</b>	retaining ring shaft ø 17mm thickness 1mm SS DIN 471		

## DIN 472



1

<b>GEV No.</b>	698003	<b>Ref. No.</b>	0A2592
<b>description</b>	retaining ring bore ø 35mm thickness 1.5mm steel DIN 472		

## DIN 6799



1

<b>GEV No.</b>	507015	<b>Ref. No.</b>	068293
<b>description</b>	retaining ring E D1 ø 7mm D2 ø 14mm SS DIN 6799 thickness 0.9mm for shaft ø 8-11mm		



roll pins			
			
1			
<b>GEV No.</b>	692013	<b>Ref. No.</b>	0H6043
<b>description</b>	roll pin ø 3mm L 16mm		

## consumables

### lubricants

#### machine lubricants

			
1			
<b>GEV No.</b>	890029	<b>Ref. No.</b>	OKL180
<b>description</b>	machine lubricant Mobilux EP004 can 500g for gearbox -25 up to +120°C		
<b>description</b>	Mobilux EP004 - can 500g Suitable for lubricating enclosed gears and bearings in poorly sealed gear cases with the exception of electric motor bearings. Can also be used for many other industrial applications, e.g. gear cases and chains, in which conventional gear oils would escape due to leaks caused by worn or missing seals. Meets requirements of SEW 1008 hour gear test, DR.EM.2003 mod. Temperature resistance: -25°C to +120°C		

### fuses

#### fine fuses

			
1			
<b>GEV No.</b>	358610	<b>Ref. No.</b>	058869
<b>description</b>	fine fuse size ø5x20mm 10A fast-acting rated 250V Qty 10 pcs		

			
1			
<b>GEV No.</b>	358611	<b>Ref. No.</b>	005136
<b>description</b>	fine fuse size ø5x20mm 16A fast-acting rated 250V Qty 10 pcs		

			
1			
<b>GEV No.</b>	358677	<b>Ref. No.</b>	057783
<b>description</b>	fine fuse size ø5x20mm 4A fast-acting rated 250V Qty 10 pcs		

			
1			
<b>GEV No.</b>	358594	<b>Ref. No.</b>	002820
<b>description</b>	fine fuse size ø5x20mm 0.16A slow-acting rated 250V Qty 10 pcs		

			
1			
<b>GEV No.</b>	358596	<b>Ref. No.</b>	002920
<b>description</b>	fine fuse size ø5x20mm 0.25A slow-acting rated 250V Qty 10 pcs		

			
1			
<b>GEV No.</b>	358703	<b>Ref. No.</b>	002750
<b>description</b>	fine fuse size ø5x20mm 0.4A slow-acting rated 250V Qty 10 pcs		



**A**

alarm devices	65
angle pieces	295
appliance hose reels	285
axial fans	101

**B**

ball valves	291
ball valves electric	96, 294
bar burners	183
bi-metal thermostats	29, 29
booster pumps I	117
bullet connectors	120

**C**

cables	120
cam switches	48
capillary tube clips	40
ceramic heaters	11
clamps	40, 296, 300
cleaning tools	297
cold air circulating fans (complete)	103
compressors	100
condensators & interference suppression filters	118
condensing trays heated	101
connection fittings	295
consumables	301
contactors	65
container filters	287
control equipment	56
control thermostats	29, 38
copper pipes uninsulated	280
cross flow fans	103
cylinder head bolts	298

**D**

defrost timers	64
door catches	240
door gaskets (wire reinforced)	272
door seal rails	278
door seals	270
door seals for dishwashers	278
door seals with tension springs	272
dosing pumps	286
drain hoses	288
drain pumps	117
drain systems and wash basins	295

**E**

edgemount hinges	241
edgemount latches	239
electric accessories	120

electrodes	98
electronic controllers	71
energy regulators	29
espagnolette locks	240
evaporators	281
expansion valves	280
extractor fans	110

**F**

fans	101
fasteners	300
fastening material	298
filters	119
fine fuses	301
float switches	48
foam rubber gaskets	277
foil heating elements	27
formed hoses	289
fuses	119, 301

**G**

gas burners	166
gas control valves	139
gas lines	200
gas nozzles	191
gas pressure regulators	200
gas solenoid valves	147
gas taps	121
gas thermostats	128
gaskets for heated units	269
gaskets for tray rack trolleys	272
gaskets for wash arm support	280
grates	260
grub screws	298

**H**

halogen lamp	60
handle latches	239
heating cartridges	11
heating elements	3, 11
heating elements for bain maries	4
heating elements for charrills	10
heating elements for condensate evaporation	7
heating elements for convection	23
heating elements for defrosting	7
heating elements for fryers	5
heating elements for frying pans	4
heating elements for griddles	7
heating elements for heated trolleys	11
heating elements for ovens	3
heating elements for pasta cookers	9
heating elements for pizza ovens	9
heating elements for refrigeration	7

heating elements for salamanders/toasters	10	oven lamps	60
heating elements for tilting bratt pan	8		
hexagonal nuts	299	<b>P</b>	
hexagonal screws	298	piezoelectric igniters	163
hob burners	166	pilot burners	147
hose clamps	296, 300	plug connectors	120
hose connectors	290, 291	plug-in gaskets	263
hose reels	285	position switches	45
hoses	288	pressure control hoses	289
hot air fans	109	pressure hoses	290
hot air motors	104	pressure switches	96, 201
hot plates	27	probe clips	40
		probes	74
<b>I</b>		programme timers	62
ignition boxes	146	pumps	111
ignition cables	162	pumps for ice machines	118
ignition switches	164	push/momentary push switches	42
ignition units	163	PVC supply hoses	288
immersion heating elements	12		
indicator lights	57	<b>R</b>	
indicator lights (complete)	58	radial fans	109
induction coils	3	radiation heaters	26
industrial hoses	289	refrigeration cycle components	280
inlet spouts	294	refrigeration fans	102
inlet taps	294	refrigeration gaskets	263
		refrigeration motors universal	102
<b>K</b>		refrigeration pipes	280
knurled nuts	299	refrigeration thermostats	38
knurled screws	298	relays	68
		residual heat indicators	62
<b>L</b>		retaining rings	300
lamps	57	ring burners	189
light bulbs	59	rocker/momentary rocker switches	41
lubricants	301	roll pins	301
		rotary switches	53
<b>M</b>			
machine lubricants	301	<b>S</b>	
magnetic switches	53	safety bi-metal thermostats	29
measuring equipment	297	safety thermostats	34
mechanical timers	64	safety valves	147
microswitches	43	screw pipe fittings	295
motors	110	screw-in gaskets	268
		screws	298
<b>N</b>		sealing cords	278
neon light bulbs	58, 59	sealing washers	276
Niplaflex hoses	289	shaft gaskets	278
non-return valves	287, 296	shelves and shelf rails	260
nuts	299	shut-off valves	294
		slot nuts	300
<b>O</b>		snap locks	240
operating capacitors	118	solenoid valves	88
O-rings	273	solid state relays	68
oven hinges	243	spray guns	285



spring assisted hinges	242
spring clips	40
spring washers	299
stainless steel flexi hoses	288
standpipes	295
starting capacitors	118
supply filters	295, 295
supply hoses	288
switches and momentary switches	41
system switches (ROLD)	45

**T**

tank inlets	288
temperature probes	74
terminals	120
terminals and connectors	120
thermocouples	164
thermostat gaskets	280
thermostats	29
time relays	70
timers	62
tools	297
transformers	70
tube burners	189

**U**

universal hoses	288
universal probes	74

**V**

valves and tank inlets	291
vibration pumps	118

**W**

wash and rinse pumps	111
washers	300
water cycle components	295
window seals	269