



**GAS COMPONENTS**



**ELECTRIC COMPONENTS**



**WATER TECHNOLOGY**



**MECHANICAL COMPONENTS**



**TOOLS**

Spare parts suitable for

**ÖZTIRYAKILER**

Find the complete and up-to-date range of products in our GEV Webshop



# Manufacturer catalogue

The most important spare parts and accessories arranged clearly for every manufacturer

- ✓ Complete product range and all appliance data always up to date in the GEV Webshop
- ✓ Alphabetical Index at the end of the catalogue

## GEV Webshop

[www.gev-online.co.uk](http://www.gev-online.co.uk)

[www.gev-online.com](http://www.gev-online.com)



- 🔍 Add to Favourites
- 🔍 Sign In with email address and usual password
- 🔍 Easy-order – place several items in your basket at the same time
- 🔍 Quick Item search – no login needed



## heating elements

### heating elements for fryers

#### 8 hole fixing

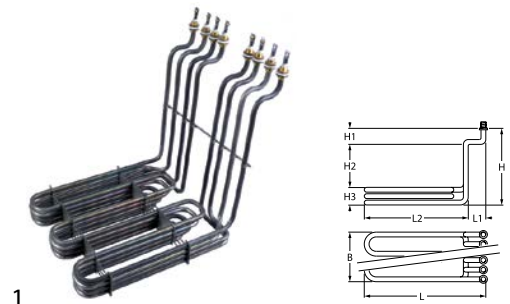

<b>GEV No.</b>	418859	<b>Ref. No.</b>	6246.00045.00 6246.00045.05 6246.00047.00
<b>description</b>	heating element 4x4500W 440V L 350mm W 255mm H 325mm 8 hole fixing connection M4 L1 50mm L2 300mm H1 40mm H2 235mm H3 45mm heating circuits 4 immersion heater tube ø 8.5mm fryer		

### heating elements for griddles



<b>GEV No.</b>	417624	<b>Ref. No.</b>	6246.00011.03
<b>description</b>	heating element 1500W 230V heating circuits 1 L 430mm W 100mm H 65mm tube ø 8.5mm		

### heating elements for contact grills



<b>GEV No.</b>	420474	<b>Ref. No.</b>	6246.00035.00
<b>description</b>	heating element 750W 230V heating circuits 1 L 165mm W 195mm H 30mm connection distance 20mm tube ø 6.5mm windings 1 connection M4 dry heating element for contact grill/waffle iron		

## immersion heating elements

### 3 hole flange ø47.5mm



<b>GEV No.</b>	417529	<b>Ref. No.</b>	6246.00001.03 6246.00006.00 6246.00006.03 9099.01000.06	
<b>description</b>	heating element 9000W 230V mounting ø 47.5mm heating circuits 3 L 440mm W 36mm H 31mm number of thermostat sleeves 1 thermostat sleeves ø 7mm length thermostat sleeves 255mm thermostat sleeve eccentric, clinging tube ø 8.5mm hole distance 61mm hole ø 10mm connection M4 3 hole flange immersion heater			
<b>For models:</b>	OBK1500			
<b>accessories for</b>	417529			
	<b>GEV No.</b>	510408	<b>Ref. No.</b>	6228.00001.22 6228.00001.26
	O-ring EPDM thickness 5.34mm ID ø 47mm Qty 1 pcs			

### with expansion flange 70 x 18mm



<b>GEV No.</b>	420366	<b>Ref. No.</b>	9099.01000.03
<b>description</b>	heating element 2000/2500W 230V heating circuits 2 flange 70x18mm L 418mm W 64mm connection M4 tube ø 8.5mm immersion heater expansion flange		

<b>GEV No.</b>	417717	<b>Ref. No.</b>	6246.00012.12 9099.01000.01
<b>description</b>	heating element 2950W 230V heating circuits 1 flange 70x18mm L 285mm W 70mm connection male faston 6.3mm tube ø 8.5mm immersion heater expansion flange		

### heating elements for convection



<b>GEV No.</b>	417622	<b>Ref. No.</b>	6246.00020.00
<b>description</b>	heating element 1500W 220V heating circuits 1 ID ø 198mm ED ø 210mm L 225mm H 35mm L1 8mm W1 30mm H1 13mm H2 20mm flange length 70mm flange width 22mm hole distance 56mm connection M4 tube ø 6.5mm convection heating element rectangular flange		



1

<b>GEV No.</b>	420544	<b>Ref. No.</b>	6246.00049.05 7AYS.00008.17 7AYS.00008.18
<b>description</b>	heating element 1500W 230V heating circuits 1 ID ø 195mm ED ø 208mm L 210mm H 30mm W1 30mm H1 10mm H2 18mm flange length 70mm flange width 22mm hole distance 56mm connection F6.3 connection length 20mm tube ø 6.5mm		

## radiation heaters



1

<b>GEV No.</b>	417647	<b>Ref. No.</b>	2859.M0012.00 6802.00001.110 6802.00001.114
<b>description</b>	radiation heater rectangular L 230mm W 158mm H 50mm heating circuits 1		

## foil heating elements



1

<b>GEV No.</b>	416371	<b>Ref. No.</b>	62460000806 7AYS0000902
<b>description</b>	foil heating element L 400mm W 290mm 1000W 230V t.max. 140°C with temperature limiter silicone cable length 2000mm thickness 1mm		

## accessories

## sealing washers

## O-rings

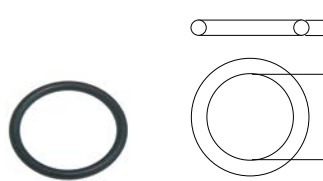

1

<b>GEV No.</b>	510408	<b>Ref. No.</b>	6228.00001.22 6228.00001.26
<b>description</b>	O-ring EPDM thickness 5.34mm ID ø 47mm Qty 1 pcs		

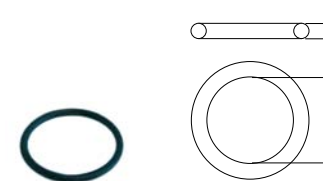

1

<b>GEV No.</b>	510409	<b>Ref. No.</b>	6228.00002.14
<b>description</b>	O-ring EPDM thickness 5.34mm ID ø 56.52mm Qty 1 pcs		

## hot plates

## round

## with radiused edge

## for domestic and commercial kitchens



1

<b>GEV No.</b>	490021	<b>Ref. No.</b>	6246.00013.02
<b>description</b>	hot plate ø 220mm 2600W 400V connection 4 screw clamps with 8mm spill ring		

## energy regulators

## EGO

## 1-circuit



1

<b>GEV No.</b>	380019	<b>Ref. No.</b>	6234.00001.11
<b>description</b>	energy regulator 240V 13A single-circuit turn direction right shaft ø 6x4.6mm shaft L 23mm mounting thread M4 power release 6-100% no. 50.57071.010		

## thermostats

### control and safety thermostats

EGO

control thermostats

55.34\_ series



<b>GEV No.</b>	390979	<b>Ref. No.</b>	6234.00001.37
<b>description</b>	thermostat t.max. 129°C temperature range 34-129°C 3-pole 3NO 16A probe ø 6mm probe L 140mm capillary pipe 2260mm capillary pipe isolated 120mm gland nut shaft ø 6x4.6mm shaft L 23mm shaft position upper rotation 270° outer switch probe material SS probe thread screw connection disc ømm		



<b>GEV No.</b>	375038	<b>Ref. No.</b>	6234.00001.14
<b>description</b>	thermostat t.max. 300°C temperature range 50-300°C 3-pole 3NO 16A probe ø 6mm probe L 79mm capillary pipe 1740mm capillary pipe isolated 800mm gland nut shaft ø 6x4.6mm shaft L 23mm shaft position upper rotation 270°		
<b>accessories for</b>	375038		
	<b>GEV No.</b>	110123	<b>Ref. No.</b>
	knob thermostat t.max. 300°C ø 50mm shaft ø 6x4.6mm shaft flat upper black temperature range 50-300°C rotation 270°		

safety thermostats

55.32\_ series

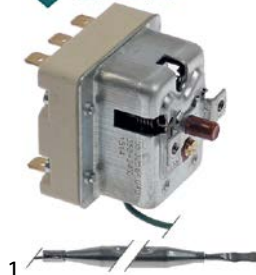

<b>GEV No.</b>	390141	<b>Ref. No.</b>	6234.00001.28
<b>description</b>	safety thermostat switch-off temp. 350°C 3-pole 3NC 20A probe ø 6mm probe L 77mm capillary pipe 1490mm capillary pipe isolated 800mm gland nut probe SS		

56\_ series



<b>GEV No.</b>	390714	<b>Ref. No.</b>	6234.00001.16 6234.00001.27
<b>description</b>	safety thermostat switch-off temp. 230°C 1-pole 1NC 16A probe ø 6mm probe L 75mm capillary pipe 740mm capillary pipe isolated 200mm gland nut probe SS		



<b>GEV No.</b>	375973	<b>Ref. No.</b>	6234.00001.26
<b>description</b>	safety thermostat switch-off temp. 365°C 1-pole 20A probe ø 3.1mm probe L 160mm capillary pipe 910mm capillary pipe isolatedmm gland nut probe SS		

TECASA

control thermostats

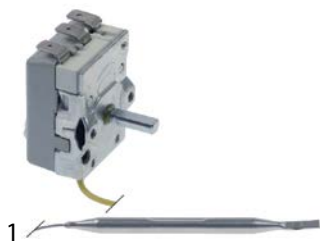

<b>GEV No.</b>	390927	<b>Ref. No.</b>	6234.00001.080
<b>description</b>	thermostat t.max. 110°C temperature range 30-110°C 1-pole 1CO 16A probe ø 6mm probe L 91mm capillary pipe 880mm capillary pipe isolated 850mm gland nut shaft ø 6x4.6mm shaft L 18mm shaft position upper rotation 270° 400V		
<b>For models:</b>	OBK1500		



<b>GEV No.</b>	375472	<b>Ref. No.</b>	6234.00001.17 6234.00001.40
<b>description</b>	thermostat t.max. 190°C temperature range 60-180°C 1-pole 1NO 16A probe ø 6mm probe L 70mm capillary pipe 2000mm capillary pipe isolated 490mm gland nut shaft ø 6x4.6mm shaft L 23mm shaft position lower° rotation 270° probe material SS		

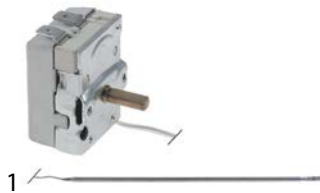

<b>GEV No.</b>	375909	<b>Ref. No.</b>	6234.00001.05
<b>description</b>	thermostat t.max. 300°C temperature range 50-300°C 1-pole 1NO 16A probe ø 3mm probe L 165mm capillary pipe 870mm capillary pipe isolatedmm gland nut shaft ø 6x4.6mm shaft L 23mm shaft position upper rotation 270°		

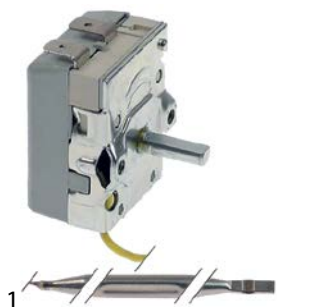

<b>GEV No.</b>	390980	<b>Ref. No.</b>	6234.00001.18 6234.00001.42
<b>description</b>	thermostat t.max. 90°C temperature range 30-90°C 1-pole 1NO 16A probe ø 6mm probe L 95mm capillary pipe 1550mm capillary pipe isolated 1500mm gland nut shaft ø 6x4.6mm shaft L 16mm shaft position° shaft position upper rotation 270° outer switch probe material SS probe thread disc ømm screw connection		

safety thermostats

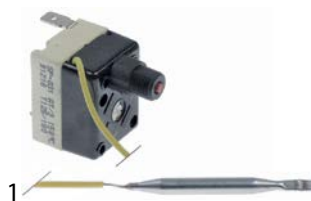

<b>GEV No.</b>	390796	<b>Ref. No.</b>	6234.00001.04 6234.00001.21
<b>description</b>	safety thermostat switch-off temp. 150°C 1-pole 1NC 16A probe ø 6mm probe L 65mm capillary pipe 1480mm capillary pipe isolated 1450mm		
<b>For models:</b>	OBK1500		



<b>GEV No.</b>	376000	<b>Ref. No.</b>	6234.00001.41
<b>description</b>	safety thermostat switch-off temp. 230°C 1-pole 1NO 16A probe ø 6mm probe L 58mm capillary pipe 2000mm capillary pipe isolated 490mm gland nut probe SS		

various

control thermostats

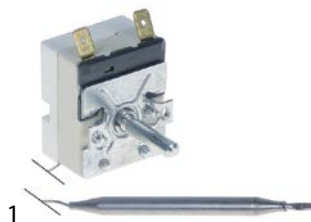

<b>GEV No.</b>	390744	<b>Ref. No.</b>	6234.00001.34 6234.00001.40
<b>description</b>	thermostat t.max. 190°C temperature range 60-190°C 1-pole 1NO probe ø 6mm probe L 69mm capillary pipe 2040mm shaft ø 6x4.6mm shaft L 26mm shaft position upper rotation 270° probe material SS		

refrigeration thermostats

RANCO

K50 series



<b>GEV No.</b>	390546	<b>Ref. No.</b>	6268.00013.01 7AYS0000228
<b>description</b>	thermostat RANCO type K50P1127 probe ømm probe Lmm capillary pipe 1200mm temperature range +1.5 up to +12.5°C		



## switches and momentary switches

### rocker/momentary rocker switches

30x22mm



1

<b>GEV No.</b>	301003	<b>Ref. No.</b>	62320001900
<b>description</b>	rocker switch mounting measurements 30x22mm green 2NO 250V 16A illuminated 0-1 connection male faston 6.3mm ambient temperature max. 125/55°C protection IP65		
<b>accessories for</b>	301003		
	<b>GEV No.</b>	301036	<b>Ref. No.</b> —
	protective cover internal size 30x22mm for rocker switch mounting measurementsmm		



1

<b>GEV No.</b>	301251	<b>Ref. No.</b>	6232.00001.21 7AYS0000136
<b>description</b>	rocker switch mounting measurements 30x22mm green 2NO 250V 16A illuminated lighting connection male faston 6.3mm ambient temperature max. 85°C protection IP40		

ø20mm



1

<b>GEV No.</b>	348204	<b>Ref. No.</b>	6232.00011.01 6232.00011.27
<b>description</b>	rocker switch mounting measurements 20mm green 1CO 250V 4A 0-1		



1

<b>GEV No.</b>	348203	<b>Ref. No.</b>	6232.00011.00 6232.00011.28
<b>description</b>	rocker switch mounting measurements 20mm orange 1CO 250V 4A 0-1		

### toggle switches

M12x1



1

<b>GEV No.</b>	347340	<b>Ref. No.</b>	6232.00020.01
<b>description</b>	toggle switch thread M12x1 1NO 250V 15A ON-OFF screw		

### position switches

PIZZATO

FR series



1

<b>GEV No.</b>	345181	<b>Ref. No.</b>	6232.00010.33
<b>description</b>	position switch plastic 1NC/1NO 400V 3A L 92mm W 31mm H 31mm protection IP67 actuating force: 450g screw connection PG13.5 mounting distance 22mm screw		

### miscellaneous



1



<b>GEV No.</b>	347962	<b>Ref. No.</b>	6232.00006.00
<b>description</b>	position switch 1NO/1NC L 68mm W 30mm H 24mm		
<b>For models:</b>	OM10G, OM20G, OM40G, OM60G, PSM10, PSM20, PSM30		

### cam switches

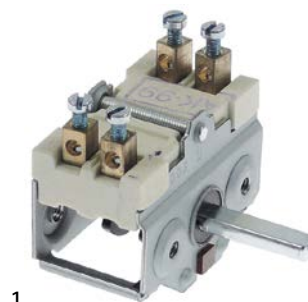
on/off



1

<b>GEV No.</b>	300020	<b>Ref. No.</b>	6254.00005.03
<b>description</b>	cam switch 4 operating positions 2NO sequence 0-1-0-1 16A shaft ø 6x4.6mm shaft L 23mm connection screw ceramic		
<b>accessories for</b>	300020		
	<b>GEV No.</b>	110135	<b>Ref. No.</b> —
	rosette knob up to ø 52mm		
	<b>GEV No.</b>	110231	<b>Ref. No.</b> —
	knob switch 0-1-0-1 t.max.°C°C ø 50mm shaft ø 6x4.6mm shaft flat upper black		



7-position



1

<b>GEV No.</b>	300106	<b>Ref. No.</b>	6254.00005.00
<b>description</b>	cam switch 7 operating positions 1NO/2CO sequence 0-1-2-3-4-5-6 32A shaft ø 6x4.6mm shaft L 23mm connection screw 7-position shaft flat upper		

operation switches



1

<b>GEV No.</b>	300002	<b>Ref. No.</b>	6254.00005.04
<b>description</b>	cam switch 2 operating positions 4NO 16A sequence 0-1 shaft ø 6x4.6mm shaft L 23mm connection male faston 6.3mm ceramic		

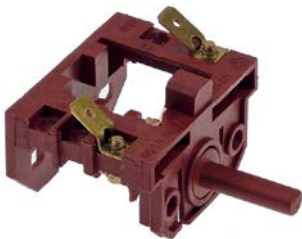

1

<b>GEV No.</b>	300257	<b>Ref. No.</b>	6232.00024.10
<b>description</b>	operation switch 16A sequence 0-1 shaft ø 6x4.6mm shaft L 22mm connection male faston 6.3mm		

magnetic switches

miscellaneous



1

<b>GEV No.</b>	347961	<b>Ref. No.</b>	6232.00005.10
<b>description</b>	magnetic switch 250V 3A P max. 750W 1NO connection cable L 12mm cable length 1000mm L1 37mm mounting measurements 58x13mm H 9mm mounting distance 49.5mm voltage AC nominal 5A		
<b>For models:</b>	OBK1500		
<b>accessories for</b>	347961		
	<b>GEV No.</b>	699294	<b>Ref. No.</b>
	magnet ø 20.8mm H 12.5mm ID ø 5mm with screw		

accessories

magnets



1

<b>GEV No.</b>	699294	<b>Ref. No.</b>	621300002.03+626200004.01 6232.00004.17 siehe bemerkung
<b>description</b>	magnet ø 20.8mm H 12.5mm ID ø 5mm with screw		
<b>For models:</b>	OBK1500		

control equipment

MOELLER/EATON

push buttons - signal lamps



1

<b>GEV No.</b>	346272	<b>Ref. No.</b>	6232.00012.08
<b>description</b>	push button mounting measurements ø22mm green		

switch blocks



1

<b>GEV No.</b>	346292	<b>Ref. No.</b>	6232.00012.05
<b>description</b>	contact block screw 1NO		



1

<b>GEV No.</b>	346293	<b>Ref. No.</b>	6232.00012.07
<b>description</b>	contact block holder triple		

LED signal elements



1

<b>GEV No.</b>	348202	<b>Ref. No.</b>	6232.00012.04
<b>description</b>	indicator lamp yellow connection screw LED 85-264VAC		





miscellaneous

			
1			
<b>GEV No.</b>	347964	<b>Ref. No.</b>	6232.00003.02
<b>description</b>	momentary push switch mounting measurements ø22mm green 1NO 10A 1-pole SMCX		
<b>For models:</b>	OM10G, OM20G, OM40G, OM60G, PSM10, PSM20, PSM30		

			
1			
<b>GEV No.</b>	347963	<b>Ref. No.</b>	6232.00003.05 6232.00003.06
<b>description</b>	momentary push switch mounting measurements ø22mm red 1NC 10A 1-pole SMCX		
<b>For models:</b>	OM10G, OM20G, OM40G, OM60G, PSM10, PSM20, PSM30		

encoders and potentiometers

			
1			
<b>GEV No.</b>	403313	<b>Ref. No.</b>	6229.00034.09
<b>description</b>	potentiometer 2.5KOhm cable length 130mm L 44mm ø 22.5mm		
<b>For models:</b>	OM10G		

lamps

indicator lights

indicator lights (complete)

ø10mm

with screw socket

			
1			
<b>GEV No.</b>	360649	<b>Ref. No.</b>	6251.00004.10
<b>description</b>	indicator light ø 10mm green 240V cable length 300mm		

			
1			
<b>GEV No.</b>	360652	<b>Ref. No.</b>	6251.00004.07
<b>description</b>	indicator light ø 10mm red 240V connection cable 300mm cable length 300mm		

30x22mm			
			
1			
<b>GEV No.</b>	359302	<b>Ref. No.</b>	6232.00001.22 7AYS0000226
<b>description</b>	indicator light mounting measurements 30x22mm yellow 240V temp.-resist. 120°C		

fluorescent lamps

fluorescent lamps

complete with holder

			
1			
<b>GEV No.</b>	359481	<b>Ref. No.</b>	6250.00001.35 7AYS0000232
<b>description</b>	fluorescent lamp L 1204mm 28W 230V		

oven lamps

universal oven lamps

mounting diameter 35.5mm

				
1				
<b>GEV No.</b>	359718	<b>Ref. No.</b>	62600016006	
<b>description</b>	oven lamp mounting ø 35.5mm 230V 15W socket E14 temp.-resist. 300°C connection male faston 6.3mm hard glas			
<b>spare parts for</b>	359718			
	<b>GEV No.</b>	359701	<b>Ref. No.</b>	—
	<b>description</b>	lamp socket socket E14 220-230V mounting ø 35.5mm connection male faston 6.3mm 15W		
	<b>GEV No.</b>	359740	<b>Ref. No.</b>	—
	<b>description</b>	light bulb t.max. 300°C socket E14 15W 230V ø 22mm L 48mm lens L 20mm for oven lamp IMPORT		

timers

mechanical timers

			
1			
<b>GEV No.</b>	350204 <sup>1</sup>	<b>Ref. No.</b>	6259.00002.00
<b>description</b>	timer 600 2-pole operation time 4min impulse mechanical 2NO at 250V 16A permanent position no shaft ø 6x4.6mm shaft 6x4.6mm shaft L 21mm mounting distance 28mm connection male faston 6.3mm		
<b>For models:</b>	PSM10, PSM20, PSM30		

<sup>1</sup>incl. knob and symbol



			
1			
<b>GEV No.</b>	350205	<b>Ref. No.</b>	6259.00002.05
<b>description</b>	timer M11 with bell 1-pole operation time 90min impulse mechanical 1NO at 250V 16A permanent position yes shaft $\varnothing$ 6x4.6mm shaft 6x4.6mm shaft L 25mm mounting distance 28mm mounting thread M4 connection male faston 6.3mm		
<b>For models:</b>	OM20G, OM40G, OM60G		

			
MOELLER/EATON			
power contactors			
1			
<b>GEV No.</b>	380171	<b>Ref. No.</b>	6230.00014.12
<b>description</b>	power contactor resistive load 20A 230VAC (AC3/400V) 9A/4kW main contacts 3NO auxiliary contacts 1NO connection screw connection type DILEM 10		

**contactors**

			
LS Industrial Systems			
power contactors			
1			
<b>GEV No.</b>	380877	<b>Ref. No.</b>	6230.00014.06
<b>description</b>	power contactor resistive load 60A 230VAC (AC3/400V) 40A/18.5kW main contacts 3NO auxiliary contacts 2NO/2NC connection screw connection type GMC-40		



**relays**

			
power relays			
with male contacts			
bullet connectors, 11 contacts			
1			
<b>GEV No.</b>	380132	<b>Ref. No.</b>	6231.00023.12
<b>description</b>	power relays Italiana Relè 230VAC 10A 3CO connection plug-in connection round 11-pole manif. no. C43-230AC ZVE11 250V 11-pole		
<b>For models:</b>	OBK1500		
<b>accessories for</b>	380132		
	<b>GEV No.</b>	380136	<b>Ref. No.</b> —
	 relay socket 11-pole connection plug-in connection round 11-pole dimensions 65x28x40mm 250V voltage AC 10A Italiana Relè manif. no. ZVE11		

**overload switches**

			
1			
<b>GEV No.</b>	381200	<b>Ref. No.</b>	6231.00001.00
<b>description</b>	motor protection circuit breaker setting range 1.6-2.5A type GTK-12M LS Industrial Systems		
<b>For models:</b>	PSM10		

**plug-in/print relays**

			
1			
<b>GEV No.</b>	380333	<b>Ref. No.</b>	6231.00020.02 6231.00023.15 6231.00025.07
<b>description</b>	print relay 230VAC 2CO at 250V 8A connection pins raster size 5mm FINDER manif. no. 40.52.8.230.0000 95.65/95.75		
<b>For models:</b>	OBK1500		
<b>accessories for</b>	380333		
	<b>GEV No.</b>	380340	<b>Ref. No.</b> —
	 relay socket dimensions 62x36x15mm 250V voltage AC 10A Italiana Relè manif. no. ZMEM/5		

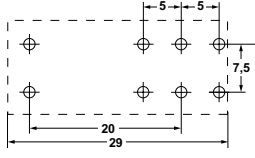





Table continues overleaf



<b>accessories for</b> 380333									
	<table border="1"> <tr> <th>GEV No.</th> <th>380505</th> <th>Ref. No.</th> <th>—</th> </tr> <tr> <td colspan="4">relay socket 2CO 40.52 dimensions 81.9x15.5x75mm 250V voltage AC 10A FINDER manuf. no. 95.95.3</td> </tr> </table>	GEV No.	380505	Ref. No.	—	relay socket 2CO 40.52 dimensions 81.9x15.5x75mm 250V voltage AC 10A FINDER manuf. no. 95.95.3			
GEV No.	380505	Ref. No.	—						
relay socket 2CO 40.52 dimensions 81.9x15.5x75mm 250V voltage AC 10A FINDER manuf. no. 95.95.3									
	<table border="1"> <tr> <th>GEV No.</th> <th>381181</th> <th>Ref. No.</th> <th>—</th> </tr> <tr> <td colspan="4">relay socket 2-pole 40.51/40.52/40.61 connection screw clamp dimensions 15.8x78.6mm 250V voltage AC 10A FINDER manuf. no. 95.75</td> </tr> </table>	GEV No.	381181	Ref. No.	—	relay socket 2-pole 40.51/40.52/40.61 connection screw clamp dimensions 15.8x78.6mm 250V voltage AC 10A FINDER manuf. no. 95.75			
GEV No.	381181	Ref. No.	—						
relay socket 2-pole 40.51/40.52/40.61 connection screw clamp dimensions 15.8x78.6mm 250V voltage AC 10A FINDER manuf. no. 95.75									

time relays

time relays

 <p>1</p>			
<b>GEV No.</b>	381201	<b>Ref. No.</b>	6231.00019.07
<b>description</b>	time relay INTER RR-W03D time range 0.1-3min 12/24VAC/DC-230VAC 5A connection screw clamp mounting measurements DIN railmm		
<b>For models:</b>	OBK1500		



 <p>Image not available</p> <p>1</p>			
<b>GEV No.</b>	381541	<b>Ref. No.</b>	6231.00019.05 6231.00019.22 RR-5T RR-W5TB
<b>description</b>	time relay INTER RR-W5TB connection grip connection		







electronic controllers

DIXELL

refrigeration controllers

built-in version

 <p>1</p>									
<b>GEV No.</b>	378256	<b>Ref. No.</b>	6234.00009.18 7AYS0000700						
<b>description</b>	electronic controller DIXELL XR02CX-5N0C0 mounting measurements 71x29mm built-in depth 56mm 230V voltage AC NTC relay outputs 1 CO-8A(4) NTC protection IP54 defrosting function/time control -40 up to +110°C display 2½ digit								
<b>spare parts for</b>	378256								
	<table border="1"> <tr> <th>GEV No.</th> <th>379161</th> <th>Ref. No.</th> <th>—</th> </tr> <tr> <td colspan="4">temperature probe NTC 10kOhm cable thermoplastic probe -40 up to +110°C cable -40 up to +110°C probe ø6x14mm cable length 3m without screw connection 2-wire</td> </tr> </table>	GEV No.	379161	Ref. No.	—	temperature probe NTC 10kOhm cable thermoplastic probe -40 up to +110°C cable -40 up to +110°C probe ø6x14mm cable length 3m without screw connection 2-wire			
GEV No.	379161	Ref. No.	—						
temperature probe NTC 10kOhm cable thermoplastic probe -40 up to +110°C cable -40 up to +110°C probe ø6x14mm cable length 3m without screw connection 2-wire									

<b>accessories for</b> 378256									
	<table border="1"> <tr> <th>GEV No.</th> <th>378194</th> <th>Ref. No.</th> <th>—</th> </tr> <tr> <td colspan="4">temperature probe NTC 10kOhm cable PVC probe -20 up to +80°C cable -10 up to 100°C probe ø7x24.5mm cable length 1.5m without screw connection 2-wire</td> </tr> </table>	GEV No.	378194	Ref. No.	—	temperature probe NTC 10kOhm cable PVC probe -20 up to +80°C cable -10 up to 100°C probe ø7x24.5mm cable length 1.5m without screw connection 2-wire			
GEV No.	378194	Ref. No.	—						
temperature probe NTC 10kOhm cable PVC probe -20 up to +80°C cable -10 up to 100°C probe ø7x24.5mm cable length 1.5m without screw connection 2-wire									
	<table border="1"> <tr> <th>GEV No.</th> <th>379057</th> <th>Ref. No.</th> <th>—</th> </tr> <tr> <td colspan="4">temperature probe NTC 10kOhm cable PVC probe -20 up to +80°C cable -10 up to 100°C probe ø6x25mm cable length 3m 2-wire</td> </tr> </table>	GEV No.	379057	Ref. No.	—	temperature probe NTC 10kOhm cable PVC probe -20 up to +80°C cable -10 up to 100°C probe ø6x25mm cable length 3m 2-wire			
GEV No.	379057	Ref. No.	—						
temperature probe NTC 10kOhm cable PVC probe -20 up to +80°C cable -10 up to 100°C probe ø6x25mm cable length 3m 2-wire									
	<table border="1"> <tr> <th>GEV No.</th> <th>379160</th> <th>Ref. No.</th> <th>6234.00004.06</th> </tr> <tr> <td colspan="4">temperature probe NTC 10kOhm cable thermoplastic probe -40 up to +110°C cable -40 up to +110°C probe ø6x14mm cable length 1.5m without screw connection 2-wire</td> </tr> </table>	GEV No.	379160	Ref. No.	6234.00004.06	temperature probe NTC 10kOhm cable thermoplastic probe -40 up to +110°C cable -40 up to +110°C probe ø6x14mm cable length 1.5m without screw connection 2-wire			
GEV No.	379160	Ref. No.	6234.00004.06						
temperature probe NTC 10kOhm cable thermoplastic probe -40 up to +110°C cable -40 up to +110°C probe ø6x14mm cable length 1.5m without screw connection 2-wire									
	<table border="1"> <tr> <th>GEV No.</th> <th>379161</th> <th>Ref. No.</th> <th>—</th> </tr> <tr> <td colspan="4">temperature probe NTC 10kOhm cable thermoplastic probe -40 up to +110°C cable -40 up to +110°C probe ø6x14mm cable length 3m without screw connection 2-wire</td> </tr> </table>	GEV No.	379161	Ref. No.	—	temperature probe NTC 10kOhm cable thermoplastic probe -40 up to +110°C cable -40 up to +110°C probe ø6x14mm cable length 3m without screw connection 2-wire			
GEV No.	379161	Ref. No.	—						
temperature probe NTC 10kOhm cable thermoplastic probe -40 up to +110°C cable -40 up to +110°C probe ø6x14mm cable length 3m without screw connection 2-wire									
	<table border="1"> <tr> <th>GEV No.</th> <th>379343</th> <th>Ref. No.</th> <th>—</th> </tr> <tr> <td colspan="4">temperature probe NTC 10kOhm cable silicone probe -40 up to +110°C cable -50 up to +180°C probe ø6x40mm cable length 3m 2-wire</td> </tr> </table>	GEV No.	379343	Ref. No.	—	temperature probe NTC 10kOhm cable silicone probe -40 up to +110°C cable -50 up to +180°C probe ø6x40mm cable length 3m 2-wire			
GEV No.	379343	Ref. No.	—						
temperature probe NTC 10kOhm cable silicone probe -40 up to +110°C cable -50 up to +180°C probe ø6x40mm cable length 3m 2-wire									
	<table border="1"> <tr> <th>GEV No.</th> <th>379458</th> <th>Ref. No.</th> <th>—</th> </tr> <tr> <td colspan="4">temperature probe NTC 10kOhm cable silicone probe -40 up to +110°C cable -50 up to +180°C probe ø6x40mm cable length 1.5m without screw connection 2-wire</td> </tr> </table>	GEV No.	379458	Ref. No.	—	temperature probe NTC 10kOhm cable silicone probe -40 up to +110°C cable -50 up to +180°C probe ø6x40mm cable length 1.5m without screw connection 2-wire			
GEV No.	379458	Ref. No.	—						
temperature probe NTC 10kOhm cable silicone probe -40 up to +110°C cable -50 up to +180°C probe ø6x40mm cable length 1.5m without screw connection 2-wire									

electronic thermometers

built-in version

 <p>1</p>			
<b>GEV No.</b>	378257	<b>Ref. No.</b>	6234.00009.19 7AYS0000703
<b>description</b>	thermometer DIXELL XT11S-500 mounting measurements 58x25.5mm 230V voltage AC NTC -40 up to +110°C display 3 digits 1 Templn1 NTC DigiIn1 defr. funct.		



## EVCO - EVERY CONTROL

### refrigeration controllers

#### built-in version

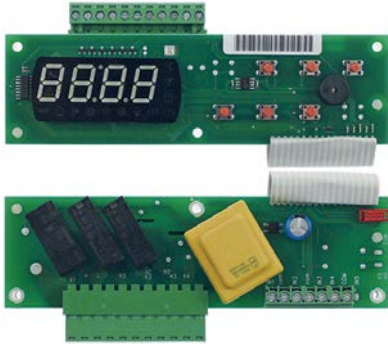

<b>GEV No.</b>	381444	<b>Ref. No.</b>	6234.00009.27
<b>description</b>	electronic controller EVCO type EVX003N7XXBXX02 mounting measurements 155x45mm 230V voltage AC NTC relay outputs 4 NO-16A(5) NO-16A NO-16A NTC(PTC) NTC(PTC) for fridge front measurementsmm built-in depth 56mm protection IP00 yes -40 up to +99°C display 4 digits		

## probes

### universal probes

#### temperature probes



<b>GEV No.</b>	379160	<b>Ref. No.</b>	6234.00004.06
<b>description</b>	temperature probe NTC 10kOhm cable thermoplastic probe -40 up to +110°C cable -40 up to +110°C probe ø6x14mm cable length 1.5m without screw connection 2-wire		
<b>For models:</b>	7919.06LMV.00, 7919.06NMV.00, 7919.12LMV.00, 7919.12NMV.00, 7919.27LMV.00, 7919.27NMV.00, 7919.37LMV.00, 7919.37NMV.00		

### producer-specific probes

#### probes



<b>GEV No.</b>	378515	<b>Ref. No.</b>	6234.00005.03
<b>description</b>	temperature probe thermocouple J (Fe-CuNi) cable Vetrotex probe -50 up to +750°C cable -50 up to +350°C connection 2-wire thread M6 probe ø4x65mm cable length 0.97m		

## electronics

### PCBs



<b>GEV No.</b>	404025	<b>Ref. No.</b>	6234.00009.50
<b>description</b>	control PCB freezer V13.06 L 156mm edition WC3LDL0TC1701 H 44mm buttons 6 ELIWELL		
<b>For models:</b>	7919.06LMV.00, 7919.06NMV.00, 7919.27LMV.00, 7919.27NMV.00, 7919.37NMV.00		

## keypads

### front foils



<b>GEV No.</b>	531271	<b>Ref. No.</b>	6800.00001.24
<b>description</b>	keypad foil refrigerator 791912MV/791927 L 170mm W 65mm buttons 6		
<b>For models:</b>	7919.12LMV.00, 7919.12NMV.00, 7919.27LMV.00, 7919.27NMV.00, 7919.37LMV.00, 7919.37NMV.00		

## solenoid valves

### solenoid valves (water)

#### ELTEK



<b>GEV No.</b>	370750	<b>Ref. No.</b>	6262.00008.00
<b>description</b>	solenoid valve single straight 230VAC inlet 3/4" outlet 11.5mm DN10 t.max. 90°C ELTEK plastic flow regulating valve inlet blue		
<b>For models:</b>	OBK1500		



## pressure switches

for warewashing

ø 58mm with coded plug



1

<b>GEV No.</b>	542365	<b>Ref. No.</b>	6262.00007.00
<b>description</b>	pressure control pressure range 85/65mbar connection 6mm ø 58mm		

## fans

refrigeration fans

refrigeration motors universal

ELCO

N series - standard



1

<b>GEV No.</b>	601930	<b>Ref. No.</b>	6268.00008.06
<b>description</b>	fan motor ELCO 10W 230V 50/60Hz bearing slide bearing L1 55.5mm L2 91.5mm L3 119mm W 83mm cable length 2000mm 1300/1550rpm 5 mounting options VN10-20/929		
<b>For models:</b>	7919.06LMV.00, 7919.12LMV.00, 7919.12NMV.00, 7919.27LMV.00, 7919.27NMV.00, 7919.37LMV.00, 7919.37NMV.00		
<b>spare parts for</b>	601930		
	<b>GEV No.</b>	601284	<b>Ref. No.</b> —
	fan wheel sucking ø 254mm fan wheel mounting 25.4mm blade angle 28° W 42mm aluminium		

miscellaneous



1

<b>GEV No.</b>	602005	<b>Ref. No.</b>	6268.00008.05
<b>description</b>	fan motor 5W 230V 50/60Hz bearing slide bearing L1 40mm L2 59.6mm L3 74.2mm W 83mm connection cable 500mm cable length 500mm 1300/1550rpm 3 mounting options		
<b>For models:</b>	7919.06NMV.00		

## hot air motors



1

<b>GEV No.</b>	601503	<b>Ref. No.</b>	5FIR.35011.12
<b>description</b>	fan wheel D1 ø 350mm H1 125mm blades 12 D2 ø 13mm D3 ø 16mm		
<b>accessories for</b>	601503		
	<b>GEV No.</b>	500505	<b>Ref. No.</b> —
	fan motor 220-240/380-415V 3 phase 50/60Hz 0.16-0.26kW 1440/1700rpm speeds 2 L1 140mm L2 27mm L3 35mm M10R IT 1.2/0.7A Cos(φ) 0.63 type L7zAw4D-014 D1 ø 17mm D2 ø 13mm		

## hot air fans

miscellaneous



1

<b>GEV No.</b>	602133	<b>Ref. No.</b>	6252.00072.09 7AYS.00008.09
<b>description</b>	fan 220/240V 38W L1 67mm L2 3mm L3 8mm L4 86mm fan wheel ø 85mm ROTTECH type SP-25-AF001 50/60Hz		



1

<b>GEV No.</b>	602032	<b>Ref. No.</b>	6252.00072.10
<b>description</b>	fan motor 220-240V 38W 1600rpm L1 72mm L2mm L3mm L4 86mm		



## motors

### gear motors

for dishwashers



<b>GEV No.</b>	601874	<b>Ref. No.</b>	6262.00015.00
<b>description</b>	gear motor AKSAN type AKWDKS 250W 380V voltage AC 50/60Hz 20rpm shaft ø 25mm L 370mm W 140mm H 235mm for dishwasher		
<b>For models:</b>	OBK1500		

## pumps





### wash and rinse pumps

LGB



<b>GEV No.</b>	499132	<b>Ref. No.</b>	9099.ZF121.00
<b>description</b>	pump inlet ø 28mm outlet ø 26mm type ZF121SX 230V 50Hz 1 phase 0.11kW 0.15HP L 195mm rotation direction right capacitor 6.3µF LGB		
<b>spare parts for</b>	499132		
	<b>GEV No.</b>	365012	<b>Ref. No.</b> —
	operating capacitor capacity 6.3µF 450V tolerance 5% 50Hz ambient temperature max. -25 to +85°C ø 30mm L 61mm M8 plastic connection male faston 6.3mm protection		
	<b>GEV No.</b>	510703	<b>Ref. No.</b> —
	mechanical shaft seal for shaft ø 13mm slide ring H 13mm height counter ring 5.5mm ED ø 26mm		
	<b>GEV No.</b>	521057	<b>Ref. No.</b> —
	pump cover LGB inlet ø 28mm outlet ø 26mm auxiliary pressure connection 12mm supporting pressure open turn direction right ø 102mm ID ø 77mm inner height 31mm		
	<b>GEV No.</b>	521085	<b>Ref. No.</b> —
	impellor ø 72mm H 17mm thread M7L shaft ø 13mm shaft length 12mm blades 3		
	<b>GEV No.</b>	528800	<b>Ref. No.</b> —
	O-ring EPDM thickness 2.62mm ID ø 75.87mm Qty 1 pcs		



<b>GEV No.</b>	499306	<b>Ref. No.</b>	9099.ZF650.00
<b>description</b>	pump inlet ø 50mm outlet ø 48mm type ZF650SX 230V 50Hz 1 phase 1.47kW L 340mm rotation direction right LGB		
<b>For models:</b>	OBK1500		
<b>spare parts for</b>	499306		
	<b>GEV No.</b>	365019	<b>Ref. No.</b> —
	operating capacitor capacity 20µF 400V tolerance 5% 50/60Hz ambient temperature max. -25 to +85°C ø 39.5mm L 70mm M8 plastic connection male faston 6.3mm 16.10.25. protection		
	<b>GEV No.</b>	510551	<b>Ref. No.</b> —
	pump cover gasket ID ø 158.3mm pump type 1214/1293/1225/2243/1226/1204/3473/1241 thickness 3.53mm EPDM Qty 1 pcs		
	<b>GEV No.</b>	510694	<b>Ref. No.</b> —
	mechanical shaft seal for shaft ø 13mm height counter ring 8mm ID ø 11.5mm H 16mm mounting ø 24/26mm int. ø 1 14mm		
	<b>GEV No.</b>	521108	<b>Ref. No.</b> —
	pump cover LGB inlet ø 50mm outlet ø 50mm auxiliary pressure connection 12mm		
	<b>GEV No.</b>	521240	<b>Ref. No.</b> —
	impellor ø 110mm H 32mm rotation direction left thread M8L shaft ø 20mm shaft length 10mm seat ø 8.2mm blades 6		

### booster pumps I



<b>GEV No.</b>	500540	<b>Ref. No.</b>	6262.00012.01
<b>description</b>	pump inlet ø 1" IT outlet ø 1" IT type PKM60 230V 50Hz 1 phase 0.37kW PEDRELLO 0.5HP		
<b>For models:</b>	OBK1500		
<b>accessories for</b>	500540		
	<b>GEV No.</b>	365015	<b>Ref. No.</b> —
	operating capacitor capacity 10µF 400V tolerance 5%Hz ambient temperature max. -25 to +85°C ø 35.5mm L 59mm M8 plastic connection male faston 6.3mm protection		



drain pumps

ASKOLL



1

<b>GEV No.</b>	499349	<b>Ref. No.</b>	6262.00016.00
<b>description</b>	drain pump 40W 220-240V inlet ø 30mm outlet ø 24mm 50Hz ASKOLL type M231 XP		



1

<b>GEV No.</b>	499315	<b>Ref. No.</b>	6262.00016.00
<b>description</b>	drain pump inlet ø 24/30/35/39mm outlet ø 22/31mm 230V 40W 50Hz ASKOLL type M231 XP kit		

gas taps





PEL

20S series



1

<b>GEV No.</b>	101094	<b>Ref. No.</b>	9GEV.10109.40 9PEL.10109.40
<b>description</b>	gas tap PEL type 20S gas inlet M16x1.5 (tube ø 10mm) bypass nozzle ø 0.35mm gas outlet M16x1.5 (tube ø 10/8mm) thermocouple connection M8x1 pilot connection shaft ø 8x6.5mm shaft L 22/15mm shaft flat lower		
<b>spare parts for</b>	101094		
	<b>GEV No.</b>	100408	<b>Ref. No.</b> —
	bypass nozzle type PEL20/21 bore ø 0.35mm thread M5x0.5		
	<b>GEV No.</b>	101060	<b>Ref. No.</b> —
	magnet unit standard L 39mm D1 ø 15.4mm D2 ø 11mm suitable for PEL20-21/JUNKERS/EGA		
	<b>GEV No.</b>	101205	<b>Ref. No.</b> —
	gas tap front part shaft ø 8x6.5mm shaft L 22/15mm shaft flat upper/lower suitable for PEL20		
	<b>GEV No.</b>	101230	<b>Ref. No.</b> —
	thermocouple nut T1: M8x1 T2: M18x1 aluminium		
<b>accessories for</b>	101094		
	<b>GEV No.</b>	101278	<b>Ref. No.</b> —
	olive for pipe ø 10mm Qty 1 pcs		

<b>accessories for</b>	101094		
	<b>GEV No.</b>	101300	<b>Ref. No.</b> —
	union nut thread M16x1.5 tube ø 10mm		
	<b>GEV No.</b>	101450	<b>Ref. No.</b> —
	olive for pipe ø 8mm L 12.7mm Qty 1 pcs ED ø 10mm		
	<b>GEV No.</b>	101451	<b>Ref. No.</b> —
	union nut thread M16x1.5 tube ø 8mm		
	<b>GEV No.</b>	110081	<b>Ref. No.</b> —
	knob ø 70mm shaft ø 8x6.5mm shaft flat universal		
	<b>GEV No.</b>	110083	<b>Ref. No.</b> —
	knob dial plate gas tap without ignition flame silver		

21S series



1







<b>GEV No.</b>	101095	<b>Ref. No.</b>	9PEL.10109.50
<b>description</b>	gas tap PEL type 21S gas inlet M16x1.5 (tube ø 10mm) bypass nozzle ø 0.35mm gas outlet M16x1.5 (tube ø 10/8mm) thermocouple connection M8x1 pilot connection M10x1 shaft ø 8x6.5mm shaft L 22/15mm shaft flat lower		
<b>spare parts for</b>	101095		
	<b>GEV No.</b>	100408	<b>Ref. No.</b> —
	bypass nozzle type PEL20/21 bore ø 0.35mm thread M5x0.5		
	<b>GEV No.</b>	101060	<b>Ref. No.</b> —
	magnet unit standard L 39mm D1 ø 15.4mm D2 ø 11mm suitable for PEL20-21/JUNKERS/EGA		
	<b>GEV No.</b>	101206	<b>Ref. No.</b> —
	gas tap front part shaft ø 8x6.5mm shaft L 22/15mm shaft flat upper/lower suitable for PEL21		
	<b>GEV No.</b>	101230	<b>Ref. No.</b> —
	thermocouple nut T1: M8x1 T2: M18x1 aluminium		
<b>accessories for</b>	101095		
	<b>GEV No.</b>	100908	<b>Ref. No.</b> —
	union screw thread M10x1 for pipe ø 4mm Qty 1 pcs		
	<b>GEV No.</b>	100909	<b>Ref. No.</b> —
	union screw thread M10x1 for pipe ø 6mm Qty 1 pcs		
	<b>GEV No.</b>	101246	<b>Ref. No.</b> —
	olive for pipe ø 4mm Qty 1 pcs		
	<b>GEV No.</b>	101278	<b>Ref. No.</b> —
	olive for pipe ø 10mm Qty 1 pcs		
	<b>GEV No.</b>	101286	<b>Ref. No.</b> —
	olive ID ø 6mm Qty 1 pcs		

Table continues overleaf

accessories for		101095		
	GEV No.	101300	Ref. No.	—
	union nut thread M16x1.5 tube ø 10mm			
	GEV No.	101450	Ref. No.	—
	olive for pipe ø 8mm L 12.7mm Qty 1 pcs ED ø 10mm			
	GEV No.	101451	Ref. No.	—
	union nut thread M16x1.5 tube ø 8mm			
	GEV No.	110081	Ref. No.	—
	knob ø 70mm shaft ø 8x6.5mm shaft flat universal			
	GEV No.	112206	Ref. No.	—
	knob dial plate silver gas tap PEL21/22/23 t.max.°C ED ø 63mm ID ø 45.5mm			

AB

gas taps



1

<b>GEV No.</b>	107905	<b>Ref. No.</b>	N/A	
<b>description</b>	gas tap AB type A60 gas inlet M16x1.5 (tube ø 10mm) gas outlet M16x1.5 (tube ø 10mm) thermocouple connection M9x1 pilot connection M10x1 front fixing shaft ø 8x6.5mm shaft L 22/15mm shaft flat lower			



1



<b>GEV No.</b>	107910	<b>Ref. No.</b>	N/A	
<b>description</b>	gas tap AB type A62 gas inlet M20x1.5 (tube ø 12mm) gas outlet M20x1.5 (tube ø 12/10mm) thermocouple connection M9x1 pilot connection M10x1 front fixing shaft ø 10x8mm shaft L 26/16mm shaft flat lower			

ECA



1

<b>GEV No.</b>	109096	<b>Ref. No.</b>	62670000503	
<b>description</b>	gas tap ECA gas inlet pipe flange ø21mm bypass nozzle ø 0.55mm gas outlet 1/4" (tube ø 8mm) thermocouple connection M8x1 shaft ø 8x6.5mm shaft L 19/13mm shaft flat upper front fixing M13x1 mounting thread M5			
<b>spare parts for</b>	109096			
	GEV No.	101051	Ref. No.	—
	magnet unit L 27mm D1 ø 12.5mm D2 ø 8.5mm suitable for JUNKERS/EGA/MADEC/SABAF standard			

accessories for		109096		
	GEV No.	101277	Ref. No.	—
	olive ID ø 8mm Qty 1 pcs			
	GEV No.	101351	Ref. No.	—
	mounting strap for gas tap			
	GEV No.	520656	Ref. No.	—
	union nut thread 1/4" tube ø 6/8mm			

gas thermostats

SIT

710 Minisit series

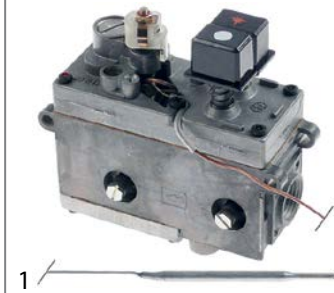

1

<b>GEV No.</b>	103262	<b>Ref. No.</b>	9099.07106.53	
<b>description</b>	gas thermostat SIT type MINISIT 710 t.max. 270°C 70-270°C gas inlet 1/2" gas outlet 3/8" thermocouple connection M9x1 pilot connection M10x1 probe ø 5mm probe L 104mm capillary pipe 1050mm probe type type B1 pressure controller no			
<b>accessories for</b>	103262			
	GEV No.	110068	Ref. No.	—
	knob suitable for Minisit ø 37mm			

PEL

25ST series



1



<b>GEV No.</b>	101172	<b>Ref. No.</b>	90991011720 9PEL.10117.20	
<b>description</b>	gas thermostat PEL type 25ST 100-300°C gas inlet M16x1.5 (tube ø 10mm) bypass nozzle ø 0.35mm gas outlet M16x1.5 (tube ø 10/8mm) thermocouple connection M9x1 pilot connection M10x1 capillary pipe 1200mm probe ø 6mm probe L 100mm shaft ø 8x6.5mm shaft L 21/15mm shaft flat upper			
<b>spare parts for</b>	101172			
	GEV No.	100259	Ref. No.	—
	bypass nozzle type PEL22 bore ø 0.35mm thread M6x0.5			
	GEV No.	101060	Ref. No.	—
	magnet unit standard L 39mm D1 ø 15.4mm D2 ø 11mm suitable for PEL20-21/JUNKERS/EGA			
	GEV No.	106200	Ref. No.	—
	nut thread M9x1 suitable for PEL 24/25S			





Table continues overleaf





accessories for		101172	
	GEV No.	100908	Ref. No. —
union screw thread M10x1 for pipe ø 4mm Qty 1 pcs			
	GEV No.	100909	Ref. No. —
union screw thread M10x1 for pipe ø 6mm Qty 1 pcs			
	GEV No.	101246	Ref. No. —
olive for pipe ø 4mm Qty 1 pcs			
	GEV No.	101278	Ref. No. —
olive for pipe ø 10mm Qty 1 pcs			
	GEV No.	101286	Ref. No. —
olive ID ø 6mm Qty 1 pcs			
	GEV No.	101300	Ref. No. —
union nut thread M16x1.5 tube ø 10mm			
	GEV No.	101450	Ref. No. —
olive for pipe ø 8mm L 12.7mm Qty 1 pcs ED ø 10mm			
	GEV No.	101451	Ref. No. —
union nut thread M16x1.5 tube ø 8mm			
	GEV No.	110079	Ref. No. —
knob dial plate gas thermostat 1-8 silver			
	GEV No.	110081	Ref. No. —
knob ø 70mm shaft ø 8x6.5mm shaft flat universal			

COPRECI

			
1			
GEV No.	109089	Ref. No.	6267.00005.22
description	gas thermostat E.C.A./COPRECI 100-300°C gas inlet pipe flange ø21mm bypass nozzle ø 0.45mm gas outlet M14x1.5 pilot connection thermocouple connection M8x1 capillary pipe 840mm probe ø 4.5mm probe L 92mm shaft ø 6x4.6mm shaft L 27/14mm shaft flat lower		
spare parts for	109089		
	GEV No.	101060	Ref. No. —
magnet unit standard L 39mm D1 ø 15.4mm D2 ø 11mm suitable for PEL20-21/JUNKERS/EGA			
	GEV No.	101537	Ref. No. —
gasket ID ø 8mm ED ø 11.5mm H 3mm Qty 1 pcs			
accessories for	109089		
	GEV No.	101538	Ref. No. —
clamp			



gas valves and ignition boxes

gas control valves

HONEYWELL

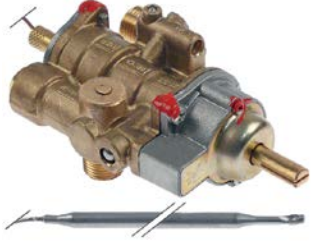
AB

			
1			
GEV No.	107915	Ref. No.	03A00033 N/A
description	gas thermostat AB type A65T 100-300°C gas inlet M16x1.5 (tube ø 10mm) gas outlet M16x1.5 (tube ø 10/8mm) thermocouple connection M9x1 pilot connection M10x1 capillary pipe 36" - 915mm probe ø 5.3mm probe L 138mm shaft ø 8x6.15mm shaft L 26/15mm shaft flat lower		

			
1			
GEV No.	106004	Ref. No.	6267.00005.30
description	gas valve type VK4105C 220-240V 50/60Hz gas inlet flange 32x32mm gas outlet flange 32x32mm thermocouple connection pilot connection pressure range 15-60mbar max 60mbar operator type pressure controller type V5306E 1234 1 suitable for HONEYWELL flange 32x32mm		
accessories for	106004		
	GEV No.	102845	Ref. No. —
gas connection angled 1/2" flange 32x32mm hole distance 24x24mm Tandem			
	GEV No.	102846	Ref. No. —
gas connection straight 1/2" flange 32x32mm hole distance 24x24mm suitable for Tandem			









ignition boxes

HONEYWELL

Honeywell



1			
<b>GEV No.</b>	102343	<b>Ref. No.</b>	6259.00020.061
<b>description</b>	ignition box HONEYWELL type S4565A 2019 1 electrodes 2 waiting times safety time 10s 220-240V 4VA 50/60Hz		

<b>accessories for</b>	106907		
<b>GEV No.</b>	100245	<b>Ref. No.</b>	—
	pilot burner nozzle LPG code 20 bore ø 0.2mm Qty 1 pcs thread M8x0.75		
<b>GEV No.</b>	100904	<b>Ref. No.</b>	—
	locking screw M10x1 for pipe ø 4mm Qty 1 pcs		
<b>GEV No.</b>	100905	<b>Ref. No.</b>	—
	locking screw M10x1 for pipe ø 6mm Qty 1 pcs		
<b>GEV No.</b>	102110	<b>Ref. No.</b>	—
	pilot tube copper pipe ø 4mm thickness 1mm L 3000mm		
<b>GEV No.</b>	102111	<b>Ref. No.</b>	—
	pilot tube copper pipe ø 6mm thickness 1mm L 3000mm		
<b>GEV No.</b>	107171	<b>Ref. No.</b>	—
	pilot burner nozzle SIT natural/liquid gas bore ø 0.25mm Qty 1 pcs		
<b>GEV No.</b>	107700	<b>Ref. No.</b>	—
	pilot burner bottom part SIT 100 series nozzle ø 0.25mm		
<b>GEV No.</b>	107701	<b>Ref. No.</b>	—
	pilot burner bottom part SIT 100 series nozzle ø 0.2mm		









ignition parts

pilot burners

SIT

100 series



1			
<b>GEV No.</b>	106907	<b>Ref. No.</b>	6267.00023.07
<b>description</b>	pilot burner SIT type 100 series 3 flames nozzle ø 0.35mm gas connection 6mm		
<b>spare parts for</b>	106907		
<b>GEV No.</b>	100246	<b>Ref. No.</b>	—
	pilot burner nozzle natural gas bore ø 0.35mm Qty 1 pcs thread M8x0.75		
<b>GEV No.</b>	100855	<b>Ref. No.</b>	—
	pilot burner bracket triple		
<b>GEV No.</b>	100885	<b>Ref. No.</b>	—
	air mixing sleeve for pilot burner Qty 1 pcs		
<b>GEV No.</b>	100916	<b>Ref. No.</b>	—
	compression spring for pilot burner Qty 1 pcs		
<b>GEV No.</b>	100917	<b>Ref. No.</b>	—
	gasket for pilot burner Qty 1 pcs aluminium		
<b>GEV No.</b>	100918	<b>Ref. No.</b>	—
	screw for pilot burner		
<b>GEV No.</b>	107162	<b>Ref. No.</b>	—
	pilot burner cap SIT 3 flames Hmm Lmm Qty 1 pcs		
<b>GEV No.</b>	107702	<b>Ref. No.</b>	—
	pilot burner bottom part SIT 100 series nozzle ø 0.35mm		









<b>ERTA</b>			
1			
<b>GEV No.</b>	102975	<b>Ref. No.</b>	6267.00023.03
<b>description</b>	pilot burner 2 flames natural gas code 14 gas connection 6mm right		
<b>spare parts for</b>	102975		
<b>GEV No.</b>	100234	<b>Ref. No.</b>	—
	pilot burner nozzle natural gas gas pressure 20mbar code 14 Qty 1 pcs suitable for JUNKERS CB5050_		
<b>GEV No.</b>	100701	<b>Ref. No.</b>	—
	ignition electrode connection M4 Qty 1 pcs		
<b>GEV No.</b>	100906	<b>Ref. No.</b>	—
	screw connection thread M10x1 for ignition electrode brass Qty 1 pcs WS 10		
<b>GEV No.</b>	100909	<b>Ref. No.</b>	—
	union screw thread M10x1 for pipe ø 6mm Qty 1 pcs		
<b>GEV No.</b>	101288	<b>Ref. No.</b>	—
	olive for pipe ø 6mm L 6mm aluminium Qty 1 pcs ED ø 8.5mm		
<b>accessories for</b>	102975		
<b>GEV No.</b>	100217	<b>Ref. No.</b>	—
	pilot burner nozzle LPG gas pressure 30mbar code 3 Qty 1 pcs suitable for JUNKERS CB5050_		
<b>GEV No.</b>	101282	<b>Ref. No.</b>	—
	olive for pipe ø 4mm L 7.4mm Qty 1 pcs		

Table continues overleaf



accessories for	102975			
	GEV No.	101283	Ref. No.	—
	union screw thread M10x1 for pipe ø 4mm Qty 1 pcs			

## ignition cables

### pre-assembled cables



GEV No.	102150	Ref. No.	6267.00031.07
description	ignition cable cable length 1500mm connection ø2.4mm / ø4mm		



GEV No.	100140	Ref. No.	6267.00031.01
description	ignition cable cable length 400mm connection ø2.4mm / ø4mm		



GEV No.	100019	Ref. No.	6267.00031.05
description	ignition cable cable length 900mm connection ø2.4mm / ø4mm		

## piezoelectric igniters

### mounting diameter 18mm



GEV No.	100003	Ref. No.	9GEV1000030
description	piezoelectric igniter body metal blowing mounting ø 18mm connection F2.8x0.8		

## thermocouples

### plug-in thermocouples

#### plug-in thermocouples standard

#### with barrel socket ø6(6.5)mm

#### thermocouples SIT

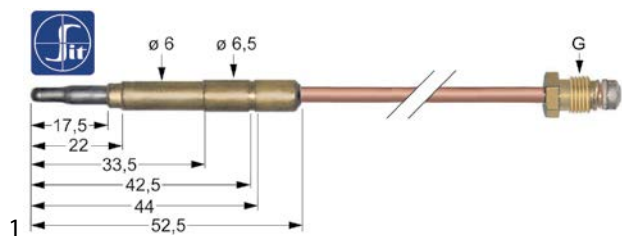

GEV No.	107604	Ref. No.	6267.00024.04
description	thermocouple SIT M8x1 L 1200mm plug connection ø6.0(6.5)mm		

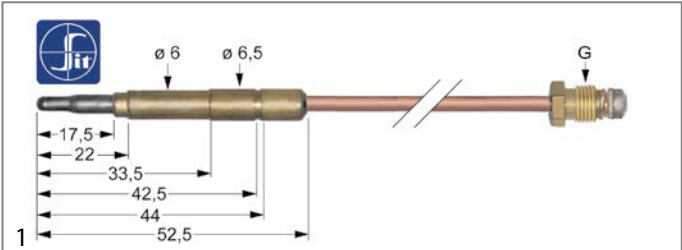

GEV No.	107613	Ref. No.	6267.00024.07 T1005191200E
description	thermocouple SIT M9x1 L 1200mm plug connection ø6.0(6.5)mm		

## gas burners

### hob burners

#### producer-specific hob burners

#### ÖZTIRYAKILER

#### stockpot stoves



GEV No.	104195	Ref. No.	62670000101
description	burner ø 150mm		



GEV No.	104308	Ref. No.	62670000104
description	burner ø 250mm		

## equipment-specific units

### for potato peelers

#### drive shafts



GEV No.	696573	Ref. No.	2840.00010.66
description	drive shaft lower for potato peeler device ø 35mm L 141mm PSM10		
For models:	PSM10		



1

<b>GEV No.</b>	696574	<b>Ref. No.</b>	2840.00020.24
<b>description</b>	drive shaft lower for potato peeler device ø 41mm L 184mm PSM20		
<b>For models:</b>	PSM20		



1

<b>GEV No.</b>	696575	<b>Ref. No.</b>	2840.00030.17
<b>description</b>	drive shaft lower for potato peeler device ø 41mm L 187mm PSM30		

### lids



1

<b>GEV No.</b>	696578	<b>Ref. No.</b>	6261.00013.10
<b>description</b>	lid for potato peeler device ø 410mm ID ø 330mm plastic mounting distance mm PSM10 H 100mm		
<b>For models:</b>	PSM10		



1

<b>GEV No.</b>	696563	<b>Ref. No.</b>	2840.00010.54
<b>description</b>	lid for potato peeler device ø 410mm ID ø 330mm plastic mounting distance mm PSM10 H 79mm		
<b>For models:</b>	PSM10		



1

<b>GEV No.</b>	696561	<b>Ref. No.</b>	2840.00020.08
<b>description</b>	lid for potato peeler device ø 510mm ID ø 440mm plastic mounting distance 160mm PSM20 H 81mm		
<b>For models:</b>	PSM20		



1

<b>GEV No.</b>	696562	<b>Ref. No.</b>	2840.00030.11
<b>description</b>	lid for potato peeler device ø 610mm ID ø 540mm plastic mounting distance 155mm PSM30 H 82mm		
<b>For models:</b>	PSM30		

### abrasive side elements

#### inserts



1

<b>GEV No.</b>	696568	<b>Ref. No.</b>	6002.00015.00
<b>description</b>	abrasive band for potato peeler device ø mm L 1210mm mounting distance mm PSM10 W 300mm		
<b>For models:</b>	PSM10		

### grinding discs



1

<b>GEV No.</b>	696565	<b>Ref. No.</b>	2840.00010.11
<b>description</b>	grinding disc ø 365mm for potato peeler device PSM10		
<b>For models:</b>	PSM10		



1

<b>GEV No.</b>	696564	<b>Ref. No.</b>	2840.00010.56
<b>description</b>	grinding disc ø 375mm for potato peeler device PSM10		
<b>For models:</b>	PSM10		

1

<b>GEV No.</b>	696566	<b>Ref. No.</b>	2840.00020.03
<b>description</b>	grinding disc ø 460mm for potato peeler device PSM20		
<b>For models:</b>	PSM20		



1

<b>GEV No.</b>	696567	<b>Ref. No.</b>	2840.00030.03
<b>description</b>	grinding disc ø 570mm for potato peeler device PSM30		
<b>For models:</b>	PSM30		

accessories



1

<b>GEV No.</b>	696570	<b>Ref. No.</b>	2840.00020.20 2840.00030.12
<b>description</b>	handle for grinding disc model PSM20/30 ø 88mm L 140mm bore ø 8mm		
<b>For models:</b>	PSM20, PSM30		

miscellaneous

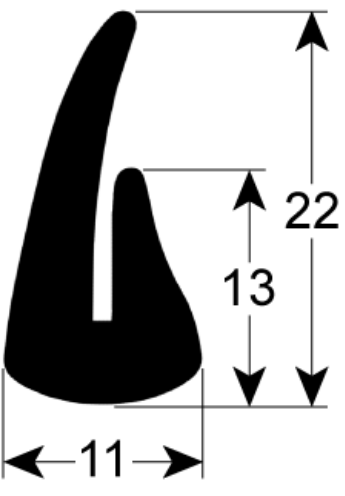

1

<b>GEV No.</b>	696572	<b>Ref. No.</b>	6261.00010.10
<b>description</b>	gasket for potato peeler device L 1320mm model PSM		
<b>For models:</b>	PSM10		



1

<b>GEV No.</b>	696571	<b>Ref. No.</b>	6261.00010.03
<b>description</b>	gasket for potato peeler device rubber L 205mm W 175mm H 17mm		
<b>For models:</b>	PSM10		



1

<b>GEV No.</b>	696569	<b>Ref. No.</b>	2840.00010.51
<b>description</b>	housing for potato peeler device plastic L 250mm W 210mm H 200mm		
<b>For models:</b>	PSM10, PSM20, PSM30		

accessories



1

<b>GEV No.</b>	696577	<b>Ref. No.</b>	2840.00020.21
<b>description</b>	coupling for drive shaft ID ø 41mm ED ø 70mm L 70mm for model PSM20		
<b>For models:</b>	PSM20		



1

<b>GEV No.</b>	696576	<b>Ref. No.</b>	2840.00030.04
<b>description</b>	coupling for drive shaft ID ø 41mm ED ø 70mm L 70mm for model PSM30		
<b>For models:</b>	PSM30		

for planetary mixers

gearboxes



1			
<b>GEV No.</b>	698452	<b>Ref. No.</b>	2810.20200.26
<b>description</b>	drive shaft for dough hook L 155mm ø 40mm model 20 litres		
<b>For models:</b>	OM20G		



1			
<b>GEV No.</b>	698451	<b>Ref. No.</b>	2810.20200.17 6261.00018.52
<b>description</b>	drive shaft for gearbox L 220mm ø 43mm		
<b>For models:</b>	OM20G		



1			
<b>GEV No.</b>	698441	<b>Ref. No.</b>	2810.00010.51
<b>description</b>	internal gear for gearbox ø 170mm H 39mm model 10 litres		
<b>For models:</b>	OM10G		

dough hooks



1			
<b>GEV No.</b>	698425	<b>Ref. No.</b>	2810.00010.08
<b>description</b>	dough hook model 10 litres shaft ø 16mm H 220mm		
<b>For models:</b>	OM10G		



1			
<b>GEV No.</b>	698424	<b>Ref. No.</b>	2810.20200.59
<b>description</b>	dough hook model 20 litres shaft ø 22.5mm H 310mm		
<b>For models:</b>	OM20G		



1			
<b>GEV No.</b>	698423	<b>Ref. No.</b>	2810.40400.59
<b>description</b>	dough hook model 40 litres shaft ø 29mm H 410mm		
<b>For models:</b>	OM40G		



1			
<b>GEV No.</b>	698422	<b>Ref. No.</b>	2810.60600.59
<b>description</b>	dough hook model 60 liters shaft ø 29mm H 460mm		
<b>For models:</b>	OM60G		

pulleys



1			
<b>GEV No.</b>	698434	<b>Ref. No.</b>	2810.20200.33
<b>description</b>	pulley bottom left disc ø 180mm ø 180mm shaft intake ø 32mm seat ø 54mm model 20 litres groove depth 65mm disc width 6mm overall width 56mm metal for planetary mixer		
<b>For models:</b>	OM20G		



1			
<b>GEV No.</b>	698440	<b>Ref. No.</b>	2810.40400.10
<b>description</b>	pulley bottom left disc ø 205mm ø 205mm shaft intake ø 32mm seat ø 50mm model 40/60 litres groove depth 70mm disc width 45mm overall width 57mm metal for planetary mixer		
<b>For models:</b>	OM40G, OM60G		



1

<b>GEV No.</b>	698437	<b>Ref. No.</b>	2810.20200.10
<b>description</b>	pulley bottom right disc ø 180mm ø 180mm shaft intake ø 14mm seat ø 33mm model 20 litres groove depth 65mm disc width 3mm overall width 110mm metal for planetary mixer		
<b>For models:</b>	OM20G		



1

<b>GEV No.</b>	698435	<b>Ref. No.</b>	2810.20200.34
<b>description</b>	pulley upper left disc ø 180mm ø 180mm shaft intake ø 19mm seat ø 45mm model 20 litres groove depth 60mm disc width 5mm overall width 129mm metal for planetary mixer shaft ø 32mm		
<b>For models:</b>	OM20G		



1

<b>GEV No.</b>	698438	<b>Ref. No.</b>	2810.40400.33
<b>description</b>	pulley bottom right disc ø 180mm ø 180mm shaft intake ø 23mm seat ø 45mm model 40 litres groove depth 65mm disc width 5mm overall width 130mm metal for planetary mixer		
<b>For models:</b>	OM40G		



1

<b>GEV No.</b>	698436	<b>Ref. No.</b>	2810.20200.09
<b>description</b>	pulley upper right disc ø 180mm ø 180mm shaft intake ø 32mm seat ø 50mm model 20 litres groove depth 65mm disc width 6mm overall width 60mm metal for planetary mixer		
<b>For models:</b>	OM20G		



1

<b>GEV No.</b>	698439	<b>Ref. No.</b>	2810.40400.34
<b>description</b>	pulley upper right disc ø 180mm ø 180mm shaft intake ø 35mm seat ø 54mm model 40 litres groove depth 67mm disc width 6mm overall width 56mm metal for planetary mixer		
<b>For models:</b>	OM40G		

beaters



1

<b>GEV No.</b>	698420	<b>Ref. No.</b>	2810.00010.13
<b>description</b>	beater model 10 litres shaft ø 16mm W 155mm H 210mm		
<b>For models:</b>	OM10G		



1

<b>GEV No.</b>	698421	<b>Ref. No.</b>	2810.00020.50 2810.20200.58
<b>description</b>	beater model 20 litres shaft ø 22.5mm W 185mm H 310mm		
<b>For models:</b>	OM20G		



1

<b>GEV No.</b>	698427	<b>Ref. No.</b>	2810.40400.58
<b>description</b>	beater model 40 litres shaft ø 29mm W 240mm H 305mm		
<b>For models:</b>	OM40G		



1

<b>GEV No.</b>	698426	<b>Ref. No.</b>	2810.60600.58
<b>description</b>	beater model 60 litres shaft ø 29mm W 300mm H 330mm		
<b>For models:</b>	OM60G		

mixer bowls



1

<b>GEV No.</b>	698432	<b>Ref. No.</b>	2810.00010.31
<b>description</b>	mixer bowl model 10 litres ø 280mm H 205mm		
<b>For models:</b>	OM10G		



1

<b>GEV No.</b>	698433	<b>Ref. No.</b>	2810.20200.49
<b>description</b>	mixer bowl model 20 litres ø 340mm H 275mm		
<b>For models:</b>	OM20G		

beaters



1

<b>GEV No.</b>	698428	<b>Ref. No.</b>	2810.00010.16
<b>description</b>	whisk model 10 litres shaft ø 16mm ø 120mm H 220mm		
<b>For models:</b>	OM10G		



1

<b>GEV No.</b>	698431	<b>Ref. No.</b>	2810.20200.57
<b>description</b>	whisk model 20 litres shaft ø 22.5mm ø 175mm H 310mm		
<b>For models:</b>	OM20G		



1

<b>GEV No.</b>	698429	<b>Ref. No.</b>	2810.40400.57
<b>description</b>	whisk model 40 litres shaft ø 29mm ø 235mm H 400mm		
<b>For models:</b>	OM40G		



1

<b>GEV No.</b>	698430	<b>Ref. No.</b>	2810.00060.17 2810.60600.57
<b>description</b>	whisk model 60 litres shaft ø 29mm ø 265mm H 460mm		
<b>For models:</b>	OM60G		





## gear wheels



1

<b>GEV No.</b>	698448	<b>Ref. No.</b>	6261.00017.22
<b>description</b>	gear wheel ø 52mm shaft intake ø 15mm W 24mm teeth 23 polyamide for model 10 litres		
<b>For models:</b>	OM10G		



1

<b>GEV No.</b>	698450	<b>Ref. No.</b>	2810.20200.23
<b>description</b>	gear wheel ø 52mm shaft intake ø 18mm W 32mm teeth 18 polyamide for model 20 litres		
<b>For models:</b>	OM20G		



1

<b>GEV No.</b>	698449	<b>Ref. No.</b>	2810.40400.23
<b>description</b>	gear wheel ø 60mm shaft intake ø 24mm W 40mm teeth 15 polyamide for model 40/60 litres		
<b>For models:</b>	OM40G, OM60G		

## for espresso machines

### brewing units

### filter holder gaskets

### O-rings



1

<b>GEV No.</b>	510409	<b>Ref. No.</b>	6228.00002.14
<b>description</b>	O-ring EPDM thickness 5.34mm ID ø 56.52mm Qty 1 pcs		

## for saladettes

### housing and bezels



1

<b>GEV No.</b>	692115	<b>Ref. No.</b>	2912.16894.W0.750.00 7AYS.00002.19
<b>description</b>	cover housing L 413mm H 337mm plate thickness max. 30mm		

## for dishwashers

### drain and intake components

### ÖZTIRYAKILER

### overflow pipes



1

<b>GEV No.</b>	517824	<b>Ref. No.</b>	6262.00028.001
<b>description</b>	overflow pipe L 200mm ø 40mm		

miscellaneous

drain /intake bodies



1			
<b>GEV No.</b>	517766	<b>Ref. No.</b>	6262.00027.000
<b>description</b>	drain unit with filter		
<b>For models:</b>	OBK1500		

overflow pipes



1			
<b>GEV No.</b>	517765	<b>Ref. No.</b>	2710.20051.450 6262.00028.02 6262.00028.02+6228.00001.36
<b>description</b>	overflow pipe L 400mm ø 41mm		
<b>For models:</b>	OBK1500		

housing and bezels

model name plates



1			
<b>GEV No.</b>	694812	<b>Ref. No.</b>	2999.NOVAT.LO
<b>description</b>	type plate NOVATEC metal L 70mm W 32mm		

miscellaneous



1			
<b>GEV No.</b>	506160	<b>Ref. No.</b>	6215.00001.03
<b>description</b>	plain washer ID ø 8.6mm ED ø 16mm thickness 1.5mm SS Qty 1 pcs		

washing and rinsing systems



1			
<b>GEV No.</b>	504857	<b>Ref. No.</b>	6262.00030.33 + 6262.00030.01 6262.00033.33
<b>description</b>	wash and rinse arm wash arm L 510mm rinse arm L 510mm w. jets 10 r. jets 6		

washing and rinsing systems (sorted by producer)

ÖZTIRYAKILER

rinse arm shafts



1			
<b>GEV No.</b>	699582	<b>Ref. No.</b>	2KLP.460.626200041.04
<b>description</b>	nut L 14.5mm M8x1 for rinse arm shaft		



1			
<b>GEV No.</b>	699581	<b>Ref. No.</b>	2KLP.460.626200041.03 6262.00041.03
<b>description</b>	rinse arm shaft L 67mm M8x1 ø 15mm hole ø 6mm		

wash arm supports



1			
<b>GEV No.</b>	699580	<b>Ref. No.</b>	6262.00030.05
<b>description</b>	tap head ø 110mm ID ø 46mm H 8mm for wash arm support		



1

<b>GEV No.</b>	513327	<b>Ref. No.</b>	2710.F0024.02 6262.00024.02
<b>description</b>	wash arm support ø 46mm ID ø 40mm H 150mm 2"		

for plate dispensers



1

<b>GEV No.</b>	501497	<b>Ref. No.</b>	6260.00022.00
<b>description</b>	guide roller for plate dispensers W 27mm ø 30mm ID ø 8mm		

knobs

producer-specific knobs

ÖZTIRYAKILER



1

<b>GEV No.</b>	112748	<b>Ref. No.</b>	6260.00015.45+6260.00015.38
<b>description</b>	knob 0-1-0-1 ø 75mm shaft ø 6x4.6mm shaft flat upper/lower black		



1

<b>GEV No.</b>	112659	<b>Ref. No.</b>	6260.00015.40 6260.00015.46 6260.00015.46+6260.00015.40 62600001518
<b>description</b>	knob gas tap with ignition flame ø 75mm shaft ø 8x6.5mm shaft flat upper/lower black		



1

<b>GEV No.</b>	112746	<b>Ref. No.</b>	6260.00015.45+6260.00015.37
<b>description</b>	knob thermostat 30-90°C ø 75mm shaft ø 6x4.6mm shaft flat upper/lower black		



1

<b>GEV No.</b>	112747	<b>Ref. No.</b>	6260.00015.45+6260.00015.32
<b>description</b>	knob thermostat 50-300°C ø 75mm shaft ø 6x4.6mm shaft flat upper/lower black		



1

<b>GEV No.</b>	112661	<b>Ref. No.</b>	6260.00015.20 6260.00015.47+6260.00015.44
<b>description</b>	knob without symbol ø 80mm shaft ø 10x8mm shaft flat upper/lower black		



1

<b>GEV No.</b>	112809	<b>Ref. No.</b>	6262.00071.20
<b>description</b>	knob zero mark ø 58mm shaft ø 6x5mm shaft flat upper		

## handles and hand wheels

## hand wheels

## hand wheels



1

<b>GEV No.</b>	694672	<b>Ref. No.</b>	6261.00028.52
<b>description</b>	hand wheel ø 190mm D1 ø 43mm bore ø 16mm depth of bore 21mm thread M10x1.5 groove width 5mm groove depth 21mm L1 20mm L2 35mm handle lengthmm		
<b>For models:</b>	OM20G, OM40G, OM60G		

## spare parts and accessories



1

<b>GEV No.</b>	514443	<b>Ref. No.</b>	2810.40400.31 6261.00028.78
<b>description</b>	cone handle ø 28mm total length 100mm thread M10x1.5 plastic L 81mm		
<b>For models:</b>	OM20G, OM40G, OM60G		

## cone handles



1

<b>GEV No.</b>	514443	<b>Ref. No.</b>	2810.40400.31 6261.00028.78
<b>description</b>	cone handle ø 28mm total length 100mm thread M10x1.5 plastic L 81mm		
<b>For models:</b>	OM20G, OM40G, OM60G		

## locks

## edgemount latches

## handle latches

## producer-specific

## ÖZTIRYAKILER

## locks



1

<b>GEV No.</b>	701581	<b>Ref. No.</b>	6201.00031.01 7AYS.00008.04
<b>description</b>	catch L 254mm mounting distance 116mm chrome-plated steel lockable		

## hinges

## door bearing



1

<b>GEV No.</b>	701430	<b>Ref. No.</b>	6201.00030.50
<b>description</b>	door guides L 80mm W 24mm H 115mm mounting pos. left/right		

## pullouts

## drawer slides

## producer-specific



1

<b>GEV No.</b>	692608	<b>Ref. No.</b>	2919.17NTS.00.910.00 left
<b>description</b>	drawer rail L 555mm pull-out lengthmm W 53mm H 15mm mounting pos. left		





1

<b>GEV No.</b>	692678	<b>Ref. No.</b>	2919.17NTS.00.910.00 2919.17NTS.00.910.00 right
<b>description</b>	drawer rail L 555mm pull-out lengthmm W 53mm H 15mm pair		

## fittings for catering equipment

### drain taps

#### accessories



1

<b>GEV No.</b>	540222	<b>Ref. No.</b>	6228.00059.60
<b>description</b>	O-ring EPDM thickness 2.62mm ID ø 47.3mm Qty 1 pcs		

## shelves and shelf rails

### shelf rails and supports

#### producer-specific



1

<b>GEV No.</b>	692607	<b>Ref. No.</b>	6260.00068.04
<b>description</b>	pair of setting bar L 550mm W 60mm inner height 12mm hook width 15mm mounting distance 490mm		



1

<b>GEV No.</b>	692605	<b>Ref. No.</b>	siehe Bemerkung 03,08,16
<b>description</b>	pair of setting bar L 725mm W 30mm inner height 13mm hook width 15mm		



1

<b>GEV No.</b>	692606	<b>Ref. No.</b>	siehe Bemerkung 03,08,16
<b>description</b>	pair of setting bar U-shape L 660mm W 30mm inner height 13mm hook width 15mm mounting pos. left/right		

## gaskets

### refrigeration gaskets

#### plug-in gaskets

##### profile 9175

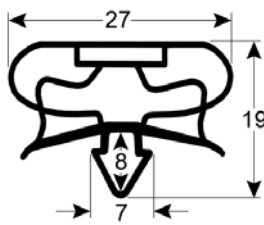

1

<b>GEV No.</b>	902468	<b>Ref. No.</b>	6268.00012.26 6268.00012.30 7AYS.00008.21
<b>description</b>	refrigeration gasket profile 9175 W 615mm L 1387mm plug size		

##### profile 9014

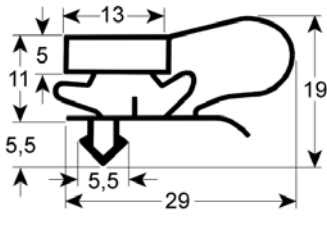

1

<b>GEV No.</b>	902056	<b>Ref. No.</b>	6268.00012.10
<b>description</b>	refrigeration gasket profile 9014 W 380mm L 585mm plug size		

##### profile 9141

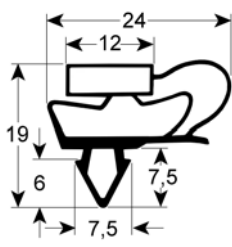

1

<b>GEV No.</b>	901868	<b>Ref. No.</b>	6268.00012.32
<b>description</b>	refrigeration gasket profile 9041 W 574mm L 1530mm external size		
<b>For models:</b>	7919.06LMV.00, 7919.06NMV.00, 7919.12LMV.00, 7919.12NMV.00		

<b>GEV No.</b>	901867	<b>Ref. No.</b>	6268.00012.60
<b>description</b>	refrigeration gasket profile 9141 W 400mm L 590mm		
<b>For models:</b>	7919.27LMV.00, 7919.27NMV.00, 7919.37LMV.00, 7919.37NMV.00		

O-rings

EPDM

<b>GEV No.</b>	540222	<b>Ref. No.</b>	6228.00059.60
<b>description</b>	O-ring EPDM thickness 2.62mm ID ø 47.3mm Qty 1 pcs		

<b>GEV No.</b>	510408	<b>Ref. No.</b>	6228.00001.22 6228.00001.26
<b>description</b>	O-ring EPDM thickness 5.34mm ID ø 47mm Qty 1 pcs		

<b>GEV No.</b>	510409	<b>Ref. No.</b>	6228.00002.14
<b>description</b>	O-ring EPDM thickness 5.34mm ID ø 56.52mm Qty 1 pcs		

shaft gaskets

shaft gaskets

<b>GEV No.</b>	698453	<b>Ref. No.</b>	6228.00011.05
<b>description</b>	shaft sealing ID ø 25mm ED ø 42mm thickness 10mm type 6244		
<b>For models:</b>	PSM10		

<b>GEV No.</b>	698454	<b>Ref. No.</b>	6228.00011.12
<b>description</b>	shaft sealing ID ø 40mm ED ø 62mm thickness 10mm type 6421		
<b>For models:</b>	PSM20, PSM30		

special gaskets

miscellaneous

<b>GEV No.</b>	696572	<b>Ref. No.</b>	6261.00010.10
<b>description</b>	gasket for potato peeler device L 1320mm model PSM		
<b>For models:</b>	PSM10		

<b>GEV No.</b>	696571	<b>Ref. No.</b>	6261.00010.03
<b>description</b>	gasket for potato peeler device rubber L 205mm W 175mm H 17mm		
<b>For models:</b>	PSM10		

<b>GEV No.</b>	696571	<b>Ref. No.</b>	6261.00010.03
<b>description</b>	gasket for potato peeler device rubber L 205mm W 175mm H 17mm		
<b>For models:</b>	PSM10		



## evaporators

### for fridges

#### producer-specific



1

<b>GEV No.</b>	750708	<b>Ref. No.</b>	6268.00011.60
<b>description</b>	evaporator L 420mm W 235mm H 115mm suitable for GN 600 NMV		
<b>For models:</b>	7919.06NMV.00		

## transmission technology and ball bearings

### ball bearings

#### deep-groove ball bearings 2RS



1

<b>GEV No.</b>	523522	<b>Ref. No.</b>	6211.00210.01
<b>description</b>	deep-groove ball bearing type 6004-2RS shaft $\varnothing$ 20mm ED $\varnothing$ 42mm W 12mm with sealing discs deep-groove ball bearing DIN 625-1		
<b>For models:</b>	OM10G		



1

<b>GEV No.</b>	523518	<b>Ref. No.</b>	6211.00243.00
<b>description</b>	deep-groove ball bearing type 6305-2RS shaft $\varnothing$ 25mm ED $\varnothing$ 62mm W 17mm with sealing discs deep-groove ball bearing DIN 625-1		
<b>For models:</b>	OM20G, OM40G, OM60G		

#### deep-groove ball bearings 2Z



1

<b>GEV No.</b>	523032	<b>Ref. No.</b>	6211.00210.00
<b>description</b>	deep-groove ball bearing shaft $\varnothing$ 20mm ED $\varnothing$ 42mm W 12mm type 6004-2Z DIN 625-1		
<b>For models:</b>	OM10G, PSM10		



1

<b>GEV No.</b>	523030	<b>Ref. No.</b>	6211.00222.00
<b>description</b>	deep-groove ball bearing shaft $\varnothing$ 30mm ED $\varnothing$ 62mm W 16mm type 6206-2Z DIN 625-1		
<b>For models:</b>	PSM20, PSM30		

### drive belts

#### V-belts

##### profile A/13



1

<b>GEV No.</b>	698444	<b>Ref. No.</b>	6263.00002.08
<b>description</b>	V-belt belt width 13mm L 875mm H 8mm CODE A34 1/2 profile A/13		
<b>For models:</b>	OM10G		

#### toothed belts



1

<b>GEV No.</b>	698442	<b>Ref. No.</b>	6263.00003.02
<b>description</b>	toothed belt profile VX L 1025mm H 10mm teeth 150 splitting 5-4 rubber with textile insertion CODE 1025Li W 32mm		
<b>For models:</b>	OM60G		



1

<b>GEV No.</b>	698443	<b>Ref. No.</b>	6263.00003.11
<b>description</b>	toothed belt profile VX L 820mm H 10mm teeth 82 splitting 8-4 rubber with textile insertion CODE 820Li W 32mm		
<b>For models:</b>	OM20G		



1

<b>GEV No.</b>	698447	<b>Ref. No.</b>	6263.00003.10
<b>description</b>	toothed belt profile VX L 950mm H 10mm teeth 100 splitting 6-4 rubber with textile insertion CODE SD2006-002 W 32mm		
<b>For models:</b>	OM40G		

poly-v belts



<b>GEV No.</b>	698445	<b>Ref. No.</b>	6263.00006.01
<b>description</b>	poly-v belt grooves 11 W 26mm L 559mm profile J		
<b>For models:</b>	PSM10		

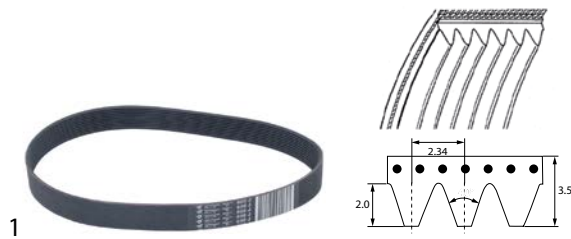

<b>GEV No.</b>	698446	<b>Ref. No.</b>	6263.00006.02
<b>description</b>	poly-v belt grooves 11 W 26mm L 660mm profile J		
<b>For models:</b>	PSM20, PSM30		

springs

tension springs



<b>GEV No.</b>	501496	<b>Ref. No.</b>	6205.00001.01
<b>description</b>	tension spring ø 14mm total length 139mm wire gauge ø 1.2mm		

dosing pumps

peristaltic dosing pumps

SEKO

built-in version

with frequency control



<b>GEV No.</b>	361979 <sup>1</sup>	<b>Ref. No.</b>	6262.30666.14
<b>description</b>	dosing pump SEKO frequency control 0.4l/h 230VAC rinse aid hose ø 4x6mm hose type D hose Sekobril type NBR 0.4 with inlet and conveyor hose		

<sup>1</sup>with accessories

hoses

supply hoses

PVC supply hoses

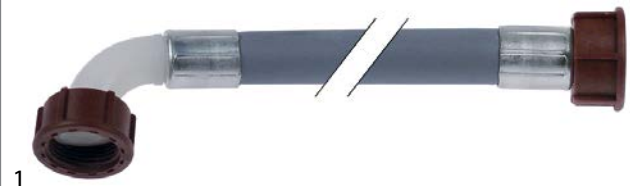

<b>GEV No.</b>	520010	<b>Ref. No.</b>	6262.00021.12
<b>description</b>	supply hose PVC straight-curved DN13 connections 3/4" L 1500mm operating p. 10bar burst p. 32bar t.max. 90°C blue approval VDE flat seal		
<b>For models:</b>	OBK1500		
<b>accessories for</b>	520010		
<b>GEV No.</b>	520053	<b>Ref. No.</b>	—
<b>description</b>	screen connection 3/4" D1 ø 26mm D2 ø 15mm Qty 10 pcs rubber thickness 8mm		
<b>GEV No.</b>	520054	<b>Ref. No.</b>	—
<b>description</b>	flat gasket rubber ED ø 23.5mm ID ø 14mm thickness 2.3mm Qty 10 pcs		

drain hoses



<b>GEV No.</b>	530872	<b>Ref. No.</b>	6262.00021.13
<b>description</b>	drain hose DN31 L 2500mm A int. ø 40mm A ext. ø 47mm B int. ø 40mm B ext. ø 47mm		
<b>For models:</b>	OBK1500		

ittings, hose and pipe connectors

ittings

double nipples



<b>GEV No.</b>	521192	<b>Ref. No.</b>	6222.00003.25
<b>description</b>	double nipple brass thread 1"-3/4" Qty 1 pcs		









## drain systems and wash basins

### wash basins



1

<b>GEV No.</b>	542317	<b>Ref. No.</b>	7759.54483.10
<b>description</b>	hand-wash basin stainless steel W 500mm D 400mm H 390mm		
<b>accessories for</b>	542317		
	<b>GEV No.</b>	515015	<b>Ref. No.</b> —
	U-bend basins 1 thread 1½" flexible hose outflow distance max. 150mm spout ø 40mm		
	<b>GEV No.</b>	515045	<b>Ref. No.</b> —
	drain fitting size 1½" usable heightmm overall height 41mm ED ø 70mm chrome-plated brass		
	<b>GEV No.</b>	515089	<b>Ref. No.</b> —
	drain fitting size 1½" usable heightmm overall height 40mm ED ø 71mm stainless steel		
	<b>GEV No.</b>	515141	<b>Ref. No.</b> —
	drain fitting size 1 1/2" usable heightmm overall heightmm ED ø 70mm SS/plastic with plug		

## fastening material

### screws

#### hexagonal screws



1

<b>GEV No.</b>	550682	<b>Ref. No.</b>	6262.00003.10
<b>description</b>	hexagonal screw thread M8 thread L 20mm SS WS 13 Qty 1 pcs DIN 933 / ISO 4017		

### nuts

#### plate nuts



1

<b>GEV No.</b>	560573	<b>Ref. No.</b>	6214.00009.00
<b>description</b>	plate nut hole ø 2.6mm L 17mm W 12mm		

#### hexagonal nuts

##### DIN 985



1

<b>GEV No.</b>	560143	<b>Ref. No.</b>	6214.00013.15
<b>description</b>	hexagonal nut thread M8 H 8.5mm SS WS 13 Qty 20 pcs DIN/ISO DIN 985 self-locking		

### washers

#### washers

##### miscellaneous



1

<b>GEV No.</b>	506160	<b>Ref. No.</b>	6215.00001.03
<b>description</b>	plain washer ID ø 8.6mm ED ø 16mm thickness 1.5mm SS Qty 1 pcs		

#### tooth lock washers

##### DIN 6798A



1

<b>GEV No.</b>	503121	<b>Ref. No.</b>	6216.00015.05
<b>description</b>	tooth lock washer ID ø 8.4mm ED ø 15mm SS Qty 1 pcs		

### fasteners

#### mounting clips



1

<b>GEV No.</b>	524043	<b>Ref. No.</b>	7AYS0000220
<b>description</b>	mounting clip plastic L 38mm W 19mm H 10mm		



<b>B</b>			
booster pumps I		14	
<b>C</b>			
cam switches		7	
contactors		10	
control equipment		8	
control thermostats		5	
<b>D</b>			
dosing pumps		32	
double nipples		32	
drain hoses		32	
drain pumps		15	
drain systems and wash basins		33	
<b>E</b>			
edgemount latches		28	
electronic controllers		11	
energy regulators		4	
evaporators		31	
<b>F</b>			
fans		13	
fasteners		33	
fastening material		33	
fittings		32	
fluorescent lamps		9, 9	
foil heating elements		4	
<b>G</b>			
gas burners		19	
gas control valves		17	
gas taps		15	
gas thermostats		16	
<b>H</b>			
handle latches		28	
hand-wash basins		33	
heating elements		3	
heating elements for contact grills		3	
heating elements for convection		3	
heating elements for fryers		3	
heating elements for griddles		3	
hexagonal nuts		33	
hexagonal screws		33	
hob burners		19	
hoses		32	
hot air fans		13	
hot air motors		13	
hot plates		4	
<b>I</b>			
ignition boxes		18	
ignition cables		19	
immersion heating elements		3	
indicator lights		9	
indicator lights (complete)		9	
<b>L</b>			
lamps		9	
<b>M</b>			
magnetic switches		8	
mechanical timers		9	
motors		14	
mounting clips		33	
<b>N</b>			
nuts		33	
<b>O</b>			
O-rings		30	
oven lamps		9	
<b>P</b>			
piezoelectric igniters		19	
pilot burners		18	
plate nuts		33	
plug-in gaskets		29	
position switches		7	
pressure switches		13	
probes		12	
pumps		14	
PVC supply hoses		32	
<b>R</b>			
radiation heaters		4	
refrigeration fans		13	
refrigeration gaskets		29	
refrigeration motors universal		13	
refrigeration thermostats		6	
relays		10	
rocker/momentary rocker switches		7	
<b>S</b>			
safety thermostats		5	
screws		33	
shaft gaskets		30	
shelves and shelf rails		29	
solenoid valves		12	
supply hoses		32	
switches and momentary switches		7	

**T**

temperature probes	12
thermocouples	19
thermostats	5
time relays	11
timers	9
toggle switches	7
tooth lock washers	33

**U**

universal probes	12
------------------	----

**W**

wash and rinse pumps	14
wash basins	33
washers	33